

Eberhard Nieschlag
Hermann M. Behre
Susan Nieschlag
Editors

Andrology

Male Reproductive
Health and Dysfunction

3rd, Completely Revised
and Updated Edition

 Springer

Andrology

Eberhard Nieschlag
Hermann M. Behre
Susan Nieschlag
(Editors)

Andrology

Male Reproductive Health
and Dysfunction

3rd Edition

 Springer

Prof. Dr. med. Eberhard Nieschlag
Centre for Reproductive Medicine and
Andrology of the University
Domagkstr. 11
48149 Münster
Germany
Eberhard.Nieschlag@ukmuenster.de

Susan Nieschlag, M.A.
Centre for Reproductive Medicine and
Andrology of the University
Domagkstr. 11
48149 Münster
Germany
Susan.Nieschlag@ukmuenster.de

Prof. Dr. med. Hermann M. Behre
Centre for Reproductive Medicine and
Andrology of the University
Ernst-Grube-Str. 40
06120 Halle/Saale
Germany
hermann.behre@medizin.uni-halle.de

ISBN: 978-3-540-78354-1

e-ISBN: 978-3-540-78355-8

DOI: 10.1007/978-3-540-78355-8

Springer Heidelberg Dordrecht London New York

Library of Congress Control Number: 2009931339

© Springer-Verlag Berlin Heidelberg 2010

This work is subject to copyright. All rights are reserved, whether the whole or part of the material is concerned, specifically the rights of translation, reprinting, reuse of illustrations, recitation, broadcasting, reproduction on microfilm or in any other way, and storage in data banks. Duplication of this publication or parts thereof is permitted only under the provisions of the German Copyright Law of September 9, 1965, in its current version, and permission for use must always be obtained from Springer. Violations are liable to prosecution under the German Copyright Law.

The use of general descriptive names, registered names, trademarks, etc. in this publication does not imply, even in the absence of a specific statement, that such names are exempt from the relevant protective laws and regulations and therefore free for general use.

Product liability: The publishers cannot guarantee the accuracy of any information about dosage and application contained in this book. In every individual case the user must check such information by consulting the relevant literature.

Cover design: eStudio Calamar, Figueres/Berlin

Printed on acid-free paper

Springer is part of Springer Science+Business Media (www.springer.com)

Preface to the 3rd Edition

The decade that has passed since publication of the second edition of this textbook has not only witnessed a tremendous increase in knowledge within the field of andrology, but also seen the field itself achieve a newfound status within the medical profession. Knowledge and status have been of mutual benefit to the field and the growing critical mass of diagnostic and therapeutic possibilities have caused andrology to be recognized as a medical subspecialty in some countries such as Germany, Poland, and Estonia. The European Academy of Andrology (EAA) served as a pacemaker for this development and continues to strive for establishment of andrology as a clinical field. Well-designed curricula and qualifying examinations have contributed to the official recognition of andrology as a speciality. This recognition of the field helps patients with andrological problems to find the specialist they seek.

This textbook summarizes the current state of knowledge in the field of andrology. It is a source of knowledge to all those who are or want to become andrologists. In addition, as andrology is clearly an interdisciplinary field, this book may serve as a compendium and source of reference for all those physicians and biologists active in neighboring areas, who want to obtain an overview of andrology and who require information on special problems. The extensive references are timely and up to date.

The majority of authors of the previous two and the current third edition of this book are coworkers or collaborators of the Institute of Reproductive Medicine of the University of Münster, which was renamed the Centre for Reproductive Medicine and Andrology of the University in 2008. The “Münster School of Andrology” provides the common basis of the work rooted in over 30 years of scientific and practical experience.

The editors are indebted to the authors for their input in creating this third edition. We also thank the Springer team, especially Dörthe Mennecke-Bühler and Claus-Dieter Bachem for producing this attractive volume. Maria Schalkowski (Münster) deserves special mention for her untiring efforts to make this book become a reality.

Eberhard Nieschlag
Herrman M. Behre
Susan Nieschlag
Münster and Halle
October 2009

Preface to the 2nd Edition

Andrology, as the science of male reproductive function and dysfunction, has experienced exceptional progress in recent years. Especially clinical applications of molecular biology and molecular genetics to male infertility and hypogonadism, the “invention” of intracytoplasmic sperm injection (ICSI) as a treatment of male infertility and the introduction of effective oral medication for erectile dysfunction can be considered major breakthroughs. The magnitude of these developments, along with many others, prompted this second edition of *Andrology: Male Reproductive Health and Dysfunction*.

As in the first edition, the textbook follows the principles of evidence-based medicine and provides a firm scientific basis for clinical andrology. As before, we consider andrology as part of the comprehensive field of reproductive medicine, but we are convinced that it can coexist alongside gynecology only when it qualifies as a scientific and clinical field in its own right. For this reason this textbook seeks to strengthen andrology as a field, along with acting as a source of information.

All chapters have been thoroughly revised and extended; some were completely rewritten. Among the new features: the diagnostic sections reflect the newest WHO guidelines on semen analysis (1999); the sections on testicular biopsy were enlarged by a contribution from Professor A.F. Holstein (Hamburg); the pathophysiological basis of numerous disease entities is explained by insights newly gained from molecular biology and molecular genetics; ICSI treatment and its genetic ramifications are thoroughly discussed; other therapeutic methods, especially the treatment of varicocele, have been brought up to date. Without disregarding the art of exact diagnosis, medical treatment of erectile dysfunction is covered in detail. Because of increasing interest, the chapters on male contraception and male senescence have been expanded. As in the earlier edition, a chapter on the ethical aspects of reproductive medicine completes the picture. The layout of the first edition, with typographical features designed for the reader’s orientation, has been maintained and is supplemented with color illustrations and figures, contributing to a lively presentation.

In order to provide a uniform work, we selected authors who are either past or current colleagues at the Institute of Reproductive Medicine at the University of Münster or who work at collaborating centers. The interest shared by the authors contributed to a uniform presentation of andrology and prompted reviewers of the first edition to speak of a “Münster School of Andrology.” The editors are grateful to all contributors for their excellent cooperation. As before, Susan Nieschlag, M.A., as editorial assistant, contributed a high degree of professionalism and tireless effort to this second edition. The word-processing skills of Angelika Schick, Barbara Bannes, and Maria Schalkowski, secretaries at the Institute, deserve special mention. Particular

thanks go to Dr. Trevor Cooper and Dr. Andrea Wagenfeld for their punctilious and professional review of all manuscripts. Finally, we are grateful to Dr. Udo Lindner, Dr. Annette Zimpelmann, and Axel Treiber of Springer-Verlag for their enthusiastic support of the present volume. They encouraged our input, which was rewarded by speedy production of the volume.

Many suggestions for the second edition were provided by reviewers and readers, and we gratefully incorporated their ideas. This dialogue was particularly helpful and we would like to repeat our earlier request for critical suggestions. We hope that the reader will again use this volume to his own advantage and to that of his patients.

Eberhard Nieschlag
Hermann M. Behre
Münster, February 2000

Preface to the 1st Edition

The present volume sets forth the basic principles and the clinical practice of andrology as the science of male reproductive health and dysfunction.

This book is to be viewed against the background of the development of reproductive medicine and andrology at our center in Munster, Germany. Following the establishment of the Clinical Research Group for Reproductive Medicine by the Max Planck Society in 1980, which was succeeded by the Institute of Reproductive Medicine at the Westphalian Wilhelms University in Munster in 1989, a center of andrological research and patient care developed, based on close cooperation between basic scientists and physicians. This close cooperation between basic research and clinical practice aims to apply scientific methods to explore the reproductive functions of the male and to harness them for mankind, both in positive and negative terms. The combination of research and patient care necessitates close contact between university clinics and institutes, in particular, the Women's Hospital, Department of Urology, Institute of Human Genetics, Institute for Clinical Radiology, Institute for Medical Microbiology, and Institute for Medical Psychology. In addition, the Institute of Reproductive Medicine participates in the network of the WHO Collaborating Centers (since 1987) and the Training Centers for Clinical Andrology of the European Academy of Andrology (since 1994).

Over the course of time we have accumulated experience in patient care and have developed clinical principles, which have been published in numerous articles, reviews, and book chapters. We consider the time ripe to present our experience and view of andrology in a textbook.

In order to present a unified volume we chose our authors either from past or present coworkers of the Institute of Reproductive Medicine or from cooperating institutions. Past or present coworkers include Dr. Martin Brinkworth, Dr. M. Angelines Castel, Dr. Trevor G. Cooper, Dr. Jorg Gromoll, Dr. Axel Kamischke, Dr. Eckhard Leifke, Priv.-Doz. Dr. Alexander Lerchl, Dr. Carl-Joachim Partsch, Dr. Claus Rolf, Dr. Manuela Simoni, Priv.-Doz. Dr. Gerhard F. Weinbauer, and Dr. Ching-Hei Yeung as well as Priv.-Doz. Dr. Christian De Geyter, Dr. Maria De Geyter, Dr. Sabine Kliesch, Priv.-Doz. Dr. Ulrich A. Knuth, and Dr. Dieter Meschede. Professor David J. Handelsman spent a 9-month sabbatical at our Institute while the book was being written. Intensive cooperation with the Women's Hospital under the directorship of Professor Dr. Hermann P. G. Schneider is of essential importance for patient care. We are closely connected to the University Urology Clinic, and this cooperation is reflected in the authorship of Professor Dr. Lothar Hertle, Priv.-Doz. Dr. Hermann van Ahlen, and Dr. Frank Oberpenning. Our patients receive psychological counseling from Professor Dr. F.A. Muthny, and Dr. Regina Oberpenning, of the Institute of

Medical Psychology. Professor Dr. Klaus Demmer, a native of Munster, has advised the Institute on ethical questions for many years. Susan Nieschlag, M.A., serves as the Institute's editor and has contributed editorial input for this volume as well. She has translated some chapters in their entirety and language-edited all others. We hope that the intellectual background shared by the authors will help to present a unified picture of andrology in this book. We thank all authors for their speedy cooperation. Strict adherence to deadlines contributed to the volume's unified appearance and to its timeliness. The Institute's secretaries, Kerstin Neuhaus, and Angelika DÜthmann deserve a great measure of thanks for word processing. Thanks too go to the members of the Springer Publishing House, Dr. Carol Bacchus, Marga Botsch, and Bernd Reichenthaler, who were responsible for the book's appearance and prompt handling. We hope that the reader will use this volume to his own advantage and to that of his patients. We are grateful for all comments and criticism.

E. Nieschlag and H. M. Behre
Münster
November 1996

Contents

1 Scope and Goals of Andrology	1
Eberhard Nieschlag	
2 Physiology of Testicular Function	11
Gerhard F. Weinbauer, Craig Marc Luetjens, Manuela Simoni, and Eberhard Nieschlag	
3 Physiology of Sperm Maturation and Fertilization	61
Trevor G. Cooper and Ching-Hei Yeung	
4 Classification of Andrological Disorders	87
Frank Tüttelmann and Eberhard Nieschlag	
5 Anamnesis and Physical Examination	93
Eberhard Nieschlag and Hermann M. Behre	
6 Imaging Diagnostics	101
Hermann M. Behre and Michael Zitzmann	
7 Endocrine Laboratory Diagnosis	109
Manuela Simoni and Eberhard Nieschlag	
8 Cytogenetic and Molecular Genetic Investigations	119
Manuela Simoni and Peter Wieacker	
9 Semen Analysis	125
Trevor G. Cooper	
10 Sperm Quality and Function Tests	139
Ching-Hei Yeung and Trevor G. Cooper	
11 Testicular Biopsy and Histology	155
Martin Bergmann and Sabine Kliesch	

12 Diseases of the Hypothalamus and the Pituitary Gland	169
Hermann M. Behre, Eberhard Nieschlag, Carl-Joachim Partsch, Peter Wieacker, and Manuela Simoni	
13 Disorders at the Testicular Level	193
Eberhard Nieschlag, Hermann M. Behre, Peter Wieacker, Dieter Meschede, Axel Kamischke, and Sabine Kliesch	
14 The Aging Male and Late-Onset Hypogonadism	239
Claus Rolf, Michael Zitzmann, and Eberhard Nieschlag	
15 Diseases of the Seminal Ducts	263
Hermann M. Behre, Eberhard Nieschlag, Wolfgang Weidner, and Peter Wieacker	
16 Disorders of Erection, Cohabitation, and Ejaculation	279
Hermann van Ahlen and Sabine Kliesch	
17 Disorders of Androgen Target Organs	323
Peter F. Wieacker, Hermann M. Behre, and Eberhard Nieschlag	
18 Testicular Dysfunction in Systemic Diseases	339
Gideon A. Sartorius and David J. Handelsman	
19 Environmental Influences on Male Reproductive Health	365
Martin H. Brinkworth and David J. Handelsman	
20 Gynecology Relevant to Andrology	391
Ulrich A. Knuth	
21 Testosterone Therapy	437
Eberhard Nieschlag and Hermann M. Behre	
22 Empirical Therapies for Idiopathic Male Infertility	457
Eberhard Nieschlag and Axel Kamischke	
23 Assisted Reproduction	469
Christian De Geyter, Maria De Geyter, and Hermann M. Behre	
24 Cryopreservation of Human Spermatozoa	505
Sabine Kliesch, Axel Kamischke, Trevor G. Cooper, and Eberhard Nieschlag	
25 Psychology of Fertility Disorders	521
Regina Oberpenning, Fritz A. Muthny, and Frank Oberpenning	

26 Sexual Medicine and Andrology	539
Klaus M. Beier	
27 Male Contribution to Contraception	557
Eberhard Nieschlag	
28 Vasectomy and Refertilization	565
Udo H. Engelmann and Oliver Gralla	
29 Approaches to Hormonal Male Contraception	577
Eberhard Nieschlag and Hermann M. Behre	
30 Pharmacological Approaches to Male Contraception	589
Trevor G. Cooper and Ching-Hei Yeung	
31 Ethical Aspects of Reproductive Medicine	601
Klaus Demmer	
Index	613

Contributors

Hermann M. Behre Centre for Reproductive Medicine and Andrology of the University, Ernst-Grube-Str. 40, 06120 Halle, Germany
e-mail: hermann.behre@medizin.uni-halle.de

Klaus M. Beier Institute of Sexology and Sexual Medicine, Center for Human and Health Sciences, Charité-Freie und Humboldt-Universität zu Berlin, 10117 Berlin-Mitte, Germany
e-mail: Klaus.Beier@Charite.de

Martin Bergmann Institute of Veterinary Anatomy, Histology and Embryology, Justus-Liebig University Gießen, Frankfurter Str. 98, 35392 Gießen, Germany
e-mail: martin.bergmann@vetmed.uni-giessen.de

Martin H. Brinkworth Biomedical Sciences, University of Bradford, Bradford, West Yorkshire, BD7 1DP, UK
e-mail: M.H.Brinkworth@bradford.ac.uk

Trevor G. Cooper Centre of Reproductive Medicine and Andrology of the University, Domagkstrasse 11, 48129 Münster, Germany
e-mail: TrevorG.Cooper@ukmuenster.de

Christian De Geyter University Women's Hospital, Spitalstrasse 21, 4031 Basel, Switzerland
e-mail: cdegeyter@uhbs.ch

Maria De Geyter University Women's Hospital, Spitalstrasse 21, 4031 Basel, Switzerland
e-mail: cdegeyter@uhbs.ch

Klaus Demmer Professor emeritus, Moral Theology of the Pontifical Gregorian University of Rome, Johanniterstraße 6, 48145 Münster, Germany

Udo H. Engelmann Urologic University Hospital Köln, Joseph-Stelzmann-Straße 9, 50924 Köln, Germany
e-mail: u-h-engelmann@uni-koeln.de

Oliver Gralla Urologic University Hospital Köln, Joseph-Stelzmann-Straße 9, 50924 Köln, Germany
e-mail: oliver.gralla@uk-koeln.de

David J. Handelsman ANZAC Research Institute & Department of Andrology,
Concord Hospital, University of Sydney, Sydney NSW 2139, Australia
e-mail: djh@anzac.edu.au

Axel Kamischke University Women's Hospital Lübeck, Ratzeburger Allee 160,
23538 Lübeck, Germany
e-mail: Axel.Kamischke@uk-sh.de

Sabine Kliesch Centre of Reproductive Medicine and Andrology of the University,
Domagkstraße 11, 48149 Münster, Germany
e-mail: Sabine.Kliesch@ukmuenster.de

Ulrich A. Knuth Endokrinologikum Hamburg, Lornsenstraße 4-6,
22767 Hamburg, Germany
e-mail: Ulrich.Knuth@endokrinologikum.com

Craig Marc Luetjens Covance Laboratories GmbH, Kesselfeld 29,
48169 Münster, Germany
e-mail: Marc.Luetjens@covance.com

Dieter Meschede Herbert-Lewin-Straße 9, 50931 Köln, Germany
e-mail: d.meschede@humangenetik-koeln.de

Fritz A. Muthny Institute for Medical Psychology of the University Clinic
Münster (UKM), Münster, Germany
e-mail: muthny@uni-muenster.de

Eberhard Nieschlag Centre of Reproductive Medicine and Andrology of the
University, Domagkstr. 11, 48149 Münster, Germany
e-mail: Eberhard.Nieschlag@ukmuenster.de

Frank Oberpenning Clinic for Urology and Paediatric Urology,
St.-Agnes Hospital, 43397 Bocholt, Germany
e-mail: f.oberpenning@st-agnes-bocholt.de

Regina Oberpenning Clinic for Urology and Paediatric Urology,
St.-Agnes Hospital, 43397 Bocholt, Germany
e-mail: f.oberpenning@st-agnes-bocholt.de

Carl-Joachim Partsch Endokrinologikum Hamburg, Lornsenstraße 4-6,
22767 Hamburg, Germany

Claus Rolf St. Josef Hospital, Wiener Str. 1, 27568 Bremerhaven, Germany
e-mail: clausrolf@web.de

Gideon A. Sartorius University Women's Hospital Basel, Spitalstrasse 21,
4031 Basel, Switzerland
e-mail: gsartorius@uhbs.ch

Manuela Simoni Department of Medicine, Endocrinology and Metabolism,
University of Modena and Reggio Emilia, 41126 Modena, Italy
e-mail: manuela.simoni@unimore.it

Frank Tüttelmann Institute of Human Genetics of the University,
Vesaliusweg 12-14, 48149 Münster, Germany
e-mail: Frank.Tuettelmann@ukmuenster.de

Hermann van Ahlen Clinic for Urology and Pediatric Urology,
Klinikum Osnabrück GmbH, 49028 Osnabrück, Germany
e-mail: vanAhlen@t-online.de

Wolfgang Weidner Clinic for Urology, Pediatric Urology and Andrology of the
University, Klinikstr. 2, 35385 Gießen, Germany
e-mail: Wolfgang.Weidner@chiru.med.uni-giessen.de

Gerhard Weinbauer Covance Laboratories GmbH, Kesselfeld 29, 48169
Münster, Germany
e-mail: gerhard.weinbauer@covance.com

Peter F. Wieacker Institute of Human Genetics of the University,
Vesaliusweg 12-14, 48149 Münster, Germany
e-mail: Wieacker@uni-muenster.de

Ching-Hei Yeung Centre of Reproductive Medicine and Andrology of the
University, Domagkstraße 11, 48129 Münster, Germany
e-mail: ChingHei.Yeung@ukmuenster.de

Michael Zitzmann Centre of Reproductive Medicine and Andrology of the
University, Domagkstr. 11, 48129 Münster, Germany
e-mail: Michael.Zitzmann@ukmuenster.de

Contents

1.1 Definition of Andrology	1
1.2 Andrology, Gynecology, Reproductive Medicine: Reproductive Health	1
1.3 Infertility, Subfertility, Sterility, Fecundity: Definition of Terms	3
1.4 The Infertile Couple as Target Patients	3
1.5 Prevalence of Infertility	5
1.6 Evidence-Based Andrology	7
1.7 Male Contribution to Contraception	9
References	9

1.1 Definition of Andrology

Andrology is defined as the branches of science and medicine dealing with reproductive functions of the male under physiological and pathological conditions (Statutes of the European Academy of Andrology).

If this definition were to be interpreted in the context of sociobiology, considering reproduction the central task of life to which the entire organism is devoted (e.g., Dawkins 2006), andrology would be a broad field. Generally and also for the purpose of this book, andrology is considered the science and practice of dealing with male reproductive functions and their disturbances in the strict sense. Following the definitions of the WHO, **male reproductive health** is the subject of andrology.

The central topics of andrology are:

(1) Infertility, (2) hypogonadism, (3) male contraception, (4) erectile dysfunction, and (5) male senescence (Fig. 1.1).

1.2 Andrology, Gynecology, Reproductive Medicine: Reproductive Health

Every layman knows that a man and a woman are necessary to produce offspring. However, a barren couple does not necessarily know whether the affliction lies on the male or the female or both sides. Therefore, it would be sensible for the couples to turn to a physician in a discipline dealing holistically with problems of infertility.

E. Nieschlag
Centre of Reproductive Medicine and Andrology of the
University, Domagkstrasse 11, D-48149 Münster/Germany
e-mail: Eberhard.Nieschlag@ukmuenster.de

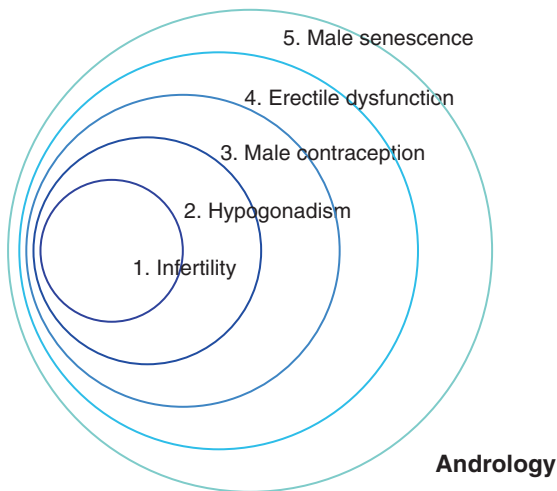

Fig. 1.1 Symbolic representation of development and scope of andrology

No matter how logical this concept may appear to the patients, medicine has barely offered appropriate solutions. Most often the individual partners of a barren couple continue to consult physicians of different disciplines in order to be diagnosed and treated. For the woman it is relatively easy to find a competent physician, since **gynecology** is a traditional field of medicine and amply represented.

It is much more difficult for the afflicted male. If he suspects problems of infertility on his part, he does not know immediately to whom he should turn. One third first consults the primary health care physician or family practitioner, one quarter turns to (his wife's) gynecologist and the remaining patients consult urologists (Bruckert 1991) and perhaps endocrinologists. As a firm discipline of medicine **andrology** is established in very few countries. It is a recognized field only in Poland and Estonia; in Italy it is a speciality, practiced, however, within the frame of endocrinology. In addition, andrology is a speciality in Egypt and Indonesia. Finally, in Germany, in 2003 the Federal Medical Board published guidelines for specialization including andrology and by 2005 andrology was established in all 16 State Medical Boards as a subspeciality of urology, endocrinology/internal medicine, and dermatology, the qualifications for which can be acquired after an 18-month postgraduate course which can be reduced to 12 months if andrological training had been included in the basic courses.

The European Academy of Andrology (EAA), founded in 1992, has established over 20 training centers in Europe.

These centers offer a 2-year course in which qualified physicians can acquire the specialty training required for the EAA examination. It is the hope of the EAA that this will gradually lead to official recognition of the field throughout Europe. Recent acceptance of the EAA training objectives by the German Federal Medical Board is an acknowledgement of this goal.

From the point of view of the afflicted couple, a specialized interdisciplinary field of **reproductive medicine** would seem to offer a solution. A few such services are in fact available at universities or in individual practices. It is, however, seldom that both partners of an infertile couple are cared for by one person; usually an interdisciplinary team consisting of an andrologist and a gynecologist working together represent reproductive medicine. At the same time there is a tendency to recognize that, because reproductive medicine has become so complex and comprehensive over recent decades, a discipline encompassing both sexes is imaginable. Especially those gynecologists working in this field have distanced themselves so far from oncology and obstetrics that they can conceive of an independent **specialty of reproductive medicine including andrology**.

The World Health Organization (WHO) considers the couple as a single entity in its definition of "**reproductive health**," which it defines as freedom from disease and disturbances of reproductive functions, both in the male and in the female. As part of its concept of reproductive health the WHO postulates that reproduction should take place in an environment of physical, mental and social well-being. In addition, in its demand for self-determination of the number of children by the couple, it assumes that both partners have free access to reliable contraceptive methods. In its research program on human reproduction the WHO devotes itself to problems both in the female *and* in the male. Whereas in previous years the investigation of female reproductive functions stood in the foreground, more recently studies on male fertility have been given equal weight.

As desirable as care for the infertile couple by only one attending physician may appear, it should not be overlooked that, apart from the initial consultation and those eventually occurring during the course of treatment, the actual investigations of husband and wife do

not necessarily proceed in synchrony. Only when techniques of assisted fertilization, which, however, are still only appropriate for selected couples, are applied is closest cooperation mandatory. Moreover, andrology covers certain aspects of male reproductive functions which can be treated largely without recourse to the partner, **e.g., replacement therapy in hypogonadism, delayed pubertal development, erectile dysfunction, contraception and male senescence. For this reason, in addition to gynecology**, the part of reproductive medicine dealing with the male, i.e., **andrology**, is indispensable. Moreover, the field of reproductive gynecology is so comprehensive that it cannot adequately deal with problems of the male as well. While not losing sight of the goal of an integrated field of reproductive medicine, at present, the development of **gynecology and andrology** as separate fields seems to offer the most advantages, not forgetting, however, that **both fields should cooperate most closely** in the care of the infertile couple, e.g., within the framework of a **center for reproductive medicine**. When treatment consists of assisted reproduction, German guidelines (Bundesärztekammer 2006) require that one of a minimum of three physicians must be an andrologist. For practical purposes this means that an andrologist must be part of every center of reproductive medicine.

1.3 Infertility, Subfertility, Sterility, Fecundity: Definition of Terms

When speaking of disturbed fertility, certain concepts must be introduced and defined. It must also be taken into consideration that terminology may change over time.

Fertility refers to the capability to conceive or induce a pregnancy. **Fecundity** refers to the probability of producing a live birth arising from a given menstrual cycle.

Infertility is the term used when a couple fails to induce a pregnancy within 1 year of regular unprotected intercourse. **Primary infertility** defines the condition when no pregnancy at all has been achieved, and *secondary infertility* means no further pregnancies have occurred. The term infertile can be applied to both men and women.

In addition to infertility, the term **sterility** is also used. Historically, it is an even older term. However, **infertility** is the more general term which may also include sterility (Templeton 1992). “Infertility” is doubtless the most accurate description for childlessness. “Sterility,” on the other hand, is a term with additional meanings as well (e.g., in the context of hygiene). “Infertility” also has the advantage of making less of a value judgement and avoids terminological ambiguity, for infertility and sterility are not separable nosological entities. The change in usage is reflected by the fact that up to 1982 the database Medline used “**sterility**”; since then “**infertility**” has been in use as a headline word (National Library of Medicine 1993).

One objection to general use of the concept of “infertility” as opposed to “fertility” is that what is meant may actually be **subfertility**, as basically, the ability to sire or conceive may actually exist, e.g., with another partner. However, here too it is difficult to delineate sharply between definitions. The suggestion to drop the term “infertility” and replace it by grades 0–4 and percentage of fertility chances lacks general acceptance as there are no clear criteria to define the percentages (Habbema et al. 2004).

For these reasons in this volume we use the term **infertility** to refer to disturbed fertility in general and we speak of it when, within 1 year of regular, unprotected intercourse, no pregnancy occurs. One can discriminate between primary and secondary infertility, depending on whether a pregnancy has once been induced or not.

1.4 The Infertile Couple as Target Patients

Even if medical care of the female suffering from disturbed fertility is much better organized than that of the man, an analysis of the distribution of causes of disturbed fertility shows that in up to half of the couples wishing offspring the male may be implicated (Fig. 1.2). Disturbances in fertility may remain latent for years and only become evident when a couple develops a firm desire for a child. It is of particular importance that the suboptimal reproductive capacities of one partner may become evident because of the infertility of the other partner. This demonstrates the

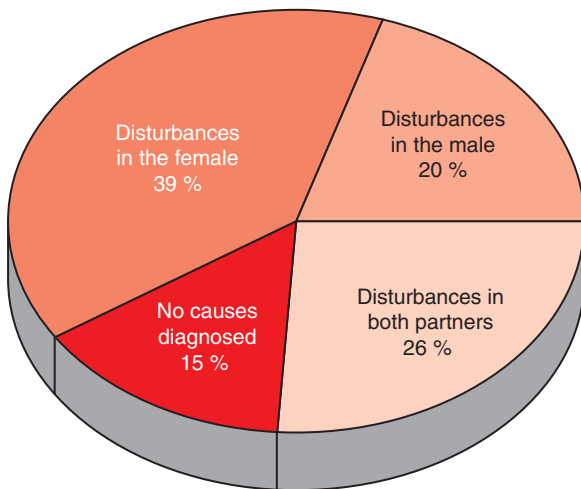

Fig. 1.2 Distribution of causes of involuntary childlessness between men and women

interdependence of male and female reproductive functions, as shown schematically in Fig. 1.3.

In order to evaluate the effects of limited reproductive functions it is important to know the **time span** within which a “normal” couple of group 1 (Fig. 1.3) will conceive. If a young couple of group 1 plans a pregnancy it will occur within 3 months in 75% of couples (Falk and Kaufmann 1950). In unselected women attending the delivery ward of a larger German municipal hospital 70% conceived within the first 6 months and 90% conceived within the first 12 months of unprotected intercourse (Knuth and Mühlentstedt 1991).

However, this rate decreases steadily with the **age of the female partner**. In women older than 25 years pregnancy occurs in 80% of couples only within 20–28 months (Bender 1953). In women whose husbands are azoospermic and who submitted to donor insemination, a rapid decline of fecundity could be found after the age of 30 (Van Noord-Zaadstra et al. 1991). This is attributable to the declining ability of the egg to be fertilized. Results from assisted reproduction show that the pregnancy rates of the female partner clearly decline after the age of 35 (Fig. 1.4). However, the age of the male partner also influences the occurrence of pregnancy. The “time to pregnancy” (TTP), an important parameter for characterizing the fertility of a couple, increases when the male is over 40 independent of the woman’s age (see Chap. 14).

Moreover, the frequency of coitus plays an important role. When both semen parameters and female factors are normal, the interval to conception decreases

	3	2	1
optimal			
impaired	5	4	2
absent	5	5	3
	absent	impaired	optimal
	Female reproductive functions		

Fig. 1.3 Interdependence of male and female reproductive functions:

- Couples from group 1, with both partners having optimal reproductive functions, will not consult a physician because of childlessness
- The suboptimal functions of one partner in couples of group 2 will probably be compensated for by the optimal functions of the other partner. These couples are probably more prevalent in the general population than their representation in fertility clinics may suggest
- In couples of group 3 treatment will be concentrated only on one partner and treatment by only either gynecologist or andrologist will suffice
- Both partners of groups 4 and 5 require treatment. Therapeutic success i.e., pregnancy will be achieved more rapidly the more intensive and coordinated medical care is. Precisely these couples benefit most from treatment in a center for reproductive medicine where physicians have both gynecological and andrological training

with the frequency of coitus as long as sperm production is not exhausted. Partners complaining of involuntary childlessness of more than 12 months’ duration and in whom andrological factors have been excluded achieve a maximum conception rate when coitus takes place two to three times per week (McLeod et al. 1955). When sperm production is limited, however, this direct relationship is no longer valid.

Also the **timing of coitus** is of great importance. Most conceptions occur on the day of ovulation and the two preceding days, few conceptions, if intercourse takes place on days 3–5 before ovulation, but no conceptions after the day of ovulation (Wilcox et al. 1995).

It follows that **younger couples** should be examined only after they have tried to found a family for at least 1 year. Should the **woman be over 30 years and/**

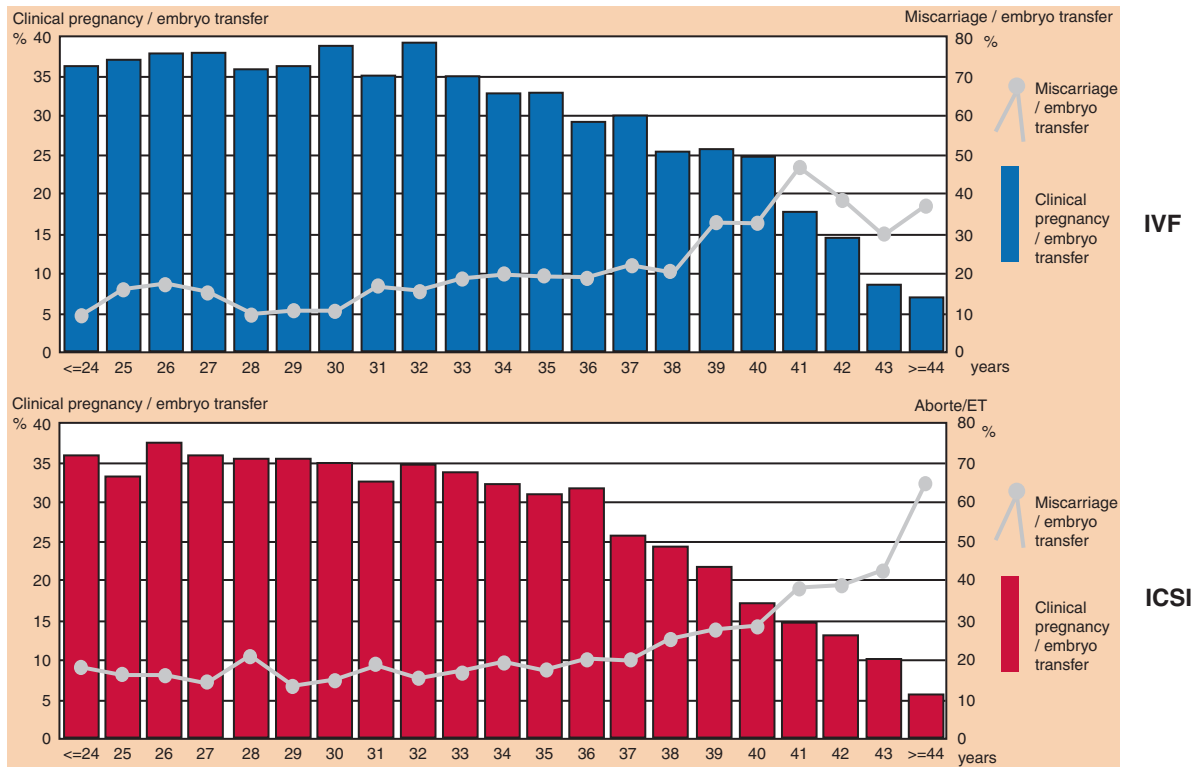

Fig. 1.4 Pregnancy rate per follicle puncture in 10,362 IVF cycles and 28,498 ICSI cycles in relation to the age of the women (Deutsches IVF-Register DIR 2007)

or the male partner be over 40, investigations may be initiated earlier. In industrialized nations married childless couples tend to belong to the latter group as the average age at marriage is increasing. Whereas in Germany it was 23.7 for women and 25.9 for men in 1975, by 2005 it had increased to 29.7 for women and 32.6 for men. However, in the meantime 30% of all German children are born to unmarried couples so that the age at marriage no longer corresponds to the age at which parenthood is to be realized. The age of the couples visiting the fertility clinic rises correspondingly. Thus the average age of the female partner at her first visit to our center in 1979 was 28.0

The interdependencies of male and female reproductive functions described above should provide reason enough to examine both partners simultaneously in the event of involuntary childlessness. Both partners should be examined with the same degree of thoroughness. Good medical practice requires a full anamnesis, careful physical examination followed by all necessary technical and laboratory investigations.

years and 32.4 years in 2005 and her partner's age was 29.4 and 35.8 years (Fig. 1.5).

The entity represented by the couple with disturbed fertility must not be ignored. For this reason, although this volume deals primarily with andrology, it also provides an overview of diagnosis and therapy of female infertility (see Chap. 20).

1.5 Prevalence of Infertility

Information on the prevalence of infertility indicates great variability and only few reliable data are available (review in Schmidt and Münster 1995; Templeton 1992). Infertility shows considerable geographic variation; according to WHO primary infertility is lowest in the Middle East and highest in Central Africa (Farley and Belsey 1988). No absolutely firm data are available for Germany. Estimations assumed a prevalence of (primary and secondary) infertility of up to 15% and more of all couples of reproductive age (Bruckert 1991; Juul et al. 1999). There are marked regional variations within

Fig. 1.5 Age of men and women in Germany at time of first marriage and age of infertile patients at the Institute of Reproductive Medicine, Münster, at first visit

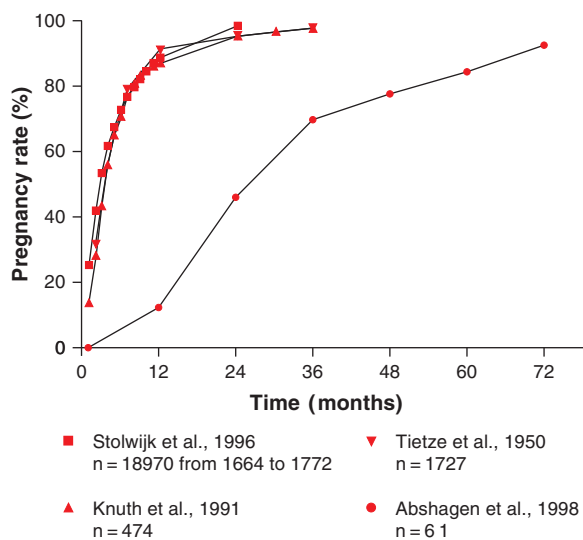
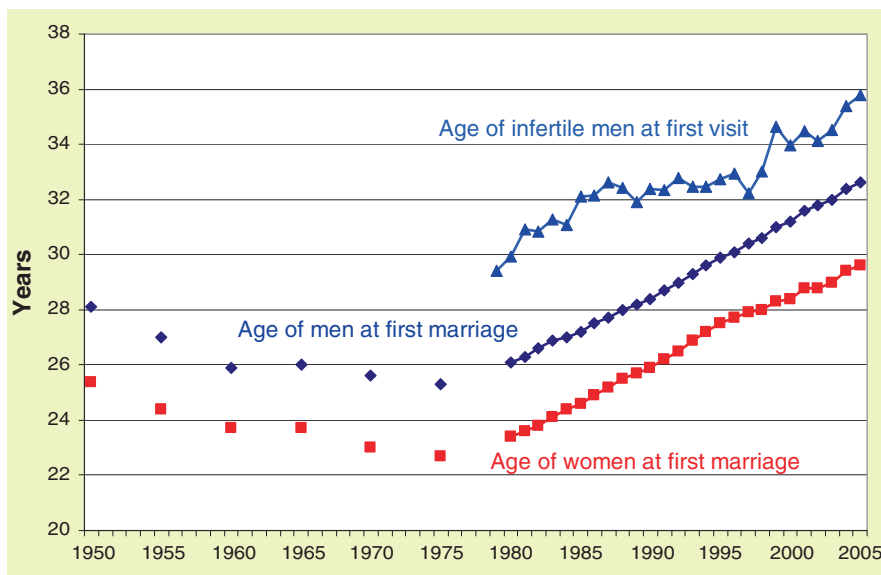

Fig. 1.6 Cumulative pregnancy rates of different normal populations in different epochs. Stolwijk et al. (1996) investigated Canadian church registers from the 17th and 18th centuries, Tietze et al. (1950) analyzed a population in New York and Knuth and Mühlentstedt (1991) interviewed mothers of newborns in a maternity ward in Germany. For comparison, pregnancy rates of untreated couples with sperm surface antibodies in seminal plasma are shown (Abshagen et al. 1998)

Europe and even between East and West Germany (Juul et al. 1999). Conversely, little change has occurred in the “time-to-pregnancy” curves which have been constructed over centuries in various populations (Fig. 1.6).

Often it is asked whether the incidence of infertility is increasing. Reports about a presumed decline in sperm numbers contribute to this speculation and are discussed critically in Chap. 19. Whereas some epidemiologists consider the problem as too complex and available data as inadequate (Sallmén et al. 2005), there are solid analyses which find a decline of infertility in the western world. With reference to a 12-month period of infertility from 1982 to 2002 of married American 15–44 year-old women, a representative survey by the USA National Survey of Family Growth found a decline of infertility from 8.5% to 7.2% (Stephen and Chandra 2006). Parallel tendencies are reported from Sweden and Great Britain (Joffe 2000; Scheike et al. 2008). The reasons presumed are improved sexual and general education, a decline in smoking, and the containment or early treatment of venereal diseases. The application of ART has become so widespread that its success also provides demographic impulses (Hoorens et al. 2008; Ziebe and Devroey 2008). Finally, improved upbringing and education of patients play a decisive role so that they are no longer willing to accept their fate but take an active role in searching for solutions and medical aid.

The proportion of couples seeking medical treatment for infertility is estimated at 4–17%. Ultimately 3–4% of all couples remain involuntarily childless at the end of their reproductive life phase (Templeton 1992).

As male causes for infertility are found in half of involuntarily childless couples, it must be assumed

that **about 7% of all men** are confronted with the problem of disturbed fertility in the course of their lives. This means that the prevalence of infertility in men clearly exceeds that of diabetes mellitus (types I and II), which is often considered almost endemic.

The incidence of individual disturbances of fertility will be dealt with in connection with the diseases discussed in the following chapters.

1.6 Evidence-Based Andrology

There are many reasons why so much time passed before andrology developed into an independent specialized medical discipline. One important reason is that, until recently, diagnostic and therapeutic measures had not reached a critical mass great enough to justify establishment of an independent field. It is a fact that research efforts investigating the physiology and pathology of male reproductive functions were not undertaken systematically before the 1960s and pathophysiological concepts explaining individual diseases only gradually emerged. One factor contributing to the situation was also that andrological diagnostic techniques lacked standardization and tended to produce vague diagnoses. At least 30% of cases of disturbed male fertility still remain etiologically unclear and are referred to as **idiopathic infertility** (see Chaps. 4 and 22).

These shortcomings, characterizing andrology as well as other specialties, often meant that the physician's personal authority and experience tended to become the dominating factor in management decisions. The situation makes it tempting for some physicians to apply innumerable empirical therapeutic procedures whose effectiveness remain uncertain. Many errors in judgement – not only in andrology – can be attributed to this attraction to meddling but unproven treatments.

With the advance of basic research and scientific thinking in andrology, the dilemma became obvious to those actively practicing clinical andrology and a **“new andrology”** operating on scientific thinking and rationally based medical practice was called for. **“Evidence-based andrology”** developed simultaneously with the beginnings of **“evidence-based medicine,”** which is increasingly becoming a pervasive force in all fields of medicine. It marks a gradual shift of paradigm in clinical medicine.

The term “evidence-based medicine” signifies that clinical decisions must be based on results from controlled clinical studies and applied statistics and not rely predominantly on intuition, empiricism and traditional protocols (Antes 1998; Cochrane Collaboration, www.cochrane.org).

Whereas they remained rare in the 1960s, today **controlled, prospective, randomized and, if possible, double-blind clinical studies** are the accepted standard for evaluating the effectiveness of a diagnostic or therapeutic measure. No medication, no interventional measure nor any diagnostic test should be incorporated into clinical practice if its effectiveness has not been proven by appropriate controlled studies. (There will, of course, be exceptions to this, as e.g., hormonal replacement therapy for which the physiological hormone levels in serum represent the target parameters.) The highest degree of evidence is achieved when several controlled studies deliver identical results in a meta-analysis. While the clinical andrologist found it particularly difficult to incorporate this **shift of paradigm into the decision-making process**, the exponential increase in clinical studies concerning infertility treatment in the 1990s showed that this concept is finally becoming established in andrology as well.

The details of carrying out **controlled clinical studies** cannot be dealt with here. The most important elements are the studies' design and statistical evaluation. Over and beyond the problems generally caused by performing controlled studies in other fields of medicine, studies on infertility treatment face the particular difficulty that not *one* patient is being dealt with, a *second* participant must not only fulfill strict inclusion criteria, but is in fact the person in whom the end-point, pregnancy, occurs. The fact that pregnancy rates are naturally relatively low and that therefore large numbers of patients must be followed over prolonged periods of time creates special problems in controlled clinical studies on infertility treatment.

“Evidence-based medicine” also subjects **pathophysiological concepts**, on which diagnosis and therapeutic measures are based, to **critical examination** and assumes that not all pathophysiological concepts must be correct **a priori**. This is supported by experience from basic research showing that errors do in fact occur, that

research results may be translated prematurely into clinical strategies, thus giving rise to conceptual “short circuits.” Examples of this are demonstrated by the various ill-founded treatments of idiopathic male infertility (see Chap. 16). Evidence-based medicine demands that translation of a scientific concept into a clinical strategy be provable by rational means and that it stand up under conditions of a controlled clinical study. The goal of this volume is to follow the precepts of evidence-based medicine to the extent possible and thus it is justified to apply the term evidence-based andrology to the message of this book.

One of the important components of evidence-based andrology is **standardized diagnostics**, making results within one laboratory as well as between laboratories comparable. In this respect the *WHO Laboratory Manual for the Examination and Processing of Human Semen* (5th edition 2009) is a standard work and provides the basis for all andrological laboratory diagnosis. Notwithstanding that Chap. 9 of the present volume briefly describes semen analysis as a laboratory technique, the **WHO Manual must be considered as an appendix to this volume**. The methodology described provides the basis for both internal and external quality control in the andrology laboratory which even today remains in its beginning stages. It is to be hoped that other areas of andrological diagnostics will be standardized to further buttress evidence-based andrology.

As long as there is no therapy for the causal treatment of male infertility, the concept of rational andrology remains endangered. When, at the conclusion of diagnostic procedures, only techniques of assisted reproduction (ICSI and TESE) remain as possible solutions, the time and effort required for careful diagnosis may seem exaggerated. This short-sighted conclusion must be rejected emphatically, as many treatable pathologies may be discovered by meticulous investigations. A drastic example are testicular tumors of which 200 were discovered among infertile men at an andrology clinic, but only because thorough diagnosis including ultrasound was performed.

While it is desirable that andrology increasingly be given a firm scientific base and that diagnostic and therapeutic measures be tested by their results, it must not be forgotten that **the patient or couple** requiring care remains the **central point of medical attention**. This includes providing time for extensive counselling, for

clarifying physical and pathological facts, for explaining diagnostic findings and therapeutic measures, for answering questions concerning sexuality, for exploring the importance of a child to each partner and to the couple. The patient must be convinced by practice that precisely these aspects are of greatest importance to the physician, whereas scientific validity of his management must be the unspoken precondition of professional expertise underlying patient-doctor interaction.

The **placebo-effect of medical advice and attention** must never be underestimated. This assumes that the **placebo be defined** as a measure lacking a specific effect, but which will nevertheless have a significantly greater influence on the desired outcome than no measure at all (Gotzsche 1994). It must be stressed that the placebo so defined has no negative connotation, of which it is often accused. The meaningfulness of such a placebo-effect becomes clear from results of a controlled study on therapy for varicocele: patients subjected to surgical or angiographic intervention showed the same pregnancy rates as those only counselled and examined at regular intervals (Nieschlag et al. 1998).

Knowing the placebo-effect of medical attention and applying it in treatment strategies is just as much a part of evidence-based andrology as its scientific basis.

When judging the success of therapy it should also be considered that infertility does not represent an absolute diagnosis, but that factors related to time may play an important role. In the course of time pregnancies may occur spontaneously, without any medical intervention. When couples on the Dutch island of Walcheren consulting a primary care center for infertility were left “untreated,” after 2 years the spontaneous pregnancy rate was 40% (Snick et al. 1997). When patients at a tertiary fertility center were treated similarly, after the 2-year observation period the pregnancy rate was 20% (Canadian Infertility Therapy Evaluation Study; Collins et al. 1995) (Fig. 1.7). The figures show that the selection of couples plays an important role and that even at a specialized center spontaneous pregnancies occur. Such occurrences must be taken into consideration when judging therapeutic measures; they are the basis for models predicting the chances for pregnancies (Collins et al. 1995).

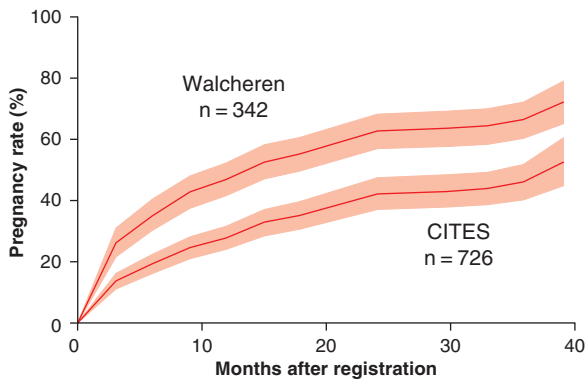

Fig. 1.7 Cumulative pregnancy rates in two populations of diagnosed, but untreated couples in centers of primary care (Walcheren) and of tertiary care (Canadian Infertility Therapy Evaluation Study CITES, Collins et al. 1995). Only pregnancies resulting in live births were computed (From Snick et al. 1997)

1.7 Male Contribution to Contraception

Providing male contraceptive methods is one of the **tasks of andrology**. Here the question arises whether the andrologist (or the specialist for reproductive medicine) is not at odds with himself if, on the one hand, he treats disturbed fertility and contributes to increasing birthrates, and on the other hand, provides contraceptive methods, thus influencing birthrates negatively.

The **apparent contradiction** is easily resolved as it is a matter of two sides of the same coin. Once the reproductive system has been understood, it can be influenced both positively and negatively. Andrology and reproductive medicine **do not in the first instance** concern themselves with the **politics of population control**. Rather they are primarily directed towards the individual and strive to help the individual couple to improve its affected reproductive functions, or to control them if they are not required. In this fashion reproductive medicine should help to reduce the suffering experienced by the couple wanting a child, while simultaneously creating the prerequisites allowing the couple to freely determine the size of its family. Finally, creating the medical preconditions also provides the means of curbing the world's overpopulation as a by-product of care for the individual patients and their voluntary rights to reproductive freedom and family planning. As male contraceptive methods in particular are lacking, research leading to the development of such methods appears strongly needed.

Reproduction can be considered as compensation for death. If medical progress allows increasing numbers of people to reach reproductive age, and if, during periods of increasing birthrates the date of death continues to be pushed forward thus leading to overpopulation, then medicine must also provide contraceptive methods in order to maintain or restore a balance between reproduction and death. Andrology must contribute to this goal.

References

- Abshagen K, Behre HM, Cooper TG, Nieschlag E (1998) Influence of sperm surface antibodies on spontaneous pregnancy rates. *Fertil Steril* 70:355–356
- Antes G (1998) Evidence based medicine. *Internist* 39:899–908
- Bender S (1953) End results in treatment of primary sterility. *Fertil Steril* 4:34–40
- Bruckert E (1991) How frequent is unintentional childlessness in Germany? *Androl* 23:245–250
- Bundesärztekammer (2006) (Muster-)Richtlinie zur Durchführung der assistierten Reproduktion, Novelle 2006. www.bundesaeztekammer.de
- Collins JA, Burrows EA, William AR (1995) The prognosis for live birth among untreated infertile couples. *Fertil Steril* 64:22–28
- Dawkins R (2006) *The selfish gene*, 2nd edn. Oxford University Press, Oxford
- Deutsches IVF-Register (DIR) (2007) Bad Segeberg
- European Academy of Andrology (EAA) (1999) Handbook. *Int J Androl* 22(Suppl):1
- Falk HC, Kaufmann SA (1950) What constitutes a normal semen? *Fertil Steril* 1:489–496
- Farley TMM, Belsey FH (1988) The prevalence and aetiology of infertility. In: *Biological Components of Fertility. The Proceedings of the African Population Conference, Dakar, Senegal, November 1988. International Union for the Scientific Study of Population, Liège, Belgium, vol 1, pp 2115–2130*
- Gotzsche PC (1994) Is there logic in the placebo? *Lancet* 344:925–926
- Habbema JDF, Collins J, Leridon H, Evers JLH, Lunenfeld B, teVelde ER (2004) Towards less confusing terminology in reproductive medicine: A proposal. *Hum Reprod* 19: 1497–1501
- Hoorens S, Gallo F, Cave JA, Grant JC (2008) Can assisted reproductive technologies help to offset population ageing? An assessment of the demographic and economic impact of ART in Denmark and UK. *Hum Reprod* 22: 2471–2475
- Joffe M (2000) Time trends in biological fertility in Britain. *Lancet* 355:1961–1965
- Juul S, Karmaus W, Olsen J and The European Infertility and Subfecundity Study Group (1999) Regional differences in

- waiting time to pregnancy: Pregnancy-based surveys from Denmark, France, Germany, Italy and Sweden. *Hum Reprod* 14:1250–1254
- Kamischke A, Nieschlag E (1999) Analysis of medical treatment of male infertility. *Hum Reprod* 14(Suppl 1):1–23
- Knuth UA, Mühlenstedt D (1991) Kinderwunschdauer, kontrazeptives Verhalten und Rate vorausgegangener Infertilitätsbehandlung. *Geburtsh Frauenheilk* 51:1
- McLeod J, Gold RZ, McLane CM (1955) Correlation of the male and female factors in human infertility. *Fertil Steril* 6: 112–120
- Nieschlag E, Hertle L, Fishedick A, Behre HM (1995) Treatment of varicocele: Counselling as effective as occlusion of the vena spermatica. *Hum Reprod* 10:347–353
- Nieschlag E, Hertle L, Fishedick A, Abshagen K, Behre HM (1998) Update on treatment of varicocele: counselling as effective as occlusion of the vena spermatica. *Hum Reprod* 13:2147–2150
- Sallmén M, Weinberg CR, Baird DD, Lindbohm ML, Wilcox AJ (2005) Has human fertility declined over time? Why we may never know. *Epidemiology* 16:494–499
- Scheike TH, Rylander L, Carstensen L, Keiding N, Jensen TK, Stromberg U, Joffe M, Akre O (2008) Time trends in human fecundability in Sweden. *Epidemiology* 19:191–196
- Schmidt L, Münster K (1995) Infertility, involuntary infecundity, and the seeking of medical advice in industrialized countries 1970–1992: A review of concepts, measurements and results. *Hum Reprod* 10:1407–1418
- Snick HKA, Snick TS, Evers JLH, Collins JA (1997) The spontaneous pregnancy prognosis in untreated subfertile couples: The Walcheren primary care study. *Hum Reprod* 12:1582–1588
- Stephen EH, Chandra A (2006) Declining estimates of infertility in the United states: 1982–2002. *Fertil Steril* 86:516–523
- Stolwijk AM, Straatman H, Zielhuis GA, Jongbloet PH (1996) Seasonal variation in the time to pregnancy: Avoiding bias by using the date of onset. *Epidemiology* 7:156–160
- Templeton AA (1992) The epidemiology of infertility. In: Templeton AA, Drife JO (eds) *Infertility*. Springer, London, pp 23–32
- Tietze C, Guttmacher AF, Rubin S (1950) Time required for conception in 1727 planned pregnancies. *Fertil Steril* 1:338–346
- van Noord-Zaadstra BM, Looman CWN, Alsbach H, Habbema JDF, te Velde ER, Karbaat J (1991) Delaying childbearing: effect of age on fecundity and outcome of pregnancy. *Br Med J* 302:1361–1365
- Wilcox AJ, Weinberg CR, Baird D (1995) Timing of sexual intercourse in relation to ovulation: Effects on the probability of conception, survival of the pregnancy, and sex of the baby. *N Engl J Med* 333:1517–1521
- WHO (2009): *Laboratory manual for the examination and processing of human semen*. WHO, Geneva (in press)
- Ziebe S, Devroey P on behalf of the State of the Art 2007 Workshop Group (2008) Assisted reproductive technologies are an integrated part of national strategies addressing demographic and reproductive challenges. *Hum Reprod Update* 14:583–592

Contents

2.1 Functional Organization of the Testis	11
2.1.1 Interstitial Compartment	11
2.1.2 Tubular Compartment	14
2.2 Hormonal Control of Testicular Function	21
2.2.1 Functional Organization of the Hypothalamo-Pituitary System	21
2.2.2 The Kisspeptin-GPR54 System	22
2.2.3 GnRH	24
2.2.4 Gonadotropins	28
2.2.5 Endocrine Regulation and Relative Importance of LH and FSH for Spermatogenesis	31
2.2.6 Local Regulation of Testicular Function	33
2.3 Testicular Descent	36
2.4 Vascularization, Temperature Regulation and Spermatogenesis	37
2.5 Immunology of the Testis	37
2.6 Testicular Androgens	39
2.6.1 Synthesis of Androgens	40
2.6.2 Testosterone Transport in Blood	42
2.6.3 Extratesticular Metabolism of Testosterone	43
2.6.4 Mechanism of Androgen Action	44
2.6.5 Biological Actions of Androgens	49
2.6.6 Androgen Secretion and Sexual Differentiation	52
References	54

2.1 Functional Organization of the Testis

The testes produce the male gametes and the male sexual hormones (**androgens**). The term **spermatogenesis** describes and includes all the processes involved in the production of gametes, whereas **steroidogenesis** refers to the enzymatic reactions leading to the production of male steroid hormones. Spermatogenesis and steroidogenesis take place in two compartments morphologically and functionally distinguishable from each other. These are the tubular compartment, consisting of the seminiferous tubules (**tubuli seminiferi**) and the interstitial compartment (**interstitium**) between the seminiferous tubules (Figs. 2.1 and 2.2). Although anatomically separate, both compartments are closely connected with each other. For quantitatively and qualitatively normal production of sperm the integrity of both compartments is necessary. The function of the testis and thereby also the function of its compartments are governed by the hypothalamus and the pituitary gland (**endocrine regulation**). These endocrine effects are mediated and modulated at the testicular level by local control mechanisms (**paracrine and autocrine factors**).

2.1.1 Interstitial Compartment

The most important cells of this compartment are the Leydig cells. These cells are the source of testicular testosterone and of **insulin-like factor 3** (INSL3). Aside from Leydig cells, the interstitial compartment also contains immune cells, blood and lymph vessels, nerves, fibroblasts and loose connective tissue. In experimental animals this compartment comprises

G. F. Weinbauer (✉)
Research and Safety Assessment, Covance
Laboratories GmbH, Kesselfeld 29,
D-48169 Münster, Germany
e-mail: gerhard.weinbauer@covance.com

Fig. 2.1 Section of an entire human testis cut transversally. The preparation also includes parts of the efferent ducts and the epididymis. The lobular architecture of the testis is evident (Courtesy of Prof. Dr. A.F. Holstein, Institute of Anatomy, University of Hamburg)

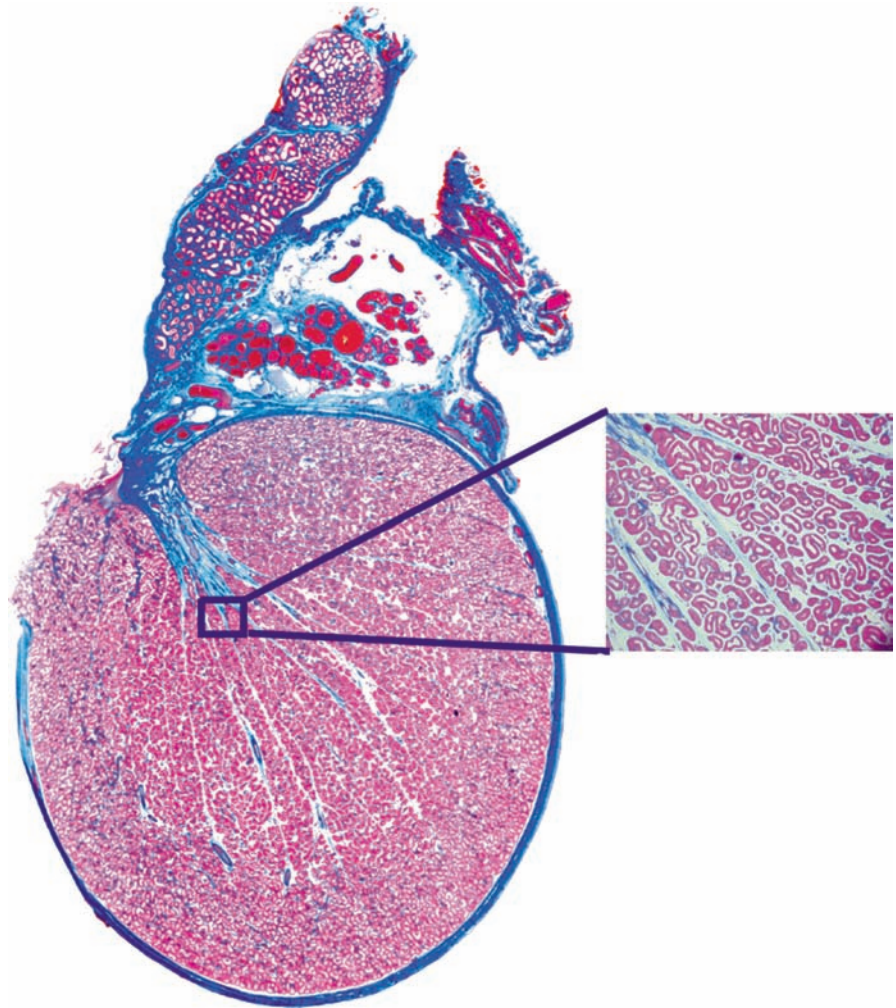

about 2.6% of the total testicular volume. In the human testis the interstitial compartment represents about 12–15% of the total testicular volume, 10–20% of which is occupied by **Leydig cells**. Human testes contain approximately 200×10^6 Leydig cells.

2.1.1.1 Leydig Cells

These cells were first described in 1850 by Franz Leydig (1821–1908). Leydig cells produce and secrete the most important male sexual hormone, testosterone. From the developmental, morphological and functional viewpoint different types of cells can be distinguished: stem Leydig cells as founder cell, progenitor Leydig cells as a committed stem cell, fetal Leydig cells as a terminally

differentiated cell in the fetus, and adult Leydig cells as the terminally differentiated Leydig cell (Ge and Hardy 2007). Fetal Leydig cells become neonatal Leydig cells at birth and degenerate thereafter or regress into immature Leydig cells (Prince 2007). Fetal Leydig cells produce testosterone. Immature Leydig cells that mainly produce androstane-3 α , 17 β -diol instead of testosterone have also been described.

Adult Leydig cells are rich in smooth endoplasmic reticulum and mitochondria with tubular cristae. These physiological characteristics are typical for steroid-producing cells and are very similar to those found in other steroidogenic cells, such as those in the adrenal gland and in the ovary. Other important cytoplasmic components are lipofuscin granules, the final product of endocytosis and lysosomal degradation, and lipid

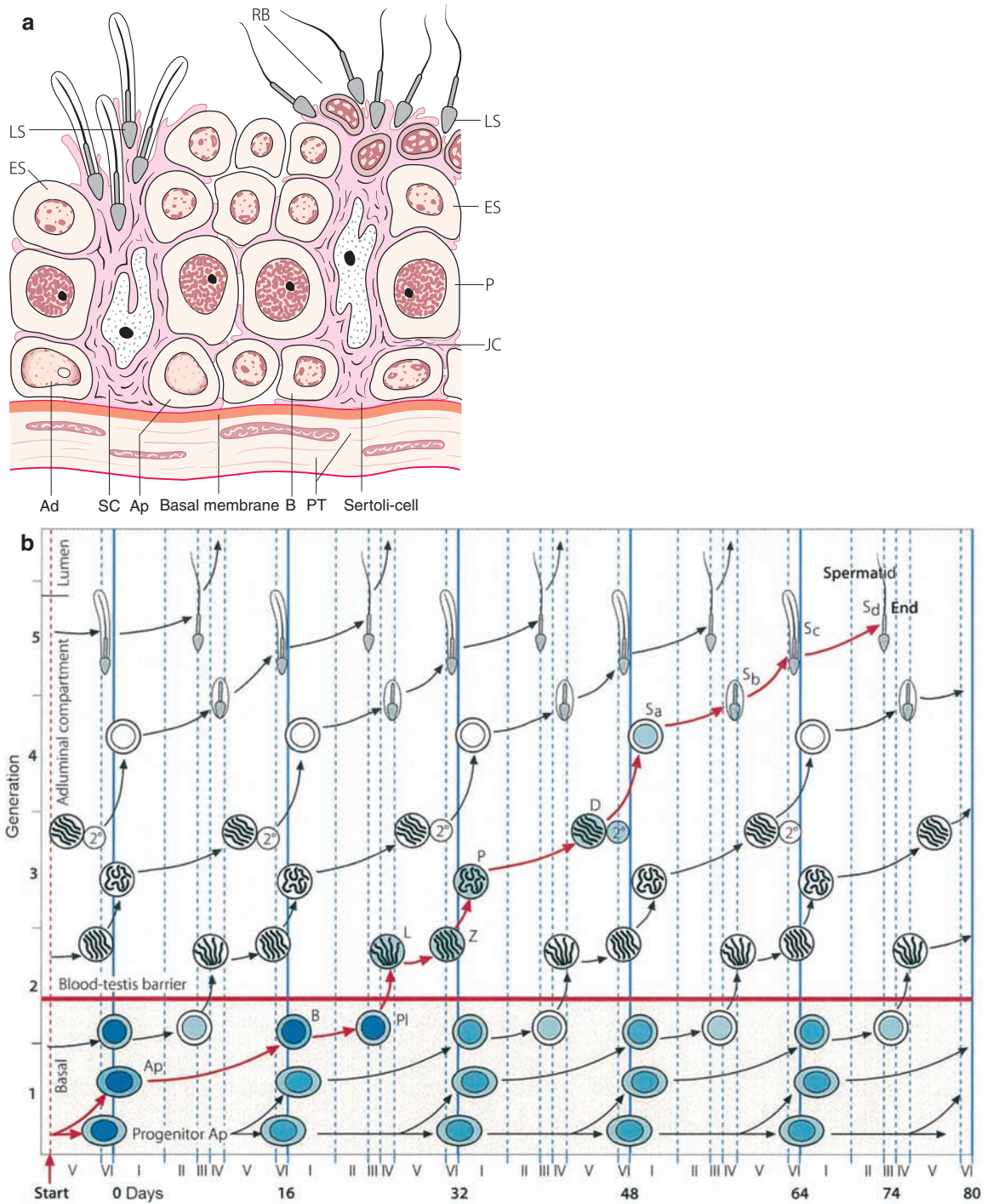

Fig. 2.2 (a) Schematic representation of the architecture of the human seminiferous epithelium. Note that the tubular wall is composed of several layers of peritubular cells (PT) and a basal lamina (BL). RB = Residual Body, LS = Late/elongating and elongated spermatids, ES = Early/round spermatids, P = Spermatocytes, Ad = A-dark-type spermatogonia (testicular stem cells), Ap = A pale-type spermatogonia; B = B-type spermatogonia, SC = Sertoli cells, JC = junctional complexes constituting the blood-testis barrier built by interconnected Sertoli cells. Modified from Ross (1985)

(b) Depicts the kinetics of the human seminiferous epithelium. Ap spermatogonia are the progenitor stem cells that enter the spermatogenic cycle (color-coded). All descendents of this progenitor cell represent a single clone of germ cells. Ad = A-dark-type spermatogonia, B = B-type spermatogonia, Pl = prelepotene spermatocyte; L = leptotene spermatocyte; Z = zygotene spermatocyte; D = diplotene spermatocyte. It takes 4–4.6 cycles (“generation” on the y-axis, denoted as Start and End) until a sperm (Sd) has developed from a progenitor cell (Sa, Sb, Sc) 2° = 2nd meiotic division. (Modified from Amann 2008)

droplets, in which the preliminary stages of testosterone synthesis take place. Special formations, called Reinke's crystals, are often found in the adult Leydig cells. These are probably subunits of globular proteins whose functional meaning is not known. The proliferation rate of the Leydig cells in the adult testis is rather low and is influenced by LH. The ontogeny of Leydig cells is not entirely clear and mesonephros, neural crest and coelomic sources have been involved. In the adult testis, Leydig cells develop from perivascular and peritubular mesenchymal-like cells and the differentiation of these cells into Leydig cells is induced by LH but also by growth factors and differentiation factors derived from Sertoli cells.

2.1.1.2 Macrophages, Lymphocytes and Nerve Fibers

Besides Leydig cells, the interstitial compartment also contains cells belonging to the immune system: macrophages and lymphocytes. For every 10–50 Leydig cells one macrophage is to be found. The macrophages probably influence the function of the Leydig cells, in particular their proliferation, differentiation and steroid production, through the secretion of cytokines. Macrophages secrete stimulators and inhibitors of steroidogenesis. Proinflammatory cytokines, reactive oxygen species, **nitric oxide** and **prostaglandins** can inhibit Leydig cell function (Hales 2007). There is evidence for an involvement of neurotransmitters and related signalling factors during regulation of Leydig cell function (Mayerhofer et al. 1999). The immunological meaning of these cells for testicular physiology will be discussed under Sect. 2.5.

2.1.2 Tubular Compartment

Spermatogenesis takes place in the tubular compartment. This compartment represents about 60–80% of the total testicular volume. It contains the germ cells and two different types of somatic cells, the **peritubular cells** and the **Sertoli cells**. The testis is divided by septa of connective tissue into about 250–300 lobules (Fig. 2.1), each one containing 1–3 highly convoluted seminiferous tubules. Overall, the human testis contains about 600 seminiferous tubules. The length of

individual seminiferous tubules is about 30–80 cm. Considering an average number of about 600 seminiferous tubules per testis and an average length of the tubuli seminiferi of about 60 cm each, the total length of the tubuli seminiferi is about 360 m per testis, i.e., 720 m of seminiferous epithelium per man.

2.1.2.1 Peritubular Cells

The seminiferous tubules are covered by a lamina propria, which consists of a **basal membrane**, a layer of collagen and the **peritubular cells (myofibroblasts)**. These cells are stratified around the tubulus and form up to concentric layers that are separated by collagen layers (Fig. 2.1). These characteristics differentiate the human testicle from the majority of the other mammals, whose seminiferous tubules are surrounded only by 2–4 layers of myofibroblasts. Peritubular cells produce several factors that are involved in cellular contractility: **panactin, desmin, gelsolin, smooth muscle myosin and actin** (Holstein et al. 1996). These cells also secrete extracellular matrix and factors typically expressed by connective tissue cells: **collagen, laminin, vimentin, fibronectin, growth factors, fibroblast protein** and adhesion molecules (Albrecht et al. 2006; Schell et al. 2008). The latter work established a human peritubular cell culture system demonstrating secretion of nerve growth factor and pro-inflammatory molecules, e.g., **IL-1 β** and **cyclooxygenase-2** under the influence of **TNF- α** (Schell et al. 2008). Myofibroblasts are poorly differentiated myocytes with the capacity of spontaneous contraction. Mature sperm are transported towards the exit of the seminiferous tubules by contraction of these cells and several regulators of cell contractions are reported, e.g., **oxytocin**, oxytocin-like substances, **prostaglandins**, androgenic steroids, **endothelins**, endothelin converting enzymes and endothelin receptors. Peritubular contractility is mediated by endothelin and this effect is modulated by the relaxant peptide **adrenomedullin** produced by Sertoli cells (Romano et al. 2005). Mice with selective peritubular cell androgen receptor deficiency revealed defects in contractility-related genes, e.g., endothelin-1 and endothelin receptor A and B, adrenomedullin receptor and **vasopressin** receptor 1a (Zhang et al. 2006).

Disturbances of testicular function and decreased or absent spermatogenic activity are associated with a

thickening of the layer of collagen fibres and of the material present between the peritubular cells. When this is the case, the tubular wall becomes **fibrotic** or – based on the histological appearance – **hyalinized**. The decrease of testicular volume involves folding of the wall along the length of the tubuli seminiferi, thereby causing an enlargement of the tubular diameter. This becomes particularly evident when fluid is injected into regressed seminiferous tubules. Tubular diameter increases and tubular wall thickness decreases (Schlatt et al. 1999). An interaction between testicular mast cells and peritubular cells leading to fibrotic changes of the seminiferous tubular wall has been suggested (Albrecht et al. 2006). Peritubular and interstitial fibrosis incidence correlated progressively with spermatogenic damage in testis from vasectomized men (Raleigh et al. 2004).

2.1.2.2 Sertoli Cells

Sertoli cells are somatic cells located within the germinal epithelium. In adulthood these cells are mitotically inactive. They are named after Enrico Sertoli (1842–1910), the Italian scientist who first described these cells in 1865 and, due to their prominent cytoplasmic projections and ramifications called them “cellulae ramificate”. These cells are located on the basal membrane and extend to the lumen of the tubulus seminiferus and, in a broad sense, can be considered as the **supporting structure of the germinal epithelium**. Along the cell body, extending over the entire height of the germinal epithelium, all morphological and physiological differentiation and maturation of the germinal cell up to the mature sperm take place. Special ectoplasmic structures sustain alignment and orientation of the sperm during differentiation. About 35–40% of the volume of the germinal epithelium is represented by Sertoli cells. The intact testis with complete spermatogenesis contains $800\text{--}1200 \times 10^6$ Sertoli cells (Zhengwei et al. 1998a) or approximately 25×10^6 Sertoli cells per gram testis (Raleigh et al. 2004).

Sertoli cells synthesize and secrete a large variety of factors: proteins, cytokines, growth factors, opioids, steroids, prostaglandins, modulators of cell division etc. The morphology of Sertoli cells is strictly related to their various physiological functions. Cytoplasm contains endoplasmic reticulum both of the smooth (**steroid synthesis**) and rough type (**protein synthesis**),

a prominent Golgi apparatus (**elaboration and transport of secretory products**), lysosomal granules (**phagocytosis**) as well as microtubuli and intermediate filaments (**adaptation of the cell shape** during the different phases of germ cell maturation). It is generally assumed that Sertoli cells coordinate the spermatogenic process topographically and functionally. On the other hand, more recent data support the contention that germ cells control Sertoli cell functions. At least the time pattern of germ cell transitions and development during the spermatogenic cycle seem to be autonomous as suggested from heterologous **germ cell transplantation** studies (Nagano et al. 2001). One spermatogenic cycle lasts about 8 days in mice and 12–13 days in rats. Notably, the cycle duration of rat germ cells transplanted into mouse testis remained 12–13 days whereas that of the host germ cells was maintained at 8 days (Franca et al. 1998).

Another important function of Sertoli cells is that they are responsible for final **testicular volume** and **sperm production** in the adult. Each individual Sertoli cell is in morphological and functional contact with a defined number of sperm. The number of sperm per Sertoli cell depends on the species. In men we observe about 10 germ cells or 1.5 spermatozoa per each Sertoli cell (Zhengwei et al. 1998a). In comparison, every macaque monkey Sertoli cell is associated with 22 germ cells and 2.7 sperm (Zhengwei et al. 1997, 1998b). This suggests that within a certain species a higher number of Sertoli cells results in a greater production of sperm and testis size, assuming that all the Sertoli cells are functioning normally. In contrast, as determined by flow cytometry, testicular cell numbers were very similar across several primate species, suggesting that testis size is the main determinant of total germ cell output (Luetjens et al. 2005).

Stereological investigations suggest that the number of Sertoli cells in men increases until the 15th year of life. In the prepubertal cynomolgus monkey and the rhesus monkey, Sertoli cells exhibit little mitotic activity, whereas some proliferative activity of A-type spermatogonia occurs in the quiescent testis. Sertoli cell proliferation is markedly activated when exposed to gonadotropin activity (Plant et al. 2005; Schlatt et al. 1995). Both Sertoli cell number and expression of markers of cell division are stimulated by these hormones. The division of Sertoli cells ends when the first germ cells undergo meiotic division and Sertoli cells have built tight junctions between each other, the

so-called blood-testis-barrier (see Sect. 2.5). Lack of **connexin-43**, a predominant gap-junction protein, prevents Sertoli cell maturation associated with continued division of Sertoli cells and spermatogenic arrest beyond spermatogonial development (Brehm et al. 2007; Sridharan et al. 2007). Expression of Sertoli cells markers such as **transferrin**, **androgen-binding protein** and junctional proteins such as **N-cadherin**, **connexin-43**, **gelsolin**, **laminin- γ 3**, **occludin**, **testin**, **nectin**, **zyxin** and **vinculin** is androgen-dependent (Zhang et al. 2006). It appears that several of these components are involved in establishing the blood-testis-barrier but also in the release of sperm and subsequent remodelling of the Sertoli cell-germ cell junctions (Yan et al. 2008). In the rat, the experimental prolongation of the division phase of Sertoli cells, produced for example by a deprivation of thyroid hormones, results in an increase of testicular weight and sperm production by about 80%. On the other hand, the decrease of Sertoli cell numbers such as that produced by an antimetabolic substance leads to a reduction of testicular volume and sperm production. Patients with Laron dwarfism suffer from a disturbance of thyroid function and growth hormone/IGF-I deficiency, and often have testicles larger than normal.

Through the production and secretion of tubular fluid Sertoli cells create and maintain the patency of the tubulus lumen. More than 90% of Sertoli cell fluid is secreted in the tubular lumen. Special structural elements of the blood-testis barrier prevent reabsorption of the secreted fluid, resulting in pressure that maintains the patency of the lumen. Sperm are transported in the tubular fluid, the composition of which is known in detail only in the rat (Setchell 1999). Unlike blood, the tubular fluid contains a higher concentration of potassium ions and a lower concentration of sodium ions. Other constituents are bicarbonate, magnesium and chloride ions, inositol, glucose, carnitine, glycerophosphorylcholine, amino acids and several proteins. Therefore, the germ cells are immersed in a fluid of **unique composition**.

The basolateral aspect of neighboring Sertoli cells comprises membrane specializations forming a band sealing the cells to each other and obliterating the intracellular space (occluding tight junctions). The physiological function of the blood-testis barrier has been proven in experiments showing that dyes or lanthanum applied outside the barrier could diffuse only up to the tight junctions without reaching the lumen of the seminiferous tubules. The closure of the blood-testis barrier coincides with the beginning of the first

meiosis in the germinal cells (preleptotene, zygotene) and with the arrest of proliferation of Sertoli cells. Through the blood-testis-barrier the seminiferous epithelium is divided into two regions which are anatomically and functionally completely different from each other. Early germ cells are located in the **basal region** and the later stages of maturing germ cells in the **adluminal region**. During their development germ cells are displaced from the basal to the adluminal compartment. This is accomplished by a synchronized dissolution and reassembly of the tight junctions above and below the migrating germ cells.

Two important functions are postulated for the blood-testis-barrier: the physical isolation of haploid and thereby antigenic germ cells to prevent recognition by the immune system (prevention of autoimmune orchitis, see Sect. 2.5) and the preparation of a special milieu for the meiotic process and sperm development. In certain seasonal breeders the opening and closure of the barrier depends much more on the activity of the Sertoli cells than on the developmental phase of the germinal epithelium. The constitution of the blood-testis-barrier and its selectivity in excluding certain molecules means that the cells localized in the adluminal compartment have no direct access to metabolites deriving from the periphery or from the interstitium. Therefore, these cells are completely dependent on Sertoli cells for their maintenance. This “nourishing function” could be exercised through different mechanisms: selective transport and transcytosis as well as synthesis and vectorial secretion.

2.1.2.3 Germinal Cells

Spermatogenesis starts with the division of stem cells and ends with the formation of mature sperm (Figs. 2.3 and 2.4). The various germ cells are arranged in typical cellular associations within the seminiferous tubules known as spermatogenic stages (Fig. 2.5) and the entire spermatogenic process can be divided into four phases:

1. **Mitotic** proliferation and differentiation of diploid germ cells (spermatogonia) (**spermatogoniogenesis**)
2. **Meiotic** division of tetraploid germ cells (spermatocytes) resulting in haploid germ cells (spermatids)
3. Transformation of spermatids into testicular sperm (**spermiogenesis**)
4. Release of sperm from the germinal epithelium into the tubular lumen (**spermiation**).

Fig. 2.3 Schematic representation of all germ cell types that occur in the human seminiferous epithelium. Ap spermatogonia enter the spermatogenic process (arrow on the cell indicates direction of germ cell development). Ad spermatogonia are believed to constitute the testicular stem cells. Ad = A-dark spermatogonium, Ap = A-pale spermatogonium, B = B spermatogonium, Pl = preleptotene spermatocytes, L = leptotene spermatocytes, EP = early pachytene spermatocytes, MP = mid pachytene spermatocytes, LP = late pachytene spermatocytes, II = 2nd meiotic division, RB = residual body, Sa1 – Sd2 = developmental stages of spermatid maturation

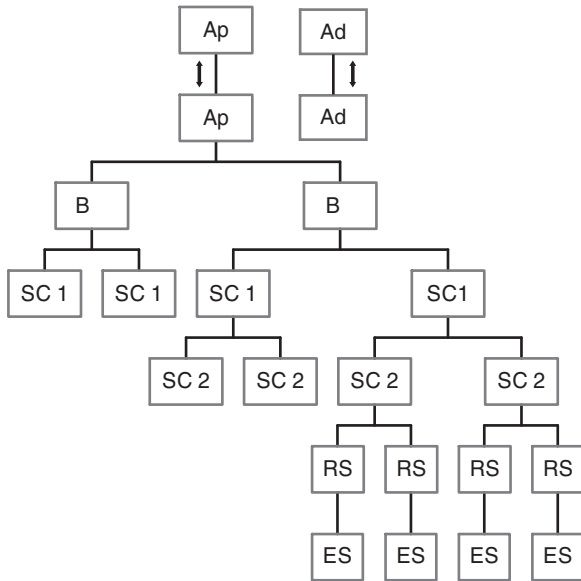
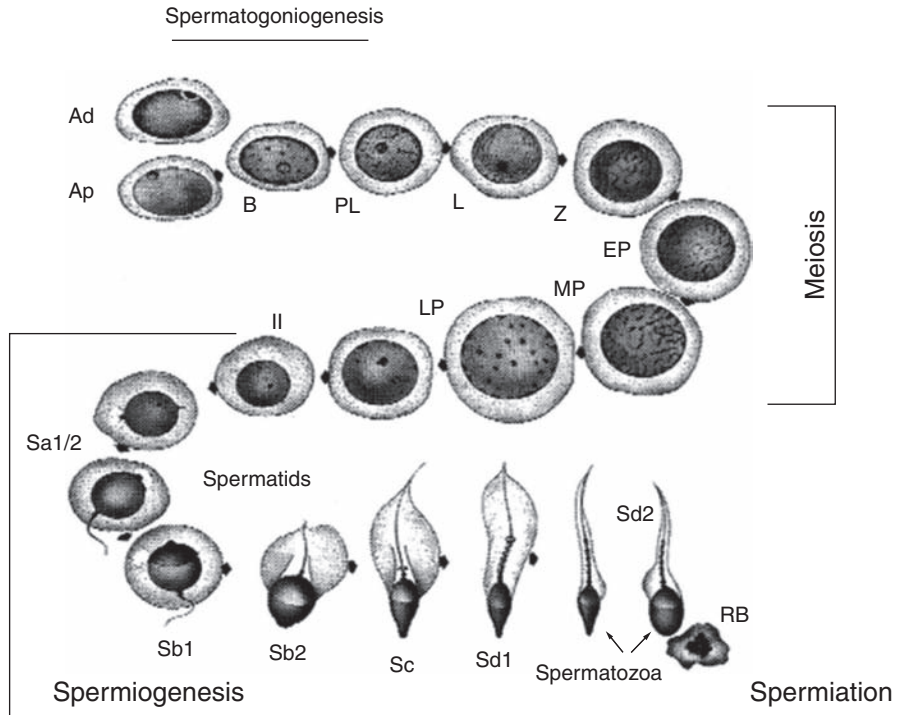
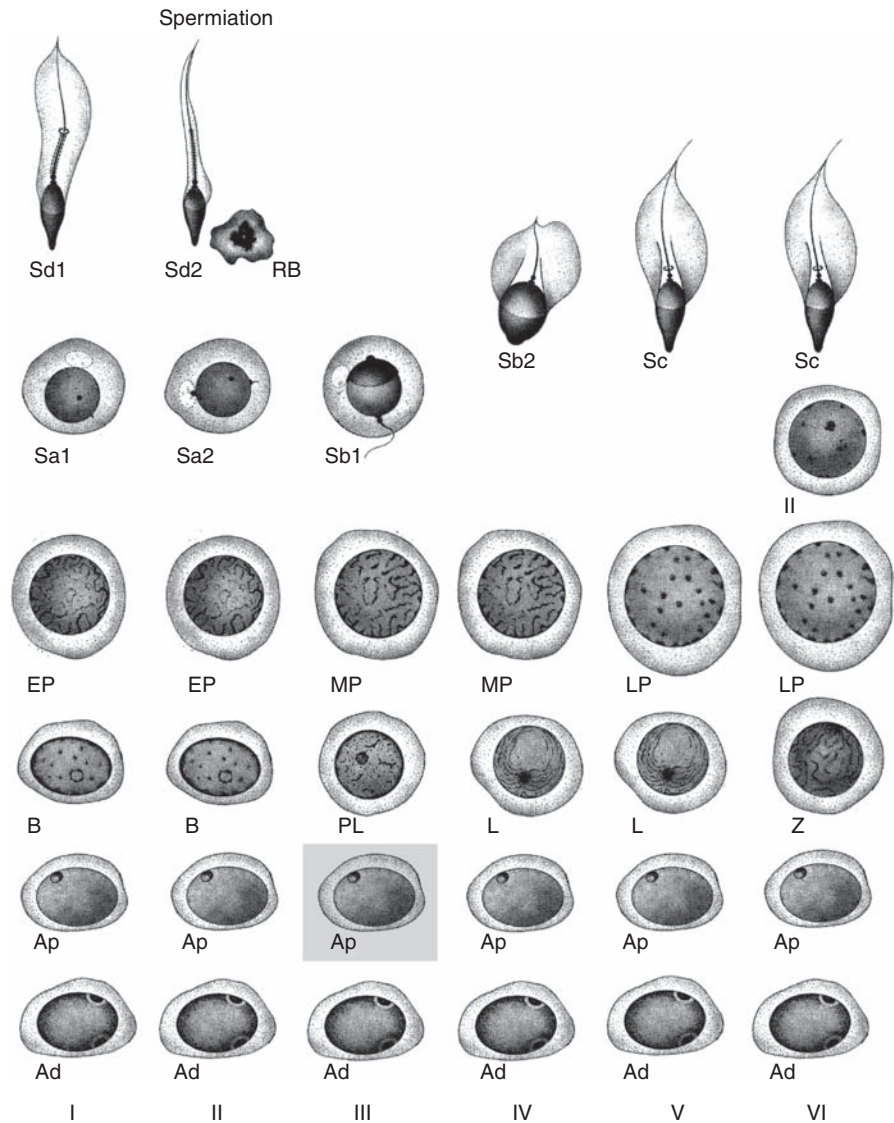

Fig. 2.4 Schematic representation of the proliferative kinetics of human gametogenesis. For the sake of clarity, complete development of only one spermatogonium is shown. The human testis contains about 1 billion sperm and releases around 25,000 sperm every minute (Amann 2008). One Ap spermatogonium can be the progenitor for 16 elongated spermatids. Since the human seminiferous epithelium contains only one generation of B-type spermatogonia, the final germ cell number produced is lower than in species with multiple spermatogonial divisions. Ad = A-dark spermatogonium (testicular stem cells, divides rarely), Ap = A-pale spermatogonium (self-renewing and progenitor cell for spermatogenesis), B = B spermatogonium, SC1 = primary spermatocyte, SC2 = secondary spermatocyte, RS = round spermatid, ES = elongated spermatid

Spermatogonia lie at the base of the seminiferous epithelium and are classified as type A and type B spermatogonia. Two types of A spermatogonia can be distinguished, originally from a cytological and now also from a physiological point of view: the Ad (dark) spermatogonia and the Ap (pale) spermatogonia. The Ad spermatogonia do not show proliferating activity under normal circumstances and are believed to divide only rarely (Ehmcke and Schlatt 2006). These spermatogonia are considered to represent **testicular stem cells** (Ehmcke et al. 2006). These germ cells, however, undergo mitosis when the overall spermatogonial population is drastically reduced, for example due to radiation (de Rooij 1998). In contrast, the Ap spermatogonia divide, renew themselves and differentiate into two B spermatogonia. Detailed studies in non-human primates led to a revised model for spermatogonial expansion in men (Ehmcke and Schlatt 2006): only Ap spermatogonia divide and give rise to Ap spermatogonia (to replenish this cell pool) as well as to B-type spermatogonia for further development. In contrast to the earlier model of Clermont, Ad spermatogonia are not the source of Ap spermatogonia during regular spermatogenic cycles. From B spermatogonia the preleptotene spermatocytes are derived directly before the beginning of the meiotic division. The latter germ cells commence DNA synthesis. Mother and daughter cells remain in close contact with each other through intercellular bridges (Alastalo et al. 1998). This “clonal”

Fig. 2.5 Representation of the specific stages of spermatogenesis of the human testis using the six-stage system. A tubular cross-section contains typical germ cell associations that are denoted as stages of spermatogenesis. The six stages (I–VI) in the human last altogether 16 days. Since a spermatogonium has to pass through minimally four cell layers, the complete duration of spermatogenesis in men is at least 64 days. The complete duration of the human spermatogenic process is still not entirely clear (Amann 2008). Ad = A-dark spermatogonium (testicular stem cells, divides rarely), Ap = A-pale spermatogonium (self-renewing and progenitor cell for spermatogenesis), B = B spermatogonium, Pl = preleptotene spermatocytes, L = leptotene spermatocytes, EP = early pachytene spermatocytes, MP = mid pachytene spermatocytes, LP = late pachytene spermatocytes, II = 2nd meiotic division, RB = residual body, Sa1–Sd2 = developmental stages of spermatid maturation



mode of germ cell development – also confirmed for primates (Ehmcke et al. 2005) – is possibly the basis and at the same time probably the prerequisite for the coordinated maturation of gametes in the seminiferous epithelium.

Tetraploid germ cells are known as **spermatocytes** and go through the different phases of the meiotic division. The pachytene phase is characterized by intensive RNA synthesis. **Haploid germ cells**, the spermatids, result from the meiotic division. The meiotic process is a critical event in gametogenesis, during which recombination of genetic material, reduction of chromosome number and development of spermatids have to be

accomplished. Secondary spermatocytes are derived from the first meiotic division. These germ cells contain a haploid chromosomal set in duplicate form. During the second meiotic division spermatocytes are divided into the haploid spermatids. The prophase of the first meiosis lasts 1–3 weeks, whereas the other phases of the first meiosis and the entire second meiosis are concluded within 1–2 days.

Spermatids are derived from the second meiotic division and are round mitotically inactive cells which undergo a remarkable and complicated transformation leading to the final production of differentiated elongated spermatids and sperm. These processes include

condensation and structural shaping of the cell nucleus, the formation of a **flagellum** and the expulsion of a large part of cytoplasm. The overall process is called **spermiogenesis** and, from a qualitative point of view, is identical in all species. It is useful to divide spermiogenesis into four phases: Golgi, cap, acrosomal and maturation phases.

During the **Golgi phase** acrosomal bubbles and cranio-caudal symmetry appear. In the **cap phase** the spermatids become elongated and the acrosome develops, covering the cranial half to two-thirds of the spermatid. During the fertilization process enzymes are released by the acrosome, allowing the sperm to penetrate the egg (see Chap. 3).

In the **acrosomal phase** the cell nucleus becomes further condensed and elongation of the cell continues. During condensation the majority of histones are lost and gene transcription stops. Nuclear chromatin is now extremely condensed, implying that the proteins necessary for spermiogenesis have to be transcribed before this timepoint and justifying the finding of RNA species with very long half-life and RNA binding proteins. This is the case for transition proteins and protamines. The mRNA translational control mechanisms are just being unravelled and RNA-binding proteins seem to play an important role. The **flagellum** is now mature.

The principal event during the maturation phase of the spermatids is the extrusion of the rest of the cytoplasm as the so-called **residual body**. Residual bodies are phagocytosed by Sertoli cells and have a regulatory role. Elongated spermatids and their residual bodies influence the secretory function of Sertoli cells (production of tubular fluid, inhibin, androgen-binding protein and interleukin-1 and 6). In parallel with degradation of the residual bodies, a new spermatogenic cycle begins.

The release of sperm into the tubular lumen is designated as **spermiation**. This event is influenced by plasminogen activators and possibly also by thimet oligopeptidases. This process can be particularly affected by hormonal modifications, temperature and toxins. The reasons for this sensitivity are, however, not yet known. Sperm that are not released are phagocytosed by Sertoli cells. Round and elongated spermatids already contain all the information necessary for fertilization; since introduction of intracytoplasmic injection of testicular sperm and even round spermatids it has become possible to induce pregnancies successfully (see Chap. 3 for details).

2.1.2.4 Kinetics of Spermatogenesis

The complex process of division and differentiation of germ cells follows a precise pattern. All germ cells pass through several stages characterized by particular cellular associations. Recognizing that acrosome development is stage-dependent was crucial for the understanding of germ cell maturation. The number of stages of spermatogenesis depends on morphological criteria. For the rat 14 stages (I–XIV) are used and 12 stages (I–XII) in macaques. For men, originally 12 spermatid maturation steps were described but a six-stage (I–VI) approach is currently used. More recently, the six-stage system has also been applied to Old World and New World primate species (Wistuba et al. 2003). The succession of all stages along time is called the spermatogenic cycle.

The duration of the spermatogenic cycle depends on the animal species and lasts between 8–17 days in mammals. **One human spermatogenic cycle requires 16 days.**

For the development and differentiation of an Ap spermatogonium into a mature sperm at least four spermatogenic cycles are necessary. It can be deduced that the **overall duration of spermatogenesis** is calculated as around 50 days in the rat, 37–43 days in different monkey species and at least 64 days in man. It must be pointed out, however, that a recent review recommends 74 days by including time for spermatogonial renewal (Amann 2008). Investigations carried out in the 1960s led to the conclusion that the duration of spermatogenesis is genetically determined, does not vary throughout life and cannot be influenced experimentally. However, many indirect experimental findings oppose this hypothesis. For example, the first spermatogenic cycle during puberty proceeds faster than in the adult age. It has also been demonstrated in the rat that the duration of germ cell maturation can actually be manipulated by exogenous factors. In contrast, endocrine factors do not alter the duration of spermatogenic cycles (Aslam et al. 1999).

The spermatogenic stages appear well orchestrated, not only in **time** but also in **space**. In the rat, serial transversal sections through the seminiferous tubules show that stage I is always followed by stage II, stage III always by stage IV and so on. This is known as the **spermatogenic wave**. In contrast, in the

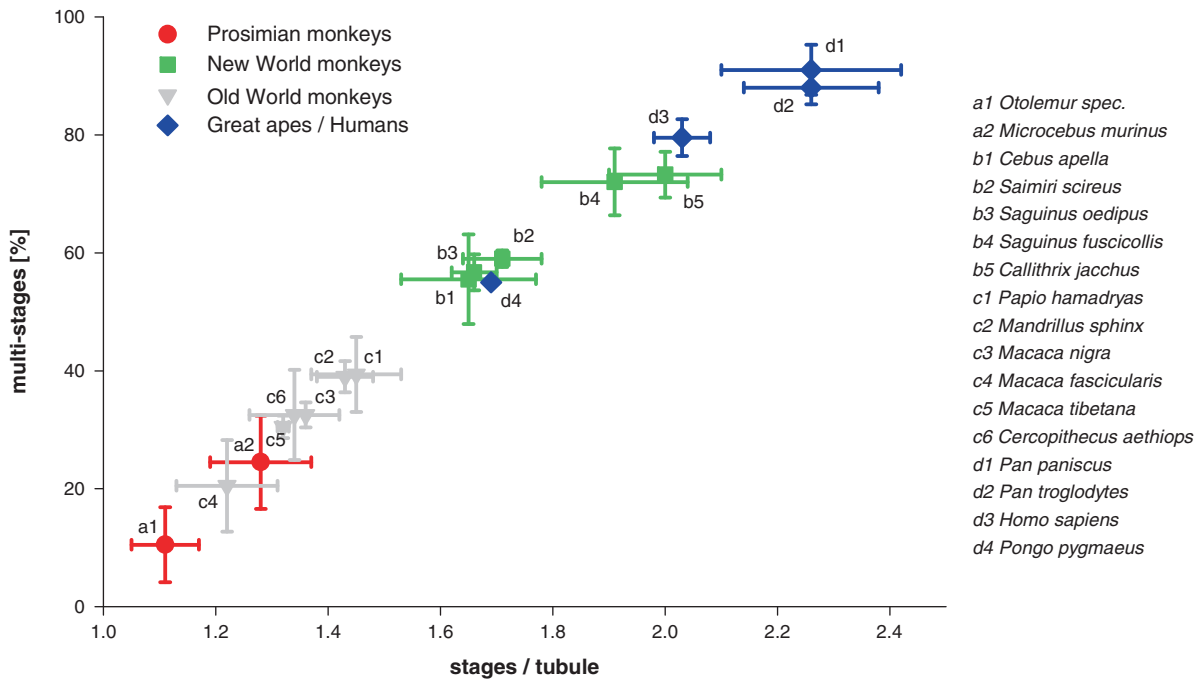

Fig. 2.6 Frequency (%) of seminiferous tubules containing more than one spermatogenic stage versus the number of stages per tubular cross-section across the primate order. a1–a2: prosimians, b1–b5: New World monkeys, c1–c6: Old World monkeys, d1, d2 and d4: great apes, d3: men. Note the clustering of

multi-stage distribution and the increased number of stages in New World monkeys, great apes and humans. The incidence of multi-stage versus single-stage tubules was not related to germ cell production (Luetjens et al. 2005; Fig. 2.7)

entire human testis and in parts or whole testis of various monkey species, tubular sections show different stages simultaneously (Fig. 2.6). While this was initially considered to be an irregular arrangement, quantitative analysis of the germ cell population suggested a helical topography of spermatogenic stages with several helices being spaced apart with spermatogonia at their basis and elongated spermatids at their apical part (Schulze and Rehder 1984; Zannini et al. 1999). Other investigations of human spermatogenesis confirmed the principle of **helical patterns** but not the presence of a complete spermatogenic wave, i.e., the complete succession of all stages (Johnson et al. 1996). At the most, 2–4 consecutive stages could be found on serial sections. Since the topographical distribution of the stages could be reproduced by assigning random numbers, the arrangement of the human spermatogenic stages along the seminiferous tubule might be at random. On the other hand, germ cell transplantation revealed that one spermatogenic stage represents a single clone of germ cells (Nagano et al. 2001). Therefore, variation in clonal size could lead to the

appearance of several stages per cross-section (Wistuba et al. 2003 for further discussion) and that species differences with regard to number of spermatogenic stages are related – at least in part – to clonal size. A comparative and quantitative analysis of the incidence of tubules with one or more spermatogenic stages in 17 primate species yielded that in men, great apes and New World monkeys, multi-stage tubules are more common, whereas in prosimians and Old World monkeys single-stage tubules predominate (Luetjens et al. 2005; Fig. 2.6).

Human germ cell production results in comparatively low sperm numbers per Sertoli cell (see Sect. 2.1.2.2). When expressed in millions of sperm per g/testis in 24 h, the rat has values of 10–24, non-human primates values of 4–5 and men values of 3–7. Since earlier work also suggested that about 50% of germ cells are lost during the meiotic divisions human spermatogenesis has been considered inefficient. However, studies using contemporary stereological approaches failed to detect meiotic germ cell losses in primates including men (Zhengwei et al. 1997, 1998a, b). More

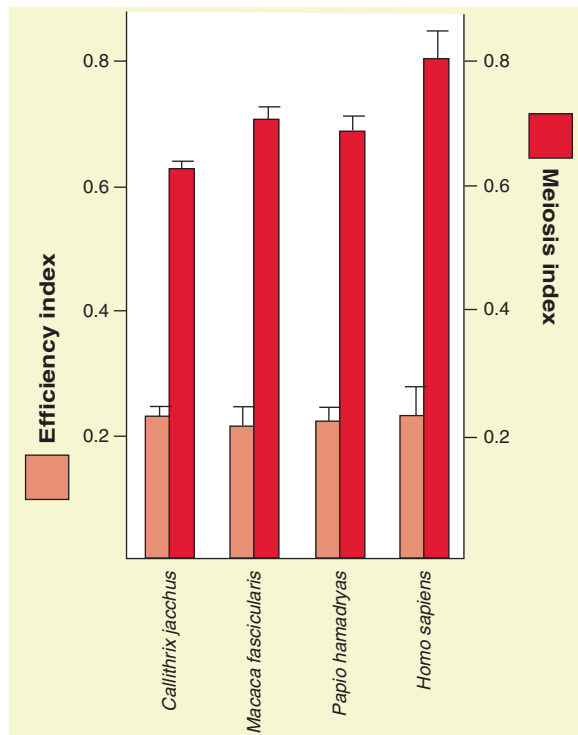

Fig. 2.7 Spermatogenic efficiency index (mean \pm SEM) and meiosis indices for New World monkeys (*Callithrix jacchus* = marmoset, $n = 4$), Old World monkeys (*Macaca fascicularis* = cynomolgus monkey, $n = 5$; *Papio hamadryas* = *Hamadryas* baboon, $n = 6$) and man (*Homo sapiens*, $n = 9$) based upon flow cytometric analyses of testicular tissue. The efficiency index is defined as the number of elongated cells divided by total cell number. The meiosis index is defined as the number of haploid cells divided by total cell number. Note that efficiency and meiosis indices are comparable between human and other primates (Based on Wistuba et al. 2003 and Luetjens et al. 2005)

recent work using flow cytometric quantitation of testicular cell numbers including meiotic cells and spermatids showed that human germ cell yields are comparable to other primates (Luetjens et al. 2005; Fig. 2.7). Hence it is obvious that human spermatogenesis is more efficient than assumed earlier. Differences in germ cell number per cell or tissue unit are rather related to the number of spermatogonial divisions (Ehmcke et al. 2005) with men considered to have only a single generation of B-type spermatogonia (Fig. 2.4), whereas macaques can have four such generations.

Primate sperm production is controlled through the number of spermatogonia entering meiosis.

2.1.2.5 Apoptosis and Spermatogenesis

Programmed cell death (**apoptosis**) comprises a coordinated sequence of signalling cascades leading to cell suicide. Unlike necrosis, this form of cell death occurs under physiological conditions (spontaneous apoptosis) but can also be induced by exposure to toxicants, disturbances of the endocrine milieu, etc. In the human testis spermatogonia, spermatocytes and spermatids undergoing apoptosis have been detected and ethnic differences in the incidence of testicular apoptosis have been suggested. Blockade of apoptotic events in the mouse model leads to accumulation of spermatogonia and infertility underpinning the need for germ cell death via apoptosis as a physiological process. Endocrine imbalance or heat treatment induced testicular apoptosis via the intrinsic and extrinsic pathways in non-human primates (Jia et al. 2007). In a non-human primate model, differentiation of Ap spermatogonia into B-type spermatogonia was found to be gonadotropin-dependent (Marshall et al. 2005). Recent human data suggest that gonadotropins may act as cell survival factors for spermatogonia rather than as stimulators of cell proliferation (Ruwanpura et al. 2008).

2.2 Hormonal Control of Testicular Function

The endocrine regulation of testicular function, i.e., the production of sperm and of androgens is well investigated. Understanding the hormonal interactions has important clinical consequences, presented in the following paragraphs. Figure 2.8 offers an overview of the systems involved, of the endocrine factors and of their physiological effects.

2.2.1 Functional Organization of the Hypothalamo-Pituitary System

The **gonadotropins luteinizing hormone (LH)** and **follicle-stimulating hormone (FSH)** are produced and secreted by the gonadotropic cells of the **anterior pituitary**. Their designation is derived from the function

exerted in females. In males, they control steroidogenesis and gametogenesis in the testis. Pituitary gonadotropes are the central structure controlling gonadal function and in turn, are regulated by the hypothalamic gonadotropin-releasing hormone (GnRH). Since GnRH secretion is pulsatile, gonadotropin release also occurs in discrete peaks, more evident in the case of LH, due to its shorter half-life in circulation compared to FSH. In turn, GnRH secretion depends on the activation of the GPR54 receptor, located on the surface of the GnRH neurons and stimulated by the peptide kisspeptin. The pituitary function is also under the control of gonadal steroids and peptides that influence its activity both directly and through the hypothalamus (Fig. 2.8). Due to their very strict anatomical and functional connection, hypothalamus and pituitary gland have to be considered as an unique functional unit.

The hypothalamus is the rostral extension of the brain stem reticular formation. It contains, among others, the cellular bodies of neurons that project their axon terminals toward the **median eminence** (ME), a specialized region of the floor of the third ventricle from which the pituitary stalk originates. The **hypothalamus** is classically subdivided into three longitudinal zones, periventricular, medial and lateral, the latter functioning as the connecting area between limbic and brain stem regions, whereas the former two contain most of the nuclei controlling neuroendocrine and visceral functions. The ME is the ventral bulge of the hypothalamus and is the site where the axon terminals of the neurosecretory neurons make contact with the capillary plexus, giving rise to the hypophyseal portal circulation. The nerve terminals form buttons on the capillaries and release the neurohormones into the portal blood by diffusion through the basal membrane. The ME is outside the blood-brain barrier and thereby freely accessible to the regulatory influences of hormones and substances present in the systemic circulation and mediating the release of neurohormones in portal blood. The blood supply of the ME is provided by the superior hypophyseal arteries. The long portal hypophyseal vessels originate from the confluence of capillary loops which supply the anterior pituitary gland with the highest blood flow of any organ in the body. In humans, the perikarya of neurons stained positive for GnRH are especially found in the ventral part of the mediobasal hypothalamus, between the third ventricle and the ME, scattered throughout the periventricular infundibular region.

The **pituitary** gland lies in the sella turcica, beneath hypothalamus and optic chiasm, covered with the sellar diaphragm. Thus, pituitary tumors can result in visual impairment by exerting pressure on the optical nerves. Gonadotropic cells are localized in the adenohypophysis, the most ventral part of the gland, of ectodermic origin from Rathke's pouch. The adenohypophysis consists of the anterior lobe (or pars distalis, the anatomically and functionally most important part), the pars intermedia and pars tuberalis.

The pars distalis is of pivotal importance for pituitary function. Gonadotropin-producing cells constitute approximately 15% of the adenohypophyseal cell population, are scattered in the posteromedial portion of the pars distalis and are basophilic and PAS-positive. Although the secretion of LH and FSH can be partially dissociated under certain circumstances, the same cell type is believed to secrete both gonadotropins. About 80% of the gonadotropic cells in men contain both LH and FSH. The cells have a very well developed RER, a large Golgi complex and are rich in secretory granules. In normal men, the pituitary contains approximately 700 IU of LH and 200 IU of FSH. Following gonadectomy or in primary hypogonadism the cells become vacuolated and large (castration cells). Finally, pituitary gonadotropes are often found in close connection with prolactin cells, suggesting a paracrine interaction between the two cell types.

2.2.2 The Kisspeptin-GPR54 System

GnRH secretion is under the control of the kisspeptin-GPR54 system. Kisspeptin is the product of the *KISS1* gene, located on chromosome 1q32.1. The name of the *KISS1* gene derives from the chocolate "kisses" of Hershey, Pennsylvania, the city in which the gene was identified. *KISS1* was originally described as a human tumor suppressor gene for its ability to inhibit the growth of melanoma and breast cancer metastasis. Later on it was shown that kisspeptin (also known as metastin) is the natural ligand of the orphan receptor GPR54 and has an important role in initiating GnRH secretion at puberty.

The product of the *KISS1* gene is a 145-amino-acid peptide, which is cleaved into a 54-amino-acid peptide known as kisspeptin-54. Shorter peptides (kisspeptin 10, -13, and -14), sharing a common C-terminal,

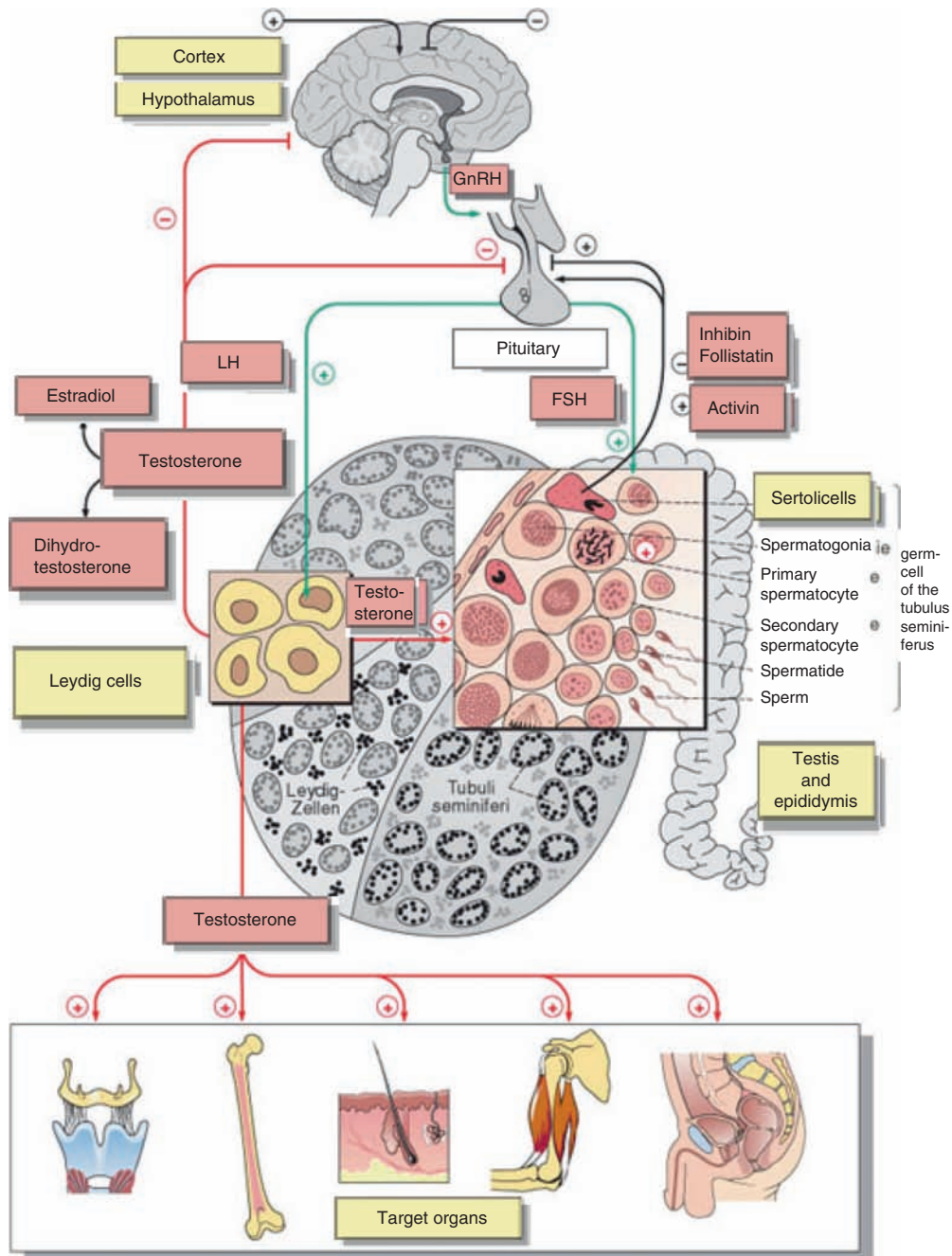

Fig. 2.8 Hormonal regulation of the testicular function and effects of androgens. Key hormones are luteinizing hormone (LH) and follicle-stimulating hormone (FSH), synthesized and secreted under hypothalamic control of gonadotropin-releasing hormone (GnRH). Leydig cells are located between the seminiferous tubules and synthesize and secrete testosterone under the control of LH. Testosterone stimulates the maturation of germ cells in seminiferous tubules. FSH acts directly on the seminiferous tubules. In the germinal epithelium only Sertoli cells possess receptors for testosterone and FSH. It is therefore believed that

the trophic effects of testosterone/FSH on gametogenesis are mediated via somatic Sertoli cells. The testis and the hypothalamo-pituitary system communicate through steroids and protein hormones. Testosterone inhibits the secretion of GnRH and gonadotropins. Inhibin B and follistatin suppress selectively the release of FSH from the pituitary gland, while activin stimulates this process. Beside the effects on gametogenesis, testosterone plays an important role in hair growth, bone metabolism, muscle mass and distribution, secondary sexual characteristics and function of the male reproductive organs. (Nieschlag et al. 2008)

RF-amidated motif with kisspeptin-54, are probably degradation products (Popa et al. 2008). Kisspeptin-expressing neurons are located in the anteroventral periventricular nucleus (AVPV), in the periventricular nucleus, in the anterodorsal preoptic nucleus and in the arcuate nucleus (ARC). Outside the nervous system, the *KISS1* gene is expressed in placenta, testis, pancreas, liver and intestine.

When injected icv or iv to rodents and primates, kisspeptin stimulates LH secretion, an effect mediated by the interaction with its receptor, GPR54, located on the surface of the GnRH-secreting neurons. This receptor was first identified as an orphan G protein coupled receptor in the rat in 1999. The *GPR54* gene is located on chromosome 19p13.3. In 2003 it was discovered that loss-of-function mutations of *GPR54* in the human cause failure to progress through puberty and hypogonadotropic hypogonadism (De Roux et al. 2003; Seminara et al. 2003). Therefore, the kisspeptin-GPR54 system is essential to initiate gonadotropin secretion at puberty and to maintain normal androgenization in adulthood. In fact, kisspeptin neurons located in ARC and AVPV send projections to the medial preoptica area, a region rich in GnRH cell bodies, providing the anatomical evidence of a direct relationship between kisspeptin fibers and GnRH neurons which, in turn, express *GPR54*. The indispensable role of the kisspeptin-GPR54 system for gonadotropin secretion is proven also by the hypogonadotropic hypogonadal phenotype of mice bearing targeted null mutations of the *kiss1* or *gpr54* gene (Seminara et al. 2003; d'Anglemont de Tassigny et al. 2007).

GPR54 signals through a Gq-type of G protein. Experimentally, kisspeptin stimulates phosphatidylinositol (PI) turnover, calcium mobilization and arachidonic acid release in GPR54 – expressing cells and induces phosphorylation of mitogen-activated protein (MAP) kinases. Continuous infusion of kisspeptin results in rapid increase in LH secretion after 2 h, followed by a decrease to the basal levels by 12 h of infusion due to desensitization of GPR54, since GnRH is still able to elicit LH secretion under these conditions. This suggests that endogenous, pulsatile kisspeptin release is physiologically responsible for pulsatile GnRH and LH secretion.

Kisspeptin is sensitive to steroid levels within the circulation and is the mediator of the negative and positive (in the female) feedback regulation of gonadotropin secretion. In fact, although androgens, estrogens and

progesterone suppress gonadotropin secretion through androgen receptor (AR)-, estrogen receptor (ER) α -, and progesterone receptor (PR)-dependent mechanisms, respectively, none of these sex steroids affect GnRH secretion by direct action on GnRH neurons. On the contrary, kisspeptin neurons in the ARC are direct targets of sex steroids in all species and should be viewed as the site of the negative feedback control of GnRH production. In addition, kisspeptin produced by the AVPV, a sexually dimorphic nucleus rich in steroid-sensitive neurons in the female, mediates the positive feedback effects of estrogen on GnRH secretion (Popa et al. 2008). Finally, kisspeptin neurones seem to be involved in the regulation of the reproductive axis by metabolic signals sensing the energy balance of the organism, e.g., leptin. Reproductive hormones are inhibited during starvation and kisspeptin mediates some of leptin's effects on reproduction. According to the current model, leptin and perhaps other adiposity and satiety factors stimulate *KISS1* expression, which results in stimulation of GnRH release. When levels of adiposity and satiety factors decrease or when such factors are not detected, the expression of *KISS1* (and presumably its secretion) decreases, thus reducing excitatory input to GnRH neurons. Among the other metabolic factors influencing gonadal function, the growth hormone secretagogue ghrelin should be considered as a possible modulator of kisspeptin neurones (Tena-Sempere 2008). The regulation of GnRH and gonadotropin secretion by kisspeptin is shown in [Fig. 2.9](#).

2.2.3 GnRH

2.2.3.1 Structure of GnRH

Two forms of GnRH, termed GnRH-I (or GnRH) and GnRH-II, encoded by separate genes have been identified. The two forms are structurally very similar but show a significantly different tissue distribution and regulation of gene expression (Cheng and Leung 2005). GnRH-I, the peptide involved in gonadotropin regulation, is a decapeptide produced in the GnRH neurons of the hypothalamus. Unique among neurons producing hypothalamic neurohormones, they originate from olfactory neurones and during embryonic development migrate toward the basal forebrain along branches of the terminal and vomeronasal nerves,

Fig. 2.9 Current model of regulation of gonadotropin secretion. Kisspeptin produced by the arcuate nucleus and in the anteroventral periventricular nucleus (AVPV) stimulates GnRH release by acting on the G protein-coupled receptor GPR54. GnRH release results in increased gonadotropin secretion from the pituitary gland, which stimulates LH and FSH production. Peripheral sex steroids (e.g., androgens, estrogens and progesterone) as well as metabolic signals (e.g., leptin) regulate Kiss1 expression and signaling to GnRH neurons

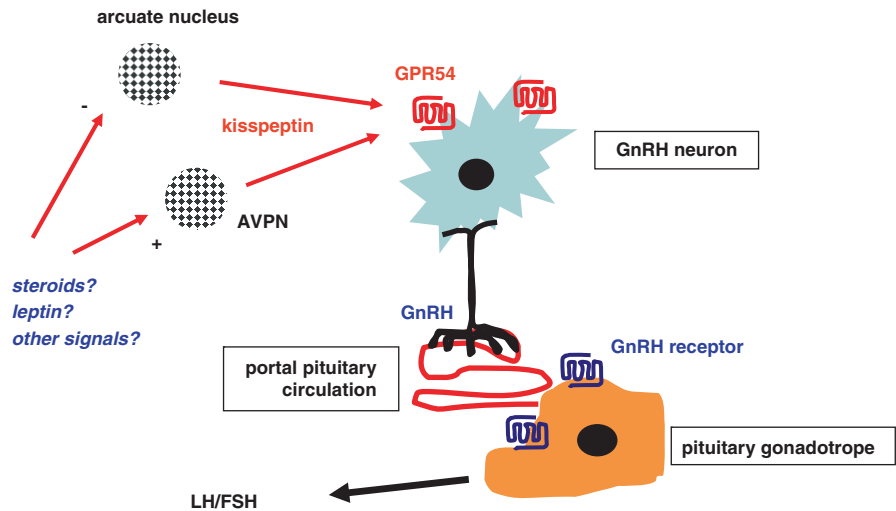

across the nasal septum. This event is regulated by a number of factors that influence the migration of different portions of the GnRH neuronal population at different steps along the route and the formation of the olfactory bulb (Tobet and Schwarting 2006). The importance of such factors is demonstrated by mutations in the respective coding gene in patients with Kallmann syndrome. In about 10% of patients with Kallmann syndrome and anosmia due to a hypoplasia of the bulbus olfactorius, mutations or deletions of the *KAL1* gene on the X chromosome were detected. This gene was the first implicated in Kallmann syndrome and encodes for anosmin-1 which is produced in the bulbus and in other tissues, and which is transiently expressed as an extracellular matrix and basal membrane protein during organogenesis and interacts with heparan sulphate. Other genes implicated in GnRH neuron migration and Kallmann syndrome are those encoding the fibroblast growth factor receptor 1 (*FGFR1*) and its ligand fibroblast growth factor 8 (*FGF8*), as well as prokineticin 2 (*PK2*) and its receptor (*PKR2*) (Falardeau et al. 2008; Kim et al. 2008).

In primates, the main locations of GnRH neurons are the medio-basal hypothalamus and the arcuate nucleus, but they are found also in the anterior hypothalamus, preoptic area, septum and other parts of the forebrain. GnRH neurons are synaptically connected with terminals stained positive for pro-opiomelanocortin-related peptides and enzymes involved in the metabolism of catecholamines and γ -aminobutyric acid (GABA). Furthermore, GnRH-positive neurons of the nucleus arcuatus are connected to neuropeptide Y (NPY)

neurons in the preoptical area and in the eminentia mediana. All these substances are known to influence GnRH secretion (Evans 1999; Li et al. 1999).

The gene encoding GnRH is localized at the chromosomal site 8p21-p11.2. GnRH is produced by successive cleavage stages from a longer precursor, called preproGnRH, transported along the axons to the ME and there released into portal blood. Phylogenetically GnRH is a rather ancient hormone, highly conserved among different species with 80% sequence identity between mammals and fish. In the precursor with a length of 92 amino acids, GnRH is preceded by a signal peptide consisting of 24 amino acids, and followed by a stretch of 56 amino acids forming the GnRH-associated peptide (GAP). PreproGnRH is processed in the rough endoplasmic reticulum and in the Golgi complex, the first step being the removal of the signal peptide and the cyclization of the aminoterminal Gln residue to pyroGlu. At the junction between GnRH and GAP a Gly-Lys-Arg sequence provides a processing signal important for the cleavage of GAP and C-terminal amidation of the last Pro residue. Mature GnRH is therefore a single chain decapeptide cyclized at the N-terminus and amidated at the C-terminus and assumes a folded conformation as the result of a β -II type bend involving the central Tyr-Gly-Leu-Arg residues that brings the N- and C termini in close proximity (Millar et al. 2008).

GnRH has a very short half-life (<10 min) and is mostly retained and degraded in the pituitary gland immediately after secretion by several peptidase systems. Deciphering the GnRH sequence earned Andrew

Schally the 1977 Nobel prize, and enabled the development of analogs with agonistic or antagonistic properties. As the generation of synthetic analogs of GnRH has shown, the amino acids in position 6–10 are important for high affinity binding of the neuropeptide, whereas positions 1–3 are critical for biological activity and positions 5–6 and 9–10 are involved in enzymatic degradation. The discovery of the amino acid sequence of GnRH permitted the design of GnRH analogs exerting agonistic or antagonistic action relative to the endogenous GnRH.

2.2.3.2 Secretion of GnRH

GnRH is released into the portal blood in discrete pulses. Although this event cannot be directly demonstrated *in vivo*, all the experimental data accumulated up to now demonstrate that each LH peak is induced by a GnRH pulse. It is the frequency of GnRH pulses and the amplitude of its secretory episodes that determine the type of LH and FSH secretion from the pituitary gland (Fig. 2.10). GnRH is the sole releasing factor for both gonadotropins, but modulating its frequency results in preferential release of LH or FSH (Hayes and Crowley 1998).

The pulsatile nature of GnRH secretion is partly an intrinsic characteristic of the GnRH neurons, since isolated immortalized GnRH neurons have a sponta-

neous pulsatile secretory activity *in vitro*. However, *in vivo* GnRH is under the control of the kisspeptin/GPR54 system, which mediates the effects of the peripheral steroids on GnRH secretion and is involved in the control of GnRH pulsatility. The pulse generator is under the continuous tonic inhibition of peripheral steroids and, e.g., gonadectomy results in an immediate increase of frequency and amplitude of gonadotropin secretion. Thus, in the absence of steroids the pulse generator becomes free-running (Lopez et al. 1998).

In man, the major hormone controlling GnRH secretion is testosterone, which inhibits gonadotropin secretion via negative feedback both at the hypothalamic and pituitary level (Fig. 2.8). Testosterone can act as such or after metabolism to DHT or estradiol. The effects of testosterone and its metabolites appear to vary depending on the experimental model but, in general, we can assume that both T and DHT act mainly at the hypothalamic level by decreasing the frequency of GnRH pulsatility, whereas estrogens depress gonadotropin secretion by reducing the amplitude of LH and FSH peaks at the pituitary level (Hayes and Crowley 1998). Progesterone inhibits gonadotropin release at least in part via arcuate nucleus dopaminergic and NPY neurons (Dufourny et al. 2005). The negative feedback action of androgens and progestins is most important for the development of a male fertility control regimen (Chap. 29).

Fig. 2.10 Importance of the pulsatile pattern of GnRH secretion for gonadotropin secretion and testicular function. Unphysiologically high GnRH pulse frequencies or continuous administration of GnRH inhibit gonadotropin secretion and testicular function (red). Similarly, blockade of GnRH receptors by means of GnRH analogs results in suppression of testicular function

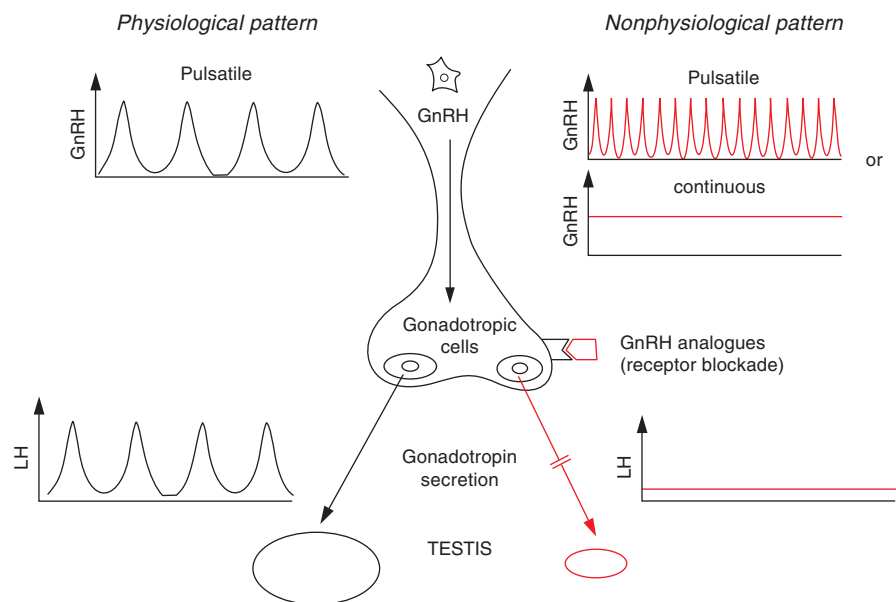

Among the neurotransmitters and neuromodulators that might influence GnRH secretion, the noradrenergic system and NPY show stimulatory activity, whereas interleukin-1, dopaminergic, serotonergic and GABAergic systems are inhibitory. Opioid peptides seem to modulate the negative feedback of gonadal steroids. Finally, leptin has been shown to stimulate gonadotropin secretion. Leptin is produced by the fat cells of the body and influences the interactions concerning the control of body mass and gonadotropin secretion. This effect is probably mediated by the hypothalamus via NPY-, POMC- and especially kisspeptin-containing neurons with numerous receptors for leptin (Popa et al. 2008).

2.2.3.3 Mechanism of GnRH Action

GnRH acts through interaction with a specific receptor. The GnRH receptor belongs to a family of G-coupled receptors linked by the typical seven-membrane domain structure. This group also encompasses the receptors for LH, FSH and TSH. With 328 amino acids, it is the smallest G protein-coupled receptor known up to now and possesses a rather short extracellular domain (Fig. 2.11). The intracellular C-terminus is practically absent and the signal transduction is probably carried out by the intracytoplasmic loops connecting the seven membrane spanning segments, especially the third one which is unusually long. The receptor contains two glycosylation sites, projecting into the extracellular space, of uncertain function.

The conformation of the binding site is unknown. The gene encoding the human GnRH receptor includes three exons separated by two introns. The 5' flanking region contains multiple TATA transcription initiation sites and several cis-acting regulatory sequences which confer responsiveness to cAMP, glucocorticoids, progesterone, thyroxin, PEA-3, AP-1, AP-2 and Pit-1-sensitive sequences. The GnRH receptor is specifically expressed in the gonadotropic cells within the pituitary. An orphan receptor, steroidogenic factor 1 (SF-1) is involved in the expression of human GnRH (Ngan et al. 1999). Transcription factors such as SF-1, Pit-1 and Pro-Pit-1 are generally needed for the development and maturation of the hypothalamo-hypophyseal-gonadal axis. SF-1-deficient mice and patients bearing a mutation in the Pro-Pit-1 gene exhibit

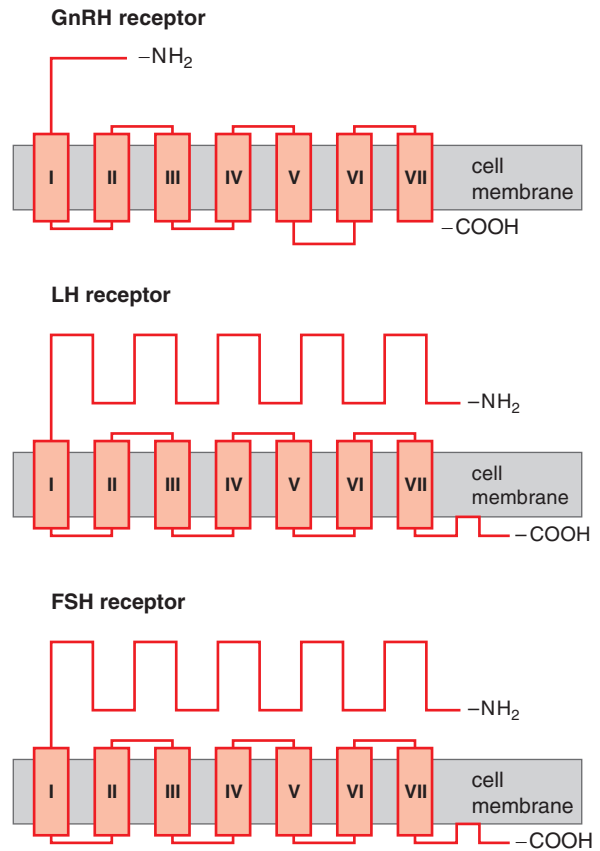

Fig. 2.11 Schematic representation of the receptors for GnRH (upper panel), LH (middle panel) and FSH (bottom panel). These receptors belong to the family of G protein-coupled receptors. They possess an extracellular domain, a transmembrane domain with seven membrane spanning segments and an intracellular domain. The GnRH receptor is characterized by a very short extracellular domain and practically no intracellular domain. On the contrary, the extracellular domain is very large in the gonadotropin receptors, where it plays a crucial role in hormone binding. The intracellular domain is important for signal transduction

pronounced alterations of gonadotropin secretion. Recently, a second GnRH receptor gene was identified in non-human primates (type II GnRH receptor) which is structurally and functionally distinct from the classical, type I receptor. The GnRH type II receptor, however, is not functional in the human and many other species and its role is yet unknown (Millar 2005). Both GnRH-I and GnRH-II were shown to signal through the GnRH type I receptor (ligand-selective-signaling). While GnRH-I regulates gonadotropins, GnRH-II appears to be a neuromodulator and stimulates sexual behavior.

Following GnRH-receptor interaction, a **hormone receptor complex** is formed. This results in the interaction with Gq protein, hydrolysis of phosphoinositide and production of diacylglycerol and inositol trisphosphate, which leads to calcium mobilization from the intracellular stores and influx of extracellular calcium into the cell. Diacylglycerol and calcium then activate protein kinase C (PKC), inducing protein phosphorylation and further activation of calcium channels. The increase in intracellular calcium results in prompt gonadotropin release by exocytosis and, with time, more sustained gonadotropin synthesis and secretion. Thereafter, the hormone-receptor complex is internalized by endocytosis and undergoes degradation in lysosomes.

GnRH is capable of **modulating number and activity** of its own **receptors** and the effects depend on the secretory pattern and dose of neurohormone. The receptor expression is higher when GnRH is given in a pulsatile manner and the withdrawal of GnRH during the interpulse intervals leads to increase of GnRH binding sites just before the next pulse occurs (self priming). Conversely, continuous exposure to GnRH results in an initial rise in response followed by desensitization. This property of the GnRH receptor is exploited in therapy with GnRH agonists that, owing to their prolonged and sustained stimulatory activity, cause slow receptor desensitization and decrease of gonadotropin secretion. The molecular mechanism of receptor desensitization is not completely understood. Owing to the lack of an intracellular domain, GnRH agonists cannot induce phosphorylation and rapid desensitization of the receptor.

2.2.4 Gonadotropins

2.2.4.1 Structure of Gonadotropins

LH and FSH are glycoprotein hormones secreted by the pituitary gland that control development, maturation and function of the gonad. Like the related thyroid stimulating hormone (TSH) and human chorionic gonadotropin (hCG), they consist of two polypeptide chains, α and β , bearing carbohydrate moieties N-linked to asparagine (Asn) residues. The α subunit is common to all members of the glycoprotein

hormone family, whereas the β subunit, although structurally very similar, differs in each hormone and confers specificity of action.

The subunits are encoded by separate genes localized on different chromosomes but structurally related. The gene encoding for the α subunit is composed of four exons and three introns, whereas the β genes consist of three exons separated by two introns. The FSH β gene is located on chromosome 11 and differs from the other glycoprotein hormone β subunit genes in possessing a rather long 3' untranslated region probably involved in RNA stability. The LH β gene belongs to an extraordinary complex cluster of genes also including at least seven nonallelic hCG β -like genes arranged in tandem on chromosome 19. The regulation of gene expression of LH and FSH has been extensively studied in experimental animals, especially rodents, and involves a complex interplay between hypothalamic GnRH and gonadal steroids and peptides acting at the hypothalamic and pituitary level (Burger et al. 2004).

The common α subunit contains two **glycosylation** sites, at position 52 and 78. The glycosylation sites of FSH β are 7 and 24, whereas LH is glycosylated only at position 30. In mammals the α subunit is also produced by the placenta and, conversely, the pituitary gland has been shown to contain and secrete trace amounts of hCG. α and β subunits are non-covalently linked and the probable tertiary structure of pituitary gonadotropins can be approximated and deduced by analogy with its cognate hCG, whose crystal structure has been resolved.

LH and hCG β subunits are structurally very similar and, in fact, LH and hCG act on the same receptor. A peculiar feature of hCG β is a carboxyl-terminal extension containing four O-linked sugar residues that remarkably reduces the rate of metabolism and increases the half-life of the hormone. This peculiarity of hCG β has been recently exploited for the production of a synthetic gonadotropin hybrid containing a similar C-terminal extension in the β subunit which resulted in a conspicuous increase of the gonadotropin half-life. A prolongation of the half-life of hCG was achieved by producing a chimera containing fused α and β chains (Boime and Ben-Menahem 1999), while a synthetic chimeric gonadotropin containing a β subunit derived from both hCG β and FSH β displays the biological properties of both gonadotropins (Garone et al. 2006).

The oligosaccharide structure consists of a central mannose core, bound to an Asn residue through two residues of N-acetyl-glucosamine, and terminal extensions of tetrasaccharide branches, bi- or triantennary, terminating with sialic acid (FSH) or sulfate (LH) residues. These carbohydrate structures can be more or less extended in length and are rich in sugar terminals, constituting the molecular basis of the gonadotropin heterogeneity evident after chromatographic separation.

Having a different terminal glycosylation, LH and FSH also have a different half-life. LH is rich in N-acetyl-glucosamine sulfate and is quickly removed from the circulation after interaction with specific liver receptors that recognize sulfate terminals. This rapid removal of sulfate LH from the blood results in rapid clearance of a relevant amount of the LH discharged in each secretory episode and “amplifies” the pulsatile features of LH in circulation. Conversely, FSH is predominantly sialylated and thereby protected from immediate capture and metabolism in the liver. As a result, LH and FSH half-lives are about 20 min and 2 h, respectively. Therefore, although both gonadotropins are secreted simultaneously from the pituitary gland following a GnRH pulse, LH appears to be highly pulsatile and FSH much less so (Moyle and Campbell 1995).

The importance of **sugar residues** on gonadotropin activity has been investigated in vitro using glycosylation-deficient hormones. It was found that glycosylation is not critical for receptor binding but is important for receptor activation

The use of recombinant variants of hCG and FSH defective in sialic acid or truncated at the mannose ramification revealed that glycosylation at position α 52 is necessary for the steroidogenic and cAMP response. Isoforms completely devoid of carbohydrates cannot be secreted by the producing cells and behave as competitive antagonists of the wild type. Overall, the current view is that glycosylation is fundamental for gonadotropin secretion and bioactivity, and strongly influences the half-life in circulation and in vivo biopotency.

It was found recently that two polymorphic variants of LH are present in the normal population. One of them has two amino acid exchanges in positions 8 and

15 of the β chain leading to a second glycosylation site in position 13. Approximately 12% of Europeans produce this allelic variant. Under in vitro conditions, this variant displays increased bioactivity and shortened half-life. A difference in immunoactivity can be detected when certain monoclonal antibodies are used (Huhtaniemi et al. 1999). Polymorphic variants of the FSH β gene exist as well and are associated with serum FSH levels in men (Grigorova et al. 2008). Such a variant was found to be associated with a significant reduction in free testosterone and testes volume, but on the contrary, in an increase of semen volume, sex hormone-binding globulin, serum testosterone and estradiol.

2.2.4.2 Secretion of Gonadotropins

After the synthetic process is completed, LH and FSH are stored in different secretion granules, ready to be released upon stimulation with GnRH. A portion of molecules, however, is not stored in secretory granules, i.e., does not enter the regulated pathway of secretion and is, instead, constitutively secreted. FSH especially follows the latter route. Storage in separate granules and the natural propensity to follow one of the two secretory pathways are the main reasons why the same GnRH stimulus can, under certain conditions, preferentially release one of the two gonadotropins. Low GnRH pulse frequency causes preferential release of FSH probably due to differential expression of the FSH receptor (Ferris and Shupnik 2006).

LH and FSH are measurable in the pituitary gland as early as the 10th week of gestation and during the 12th week in peripheral blood. In fetal life and in infancy FSH is predominant over LH and the FSH/LH ratio is higher in females than in males. The relative abundance of the two gonadotropins changes during development.

It is noteworthy that before birth both male and female fetuses grow in an environment extraordinarily rich in potent, maternal estrogens.

It is testosterone that determines the initial phase of testicular migration and the development of male external genitalia. Testosterone is already produced by the fetal testicle during the 10th week of gestation, under the stimulation of fetal LH and maternal hCG.

The role of maternal hCG in this crucial phase of gonadal development is suggested by the fact that a mutation of the LH β chain leading to a biologically inactive gonadotropin is associated with normal sexual differentiation (Huhtaniemi et al. 1999). Conversely, inactivating mutations of the LH receptor produce a clinical syndrome resembling complete androgen insensitivity, with a phenotype of female external genitalia (Themmen et al. 1998).

During infancy gonadotropins in serum are very low. The pulsatile secretion of gonadotropins becomes evident at the time of puberty, when LH and FSH pulses in serum are detected first during sleep, at night, and then progressively also during the day. Before puberty, gonadotropin levels are very low and GnRH secretion appears to be extremely limited, even in the presence of negligible steroid production by the gonads. High sensitivity of the hypothalamus to negative steroid feedback is believed to suppress GnRH production before puberty, but certainly other factors such as body mass, leptin and signals from the central nervous system are important to maintain the hypothalamo-pituitary-gonadal axis silent before the programmed time.

The steroid regulation of gonadotropin gene expression, synthesis and secretion is rather complex and shows many facets depending on the experimental model. In general, however, it is currently accepted that gonadal steroids exert their negative control on gonadotropins mainly at the hypothalamic level, depressing the release of GnRH most probably via the **kisspeptin/GPR54** system. The steroid effect at the pituitary level is more complex, but there is considerable evidence that estrogens inhibit GnRH-stimulated gonadotropin synthesis and secretion at this level. In rodents, testosterone has a specific stimulatory effect on FSH gene expression, synthesis and secretion directly at the pituitary level. In primates, however, the effects of testosterone are always inhibitory. Testosterone is the main testicular product suppressing FSH and LH secretion in men.

FSH secretion is, obviously, also under the control of some other factor(s) related to the efficiency of spermatogenesis, since oligozoospermia is often accompanied by selective increase of serum FSH in the presence of normal testosterone levels. New assays for **inhibin B** permitted analysis of the relationship between **FSH and inhibin secretion** in man. A pronounced inverse correlation was established between serum concentrations of inhibin B and serum levels of FSH, testis size and sperm numbers. Clearly, inhibin B is the physiologically

relevant form of inhibin in men (von Eckardstein et al. 1999). It appears at present that the serum levels of inhibin B directly reflect the integrity of the germinal epithelium and of the Sertoli cells (Boepple et al. 2008).

2.2.4.3 Mechanism of Action of Gonadotropins

LH and FSH exert their function via specific receptors (Simoni et al. 1997). The gonadotropin receptors also belong to the family of the G protein-coupled receptors and are characterized by a very large extracellular domain to which the hormone binds specifically, the usual membrane-spanning domain including 7 hydrophobic segments connected to each other through three extracellular and three intracellular tracts, and an intracellular carboxyterminal domain (Fig. 2.11).

The genes for LH and FSH receptors are localized on chromosome 2 and consist of 11 and 10 exons, respectively. The last exon encodes a small portion of the extracellular domain, the entire transmembrane domain and the intracellular C-terminus. The extracellular domain contains the high-affinity hormone binding site and is rich in leucine repeats. The 5'-flanking region of the two genes contains no conventional promoter and has multiple transcription start sites. In addition, the human LH receptor was recently shown to contain a cryptic exon (denominated exon 6A) which plays a very important role in the intracellular processing of the mature receptor protein and can be mutated in rare cases of LH resistance (Kossack et al. 2008). Several alternatively spliced transcripts of LH and FSH receptors have been described, lacking one or more exons, but presently it is not known whether these RNA **isoforms** are translated into proteins of any physiological function. Single nucleotide polymorphisms give rise to **allelic variants** with different biological activity in vitro and/or in vivo (Gromoll and Simoni 2005; Piersma et al. 2007).

The **mature receptor proteins** are glycosylated at several points, a process that does not seem to be involved in receptor activation and signal transduction but probably necessary for receptor folding and transport to the cell membrane. Recently, the partially deglycosylated complex of human FSH bound to the extracellular hormone-binding domain of its receptor was crystallized, showing that binding specificity is mediated by key interaction sites involving both the common alpha- and hormone-specific beta-subunits.

On binding, FSH undergoes a concerted conformational change that affects protruding loops implicated in receptor activation. The FSH-FSHR complexes form dimers in the crystal important for transmembrane signal transduction (Fan and Hendrikson 2005) resulting in activation of the G protein, cAMP production and activation of protein kinase A. Gonadotropins act mainly through stimulation of intracellular cAMP. More recently it has been shown that LH and FSH can also induce an increase of Ca^{++} influx in target cells, but the physiological importance of this mechanism is still unknown. cAMP remains, therefore, the main signal transducer and calcium could possibly act as a signal amplification or modulating mechanism. Following the hormone-receptor interaction there is an increase in cAMP concentrations and subsequent activation of protein kinases which, in turn, phosphorylate existing proteins such as enzymes, structural and transport proteins and transcriptional activators. Activating and inactivating mutations of the gonadotropin receptors have been identified. The biological consequences of these mutations are described below and in Chap. 13.

2.2.5 Endocrine Regulation and Relative Importance of LH and FSH for Spermatogenesis

The primary functions of the testis, androgen production and gamete development, are regulated by the brain, e.g., hypothalamus and hypophysis via GnRH and gonadotropins. Importantly, the hypothalamo-hypophyseal circuit is subject to **negative feedback regulation** mediated by testicular factors (Fig. 2.8). Testosterone inhibits the secretion of LH and FSH. For FSH, the protein hormone **inhibin B** plays an important role (Boepple et al. 2008).

For the interpretation of hormonal regulation and hormonal effects on spermatogenesis, the following terminology should be remembered:

1. **Initiation:** First complete cycle of spermatogenesis during puberty
2. **Maintenance:** Hormonal requirements of intact spermatogenesis in the adult
3. **Reinitiation:** Hormonal requirements for the restimulation of gametogenesis after transitory interruption

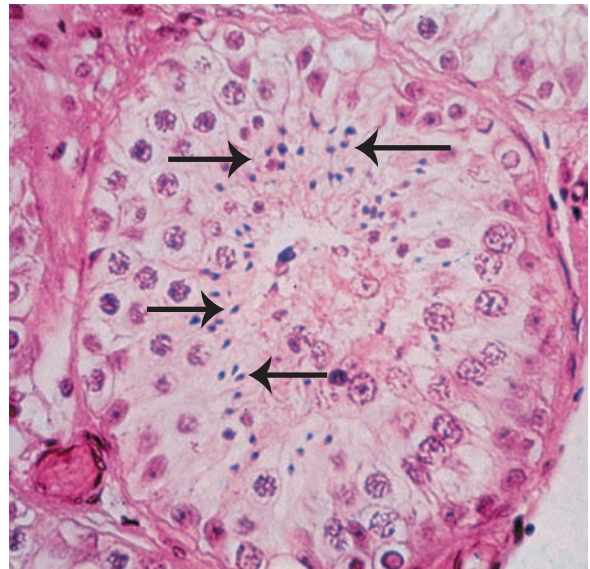

Fig. 2.12 Testicular histology of a 5.2-year old boy with an activating mutation of the LH receptor. Note complete spermatogenesis (arrows). (Courtesy of Prof. Dr. W. Rabl, Pediatric Clinic of the Technical University Munich)

4. **Qualitatively normal spermatogenesis:** All germ cells are present although in subnormal numbers
5. **Quantitatively normal spermatogenesis:** All germ cells are present in normal numbers

Considerable efforts were undertaken to unravel the relative importance of LH/testosterone and FSH for qualitative and quantitative initiation, maintenance and reinitiation of spermatogenesis (Fig. 2.12). It is generally assumed that either testosterone and FSH alone are able to initiate, maintain and reinitiate spermatogenesis but only to a qualitative extent (Weinbauer et al. 2004). In order to achieve quantitative effects on germ cell production and sperm numbers, at least under physiological conditions, both LH and FSH activities are needed.

These assertions are based upon controlled studies in non-human primate models and volunteers, and on studies in patient populations and case reports. The latter has provided interesting information but can also confound interpretation of findings owing to the variable endocrine and medical history of the patients. Complete spermatogenesis is seen in the vicinity of testosterone-producing Leydig cell tumors and in patients with activating mutations of the LH receptor, suggesting that pharmacologically high local

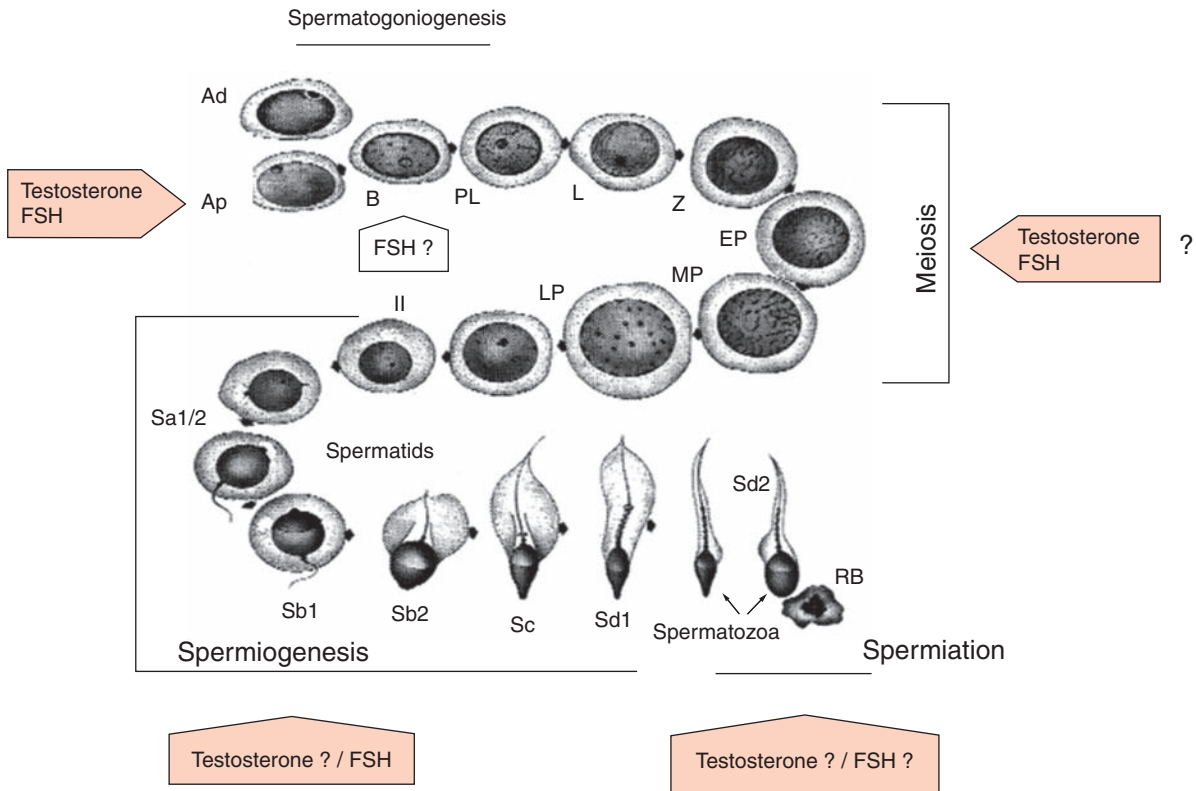

Fig. 2.13 Sites of action of testosterone and FSH on the spermatogenic process in primates. (?) denotes unresolved questions. Ap spermatogonia enter the spermatogenic process (arrow on the cell indicates direction of germ cell development). Ad spermatogonia are believed to constitute the testicular stem cells. The majority of available data indicate that testosterone and FSH act on spermatogenesis via increasing numbers of type A-pale spermatogonia followed by an increase of subsequent germ cell populations. These endocrine factors might act via stimulation of proliferation and/or prevention of cell death. Meiotic transitions appear to be independent of testosterone/FSH action. FSH has been reported to play a role in chromatin

condensation during spermiogenesis. Whether testosterone is needed for spermiogenesis has not been studied yet. Spermiation is affected by gonadotropin sufficiency but it is currently unclear whether this is related to diminished actions of testosterone or FSH or both. Ad = A-dark spermatogonium (testicular stem cells, divides rarely), Ap = A-pale spermatogonium (self-renewing and progenitor cell for spermatogenesis), B = B spermatogonium, PL = preleptotene spermatocytes, L = leptotene spermatocytes, EP = early pachytene spermatocytes, MP = mid pachytene spermatocytes, LP = late pachytene spermatocytes, II = 2nd meiotic division, RB = residual body, Sa1–Sd2 = developmental stages of spermatid maturation

testosterone concentrations induce sperm formation (Fig. 2.13). The aim of treatment is to obtain sufficiently high intratesticular testosterone concentrations, which are crucial. This is normally pursued clinically by giving hCG, which contains high LH activity, together with FSH. On the other hand, patients bearing a defective FSH β subunit, presented with azoospermia (Lindstedt et al. 1998; Phillip et al. 1998). One of these patients was normally virilized, suggesting the need of FSH for complete initiation of spermatogenesis in man. Conversely, patients with Pasqualini syndrome, a disorder with selective LH deficiency, can have complete spermatogenesis, indicating the ability of FSH to initiate the entire male germ cell development cascade.

Exogenous provision of supranormal doses of testosterone or of gestagenic compounds suppresses gonadotropin secretion through the negative feedback mechanism and leads to a drastic decrease of sperm numbers in the ejaculate. In primates – unlike in rodents – it is essential that complete suppression of FSH secretion is achieved despite inhibition of LH secretion (Narula et al. 2002; Weinbauer et al. 2001). In the latter study, albeit LH bioactivity had been completely eliminated, a slight and transient rebound of FSH secretion provoked an escape of spermatogenic suppression. In gonadotropin-suppressed men, either FSH or LH maintained spermatogenesis (Matthiesson et al. 2006). The importance of FSH is also evident

from a hypophysectomized patient in whom an activating mutation of the FSH receptor coexisted with normal spermatogenesis in the absence of LH (Gromoll et al. 1996). Conversely, inactivating mutations of FSH action do not necessarily lead to a complete block of spermatogenesis (Huhtaniemi 1996). Although either hormone on its own has the potential to elicit the entire spermatogenic process, this is not always the case in patients receiving androgen/hCG therapies. In case of failure of hCG, however, the addition of FSH has been shown to permit completion of spermatogenesis in hypogonadotropic men with azoospermia (Bouloux et al. 2003).

In certain animal species, e.g., Djungarian hamsters, FSH is the only hormone responsible for spermatogenesis, while LH and testosterone stimulate the development of androgen-dependent organs and sexual behavior. Conversely, in primates, both gonadotropins are necessary for spermatogenesis. The biological meaning of this **dual regulation system** is not clear yet (Weinbauer et al. 2004).

From a clinical viewpoint it is concluded that the synergistic action of LH/testosterone and FSH is necessary for the initiation, maintenance and also for reinitiation of normal spermatogenesis.

2.2.6 Local Regulation of Testicular Function

As described above, the regulation of testicular function is primarily controlled by central structures. The complexity of the testicular cell types and architecture also mandates a variety of local control and regulatory mechanisms. The categories of local interactions and communication can be classified as **paracrine**, referring to factors acting – mainly by diffusion – between neighboring cells; **autocrine**, referring to factors which are released from the cell and work back on the same cell and **intracrine**, referring to factors and substances which never leave the cell and whose site of production and action is the same cell. The term “paracrinology” has inadvertently been used earlier to characterize all types testicular cell interactions which seem better described by **“local interaction”** (Weinbauer and Wessels 1999). In addition, the interplay between the different testicular compartments are also subsumed under local interactions.

Many local factors have been identified and for several of them, gene-targeting in mice either confirmed or challenged their pivotal role for somatic and germ cell development. This approach in mice has been strengthened by the ability of conditional and cell-specific gene targeting. In contrast and for obvious experimental and ethical reasons, the identification of essential local factors for human testicular function has been limited.

It is evident that the endocrine mechanisms play the central role in the regulation of testicular function and **factors produced locally** are important for the **modulation of hormone activity** and local factors could thus be seen as **mediators of hormone action and intra-/intercellular communication**. From this point of view both gametogenesis and endocrine function of the testis are under local control. An example for this might be the earlier report of stage-specific expression of androgen receptor in the human testis (Suarez-Quian et al. 1999). While Sertoli cells were viewed as coordinators and regulators of germ cell development and maturation for a long time, these cells are now believed to be influenced by germ cell products that can influence the secretory activity of Sertoli cells. Hence, Sertoli cells are under the local control of germ cells having varying requirements for metabolic substances depending on the spermatogenic cycle phase (Franca et al. 1998).

A plethora of factors with potentially local testicular activity has accumulated, e.g., **growth factors, stem cell factors, immunological factors, opioids, oxytocin and vasopressin, peritubular cell modifying substance, renin and angiotensin, GHRH, CRH, ACTH, GnRH, calmodulin, ceruloplasmin, transport proteins, glycoproteins, plasminogen activator, metalloproteases, dynorphin, PACAP**, etc. Moreover, it can be reasonably assumed that other, still unidentified protein factors mediate the communication between interstitial and tubular compartments, between Sertoli cells and germ cells and between germ cells.

2.2.6.1 Steroid Hormones

Testosterone is the main secretory product of the testis, along with 5 α -dihydrotestosterone (DHT), androsterone, androstenedione, 17-hydroxyprogesterone, progesterone and pregnenolone. The role of androsterone, progesterone and 17-hydroxyprogesterone in the testis

is unknown but progesterone receptors have been found in some peritubular cells and on spermatozoa (Luetjens et al. 2006; Modi et al. 2007). Using a derivative of progesterone, norethisterone enanthate, no direct effects on testicular/epididymal function were found (Junaidi et al. 2005).

For testosterone, a classic endocrine factor, compelling evidence is available as a pivotal local regulator of spermatogenesis. Rodent data demonstrated that selective elimination of Leydig cells, interruption of testicular testosterone transport and specific Sertoli cell androgen receptor knockout models provoked profound alterations of germ cell maturation (Takaimya et al. 1998). Selective peritubular cell androgen receptor knockout mice exhibited specific Sertoli cell and peritubular cell defects (Zhang et al. 2006). Spermatogenesis was present in boys with testosterone-producing Leydig cell tumors but only in seminiferous tubules adjacent to the tumor and not in tumor-free areas. Similarly, activating mutations of the LH receptor prematurely induced qualitatively normal spermatogenesis.

In fertile men testicular testosterone concentrations exceed that of SHBG/ABP by about 200-fold (Jarow et al. 2001), indicating a substantial surplus of testosterone in the testis. Relative to serum, testicular testosterone concentrations were >80-fold higher (Coviello et al. 2005). Testosterone is metabolized to DHT by testicular 5α -reductase activity and to estradiol by testicular aromatase activity. To what extent these metabolic activities are essential for spermatogenesis besides testosterone itself is not entirely clear. Treatment of volunteers with the 5α -reductase-inhibitor finasteride did not alter spermatogenesis (Kinniburgh et al. 2001; Overstreet et al. 1999), whereas more recently, a mild decrease in semen parameters was reported for finasteride and dutasteride (Amory et al. 2007b). Addition of dutasteride to a contraceptive steroid regimen (testosterone and levonorgestrel) did not augment suppression of spermatogenesis (Matthiesson et al. 2005a). With regard to estradiol, aromatase activity and estrogen receptor- β are present in human Sertoli cells and germ cells (Carreau et al. 2006 for review; Berensztejn et al. 2006). Administration of aromatase inhibitor in a non-human primate model with seasonal reproduction (bonnet monkey) resulted in impairment of spermiogenesis and altered sperm chromatin condensation (Shetty et al. 1997, 1998). The clinical evidence for a causal role of estrogens for testicular functions is ambiguous since isolated cases with estrogen receptor deficiency or aromatase deficiency did not

reveal a consistent picture, with some patients being ill and having cryptorchidism (O'Donnell et al. 2001; Maffei et al. 2004).

Although it is established beyond doubt that testosterone is an essential local regulator of spermatogenesis, it has been surprisingly difficult to demonstrate a clear-cut relationship between testicular testosterone concentrations and germ cell production. In non-human primates, no correlation between testicular androgen levels and germ cell production/spermatozoal number was observed (Narula et al. 2002; Weinbauer et al. 2004 for review). Similarly, contraceptive studies in volunteers failed to demonstrate a correlation between intratesticular steroids and germ cell numbers (Matthiesson et al. 2005b).

In the non-human primate testosterone induces the formation of smooth muscle actin in the peritubular cells during prepubertal testicular maturation (Schlatt et al. 1993). Peritubular cells express the androgen receptor. The testosterone effect is significantly reinforced by FSH. Since FSH receptors are found only in Sertoli cells it follows that FSH influences androgen action indirectly through factors arising in the Sertoli cell. This indicates that as an endocrine factor FSH can also induce the formation of physiologically relevant, locally acting factors in the primate testis. Interestingly, recombinant FSH stimulates testosterone production in men (Levalle et al. 1998) and in patients with selective FSH deficiency (Lofrano-Porto et al. 2007), lending further support to the importance of local interactions between Sertoli cells, Leydig cells and peritubular cells in connection with the actions of androgens and gonadotropins. In-vitro studies using monkey Sertoli cells exposed to testosterone and FSH, revealed that estradiol was produced in the presence of testosterone but not of FSH (Devi et al. 2006). This is surprising since based upon rodent data, Sertoli cell aromatase activity is regulated by FSH.

Testosterone acts both as an endocrine and local (paracrine and autocrine) factor within the testis.

2.2.6.2 Insulin-like Factor 3

Insulin-like factor 3 (INSL3) is a relaxin-like proteohormone produced by Leydig cells (Foresta et al. 2004) and signals through a G-coupled receptor (LGR8) that is expressed in Leydig cells and meiotic/

postmeiotic testicular human germ cells but not in peritubular and Sertoli cells (Anand-Ivell et al. 2006). Compelling evidence is available to indicate that INSL3 is a marker of Leydig cell differentiation and of entry into male puberty (Ferlin et al. 2006; Wikström et al. 2006). Levels of INSL3 are influenced by hCG/LH but this effect appears uncoupled from the steroidogenic effects of LH on testosterone synthesis (Bay et al. 2005, 2006). Since receptors for INSL3 are present on advanced germ cells it is tempting to assume a local role for INSL3 during spermatogenesis. A retrospective analysis of several male contraceptive studies suggested that circulating INSL3 levels were lower in azoospermic subjects compared to non-azoospermic subjects and a weak correlation between INSL3 levels and sperm number was reported (Amory et al. 2007a). More data is needed to reach a firm conclusion on the relevance of INSL3 as a local regulator of human spermatogenesis.

2.2.6.3 Growth Factors

Growth factors bind to surface receptors and induce cell-specific differentiation events via specific signal transduction cascades. Among those factors participating in the local regulation of spermatogenesis are **transforming growth factor** (TGF)- α and - β , **inhibin** and **activin**, **nerve growth factor** (NGF), **insulin-like growth factor I** (IGF-I), fibroblast growth factor (FGF) and **epidermal growth factor** (EGF).

Inhibin and activin have been detected not only in Sertoli cells, but also in Leydig cells of primates. Inhibins and activins are structurally related proteins. The heterodimer inhibin consists of an α subunit and a βA or βB subunit whereas activins are homodimers ($\beta A\beta A$ or $\beta B\beta B$). Generally, activins are considered to stimulate spermatogonial proliferation whereas inhibins exert inhibitory actions. Of considerable clinical interest are recent discoveries that serum concentrations of **inhibin** are correlated with spermatogenic activity, testis size and sperm production. This growth factor can actually be used as an endocrine indicator of local spermatogenic defects (Boepple et al. 2008; Meachem et al. 2001).

In vitro studies have suggested that the local function of inhibin and activin could be a modulation of steroidogenic activity in Leydig cells. Activins inhibit or stimulate Leydig cell steroidogenesis in a species-

dependent manner. Generally, IGF-I and TGF- α exert a stimulatory activity in the testis, while TGF- β acts as an inhibitor. In the rat, the development of Leydig cells is sustained by an interplay between TGF- α and TGF- β and LH activity is modulated by IGF-I. In the human Leydig cell the steroidogenic activity is also stimulated by EGF. This growth factor directly influences spermatogenesis: IGF-I concentrations are positively related to the number of pachytene spermatocytes. In man, IGF-I shows the highest expression in these spermatocytes and stimulates DNA synthesis in mitotic germ cells. Administration of IGF-I to patients increased testis size but this was also associated with increased gonadotropin secretion and testosterone (Laron and Klinger 1998). An important role of NGF for the structural organization of the human seminiferous tubules is postulated, since the culture of seminiferous tubules can be successful only in the presence of NGF. NGF has been localized in peritubular cells by immunocytochemistry. In the rat, NGF is an important regulator of meiotic division. Fibroblast growth factor has been involved in mitosis and Sertoli-germ cell interactions.

2.2.6.4 Immune System Factors

Cells of the immune system and the blood-testis-barrier provide a special environment for the development of otherwise antigenic germ cells (see Sect. 2.5). It appears, however, that immune factors may also play a more direct role during testicular steroidogenesis and gametogenesis and might have a relationship to male infertility (Albrecht et al. 2005; Fijak and Meinhardt 2006; Hedger 2002). These factors involve leucocyte, macrophage and mast cell products. For example, cytokines such as interferon, tumor necrosis factor (TNF), interleukins, leukemia inhibiting factor (LIF), stem cell factor (SCF), macrophage migration inhibiting factor (MIF) that bind to cell surface receptors and provoke cell proliferation and differentiation. TNF and LIF are suspected to play a role in Sertoli cell-germ cell interactions and in the autocrine control of Sertoli cell proliferation. MIF is produced specifically by Leydig cells and is found in Sertoli cells, basal germ cells and peritubular cells following elimination of Leydig cells, indicating that compensatory mechanisms maintain testicular MIF production. Unlike interleukins, SCF and its receptor (c-kit) are

clearly essential local factors that govern germ cell migration during ontogenesis and spermatogonial differentiation in the adult testis. SCF is synthesized and secreted by Sertoli cells whereas the receptor is expressed on spermatogonial surfaces. The SCF/c-kit system is important for spermatogonial differentiation and development.

2.3 Testicular Descent

The incidence of positional anomalies of the testis is over 3% and ranges among the most common congenital defects (reviewed in Virtanen et al. 2007a). These defects are associated with spermatogenic disturbances such as fewer **spermatogonial stem cells** at birth compared with normal boys (Virtanen et al. 2007b) and increased risk of **testicular tumor** development. Testicular descent is multifactorial with two distinct phases. First a **descending phase** from the lower kidney pole to the pelvic cavity (**transabdominal phase of descent**) controlled by the swelling of the gubernaculum. The shortening of the gubernacular cord and the outgrowth of the gubernacular bulb controlled by the genitofemoral nerve is independent of androgens. The gubernaculum deposits extracellular matrix, rich in glycosaminoglycans and hyaluronic acid, and forms a cone-like structure at the caudal end of the gonad, anchoring the developing testis close to the inguinal region during fetal growth. The second phase, the descent into the scrotum (**inguino-scrotal phase of**

descent) is controlled by androgen action (Shono 2007). In the 26th gestational week the gubernaculum begins to grow through the inguinal canal and reaches the scrotum by gestational week 35, pulling the testis in its path before the gubernaculum shrinks to a fibrous remnant. The intra-abdominal pressure and the shrinkage of the gubernaculum may force the testis through the inguinal canal. At birth, the testes reach at the bottom of the scrotum and in 97% of boys testicular descent is completed within another 12 weeks (Fig. 2.14).

The physiological and endocrine mechanisms that govern testicular descent are not known in detail. Several factors besides androgen such as calcitonin gene-related peptide, epidermal growth factor (EGF) and fibroblast growth factor (FGF) family are candidates for inducing the testicular descent (Nightingale et al. 2008). *Hoxa-10* and insulin-like factor 3 (INSL3) are potential regulators of these phases as suggested by the fact that in gene knockout mice maldescended testes remain located in the abdominal cavity. INSL3 produced by the Leydig cells together with androgen induces the gubernaculum growth and is therefore needed in the early phase (Emmen et al. 2000). INSL3 knockout mice have their testes high in the abdominal cavity. In *Hoxa-10* knockout mice, testes remain close to the scrotum after the initial descending phase. Estrogens or environmental endocrine disruptors have also been suspected to induce a down-regulated INSL3 expression and thus disturb testicular descent (Toppari et al. 2006). Genetic analysis in men revealed several functionally deleterious mutations in both INSL3 and

Fig. 2.14 Testicular descent. At an early stage the gonad precursor organ is located next to the kidney (K). During the first testicular descent phase between week 8 (left image) and week 17 (right image), the testis is anchored by the swollen gubernaculum close to the inguinal region. The bud-like growth of the gubernaculum is regulated by INSL-3 and androgens

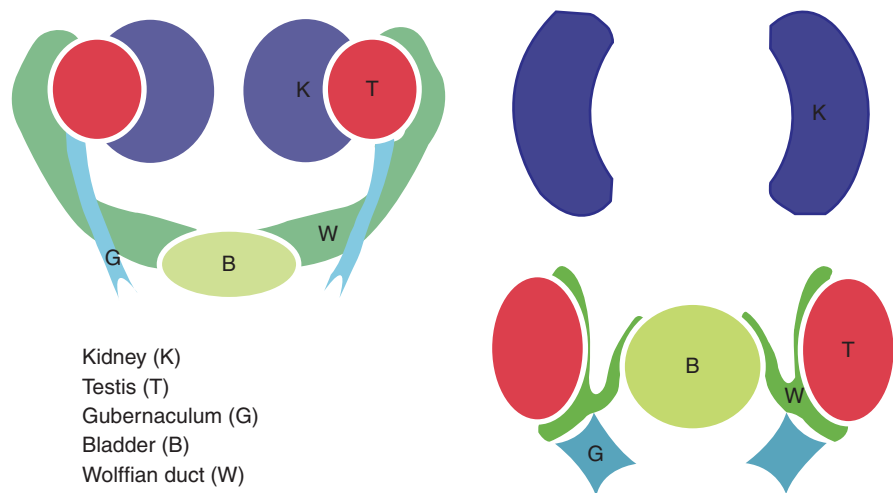

its receptor GREAT/LGR8 gene. Although some mutations were found only in patients with maldescended testes, the causative link between the presence of mutations in INSL3 or GREAT/LGR8 and the undescended testes remains to be demonstrated (Feng et al. 2006; Yamazawa et al. 2007).

2.4 Vascularization, Temperature Regulation and Spermatogenesis

Vascularization of the testis has two main roles: **transport and mobilization** of endocrine factors and metabolites, as well as regulation of **testicular temperature**. The arterial supply of the testicular parenchyma follows the lobular division of the seminiferous tubules. Each lobule is supplied by one artery from which segmental arteries originate at a distance of about 300 μm from each other, supplying blood to the lateral regions of the lobuli (Ergiın 1994a, b). Segmental arteries and capillaries become branched between the Leydig cells and finally give rise to the venous system.

In men, testicular temperature is about 3–4°C below core body temperature and about 1.5–2.5°C above the temperature of scrotal skin. For the maintenance of a physiologically lower temperature the testis relies on two **thermoregulatory systems**. Heat can be transferred to the external environment through the scrotal skin, as the scrotal skin is very thin, possesses hardly any subcutaneous fat tissue and has a very large surface.

The second regulatory system is the pampiniform plexus. In this system, the convoluted testicular artery is surrounded by several veins coiling around the artery several times. Arterial blood arriving at the testis is thereby cooled down by the surrounding venous blood. The usual explanation for the pampiniform plexus here is to efficiently maintain the optimal temperature which is below body temperature. Recently, a new theory has been put forward hypothesizing that the process of spermatogenesis results in a large amount of heat which has to be regulated. Testes are located in the scrotum in order to maintain lower than body temperatures (Skandhan and Rajahariprasad 2007). Some mammals' testes remain functional inside the body, e.g., elephants, but these animals lack sweat glands and are closely related to aquatic ancestors which have to compensate for the chilling effects of the heat-conducting environment, namely water. Human scrotal

skin is devoid of subcutaneous fat and the presence of high sweat gland density enables heat transmission. Upon exposure to cold temperatures, the scrotal surface is minimized by contraction for preventing temperature loss and cremaster muscles retract the testes closer to the abdomen for temperature maintenance.

In case of **varicoceles**, defined as abnormally dilated scrotal veins, scrotal temperature is increased (Lerchl et al. 1993). Approximately 15% of normal men have a varicocele, with 40% of them having fertility problems. Venous reflux and testicular temperature elevation appear to play an important role in testicular dysfunction, although the exact pathophysiologic mechanisms involved are not yet completely understood. An increase of testicular temperature results in damage of the spermatogenic function of the testis (Jung and Schuppe 2007). If testicular temperature is increased in adults, reversible spermatogenic damage can be induced. Most importantly, however, substantial increase of temperature must be achieved. Scrotal temperature elevations by 0.8–1°C over a period of 52 weeks in healthy volunteers had no adverse effect on the number and quality of spermatozoa (Wang et al. 1997).

Treatment with heat leads to sustained activation of both mitogen-activated protein kinase MAPK13 and MAPK14. Activation of MAPK13 and MAPK14 is accompanied by an increase in B-cell leukemia/lymphoma 2 (BCL2) levels in both cytosolic and mitochondrial fractions of testicular lysates, leading to apoptosis mediated by cytochrome c and DIABLO release (Jia et al. 2007). Heat also results in inactivation of Bcl2, an anti-apoptotic protein, through phosphorylation at serine 70, thereby favoring the apoptotic pathway. Both the protein kinases and the anti-apoptotic factor Bcl2 help balance the death pathway in male germ cells. However, although testicular temperature is lower than body temperature in the majority of mammals, this difference is not obligatory in every species.

2.5 Immunology of the Testis

Gonocytes migrate to the testis even during prenatal development, but spermatogonia begin to differentiate into spermatozoa only at puberty after the immune system has matured and a systemic self-tolerance is

developed. As the spermatogonia proliferate and differentiate into spermatocytes, many new surface and intracellular proteins are expressed which are unique in the body, especially for the immune system. These proteins are also novel antigens which have to be tolerated by the immune system. At the same time, adjacent Sertoli cells form complex networks of specialized tight junctions (zonula occludens) that cause isolation of the tubular contents from the blood vascular compartment. This barrier contains several integral membrane proteins, comprising various components such as junctional adhesion molecules, claudin family proteins, and occludin. The **blood-testis-barrier** provides a separation between immune cells and haploid germ cells with antigenic properties. This barrier was thought to provide the basis of the systemic tolerance to newly developing auto-antigens. Transplantation of spermatogonia into testis tubuli can restore spermatogenesis, even across species borders (Schlatt et al. 1999), demonstrating that the seminiferous tubules are an immunoprivileged site.

Notwithstanding this, auto-antigens are also expressed in cells located outside the inter-Sertoli cell tight junctions, e.g., in the basal compartment of the seminiferous epithelium and are recognized as foreign (Pöllänen and Cooper 1994)). Experiments with allo- and xenografts placed directly into the testicular interstitial space can lack signs of degeneration caused by a graft-versus-host reaction, indicating absent or reduced immune reactions (Gores et al. 2003; Isaac et al. 2005). However, the testis is capable of a normal inflammatory response, demonstrated by its effective reaction to viral and bacterial infections, especially in the rete testis where testicular sperm enter the efferent ducts of the epididymis (Naito and Itoh 2008). This transition zone has a special arrangement of Sertoli-like cells, forming a valve with many macrophages patrolling the tissue. The blood-testis-barrier is terminated in this area; subsequently, spermatozoa are no longer protected, whereas later on, an **epididymidal-blood-barrier** is present (Dube et al. 2007). This status is confirmed by the observation that certain forms of autoimmune orchitis are first manifested in the rete testis. Studies demonstrated that the blood-testis-barrier at this transition point is incomplete against humoral antibodies and also intravenously injected horseradish peroxidase. The immune privilege of the testis is not only due to the blood-testis-barrier, but also depends on a specific

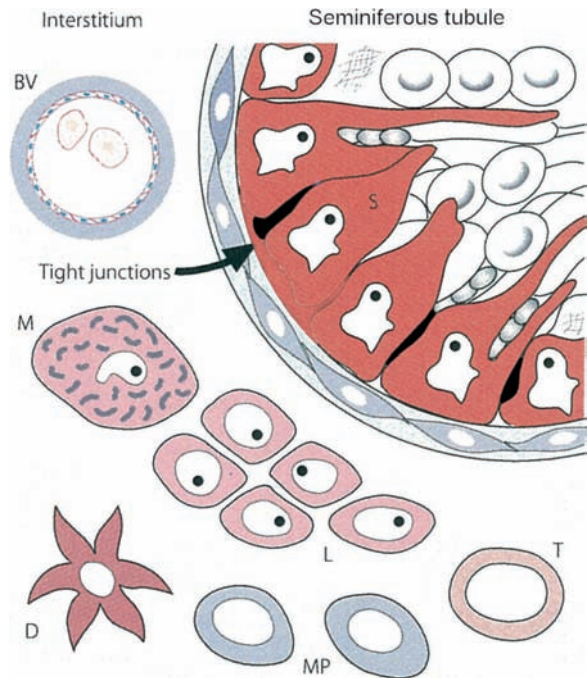

Fig. 2.15 Immunological compartments of the testis. Sertoli cells (S) traverse the testicular tubules, keeping in close contact with the germ cells. Together with the peritubular cells, they form the seminiferous epithelium. The blood–testis barrier (tight junctions) is built by tight junctions between neighboring S, dividing the seminiferous tubules into a basal and adluminal compartment. The interstitial space contains the Leydig cells (L) and the immune cells such as macrophages (MP), dendritic cells (D), mast cells (M), and T cells as well as blood vessels (BV) with migrating leukocytes

intratesticular regulation of the immune system function (Fig. 2.15). The predominant interstitial cell type is the Leydig cell. In transplantation studies, rats pretreated with estrogen to suppress Leydig cell testosterone production promptly rejected intratesticular allografts, indicating that high intratesticular testosterone concentrations seem to play an important role in the maintenance of testicular immune privilege. However, it remains unknown how testosterone may mediate an anti-inflammatory effect. In fact, the interstitium contains a variety of immunocompetent cells e.g., leukocytes, macrophages, monocytes, dendritic cells, T and B lymphocytes, and mast cells.

Testicular macrophages are found as early as week 7 of gestation and probably originate from hematopoietic precursor cells that migrate to the testis. Macrophages proliferate in the testis during postnatal life, probably under pituitary control, since hCG is

able to increase the mitotic index of testicular macrophages in rats. In the adult, human testis macrophages represent about 25% of all interstitial cells. Morphologically and biochemically they are similar to macrophages resident in other tissues. Testicular macrophages have a reduced capacity to excrete some cytokines such as IL-1 β and TNF- α compared to macrophages from other tissues (Hayes and Crowley 1998). Furthermore, lipopolysaccharides, resembling the surface of bacteria, given to immature and mature mice resulted in enhanced levels of the testicular cytokine IL-6 and constitutively elevated the production of other anti-inflammatory mediators (Elhija et al. 2005; Isaac et al. 2005). Interestingly, the expression of pro-inflammatory cytokines such as IL-1 β and TNF- α by testicular macrophages demonstrates the testicular capability of an inflammatory response. Up to now two macrophage types have been distinguished in the adult testis that differ in the expression of markers and inflammatory mediators. In the rat, the ED2⁺ expressing macrophages do not participate in promoting inflammatory processes. They may take part in maintaining the immune privilege as an immunoregulatory team player. However, the ED1⁺ ED2⁻ macrophages are involved in testicular inflammatory responses. During acute and chronic inflammation the influx of ED1⁺ monocytes change the equilibrium of the macrophage population. The number of mononuclear cells increases in case of testicular disease.

In about 5% of testicular biopsies from infertile men lymphoid cells surround the tubules with markedly higher spermatogenic damage. Similarly, mononuclear infiltrates are often associated with carcinoma in situ. Seminomas generally show a very conspicuous infiltration of immunocompetent cells. Diseases such as mumps can be complicated by a severe testicular inflammation in 35% of cases.

The contribution of mast cells to the immune system has often been underestimated, but recently the complexity of these cells was shown and their involvement in the innate and adaptive immune system (Gilfillan and Tkaczyk 2006; Stelekati et al. 2007). Mast cells can release factors that act as mediators and as such are capable of influencing disease induction and progression. In the brain these cells can change vascular permeability through factor release, thereby opening the blood-brain-barrier, allowing the entry of activated T lymphocytes and increased inflammatory cell traffic. In men the testicular mast cell presence changes with age,

with numbers increasing slightly during infancy, decreasing during childhood, and increasing again at puberty. Their major released product, a serine protease trypase, is a mitogen for fibroblasts, enhancing the synthesis of collagen, resulting in fibrosis, thickening, and hyalinization of the tubuli walls.

Histological features of spermatogenic pathologies are associated with increased numbers of mast cells and are often found in men with infertility problems (Apa et al. 2002; Sezer et al. 2005). Mast cell inhibitors are beneficial in the treatment of idiopathic oligozoospermia and oligoasthenozoospermia too and can prevent mast cell activation (Cayan et al. 2002; Hibi et al. 2002). Human peritubular cells express receptors for the mast cell products histamine and trypase (Albrecht et al. 2006). This may be helpful in the maintenance of an immunosuppressive phenotype not only in the testis.

2.6 Testicular Androgens

Androgens are essential for the development and function of testes, maturation of secondary sexual characteristics, masculinization of the bone-muscle apparatus, libido, and stimulation of spermatogenesis. Physiological effects of androgens depend on different factors such as number of androgen molecules, distribution of androgens and their metabolites inside the cell, interaction with the receptors, polyglutamine number of the amino acid sequence in the androgen receptor and receptor activation (Palazzolo et al. 2008). In turn, androgen concentrations in the blood depend on the synthesis rate, balanced by metabolic conversion and excretion. Androgens also exert rapid non-genomic effects contributing to the physiological actions (Lösel et al. 2003). Whereas genomic effects take hours or days to produce their actions, rapid steroid effects are activated within seconds or minutes. These non-genomic actions are not removed by inhibition of transcription or translation and are often activated by membrane-impermeant steroid conjugates. However, rapid pathways of androgen action can modulate transcriptional activity of androgen receptors or other transcription factors (Rahman and Christian 2007).

In men, **testosterone** is by far the most important and abundant androgen in blood. More than 95% of

the existing androgens derive from the testis, which synthesizes about 6–7 mg testosterone per day. Besides the testes the remaining contribution to androgen production derives mainly from the adrenals. The site of androgen production in the testis is the Leydig cell. Both synthesis and secretion are under regulation of pituitary LH and local factors (Lei et al. 2001; Sriraman et al. 2005).

Since Leydig cells cannot store androgens, de novo biosynthesis takes place continuously. The starting point for androgen synthesis is cholesterol, a fundamental substance of metabolism, with the typical steroid ring conformation energetically compatible with the transformation into androgens. Unlike most cells that use cholesterol primarily for membrane synthesis, Leydig cells have additional requirements for cholesterol, because it is the essential precursor for all steroid hormones. LH as the central regulatory factor controls both steroidogenesis and Leydig cell cholesterol homeostasis in vivo. Cholesterol can either be incorporated by the cell through receptor-mediated endocytosis from low-density lipoproteins (LDL), or can be synthesized de novo within the Leydig cell starting from acetyl-coenzyme A. In addition testosterone signaling regulates lipid homeostasis in Leydig cells. It also affects the synthesis of steroids and modulates the expression of genes involved in de novo cholesterol synthesis (Eacker et al. 2008). Cholesterol is stored in cytoplasmic lipid droplets. The number of lipid droplets is inversely related to the rate of androgen synthesis in the Leydig cell, i.e., a high synthesis rate leads to a low content of lipid droplets and vice versa.

2.6.1 Synthesis of Androgens

Androgen synthesis requires the **conversion of cholesterol to testosterone** (Fig. 2.16). This transformation goes through five different enzymatic steps in which the side chain of cholesterol is shortened through oxidation from 27C to 19C. The steroidal A-ring assumes a keto configuration at position 3. The starting point for the transformation of cholesterol into testosterone is the shortening of the side chain through C 22 and C 20 hydroxylases, followed by cleavage of the bond between C 20 and C 22, leading to production of pregnenolone. The steps following pregnenolone formation

occur in the endoplasmic reticulum either through the $\Delta 4$ or through the $\Delta 5$ pathway.

The designation $\Delta 4$ or $\Delta 5$ refers to the localization of the double bond in the steroid. The **$\Delta 5$ pathway** is predominant over the $\Delta 4$ in human steroid synthesis. Along the **$\Delta 4$ pathway**, pregnenolone is dehydrated to progesterone, a key biological substance. The $\Delta 4$ pathway proceeds to the intermediate 17α -hydroxyprogesterone. If the side chain is removed at this stage, the intermediate androstene-3, 17-dione is produced, which, through further reduction at position C 17, is then transformed into testosterone. In the $\Delta 5$ synthesis pathway, testosterone synthesis occurs through the intermediates 17 -hydroxypregnenolone and dehydroepiandrosterone.

Cholesterol is the starting point for biosynthesis of steroids, oxysterols and bile acids. After cholesterol, an insoluble molecule is de novo synthesized or taken up via the LDL receptor into the cell. Cholesterol for steroidogenesis is stored in an ester form in lipid droplets, which are hydrolyzed by LH activation of cholesterol ester hydrolase. It has to be transported within the cell to the mitochondria where it is imported into the cristae of the mitochondria.

The discovery of the Steroidogenic Acute Regulatory protein (StAR) and related proteins containing StAR-related lipid transfer domains have helped much to understand this limiting step of testosterone synthesis. StAR mRNA expression is triggered by endocrine stimuli and is rapidly and widely distributed in steroidogenic tissues including the adrenals and corpora lutea. StAR moves cholesterol from the outer to the inner mitochondrial membrane, but acts exclusively on the outer membrane. The precise mechanism by which StAR's action stimulates the influx of cholesterol remains unclear, but when StAR connects to cholesterol it performs a conformational change that opens a cholesterol-binding pocket (Miller 2007). After a phosphorylation StAR interacts with voltage-dependent anion channel 1 (VDAC1) on the outer membrane, which processes the phospho-StAR to a smaller intermediate. If VDAC1 is lacking, phospho-StAR is degraded by cysteine proteases preventing the mitochondrial membrane transport (Bose et al. 2008). The physiological importance of StAR is highlighted by the phenotype of patients with an inactivating mutation of the StAR gene. These patients suffer from life-threatening congenital adrenal hyperplasia as they are unable to produce the necessary amounts of steroids.

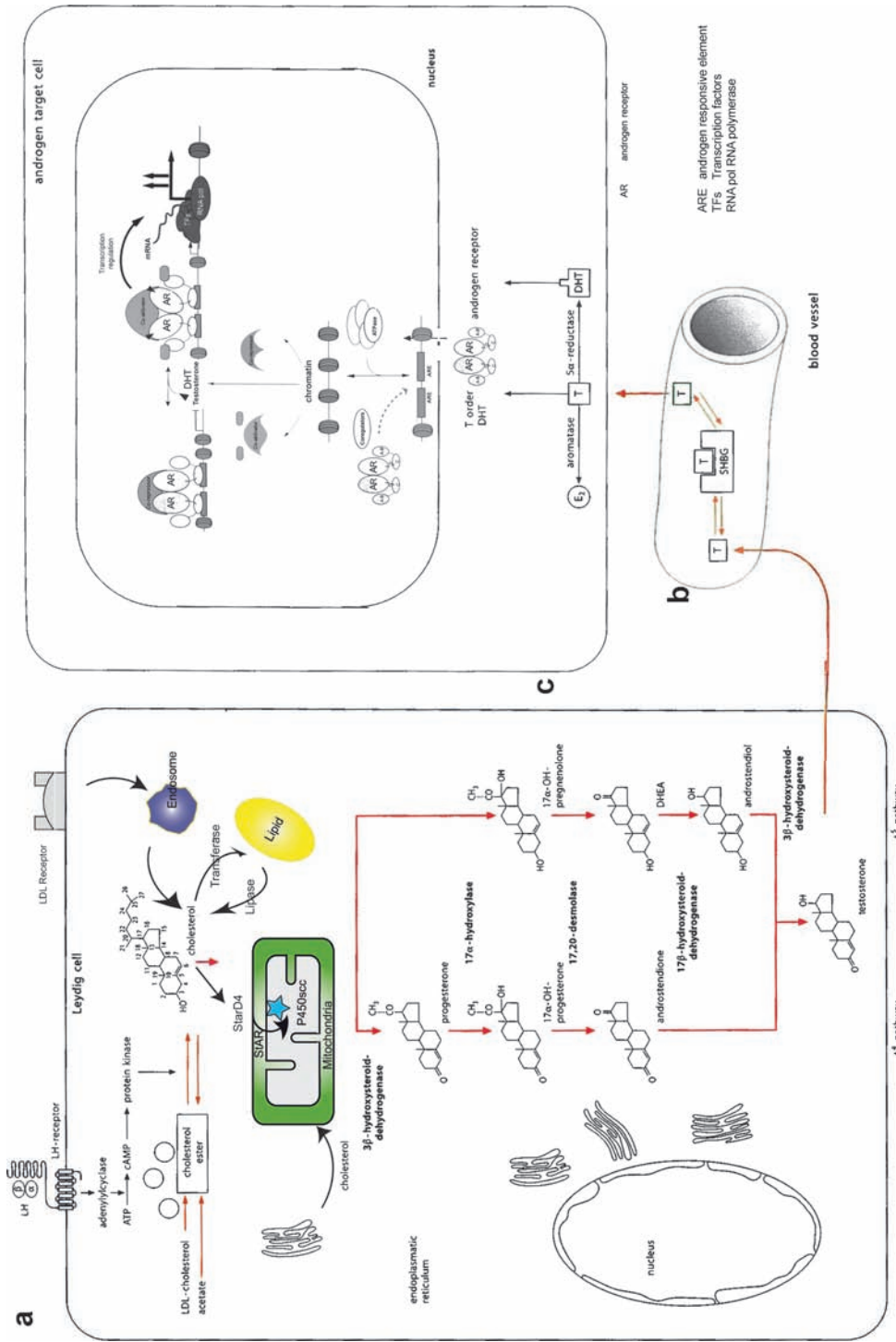

Fig. 2.16 (a) Steroid biosynthesis in the Leydig cell. Steroid biosynthesis is induced by LH through activation of adenylyl cyclase. Starting material is cholesterol or acetate. The C atoms of cholesterol are numbered in order to follow better the different enzymatic modifications and their localization. StAR (Steroidogenic acute regulatory protein) plays a key role during steroidogenesis. StAR is localized to the inner mitochondrial membrane and governs cholesterol transport. (b) Cholesterol uptake and transport to the inner mitochondrial membrane. (c) Normally human steroid cells take up circulating low-density lipoproteins (LDL) through receptor-mediated endocytosis, directing the cholesterol to endosomes. It may be esterified by acyl-CoA cholesterol transferase and stored in lipid droplets as cholesterol esters. Free cholesterol, set free by the hormone-sensitive lipase, is probably bound by StarD4 for trans-cytoplasmic transport to the mitochondrial membrane. StAR is responsible for the rapid movement of cholesterol from the outer mitochondrial membrane to the inner mitochondrial membrane, where it is converted by P450_{scc} to pregnenolone

Fig. 2.16 (a) Steroid biosynthesis in the Leydig cell. Steroid biosynthesis is induced by LH through activation of adenylyl cyclase. Starting material is cholesterol or acetate. The C atoms of cholesterol are numbered in order to follow better the different enzymatic modifications and their localization. StAR (Steroidogenic acute regulatory protein) plays a key role during steroidogenesis. StAR is localized to the inner mitochondrial membrane and governs cholesterol transport. (b) Cholesterol uptake and transport to the inner mitochondrial membrane. (c) Normally human steroid cells take up circulating low-density lipoproteins (LDL) through receptor-mediated endocytosis, directing the cholesterol to endosomes. It may be esterified by acyl-CoA cholesterol transferase and stored in lipid droplets as cholesterol esters. Free cholesterol, set free by the hormone-sensitive lipase, is probably bound by StarD4 for trans-cytoplasmic transport to the mitochondrial membrane. StAR is responsible for the rapid movement of cholesterol from the outer mitochondrial membrane to the inner mitochondrial membrane, where it is converted by P450_{scc} to pregnenolone

At the inner mitochondrial membrane site cytochrome P450_{ssc} (ssc = side chain cleavage) catalyzes the conversion of cholesterol into pregnenolone. The enzyme cytochrome P450_{ssc} is responsible for the different enzymatic reactions leading to the production of pregnenolone. Like other steroid synthetic enzymes, it belongs to the group of monooxygenases, containing a prosthetic hemogroup as in hemoglobin and is localized on the internal membrane of mitochondria. This reaction consists of three consecutive monooxygenations requiring two electrons to activate molecular oxygen; a 22-hydroxylation, 20-hydroxylation and the cleavage of the C 20–C 22 bond, yielding pregnenolone and isocaproic aldehyde. Pregnenolone diffuses across the mitochondrial membranes and is transformed into testosterone through the enzyme cytochrome P450 C 17, also belonging to the group of monooxygenases and located in the endoplasmic reticulum. The overall enzymatic system, however, is not capable of transforming every molecule of pregnenolone into testosterone so that several intermediates are produced.

Testosterone is the main secretory product of the testis, along with **5 α -dihydrotestosterone (DHT)**, androsterone, androstenedione, 17-hydroxyprogesterone, progesterone and pregnenolone. The transformation of testosterone into DHT takes place principally in the target organs, e.g., prostate. Androstenedione is important as a precursor for the production of extratesticular estrogens. Biologically active **estradiol** can be produced as a result of extratesticular aromatization of androstenedione to estrone that is subsequently reduced to estradiol in peripheral tissues. Only a very small portion of the testosterone produced is stored in the testis and the androgen is mainly secreted in blood.

Testosterone concentrations in the testicular lymphatic circulation and in the venous blood are very similar, but there are essential differences in the flow rate and velocity of both systems. Therefore, transport of testosterone in the general blood circulation occurs mainly through the spermatic vein. Androgens diffuse into interstitial fluid and then enter testicular capillaries or enter capillaries directly from Leydig cells that are in direct contact with the testicular microvasculature. The mechanism for testosterone transport from the Leydig cell into the blood or lymph is not completely known. Probably lipophilic steroids distributed within cells or small cell groups are released through passive diffusion.

2.6.2 Testosterone Transport in Blood

During transport in plasma, testosterone is mainly bound to albumin or to **sex hormone binding globulin (SHBG)** which is produced by hepatocytes. A protein, the androgen binding protein (ABP), with similar steroid-binding characteristics was found to be produced in the testis. SHBG is a β -globulin consisting of different protein subunits. In rats it is expressed in Sertoli cells and is secreted preferentially into the seminiferous tubules, migrates into the caput epididymis where it is internalized by epithelial cells regulating androgen-dependent mechanisms of sperm maturation. Testicular SHBG isoforms are found in sperm and released from these during the capacitation reaction. Plasma SHBG is about 95 kDa in molecular weight, 30% of which is represented by carbohydrate, and possesses one androgen binding site per molecule. Human testicular SHBG transcripts are expressed in the germ cells and contain an alternative exon 1 sequence, appearing to encode an SHBG isoform that is 4–5 kDa smaller than plasma SHBG. The testosterone binding capacity is also much lower compared to the plasma SHBG (Selva et al. 2005).

In normal men, only 2% of total testosterone circulates freely in blood, while 44% is bound to SHBG and 54% to albumin. The binding affinity of testosterone to albumin is about 100 times lower compared to SHBG. However, since albumin concentration is much higher than that of SHBG, the binding capacity of both proteins for testosterone is about the same. The ratio of testosterone bound to SHBG over free SHBG is proportional to SHBG concentration. A direct measurement of free testosterone is impractical in routine practice, so that several equations are used to estimate the free testosterone concentration in serum.

The main dissociation of testosterone from binding proteins takes place in capillaries. The interaction of binding proteins with the endothelial glycocalyx leads to a structural modification of the hormonal binding site and thereby to a change in affinity. As a result testosterone is set free and can diffuse freely into the target cell or binds together with SHBG to **megalín**, a cell importer protein (Hammes et al. 2005). Megalín is expressed in sex-steroid target tissues and is a member of the low density lipoprotein receptor superfamily of endocytic proteins. In the serum 98–99.5% of the sex steroids are protein-bound and endocytosis is quantitatively more relevant for tissue delivery of biologically active steroid

hormones than free diffusion. Until now several different ways have been described how steroids can enter the target cells and it is still under debate which of these are the most relevant pathways to take up all kinds of steroids.

SHBG not only binds testosterone but also estradiol. The type of binding is influenced by the different SHBG isoforms, but generally testosterone binds threefold higher than estradiol to SHBG. For example, it could be demonstrated that post-translational changes in the carbohydrate structure of SHBG can lead to different binding affinity of the protein to testosterone or estradiol. SHBG concentration in serum is under hormonal regulation and primarily regulated through opposing actions of sex steroids on hepatocytes, estrogen stimulates and androgen inhibits SHBG production. Other hormones such as thyroid hormones are also potent stimulators of SHBG production. SHBG concentration in men is about one third to one half of the concentration found in women. In normal, healthy men with an intact hypothalamo-pituitary-testicular axis, an increase in plasma concentrations of SHBG leads to an acute decrease of free testosterone and simultaneous stimulation of testosterone synthesis, persisting until achievement of normal concentrations. SHBG concentrations can be elevated in hypogonadal men.

2.6.3 Extratesticular Metabolism of Testosterone

Testosterone is a precursor of two important hormones: through 5α -reduction it gives rise to the highly biologically (three to sixfold compared to testosterone) active hormone **5α -dihydrotestosterone (DHT)**, and through aromatization to **estradiol**. The **half-life of testosterone** in plasma is **only about 12 min**. Estrogens influence testosterone effects by acting either synergistically or antagonistically. Moreover, estrogens have other specific effects which were originally described to be typical of testosterone. It has been found that inactivating mutations of the estrogen receptor or aromatase, preventing estrogen action on the bones, result in continuous linear growth and lack of epiphyseal closure.

Low levels of bioavailable estrogen and testosterone are strongly associated with high bone turnover, low bone mineral density and high risk of osteoporotic

fractures. In aromatase-knockout and estrogen receptor-knockout male mice an association between impaired glucose tolerance with insulin resistance and lack of estrogens with elevated testosterone concentrations have been found (Takeda et al. 2003). It also seems that aromatase deficiency in men is associated with the occurrence of insulin resistance and diabetes mellitus type 2 during high-dose testosterone treatment (Maffei et al. 2004). The impairment of the estrogen to testosterone ratio is thought to be responsible for the development of impaired glucose tolerance and insulin resistance in aromatase deficiency patients receiving testosterone replacement therapy. An imbalance in the ratio of estrogen to androgen tissue levels is also postulated as a major cause in the development of gynecomastia. Furthermore recent investigations have shown a local neuroprotective effect of newly aromatized estradiol on the brain.

Reduction of testosterone to DHT occurs in the endoplasmic reticulum through the enzyme 5α -reductase which is in the microsomes of the cell. Both testosterone and DHT bind to the same intracellular androgen receptor to regulate gene expression in the target tissue. Although they interact with the same androgen receptor, testosterone and DHT produce distinct biological responses and the molecular mechanisms are still under debate. Two isoforms of 5α -reductase could be identified in humans by NADPH-dependent enzymes reducing the double bond at the four to five position in C 19 steroids as well as C 21 steroids. The gene for 5α -reductase type I is located on chromosome 5 encoding for a protein with 259 amino acids, while the gene for the 5α -reductase type II is on chromosome 2 encoding for a slightly shorter protein with 254 amino acids.

The two isoforms are very similar to each other, but show different biochemical properties. Type I enzyme works optimally at an alkaline pH, while the optimal pH for type II is acidic. Also, the tissue distribution of the two forms is different. Type I 5α -reductase has been localized in the non-genital skin, liver, brain prostate, ovary and testis, while type II is mainly active in classical androgen-dependent tissues, such as the epididymis, genital skin, seminal vesicle, testis and prostate but also in liver, uterus, breast, hair follicles and placenta.

At the cellular level, DHT sustains differentiation and growth and is particularly important for normal sexual development and virilization in men. It also affects the muscle mass and the deepening of the voice.

DHT transactivates the androgen receptor leading to gene transcription in the prostate and its growth.

Overall, testosterone effects result from influences of the hormone itself and of its metabolites estradiol and DHT. Changes in the property of type II 5 α -reductase due to mutation can result in complete androgen insensitivity syndrome (CAIS) or partial androgen insensitivity syndrome (PAIS). DHT is eliminated by type 3 α -HSD (aldo-keto reductase (AKR) 1C2) which reduces 5 α -DHT to 3 α -androstenediol. Studies in men have demonstrated that 3 α -androstenediol can be converted back to 5 α -DHT to stimulate growth of the prostate by a short-chain dehydrogenase/reductase called RoDH like 3 α -HSD (Penning 2000). In human tissues five aldo-keto reductase isoforms (AKR) exist with varying reductase activity on the 3-, 17- and 20-ketosteroid position with isoform (AKR1C2) predominately converting 5 α -DHT to 3 α -diol. The inactivated metabolites are excreted in the urine.

Some androgen metabolites are excreted in free form, others are glucuronated by the liver before excretion. Recently excreted metabolites have been used in screening assays to uncover doping with exogenous testosterone esters in high-performance athletics (Saudan et al. 2006). The 17-glucuronidation of the DHT metabolite androstane-3 α , 17 β -diol is correlated with several metabolic risk factors in men. The ratio of 17G to DHT is associated with total fat mass, its distribution, intrahepatic fat, disturbed lipid profile, insulin resistance, and diabetes (Vandenput et al. 2007).

2.6.4 Mechanism of Androgen Action

Testosterone dissociates from SHBG at the target organ and diffuses into the cells. The conversion of testosterone into DHT is organ-dependent. This occurs, for example, in the prostate, where DHT is the main biologically active androgen. Hydroxysteroid dehydrogenases regulate ligand access to the androgen receptor in the human prostate. The first step in androgen action is binding to the androgen receptor which belongs to the family of steroid hormone receptors (Fig. 2.17). Together with RoDH the hydroxysteroid dehydrogenases are involved in the pre-receptor regulation of androgen action. The mechanism through which the androgen receptor and other nuclear

receptors act as transcriptional factors has a general mechanism in which they bind to their ligand cytosolically, inducing conformational changes, loss of chaperones, dimerization, and nuclear translocation. In the nucleus both (ligand and nuclear receptor) bind to specific sequences of genomic DNA and induce stimulation of RNA synthesis. Chromatin remodeling such as modification of histones plays a role in gene transcription, and many nuclear receptor interacting co-regulators perform significant roles in gene transcription. Mineralocorticoid, glucocorticoid, thyroid hormone, retinol, fatty acid metabolite, estrogen and progesterone receptors also belong to this family. Currently 48 nuclear receptors have been identified in humans [reviewed in (Kishimoto et al. 2006)]. These receptors share substantial functions and are thought to have evolved from a single ancestral gene (Bertrand et al. 2004). Orphan nuclear receptors have also been found for which no ligand has yet been identified. Members of this receptor family possess an N-terminal domain, a DNA-binding domain, a hinge region and a hormone-binding domain (Fig. 2.18).

Nuclear receptors have several functional domains, a constitutionally activating function domain, a highly conserved DNA-binding domain, a nuclear localization signal domain and a ligand binding domain. Steroid receptors show high homology with the corresponding DNA-binding and ligand-binding domains in the mineralocorticoid, glucocorticoid and progesterone receptors. In contrast, at the N-terminal domain little similarity with these receptors remains. The nuclear receptors are subdivided into two subfamilies depending on their ligand partners' forming homodimers such as the androgen receptor and other steroid receptors; another subfamily form heterodimers with only one ligand, such as the thyroid hormone receptor. In most nuclear receptors the binding in a pouch to their ligand at the C-terminal end made of 12 α -helices, leads to a shift of the most C-terminal α -helix and to a change of the activation activity. Inside the 12 helices a hydrophobic cave is induced to change its formation and angle in which the helix 12 changes. This angle is associated with transactivation status of the receptor.

An important characteristic of the N-terminal domain of the androgen receptor is the presence of short tandem repeats (STRs) CAG, coding for polymorphic polyglutamine, TGG repeats coding for polyproline and GGC repeats for polyglycine. In normal

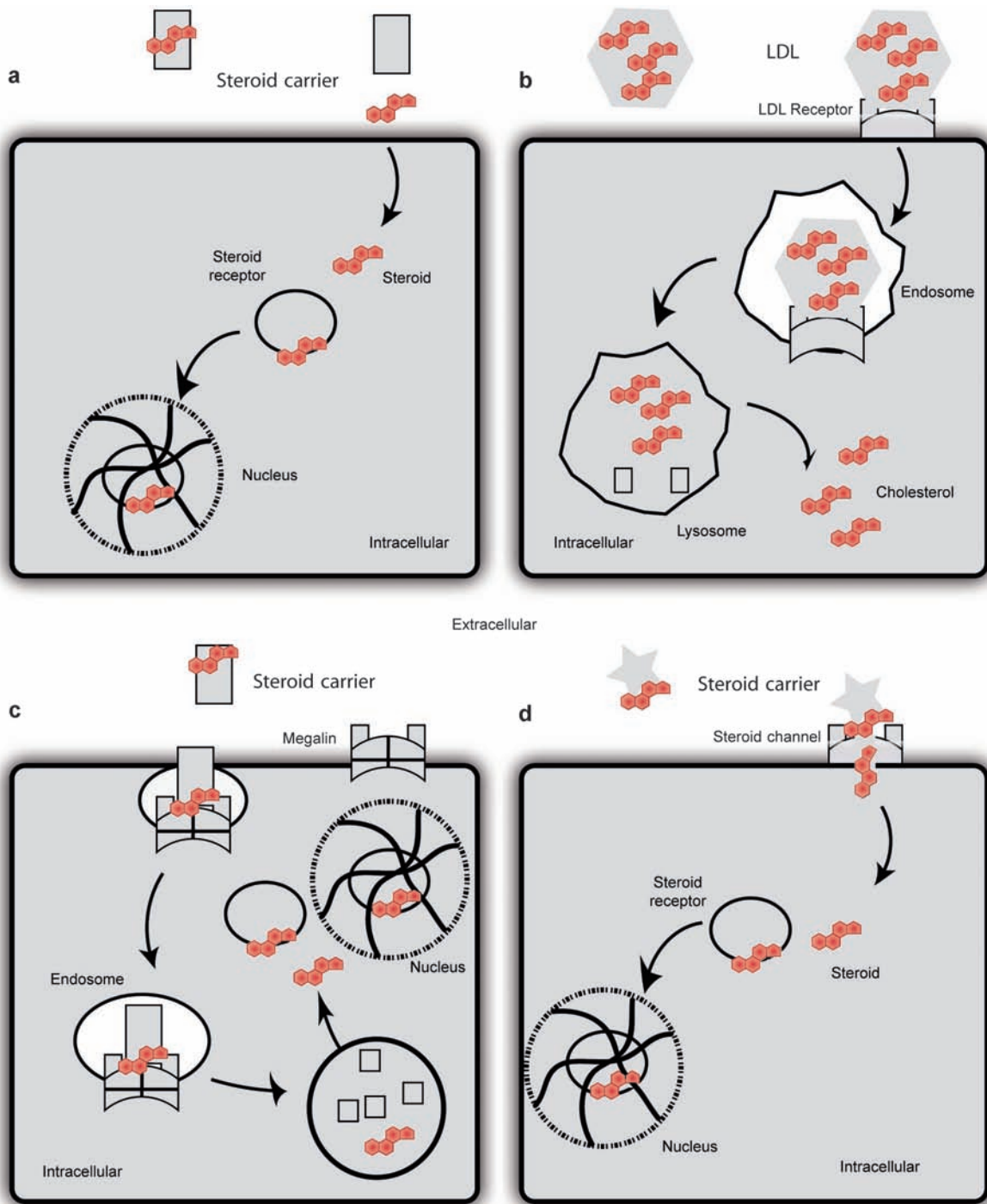

Fig. 2.17 Mechanisms by which steroidal hormones can enter cells. (a) The steroid hormone diffuses freely across the cell membrane, binds to an intracellular receptor and enters the nucleus to regulate gene expression. (b) Receptor-mediated endocytosis of steroid containing lipophilic molecules. The lipoprotein LDL binds its receptor and is taken up, degraded in lysosomes and the steroid cholesterol can enter different metabolic

pathways. (c) Receptor-mediated endocytosis of steroids. The entire hormone-carrier is incorporated by endocytosis after binding to a carrier protein. Following intracellular degradation of the carrier, the ligand hormone is released into the free cytoplasm. (d) Transport-mediated uptake of molecules through the membrane. The steroid-carrier is recognized by a membrane receptor and the ligand is transported into the cell

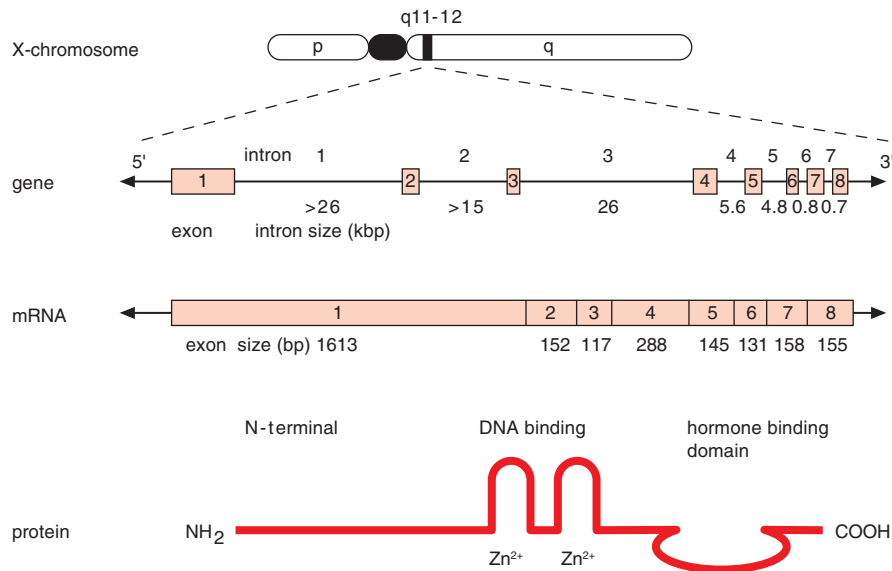

Fig. 2.18 Organization of the androgen receptor and chromosomal localization of the androgen receptor and structure of the androgen receptor gene and protein. *Upper* figure: the gene for the androgen receptor is localized in the pericentromeric region of chromosome X, at the site Xq11–12. *Middle* figure: the entire gene encompasses a region of about 90 kilobase pairs (kbp) on genomic DNA. Different exons are represented by boxes 1–8, with corresponding intron sizes reported below. Exon 1 encodes

the N-terminal region, exon 2–3 the DNA binding domain and exon 4–8 the steroid binding domain. *Lower* figure: schematic representation of the androgen receptor protein with the different functional domains. The genome spans more than 80 kb of chromosome X with eight exons. In exon 1 short tandem repeat regions (Gln and Gly). The protein structure consists of a transcription regulation domain, a DNA-binding domain, a hinge region and the androgen binding region

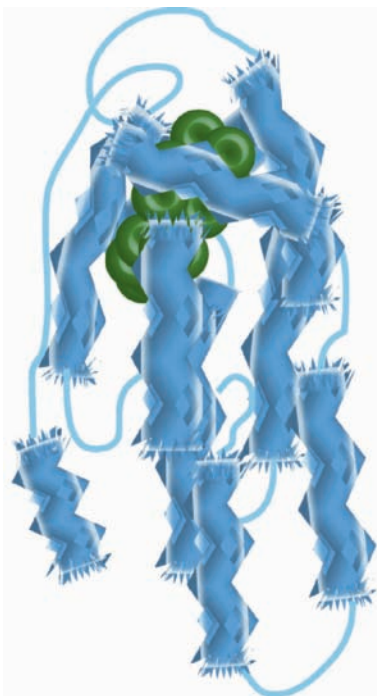

Fig. 2.19 Model of the androgen receptor binding pouch. Twelve α -helices (blue) open up a gap into which the steroid (green) can slip. Thereby one helix turns its angle and upregulates the activity of the entire receptor

men, about 17–29 glutamine repeats and 13–17 glycine repeats are present. Alleles of small GGC size have been associated with esophageal cancer, while in patients with Kennedy disease, a disease with degenerating motoneurons, up to 72 such glutamine repeats are present. Furthermore, in the androgen receptor long CAG and GGC alleles are associated with decreased transactivation function and have been associated with cancers in women. In the androgen receptor a low size CAG (<19 repeats) and GGC (<15 repeats) alleles result in higher receptor activity, and have been associated with earlier age of onset, and a higher grade and more advanced stage of prostate cancer at the time of diagnosis. The number of glutamine repeats of the androgen receptor has been associated with azoospermia or oligozoospermia but no clear association was found (Asatiani et al. 2003).

The androgen receptor gene (Fig. 2.18) encoding for two isoforms is located on the X-chromosome and spans about 90 kb and codes for a 2,757-base pair open reading frame within a 10.6-kb mRNA. The location of the androgen receptor gene on the X chromosome is preserved in evolutionary distant animals, such as marsupials and monotremes, and may reflect a developmentally significant association of the androgen

receptor gene with other systemic genes. The coding sequence, containing the sequence of nucleotides translated into amino acids, consists of eight exons. The N-terminal domain, the transcriptional regulatory region of the protein, is fully encoded by exon 1, while DNA-binding domain is encoded by exon 2 and 3 and steroid-binding domain by exons 4–8.

Similar to all the other steroid receptors, the DNA-binding domain of the androgen receptor contains two zinc fingers. This domain is about 70 amino acids long and is localized between the N-terminal and the androgen-binding domain. In this part of the sequence, eight cysteines are spatially arranged such that four sulphurs keep one zinc in place, giving rise to the typical structure of two overlapping helices. Exon 2 and 3 of the androgen receptor encode for the DNA-binding domain. The first zinc finger, encoded by exon 2, is important for the specific binding of the androgen receptor to the second and fifth nucleotide pairs in the first androgen-response element repeat GGTACA of the DNA. The second zinc finger, encoded by exon 3, stabilizes DNA receptor binding by hydrophobic interactions with the first finger and contributes to specificity of receptor DNA binding, leading to dimerization of two receptor molecules. In immediate proximity to the DNA binding domain, a short amino acid sequence is responsible for the transport of the receptor into the nucleus.

The androgen-binding domain of the androgen receptor encompasses about 30% of the overall receptor (the DNA-binding domain about 10%) and is responsible for the specific binding of androgens. This domain forms a lipophilic pocket based upon 24 amino acids that enables the binding of testosterone or other androgens (Fig. 2.19). Experimental deletion of this domain results in increased gene transcription *in vitro*. This part of the receptor is necessary for inducible and regulated gene transcription. Regulation of steroid hormone receptor action occurs, in part, by posttranslational modifications, such as phosphorylation. The androgen receptor is phosphorylated at a number of sites in response to agonist binding that results in nuclear localization, but usually not in response to antagonists. It has also been shown that phosphorylation is regulated by steroid hormones or forskolin and phorbol esters at different sites. DHT binds to the androgen receptor with higher affinity than testosterone, mainly because testosterone more quickly dissociates from the receptor again. Other steroids such as androstenedione, estradiol and progesterone bind to the androgen receptor with much lower affinity than testosterone. The phosphorylation in

the hinge region required for full transcriptional activity is involved in the signal transduction mediated by cyclic AMP and protein kinase C.

Chaperones such as heat shock protein 90 (HSP 90) are responsible for the maintenance of the receptor in the inactive state and are released from the complex. Without its hormone ligand the androgen receptor can bind to homologous or heterologous ligands in the cytoplasm and exert inhibitory effects on cell death processes. The loss of this protein has uncovered functional domains of the receptor and is necessary for nuclear transport. The nuclear transport is mediated by import receptors through a pathway that employs two proteins, importin- α and importin- β . In this nuclear-protein-import pathway, the positively charged nuclear localization signal of the androgen receptor is recognized in the cytoplasm by importin- α that serves as an adaptor to the nuclear transport factor importin- β . The importin- α -importin- β androgen receptor complex then moves through nuclear-pore complexes and dissociates mediated by a GTPase protein, thus releasing the androgen receptor inside.

The actual interaction with the DNA occurs through the two zinc fingers in the DNA-binding domain of the androgen receptor. The androgen receptor interacts with DNA in a homodimeric form consisting of two identical hormone receptor complexes. These homodimers bind to DNA sequences known as androgen responsive elements which contain typical palindromic sequences, i.e., DNA tracts with a nucleotide sequence independent of the reading direction. Before it can bind to the DNA, covalent modifications of the DNA trapping proteins, the histones, have to occur first. At the N-terminal ends of histones various covalent modifications can be carried out, such as acetylation, phosphorylation, ubiquitination and methylation. Depending on the histone modifications, genes will be either expressed or silenced and the methylation of lysines or arginines has been linked to either transcriptional activation or repression. Lysine residues of the histone tails can be monomethylated, dimethylated or trimethylated. The differentially methylated lysine residues serve as binding sites for various effector proteins which may be co-repressor or co-activators.

The lysine-specific demethylase 1 (LSD1) has the function to silence genes if no nuclear receptor is present but in the opposite case to demethylate histones if such a ligand-activated receptor is docking onto the site. During this step, LSD1 forms a chromatin-associated complex with the ligand-activated androgen

receptor. Another co-activator is needed to start the actual gene expression of the LSD1 chromatin-associated ligand-activated androgen receptor complex. This is again a demethylase (JHDM2A) which is only associated with the DNA in combination with the above-mentioned complex. Two different mechanisms involving demethylases in the transcriptional regulation of the androgen receptor are needed to express androgen target genes (Metzger et al. 2006). The time sequence of events is not known. Up to now many methylation/demethylation enzymes have been found which all may be needed for fine tuning of gene expression. The transcription complex induces mRNA synthesis of androgen-dependent genes and, after mRNA translation, synthesis of new androgen-dependent proteins such as prostate specific antigen (PSA).

The regulation of androgen receptor expression at the transcriptional and translational level is complex and depends on factors such as age, cell type and tissue. Generally, androgens have a positive effect on stabilization of the receptor protein, so that androgen administration leads to inhibition of receptor degradation and thereby to an increase in androgen receptor protein levels. The effects of androgens on the androgen receptor mRNA are opposite. In this case, androgen administration leads to down-regulation of the androgen receptor mRNA by shortening of the mRNA half-life. Current and future activities concentrate on **selective androgen receptor modulators (SARMs)**, analogous to the SERMs for the estrogen receptor. This work leads to a general understanding of structure-activity relationships of new pharmacophores of nonsteroidal SARMs by structural modification of nonsteroidal antiandrogens.

SARM pharmacophores can be classified into four categories so far: aryl-propionamide, bicyclic hydantoin, quinoline, and tetrahydroquinoline analogs. A characteristic of these molecules is that they are not substrates for aromatase or 5α -reductase. The functions of these androgen receptor ligands are intended to act as agonists in anabolic organs (e.g., muscle and bone) but neutral in androgenic tissues (e.g., prostate and seminal vesicles). Other possible molecular mechanisms related to the tissue selectivity of SARMs include ligand-dependent changes in androgen receptor conformation, differential interaction with the promoter context of target tissue genes, and the differential recruitment of coregulators in these tissues. The development stages of these new compounds are now in preclinical animal

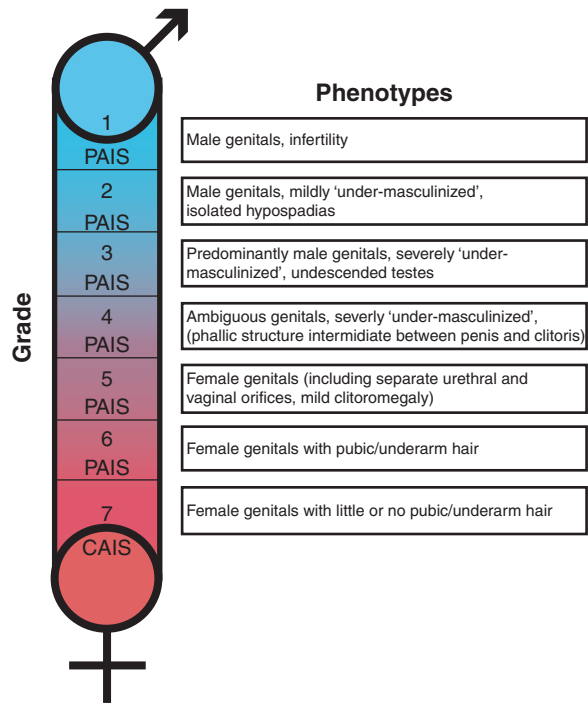

Fig. 2.20 Grading of the different severities of androgen insensitivity. The highest grade (7) is named CAIS (complete) while the lowest form is PAIS grade 1 (partial) (Adapted from Rajender et al. 2007)

trials or already in phase I clinical trials. The hope is that SARMs are of benefit for the treatment of primary or secondary hypogonadism, anemias, osteopenia or osteoporosis, frailty, BPH, and may be also of help in designing a hormonal male contraception method.

Androgen receptor defects such as deletions or inactivating mutations can profoundly alter receptor function. The resulting phenotype is highly variable ranging from undervirilization to testicular feminization. Inactivating mutations of the androgen receptor gene in a 46 XY male with testes resulted in a female phenotype owing to the complete lack of all androgen activity (Fig. 2.20). However, there is no uterus and only a partially formed vagina, and during puberty pubic and axillary hair is scant or absent. This syndrome of complete androgen insensitivity (AIS) was earlier called testicular feminization.

Similar clinical consequences are also typical for mutations which severely damage the function of the androgen receptor, such as those in the DNA-binding or androgen-binding domain. **Partial AIS (PAIS)** is due to mutations in the androgen receptor gene and over 800

mutations have been reported (<http://www.androgendb.mcgill.ca>). Furthermore, mutations which involve co-activators or co-repressors can also lead to PAIS of different severity. Moreover, mutations in the N-terminal domain of the androgen receptor, which can lead to elimination of the androgen receptor function, plays a minor role in male idiopathic infertility (Zuccarello et al. 2008). The mentioned subtle differences in the number of repeats e.g., CAG, or TGG, GGC of ARgen have also been tested for spermatogenic effects. In spite of many efforts to demonstrate that the number of CAG triplets influences the transcriptional activity of the androgen receptor, no clear relationship to disturbances of spermatogenesis has been found in a wide variety of human ethnics (Rajender et al. 2007). Some oligozoospermic and azoospermic men bearing mutations in the ligand-binding domain have also been identified (Zuccarello et al. 2008). Over 120 mutations in the androgen receptor are associated with prostate carcinoma; both in the primary tumor tissue and in

metastases and in very few other cases they have been associated with other cancers, such as testicular carcinoma, or liver and breast cancer.

2.6.5 Biological Actions of Androgens

In primates, the androgen receptor can be found not only in the classical androgen-dependent organs, such as muscles, prostate, seminal vesicles, epididymis and testes, but also in almost every tissue, e.g., hypothalamus, pituitary, kidney, spleen, heart, salivary glands. Hence, testosterone exerts a variety of actions on many body targets (Fig. 2.21)

In the testis, the androgen receptor is expressed in Sertoli cells, peritubular cells, and Leydig cells, while the germ cells seem not to express it. Studies in cell-specific androgen receptor knockout mice demonstrated that the Sertoli cells require androgen for the

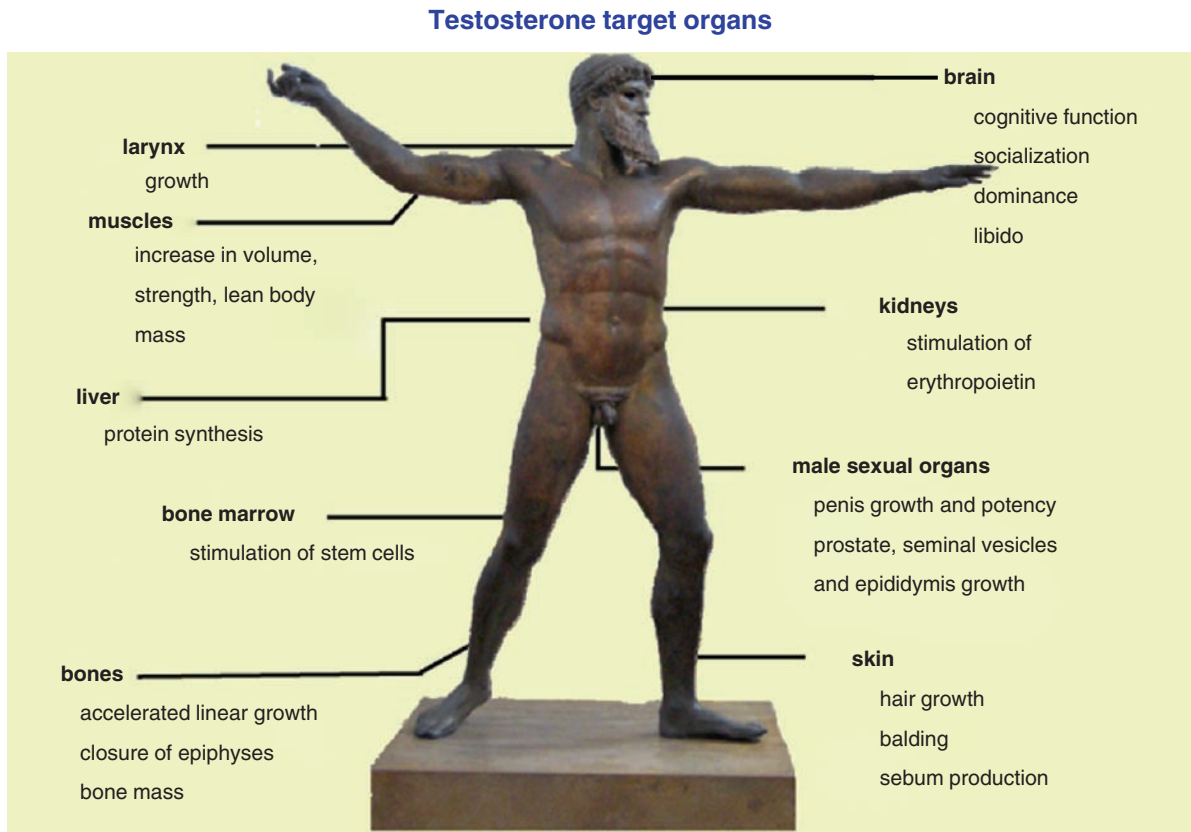

Fig. 2.21 Targets of testosterone action in the male

maintenance of complete spermatogenesis, and that spermatocyte and spermatid development depends on androgens. The peritubular myoid cells maintain their cell contractility, ensuring normal spermatogenesis and sperm output. A functional androgen receptor in Leydig cells is essential to maintain spermatogenesis and testosterone production, and is required for normal male fertility (Chang et al. 2004; Zhang 2006; Xu et al. 2007).

Androgens are important in every phase of human life. During the embryonal stage, testosterone determines the differentiation of the sexual organs, during puberty, the further development toward the adult male phenotype which is then maintained along with important anabolic functions. DHT is the main androgen acting on epididymis, vas deferens, seminal vesicles and prostate, originating from testosterone through 5α -reductase. These tissues are particularly dependent on continuous androgen action. In addition, testosterone aromatization to estrogens plays an important role in prostate growth. Estrogen concentrations in prostate stromal tissue are clearly increased in case of benign prostate hyperplasia (BPH). Estrogens, acting in synergy with androgens and the estrogen receptor β , are required to regulate the proliferative and antiproliferative changes that occur during normal prostate development and differentiation. In the epididymis, the seminal vesicles and the vas deferens a lack of testosterone can result in regression of the secretory epithelia, eventually leading to aspermia (ejaculation failure). The androgen effects in these organs are mediated through testosterone, DHT and estradiol.

Both testosterone and DHT are necessary for normal penis growth, which is positively correlated with the increasing testosterone concentrations during puberty. The masculinization of Wolffian ducts is primarily caused by testosterone, whereas the transformation of the external genitalia, urethra, and prostate is primarily due to DHT. However, androgen receptors are no longer expressed in the penis of adult men and any androgen deficiency after puberty results in only minor decrease of penis size. Similarly, testosterone administration to adults is not capable of increasing penis size.

Testosterone is the main androgen present in muscles, which have very low 5α -reductase activity. Skeletal muscles are capable of converting circulating dehydroepiandrosterone (DHEA) to testosterone and estrogen. Furthermore it is discussed whether skeletal muscle cells even synthesize DHT which

activates the glucose metabolism-related signaling pathway. Testosterone has direct anabolic effects both on smooth and striated muscles with an increase of muscular mass and hypertrophy of the fibers. In modern sports these effects have led to an abuse of these steroids to increase the muscle mass in both sexes. The number of muscular fibers, however, does not change. Loss of testosterone can lead to muscular atrophy. As a consequence of testosterone action, mRNA synthesis and glycogen synthesis increase in the striated muscles. Testosterone also has an anabolic effect the heart, increasing mRNA synthesis.

Both androgens and estrogens induce an increase of bone density by stimulating mineralization, while the lack of these steroids results in osteoporosis. The skeleton develops distinctly in males and females, particularly at the periosteal surface. Sex differences in skeletal morphology and physiology occur at or around puberty, with little effect of gonadal steroids prior to puberty. At the beginning of puberty, the increase in linear growth of bones is directly correlated with increasing testosterone concentrations. It is discussed that gender differences, particularly with respect to 'bone quality' and architecture (i.e., predominantly bone width) are modulated by the balance of the sex steroids estrogen and androgen. At the end of puberty, depending on the presence of testosterone, epiphyseal closure occurs, an event that can be consistently delayed in the presence of low testosterone concentrations. Low testosterone is associated with increased risk of fracture, particularly with hip and nonvertebral fractures. It is clear now that the androgen action on bone metabolism is mediated through estradiol. Serum estradiol and testosterone contribute to bone turnover rate, with testosterone increasing bone formation, and estradiol suppressing both bone formation and resorption. Conversely, the administration of high testosterone doses can induce precocious epiphyseal closure. This effect can be used therapeutically in cases of excessively tall stature. Moreover, serum SHBG seems to be an independent positive predictor of bone turnover rate (Valimaki et al. 2004).

The effect of androgens on skin and dependent organs vary in the different cutaneous districts and are mediated by testosterone and, probably, DHT. Depending on testosterone, the growth of sebaceous glands can be stimulated and **sebum production** in the face, upper part of the back and in the skin of the chest can be induced. Testosterone contributes to the development of acne vulgaris, while estrogens can diminish

sebum concentration. The effects of DHT and testosterone on the **hair** are influenced by the androgen sensitivity of the hair follicle. DHT stimulates the expression of nitric oxide synthase in human dermal papilla cells, suggesting that nitric oxide works as a signaling molecule and implies androgen-mediated nitric oxide production to be involved in the regulation of hair follicle activity. While **axillary hair** and the lower part of **pubic hair** start growing even in the presence of low androgen concentrations, much higher androgen levels are necessary for the growth of **beard**, upper part of the pubic hair and chest hair. The hair-line is determined both by genetic factors and individual distribution of the androgen receptor and depends on the androgen milieu. High 5α -reductase activity has been observed in bald men, while in patients with 5α -reductase deficiency or hypogonadism there is no regression of the hair line. Since the growth of the scalp hair is related to increased 5α -reductase activity, increased activity of this enzyme with consequences for hair loss could be an expression of the precocious aging of the hair follicles. Androgens stimulate hair follicles to alter hair color and size via the hair growth cycle and seem to reduce alopecia (Randall et al. 2008).

During puberty, there is a testosterone-dependent growth of the length of the *larynx* of about 1 cm. This size increase, together with the length and mass of the vocal cords, leads to a lowering of vocal register. To maintain a high soprano voice, young males in the sixteenth–nineteenth century were castrated before puberty. A deep voice is directly related to androgens so that a lower register can also be induced in women by testosterone treatment. The depth of voice in a man is correlated with the duration of the pubertal phase after which the androgen receptors are lost. Once reached, register remains unchanged and no modification of the voice can be obtained after puberty in hypogonadal patients. The gender-specific change of the vocal register is correlated with the degree of mineralization in human thyroid cartilage. This modification is linked with the expression of the enzyme alkaline phosphatase. Few chondrocytes near the mineralization front are positive for the androgen receptor and also for alkaline phosphatase, suggesting an involvement in androgen mediated thyroid cartilage mineralization (Claassen et al. 2006).

In the **central nervous system** (CNS) testosterone can be either aromatized or reduced to DHT.

The individual activities of the different enzymes and distribution of receptors are not homogeneous in the CNS, but rather vary according to the brain region. During the intrauterine period a boy's brain develops in the male direction induced by testosterone, and in a girl in the female direction through its absence. The gender identity, the sexual orientation, and other CNS controlled behaviors are programmed at this early period of development. Androgens are also important for other male characteristics such as aggressive behavior, initiative and concentration capacities. Women have different mechanisms to exert these character traits. A connection with spatial orientation and mathematical and composition skills are still under discussion. There is a close relationship between androgen milieu and normal corporeal and spiritual performance and activity as well as good general mood and self-confidence. The frequency and presence of sexual phantasies, morning erections, frequency of masturbation or copulation and sexual activity are related to blood testosterone concentrations in the normal-to-subnormal range. Conversely, androgen deficiency is often accompanied by loss of interest, lethargy, depressive mood, loss of libido and sexual inactivity. Furthermore in the adult, testosterone in the brain is neuroprotective. Although the role of testosterone in the CNS is still poorly understood, evidence suggests that testosterone could be helpful in the treatment of cognitive diseases, including dementia and may influence motor neuron regeneration in adulthood. Testosterone appears to activate a distributed cortical network and addition of testosterone may improve spatial cognition in younger and older hypogonadal men. As already mentioned reduced testosterone is associated with depressive disorders and depends upon the androgen receptor genotype (Zitzmann 2006).

The function of the **liver** is also influenced by steroid hormones. A sexual dimorphism is known both for protein synthesis in the liver and for many liver enzyme systems. This is reflected by the existence of different reference ranges for hepatic enzymes depending on the sex. As far as protein production is concerned, estrogens and testosterone/DHT have often antagonist effects, e.g., on SHBG synthesis. Testosterone and estrogens, however, can also have synergistic effects, for example on α -1-antitrypsin.

The influence of androgens on the **hematopoietic system** is twofold. Through the androgen-dependent, receptor-mediated erythropoietin synthesis there is a

stimulation of erythrocyte production. Androgens also directly affect the hematopoietic stem cells and lead to increased synthesis of hemoglobin. These effects can also be demonstrated in vitro on the granulopoietic and thrombopoietic stem cells, although the role of androgens in this field is still unclear.

There is substantial evidence that androgens may play a role in determining sex-specific **blood pressure**. It is well known that sclerosis of the coronary arteries is one of the most frequent causes of death in Western industrialized countries and that the risk of contracting this disease is twice as high in men compared to women. For this sex-dependent disease, differences in hormone secretion between sexes are supposed. Androgen binding sites can be found in the area postrema and in the preoptic region, suggested to regulate in part blood pressure and heart rate. Therefore, sex-dependent differences in blood pressure might partly result from a sexually dimorphic pattern of the brain which determines central blood pressure regulation.

Suppression of testosterone concentrations in serum leads to a subsequent increase in high density lipoprotein (HDL) concentrations. Influences of testosterone and estradiol on coagulation and fibrinolysis are also discussed. Androgen deficiency is associated with an elevation of the levels of plasminogen activator type 1 which, in turn, can lead to decreased fibrinolysis. While testosterone treatment seems to decrease vascular tone but the long-term effects appear to be vasoconstriction via upregulation of thromboxane A2 expression, norepinephrine synthesis, angiotensin II expression, and endothelin-1 action. Furthermore, androgens are discussed to affect atherosclerosis, vascular remodelling and induce renal prohypertensive processes involving the renin-angiotensin-aldosterone system. The effects of sex hormones on different parts of the renal-vascular system are often contradictory.

Metabolic syndrome is associated with weight gain, diabetes type II and androgen deficiency in men. Cross-sectional studies have found that between 20% and 64% of men with diabetes have hypogonadism, with higher prevalence rates found in aging men. The mechanisms leading to these diseases include change in body composition, androgen receptor polymorphisms, glucose transport, and reduced antioxidant effects. Conversely, diabetes and the metabolic syndrome are also risk factors for hypogonadism through similar mechanisms, body weight change, decreased

sex hormone binding globulin levels, suppression of testosterone production, and increased aromatase activity contributing to relative estrogen excess.

2.6.6 Androgen Secretion and Sexual Differentiation

Sexual dimorphism precedes gonadal development, in a pregonadal stage. Sex determination is primarily under genetic control and is mediated by the “sex determining gene on the Y chromosome” (Sry) and other transcription factors (Fig. 2.21). It has been shown that the Sry gene and others are already expressed at the one-cell stage and also in the blastocyst stage, enabling these genes to trigger the sex determination cascade. Reproductive development is driven by the production of hormones in the male, or their absence in the female. These factors govern testicle formation and male germ cell development but this gene is neither necessary nor sufficient for testis induction. There is growing evidence supporting the hypothesis that the gene SOX-9 (SRV HMG-box-related gene 9) is necessary as the testis inducer gene. 46XY individuals with the condition of campomelic syndrome caused by haploinsufficiency of SOX-9 show a partial sex reversal. Duplication of SOX-9 is coupled to masculinization in an XX fetus, and mouse XX Sox-9 transgenics develop as males. SOX-9 regulates Fgf9 expression and Fgf9 is likely to be required to promote the male pathway and suppress the female pathway. Contrary to what was long believed, female development does not occur by default while male development is induced. In fact, a female sex-determining gene is predicted (Fig. 2.22).

Sexual differentiation refers to the hormonal induction and regulation of the maturation of the secondary reproductive organs. During the 1st weeks of gestation, the external genitalia are indistinguishable between the sexes and have the potential of developing in the female or in the male direction. Under the influence of DHT, differentiation of the bipotent structures starts at the 8th week of gestation towards the male phenotype. Hormonal production of differentiated gonads is relevant for differentiation of the internal and external genitalia during fetal life. Antimüllerian hormone (AMH) secreted by Sertoli cells inhibits the development of female internal genitalia (tube, uterus,

Fig. 2.22 Mammalian sex determination. The male-promoting (SOX9 and FGF9) and female-promoting (WNT4 and possibly FST) genes keep the gonad in a bipotential state. In the presence of SRY expression the balance to the male pathway changes and out-competes the female signals. In the absence of SRY and possibly the presence of FOXL2, the female-promoting signals shut down these signals and ovarian differentiation is induced

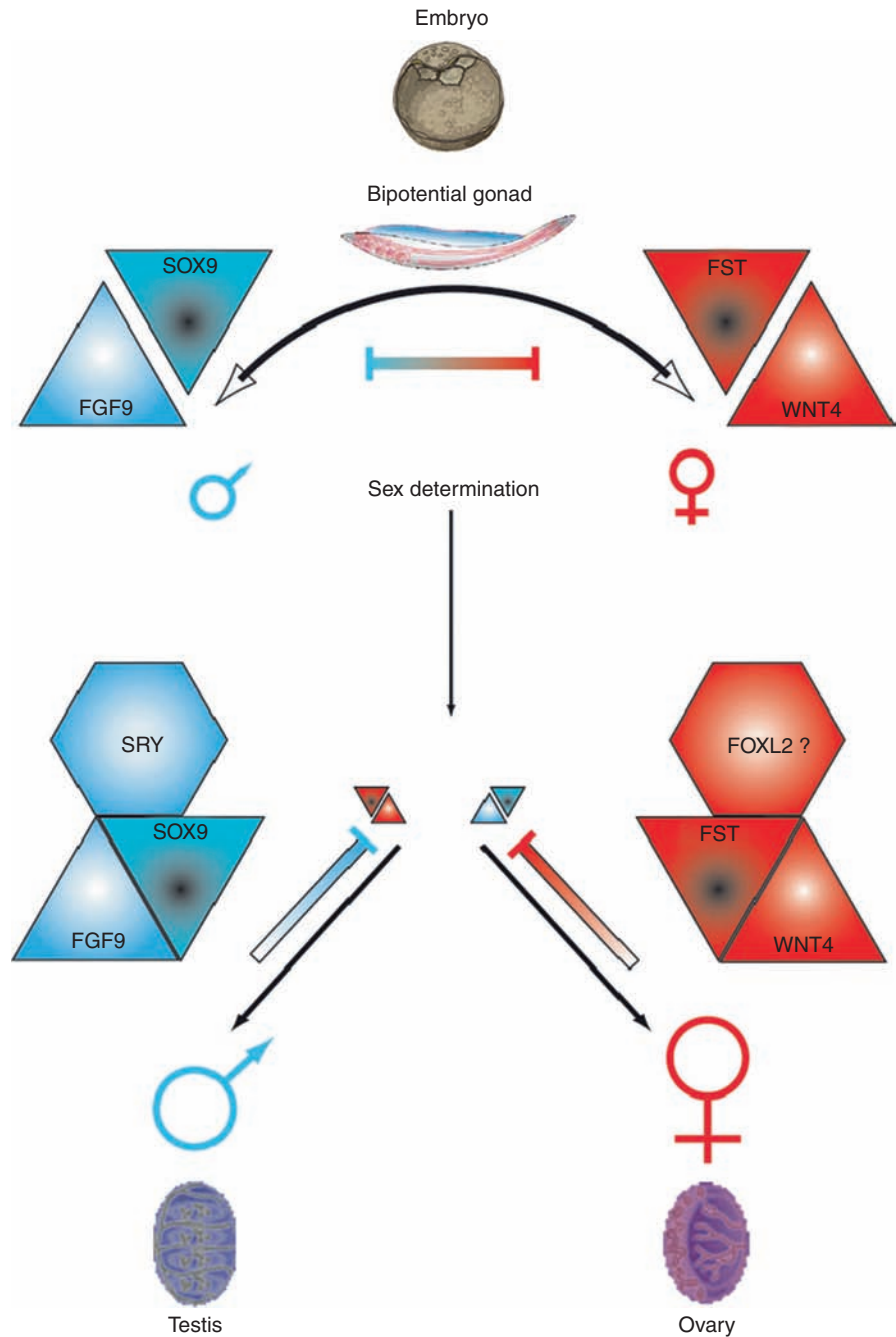

upper part of vagina). Testosterone secreted by Leydig cells induces stabilization of Wolffian ducts and development of internal male genitalia. Differentiation of external male genitalia and the prostate requires the transformation of testosterone to dihydrotestosterone by 5- α -reductase type 2 expressed in genital skin and the urogenital sinus. DHT stimulates prostate

differentiation from this sinus genitalis. After the end of the differentiation process, at about week 14 of gestation, DHT influences the continuous growth of the external sexual organs, in particular the penis. Fetal testosterone production is maximal at the moment of differentiation of the external sexual organs. This occurs between weeks 9 and 14 of gestation, after

which testosterone production decreases. The production of testicular testosterone seems to be mainly induced by hCG, but after the second gestation week, fetal LH assumes the stimulation of the Leydig cells.

In the male newborn, serum testosterone concentrations are comparable to those found in normal adults, decrease then at the end of the 1st week of life, increase again in the 2nd month of life to a new height and fall by the 6th month of life to very low levels such as those found in female babies. Up to the 7th year of life, androgen concentrations in serum are very low, although there is a remarkable increase of free testosterone levels. During this phase, Leydig cells can be stimulated to produce testosterone through the exogenous administration of hCG.

At the age of about 7 years androgen production starts increasing, first due to increased secretion of dehydroepiandrosterone by the adrenal gland (adrenarche). At the age of about 10 years gonadotropin secretion starts, first with pulsatile discharge of LH by the pituitary only during sleeping hours. This nocturnal LH pulsatility becomes progressively evident, also during the day, in the course of pubertal maturation until the pattern typical for the adult man is reached. FSH also starts increasing, along with basal LH and testosterone serum concentrations. The clinical modifications during puberty follow the hormonal modifications in a characteristic sequence.

Normal testosterone concentrations of young men in peripheral serum range between 12 and 30 nmol/l. Testosterone concentrations in blood follow a circadian rhythm with higher levels in the morning hours and about 25% lower levels in the evening. In the aging man a decline of free serum testosterone concentrations occurs but simultaneously the SHBG levels increase. In the case of a strong decrease of testosterone some men develop symptoms of late-onset hypogonadism with clinical consequences such as frailty, changes in body composition, cardiovascular disease, sexual dysfunction and osteoporosis.

References

Alastalo TP, Lonnstrom M, Leppa S, Kaarniranta K, Pelto-Huikko M, Sistonen L, Parvinen M (1998) Stage-specific expression and cellular localization of the heat shock factor 2 isoforms in the rat seminiferous epithelium. *Exp Cell Res* 240:16–27

- Albrecht M, Frungieri MB, Gonzalez-Calvar S, Meineke V, Köhn FM, Mayerhofer A (2005) Evidence for a histaminergic system in the human testis. *Fertil Steril* 83:1060–1063
- Albrecht M, Rämisch R, Köhn FM, Schwarzer JU, Mayerhofer A (2006) Isolation and cultivation of human peritubular cells: A novel model for investigation of fibrotic processes in the human testis and male infertility. *J Clin Endocrinol Metab* 81:1956–1960
- Amann RP (2008) The cycle of the seminiferous epithelium: A need to revisit? *J Androl* 29:469–487
- Amory JK, Page ST, Anawalt BD, Coviello AD, Matsumoto AM, Bremner WJ (2007a) Elevated end-of-treatment serum INSL3 is associated with failure to completely suppress spermatogenesis in men receiving male hormonal contraception. *J Androl* 28:548–554
- Amory K, Wang C, Swerdloff RS, Anawalt BD, Matsumoto AM, Bremner WJ, Walker SE, Haberer LJ, Clark RV (2007b) The effect of 5 α -reductase inhibition with dutasteride and finasteride on semen parameters and serum hormones in healthy men. *J Clin Metab Endocrinol* 92:1659–1665
- Anand-Ivell RJK, Relan V, Balvers M, Coiffec-Dorval I, Fritsch M, Bathgate RAD, Ivell R (2006) Expression of the insulin-like peptide 3 (INSL3) hormone-receptor (LGR8) system in the testis. *Biol Reprod* 74:945–953
- Apa DD, Cayan S, Polat A, Akbay E (2002) Mast cells and fibrosis on testicular biopsies in male infertility. *Arch Androl* 48:337–344
- Asatiani K, von Eckardstein S, Simoni M, Gromoll J, Nieschlag E (2003) CAG repeat length in the androgen receptor gene affects the risk of male infertility. *Int J Androl* 26: 255–261
- Aslam H, Rosiepen G, Krishnamurthy H, Arslan M, Clemen G, Nieschlag E, Weinbauer GF (1999) The cycle duration of the seminiferous epithelium remains unaltered during GnRH antagonist-induced testicular involution in rats and monkeys. *J Endocrinol* 161:281–288
- Bay K, Ivell R, Schumacher M, Jürgensen D, Jorgensen N, Holm M, Skakkebaek NE, Andersson AM (2005) Insulin-like factor 3 serum levels in 135 normal men and 85 men with testicular disorders. Relationship to the luteinizing hormone-testosterone axis. *J Clin Endocrinol Metab* 90: 3410–3418
- Bay K, Matthiesson KL, McLachlan RI, Andersson AM (2006) The effects of gonadotropin suppression and selective replacement on insulin-like factor 3 secretion in normal adult men. *J Clin Endocrinol Metab* 91:1108–1111
- Berensztejn EB, Baquedano MS, Gonzalez CR, Saraco NI, Rodriguez J, Ponzio R, Rivarola MA, Belgorosky A (2006) Expression of aromatase, estrogen receptor α and β , androgen receptor, and cytochrome P-450 in the human early prepubertal testis. *Ped Res* 60:740–744
- Bertrand S, Brunet FG, Escriva H, Parmentier G, Laudet V, Robinson-Rechavi M (2004) Evolutionary genomics of nuclear receptors: From twenty-five ancestral genes to derived endocrine systems. *Mol Biol Evol* 21:1923–1937
- Boepple PA, Hayes FJ, Dwyer AA, Raivio T, Lee H, Crowley WF Jr, Pitteloud N (2008) Relative roles of inhibin B and sex steroids in the negative feedback regulation of follicle-stimulating hormone in men across the full spectrum of seminiferous epithelium function. *J Clin Endocrinol Metab* 93:1809–1814

- Boime I, Ben-Menahem D (1999) Glycoprotein hormone structure-function and analog design. *Recent Prog Horm Res* 54: 271–288
- Bose M, Whittall RM, Miller WL, Bose HS (2008) Steroidogenic activity of STAR requires contact with mitochondrial VDAC1 and PCP. *J Biol Chem* 283:8837–8845
- Bouloux PMG, Nieschlag E, Burger HG, Skakkebaek NE, Wu FCW, Handelsman DJ, Baker GHW, Ochsenuh R, Syska A, McLachlan RI, Giwercman A, Conway AJ, Turner L, van Kuijk JHM, Voortman G (2003) Induction of spermatogenesis by recombinant follicle-stimulating hormone (Puregon) in hypogonadotropic azoospermic men who failed to respond to human chorionic gonadotropin alone. *J Androl* 24:604–611
- Brehm R, Zeiler M, Rüttinger C, Herde K, Kibschull M, Winterhager E, Willecke K, Guillou F, Lecureuil C, Steger K, Konrad L, Biermann K, Failing K, Bergmann M (2007) A sertoli cell-specific knockout of connexin43 prevents initiation of spermatogenesis. *Am J Pathol* 171:19–31
- Burger LL, Haisenleder DJ, Dalkin AC, Marshall JC (2004) Regulation of gonadotropin subunit gene transcription. *J Mol Endocrinol* 33:559–584
- Carreau S, Delalande C, Silandre D, Bourguiba S, Lambard S (2006) Aromatase and estrogen receptors in male reproduction. *Mol Cell Endocrinol* 246:65–68
- Cayan S, Apa DD, Akbay E (2002) Effect of fexofenadine, a mast cell blocker, in infertile men with significantly increased testicular mast cells. *Asian J Androl* 4:291–294
- Chang C, Chen YT, Yeh SD, Xu Q, Wang RS, Guillou F, Lardy H, Yeh S (2004) Infertility with defective spermatogenesis and hypotestosteronemia in male mice lacking the androgen receptor in Sertoli cells. *Proc Natl Acad Sci USA* 101:6876–81
- Cheng CK, Leung PC (2005) Molecular biology of gonadotropin-releasing hormone (GnRH)-I, GnRH-II, and their receptors in humans. *Endocr Rev* 26:283–306
- Claassen H, Monig H, Sel S, Werner JA, Paulsen F (2006) Androgen receptors and gender-specific distribution of alkaline phosphatase in human thyroid cartilage. *Histochem Cell Biol* 126:381–388
- Coviello AD, Matsumoto AM, Bremner WJ, Herbst KL, Amory JK, Anawalt BD, Sutton PR, Wright WW, Brown TR, Yan X, Zirkin BR, Jarow JP (2005) Low-dose human chorionic gonadotropin maintains intratesticular testosterone in normal men with testosterone-induced gonadotropin suppression. *J Clin Endocrinol Metab* 90:2595–2602
- d'Anglemont de Tassigny X, Fagg LA, Dixon JP, Day K, Leitch HG, Hendrick AG, Zahn D, Franceschini I, Caraty A, Carlton MB, Aparicio SA, Colledge WH (2007) Hypogonadotropic hypogonadism in mice lacking a functional Kiss1 gene. *Proc Natl Acad Sci USA* 104:10714–10719
- de Rooij DG (1998) Stem cells in the testis. *Int J Exp Pathol* 79:67–80
- De Roux N, Genin E, Carel JC, Matsuda F, Chaussain JL, Milgrom E (2003) Hypogonadotropic hypogonadism due to loss of function of the KiSS1-derived peptide receptor GPR54. *Proc Natl Acad Sci USA* 100:10972–10976
- Devi YS, Sarda K, Stephen B, Nagarajan P, Majumdar SS (2006) Follicle-stimulating hormone-independent functions of primate Sertoli cells: Potential implications in the diagnosis and management of male infertility. *J Clin Endocrinol Metab* 91:1062–1068
- Dube E, Chan PTK, Hermo L, Cyr DG (2007) Gene expression profiling and its relevance to the blood-testis-barrier in the human epididymis. *Biol Reprod* 76:1034–1044
- Dufourny L, Caraty A, Clarke IJ, Robinson JE, Skinner DC (2005) Progesterone-receptive dopaminergic and neuropeptide Y neurons project from the arcuate nucleus to gonadotropin-releasing hormone-rich regions of the ovine preoptic area. *Neuroendocrinology* 82:21–31
- Eacker SM, Agrawal N, Qian K, Dichek HL, Gong EY, Lee K, Braun RE (2008) Hormonal regulation of testicular steroid and cholesterol homeostasis. *Mol Endocrinol* 22:623–635
- Ehmcke J, Schlatt S (2006) A revised model for spermatogonial expansion in man: lessons from non-human primates. *Reproduction* 132:673–680
- Ehmcke J, Luetjens CM, Schlatt S (2005) Clonal organization of proliferating spermatogonial stem cells in adult males of two species of non-human primates, *Macaca mulatta* and *Callithrix jacchus*. *Biol Reprod* 72:293–300
- Ehmcke J, Wistuba J, Schlatt S (2006) Spermatogonial stem cells: Questions, models and perspectives. *Hum Reprod Update* 12:275–282
- Elhija MA, Potashnik H, Lunenfeld E, Potashnik G, Schlatt S, Nieschlag E, Huleihel M (2005) Testicular interleukin-6 response to systemic inflammation. *Eur Cytokine Netw* 16:167–172
- Emmen JM, McLuskey A, Adham IM, Engel W, Grootegoed JA, Brinkmann AO (2000) Hormonal control of gubernaculum development during testis descent: Gubernaculum outgrowth in vitro requires both insulin-like factor and androgen. *Endocrinology* 141:4720–4727
- Ergün S, Stingl J, Holstein AF (1994a) Segmental angioarchitecture of the testicular lobes in man. *Andrologia* 26: 143–150
- Ergün S, Stingl J, Holstein AF (1994b) Microvasculature of the human testis in correlation to Leydig cells and seminiferous tubules. *Andrologia* 26:255–262
- Evans JJ (1999) Modulation of gonadotropin levels by peptides acting at the anterior pituitary gland. *Endocr Rev* 20:46–67
- Falardeau J, Chung WC, Beenken A, Raivio T, Plummer L, Sidis Y, Jacobson-Dickman EE, Eliseenkova AV, Ma J, Dwyer A, Quinton R, Na S, Hall JE, Huot C, Alois N, Pearce SH, Cole LW, Hughes V, Mohammadi M, Tsai P, Pitteloud N (2008) Decreased FGF8 signaling causes deficiency of gonadotropin-releasing hormone in humans and mice. *J Clin Invest* [Epub ahead of print]
- Fan QR, Hendrickson WA (2005) Structure of human follicle-stimulating hormone in complex with its receptor. *Nature* 433:269–277
- Feng S, Bogatcheva NV, Truong A, Engel W, Adham IM, Agoulnik AI (2006) Over expression of insulin-like 3 does not prevent cryptorchidism in GNRHR or HOXA10 deficient mice. *J Urol* 176:399–404
- Ferlin A, Arredi B, Zuccarello D, Garolla A, Selice R, Foresta C (2006) Paracrine and endocrine roles of insulin-like factor 3. *J Endocrinol Invest* 29:657–664
- Ferris HA, Shupnik MA (2006) Mechanisms for pulsatile regulation of the gonadotropin subunit genes by GNRH1. *Biol Reprod* 74:993–998
- Fijak M, Meinhardt A (2006) The testis immune privilege. *Immunol Rev* 213:66–81
- Foresta C, Bettella A, Vinanzi C, Dabrilili P, Meriggiola MC, Garolla A, Ferlin A (2004) A novel circulating hormone of testis origin in humans. *J Clin Endocrinol Metab* 89: 5952–5958

- Franca LR, Ogawa T, Avarbock MR, Brinster RL, Russell LD (1998) Germ cell genotype controls cell cycle during spermatogenesis in the rat. *Biol Reprod* 59:1371–1377
- Garone LM, Ammannati E, Brush TS, Fischer DJ, Tos EG, Luo J, Altobello KL, Ciampolillo C, Ihley TM, Kurosawa E, Tiebout A, McKenna S (2006) Biological properties of a novel follicle-stimulating hormone/human chorionic gonadotropin chimeric gonadotropin. *Endocrinology* 147:4205–42012
- Ge R, Hardy MP (2007) Regulation of Leydig cells during pubertal development. In: Payne AH, Hardy MP (eds) *The Leydig cell in health and disease*. Humana Press, Totowa, pp 55–70
- Gilfillan AM, Tkaczyk C (2006) Integrated signalling pathways for mast-cell activation. *Nat Rev Immunol* 6:218–230
- Gores PF, Hayes DH, Copeland MJ, Korbutt GS, Halberstadt C, Kirkpatrick SA, Rajotte RV (2003) Long-term survival of intratesticular porcine islets in nonimmunosuppressed beagles. *Transplantation* 75:613–618
- Grigorova M, Punab M, Ausmees K, Laan M (2008) FSHB promoter polymorphism within evolutionary conserved element is associated with serum FSH level in men. *Hum Reprod* 23:2160–2166
- Gromoll J, Simoni M (2005) Genetic complexity of FSH receptor function. *Trends Endocrinol Metab* 16:368–373
- Gromoll J, Simoni M, Nieschlag E (1996) An activating mutation of the follicle-stimulating hormone receptor autonomously sustains spermatogenesis in a hypophysectomized man. *J Clin Endocrinol Metab* 81:1367–1370
- Hales DB (2007) Regulation of Leydig cell functions as it pertains to the inflammatory response. In: Payne AH, Hardy MP (eds) *The Leydig cell in health and disease*. Humana Press, Totowa, pp 305–322
- Hammes A, Andreassen TK, Spoelgen R, Raila J, Hubner N, Schulz H, Metzger J, Schweigert FJ, Luppia PB, Nykjaer A, Willnow TE (2005) Role of endocytosis in cellular uptake of sex steroids. *Cell* 122:751–762
- Hayes FJ, Crowley WF Jr (1998) Gonadotropin pulsations across development. *Horm Res* 49:163–168
- Hedger MP (2002) Macrophages and the immune responsiveness of the testis. *J Reprod Immunol* 57:19–34
- Hibi H, Kato K, Mitsui K, Taki T, Yamada Y, Honda N, Fukatsu H, Yamamoto M (2002) Treatment of oligoasthenozoospermia with tranilast, a mast cell blocker, after long-term administration. *Arch Androl* 48:451–459
- Holstein AF, Maekawa M, Nagano T, Davidoff MS (1996) Myofibroblasts in the lamina propria of human seminiferous tubules are dynamic structures of heterogeneous phenotype. *Arch Histol Cytol* 59:109–125
- Huhtaniemi I (1996) Ontogeny of the luteinizing hormone action in the male. In: Payne ADH, Hardy MP, Russell LD (eds) *The Leydig Cell*. Cache River Press, Vienna, pp 365–382
- Huhtaniemi I, Jiang M, Nilsson C, Petterson K (1999) Mutations and polymorphisms in gonadotropin genes. *Mol Cell Endocrinol* 151:89–94
- Isaac JR, Skinner S, Elliot R, Salto-Tellez M, Garkavenko O, Khoo A, Lee KO, Calne R, Wang DZ (2005) Transplantation of neonatal porcine islets and sertoli cells into nonimmunosuppressed nonhuman primates. *Transplant Proc* 37:487–488
- Jarow JP, Chen H, Rosner TW, Trentacoste S, Zirkin BR (2001) Assessment of the androgen environment within the human testis: Minimally invasive method to obtain intratesticular fluid. *J Androl* 22:640–645
- Jia Y, Hikim AP, Lue YH, Swerdloff RS, Vera Y, Zhang XS, Hu ZY, Li YC, Liu YX, Wang C (2007) Signaling pathways for germ cell death in adult cynomolgus monkeys (*Macaca fascicularis*) induced by mild testicular hyperthermia and exogenous testosterone treatment. *Biol Reprod* 77:83–92
- Johnson L, McKenzie KS, Snell JR (1996) Partial wave in human seminiferous tubules appears to be a random occurrence. *Tissue Cell* 28:127–136
- Junaidi A, Luetjens CM, Wistuba J, Kamischke A, Yeung CH, Simoni M, Nieschlag E (2005) Norethisterone enanthate has neither a direct effect on the testis nor on the epididymis: A study in adult male cynomolgus monkeys (*Macaca fascicularis*). *Eur J Endocrinol* 152:655–661
- Jung A, Schuppe HC (2007) Influence of genital heat stress on semen quality in humans. *Andrologia* 39:203–215
- Kinniburgh D, Anderson RA, Baird DT (2001) Suppression of spermatogenesis with desogestrel and testosterone pellets is not enhanced by addition of finasteride. *J Androl* 22:88–95
- Kim SH, Hu Y, Cadman S, Bouloux P (2008) Diversity in fibroblast growth factor receptor 1 regulation: Learning from the investigation of Kallmann syndrome. *J Neuroendocrinol* 20:141–163
- Kishimoto M, Fujiki R, Takezawa S, Sasaki Y, Nakamura T, Yamaoka K, Kitagawa H, Kato S (2006) Nuclear receptor mediated gene regulation through chromatin remodeling and histone modifications. *Endocr J* 53:157–172
- Kossack N, Simoni M, Richter-Unruh A, Themmen AP, Gromoll J (2008) Mutations in a novel, cryptic exon of the luteinizing hormone/chorionic gonadotropin receptor gene cause male pseudohermaphroditism. *PLoS Med* 5:e88
- Laron Z, Klinger B (1998) Effect of insulin-like growth factor –I on serum androgens and testicular and penile size in males with Laron syndrome (primary growth hormone resistance). *Eur J Endocrinol* 138:176–180
- Lei ZM, Mishra S, Zou W, Xu M, Foltz M, Li X, Rao CV (2001) Targeted disruption of luteinizing hormone/human chorionic gonadotropin receptor gene. *Mol Endocrinol* 15:184–200
- Lerchl A, Keck C, Spiteri-Grech J, Nieschlag E (1993) Diurnal variations in scrotal temperature of normal men and patients with varicocele before and after treatment. *Int J Androl* 16:195–200
- Levalle O, Zylbersztein C, Aszpis S, Aquilano D, Terradas C, Colombani M, Aranda C, Scaglia H (1998) Recombinant human follicle-stimulating hormone administration increases testosterone production in men, possibly by a Sertoli cell-secreted nonsteroid factor. *J Clin Endocrinol Metab* 83:3973–3976
- Li C, Chen P, Smith MS (1999) Morphological evidence for direct interaction between arcuate nucleus neuropeptide Y (NPY) neurons and gonadotropin-releasing hormone neurons and the possible involvement of NPY Y1 receptors. *Endocrinology* 140:5382–5390
- Lindstedt G, Nystrom E, Matthews C, Ernest I, Janson PO, Chatterjee K (1998) Follitropin (FSH) deficiency in an infertile male due to FSHbeta gene mutation. A syndrome of normal puberty and virilization but underdeveloped testicles with azoospermia, low FSH but high lutropin and normal serum testosterone concentrations. *Clin Chem Lab Med* 36:663–665

- Lofrano-Porto A, Casulari LA, Nascimento PP, Giacomini L, Naves LA, da Motta LD, Layman LC (2007) Effects of follicle-stimulating hormone and human chorionic gonadotropin on gonadal steroidogenesis in two siblings with a follicle-stimulating hormone beta subunit mutation. *Fertil Steril* [Epub ahead of print]
- Lopez FJ, Merchenthaler IJ, Moretto M, Negro-Vilar A (1998) Modulating mechanisms of neuroendocrine cell activity: The LHRH pulse generator. *Cell Mol Neurobiol* 18: 125–146
- Lösel RM, Falkenstein E, Feuring M, Schultz A, Tillmann HC, Rossol-Haseroth K, Wehling M (2003) Nongenomic steroid action: Controversies, questions, and answers. *Physiol Rev* 83:965–1016
- Luetjens CM, Weinbauer GF, Wistuba J (2005) Primate spermatogenesis: New insights into comparative testicular organisation, spermatogenic efficiency and endocrine control. *Biol Rev* 80:475–488
- Luetjens CM, Didolkar A, Kliesch S, Paulus W, Jeibmann A, Böcker W, Nieschlag E, Simoni M (2006) Tissue expression of the nuclear progesterone receptor in male non-human primates and men. *J Endocrinol* 189:529–539
- Maffei L, Murata Y, Rochira V, Tubert G, Aranda C, Vazquez M, Clyne CD, Davis S, Simpson ER, Carani C (2004) Dysmetabolic syndrome in a man with a novel mutation of the aromatase gene: Effects of testosterone, alendronate, and estradiol treatment. *J Clin Endocrinol Metab* 89:61–70
- Marshall GR, Ramaswamy S, Plant TM (2005) Gonadotropin-independent proliferation of the pale type A spermatogonia in the adult rhesus monkey (*Macaca mulatta*). *Biol Reprod* 73:222–229
- Matthiesson KL, Amory JK, Berger R, Ugoni A, McLachlan RI, Bremner WJ (2005a) Novel male hormonal contraceptive combinations: the hormonal and spermatogenic effects of testosterone and levonorgestrel combined with 5 α -reductase inhibitor or gonadotropin-releasing hormone antagonist. *J Clin Endocrinol Metab* 90:91–97
- Matthiesson KL, Stanton PG, O'Donnell L, Meachem SJ, Amory JK, Berger R, Bremner WJ, McLachlan RI (2005b) Effects of testosterone and levonorgestrel combined with a 5 α -reductase inhibitor or gonadotropin-releasing hormone antagonist on spermatogenesis and intratesticular steroid levels in normal men. *J Clin Endocrinol Metab* 90:5647–5655
- Matthiesson KL, McLachlan RI, O'Donnell L, Frydenberg M, Robertson DM, Stanton PG, Meachem SJ (2006) The relative roles of follicle-stimulating hormone and luteinizing hormone in maintaining spermatogonial maturation and spermiogenesis in normal man. *J Clin Endocrinol Metab* 91: 3962–3969
- Mayerhofer A, Frungieri MB, Fritz S, Bulling A, Jessberger B, Vogt HJ (1999) Evidence for catecholaminergic, neuronlike cells in the adult human testis: Changes associated with testicular pathologies. *J Androl* 20:341–317
- Meachem S, Nieschlag E, Simoni M (2001) Inhibin B in male reproduction: Pathophysiology and clinical relevance. *Eur J Endocrinol* 145:561–571
- Metzger E, Wissmann M, Schule R (2006) Histone demethylation and androgen-dependent transcription. *Curr Opin Genet Dev* 16:513–517
- Millar RP (2005) GnRHs and GnRH receptors. *Anim Reprod Sci* 88:5–28
- Millar RP, Pawson AJ, Morgan K, Rissman EF, Lu ZL (2008) Diversity of actions of GnRHs mediated by ligand-induced selective signaling. *Front Neuroendocrinol* 29:17–35
- Miller WL (2007) StAR search—what we know about how the steroidogenic acute regulatory protein mediates mitochondrial cholesterol import. *Mol Endocrinol* 21:589–601
- Modi DN, Shah C, Puri CP (2007) Non-genomic membrane progesterone receptors on human spermatozoa. *Soc Reprod Fertil(Suppl 63):*515–529
- Moyle WR, Campbell, RK (1995) Gonadotropins. In: DeGroot JL, Besser M, Burger HG, Jameson LJ, Loriaux DL, Marshall JC, Odell WD, Potts jr JT, Rubenstein AH (eds) *Endocrinology*. Saunders, Philadelphia/London, pp 230–241
- Nagano M, McCarrey JYR, Brinster RL (2001) Primate spermatogonial cells colonize mouse testis. *Biol Reprod* 64:1409–1416
- Naito M, Itoh M (2008) Patterns of infiltration of lymphocytes into the testis under normal and pathological conditions in mice. *Am J Reprod Immunol* 59:55–61
- Narula A, Gu YQ, O'Donnell L, Stanton PG, Robertson DM, McLachlan RI, Bremner WJ (2002) Variability in sperm suppression during testosterone administration to adult monkeys is related to follicle stimulating hormone suppression and not to intratesticular androgens. *J Clin Endocrinol Metab* 87:3399–3406
- Ngan ES, Cheng PK, Leung PC, Chow BK (1999) Steroidogenic factor-1 interacts with a gonadotrope-specific element within the first exon of the human gonadotropin-releasing hormone receptor gene to mediate gonadotrope-specific expression. *Endocrinology* 140:2452–2462
- Nieschlag E, Weinbauer GF, Cooper TG, Wittkowski W, Cantz T (2008) Reproduktion. In: Speckmann E-J, Hescheler J, Köhling R (eds.) *Physiologie 5*. Auflage, Urban & Fischer, München pp 652–677
- Nightingale SS, Western P, Hutson JM (2008) The migrating gubernaculum grows like a “limb bud”. *J Pediatr Surg* 43:387–390
- O'Donnell L, Robertson KM, Jones ME, Simpson ER (2001) Estrogen and spermatogenesis. *Endocr Rev* 22:289–318
- Overstreet JW, Fuh VL, Gould J, Howards SS, Lieber MM, Hellstrom W, Shapiro S, Carroll P, Corfman RS, Petrou S, Lewis R, Toth P, Shown T, Roy J, Jarow JP, Bonilla J, Jacobsen CA, Wang DZ, Kaufman KD (1999) Chronic treatment with finasteride daily does not affect spermatogenesis or semen production in young men. *J Urol* 162:1295–1300
- Palazzolo I, Gliozzi A, Rusmini P, Sau D, Crippa V, Simonini F, Onesto E, Bolzoni E, Poletti A (2008) The role of the polyglutamine tract in androgen receptor. *J Steroid Biochem Mol Biol* 108:245–253
- Penning TM, Burczynski ME, Jez JM, Hung CF, Lin HK, Ma H, Moore M, Palackal N, Ratnam K (2000) Human 3 α -hydroxysteroid dehydrogenase isoforms (AKR1C1-AKR1C4) of the aldo-keto reductase superfamily: Functional plasticity and tissue distribution reveals roles in the inactivation and formation of male and female sex hormones. *Biochem J* 351:67–77
- Phillip M, Arbelle JE, Segev Y, Parvari R (1998) Male hypogonadism due to a mutation in the gene for the beta-subunit of follicle-stimulating hormone. *N Engl J Med* 338: 1729–1732
- Piersma D, Verhoef-Post M, Berns EM, Themmen AP (2007) LH receptor gene mutations and polymorphisms: An overview. *Mol Cell Endocrinol* 260–262:282–A286

- Plant TM, Ramaswamy S, Simorangkir D, Marshall GR (2005) Postnatal and pubertal development of the rhesus monkey (*Macaca mulatta*) testis. *Ann NY Acad Sci* 1061:149–162
- Pöllänen P, Cooper TG (1994) Immunology of the testicular excurrent ducts. *J Reprod Immunol* 26:167–216
- Popa SM, Clifton DK, Steiner RA (2008) The role of kisspeptins and GPR54 in the neuroendocrine regulation of reproduction. *Annu Rev Physiol* 70:213–238
- Prince FP (2007) The human Leydig cell: Functional morphology and developmental history. In: Payne AH, Hardy MP (eds) *The Leydig cell in health and disease*. Humana Press, Totowa, pp 71–90
- Rahman F, Christian HC (2007) Non-classical actions of testosterone: An update. *Trends Endocrinol Metab* 18:371–378
- Rajender S, Singh L, Thangaraj K (2007) Phenotypic heterogeneity of mutations in androgen receptor gene. *Asian J Androl* 9:147–179
- Raleigh D, O'Donnell L, Southwick GJ, de Kretser DM, McLachlan RI (2004) Stereological analysis of the human testis after vasectomy indicates impairment of spermatogenic efficiency with increasing obstructive interval. *Fertil Steril* 81:1595–1603
- Randall VA, Jenner TJ, Hibberts NA, De Oliveira IO, Vafae T (2008) Stem cell factor/c-Kit signalling in normal and androgenetic alopecia hair follicles. *J Endocrinol* 197:11–23
- Romano F, Tripiciano A, Muciaccia B, De Cesaris P, Ziparo E, Palombi F, Filippini A (2005) The contractile phenotype of peritubular smooth muscle cells is locally controlled: Possible implications in male fertility. *Contraception* 72:294–297
- Ruwanpura SM, McLachlan RI, Matthiesson KL, Meachem SJ (2008) Gonadotrophins regulate germ cell survival, not proliferation, in normal adult men. *Hum Reprod* 23:403–411
- Saudan C, Baume N, Robinson N, Avois L, Mangin P, Saugy M (2006) Testosterone and doping control. *Br J Sports Med* 40:21–24
- Schell C, Albrecht M, Mayer C, Schwarzer JU, Frungieri MB, Mayerhofer A (2008) Exploring human testicular peritubular cells: Identification of secretory products and regulation by tumor necrosis factor- α . *Endocrinology* 149:1678–1686
- Schlatt S, Weinbauer GF, Arslan M, Nieschlag E (1993) Appearance of alpha-smooth muscle actin in peritubular cells of monkey testes is induced by androgens, modulated by follicle-stimulating hormone, and maintained after hormonal withdrawal. *J Androl* 14:340–50
- Schlatt S, Arslan M, Weinbauer GF, Behre HM, Nieschlag E (1995) Endocrine control of testicular somatic and premeiotic germ cell development in the immature testis of the primate *Macaca mulatta*. *Eur J Endocrinol* 133:235–247
- Schlatt S, Rosiepen G, Weinbauer GF, Rolf C, Brook PF, Nieschlag E (1999) Germ cell transfer into rat, bovine, monkey and human testis. *Hum Reprod* 14:144–150
- Schulze W, Rehder U (1984) Organization and morphogenesis of the human seminiferous epithelium. *Cell Tissue Res* 237:395–407
- Selva DM, Bassas L, Munell F, Mata A, Tekpetey F, Lewis JG, Hammond GL (2005) Human sperm sex hormone-binding globulin isoform: Characterization and measurement by time-resolved fluorescence immunoassay. *J Clin Endocrinol Metab* 90:6275–6282
- Seminara SB, Messenger S, Chatzidaki EE, Thresher RR, Acierno JS Jr, Shagoury JK, Bo-Abbas Y, Kuohung W, Schwinf KM, Hendrick AG, Zahn D, Dixon J, Kaiser UB, Slaugenhaupt SA, Gusella JF, O'Rahilly S, Carlton MB, Crowley WF Jr, Aparicio SA, Colledge WH (2003) The GPR54 gene as a regulator of puberty. *N Engl J Med* 349:1614–1627
- Setchell BP (1999) Blood-testis barrier. In: Knobil E, Neill JD (eds) *Encyclopedia of Reproduction*. Academic, San Diego, CA, pp 375–381
- Sezer C, Koksall IT, Usta MF, Gulkesen KH, Erdogru T, Ciftcioglu A, Baykara M (2005) Relationship between mast cell and iNOS expression in testicular tissue associated with infertility. *Arch Androl* 51:149–158
- Shetty G, Krishnamurthy H, Krishnamurthy HN, Bhatnagar S, Moudgal RN (1997) Effect of estrogen deprivation on the reproductive physiology of male and female primates. *J Steroid Biochem Mol Biol* 61:157–166
- Shetty G, Krishnamurthy H, Krishnamurthy HN, Bhatnagar AS, Moudgal NR (1998) Effect of long-term treatment with aromatase inhibitor on testicular function of adult male bonnet monkeys (*M. radiata*). *Steroids* 63:414–420
- Shono T (2007) Molecular and anatomical studies of testicular descent. *Hinyokika Kyo* 53:505–508
- Simoni M, Gromoll J, Nieschlag E (1997) The follicle-stimulating hormone receptor: biochemistry, molecular biology, physiology and pathophysiology. *Endocr Rev* 18:739–773
- Skandhan KP, Rajahariprasad A (2007) The process of spermatogenesis liberates significant heat and the scrotum has a role in body thermoregulation. *Med Hypotheses* 68:303–307
- Sridharan S, Simon L, Meling DD, Cyr DG, Gutstein DE, Fishman GI, Guillou F, Cooke PS (2007) Proliferation of adult Sertoli cells following conditional knockout of the gap junctional protein GJA1 (connexin 43) in mice. *Biol Reprod* 76:804–812
- Sriraman V, Anbalagan M, Rao AJ (2005) Hormonal regulation of Leydig cell proliferation and differentiation in rodent testis: A dynamic interplay between gonadotrophins and testicular factors. *Reprod Biomed Online* 11:507–518
- Stelekati E, Orinska Z, Bulfone-Paus S (2007) Mast cells in allergy: innate instructors of adaptive responses. *Immunobiology* 212:505–519
- Suarez-Quian CA, Martinez-Garcia F, Nistal M, Regadera J (1999) Androgen receptor distribution in adult human testis. *J Clin Endocrinol Metab* 84:350–358
- Takaimya K, Yamamoto A, Furukawa K, Zhao J, Fukumoto S, Amashiro S, Okada M, Haraguchi M, Shin M, Kishikawa M, Shiku H, Auzawa S, Furukawa K (1998) Complex gangliosides are essential in spermatogenesis of mice: possible roles in the transport of testosterone. *Proc Natl Acad Sci USA* 95:12147–12152
- Takeda K, Toda K, Saibara T, Nakagawa M, Saika K, Onishi T, Sugiura T, Shizuta Y (2003) Progressive development of insulin resistance phenotype in male mice with complete aromatase (CYP19) deficiency. *J Endocrinol* 176:237–246
- Tena-Sempere M (2008) Ghrelin and reproduction: Ghrelin as novel regulator of the gonadotropic axis. *Vitam Horm* 77:285–300
- Themmen AP, Martens JW, Brunner HG (1998) Activating and inactivating mutations in LH receptor. *Mol Cell Endocrinol* 145:137–142

- Tobet SA, Schwarting GA. (2006) Recent progress in gonadotropin-releasing hormone neuronal migration. *Endocrinology* 147:1159–1165
- Toppari J, Virtanen H, Skakkebaek NE, Main KM (2006) Environmental effects on hormonal regulation of testicular descent. *J Steroid Biochem Mol Biol* 102:184–186
- Valimaki VV, Alfthan H, Ivaska KK, Loyttyniemi E, Pettersson K, Stenman UH, Valimaki MJ (2004) Serum estradiol, testosterone, and sex hormone-binding globulin as regulators of peak bone mass and bone turnover rate in young Finnish men. *J Clin Endocrinol Metab* 89:3785–3789
- Vandenput L, Mellstrom D, Lorentzon M, Swanson C, Karlsson MK, Brandberg J, Lonn L, Orwoll E, Smith U, Labrie F, Ljunggren O, Tivesten A, Ohlsson C (2007) Androgens and glucuronidated androgen metabolites are associated with metabolic risk factors in men. *J Clin Endocrinol Metab* 92:4130–4137
- Virtanen HE, Bjercknes R, Cortes D, Jorgensen N, Rajpert-De Meyts E, Thorsson AV, Thorup J, Main KM (2007a) Cryptorchidism: classification, prevalence and long-term consequences. *Acta Paediatr* 96:611–616
- Virtanen HE, Cortes D, Rajpert-De Meyts E, Ritzen EM, Nordenskjold A, Skakkebaek NE, Toppari J (2007b) Development and descent of the testis in relation to cryptorchidism. *Acta Paediatr* 96:622–627
- von Eckardstein S, Simoni M, Bergmann M, Weinbauer GF, Gaßner P, Schepers AG, Nieschlag E (1999) Serum inhibin B in combination with serum follicle-stimulating hormone (FSH) is a more sensitive marker than serum FSH alone for impaired spermatogenesis in men, but cannot predict the presence of sperm in testicular tissue samples. *J Clin Endocrinol Metab* 84: 2496–2501
- Wang C, McDonald V, Leung A, Superlano L, Berman N, Hull L, Swerdloff RS (1997) Effect of increased scrotal temperature on sperm production in normal men. *Fertil Steril* 68:334–339
- Weinbauer GF, Wessels J (1999) Paracrine control of spermatogenesis. *Andrologia* 31:249–262
- Weinbauer GF, Schlatt S, Walter V, Nieschlag E (2001) Testosterone-induced inhibition of spermatogenesis is more closely related to suppression of FSH than to testicular androgen levels in the cynomolgus monkey (*Macaca fascicularis*). *J Endocrinol* 168:25–38
- Weinbauer GF, Niehaus M, Nieschlag E (2004) The role of testosterone in spermatogenesis. In: Nieschlag E, Behre HM (eds) Testosterone: Action, deficiency, substitution. Cambridge University Press, Cambridge, pp 173–206
- Wikström AM, Bay K, Hero M, Andersson AM, Dunkel L (2006) Serum insulin-like factor 3 levels during puberty in healthy boys and boys with Klinefelter syndrome. *J Clin Endocrinol Metab* 91:4705–4708
- Wistuba J, Schrod A, Greve B, Hodges KJ, Aslam H, Weinbauer GF, Luetjens CM (2003) Organization of the seminiferous epithelium in primates: Relationship to spermatogenic efficiency, phylogeny and mating system. *Biol Reprod* 69:582–591
- Xu Q, Lin HY, Yeh SD, Yu IC, Wang RS, Chen YT, Zhang C, Altuwaijri S, Chen LM, Chuang KH, Chiang HS, Yeh S, Chang C (2007) Infertility with defective spermatogenesis and steroidogenesis in male mice lacking androgen receptor in Leydig cells. *Endocrine* 32:96–106
- Yamazawa K, Wada Y, Sasagawa I, Aoki K, Ueoka K, Ogata T (2007) Mutation and polymorphism analyses of INSL3 and LGR8/GREAT in 62 Japanese patients with cryptorchidism. *Horm Res* 67:73–76
- Yan HH, Mruk DD, Wong EW, Lee WM, Cheng CY (2008) An autocrine axis in the testis that coordinates spermiation and blood-testis-barrier restructuring during spermatogenesis. *Proc Natl Acad Sci USA* 105:8950–8955
- Zannini C, Turchetti S, Guarch R, Buffa D, Psece C (1999) Cell counting and three-dimensional reconstruction to identify a cellular wave in human spermatogenesis. *Ann Quant Cytol Histol* 21:358–362
- Zhang C, Yeh S, Chen YT, Wu CC, Chuang KH, Lin HY, Wang RS, Chang YJ, Mendis-Handagama C, Hu L, Lardy H, Chang C (2006) Oligozoospermia with normal fertility in male mice lacking the androgen receptor in testis peritubular myoid cells. *Proc Natl Acad Sci USA* 103:17718–17723
- Zhengwei Y, McLachlan RI, Bremner WJ, Wreford NG (1997) Quantitative (stereological) study of the normal spermatogenesis in the adult monkey (*Macaca fascicularis*). *J Androl* 18:681–687
- Zhengwei Y, Wreford NG, Royce P, de Kretser DM, McLachlan RI (1998a) Stereological evaluation of human spermatogenesis after suppression by testosterone treatment: heterogeneous pattern of spermatogenic impairment. *J Clin Endocrinol Metab* 83:1284–1291
- Zhengwei Y, Wreford NG, Schlatt S, Weinbauer GF, Nieschlag E, McLachlan RI (1998b) Acute and specific impairment of spermatogonial development by GnRH antagonist-induced gonadotrophin withdrawal in the adult macaque (*Macaca fascicularis*). *J Reprod Fertil* 112:139–147
- Zitzmann M (2006) Testosterone and the brain. *Aging Male* 9:195–199
- Zuccarello D, Ferlin A, Vinanzi C, Prana E, Garolla A, Callewaert L, Claessens F, Brinkmann AO, Foresta C (2008) Detailed functional studies on androgen receptor mild mutations demonstrate their association with male infertility. *Clin Endocrinol (Oxf)* 68:580–588

Physiology of Sperm Maturation and Fertilization

3

Trevor G. Cooper and Ching-Hei Yeung

Contents

3.1 Introduction.....	61
3.2 Development of the Ability of Spermatozoa to Fertilize Eggs During Epididymal Maturation.....	62
3.2.1 Anatomy of the Human Epididymis and Sperm Transport Through It.....	62
3.2.2 Epididymal Secretion and Absorption.....	63
3.2.3 Sperm Maturation in the Human Epididymis: Fertilizing Capacity.....	64
3.2.4 Sperm Maturation in the Human Epididymis: Morphology and Motility.....	65
3.2.5 Sperm Maturation in the Human Epididymis: Interaction with the Egg.....	67
3.2.6 Sperm Storage in the Epididymis.....	69
3.3 Natural Fertilization.....	71
3.3.1 Erection and Ejaculation.....	71
3.3.2 The Ejaculate.....	71
3.3.3 The Basis of Sperm Motility.....	72
3.3.4 Movement of Spermatozoa Through the Female Tract.....	74
3.3.5 Penetration of Spermatozoa Through the Egg Investments.....	75
3.3.6 Fusion of Spermatozoa with the Vitelline Membrane (Oolemma) and Egg Activation....	78
3.3.7 Post-fusion Events.....	79
References.....	80

3.1 Introduction

Fertilization is the event that brings together the cellular content of both haploid gametes in the formation of a new individual.

During intercourse, spermatozoa from the distal cauda epididymidis enter the ejaculate and fertilize the freshly ovulated egg (see Chap. 9). These spermatozoa have to **survive** in the female tract, **move** to the oviduct, **penetrate** the egg investments and **fuse** with the oocyte before they can deliver their **chromatin** into the egg's cytoplasm to have it decondensed, eventually to form a **male pronucleus**, **zygote** and viable **embryo**. These processes are synchronized by a parallel event, **capacitation**, that the spermatozoa undergo while moving through the female tract. The spermatozoon also has to **activate the egg** to permit resumption of the second meiotic division (expelling the **second polar body** and forming the **female pronucleus**) as well as to deliver a centriole that organizes the spindle that draws the male pronucleus to that of the female and forms the first **mitotic spindle** (Figs. 3.1, 3.7), and may provide early embryonic gene transcripts. Investigation of maturing epididymal spermatozoa has indicated that the functional capacity to perform the individual steps of fertilization is developed during epididymal transit.

This chapter examines first the development of relevant sperm functions within the epididymis and second the process of fertilization that this maturation permits. In certain cases of male infertility, spermatozoa can be obtained from more proximal regions of the epididymis or the testis and used in assisted reproductive techniques (ART) that bypass several of the steps necessary during natural fertilization.

T. G. Cooper (✉)
Centre of Reproductive Medicine and Andrology
of the University, Domagkstrasse 11,
D-48129 Münster, Germany
e-mail: TrevorG.Cooper@ukmuenster.de

Fig. 3.1 Scheme of events taken by the fertilizing spermatozoon post-coitum. *Pink rectangular boxes*, sequential events; *grey rectangular boxes*, concomitant events of capacitation, *IUI*, *GIFT*, *IVF*, *SUZI*, *ICSI*, entry points of sperm provided by intra-uterine insemination, gamete intra-Fallopian transfer, in vitro fertilization, sub-zonal insemination, intracytoplasmic sperm injection, respectively. *White boxes*, events undergone by the egg. (+), positive influence (-), negative influence

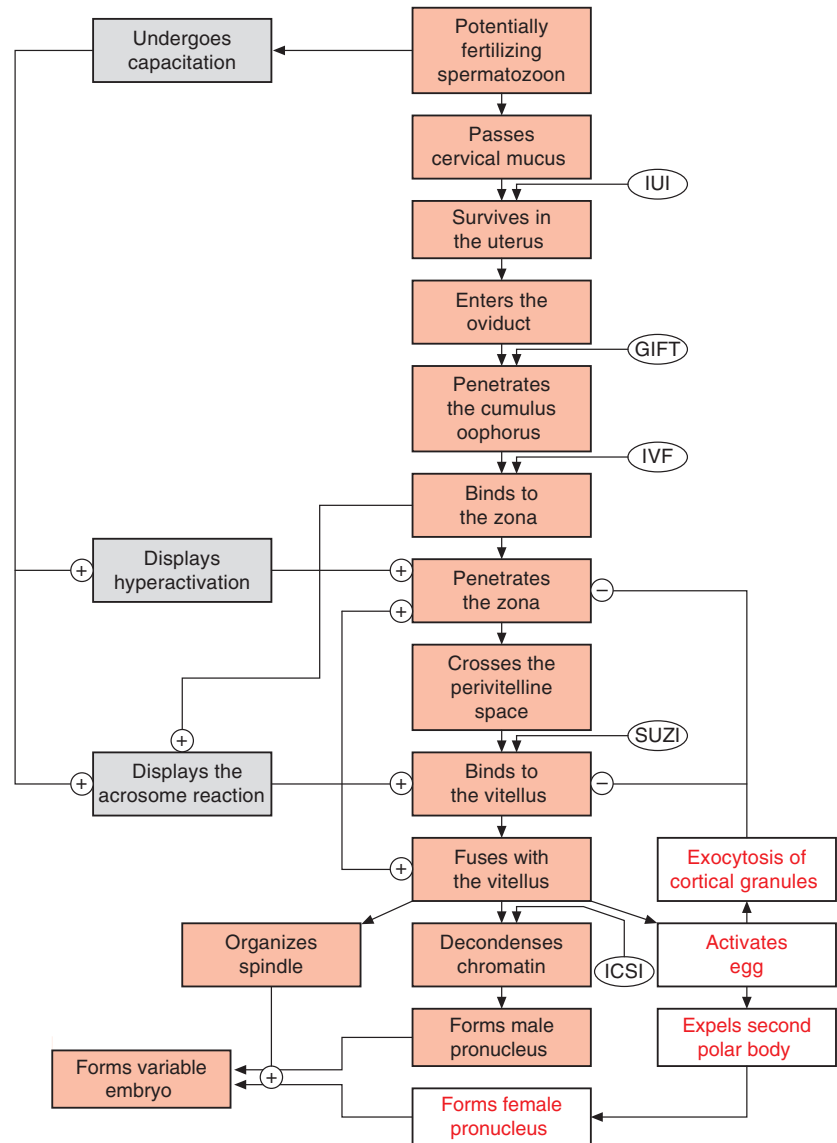

3.2 Development of the Ability of Spermatozoa to Fertilize Eggs During Epididymal Maturation

3.2.1 Anatomy of the Human Epididymis and Sperm Transport Through It

Spermatozoa shed from the seminiferous epithelium together with fluid secreted by the **Sertoli cells** are wafted through the **tubuli recti** into the cavities of the **rete testis** as the fluid is drawn along by the ciliary

action and absorption of fluid in the testicular **efferent ducts**. The spermatozoa then pass into one of these 12–18 efferent ducts (each 0.2–0.5 m long) forming the *globus major* of the epididymis (**caput epididymidis**) that eventually unite to form the single tubule of the epididymis. The efferent ducts comprise ciliated and non-ciliated cells whose arrangement, appearance and height form at least five different tubule types (Yeung et al. 1991). They provide a **resorptive** epithelium that concentrates the spermatozoa entering the ducts from the testis by mediating the transfer of ions and water from the tubule lumen to the interstitium; they may also have a secretory role (see Turner 2008).

The single duct of the epididymis is coiled into lobules forming the epididymis proper. Unlike that in other species, the human epididymis does not display grossly discernible **caput**, **corpus** and **cauda epididymidis regions**; the total length of the tubule in man is 5–6m (von Lanz and Neuhauser 1964). The epididymis proper has a pseudostratified epithelium, containing a population of **principal cells** of various heights (generally shorter distally) and **basal cells** that do not extend to the lumen as well as a population of wandering **lymphocytes**. The fixed cells are both resorptive and secretory in nature and they maintain a unique microenvironment in which sperm can remain viable for over 2 weeks. **Basal cells** share some characteristics with macrophages (Yeung et al. 1994). Tight junctional complexes are found in all regions (Cyr et al. 2007; Dubé et al. 2007).

The time for spermatozoa to pass through the epididymis lies between 2 and 11 days, depending on testicular sperm output (Johnson and Varner 1988). In this organ spermatozoa mature and are stored prior to ejaculation.

3.2.2 Epididymal Secretion and Absorption

Epididymal epithelial functions include the **estrogen**-dependent water resorption in the efferent ducts, which is driven by the androgen-dependent **absorption** of Na⁺ ions, and the androgen-dependent **secretion** of components that modify the epididymal spermatozoa in preparation for fertilization and maintain the mature spermatozoa quiescent before ejaculation. Absorption of fluid further concentrates the spermatozoa and epididymal secretions in the lumen. Epididymal secretions are important for some changes undergone by the maturing spermatozoa, whereas others are time-dependent phenomena (Cooper 1998). However, little is known in detail about these secretions and what they do in man, although some ideas are emerging (see Table 3.1).

Three low molecular weight secretions are present in high concentrations in the epididymis: **L-carnitine**, which is not synthesized in the epididymis but concentrated from the circulation; **myo-inositol**, which is both transported and synthesized by the epididymal epithelium, and **glycerophosphocholine (GPC)**, synthesized from

circulating lipoproteins (and possibly from sperm cells themselves). These molecules are organic osmolytes and may serve a role in sperm storage in the epididymis and sperm survival in the female tract. The amounts of **GPC** and **carnitine** in semen vary greatly between fertile men (Cooper et al. 1991): seminal GPC content provides a low prognostic value for IVF success and carnitine none (Jeyendran et al. 1989).

Molecular biology techniques have been used to determine the nature of human epididymal proteins. These include analyses at the gene level, including all transcripts in cDNA libraries (Li et al. 2008), known genes on Affymetrix chip arrays (Thimon et al. 2007, 2008; Dubé et al. 2007) or specific genes (Kirchhoff 2007), as well as at the level of the proteome and secretome (Dacheux et al. 2006). Table 3.1 summarizes some human epididymal proteins with suspected roles in fertilization (Cooper 2007a, b).

Table 3.1 Human epididymal proteins thought to have a role in fertilization

<i>Maturation-related</i>	
MIF	motility/immunity?
Clusterin (SGP-2)	acrosome masking?
SPAM1/PH20	zona binding?
P34H	zona binding?
4A8	zona binding?
Fibronectin	zona binding?
SPAMI (PH-200)	hyaluronidase/zona binding?
FLB1 (SOB1)	vitellus fusion
SOB2	vitellus fusion
hBD5, 6	antibacterial defensin
CRISP/ARP (AEGL1)	vitellus fusion
Cystatin 11	protease
ADAM7/GP83, GP39	metalloprotease
HE4	protease inhibitor
HE1/EPV20	sterol transfer/membrane fluidity
<i>Storage-related</i>	
CD52 (HE5, gp20)	decapacitation?/fusion?
LPB	immunity?
Eppin 1,2	antibacterial/protease inhibitor
SOB3 (CAP18)	anti bacterial/zona binding?
MIG/CXLC9	antibacterial chemokine
HE2a/b1/2b1/2b2/g	antibacterial defensin
DEFB118 (E5C42)	antibacterial defensin
EP2	antibacterial defensin
Semenogelin I product	antibacterial
LCN6	not antibacterial/ligand binding protein
MUC20	mucin/antibacterial

These genes are regulated by the presence of luminal secretions including spermatozoa (Dubé et al. 2008; Reyes-Moreno et al. 2008) and for some, but not all, proteins a general shift in expression proximally occurs in post-vasectomy tissue (Sullivan et al. 2007) or a decrease in cryptorchid tissue (Légaré et al. 2004). These changes may occur after natural blockages, leading to a higher and more proximal content of maturational secretions and consequences for the fertilizing potential of aspirated spermatozoa.

The neutral form of α -glucosidase is an important secretion of the human epididymis, and its absence from seminal plasma is used clinically as an indication of distal ductal occlusion in cases of azoospermia (see Chap. 6). IVF success can be predicted from the sperm content of the epididymal secretion P34H (Sullivan et al. 2006).

3.2.3 Sperm Maturation in the Human Epididymis: Fertilizing Capacity

The process occurring in the proximal epididymis (caput and corpus epididymidis) whereby spermatozoa gain their ability to fertilize eggs is termed **sperm maturation** and is associated with many physiological, biochemical and morphological changes in the spermatozoa (Cooper 1998). Most studies, made in animals, show that whereas ejaculated and cauda epididymidal spermatozoa from healthy males can fertilize eggs, spermatozoa leaving the testis are incapable of doing so when inseminated into the female tract or in vitro (Cooper 2007a). Such studies on fertility cannot be done for ethical reasons in man, and while there are few morphological signs of **sperm maturation** in humans (Bedford 1994), there are data on the ability of sperm from various regions of the epididymis to interact with eggs. (Cooper 1993, 1995a, 1996, 2002).

3.2.3.1 Evidence for Sperm Maturation in Man from Surgical Anastomoses

The **fertilizing capacity** of spermatozoa from various regions of the human epididymis can be inferred from pregnancies following operations in which occluded parts of the duct are bypassed by connecting the existing patent ductus deferens to the epididymis distal to the site

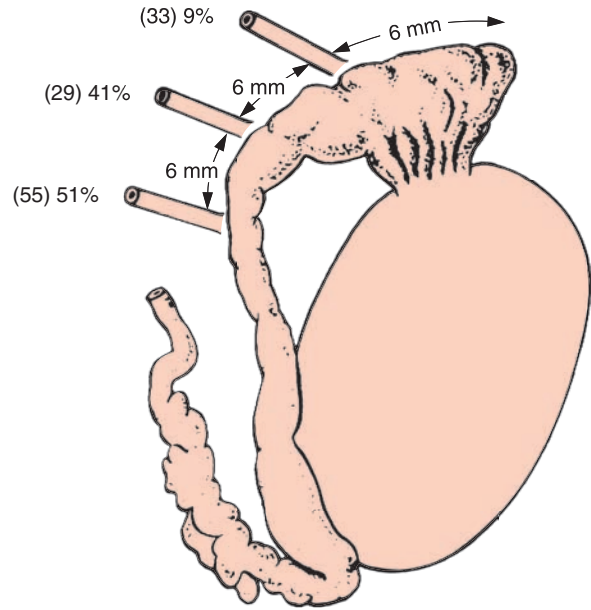

Fig. 3.2 Scheme indicating how epididymal occlusion can be overcome surgically by epididymovasostomy, in which the remaining patent vas deferens is anastomosed to an unobstructed region of the epididymis downstream of the block. The length of the epididymis through which spermatozoa pass naturally varies with the site of attachment. The pregnancy rates (%) increase the more distal the connection (number of patients in parenthesis) (From Bedford 1988. With permission)

of blockage (Fig. 3.2). Pregnancies established after coitus occur from 6 months to 2 years later, depending on whether connection is made at the levels of cauda, corpus or caput, with more success when sperm have passed through more of the duct (see Cooper 2007b).

While this may be interpreted as indicating that the human epididymis has some beneficial influence on spermatozoa, proximal connections of the vas deferens to the efferent ducts and even testicular tubules have also resulted in **pregnancies**. In all these cases sperm have been trapped for unknown periods of time in the caput epididymidis or testis before their release into the newly created outlet and long periods of time elapse before paternity results. There is current debate as to whether an effect of the epididymis can be ruled out or whether **epididymal secretions**, above the site of blockage and prevented from migrating distally, have accumulated and influenced the spermatozoa (see Turner 2008). It is not known if, after this operation, the **efferent ducts** or the **ductus deferens** secrete compensating factors that interact with the spermatozoa, but it is known that some glycoprotein secretions

of the human epididymis are also expressed in the vas deferens (Kirchhoff 1995), which has the same developmental origin.

3.2.3.2 Evidence for Sperm Maturation in Man from Assisted Reproduction Techniques

Another avenue of approach to determining the “fertility profile” of the epididymis is the application of **assisted reproduction techniques**. Under these experimental conditions, though, where the challenges to spermatozoa are completely different from those encountered in vivo, various stages of the fertilization process may be achieved in vitro by what were hitherto considered immature spermatozoa. Thus, in contrast to epididymovasostomies, in which spermatozoa are deposited through natural copulatory activity into the female tract, assisted reproductive technologies bypass most of the natural barriers confronted by normally ejaculated spermatozoa (Cooper 2007b).

Data are available from **in vitro fertilization (IVF)** where spermatozoa are taken from various regions of occluded ducts, especially from men with **congenital bilateral absence of the vas deferens (CBAVD)** and **cystic fibrosis (CF)**, where no vasal structures are present and surgical correction is not possible. Pregnancies can result from fertilization of eggs by epididymal spermatozoa obtained from the cauda, corpus and caput (**micro-epididymal sperm aspiration, MESA**) and testicular spermatozoa from the efferent ducts and epididymal spermatozoa (Hirsch et al. 1993, 1996), tubuli recti (Zenke et al. 2004) and testicular biopsies (**testicular sperm extraction, TESE**). Where comparisons have been made, spermatozoa from more proximal regions of the tract are generally less competent to initiate pregnancies as judged by high embryonic losses (Fig. 3.3h).

With more invasive reproductive technologies (see Chap. 23), human testicular spermatozoa produce pregnancies by **intracytoplasmic sperm injection (ICSI)**. Even immature germ cells, obtained from the ejaculate or testicular biopsies, can initiate pregnancies via intracytoplasmic injection methods termed **ELSI** (elongated spermatid injection), **ROSI** (round spermatid injection) or **ROSNi** (round spermatid nucleus injection) (see Lacham-Kaplan and Trounson 1997). The sperm-associated oocyte activation factor (SOAF: now identified as phospholipase C zeta [PLCζ]) develops during

spermatogenesis: it is absent from primary and secondary spermatocytes but present in round spermatids (Sousa et al. 1996).

3.2.4 Sperm Maturation in the Human Epididymis: Morphology and Motility

3.2.4.1 Changes in Sperm Morphology

The percentage of spermatozoa with normal head morphology appears to increase throughout the epididymis because the macrocephalic forms with “exploded” post-acrosomal regions disappear (Fig. 3.3a). This abnormal form is an artefact of the air-drying process used in the morphology procedure, since immature cells fixed before smearing do not exhibit this phenomenon (Yeung et al. 1997). Testicular spermatozoa also generate such morphologically abnormal exploded forms but this sensitivity is lost during a 3-day incubation (Liu et al. 1997) when they presumably undergo some oxidation of sensitive head structures.

3.2.4.2 Initiation of Sperm Motility

Spermatozoa released from the testis are equipped with the structural complex for flagellation although they are largely immotile. Some sluggishly motile spermatozoa can be obtained from the testis of patients with **CBAVD** or **obstructive azoospermia**, although the incidence of spontaneous testicular sperm motility seems to occur only in association with epididymal or ductus deferens blockage (Jow et al. 1993). Induction of motility is a time-dependent phenomenon and it is now common practice to incubate testicular spermatozoa in vitro to induce motility before using them for ICSI (Edirisinghe et al. 1996; Liu et al. 1997).

3.2.4.3 Acquisition of Co-ordinated Sperm Motion

In passing through the epididymis, spermatozoa from the testis not only acquire the potential for motility, but also develop the pattern of movement to a mature form. There is a general trend of increase in values for

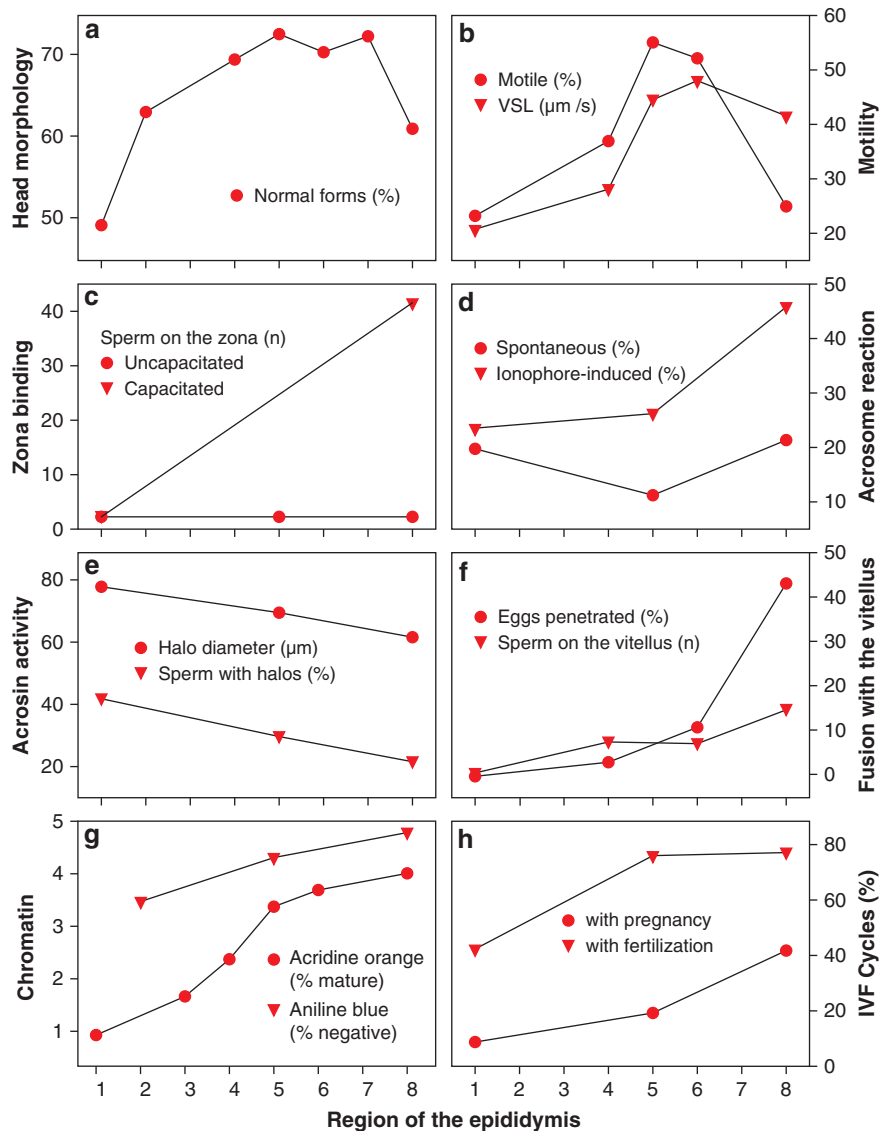

Fig. 3.3 Summary of changes to human spermatozoa removed from different regions of the epididymis. (a) normal sperm head morphology (uniform head shape) (From Soler et al. 2000); (b) motility (percentage and straight-line velocity) (From Yeung et al. 1993); (c) binding ability of uncapacitated cells is low (Delpech et al. 1988) but only mature capacitated bind to the zona (From Moore et al. 1992); (d) spontaneous acrosomal loss is constant in all epididymal regions but ionophore-induced acrosome reactions occur only to corpus and cauda spermatozoa (From Yeung et al. 1997); (e) acrosin activity as detected on substrate slides declines or is less accessible upon maturation

(From Haidl et al. 1994); (f) penetration of zona-free hamster eggs by capacitated, acrosome-reacted spermatozoa increases as they mature (From Moore et al. 1983); (g) chromatin assumes the mature compacted form of packaging as assessed by aniline blue binding to nucleoprotein (From Haidl et al. 1994) and acridine orange binding to nucleic acids (From Golan et al. 1996); (h) fertilization and pregnancy rate are higher when distal epididymal spermatozoa are used in IVF (From Patrizio et al. 1994). Regions of the epididymis 1 efferent ducts; 2–3 proximal corpus; 4 mid-corpus; 5–6 distal corpus; 7–8 cauda epididymidis

kinematic parameters including motility percentage, *velocity* of forward progression (VSL) and **straightness** of the swim-path (Fig. 3.3b). The increase in VSL is

largely a consequence of development in the co-ordination of flagellation, reflected by the parallel increase in the linearity of progression, in addition to an

increase in the vigor of flagellation as reflected by the curvilinear velocity. These maturational changes in sperm kinematic parameters occur within the proximal half of the epididymis and are accomplished in the mid-corpus epididymidis. There is little change in the amplitude of head displacement more distally.

The **heterogeneity** of the sperm population in any one region of the epididymis attests to differing rates of maturation in motility among individual sperm cells. This may reflect the anatomy of the caput epididymidis where some spermatozoa enter the beginning of the epididymal tubule via an end-to-end junction, whereas others overtake them by entering end-to-side junctions more distally (Yeung et al. 1991). Young mature spermatozoa from the mid-corpus epididymidis, where kinematic values are maximal, are most homogeneous. In several animals studied, especially in man, there is a decline, to various extents, in either percentage motility or VSL, or both, within the cauda epididymidis, often accompanied by a decrease in homogeneity of the sperm population. This probably reflects ageing of the mature spermatozoa, and the extent of such decline is related to the periods of **sexual inactivity** of the aged donors (Yeung et al. 1993; Bedford 1994).

3.2.4.4 Regulation of Sperm Motility

The axonemal complex of testicular spermatozoa is already functional in some but not all cells, since flagellation can be induced by adenosine triphosphate (ATP) in a low percentage of testicular spermatozoa permeated with Triton X-100. During epididymal passage, the mature status of the naked sperm axoneme (the response to exogenous ATP) is attained before that of the intact spermatozoon, which only initiates motility more distally, under its own ATP production (Yeung 1995). Mature spermatozoa released from the cauda epididymidis can swim better than less mature caput spermatozoa because of the acquisition of motility permissive factors and removal of some inhibitory factors to allow the necessary signal transduction. These include changes such as intracellular pH, Ca^{2+} , cAMP (see Yeung and Cooper 2002) and the protein phosphatase PPI γ 2 activity (Chakrabarti et al. 2007). Epididymal spermatozoa possess a novel **adenylyl cyclase** and they can be stimulated by **bicarbonate** that is produced by epididymal epithelial cells containing carbonic anhydrase.

3.2.4.5 Consequences of Increased Vigor of Mature Spermatozoa

The increased vigor of the more mature sperm cells, as indicated by VCL, provides them with an efficiency that is lacking from immature spermatozoa from the proximal epididymis with respect to their escaping from cervical mucus, migrating within the female tract and penetrating the egg investments. They have less of an advantage in vitro when contact with eggs is provided technically, as in *IVF*, although penetration of the zona is still required here. For (now no longer practised), **subzonal insemination** (SUZI), where the zona is breached mechanically to bring the sperm cell into the perivitelline space, motility is not required for fertilization since even immotile spermatozoa (e.g., from men with the ciliary disturbance Kartagener's syndrome) may fuse with the egg. After penetrating the egg the spermatozoon stops beating (Yanagimachi 1994) so that motility is not required once the sperm nucleus has entered the egg, and stopping movement by damaging the sperm membrane is a normal and necessary practice in **ICSI** techniques (Dozortsev et al. 1995).

3.2.5 Sperm Maturation in the Human Epididymis: Interaction with the Egg

3.2.5.1 Development of Sperm-Zona Binding Capacity

Capacitated spermatozoa from the caput epididymidis bind to the zona pellucida to a lower extent than those from the ejaculate, providing evidence for epididymal maturation of the zona binding process (Fig. 3.3c). Many sperm "zona receptors" have been identified in different species; some are present on testicular spermatozoa and are modified during epididymal transit by changes in size or location on the sperm head, others are secretion products of the epididymis (Table 3.1). A human **epididymal secreted glycoprotein** (P34H) has been shown to be involved in zona binding (Boué et al. 1996; Légaré et al. 1999).

Some cases of infertility are associated with failure of spermatozoa to attach to the zona (Bedford and Kim 1993) and lack of epididymal P34H in sperm extracts (Moskovtzev et al. 2007).

3.2.5.2 Development of the Sperm's Ability to Undergo an Induced Acrosome Reaction

When epididymal spermatozoa are incubated under conditions considered capacitating for mature cells, fewer caput cells undergo these “spontaneous” acrosome reactions than those from the corpus or cauda epididymidis (Fig. 3.3d). Synchronizing the acrosome reaction in human epididymal spermatozoa by incubation with calcium ionophore (Fig. 3.3d) or a cold stimulus (Haidl et al. 1994) leads to a higher rate of acrosome reactions by mature than immature spermatozoa, demonstrating maturation of the ability of sperm cells to respond to external stimuli upon maturation. One prerequisite of the acrosome reaction is appropriate cell membrane lipid fluidity and organization, to permit the plasma and outer acrosomal membrane to fuse and vesiculate, and the equatorial acrosomal membrane to fuse with the oolemma. The difference in membrane lipid composition between immature and mature spermatozoa (Haidl and Opper 1997) may underlie their different ability to undergo the acrosome reaction. Provided that they undergo the acrosome reaction, immature spermatozoa have sufficient acrosin for zona penetration, since they contain no less acrosin than mature spermatozoa (Fig. 3.3e).

3.2.5.3 Development of the Sperm's Potential to Fuse with the Vitellus

The ability of epididymal spermatozoa to bind to and fuse with the hamster vitelline membrane occurs beyond the caput and is maximal in the cauda epididymidis (Fig. 3.3f). Whether the RGD (arg-gly-asp) tripeptide sequence is involved in sperm–vitellus recognition is less certain than previously thought (Nixon et al. 2007). Other secreted proteins involved in sperm egg interaction (Boue et al. 1995) are given in Table 3.1.

3.2.5.4 Condensation of Sperm Chromatin and Ability to Form Male Pronuclei

In all species studied, there is an accumulation of disulphide bonds in the chromatin material of maturing spermatozoa in the epididymis due to oxidation of sulphhydryl (SH) groups of DNA-binding proteins (protamines). Chromatin condensation occurs in spermatozoa in the

epididymis, as indicated by decreased staining by aniline blue, a dye that interacts with histones, and by acridine orange, that binds to the nucleic acid, as spermatozoa mature (Fig. 3.3g). The decreased staining reflects decreased access of the dyes due to the oxidation of sulphhydryl bonds in nucleoproteins (Bedford 1994), resulting in increased chromatin stability. Eggs with sufficient reducing power in the ooplasm to reduce mature spermatozoa are able to decondense immature sperm cell nuclei that contain fewer S–S bonds.

3.2.5.5 Development of the Sperm's Ability to Contribute to a Healthy Embryo

In many species, epididymal spermatozoa that have developed the competence to fertilize eggs may not produce viable embryos. Delayed fertilization, delayed cleavage, and pre- and post-implantation losses have been documented in many species (Mieusset 1995). Their causes have hardly been investigated, but observations on the methylation of genes within spermatozoa in the epididymis (Ariel et al. 1994) may throw light on these phenomena, although the global demethylation that occurs by the 4.8 cell stage (Schultz 2002) argues against it.

Although fertilization may result in vitro from human epididymal spermatozoa, transfer of embryos does not always result in pregnancies. Comparison of the number of cycles that produce pregnancies with those in which fertilization occurs (see Cooper 1995b) reveals that human spermatozoa from the proximal occluded epididymides are not able to generate embryos of such good quality as spermatozoa obtained more distally (Fig. 3.3h). This view is confirmed by findings on the application of ICSI to testicular spermatozoa which have shown that the formation rate of two pronuclear embryos is lower (Lacham-Kaplan and Trounson 1997) and the transfer rate and pregnancy rates are lower with testicular spermatozoa compared with epididymal sperm cells.

The pathological nature of the material available leads to inconsistencies in whether testicular or epididymal spermatozoa are found to be best suited to ART. Where comparisons have been made on the application of ICSI with testicular and epididymal spermatozoa, the rates of two pronuclear embryos, embryo transfer and pregnancy are lower with testicular spermatozoa compared with epididymal sperm cells (Van Steirteghem et al. 1995). However, Dozortesev et al. (2006) found

higher fertilization rates with epididymal spermatozoa, but implantation rates greater with testicular spermatozoa, whereas Buffat et al. (2006) found fertilization and pregnancy rates to be the same for both sperm sources but miscarriage rates higher with testicular spermatozoa. Stalf et al. (2005) found that fertilization rates were higher when motile testicular spermatozoa were injected, whereas Rhouma et al. (2003) and Moghadam et al. (2005) found that immotile spermatozoa from the ejaculate, epididymis and testis produced similar fertilization and pregnancy rates. This dichotomy reflects the balance between obtaining poor quality mature spermatozoa, dying upstream of any blockage, and obtaining fresh immature spermatozoa that have come into premature contact with distal secretions accumulating within the duct.

3.2.6 Sperm Storage in the Epididymis

3.2.6.1 Storage Capacity

The **storage capacity** of the human epididymis is small (Bedford 1994) and **transport** of spermatozoa through it rapid. Ejaculated spermatozoa are unlikely to have been held for long periods in the epididymis and after about 2 weeks of abstinence spermatozoa appear in the urine (Barratt and Cooke 1988). The caudal sperm reserve is not emptied by one ejaculation (Bedford 1990; Cooper et al. 1993) and when aged spermatozoa are cleared from the epididymis by multiple ejaculations within a short period of time after a 2-week period of **sexual abstinence**, they are still viable (see Chap. 9). By this method of accumulating spermatozoa in the epididymis, an increase in the number of morphologically normal and motile spermatozoa can be achieved without medication by multiple ejaculations at the end of the abstinence period (see Chap. 9). Even without epididymal emptying and provision of single ejaculates, spermatozoa and semen quality does not change appreciably over this period of time (De Jonge et al. 2004; Levitas et al. 2005). Although the fertilizing potential of spermatozoa stored so long has to be proven, this strategy may be beneficial for increasing the sperm output of oligozoospermic patients.

Experimental retention of the epididymis (but not testis) in the abdomen reduces the size and **storage capacity** of the epididymis and our clothed lifestyle, which limits **scrotal cooling**, may influence

spermatozoa contained in the epididymis with undesirable consequences for fertility (Bedford 1994). The increased solubility of oxygen at lower temperatures (Djakiew and Cardullo 1986) may help maintain the viability of the concentrated spermatozoa. Spermatozoa within the human epididymis retain their fertilizing potential in vitro for at least 30h after death (Shefi et al. 2006) which is of interest for posthumous conception.

3.2.6.2 Sperm Quiescence and Protection

Spermatozoa within the epididymal canal are quiescent. This is partially enforced by lower concentrations of sodium and higher concentrations of potassium in **epididymal fluid** than are found in serum as a result of the transporting activities of the epithelium. Low **sodium ion concentrations** prevent the sodium-dependent increase in intracellular pH that normally promotes motility once the cells are released from the tract at ejaculation or in vitro. Low intracellular pH, brought about by the penetrating acids (e.g., lactate), may also inhibit the initiation of motility within the epididymis (Carr et al. 1985). High potassium depolarises the membrane, reducing ion transport activities. During their time in the epididymis spermatozoa are likely to be protected from lipid peroxidation by certain secretory products of the epididymis such as **superoxide dismutase** and **glutathione peroxidase** (Williamson et al. 1998; Potts et al. 1999) and from damage by leaking acrosomal enzymes by a secreted **acrosin inhibitor** (Kirchhoff 2007).

Inadequate epididymal storage can be a cause of necrozoospermia (Correa-Perez et al. 2004).

3.2.6.3 Immune Protection of Auto-antigenic Spermatozoa

As spermatozoa are formed many years after the **immune system** develops its ability to distinguish “self” from “non-self”, they will be considered “foreign” should they be recognized by the immune system. Various strategies have been adopted to hide them from immunological surveillance. Firstly, spermatozoa are **segregated** within the epididymal tubule. Unless this is ruptured, by continuous accumulation of sperm cells, as may occur after vasectomy, injury or disease, or in

cases of agenesis of the ductus deferens, they are to a large extent separated from circulating **immune effector cells**. However, the **tight junctional complexes** in the epididymis (Dube et al. 2007; Cyr et al. 2007) that prevent paracellular transport are not as effective as those in the testis and antigenic material can gain access to the interstitium, either through these tight junctions or by circumventing the barrier altogether by transcytosis (Yeung et al. 1989).

A second line of defence operating under normal conditions, indicated by the lack of anti-sperm immune response despite leakage of antigens, comprises **immunosuppression** by factors in the epididymis reducing lymphocyte activation (Pöllänen and Cooper 1994). **Macrophages** that are able to present sperm auto-antigens to the immune system are only occasionally found in the normal epididymal epithelium, but they are abundant in interstitial tissues. Cell-mediated antigenic responses against spermatozoa are effectively paralyzed as spermatozoa lack both the MHC-I and MHC-II-antigens that are required

for the responses of CD4⁺- or CD8⁺-lymphocytes and co-stimulatory molecules are normally absent. Should circulating antibodies be produced, their escape from capillaries is limited (Pöllänen et al. 1995). **Complement**-assisted destruction of spermatozoa in the lumen is minimal because of low levels of complement and the high levels of **complement regulatory proteins** on spermatozoa. The latter are present on developing germ cells in the testis (e.g., CD46, CD55 and CD59) and are secreted by the epididymal epithelium into epididymal fluid (e.g., SGP-2) (see Fig. 3.4). Recently interferon-dependent chemokines have been found in the human epididymis (Linge et al. 2008).

De Kretser et al. (1998) have shown that **antisperm antibodies** are present in the serum of men with epididymal occlusion, whether of obstructive or congenital origin. The incidence is higher when occlusion is more distal which suggests that there are regional abilities of the duct to suppress antigen responses. The macrophage-like expression of basal cells of the human

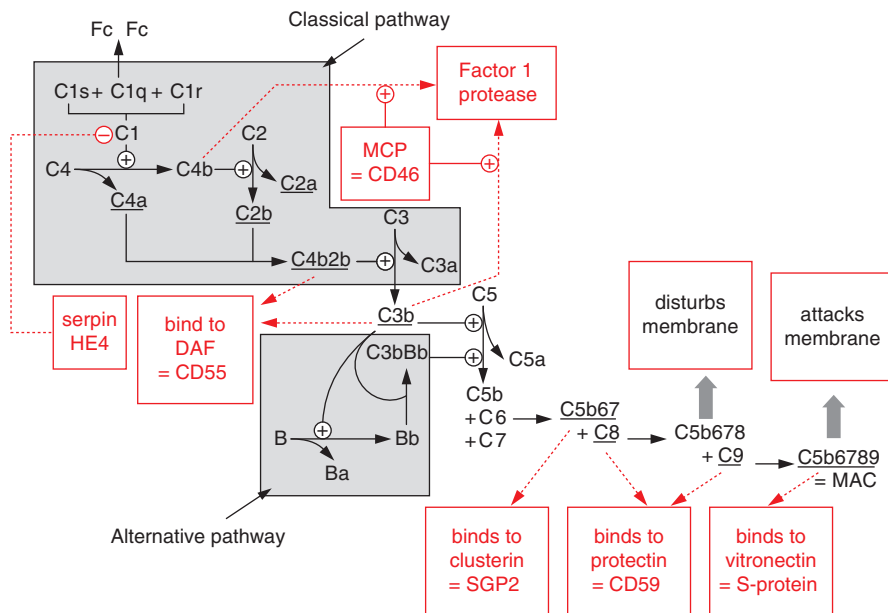

Fig. 3.4 A scheme outlining putative complement regulators in the male reproductive tract. *Black text*, sequential events; *grey boxes*, classical and alternative pathways; *red text*, immunoprotective pathways. In the *classical pathway*, the C1 component interacts with appropriately situated Fc fragments of immunoglobulins and stimulates production of a cascade of proteases (C4b, C2b) that combine to yield C4b2b which cleaves C3 to C3b. In the *alternative pathway*, C3b is produced spontaneously or by conversion of Factor B to Bb and production of the protease C3bBb. *Both pathways* generate C3b which converts C5 to C5b, and which in turn combines with other complement components

C6, C7, C8 and C9 to yield a membrane attack protein (MAC). Protection from attack (*red text*) is at the level of (i) inhibition of initial C1 protease by serine protease inhibitors (e.g., serpins); (ii) destruction of the proteases C4b and C3b by Factor 1 protease, involving a sperm membrane cofactor protein (MCP, CD46); (iii) binding of the proteases C4b2b and C3b by decay accelerating factor (DAF, CD55); (iv) binding of components of the membrane attack complex by clusterin (SGP-2), protectin (CD59) and vitronectin (S-protein) on sperm cells. CD46, CD55 and CD59 are present on testicular spermatozoa and the epididymis secretes SGP-2 and a serpin (HE4)

epididymis (Yeung et al. 1994) may indicate their involvement in removal of sperm auto-antigens.

3.3 Natural Fertilization

The spermatozoa that have matured and been stored in the epididymis are transferred to the female tract at ejaculation when they come into contact with other male accessory gland secretions. These activate the spermatozoa into motility but also deliver inhibitory agents that delay fertilization-relevant events.

3.3.1 Erection and Ejaculation

The **ejaculatory** process consists of two sequential processes under control of the **autonomic nervous system**. Under psychological, visual, auditory, olfactory and tactile stimuli, **parasympathetic** impulses travelling over the **nervi erigentes** liberate acetylcholine that vasodilates the **puddendal arteries**. This increases blood flow into the **corpora cavernosum** and **corpus spongiosum**, which compresses venous outflow, thus increasing turgidity of the penis and causing an **erection** (Fig. 3.5). Parasympathetic impulses also lead to secretion by the urethral and bulbourethral glands. The next phase, **emission** (the passage of spermatozoa into the urethra) is under **sympathetic** control with nerve impulses travelling over the **rami communicantes** and **hypogastric nerves** to liberate adrenalin that initiates contraction of the smooth muscles surrounding the ampulla, ductuli deferentia and terminal cauda epididymidis. At **ejaculation** proper, **parasympathetic** fibres from the lower lumbar and upper sacral centres, together with **somatic** inflow via the **puddendal nerve**, initiate contraction of the **bulbocavernous muscles**, leading to forcible ejection of the semen from the urethra at the same time as ascending impulses give rise to the sensation of **orgasm**. Finally, **detumescence** of the penis is caused by **sympathetic** release of noradrenalin causing dilation of the penile vasculature and penile flaccidity.

3.3.2 The Ejaculate

Unlike testicular, epididymal and accessory gland fluids, the ejaculate does not exist within the body; it is

only produced at the time of ejaculation. Analysis of ejaculate fractions in the order they are produced (split ejaculates) reveals the sequence of accessory gland secretions so that disturbances in the ejaculatory pattern can be discerned with this procedure. In fertile men the sequence in which the accessory glands contribute their secretions to the ejaculate is fixed: the **bulbourethral glands** secrete an alkaline solution with glycoproteins that neutralizes urinary tract acidity and lubricates the tract before ejaculation; the **prostate, epididymis** and **vasa deferentia** contract together, discharging spermatozoa and prostatic secretions; finally the **seminal vesicles** contract and expel the pellet of spermatozoa to the urethra with their secretions before forceful expulsion to the outside.

Coagulation of semen occurs as a result of interaction of a zinc-binding protein from the seminal vesicles (**semenogelin I**), which combines first with the spermatozoa and then with **zinc** from the prostate (Yoshida et al. 2008) to immobilize the spermatozoa in a semi-solid seminal clot. The epididymal secretion CD52 that is GPI-anchored to spermatozoa binds is a receptor for semenogelin I, retaining spermatozoa within the coagulum (Flori et al. 2008). Spermatozoa are released from it by a complex process that involves dissolution by the proteolytic action of another zinc-binding protein, **prostate specific antigen**, which is inhibited by zinc but relieved of this inhibition by semenogelin (Jonsson et al. 2005). During liquefaction that occurs within

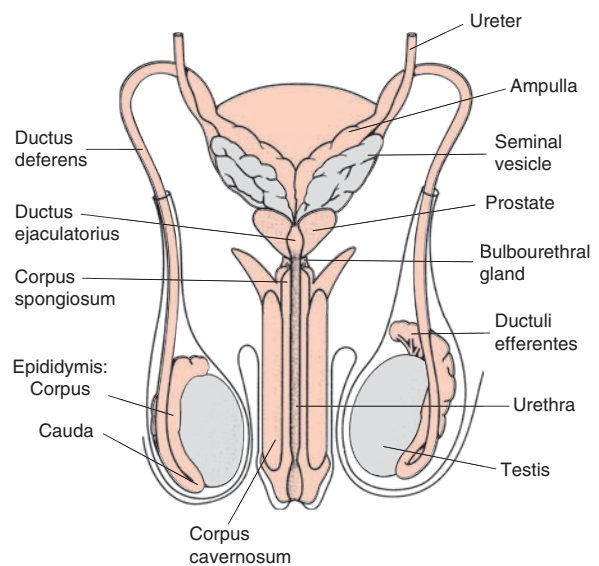

Fig 3.5 Morphologic scheme of the male genital tract

20–30 min, and thereafter, the osmolality of semen rises (Cooper et al. 2005) and the GPI anchor of CD52 is cleaved, freeing the spermatozoa from the clot.

The ejaculate that is collected and analyzed in the laboratory differs from that produced at coitus since all the various fractions are pooled in the collection vessel and cannot be analyzed until liquefaction has occurred. Of all the accessory glands that contribute to the ejaculate, the **seminal vesicles** provide the bulk volume but proper functioning of all the organs is necessary to provide sufficient fluid of the optimum composition for a normal ejaculate. Sperm-free seminal plasma is assayed to assess accessory gland function. The major secretions of the sex organs that appear in seminal plasma (**fructose** from the seminal vesicles; **zinc, acid phosphatase, citric acid, prostate-specific antigen** from the prostate, **L-carnitine, glycerophosphocholine, neutral α -glucosidase** from the epididymis) are analysed clinically to diagnose possible causes of infertility; the amount of secretion provides information about the presence, functioning or blockage of the glands (see Chap. 9).

3.3.3 The Basis of Sperm Motility

3.3.3.1 Structure of the Axoneme and Flagellar Motion

The structural basis of sperm **flagellation** is the tail (mid-, principal- and end-piece) with its central axoneme and the associated nine **outer dense fibres**. The **mid-piece** of the tail is circumscribed by the **mitochondria** (Fig. 3.6). Distal to the midpiece is the principal piece where outer dense fibres numbers 3 and 8 extend ribs to encircle the other dense fibres and the axoneme, forming the **fibrous sheath**. The axonemal complex is comprised of nine **microtubule doublets**, circularly arranged, interlinked by **nexin** and connected to the **central sheath** of the central pair of microtubules by **radial spokes** (Fig. 3.7).

The motor of flagellation is the row of outer and inner **dynein arms** protruding from each doublet. When the dynein **ATPase** is activated in doublets 1–4 in one half of the axoneme, the arms on each doublet pull on each adjacent doublets 2–5 with repetitious formation and breakage of dynein bridges. Because the doublets are anchored at the connecting piece in



Fig. 3.6 (a) Transverse section through the sperm principal piece reveals that the axoneme is composed of a central pair of microtubules surrounded by nine tubule doublets that are connected to each other and to the central pair. Bar, 0.2 μ m (From Neugebauer et al. 1990. With permission). (b) Longitudinal section of a normal spermatozoon: sperm head with nucleus (N) and acrosome (A). The midpiece comprises the axoneme (AX) and associated outer dense fibres, mitochondria (M) and a cytoplasmic droplet (C). The principal piece contains the axoneme and fibrous sheath (RF). Bar, 1 μ m

the neck region and at different sites in the endpiece, the flagellum does not lengthen and shorten; rather the sliding movement of the doublets so produced is

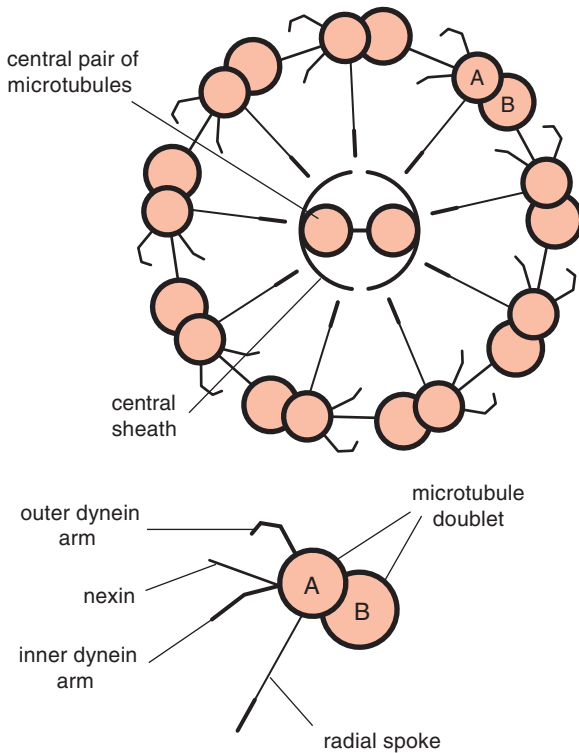

Fig. 3.7 Components of the axoneme are represented schematically. The axonemal complex comprises nine microtubule doublets interlinked by nexin and connected to the central sheath of the central pair by radial spokes

translated into flagellar bending in one direction. When active sliding is switched to the doublets 6–9 on the other half of the flagellum, bend formation occurs in the opposite direction. This alternating bending and the propagation of these opposing bends along the flagellum result in oscillation of the sperm tail. The mechanisms for the switching from one bending to the opposite bending have been explained by the “switch-point” (see Yeung and Cooper 2002) or the more recent “geometric clutch” models (Lindemann 2007).

The set-point at which such switching occurs differs between progressive motility and the state of **hyperactivation** (more vigorous flagellation but less progressive movement) that occurs in capacitated spermatozoa. This results in an altered pattern of tail flagellation in hyperactivation. Assessment of hyperactivated motility of human spermatozoa is largely performed by computer image analysis of patterns of the track of the head. Various parameters have been defined to quantify this (“thrashing, star-spin, erratic, circular or helical” motion), depending on the

conditions of measurement, including freedom of 3D movement within the viewing chamber and on the settings of the equipment used.

Various types of **axonemal defects** in ejaculated human spermatozoa have been identified clinically as the cause of sperm immotility in **infertile men**. These include absence of dynein arms, central pairs, linking components or outer dense fibres, and disorganization of axonemal and peri-axonemal components (Zamboni 1992; Chemes and Rawe 2003). However, not all axonemal anomalies lead to total immotility of the sperm cell, in particular the lack of outer dynein arms, which is in agreement with the interpretation of different functions for different types of dynein arms. Bend initiation and the maintenance of the angle of the propagating bend are each attributed to the inner arms, whereas the outer arms are not essential for flagellation but generate force to overcome the viscous bending resistance in the regulation of bend growth and beat frequency.

Motility is essential for sperm migration out of cervical mucus, partly responsible for their reaching the site of fertilization, and obligatory for penetrating the egg’s cellular and acellular investments.

3.3.3.2 Energy for Flagellation

The midpiece mitochondria generate energy via oxidative phosphorylation from respiratory substrates (Yeung et al. 1996) and correlations between the mitochondrial membrane potential and progressive motility and IVF success have been documented (Marchetti et al. 2004). However, glycolysis can provide additional energy from substrate-level phosphorylation and this supports human sperm motility (Hoshi et al. 1991). This is facilitated by the glycolytic enzyme location along the fibrous sheath (Kim et al. 2007) which also provides a scaffold for closely associated signal transduction molecules for sperm function including motility (Carr and Newell 2007).

Immotility may stem from mitochondrial dysfunction, providing insufficient energy for motility (Carra et al. 2004), although dysfunctional axonemes that are not reactivated with ATP indicate that other, non-metabolic, factors may be responsible (Yeung et al. 1988).

3.3.4 Movement of Spermatozoa Through the Female Tract

3.3.4.1 Passage of Uncapacitated Spermatozoa Through Cervical Mucus

During intercourse spermatozoa are deposited in the **vagina** within the seminal plasma which neutralizes vaginal acidity and provides immunoprotection. Spermatozoa migrate out of the seminal coagulum during its liquefaction in the vagina and **cervix** into a mucus secreted around ovulation by the cervical crypts. The first, sperm-rich portion of the ejaculate may immediately contact **cervical mucus** extending into the vagina (Sobrero and MacLeod 1962). The alignment of the mucus glycoprotein constituents around ovulation favors the passage of sperm cells (Mortimer 1995).

However, mucus can represent a barrier to sperm passage when anti-sperm antibodies are present in it. Antibody-coated spermatozoa are anchored by their tails, leading to a “shaking” phenomenon observed *in vitro*. This observation has diagnostic significance in the *in vitro* **cervical mucus contact (Kremer) test** (see Chap. 10). In addition to spermatozoa suffering from sub-normal tail flagellations, morphologically abnormal spermatozoa also suffer a hindrance when penetrating cervical mucus, as a result of hydrodynamic considerations (resistance to passage of the head) (Katz et al. 1990). Spermatozoa that cannot regulate their volume also display impeded transport through mucus (Yeung and Cooper 2001).

The extent to which spermatozoa are slowly released from a pool sequestered in cervical crypts is debated (Mortimer 1995). In addition to their own movements, bulk movement of spermatozoa to the oviducts is assisted by ipsilateral **uterine peristalsis** which is controlled by estradiol secreted from the dominant follicle and enhanced by oxytocin (Kunz et al. 2007).

3.3.4.2 Capacitation in the Female Tract and Ascent of Spermatozoa to the Oviducts

Whether the human **uterotubal junction** is a serious obstacle to functional spermatozoa is not known (Mortimer 1995) but fertilizing spermatozoa probably need to swim through it into the **Fallopian tube** (Suarez and Pacey 2006). The composition of tubal fluid is such

that migration of spermatozoa to the eventual site of fertilization is arrested when they are attached to the tubal epithelium.

During the time that spermatozoa pervade the female tract they also undergo a parallel process called “**capacitation**” that enables them to reach and fertilize eggs. This process is demonstrated by the inability of freshly ejaculated sperm cells to fertilize eggs immediately on contact with eggs *in vitro*, and their ability to do so after a period of capacitation has elapsed. In man this period is extremely variable in duration (Yanagimachi 1994). Capacitation results in changes in the functional status of spermatozoa, permitting **hyperactivated motility** and their ability to penetrate the egg-coats and undergo an **induced acrosome reaction** on the surface of the zona pellucida (Fig. 3.8). It is believed that spermatozoa *in vivo* attach to the endosalpinx before the time of ovulation in a non-capacitated state which maintains their viability.

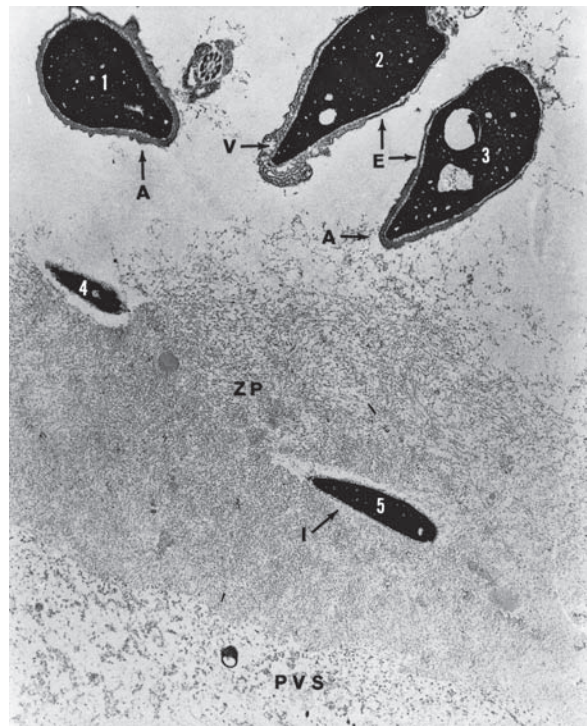

Fig. 3.8 Human spermatozoa outside and within the zona pellucida 8h after *in vitro* fertilization with salt-stored human zonae. Spermatozoa 1 and 3 have unreacted (intact) acrosomes and the plasma membrane over the anterior acrosome (A) and equatorial segment (E) is intact. Spermatozoon 2 shows changes in the acrosomal membranes that may represent fusion and vesiculation (V). Spermatozoa within the zona have lost their plasma membrane and outer acrosome membranes. The inner acrosomal membrane (I) is in contact with the zona substance (ZP) (From Overstreet and Hembree 1976. With permission)

Mechanism of Capacitation

During capacitation, spermatozoa lose some surface proteins (so-called **decapacitation factors**) that are provided by the **epididymis** and at ejaculation from **seminal vesicle** secretions. This is accompanied by bicarbonate-dependent changes in sperm plasma **membrane lipids** (Harrison and Gadella 2005). Sterols and their sulphates are present in spermatozoa and sterol binding proteins and sterol sulphatases are present in the female tract and follicular fluid (Zarintosh and Cross 1996). Enzymatic cleavage of polar esters to non-polar sterols alters the rigidity of membranes, and cholesterol removal by sterol-binding proteins changes the status of the membrane **lipid raft microdomains**. These are the site of signal transduction complexes involved in recognition and binding of the zona pellucida (Shadan et al. 2004). Plasma membrane lipid rafts are micro-domains rich in cholesterol, sphingomyelin, glycosphingolipids, glycosylphosphatidylinositol (GPI)-anchored proteins and signal transduction molecule complexes. A loss of cholesterol from sperm membranes is an important step in causing membrane lipid disorder to increase **membrane fluidity** and facilitate the eventual **membrane fusion** required for the acrosome reaction and sperm–egg fusion (Cross 2003). **Sperm proteins** also change their location and their cAMP- and protein kinase A-dependent phosphorylation status (Visconti et al. 1998; Mitchell et al. 2008). The molecular changes and mechanisms involved in sperm capacitation are inevitably studied in vitro and caution is warranted in extrapolation to in vivo temporal, spatial and physiological situations.

Consequences of Capacitation: Hyperactivation and Migration to the Site of Fertilization

The first consequence of capacitation is **hyperactivation**. This motility pattern is recognized microscopically as a vigorous thrashing of the sperm tail, flagellating with **large bend amplitudes**, and resulting in a darting, **non-progressive** motion. The trigger for hyperactivation is uncertain, but the molecular basis of hyperactivation includes Ca^{2+} influx through the CatSper ion channels (Qi et al. 2007) and cAMP-dependent tyrosine phosphorylation of sperm proteins generating signal transduction. This generates **increased thrust** compared with the high beat-frequency, low-amplitude

flagellation of forward progressive, non-capacitated freshly ejaculated spermatozoa.

Such movement leads to detachment of spermatozoa from the oviductal epithelium, increases the chance of collision of the spermatozoon with the cumulus (as it enlarges the area swept out by the sperm track) and provides thrust for spermatozoa to migrate through viscous luminal fluid, the cumulus oophorus and the zona pellucida surrounding the oocyte. For humans, hyperactivation is not as well defined as for laboratory animals (Mortimer and Swan 1995), and only a small proportion of all the spermatozoa may be hyperactivated at any time. The extent of hyperactivated motility in a population is positively correlated with the extent of **zona binding**, the **acrosome reaction**, **zona-free oocyte penetration** and **fertilizing capacity** in vitro.

Migration of spermatozoa towards the oocyte in the oviductal **ampulla** is probably assisted by **thermotaxis**, the migration of spermatozoa up a thermal gradient. The **ampulla** has a higher temperature than the **isthmus** of the Fallopian tube, and this may mediate long-range migration to the ampulla (Bahat and Eisenbach 2006). Only capacitated spermatozoa respond to these influences.

3.3.5 Penetration of Spermatozoa Through the Egg Investments

After reaching the site of fertilization in the ampulla of the Fallopian tube, individual spermatozoa still have to surmount two barriers potentially preventing direct contact with the oolemma: the **cumulus oophorus**, in which the egg is embedded; and the **zona pellucida**, surrounding the oocyte (Fig 3.9).

3.3.5.1 Penetration Through the Cumulus Oophorus

The **cumulus oophorus** consists of **granulosa cells**, including the “corona radiata” immediately adjacent to the egg. These cells are embedded in a viscoelastic matrix composed mainly of hyaluronic acid. Although lytic enzymes on the sperm surface, such as the **hyaluronidase** PH-20 (Lin et al. 1994), may be involved in facilitating the passage of spermatozoa through the **cumulus**, the necessity for mechanical force from the hyperactivated spermatozoa itself is

demonstrated by the **physical distortion** of the cumulus matrix (Dandekar et al. 1992) by the penetrating spermatozoon. The spermatozoon may be directed to the egg within the cumulus by **chemotaxis**, the migration of spermatozoa towards a higher concentration of chemoattractant (Eisenbach and Giojalas 2006). The granulosa cells, especially the corona radiata, may secrete compounds that mediate short-range chemotactic migration within the cumulus (Sun et al. 2005). Progesterone is one component of the fluid that has recently been considered to stimulate motility via Ca^{2+} signalling (Harper et al. 2004), possibly by way of non-

genomic membrane steroid receptors. Olfactory receptors have been identified on spermatozoa that may mediate chemotaxis (Spehr et al. 2006).

Only acrosome-intact spermatozoa can penetrate the cumulus. If a spontaneous acrosome reaction (loss of the acrosome) occurs outside the **cumulus**, the spermatozoa cannot migrate through this investment, as acrosome-reacted spermatozoa become attached to the cumulus mass. Thus, it is generally agreed that the **acrosome reaction** of importance for sperm penetration occurs on the surface of the **zona pellucida** (Liu et al. 2007a; see Fig. 3.9).

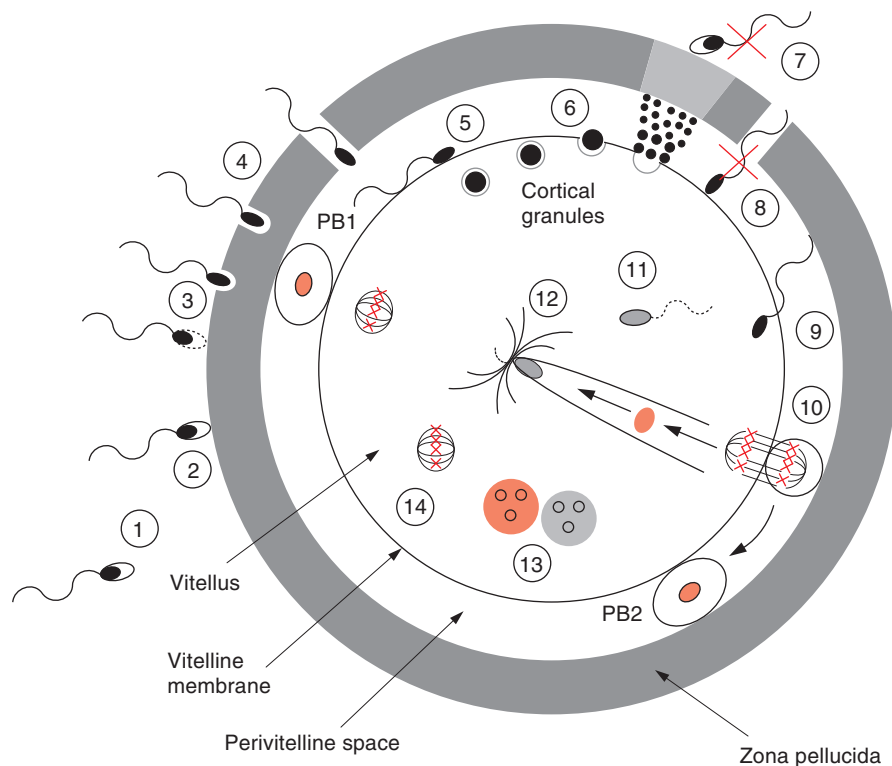

Fig. 3.9 The sequence of events leading to fertilization. After the intact, capacitated spermatozoon penetrates the cumulus oophorus (1) it makes contact with the zona pellucida (2) which induces the acrosome reaction on the surface of the zona (3). The acrosome-reacted spermatozoon drives its way through the zona substance (4) into and across the perivitelline space (PVS). Binding to and fusion of the acrosome-reacted spermatozoon with the vitellus (5) initiates membrane-mediated calcium-dependent electrical spikes and introduce sperm-associated an egg-activating factor that promotes migration of the cortical granules to the egg surface where their contents are liberated into the PVS (6) and diffuse across it to alter the zona substance such that subsequent spermatozoa cannot bind to the zona, the “zona block to polyspermy” (7). The granules’ membranes are

now the egg membrane and block fusion of acrosome-reacted spermatozoa that may simultaneously be in the PVS, the “vitelline block to polyspermy” (8). Penetration of the fertilizing spermatozoon (9) further activates the egg, overcoming the metaphase promoting factors, so that the second meiotic division ensues, leading to extrusion of the second polar body (PB2) and the female pronucleus (10). Meanwhile the sperm tail degenerates and the sperm chromatin decondenses in the cytoplasm (11), its protamine is replaced by histones and the male pronucleus forms. The sperm’s centriole organises microtubule spindles that spread throughout the ooplasm (12) and eventually contact the female pronucleus and draw it to that of the male (13). Eventual alignment of sister chromatids leads to syngamy (14)

3.3.5.2 Consequences of Capacitation: Interaction of Spermatozoa with the Zona Pellucida

The **acellular zona pellucida** consists of a meshwork of the glycoproteins ZP1, ZP2, ZP3 and ZP4/ZPB (Lefievre et al. 2004). Whereas ZP3 and possibly ZPB are involved in sperm-zona binding, ZP1 provides structural integrity to the zona pellucida by cross-linking filaments constituted by the other zona proteins. Despite vigorous movement of the hyperactivated spermatozoon, an initial loose contact between the gametes gives way to a firmer, or **primary, binding**, between carbohydrate groups O-linked to the **zona pellucida protein ZP3/ZPB** and a “**zona receptor**” on the spermatozoon. A variety of proteins associated with the sperm surface have been considered capable of mediating this sperm-zona binding and different sugar residues and structure of the ZP glycans are involved in different species. **Fucose** or **fucoidan** and **mannose**, in particular, are reported to inhibit sperm-zona binding, suggestive of competition with similar structures on the sperm surface with the zona pellucida.

Receptors for ZP3 on human spermatozoa have not been unequivocally identified but they include integral membrane proteins already present on testicular spermatozoa, as well as epididymal secretions coating the sperm surface during maturation within the epididymis, e.g., P34H. The fact that N-**acetylglucosamine** (Brandelli et al. 1996) and **mannose**-ligands (Benoff et al. 1997) can induce the acrosome reaction indicates that they are interacting with putative zona-binding sites on the spermatozoon. There are recent suggestions that in addition to ZP3, initial sperm-zona binding also involves other egg-coat components acquired in the oviduct after ovulation (Shur et al. 2006).

The vigor of sperm cells alone, in the absence of enzymes, may be sufficient for zona penetration (Bedford 1998), and the necessity for mechanical force from the spermatozoon itself is demonstrated by **stress lines** in the zona pellucida created by the penetrating spermatozoon (Phillips 1991). However, as each spermatozoon reaching the perivitelline space generates a **penetration slit** in the zona, suggestive of local dissolution of the zona, it is likely that both mechanical and enzymatic forces are the means by which the spermatozoon gains entry to the perivitelline space. SPAM1/PH-20 (a **sperm surface hyaluronidase**) is

secreted by the human epididymis and may function as enzyme and zona-receptor (Evans et al. 2003).

3.3.5.3 Interaction of Spermatozoa with the Zona Pellucida: the Acrosome Reaction

Binding of the zona pellucida protein ZP3 to the “zona-receptors” on the membrane overlying the acrosome elicits fluxes of both intra- and extra-cellular Ca^{2+} in addition to increases in intracellular pH, cAMP and protein tyrosine phosphorylation in complex signal transduction processes (Jimenez-Gonzalez et al. 2006). One prerequisite for the acrosome reaction is a change in membrane lipid composition and organization, acquired during capacitation, to increase fluidity which favors fusibility (Gadella and Harrison 2002; Jones et al. 2007). Another prerequisite is the re-organization and distribution of the cytoskeletal actin components and the subsequent depolymerization of F-actin so that the plasma membrane over the acrosome and the underlying **outer acrosomal membrane** are brought into contact for fusion (Liu et al. 2002, 2005; Breitbart et al. 2005). This leads to the formation of hybrid vesicles that are eventually shed as the spermatozoon moves through the **zona pellucida** (Figs. 3.8 and 3.9).

One consequence of this is the release of soluble acrosomal proteases (e.g., acrosin), and exposure of inner outer acrosomal membrane-bound proteases (**acrosin** and its precursor **proacrosin**). High molecular weight α -acrosin (**proacrosin**) can also function as a zona binding protein, and it plays another postulated role in **secondary binding** to the zona by acrosome-reacted spermatozoa, involving the zona protein ZP2 (Green 1997), once the plasma membrane is lost and ZP3-binding is no longer functional.

Infertility can be associated with failure of several aspects of attachment of the spermatozoon to the egg (Liu and Baker 2003a, b, 2004), failure of bound cells to undergo a normal acrosome reaction (Tesarik and Mendoza 1993; Franken et al. 2000; Esterhuizen et al. 2001; Bastiaan et al. 2003; Liu and Baker 1994, 2003a, b; Liu et al. 2007b), defective action of non-genomic progesterin receptors (Tesarik and Mendoza 1992) and an inability of spermatozoa to intrude into the zona pellucida or complete penetration of it (Bedford and Kim 1993; Liu and Baker 1994).

3.3.6 Fusion of Spermatozoa with the Vitelline Membrane (Oolemma) and Egg Activation

3.3.6.1 Pre-fusion Events and Membrane Fusion

Besides releasing hydrolytic enzymes to facilitate zona penetration, another role of the acrosome is to produce the subtle changes in the **equatorial region** of the acrosome and **post-acrosomal region** (see Fig. 3.10) that are necessary for subsequent sperm–vitellus fusion. Unlike the proximal acrosomal region, there is no vesiculation of the equatorial region of the acrosome which, together with the post-acrosomal region, is considered to be the site of initial **sperm–egg contact** (Primakoff and Myles 2007).

Once inside the **perivitelline space** the normally penetrating spermatozoon is already **acrosome-reacted**

so that the changes in the post-acrosomal and equatorial regions that permit fusion with the egg have already taken place. The equatorial and post-acrosomal region of the sperm head bind to the oolemma in the region rich in microvilli (Liu and Baker 1994).

Information on sperm–egg fusion at the molecular level is mainly confined to studies on mice and is inconclusive. The interaction of **integrins** on the oolemma with **disintegrins (ADAMs)** on the sperm membrane believed a decade ago to result in fusion, remains unproven (Nixon et al. 2007). Besides ADAMs, the other candidate for egg fusion expressed by human spermatozoa is **Izumo**, a member of the immunoglobulin superfamily (Inoue et al. 2005).

Infertility can result when acrosome-reacted spermatozoa are defective in their fusing ability (Tesarik and Thebault 1993).

Fig. 3.10 Scheme of events occurring during the acrosome reaction. (a) The membranes of the sperm head; (b) the fusion of the outer acrosomal membrane and overlying plasma membrane and migration of components to the posterior sperm head; (c) formation and loss of acrosomal vesicles with attendant exposure of bound, and loss of soluble, lytic enzymes and migration of components to the anterior head; (d) the final state with membrane domains exposed for further sperm–vitellus interaction

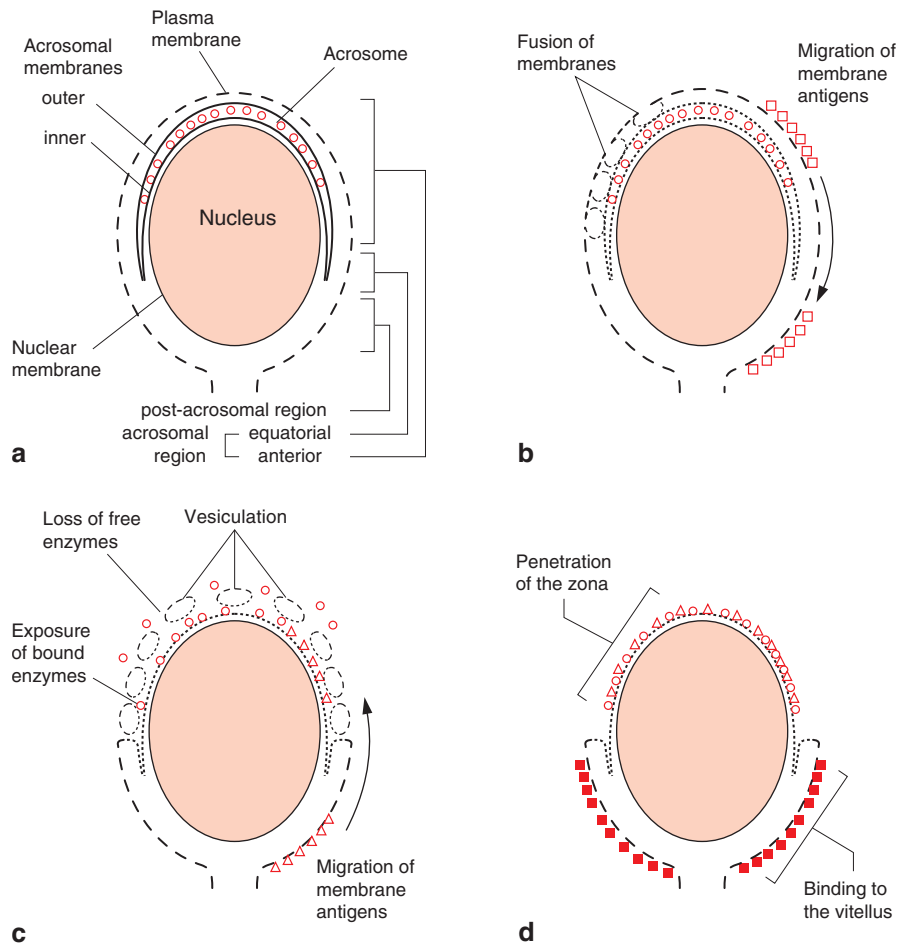

3.3.6.2 Post-fusion Events and Activation of the Egg

Although the **oocyte** is developed from the follicle to be the female gamete contributing the **maternal haploid genome**, meiosis is not complete at the time of ovulation; it is arrested at metaphase of meiosis II. The importance of sperm entry at fertilization is the alleviation of this blockage so that the oocyte can resume meiosis. Sperm–egg fusion induces the release of calcium ions from the intracellular store of the oocyte, followed by **Ca²⁺ oscillations** lasting for hours until **pronucleus** formation. The identities of the factors responsible for the initiation of oocyte activation are still unclear. Evidence supports the existence of a so-called sperm-associated oocyte activation factor (**SOAF**) contained in the perinuclear theca of the sperm head which has been identified as **phospholipase C zeta (PLC ζ)**. Upon release into the ooplasm, PLC ζ stimulates Ca²⁺ release from the endoplasmic reticulum, which activates a protein kinase (CaMKII) that acts on, and induces degradation of, the inhibitor (Erp1) of a protein complex called APC/C^{Cdc20} (anaphase-promoting complex/cyclosome). This protein complex in turn induces the degradation of certain inhibitors responsible for the meiotic II arrest, so that the oocyte can enter anaphase (Kishimoto 2005). The subsequent extrusion of the second polar body is the evidence for the completion of this interrupted meiosis (Fig. 3.9).

Although during intracytoplasmic sperm injection (ICSI) the sperm–egg membrane fusion event is bypassed, oocyte activation can still occur. Nevertheless, there is a delay, owing to the slower release of PLC ζ from the perinuclear theca from the acrosome-intact injected spermatozoon. The delay in the breakdown of perinuclear theca and exposure of sperm chromatin also leads to delay in chromatin decondensation in ICSI compared with fertilization via sperm–egg fusion (Williams 2002).

3.3.7 Post-fusion Events

3.3.7.1 Block to Polyspermy

An early aspect of oocyte activation triggered by Ca²⁺ signalling is the exocytosis of **cortical granules** that are superficially situated in the unfertilized egg (Fig. 3.9).

These serve to inhibit **polyploidy** by preventing a second spermatozoon from entering the egg by action at two levels: the vitellus and the zona. First, fusion of the cortical granule vesicles with the vitelline membrane immediately alters the composition of the egg membrane to that of the interior membrane of the granules, for which spermatozoa have no affinity; this constitutes the **“vitelline block to polyspermy”**. Second, the contents of the granules are released into the perivitelline space. Of these, glycosidases alter the zona glycoprotein ZP3 to ZP3f, which lacks the carbohydrates which the sperm’s primary receptor recognizes, and proteases degrade ZP2 to ZP2f, which is unable to bind to acrosome-reacted spermatozoa (Wassarman 1992). This constitutes the **“zona block to polyspermy”** (see Fig. 3.9).

Infertility stemming from failure of egg activation may be due to insufficient SOAF and be overcome by injection of SOAF from other spermatozoa (Palermo et al. 1997).

3.3.7.2 Formation of the Male Pronucleus

Within the testis, sperm chromatin is highly condensed and arginine-rich **histones** are replaced by even more highly charged, basic **protamines** during spermiogenesis, which fit into the spiral grooves of nucleic acid (Barone et al. 1994). Within a few hours of sperm–egg fusion, the sperm head swells as the disulphide bonds of the nucleoprotein protamine are reduced by glutathione in the egg cytoplasm and **nucleoplamin** displaces the protamines, exchanging them for histones (Montag et al. 1992). After protamine-histone exchange and **DNA demethylation**, restrictions on the DNA template are removed, and the male pronucleus is generated, around which a membrane forms. Eventually the tail and paternal mitochondrial DNA is lost, as only maternal mitochondria supply the embryo. The paternal chromatin in the **male pronucleus** can already contribute significantly to gene transcription of the newly formed zygote before transcription is initiated in the **female pronucleus**, although there is no translation as yet (Schultz 2002).

Entry of the spermatozoon has already led to oocyte activation (see above), resulting in extrusion of the second polar body and formation of the female pronucleus, from its haploid chromosome complement. At the same time, the **centromere** from the fertilizing spermatozoon is activated, and this is responsible for

organizing the **microtubule spindles** that pervade the fertilized egg, make contact with the **female pronucleus** and draw the male to the female **pronucleus** for the first mitotic division (Navara et al. 1995; Sathananthan et al. 1996). Both **pronuclei** move together and the chromosomes condense during the prophase of **syngamy** before breakdown of the nuclear membrane, at which time paternal and maternal sets of chromosomes become visible. These interact on the spindle during the first cleavage division.

Some infertile men have spermatozoa that cannot be activated in the ooplasm (Brown et al. 1995) and infertility may result when penetrating spermatozoa cannot organize the cytoskeletal structures necessary for the mitotic spindle (Asch et al. 1995).

3.3.7.3 Early Embryonic Development

After formation of the **zygote**, early cellular divisions occur in the oviduct. Gene expression becomes very rapid to enable a drastic increase in metabolism for pre-implantation development. After **2.5–3 days** the developing zygote, still within the zona pellucida, enters the uterus where division continues to the **morula** stage (consisting of 16 totipotent cells) and **blastocyst** (32–64 cells). During oviductal transport both the uterus and embryo undergo morphological and biochemical changes: the uterus becomes receptive for blastocysts to survive (dependent on ovarian progesterone and estrogens) and the embryo develops to a form that is eventually dependent on the maternal circulation. Within the uterine cavity the blastocyst expands and becomes asymmetrical; the outer layer defining the future **trophoblast** and the inner cells the **inner cell mass**. At a late cleavage stage, **compaction** of the blastocyst occurs, when it acquires gap and tight junctions and epithelial differentiation begins. The formation of an enveloping epithelium (**trophoblast**) isolates the developing embryo from the external environment and directional ion transport by the trophoblast leads to fluid secretion into the blastocyst cavity (**blastocoel**) and the creation of different ion concentrations inside the conceptus.

3.3.7.4 Embryo Implantation

Implantation is a unique association of the embryo with the endometrium that is necessary for **placentation**

(a haemochorial placenta forms). After 3 days free in the uterus (**6–7 days** after fertilization), the blastocyst comes in close apposition to the uterine epithelial cells and awaits a signal from it to initiate changes for implantation. In a pre-implantation phase the fertilized egg **hatches** from the zona pellucida. This is a necessary event for implantation that requires steroid-dependent lytic factors. The free blastocyst enters the endometrium on **day 20–21** after fertilization and during **implantation** the unattached blastocyst becomes fixed in the uterus in an intimate relationship with the endometrium. During attachment/adhesion of the embryo to the endometrial wall fibroblast-like cells of the uterine stroma are transformed into giant cells dependent on progesterone. Invasion of the uterine luminal epithelial cells, penetration of the basal lamina and eventual tapping of maternal blood vessels are synchronised by progesterone and estrogens.

References

- Ariel M, Cedar H, McCarry J (1994) Developmental changes in methylation of spermatogenesis-specific genes include reprogramming in the epididymis. *Nature* 7:59–63
- Asch A, Simerly C, Ord T, Ord VA, Schatten G (1995) The stage at which human fertilization arrests: microtubule and chromosome configurations in inseminated oocytes which failed to complete fertilization and development in humans. *Hum Reprod* 10:1897–1906
- Bahat A, Eisenbach M (2006) Sperm thermotaxis. *Mol Cell Endocrinol* 252:115–119
- Barone JG, De Lara J, Cummings KB, Ward WS (1994) DNA organization in human spermatozoa. *J Androl* 15:139–144
- Barratt CLR, Cooke ID (1988) Sperm loss in the urine of sexually rested men. *Int J Androl* 11:201–207
- Bastiaan HS, Windt ML, Menkveld R, Kruger TF, Oehninger S, Franken DR (2003) Relationship between zona pellucida-induced acrosome reaction, sperm morphology, sperm-zona pellucida binding, and in vitro fertilization. *Fertil Steril* 79:49–55
- Bedford JM (1988) The bearing of epididymal function in strategies for In vitro fertilization and gamete intrafollicular transfer. *New York Acad Sci USA* 541:284–291
- Bedford JM (1990) Sperm dynamics in the epididymis. In: Asch RA, Balmaceda JP, Johnston I (eds) *Gamete physiology*. Sero Symposium, Norwell, MA, pp 53–67
- Bedford JM (1994) The status and the state of the human epididymis. *Hum Reprod* 9:2187–2199
- Bedford JM (1998) Mammalian fertilization misread? Sperm penetration of the eutherian zona pellucida is unlikely to be a lytic event. *Biol Reprod* 59:1275–1287
- Bedford JM, Kim HH (1993) Sperm/egg binding patterns and oocyte cytology in retrospective analysis of fertilization in vitro. *Hum Reprod* 8:453–463

- Bedford JM, Calvin H, Cooper GW (1973) The maturation of spermatozoa in the human epididymis. *J Reprod Fertil Suppl* 18:199–213
- Benoff S, Hurley IR, Mandel FS, Cooper GW, Hershlag A (1997) Induction of the human sperm acrosome reaction with mannose-containing neoglycoproteins. *Mol Hum Reprod* 3:827–837
- Boué F, Sullivan R (1996) Cases of human infertility are associated with the absence of P34H, an epididymal sperm antigen. *Biol Reprod* 54:1018–1024
- Boué F, Duquenne C, Lassalle B, Lefèvre A, Finaz C (1995) FLB1, a human protein of epididymal origin that is involved in the sperm-oocyte recognition process. *Biol Reprod* 52:267–278
- Boué F, Blais J, Sullivan R (1996) Surface localization of P34H, an epididymal protein, during maturation, capacitation, and acrosome reaction of human spermatozoa. *Biol Reprod* 54:1009–1017
- Brandelli A, Miranda PV, Tezón JG (1996) Voltage-dependent calcium channels and Gi regulatory protein mediate the human sperm acrosomal exocytosis induced by N-acetylglucosaminyl/mannosyl neoglycoprotein. *J Androl* 17:522–529
- Breitbart H, Cohen G, Rubinstein S (2005) Role of actin cytoskeleton in mammalian sperm capacitation and the acrosome reaction. *Reproduction* 129:263–268
- Brown DB, Hayes EJ, Uchida T, Nagamani M (1995) Some cases of human male infertility are explained by abnormal in vitro human sperm activation. *Fertil Steril* 64:612–622
- Buffet C, Patrat C, Merlet F, Guibert J, Epelboin S, Thiounn N, Vieillefond A, Adda-Lievin A, Lebon C, Jouannet P (2006) ICSI outcomes in obstructive azoospermia: influence of the origin of surgically retrieved spermatozoa and the cause of obstruction. *Hum Reprod* 21:1018–1024
- Carr DW, Newell AE (2007) The role of A-kinase anchoring proteins (AKaps) in regulating sperm function. *Soc Reprod Fertil Suppl* 63:135–141
- Carr DW, Usselman MC, Acott TS (1985) Effects of pH, lactate, and viscoelastic drag on sperm motility: a species comparison. *Biol Reprod* 33:588–595
- Carra E, Sangiorgi D, Gattuccio F, Rinaldi AM (2004) Male infertility and mitochondrial DNA. *Biochem Biophys Res Commun* 322:333–339
- Chakrabarti R, Cheng L, Puri P, Soler D, Vijayaraghavan S (2007) Protein phosphatase PP1 gamma 2 in sperm morphogenesis and epididymal initiation of sperm motility. *Asian J Androl* 9:445–452
- Chemes EH, Rawe YV (2003) Sperm pathology: a step beyond descriptive morphology. Origin, characterization and fertility potential of abnormal sperm phenotypes in infertile men. *Hum Reprod Update* 9:405–428
- Cooper TG (1993) The human epididymis – is it necessary? *Int J Androl* 16:245–250
- Cooper TG (1995a) The epididymal influence on sperm maturation. *Reprod Med Rev* 4:141–161
- Cooper TG (1995b) Epididymis: role and importance in male infertility treatment. In: Hamamah S, Mieusset R, Dacheux J-L (eds) *Frontiers in endocrinology*. Ares Serono Symposia, Rome
- Cooper TG (1996) Physiology and evaluation of epididymal function. In: Comhaire F (ed) *Male infertility*. Clinical investigation, cause evaluation and treatment. Chapman & Hall, London, pp 97–119
- Cooper TG (1998) Epididymis. In: Neill JD, Knobil E (eds) *Encyclopedia of reproduction*. Academic, San Diego, CA, pp 1–17
- Cooper TG (2002) Recent advances in sperm maturation in the human epididymis. *Andrologie* 12:38–51
- Cooper TG (2007a) Sperm maturation in the epididymis: a new look at an old problem. *Asian J Androl* 9:533–539
- Cooper TG (2007b) The human epididymis, sperm maturation and storage. *ANIR-ANHP* 9:18–21
- Cooper TG, Jockenhovel F, Nieschlag E (1991) Variations in semen parameters from fathers. *Hum Reprod* 6:859–866
- Cooper TG, Keck C, Oberdieck U, Nieschlag E (1993) Effects of multiple ejaculations after extended periods of sexual abstinence on total, motile and normal sperm numbers, as well as accessory gland secretions, from healthy normal and oligozoospermic men. *Hum Reprod* 8:1251–1258
- Cooper TG, Barfield JP, Yeung CH (2005) Changes in osmolality during liquefaction of human semen. *Int J Androl* 28:58–60
- Correa-Perez JR, Fernandez-Pelegrina R, Aslanis P, Zavos PM (2004) Clinical management of men producing ejaculates characterized by high levels of dead sperm and altered seminal plasma factors consistent with epididymal necrostermia. *Fertil Steril* 81:1148–1150
- Cross NL (2003) Decrease in order of human sperm lipids during capacitation. *Biol Reprod* 69:529–534
- Cyr DG, Gregory M, Dube E, Dufresne J, Chan PT, Hermo L (2007) Orchestration of occludins, claudins, catenins and cadherins as players involved in maintenance of the blood-epididymal barrier in animals and humans. *Asian J Androl* 9:463–475
- Dacheux JL, Belghazi M, Lanson Y, Dacheux F (2006) Human epididymal secretome and proteome. *Mol Cell Endocrinol* 250:36–42
- Dandekar P, Aggeler J, Talbot P (1992) Structure, distribution and composition of the extracellular matrix of human oocytes and cumulus masses. *Hum Reprod* 7:391–398
- De Jonge C, LaFromboise M, Bosmans E, Ombelet W, Cox A, Nijs M (2004) Influence of the abstinence period on human sperm quality. *Fertil Steril* 82:57–65
- De Kretser DM, Huidobro C, Southwick GJ, Temple-Smith PD (1998) The role of the epididymis in human infertility. *J Reprod Fertil Suppl* 53:271–275
- Delpuch S, Lecomte P, Lecomte C (1988) Etude in vitro chez l'homme de la liaison des spermatozoïdes epididymaires à la zone pellucida. *J Gynecol Obstet Biol Reprod* 17:339–342
- Djakiew D, Cardullo R (1986) Lower temperature of the cauda epididymidis facilitates the storage of sperm by enhancing oxygen availability. *Gamete Res* 15:237–245
- Dozortsev D, Rybouchkin A, De Sutter P, Dhont M (1995) Sperm plasma membrane damage prior to intracytoplasmic sperm injection: a necessary condition for sperm nucleus decondensation. *Hum Reprod* 10:2960–2964
- Dozortsev D, Neme R, Diamond MP, Abdelmassih S, Abdelmassih V, Oliveira F, Abdelmassih R (2006) Embryos generated using testicular spermatozoa have higher developmental potential than those obtained using epididymal spermatozoa in men with obstructive azoospermia. *Fertil Steril* 86:606–611
- Dubé E, Chan PT, Hermo L, Cyr DG (2007) Gene expression profiling and its relevance to the blood-epididymal barrier in the human epididymis. *Biol Reprod* 76:1034–1044

- Dubé E, Hermo L, Chan PT, Cyr DG (2008) Alterations in gene expression in the caput epididymides of nonobstructive azoospermic men. *Biol Reprod* 78:342–351
- Edirisinghe WR, Junk SM, Matson PL, Yovich JL (1996) Changes in motility patterns during in vitro culture of fresh and frozen/thawed testicular and epididymal sperm: implications for planning treatment by intracytoplasmic sperm injection. *Hum Reprod* 11:2474–2476
- Eisenbach M, Giojalas LC (2006) Sperm guidance in mammals – an unpaved road to the egg. *Nat Rev Mol Cell Biol* 7: 103–115
- Esterhuizen AD, Franken DR, Lourens JG, Lourens JG, Van Rooyen LH (2001) Clinical importance of a micro-assay for the evaluation of sperm acrosome reaction using homologous zona pellucida. *Andrologia* 33:87–93
- Evans EA, Zhang H, Martin-DeLeon PA (2003) SPAM1 (PH-20) protein and mRNA expression in the epididymides of humans and macaques: utilising laser microdissection/RT-PCR. *Reprod Biol Endocrinol* 1:54–65
- Flori F, Ermini L, La Sala GB, Nicoli A, Capone A, Focarelli R, Rosati F, Giovampaoa CD (2008) The GPI-anchored CD52 antigen of the sperm surface interacts with semenogelin and participates in clot formation and liquefaction of human semen. *Mol Reprod Dev* 75:326–335
- Franken DR, Bastiaan HS, Oehninger SC (2000) Physiological induction of the acrosome reaction in human sperm: validation of a microassay using minimal volumes of solubilized, homologous zona pellucida. *J Assist Reprod Genet* 17:156–161
- Gadella BM, Harrison RA (2002) Capacitation induces cyclic adenosine 3', 5'-monophosphate-dependent, but apoptosis-unrelated, exposure of aminophospholipids at the apical head plasma membrane of boar sperm cells. *Biol Reprod* 67:340–350
- Golan R, Cooper TG, Oschry Y, Oberpenning F, Schulze H, Shochat L, Lewin LM (1996) Changes in chromatin condensation of human spermatozoa during epididymal transit as determined by flow cytometry. *Hum Reprod* 11:1457–1462
- Green DP (1997) Three-dimensional structure of the zona pellucida. *Rev Reprod* 2:147–156.
- Haidl G, Opper C (1997) Changes in lipids and membrane anisotropy in human spermatozoa during epididymal maturation. *Hum Reprod* 12:2720–2723
- Haidl G, Badura B, Schill W-B (1994) Function of human epididymal spermatozoa. *J Androl* 15:23S–27S
- Harper CV, Barratt CL, Publicover SJ (2004) Stimulation of human spermatozoa with progesterone gradients to simulate approach to the oocyte. Induction of $[Ca^{2+}]_i$ oscillations and cyclical transitions in flagellar beating. *J Biol Chem* 279:46315–46325
- Harrison RA, Gadella BM (2005) Bicarbonate-induced membrane processing in sperm capacitation. *Theriogenology* 63:342–351
- Hirsch A, Montgomery J, Mohan P, Mills C, Bekir J, Tan SL (1993) Fertilization by testicular sperm with standard IVF techniques. *Lancet* 342:1237–1238
- Hirsch AV, Dean NL, Mohan PJ, Shaker AG, Bekir JS (1996) Natural spermatozoa in irreversible obstructive azoospermia-reservoirs of viable spermatozoa for assisted conception. *Hum Reprod* 11:1919–1922
- Hoshi K, Tsukikawa S, Sato A (1991) Importance of Ca^{2+} , K^+ and glucose in the medium for sperm penetration through human zona pellucida. *Tokoku J Exp Med* 165:99–104
- Inoue N, Ikawa M, Isotani A, Okabe M (2005) The immunoglobulin super family protein Izumo is required for sperm to fuse with eggs. *Nature* 434:234–238
- Jeyendran RS, van der Ven HH, Rosecrans R, Perez-Pelaez M, al-Hasani S, Zaneveld LJ (1989) Chemical constituents of human seminal plasma: relationship to fertility. *Andrologia* 21:423–428
- Jimenez-Gonzalez C, Michelangeli F, Harper CV, Barratt CL, Publicover SJ (2006) Calcium signalling in human spermatozoa: a specialized 'toolkit' of channels, transporters and stores. *Hum Reprod Update* 12:253–267
- Johnson L, Varner DD (1988) Effect of daily sperm production but not age on transit time of spermatozoa through the human epididymis. *Biol Reprod* 39:812–817
- Jones R, James PS, Howes L, Bruckbauer A, Klenerman D (2007) Supramolecular organization of the sperm plasma membrane during maturation and capacitation. *Asian J Androl* 9: 438–444
- Jonsson M, Linse S, Forhm B, Lundwall A, Malm J (2005) Semenogelins I and II bind zinc and regulate the activity of prostate-specific antigen. *Biochem J* 387:47–453
- Jow WW, Steckel J, Schlegel PN, Magid MS, Goldstein M (1993) Motile sperm in human testis biopsy specimens. *J Androl* 14:194–198
- Katz DF, Morales P, Samuels SJ, Overstreet JW (1990) Mechanisms of filtration of morphologically abnormal human sperm by cervical mucus. *Fertil Steril* 54:513–503
- Kim YH, Haidl G, Schaefer M, Egner U, Mandal A, Herr JC (2007) Compartmentalization of a unique ADP/ATP carrier protein SFED (sperm flagellar energy carrier, AAC4) with glycolytic enzymes in the fibrous sheath of the human sperm flagellar principal piece. *Dev Biol* 302:463–476
- Kirchhoff C (1995) Molecular biology or sperm maturation in the human epididymis. *Reprod Med Rev* 4:121–139
- Kirchhoff C (2007) Human epididymis – specific gene expression. *ANIR* 9:25–42
- Kishimoto T (2005) Developmental biology: cell cycle unleashed. *Nature* 437:1048–1052
- Kunz G, Beil D, Huppert P, Leyendecker G (2007) Oxytocin-a stimulator of directed sperm transport in humans. *Reprod Biomed Online* 14:32–39
- Lacham-Kaplan O, Trounson A (1997) Fertilization and embryonic development capacity of epididymal and testicular sperm and immature spermatids and spermatocytes. *Reprod Med Rev* 6: 55–68
- Lefevre L, Conner S J, Salpekar A, Olufowobi O, Ashton P, Pavlovic B, Lenton W, Afnan M, Brewis IA, Monk M, Hughes DC, Barratt CL (2004) Four zona pellucida glycoproteins are expressed in the human. *Hum Reprod* 19: 1580–1586
- Légaré C, Gaudreault C, St-Jacques S, Sullivan R (1999) P34H sperm protein is preferentially expressed by the human corpus epididymidis. *Endocrinology* 140:3318–3327
- Légaré C, Thabet M, Sullivan R (2004) Expression of heat shock protein 70 in normal and cryptorchid human excurrent duct. *Mol Hum Reprod* 10:197–202
- Levitas E, Lunenfeld E, Weiss N, Friger M, Har-Vardi I, Koifman A, Potashnik G (2005) Relationship between duration of sexual abstinence and semen quality; analysis of 9,489 semen samples. *Fertil Steril* 83:1680–1686
- Li JY, Wang HY, Liu J, Liu Q, Zhang JS, Wan FC, Liu FJ, Jin SH, Zhang YL (2008) Transcriptome analysis of a cDNA library from adult human epididymis. *DNA Res* 15: 115–122

- Lin Y, Mahan K, Lathrop WF, Myles DG, Primakoff P (1994) A hyaluronidase activity of the sperm plasma membrane protein PH-20 enables sperm to penetrate the cumulus cell layer surrounding the egg. *J Cell Biol* 125:1157–1163
- Lindemann CB (2007) The geometric clutch as a working hypothesis for future research on cilia and flagella. *Ann New York Acad Sci* 1101:477–493
- Linge HM, Collin M, Giwercman A, Malm J, Bjartell A, Egestan A (2008) The antibacterial chemokine MIG/CXCL9 is constitutively expressed in epithelial cells of the male urogenital tract and is present in seminal plasma. *J Interferon Cytokine Res* 28:191–196
- Liu DY, Baker HW (1994) Disordered acrosome reaction of spermatozoa bound to the zona pellucida: a newly discovered sperm defect causing infertility with reduced sperm-zona pellucida penetration and reduced fertilization in vitro. *Hum Reprod* 9:1694–1700
- Liu DY, Baker HW (2003a) Disordered zona pellucida-induced acrosome reaction and failure of in vitro fertilization in patients with unexplained infertility. *Fertil Steril* 79:74–80
- Liu DY, Baker HW (2003b) Frequency of defective sperm-zona pellucida interaction in severely teratozoospermic infertile men. *Hum Reprod* 18:802–807
- Liu DY, Baker HW (2004) High frequency of defective sperm-zona pellucida interaction in oligozoospermic infertile men. *Hum Reprod* 19:228–233
- Liu DY, Martic M, Clarke GN, Grkovic I, Garrett C, Dunlop ME, Baker HW (2002) An anti-actin monoclonal antibody inhibits the zona pellucida-induced acrosome reaction and hyperactivated motility of human sperm. *Mol Hum Reprod* 8:37–47
- Liu DY, Clarke GN, Baker HW (2005) Exposure of actin on the surface of the human sperm head during in vitro culture relates to sperm morphology, capacitation and zona binding. *Hum Reprod* 20:999–1005
- Liu DY, Liu ML, Clarke GN, Baker HW (2007a) Hyperactivation of capacitated human sperm correlates with the zona pellucida-induced acrosome reaction of zona pellucida-bound sperm. *Hum Reprod* 22:2632–2638
- Liu DY, Liu ML, Garrett C, Baker HW (2007b) Comparison of the frequency of defective sperm-zona pellucida (ZP) binding and the ZP-induced acrosome reaction between subfertile men with normal and abnormal semen. *Hum Reprod* 22:1878–1884
- Liu J, Tsai YL, Katz E, Compton G, Garcia JE, Baramki TA (1997) Outcome of in-vitro culture of fresh and frozen-thawed human testicular spermatozoa. *Hum Reprod* 12:1667–1672
- Marchetti C, Jouy N, Leroy-Martin B, Formstecher P, Marchetti P (2004) Comparison of four fluorochromes for the detection of the inner mitochondrial membrane potential in human spermatozoa and their correlation with sperm motility. *Hum Reprod* 19:2267–2276
- Mieusset R (1995) Spermatozoa and embryonic development. *Front Endocrinol* 11:105–128
- Mitchell LA, Nixon B, Baker MA, Aitken RJ (2008) Investigation of the role of SRC in capacitation associated tyrosine phosphorylation of human spermatozoa. *Mol Hum Reprod* 14:235–243
- Moghadam KK, Nett R, Robins JC, Thomas MA, Awadalla SG, Scheiber MD, Williams DB (2005) The motility of epididymal or testicular spermatozoa does not directly affect IVF/ICSI pregnancy outcomes. *J Androl* 26:619–623
- Montag M, Tok V, Liow S-L, Bongso A, Ng SC (1992) In vitro decondensation of mammalian sperm and subsequent formation of pronuclei-like structures for micromanipulation. *Mol Reprod Dev* 33:338–346
- Moore HDM, Hartmann TD, Pryor JP (1983) Development of the oocyte-penetrating capacity of spermatozoa in the human epididymis. *Int J Androl* 6:310–318
- Moore HDM, Curry MR, Penfold LM, Pryor JP (1992) The culture of human epididymal epithelium and in vitro maturation of epididymal spermatozoa. *Fertil Steril* 58:776–783
- Mortimer D (1995) In: Grudzinskas JG, Yovich JL (eds) *Gametes. The spermatozoon*. Cambridge University Press, Cambridge, pp 157–174
- Mortimer ST, Swan MA (1995) Variable kinematics of capacitating human spermatozoa. *Hum Reprod* 10:3178–3182
- Moskovtsev SI, Jarvi K, Légaré C, Sullivan R, Mullen JB (2007) Epididymal P34H protein deficiency in men evaluated for infertility. *Fertil Steril* 88:1455–1457
- Navarra CS, Simerly C, Zoran S, Schatten G (1995) The sperm centrosome during fertilization in mammals: implications for fertility and reproduction. *Reprod Fertil Develop* 7:747–754
- Neugebauer DC, Neuwinger J, Jockenhövel F, Nieschlag E (1990) '9 + 0' axoneme in spermatozoa and some nasal cilia of a patient with totally immotile spermatozoa associated with thickened sheath and short midpiece. *Hum Reprod* 5:981–986
- Nixon B, Aitken RJ, McLaughlin EA (2007) New insights into the molecular mechanisms of sperm-egg interaction. *Cell Mol Life Sci* 64:1805–1823
- Overstreet JW, Hembree WC (1976) Penetration of the zona pellucida of nonliving human oocytes by human spermatozoa in vitro. *Fertil Steril* 27:815–831
- Palermo GD, Avrech OM, Colombero LT, Wu H, Wolny YM, Fissore RA, Rosenwaks Z (1997) Human sperm cytosolic factor triggers Ca^{2+} oscillations and overcomes activation failure of mammalian oocytes. *Mol Hum Reprod* 3:367–337
- Patrizio P, Ord T, Silber SJ, Asch RH (1994) Correlation between epididymal length and fertilization rate in men with congenital absence of the vas deferens. *Fertil Steril* 61:265–268
- Phillips DM (1991) Structure and function of the zona pellucida. In: Familiari G, Makabern S, Motta PM (eds) *Ultrastructure of the ovary*. Kluwer, Den Haag, The Netherlands, pp 63–72
- Pöllänen P, Cooper TG (1994) Immunology of the testicular excurrent ducts. *J Reprod Immunol* 26:167–216
- Pöllänen P, Cooper TG, Yeung CH, Saari T (1995) Regulation of the transport of immunoglobulin G into the male rat reproductive tract. *J Reprod Immunol* 28:111–135
- Potts RJ, Jefferies TM, Notarianni LJ (1999) Antioxidant capacity of the epididymis. *Hum Reprod* 14:2513–2516
- Primakoff P, Myles DG (2007) Cell-cell membrane fusion during mammalian fertilization. *FEBS Lett* 581:2174–2180
- Qi H, Moran MM, Navarro B, Chong JA, Krapivinsky G, Krapivinsky L, Kirichok Y, Ramsey IS, Quill TA, Clapham DE (2007) All four CatSper ion channel proteins are required for male fertility and sperm cell hyperactivated motility. *Proc Natl Acad Sci USA* 104:1107–1108
- Reyes-Moreno C, Laflamme J, Frenette G, Sirard MA, Sullivan R (2008) Spermatozoa modulate epididymal cell proliferation and protein secretion in vitro. *Mol Reprod Dev* 75:512–520

- Rhouma KB, Miled EB, Attallah K, Marrakchi H, Khouja H, Sakly M (2003) Successful pregnancies after using immotile spermatozoa from ejaculate, epididymis and testis. *Eur J Obstet Gynecol Reprod Biol* 108:182–185
- Sathananthan AH, Ratnam SS, Ng SC, Tarín JJ, Gianaroli L, Trounson A (1996) The sperm centriole: its inheritance, replication and perpetuation in early human embryos. *Hum Reprod* 11:345–356
- Schultz RM (2002) The molecular foundations of the maternal to zygotic transition in the preimplantation embryo. *Hum Reprod Update* 8:323–331
- Shadan S, James PS, Howes EAJR (2004) Cholesterol efflux alters lipid raft stability and distribution during capacitation of boar spermatozoa. *Biol Reprod* 71: 253–265
- Shefi S, Raviv G, Eisenberg ML, Weissenberg R, Jalalian L, Levron J, Band G, Turek PJ, Madgar I (2006) Posthumous sperm retrieval analysis of time interval to harvest sperm. *Hum Reprod* 21:2890–2893
- Shur BD, Rodeheffer C, Ensslin MA, Lyng R, Raymond A (2006) Identification of novel gamete receptors that mediate sperm adhesion to the egg coat. *Mol Cell Endocrinol* 250: 137–148
- Sobrero AJ, MacLeod J (1962) The immediate postcoital test. *Fertil Steril* 13:184–189
- Soler C, Pérez-Sánchez F, Schulze H, Bergmann M, Oberpenning F, Yeung C, Cooper TG (2000) Objective evaluation of the morphology of human epididymal sperm heads. *Int J Androl* 23:77–84
- Sousa M, Mendoza C, Barros A, Tesarik J (1996) Calcium responses of human oocytes after intracytoplasmic injection of leukocytes, spermatocytes and round spermatids. *Mol Hum Reprod* 2:853–857
- Spehr M, Schwane K, Riffell JA, Zimmer RK, Hatt H (2006) Odorant receptors and olfactory-like signaling mechanisms in mammalian sperm. *Mol Cell Endocrinol* 250:128–136
- Staff T, Mehnert C, Hajimohammad A, Manolopoulos K, Shen Y, Schuppe HC, Diemer T, Schill WB, Weidner W, Tinneberg HR (2005) Influence of motility and vitality in intracytoplasmic sperm injection with ejaculated and testicular sperm. *Andrologia* 37:125–130
- Suarez SS, Pacey AA (2006) Sperm transport in the female reproductive tract. *Hum Reprod Update* 12:23–37
- Sullivan R, Légaré C, Villeneuve M, Foliguet B, Bissonnette F (2006) Levels of P34H, a sperm protein of epididymal origin, as a predictor of conventional in vitro fertilization outcome. *Fertil Steril* 85:1557–1559
- Sullivan R, Légaré C, Thimon V (2007) Effects of vasectomy on protein secretion and sperm maturation along the human epididymis. *ANIR* 9:43–48
- Sun F, Bahat A, Gakamsky A, Girsh E, Katz N, Giojalas LC, Tur-Kaspa I, Eisenbach M (2005) Human sperm chemotaxis: both the oocyte and its surrounding cumulus cells secrete sperm chemoattractants. *Hum Reprod* 20:761–767
- Tesarik J, Mendoza C (1992) Defective function of a nongenomic progesterone receptor as a sole sperm anomaly in infertile patients. *Fertil Steril* 58:793–797
- Tesarik J, Mendoza C (1993) Sperm treatment with pentoxifylline improves the fertilizing ability in patients with acrosome reaction insufficiency. *Fertil Steril* 60:141–148
- Tesarik J, Thebault A (1993) Fertilization failure after subzonal sperm insertion associated with defective functional capacity of acrosome-reacted spermatozoa. *Fertil Steril* 60:369–371
- Thimon V, Koukoui O, Calvo E, Sullivan R (2007) Region-specific gene expression profiling along the human epididymis. *Mol Hum Reprod* 13:691–704
- Thimon V, Calvo E, Koukoui O, Légaré C, Sullivan R (2008) Effects of vasectomy on gene expression profiling along the human epididymis. *Biol Reprod* 79:262–273
- Turner T (2008) De Graaf's thread: the human epididymis. *J Androl* 29:237–250
- Van Steirteghem AC, Nagy Z, Liu J, Joris H, Janssenswillen C, Silber S, De Vroey P (1995) Embryo development after ICSI using testicular, epididymal and ejaculated spermatozoa. In: Hamamah S, Mieusset R, Dacheux JL (eds) *Frontiers in endocrinology. Epididymis: role and importance in male infertility treatment*. Ares Sero Symposia, Rome, pp 141–147
- Visconti PE, Galantino-Homer H, Moore GD, Bailey JL, Ning X, Fornes M, Kopf GS (1998) The molecular basis of sperm capacitation. *J Androl* 19:242–248
- von Lanz T, Neuhauser G (1964) Morphometrische Analyse des menschlichen Nebenhodens. *Z f Anat Entwickl* 124:126–152
- Wassarman P (1992) Regulation of mammalian fertilization by gamete adhesion molecules. In: Nieschlag E, Habenicht UA (eds) *Spermatogenesis, fertilization, contraception. Molecular, cellular and endocrine events in male reproduction*. Springer, Berlin, pp 345–366
- Williams CJ (2002) Signalling mechanisms of mammalian oocyte activation. *Hum Reprod Update* 8:313–321
- Williamson K, Frayne J, McLaughlin EA, Hall L (1998) Expression of extracellular superoxide dismutase in the human male reproductive tract, detected using antisera raised against a recombinant protein. *Mol Hum Reprod* 4:235–242
- Yanagimachi R (1994) Mammalian fertilization. In: Knobil E, Neill JD (eds) *The physiology of reproduction*, 2nd edn. Raven, New York, pp 189–317
- Yeung CH (1995) Development of sperm infertility. In: Hamamah S, Mieusset R, Dacheux JL (eds) *Frontiers in endocrinology. Epididymis: role and importance in male infertility treatment*. Ares Sero Symposia, Rome, pp 73–86
- Yeung CH, Cooper TG (2001) Effects of the ion-channel blocker quinine on human sperm volume, kinematics and mucus penetration, and the involvement of potassium channels. *Mol Human Reprod* 7:819–828
- Yeung CH, Cooper TG (2002) Acquisition and development of sperm motility upon maturation in the epididymis. In: Robaire B, Hinton BT (ed) *The epididymis: from molecules to clinical practice. A comprehensive survey of the efferent ducts, the epididymis and the vas deferens*. Kluwer/Plenum, New York
- Yeung CH, Bals-Pratsch M, Knuth UA, Nieschlag E (1988) Investigation of the cause of low sperm motility in asthenozoospermic patients by multiple quantitative tests. *Int J Androl* 11:289–299
- Yeung CH, Cooper TG, Weinbauer GF, Bergmann M, Kleinhans G, Schulze H, Nieschlag E (1989) Fluid-phase transcytosis in the primate epididymis in vitro and in vivo. *Int J Androl* 12:384–394
- Yeung CH, Cooper TG, Bergmann M, Schulze H (1991) Organization of tubules in the human caput epididymidis and the ultrastructure of their epithelia. *Am J Anat* 191:261–279
- Yeung CH, Cooper TG, Oberpenning F, Schulze H, Nieschlag E (1993) Changes in movement characteristics of human spermatozoa along the length of the epididymis. *Biol Reprod* 49:274–280

- Yeung CH, Nashan D, Sorg C, Oberpenning F, Schulze H, Nieschlag E, Cooper TG (1994) Basal cells of the human epididymis – antigenic and ultrastructural similarities to tissue-fixed macrophages. *Biol Reprod* 50:917–926
- Yeung CH, Cooper TG, Majumder GC, Rolf C, Behre H (1996) The role of phosphocreatine kinase in the motility of human spermatozoa supported by different metabolic substrates. *Mol Hum Reprod* 2:591–596
- Yeung CH, Perez-Sanchez F, Soler C, Poser D, Kliesch S, Cooper TG (1997) Maturation of human spermatozoa (from selected epididymides of prostatic carcinoma patients) with respect to their morphology and ability to undergo the acrosome reaction. *Hum Reprod Update* 3: 205–213
- Yoshida K, Kawano N, Yoshiike M, Yoshida M, Iwamoto T, Morisawa M (2008) Physiological roles of semenogelin I and zinc in sperm motility and semen coagulation on ejaculation in humans. *Mol Human Reprod* 14:151–156
- Zamboni L (1992) Sperm structure and its relevance to infertility. An electron microscopic study. *Arch Pathol Lab Med* 116:325–344
- Zarintosh RJ, Cross NL (1996) Unesterified cholesterol content of human sperm regulates the response of the acrosome to the agonist, progesterone. *Biol Reprod* 55:19–24
- Zenke U, Jalalian L, Shen S, Turek PJ (2004) The difficult MESA: findings from tubuli recti sperm aspiration. *J Assist Reprod Genet* 21:31–35

Contents

4.1 Classification Based on Localization and Cause	87
4.2 Classification According to Therapeutic Possibilities.....	91
References.....	92

4.1 Classification Based on Localization and Cause

Infertility and **hypogonadism** are symptoms of a wide range of disorders to be dealt with in the following chapters. It is the physician's task to recognize the subtle nuances of these symptoms and to use appropriate ancillary techniques in order to arrive at the appropriate diagnosis. In andrology, as in all areas of medicine, a diagnosis as exact as possible is the prerequisite for optimal therapeutic direction. Correct therapy requires knowledge of the pathological basis of the underlying disorder.

The **causes of male infertility and hypogonadism** are located at various levels of the organism. The *testes* themselves may be affected; the causes for infertility may lie in the **excurrent seminal ducts** or in the *accessory sex glands*; there may be a disturbance of **semen deposition**, but also central structures such as the **hypothalamus** and the **pituitary** or the **androgen target organs** may be afflicted.

The **first principle** in classifying disorders of male infertility and hypogonadism is therefore the topographic **localization** of the cause. The **nature** of the cause may serve as a **second principle** of classification, e.g., endocrine, genetic, inflammatory etc.

Such a classification is used in this volume. An overview is shown in **Table 4.1**, which also indicates whether an individual disorder is associated with signs of androgen deficiency, infertility or both symptoms. Comparable classifications are also used in other andrological textbooks/chapters, giving a rough division into hormonal, testicular and post-testicular origins (de Kretser et al. 2006; Bhasin 2007).

F. Tüttelmann (✉)
Institute of Human Genetics of the University,
Vesaliusweg 12–14, D-48149 Münster, Germany
e-mail: Frank.Tuettelmann@ukmuenster.de

Table 4.1 Classification of disorders of testicular function based on localization of cause

Localization of disorder	Disorder	ICD-10	Cause	Androgen deficiency	Infertility
Hypothalamus/ pituitary	Kallmann syndrome, idiopathic hypogonadotropic hypogonadism	E23.0	Genetic disturbances of GnRH secretion due to mutations of the <i>KALI</i> , <i>FGFR1</i> , (<i>KAL2</i>), <i>PROK2</i> , <i>PROKR2</i> , <i>GPR54</i> gene (amongst others)	+	+
	Prader-Labhart-Willi syndrome	Q87.1	Genetic disturbances of GnRH secretion	+	+
	Constitutionally delayed puberty	E30.0	Delayed biological clock	+	(+)
	Secondary disturbance of GnRH secretion	E23.0	Tumors, infiltrations, trauma, irradiation, disturbed circulation, malnutrition, systemic disease	+	+
	Hypopituitarism	E23.0	Tumors, infiltrations, trauma, irradiation, ischemia, surgery	+	+
	Pasqualini syndrome	E23.0	Isolated LH deficiency	+	(+)
	Hyperprolactinemia	E22.1 (D35.2)	Adenomas, medications, drugs	+	+
Testes	Congenital anorchia	Q55.0	Fetal loss of testes	+	+
	Acquired anorchia	E89.5	Trauma, torsion, tumor, infection, surgery	+	+
	Mal descended testes	Q53.9	Testosterone, AMH deficiency, congenital, anatomical hindrance	(+)	+
	Varicocele	I86.1	Venous insufficiency (?)	(-)	+
	Orchitis	N45.-	Infection with destruction of germinal epithelium	(-)	+
	Sertoli-cell-only syndrome	N46	Congenital, acquired	-	+
	Spermatogenic arrest	N46	Congenital, acquired	-	+
	Globozoospermia	N46	Absence of acrosome formation	-	+
	Immotile cilia syndrome	N46	Lack of dynein arms	-	+
	DSD (Disorders of sexual development)		Genetic disturbance in gonadal differentiation		
	Klinefelter syndrome, 47,XXY	Q98.0	Meiotic non-disjunction	+	+
	46,XX male syndrome	Q98.2	Translocation of part of Y-chromosome	+	+
	Gonadal dysgenesis	Q96.9	Varying genetic disturbances	+	+
	Persistent oviduct	-	AMH receptor mutation	-	(-)
	Leydig cell hypoplasia	E29.1	LH receptor mutation	+	(+)
	Disorders of steroid synthesis (Male pseudohermaphroditism)	E29.1	Enzymatic defects in testosterone synthesis	+	+
	47,YYY syndrome	Q98.5	Meiotic non-disjunction	(+)	(+)
	Noonan syndrome	Q87.1	Mutations of the <i>PTPN11</i> , <i>KRAS</i> , <i>SOS1</i> , and <i>RAF1</i> gene	+	+
	Structural chromosomal anomalies	Q99.-	Deletions, translocations, etc.	-	+
	Testicular tumors	C62.-	Congenital/acquired?	+	+
	Disorders caused by exogenous factors or systemic disease	div.	Medication, irradiation, heat, environmental and recreational toxins, liver cirrhosis, renal failure	+	+
	Idiopathic infertility	N46	?	-	+
	Mixed hypothalamus/pituitary/ testes	Late-onset hypogonadism (LOH)	-	Primary and secondary hypogonadism	+

Table 4.1 (continued)

Localization of disorder	Disorder	ICD-10	Cause	Androgen deficiency	Infertility
Excurrent seminal ducts and accessory sex glands	Infections	N49.-	Bacteria, viruses, Chlamydia	–	+
	Obstructions	N50.8	Congenital anomalies, infections, vasectomy, appendectomy, herniotomy, kidney transplantation	–	+
	Cystic fibrosis	E84.-	Mutations of the <i>CFTR</i> -gene	–	+
	CBAVD (congenital bilateral aplasia of the vas deferens)	Q55.3	Mutations of the <i>CFTR</i> -gene	–	+
	Disturbance of liquefaction	–	?	–	+
Disturbed semen deposition	Immunologic infertility	N46	Autoimmunity	–	+
	Ectopic urethra	Q54.- Q64.0	Congenital	–	(+)
	Penis deformation	N48.8 Q55.6	Congenital/acquired	–	(+)
	Erectile dysfunction	F52.2 N48.4	Multifactorial origin	(+)	(+)
	Disturbed ejaculation	F52.3/4	Congenital/acquired	–	+
Androgen target organs	Phimosis	N47	Congenital	–	(+)
	Complete Androgen Insensitivity syndrome (CAIS)	E34.51	Androgen receptor defect	+	+
	Reifenstein syndrome	E34.50	Mild androgen receptor defect	+	+
	Prepenile scrotum bifid and hypospadias	E34.50	Mild androgen receptor defect	+	+
	Bulbospinal-muscular atrophy	G12.1	Androgen receptor defect	(+)	–
	Perineoscrotal hypospadias with pseudovagina	E29.1	5 α -reductase deficiency	+	+
	Estrogen resistance	E28.0	Estrogen receptor defect	(–)	(–)
	Estrogen deficiency	–	Aromatase deficiency	(–)	(–)
	Gynecomastia	N62	?	(+)	(–)
Androgenic alopecia	L64.9	?	–	–	

Similarly, the **International Classification of Diseases (ICD)** is oriented according to localization and cause of **infertility** and **hypogonadism**. **Table 4.1** provides the relevant ICDs whose categorization of diseases is, however, largely too unprecise, especially for scientific evaluation; further subdivisions and/or a combination of several diagnoses have proven useful for complete description of patients.

In addition to this vertical classification of disorders, factors must be considered which are targeted at several specific levels or which are of general importance. There may be special aspects of fertility, infertility and genetic risks for the offspring of **older men**; endocrine alterations and the possibility of hormone replacement therapy in advanced age are of increasing interest. Therefore, a special chapter is devoted to the aging male (Chap. 14).

General and systemic diseases may affect all or several of the above-mentioned levels at the same time and may thus exert their impact on testicular function and fertility; therefore general diseases will be dealt with in a separate chapter (Chap. 18). The impact of **toxins and environmental factors** on fertility is not yet fully understood and requires further intensive research; these issues are summarized in a special chapter (Chap. 19). In all disorders **psychological factors** play an important role, in some they may even be their cause; therefore, the psychology of male infertility and sexual medicine are reviewed in individual chapters (Chaps. 25 and 26).

In addition, there is a large group of patients in whom no clear cause of infertility can be identified. These patients most likely represent a heterogeneous group whose so-called **idiopathic infertility** may have

very different causes. It is a compelling task of andrology to investigate these causes by intensive research. In these patients, seminal parameters may be normal or subnormal and may then be described by the terminology of oligo-, astheno- and teratozoospermia. Such symptomatic description fails to provide any clue to pathophysiology. Idiopathic infertility will be dealt with in the context of therapeutic measures (Chap. 22).

Today **Disorders of Sexual Development (DSD)** is the correct and systematic designation for intersexuality, hermaphroditism and pseudohermaphroditism, terms which have been eliminated for various reasons. First, these are generally not pathophysiologically

distinct and secondly, it is advisable to abolish these discriminating terms when dealing with patients. Moreover, the transitions from completely normal to an intersexual phenotype may be indistinct, here the disorders of sexual differentiation have been assigned according to their levels of causation. The various disorders (to the extent that they refer to the male) are thus discussed in “Disorders at the Testicular Level” (Chap. 13) (e.g., Disorders of Testosterone Biosynthesis or Leydig Cell Hypoplasia) or under “Disorders of Androgen Target Organs” (Chap. 17) (e.g., Complete Androgen Insensitivity and Reifenstein Syndrome) according to the above-mentioned principles.

Table 4.2 Percentage distribution of diagnoses of 12,945 patients attending the Institute of Reproductive Medicine of the University of Münster based on the clinical databank Androbase®. 1,446 (=11.2%) of these patients were azoospermic. In the event of several diseases, only the leading diagnosis was included

Diagnosis	Unselected patients (N = 12.945)	Azoospermic patients (N = 1.446)
<i>All</i>	100%	11.2%
<i>Infertility of known (possible) cause</i>	42.6	42.6
Maldescended testes (current/former)	8.4	17.2
Varicocele	14.8	10.9
Infection	9.3	10.5
Autoantibodies against sperm	3.9	–
Testicular tumor	1.2	2.8
Others	5.0	1.2
<i>Idiopathic infertility</i>	30.0	13.3
<i>Hypogonadism</i>	10.1	16.4
Klinefelter syndrome (47, XXY)	2.6	13.7
XX-male	0.1	0.6
Primary hypogonadism of unknown cause	2.3	0.8
Secondary (hypogonadotropic) hypogonadism	1.6	1.9
Kallmann syndrome	0.3	0.5
Idiopathic hypogonadotropic hypogonadism	0.4	0.4
Residual after pituitary surgery	<0.1	0.3
Others	0.8	0.8
Late-onset hypogonadism	2.2	–
Constitutional delay of puberty	1.4	–
<i>General/systemic disease</i>	2.2	0.5
<i>Cryopreservation due to malignant disease</i>	7.8	12.5
Testicular tumor	5.0	4.3
Lymphoma	1.5	4.6
Leukemia	0.7	2.2
Sarcoma	0.6	0.9
<i>Disturbance of erection/ejaculation</i>	2.4	–
<i>Obstruction</i>	2.2	10.3
Vasectomy	0.9	5.3
Cystic fibrosis, CBAVD	0.5	3.1
Others	0.8	1.9
<i>Gynecomastia</i>	1.5	0.2
<i>Y-chromosomal deletion</i>	0.3	1.6
<i>Other chromosomal aberrations</i>	0.2	1.3
Translocations	0.1	0.3
Others	<0.1	0.3
<i>Others</i>	0.7	1.3

Prevalence and **incidence** of the various disorders – to whatever extent known – will be reported in the appropriate paragraphs. [Table 4.2](#) provides an overview of the frequency of individual disorders as they may occur in a larger center of andrology/reproductive medicine. These data were extracted from the database Androbase® (Tüttelmann et al. 2006) established by our institute and comprise about 13,000 of our patients.

4.2 Classification According to Therapeutic Possibilities

Unlike the previously described classification of andrological disorders based on localization of origin and cause, a purely pragmatic classification based on treatment modalities is also possible. Such a classification

largely ignores pathophysiological considerations, with the primary question of whether and how to treat the patient receiving priority. When talking to patients it is useful to have, along with a systematic pathophysiological classification, similarly organized possibilities at one's fingertips. For this reason, such an overview is presented and briefly explained in [Table 4.3](#).

As described in the following chapters, there is a series of fertility disturbances whose pathophysiological origins are known and which can be **treated rationally**. For some diseases for which the cause is known **rational therapies** are not yet available. For others, e.g., anomalies of testicular descent and infections, **preventive treatment** can potentially avoid infertility. Techniques of assisted reproduction (intrauterine insemination, in vitro fertilization and intracytoplasmic sperm injection) offer effective treatment of male infertility which can, however, only be considered **symptomatic therapy** as they

Table 4.3 Classification of male infertility according to therapeutic possibilities

Disorder	Therapy	Discussed in section of this volume
<i>Rational therapy</i>		
IHH and Kallmann syndrome	GnRH or gonadotropins	12
Pituitary insufficiency	Gonadotropins	12
Prolactinoma	Dopamine agonists	12
Infections	Antibiotics	15
Chronic general disease (e.g., renal insufficiency, diabetes mellitus)	Treatment of underlying disease	18
Medication, drugs, toxins	Elimination	18/19
Obstructive azoospermia	Epididymovasostomy, vasovasostomy, TESE	15
Erectile dysfunction	Psychosexual counseling, PDE-5 inhibitors, prostaglandin injections	16/25/26
Retrograde ejaculation	Imipramine, Midodrine	16
<i>Preventive therapy</i>		
Maldescended testes	Orchidopexy (GnRH/hCG)	13
Delayed puberty	Testosterone/GnRH/hCG	12
Infections	Timely use of antibiotics	15
Exogenous factors (X-rays, drugs, toxins)	Elimination	18/19
Malignant disease	Gonadal protection/cryopreservation of sperm	24
<i>No causal therapy</i>		
Bilateral anorchia	(Testosterone substitution)	13/21
Complete SCO syndrome	–	13
Gonadal dysgenesis	(Testosterone substitution)	13
<i>Empirical therapy</i>		
Idiopathic infertility	Various medications	22
Immunologic infertility	Immunosuppression	15
Varicocele	Optimization of female reproductive function/intervention	13
<i>Symptomatic therapy</i>		
Severe fertility disturbance	Assisted reproduction (IUI/IVF/ICSI/TESE)	23

do not eliminate the cause of disturbed fertility (see Chap. 23). Thus they are applied independently of the diagnosis and exclusively on the basis of ejaculate parameters or extractability of sperm from the epididymis or testis.

Prior to the introduction of assisted reproduction (especially before ICSI) many **empirical therapies** were used for male infertility. These were and continue to be used indiscriminately in various diagnoses. This applies most frequently to **varicocele, immunological infertility** and especially **idiopathic infertility**. Together these cases comprise almost half of the patients with disturbed fertility (see Table 4.2). Because of the dimensions of the problem empirical treatment of idiopathic infertility is dealt with in a separate Chap. 22, whereas varicocele (see Chap. 13) and immunologi-

cal infertility (see Chap. 15) are discussed in the context of the volume's classification.

References

- Bhasin S (2007) Disorders of the testes and the male reproductive tract (Chap. 18). In: Kronenberg HM, Melmed S, Polonsky KS, Larsen PR (eds) Williams textbook of endocrinology, 11th edn. Saunders, St. Louis, MO
- de Kretser DM, O'Bryan MK, Lynch M, Reilly A, Kennedy C, Cram D, McLachlan RI (2006) From bench to clinic (Chap. 16). In: Carell DT (ed) The genetics of male infertility. Humana Press, Totowa, NJ
- Tüttelmann F, Luetjens CM, Nieschlag E (2006) Optimising workflow in andrology: a new electronic patient record and database. *Asian J Androl* 8:235–241

Contents

5.1 Anamnesis	93
5.2 Physical Examination	94
5.2.1 Body Proportions, Skeletal Structure, Fat Distribution	94
5.2.2 Voice	95
5.2.3 Skin and Hair	95
5.2.4 Olfactory Sense.....	96
5.2.5 Mammary Gland.....	97
5.2.6 Testis	97
5.2.7 Epididymis.....	99
5.2.8 Pampiniform Plexus.....	99
5.2.9 Deferent Ducts	99
5.2.10 Penis.....	100
5.2.11 Prostate and Seminal Vesicles.....	100
References	100

5.1 Anamnesis

Anamnesis and physical examination are the basis of all medical procedures. Especially in the field of andrology and reproductive medicine, they are vital for establishing a relationship of trust between physician and patient, without which the physician will not receive required information in an area that continues to be characterized by strong taboos. Anamnesis and a thorough physical examination provide the signals for further diagnostics and therapy.

The **anamnesis** provides important information for the assessment of testicular function. Impairment of general performance, a diminution of beard growth and a decrease in shaving frequency, a decrease in erection frequency, particularly spontaneous nocturnal and morning erections, and a lessening of sexual desire and fantasies provide important information on **possible androgen deficiency**. Because of a concomitant decrease in libido, patients' complaints may be muted in contrast to those generated by erectile dysfunction not caused by testosterone deficiency.

Important aspects emerge from suspicions aroused by particular clinical pictures. In the case of a suspected pituitary tumor, for example, the field of vision should be checked for impairment; in the case of a suspected Kallmann syndrome with hypergonadism of hypothalamic origin, disturbances of the olfactory sense have to be considered.

As regards **medical history**, onset of puberty, voice mutation and the beginning of beard growth have to be recorded. Any testicular maldescent and the age at which medical therapy (hCG or GnRH) or surgery (orchidopexy) were carried out are of importance. Herniotomy, possibly with subsequent testicular damage, is to be recorded. Since general diseases (diabetes mellitus, liver

E. Nieschlag (✉)
Centre of Reproductive Medicine and Andrology of the
University, Domagkstraße 11, D-48149 Münster, Germany
e-mail: Eberhard.Nieschlag@ukmuenster.de

or kidney diseases) can lead to hypogonadism and/or infertility, the relevant symptoms must be noted (see Chap. 18). Recurrent bronchitis or sinusitis in childhood or adulthood indicate diseases of the respiratory system which may, e.g., in cases of ciliary dyskinesia, Kartagener syndrome, Young syndrome or cystic fibrosis, be associated with infertility. Infectious diseases with or without clinically manifest orchitis or epididymitis can lead to androgen deficiency and/or infertility. Sexually transmitted diseases (syphilis, gonorrhoe, AIDS) and their respective treatments must be recorded.

The **family medical history**, including data on the fertility status of parents, siblings and other relatives, provides essential information for a possible genetic cause of hypogonadism and infertility. Often, establishing a pedigree is indispensable to obtain clues to the inheritance of certain conditions and syndromes.

An exact **drug history** is important, since a multitude of substances can lead to side-effects of androgen deficiency and infertility (e.g., sulfasalazine, anti-hypertensive drugs, antibiotics, cytostatic agents, anabolic hormones) (see Chap. 18). Occupational exposure to heat and chemicals can lead to infertility. In addition, exposure to **exogenous toxins**, which may impair spermatogenesis and testicular testosterone production, should be carefully recorded (see Chap. 19). Athletic activities, particular habits and nicotine and alcohol abuse are rarely mentioned spontaneously and must be probed insistently by the physician.

Since involuntary childlessness is a problem common to the **couple**, the medical history should be taken in the presence of both partners. In case of infertility, the duration of childlessness, unprotected intercourse and intercourse frequency are docu-

mented. Periodic separations, e.g., because of shift-work or frequent travel, are recorded. Indications for dyspareunia and (perhaps temporary) erectile dysfunction should also be pursued. Professional or private stress factors which may lead to conflicts between the partners are explored. Earlier pregnancies with the present partner or in another partnership are also recorded. Both previously performed or anticipated infertility examinations of the female partner should be noted.

Special **psychological and sexological problems** are dealt with in Chaps. 25 and 26.

5.2 Physical Examination

A thorough physical examination provides an overview of all organ systems and of diseases which may be associated with hypogonadism and/or infertility. In the following sections, special examinations are mentioned when hypogonadism or infertility are suspected. It should be kept in mind that the clinical presentation of hypogonadism is dependent on the time of manifestation (Table 5.1). If androgen deficiency becomes manifest after puberty, clinical symptoms can be very discrete.

5.2.1 Body Proportions, Skeletal Structure, Fat Distribution

If androgen deficiency exists at the time of normal onset of puberty, **eunuchoid tall stature** will result because

Table 5.1 Symptoms of hypogonadism relative to age of manifestation

Affected organ/function	Before completed puberty	After completed puberty
Bones	Eunuchoid tall stature, osteoporosis	Osteoporosis
Larynx	No voice mutation	No change of voice
Hair	Horizontal pubic hairline, straight frontal hairline, diminished beard growth	Diminishing secondary body hair
Skin	Absent sebum production, lack of acne, pallor, skin wrinkling	Decreased sebum production, lack of acne, pallor, skin wrinkling
Bone marrow	Low degree anemia	Low degree anemia
Muscles	Underdeveloped	Atrophy
Penis	Infantile	No change of size
Testes	Possibly maldescended testes, small volume	Decrease of testicular volume
Spermatogenesis	Not initiated	Involuting
Prostate	Underdeveloped	Atrophy
Libido and potency	Not developed	Erectile dysfunction

of delayed or absent pubertal development with delayed epiphyseal closure. Consequently, arm span (measured from the tip of one middle finger to the other while arms are stretched out) will exceed body length and the legs become longer than the trunk. Because of these characteristic body proportions these patients appear short when sitting (“**sitting dwarfs**”) and tall while standing (“**standing giants**”). Patients may remain short if other central disorders are present, especially those affecting thyroid function or growth factors. However, bodily proportions will develop similarly to those seen in eunuchoid tall stature. Onset of androgen deficiency after puberty will not result in a change of bodily proportions, although the **musculature can be atrophic** depending on the duration and degree of androgen deficiency (Table 5.1).

Long-standing androgen deficiency leads to **osteoporosis** which can result in severe **lumbago** and pathological spine and hip **fractures**. The androgen deficiency does not directly cause an increase in subcutaneous fatty tissue; however, **fat distribution** will have female characteristics (hips, buttocks, lower abdomen). Exact measurement of **abdominal circumference** (by tape measure) is part of every medical status, as it not only correlates with testosterone levels (Svartberg et al. 2004) (Fig. 5.1) but also with life expectancy (Pischon et al. 2008). There is a good correlation between bodily fat distribution measured by DXA and the quotient of abdominal circumference and height (Ketel et al. 2007).

5.2.2 Voice

In normal physiology, larynx growth correlates with testicular growth and increase of biologically active testosterone during puberty (Pedersen 1986; Harries et al. 1997). If hypogonadism is present before normal puberty, **no voice mutation** will occur because of a lack of laryngeal growth. Often patients are addressed as females despite advanced age, especially on the telephone, with negative effects on the patient’s self-esteem. When hypogonadism develops after puberty, the voice, already mutated, remains unchanged.

5.2.3 Skin and Hair

When puberty fails to occur, the **frontal hairline** remains straight. **Temporal hair recession** or **balding** will not occur, but remain if androgen loss occurs after puberty, and secondary sexual hair and body hair become sparser (Randall 2004). When evaluating hair distribution, the Hamilton scale (Fig. 5.2) can be consulted. Non-occurrence or only partial puberty causes lack of or sparseness of **beard growth**, shaving is seldom or never necessary. Even Shakespeare noted, “He that hath a beard is more than a youth, And he that hath no beard is less than a man” (Much Ado About Nothing, 1600). The **upper pubic hairline** remains horizontal.

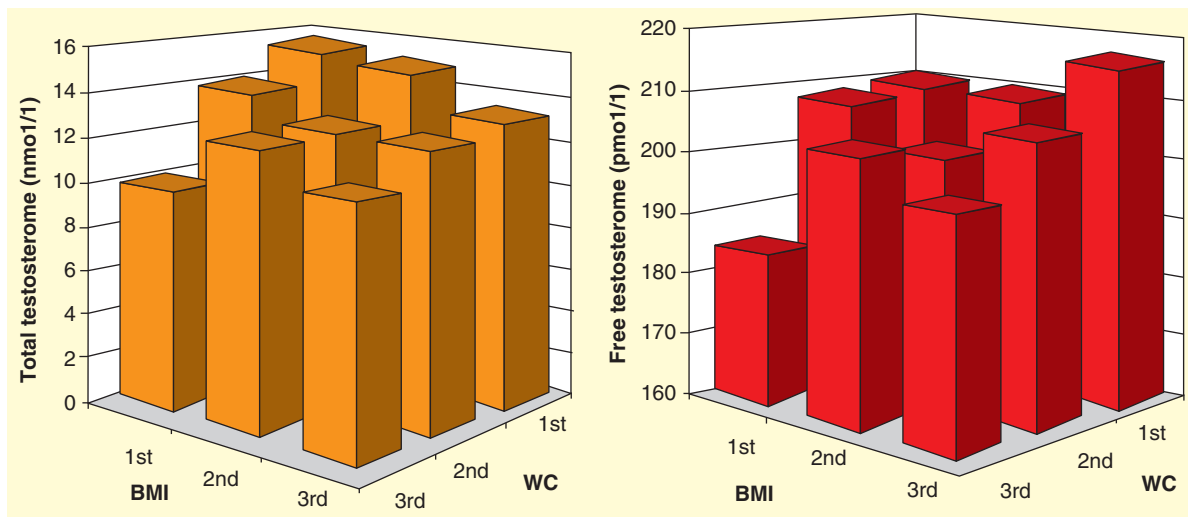
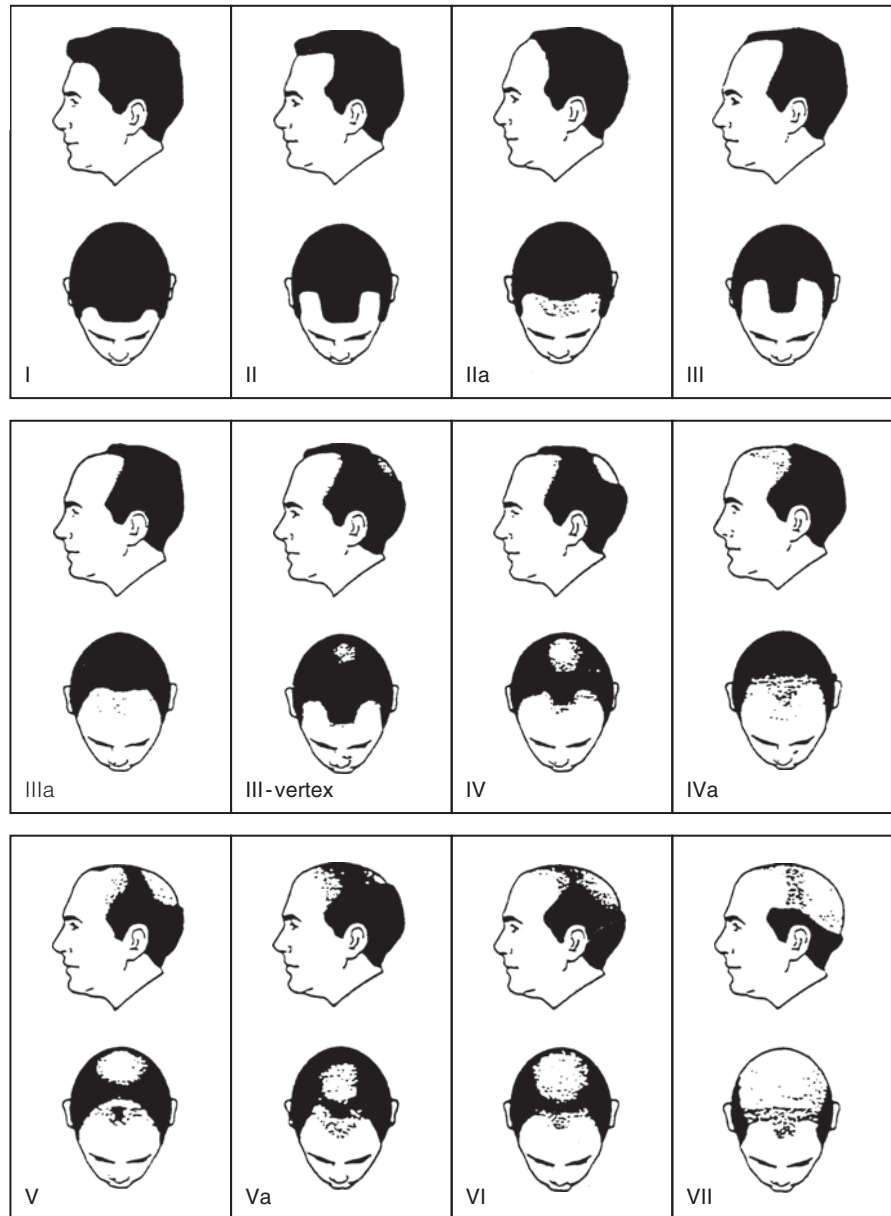

Fig. 5.1 Correlation between total and free serum testosterone with tertiles of BMI (<24.5, 24.5–27.3 and >27.3 kg/m²) and waist circumference (<91.1, 92.1–98.5 and >98.5 cm) in 1,548 men with an average age of 60.3 (25–84) years (Svartberg et al. 2004)

Fig. 5.2 Hamilton classification of the development of male hair patterns and androgenetic alopecia (Norwood 1975)



Polymorphism of the androgen receptor (CAG repeats in exon 1) is discussed as a determinant of hair pattern (Ellis et al. 2001). When evaluating hair distribution, ethnic differences must be considered (Santner et al. 1998).

Another typical feature is early, **fine wrinkling of the perioral and periorbital skin**. Additionally, because sebaceous gland stimulation is absent, the skin remains dry (Imperato-McGinley et al. 1993). Anemia, along with decreased blood circulation of the skin, causes pallor.

5.2.4 Olfactory Sense

The existence of **hyposmia** or **anosmia**, which are important diagnostic indicators of Kallmann syndrome, are recorded following specific questioning and systematic examination. Patients with Kallmann syndrome are unable to smell aromatic substances (e.g., vanilla, lavender). Substances irritating to the trigeminal nerve (e.g., ammonia) are, however, recognizable.

5.2.5 Mammary Gland

Gynecomastia is defined as enlargement of the mammary gland in the male. It must be distinguished by palpation or sonography from pure **lipomastia**. In most cases gynecomastia is bilateral, more rarely unilateral without side preference. The stages of breast development can be distinguished according to the scheme by Tanner usually used for girls (Fig. 5.3) (Marshall and Tanner 1969). In cases of marked, especially unilateral enlargement, and suspicious findings at palpation, a **mammography** should be performed for diagnosis of a possible mammary cancer. Gynecomastia can cause breast tension and the mamillae may be sensitive to touch. In most cases, however, gynecomastias are asymptomatic.

Gynecomastia develops frequently in pubescent boys at the age of about 14 years and disappears within 2–3 years. Concomitant obesity augments and prolongs the clinical picture. Gynecomastia can occasionally persist into adulthood without clinical significance. It may again appear in the aging male. Small, firm testes in combination with gynecomastia are typical for Klinefelter syndrome. Gynecomastia can also be present in other forms of primary hypogonadism or diseases of androgen target organs. Hyperprolactinemia can lead to gynecomastia which is caused more often by concomitant hypogonadism than by the increased prolactin itself.

Rapidly developing gynecomastia may indicate an **endocrinologically active testicular tumor**. The symptom triad gynecomastia, loss of libido and testicular tumor is characteristic. **Careful palpation and sonography of the testes is obligatory in all cases of gynecomastia.**

Testicular tumors (Leydig cell tumor; embryonic carcinoma, teratocarcinoma, chorioncarcinoma, combination tumor) lead either directly or via elevated hCG secretion to increased estradiol production by the Leydig cells. Chronic, general illnesses (e.g., liver cirrhosis, terminal renal failure under hemodialysis, hyperthyroidism) can also cause gynecomastia. A large number of **drugs**, with quite different mechanisms of action, may exacerbate gynecomastia.

5.2.6 Testis

The normal testis has a firm **consistency**. When LH and FSH stimulation are absent the testes are usually

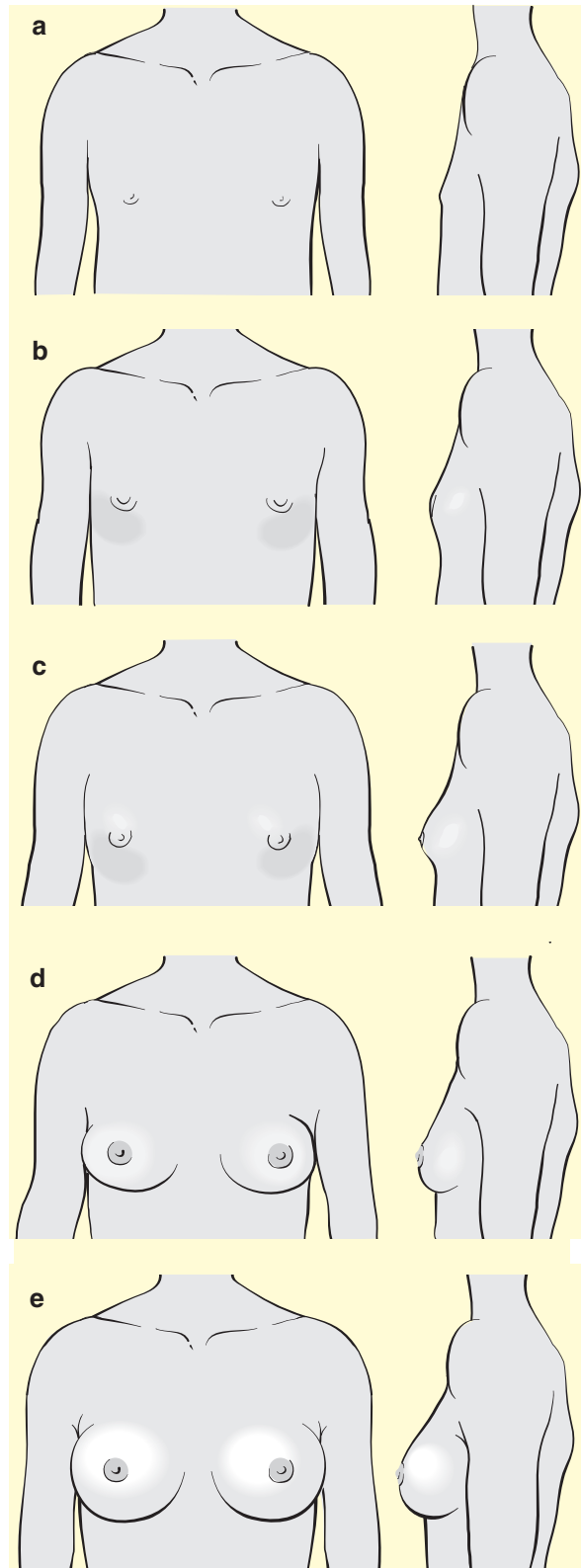

Fig. 5.3 The five Tanner stages of the development of the female breast, which can also be used for the classification of gynecomastia (Marshall and Tanner 1969)

soft; small, very firm testes are typical for Klinefelter syndrome (Fig. 5.4) Fluctuating to tightly elastic consistency indicates a hydrocele, which is confirmed through diaphanoscopy or, preferably, through ultrasonography. Differences in testicular consistency between the two sides, a very hard testis or an uneven surface raise suspicion of a testicular tumor. Testicular size is determined by palpation and comparison to testis-shaped models of defined sizes (Prader orchidometer).

A healthy European man has, on average, a **testicular volume** of 18 ml per testis; the normal range lies between 12 and 30 ml. A higher testicular volume is known as megalotestis (Meschede et al. 1995). Although exactness in determining testicular volume increases with the experience of the investigator palpating the testis, the margin of error remains great. Especially in cases of incomplete testicular descent and intrascrotal pathological processes, ultrasound imaging should be carried out (Behre et al. 1989; Carlsen et al. 2000; Sakamoto et al. 2007). As testicular volume is largely correlated with sperm production (Figs. 9.4 and 9.5), normal testicular volume with azoospermia raises suspicion of obstructed seminal ducts.

The presence of **maldescended testes** or **anorchia** should be recorded.

In the case of **cryptorchidism**, the testis lies intra-abdominally or retroperitoneally above the inguinal canal and cannot be palpated or seen.

The **inguinal testis** is a testis fixed in the inguinal canal.

The **retractile testis** is located at the orifice of the inguinal canal and can be temporarily moved to the scrotum, or migrates spontaneously between the scrotum and the inguinal canal, e.g., in response to cold or coitus.

In the case of an **ectopic testis**, the testis lies outside the normal path of descent (e.g., either femoral or inguinal).

Palpation is performed with the patient standing or supine. Exposure to cold, stimulation and excitement of the patient are to be avoided, since they can induce the cremasteric reflex and thus cause retraction of the testis. Ultrasonography is especially indicated when diagnosing maldescended testes. In cases of bilateral cryptorchidism or ectopic testes, measuring anti-Müllerian hormone (AMH) or performing an hCG-test distinguishes the condition from anorchia (see Sect. 7.5). When testes are unpalpable, they can be localized by **magnetic resonance tomography**, as the imaging method of choice.

Fig. 5.4 Distribution of bilateral testicular volume in 160 Klinefelter patients and 137 eugonadal men seen at the Institute for Reproductive Medicine, University of Münster

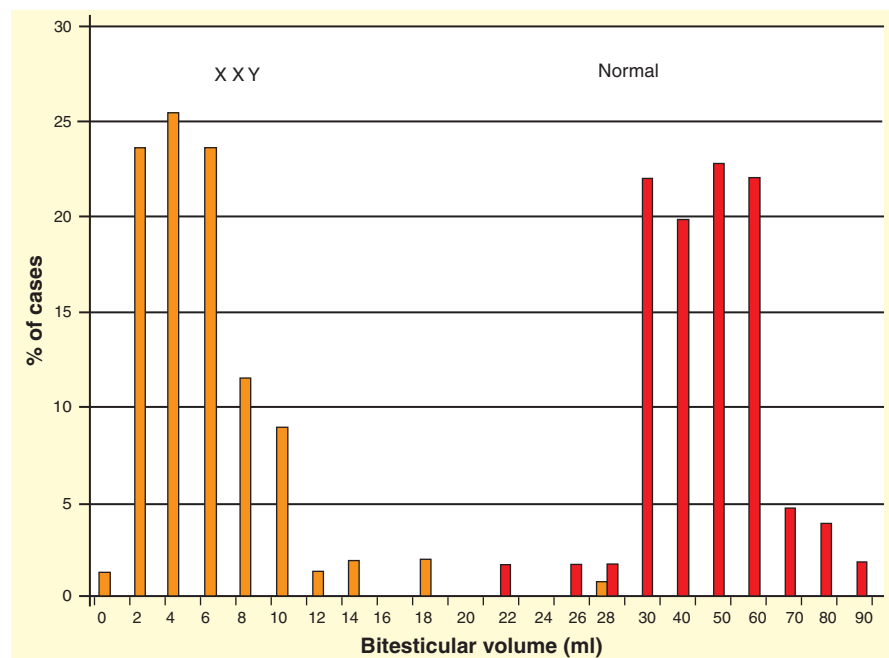

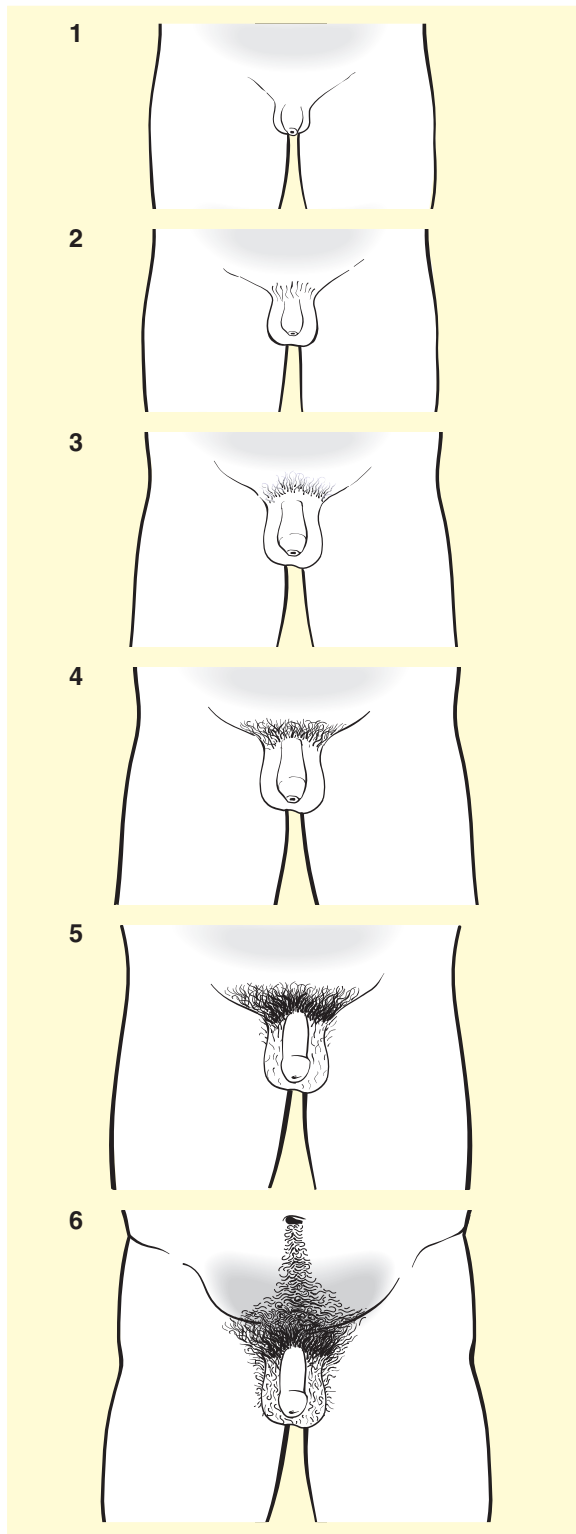

Fig. 5.5 Stages of genital pubertal development in boys (Marshall and Tanner 1970)

5.2.7 Epididymis

The normal epididymis can be palpated as a soft organ in a cranio-dorsal position relative to the testis. Smooth cystic distensions indicate a distal **obstruction**; indurations indicate an obstruction caused by diseases such as gonorrhoe or epididymitis. **Spermatoceles** appear as tense-elastic spherical formations, mainly in the area of the head of the epididymis. Painful swelling of the epididymis indicates acute or chronic **inflammation**, soft tumorous swelling of the epididymis can be found in rare cases of a tuberculoma.

5.2.8 Pampiniform Plexus

A **varicocele**, a distension of the venous pampiniform plexus, usually appearing on the left side, will be diagnosed by careful palpation of the standing patient. During the Valsalva maneuver, with increasing abdominal pressure, the veins distend. Depending on the results of palpation, the varicocele is assigned to one of the following grades.

- **I° varicocele** can be palpated only during the Valsalva maneuver.
- **II° varicocele** can be palpated without a Valsalva maneuver.
- **III° varicocele** is a visible distension of the pampiniform plexus.

While III° varicoceles can be easily diagnosed, diagnosis of smaller varicoceles depends largely on the experience of the investigator. In addition, palpation can be complicated by previous surgery, hydroceles or maldescended testes. Here, ultrasonography offers the best methods for diagnosis.

5.2.9 Deferent Ducts

Using thumb and index finger, the deferent duct can be palpated between the vessels of the spermatic chord in the upright, standing patient. Absence of the deferent duct leads to obstructive azoospermia. Obstructive azoospermia caused by congenital malformation of the epididymis and/or deferent duct (unilateral or bilateral **congenital aplasia of the vas deferens = CBAVD**) is

found in approximately 2% of infertile patients attending infertility clinics (see Chap. 15). Partial obliterations or aplasias of the deferent duct can escape palpation. In such cases, surgical exploration of the scrotal content is indicated.

5.2.10 Penis

Normal penile growth and development during puberty can be divided into six stages (Fig. 5.5) (Marshall and Tanner 1970). The penis remains infantile if hypogonadism becomes manifest before onset of normal puberty. If hypogonadism appears after puberty, changes of penile size will not occur. Among adult Europeans the erect penis is between 11 and 15 cm long (Baker and Bellis 1995). During examination of the penis, the urethral orifice has to be localized, as even minor forms of **hypospadias** can lead to infertility. **Phimosis** is diagnosed by attempted retraction of the prepuce. **Deviations** of the penis during erection and resulting problems of cohabitation should be described by the patient and documented by autophotography.

5.2.11 Prostate and Seminal Vesicles

Rectal examination reveals the normal prostate gland to have a smooth surface and the size of a horse chestnut. In cases of hypogonadism prostate volume remains small and the normal age-dependent increase in volume is not seen. A doughy, soft consistency points to prostatitis, general enlargement to benign prostatic hyperplasia (BPH), knobby surface and hard consistency to a carcinoma. Significantly more information can be obtained from simultaneous transrectal sonography of the prostate and seminal vesicles (see Chap. 6).

References

- Baker RR, Bellis MA (1995) Human sperm competition. Copulation, masturbation and infidelity. Chapman & Hall, London
- Behre HM, Nashan D, Nieschlag E (1989) Objective measurement of testicular volume by ultrasonography: evaluation of the technique and comparison with orchidometer estimates. *Int J Androl* 12:395–403
- Carlsen E, Andersen AG, Buchreitz L, et al. (2000) Inter-observer variation in the results of clinical andrological examination including estimation of testicular size. *Int J Androl* 23: 248–253
- Ellis JA, Stebbing M, Harrap SB (2001) Polymorphism of the androgen receptor gene is associated with male pattern baldness. *J Invest Dermatol* 116:452–455
- Harries ML, Walker JM, Williams DM, Hawkins S, Hughes IA (1997) Changes in the male voice at puberty. *Arch Dis Child* 77:445–447
- Imperato-McGinley J, Gautier T, Cai LQ, Yee B, Epstein J, Pochi P (1993) The androgen control of sebium production. Studies of subjects with dihydrotestosterone deficiency and complete androgen insensitivity. *J Clin Endocrinol Metab* 76:524–528
- Ketel IJG, Volman MNM, Seidell JC, Stehouwer CDA, Twisk JW, Lambalk CB (2007) Superiority of skinfold measurements and waist over waist-to-hip ratio for determination of body fat distribution in a population-based cohort of Caucasian Dutch adults. *Eur J Endocrinol* 156:655–661
- Marshall WA, Tanner JM (1969) Variations in pattern of pubertal changes in girls. *Arch Dis Child* 44:291–303
- Marshall WA, Tanner JM (1970) Variations in pattern of pubertal changes in boys. *Arch Dis Child* 45:13–23
- Meschede D, Behre HM, Nieschlag E (1995) Endocrine and spermatological characteristics of 135 patients with bilateral megalotestis. *Andrologia* 27:207–212
- Norwood OT (1975) Male pattern baldness: classification and incidence. *South Med J* 68:1359–1365
- Pedersen MF, Møller S, Krabbe S, Bennett P (1986) Fundamental voice frequency measured by electroglottography during continuous speech. A new exact secondary sex characteristic in boys in puberty. *Int J Pediatr Otorhinolaryngol* 11:21–27
- Pischon T, Boeing H, Hoffmann K, et al. (2008) General and abdominal adiposity and risk of death in Europe. *N Engl J Med* 359:2105–2120
- Randall VA (1998) Androgens and hair. In: Nieschlag E, Behre HM (eds) *Testosterone – action, deficiency, substitution*, 2nd edn. Springer, Heidelberg/New York, pp 169–186
- Randall VA (2004) Androgens and hair: a biological paradox. In: Nieschlag E, Behre HM (eds) *Testosterone action, deficiency, substitution*. 3rd ed. Cambridge University Press, Cambridge, pp 207–232
- Sakamoto H, Saito K, Ogawa Y, Yoshida H (2007) Testicular volume measurements using Prader orchidometer versus ultrasonography in patients with infertility. *Urology* 61: 158–162
- Santner SJ, Albertson B, Zhang GY, Zhang GH, Santulli M, Wang C, Demers LM, Shackleton C, Santen RJ (1998) Comparative rates of androgen production and metabolism in Caucasian and Chinese subjects. *J Clin Endocrinol Metab* 83:2104–2109
- Svartberg J, von Mühlen D, Sundsfjord J, Jorde R (2004) Waist circumference and testosterone levels in community dwelling men. The Tromsø study. *Eur J Epidemiol* 19: 657–663

Contents

6.1 Scrotal Ultrasonography	101
6.2 Doppler Sonography of the Plexus Pampiniformis	103
6.3 Transrectal Ultrasonography of the Prostate Gland and the Seminal Vesicles	105
6.4 Further Imaging Techniques.....	105
References.....	107

6.1 Scrotal Ultrasonography

Ultrasonography of the scrotal content has a firm place in present-day andrological diagnostics (Isidori and Lenzi 2008), allowing access to the scrotal organs without side-effects. Normal testis and epididymis display homogenous parenchymal echogenicity. **Determination of testicular volume** by palpation can be difficult in the case of hydroceles, thickened scrotal skin, epididymal fibrosis and particularly, in the case of cryptorchidism. Here, ultrasonography allows objective determination of testicular volume. Using a rotation ellipsoid formula, precise and reproducible determination of testicular volume is possible, which is of importance for longitudinal therapeutic studies (e.g., treatment with gonadotropins in hypogonadotropic hypogonadal patients) (Fig. 6.1a) (Behre et al. 1989; Büchter et al. 1998). A **hydrocele** appears as an echo-free area around the testis (Fig. 6.1b). It can occur following surgery or result from testicular tumors, or from chronic and recurrent inflammations of the testis or epididymis. In **varicocele**, enlargement of the venous diameter of the pampiniform plexus can be registered as well as the increase in the diameter of individual veins during the Valsalva maneuver (Cina et al. 2006) (Fig. 6.2a).

For the diagnosis of **testicular tumors**, today sonography is the method of choice since even unpalpable, intratesticular tumors can be recognized. These tumors appear as hyperechogenic or, mostly, as hypoechogenic or mixed areas (Fig. 6.3a–c). Hypoechogenic areas may be caused by abscesses, hematomas or intratesticular cysts (Fig. 6.3d). Men presenting with the adrenogenital syndrome (congenital adrenal hyperplasia) receiving sub-optimal hormonal substitution often show so-called adrenal rest tumors in the area of the

H. M. Behre (✉)
 Centre for Reproductive Medicine and Andrology of the
 University, Ernst-Grube-Str. 40, D-06120 Halle, Germany
 e-mail: hermann.behre@medizin.uni-halle.de

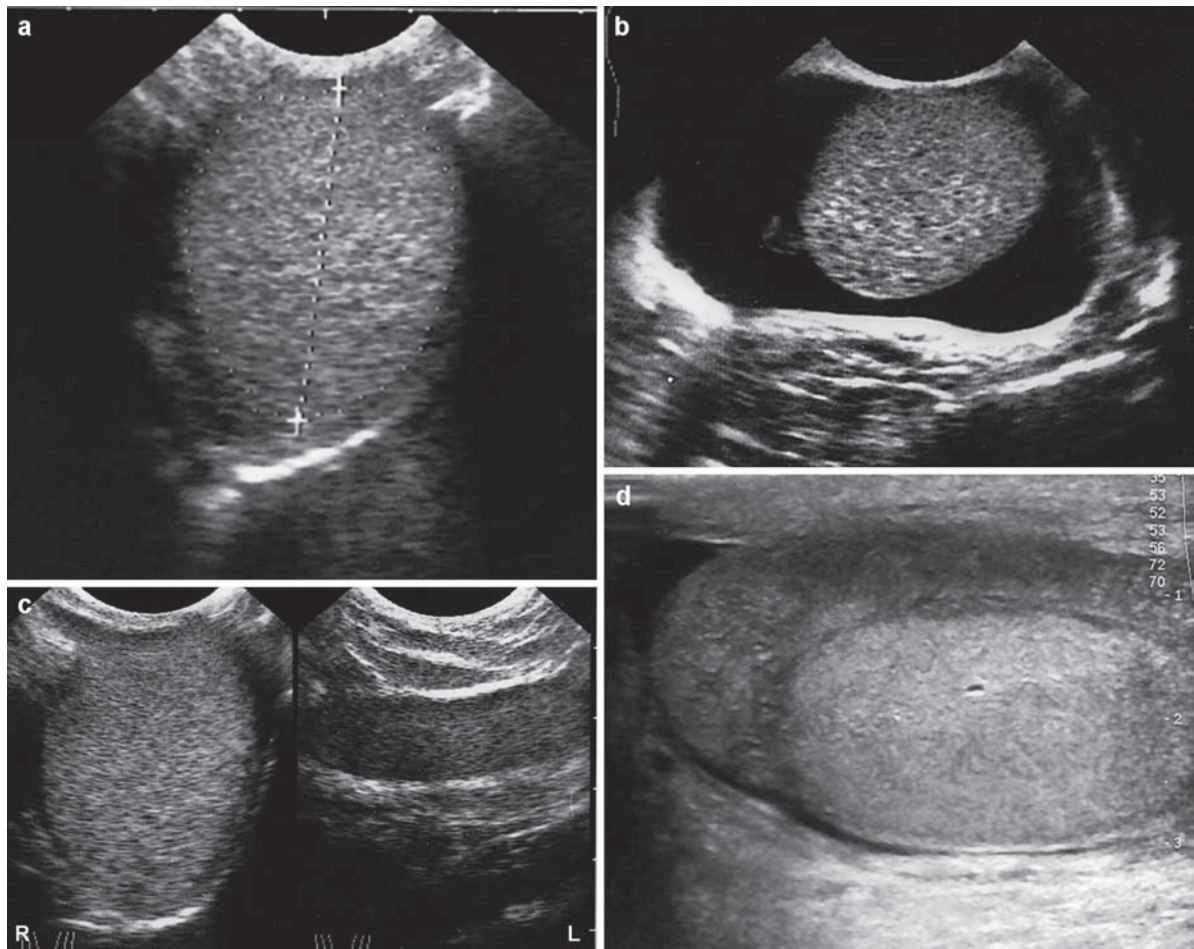

Fig. 6.1 Sonography of the scrotal content. (a) Determination of testicular volume applying the area-length-diameter-calculation: testicular volume 20 ml. Homogeneous testis with normal echogenicity. (b) Hydrocele. The echo-free edge surrounds the testis with homogeneous parenchyma. (c) The right testis shows

normal homogeneity and echogenicity. The left testis shows decreased echogenicity following maldescent and orchidopexy in childhood. (d) Enlarged and hypoechoic epididymis in acute epididymitis

rete testis which must be differentiated from testicular tumors (Fig. 6.3e). In the case of cryptorchidism, the testis frequently shows diminished echogenic appearance (Fig. 6.1c). Differential diagnosis of hyperechoic areas are fibrotic changes (e.g., after mumps orchitis or testicular biopsy) and microlithiasis testis (Fig. 6.3f, g). Because of the frequent association of microlithiasis and testicular tumors or testicular intra-epithelial neoplasia (TIN) meticulous sonographic diagnosis is especially important (von Eckardstein et al. 2001). Isolated focal hyperechoic or, more rarely, hypoechoic areas may occur after testicular sperm extraction (TESE) (Ramaswamy et al. 2005) (Fig. 6.3f).

Acute **epididymitis** results in a hypoechoic and enlarged sonographical picture of the epididymis (Fig. 6.1d). An accompanying hydrocele is frequently found. Chronic epididymitis causes hyperechogenicity because of fibrotic changes of the epididymis. A spermatocele appears as an echo-free, even, round area within the epididymis (Fig. 6.3h).

As men attending an infertility clinic show increased prevalence of testicular tumors, sonography of the scrotal content should be routinely performed (Behre et al. 1995). Using sonography we obtained pathological findings in 54% of 3,518 consecutively examined patients attending our clinic because of infertility (Table 6.1). 0.4% of these patients had

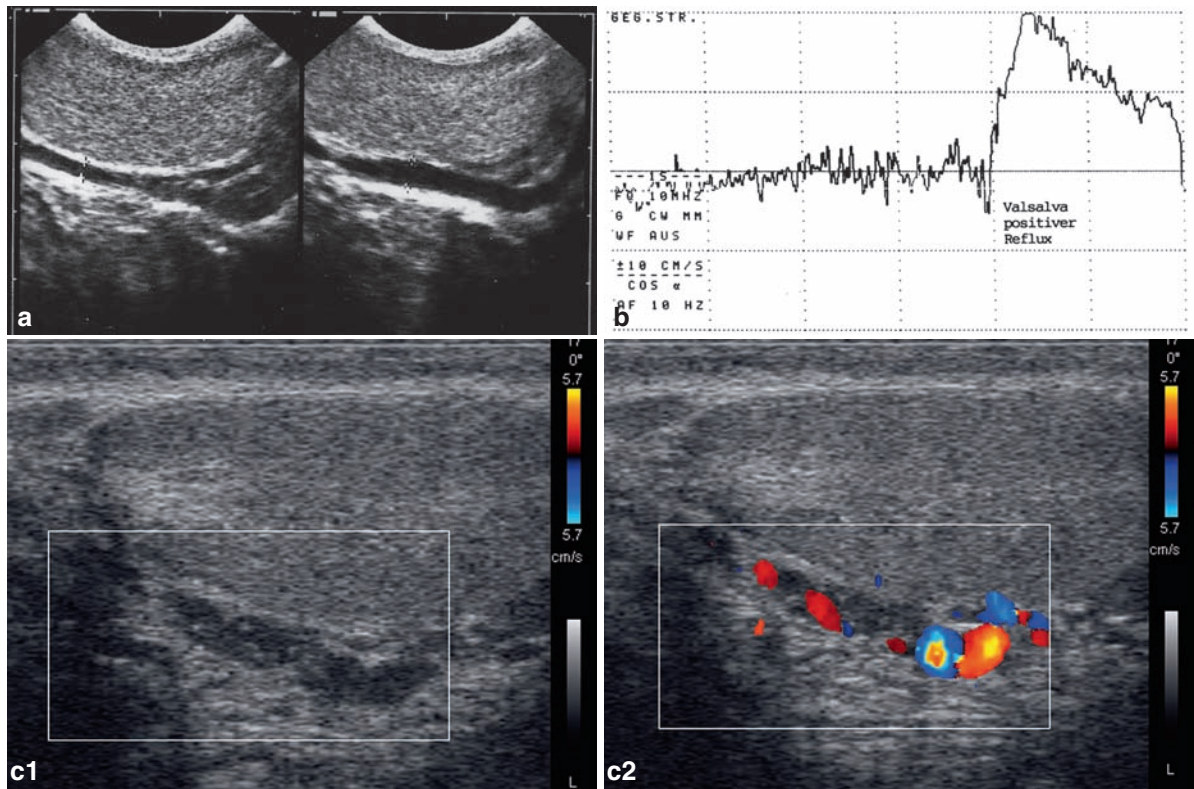

Fig. 6.2 Diagnosis of a varicocele. (a) Sonography shows an increase of the vein diameter of the pampiniform plexus in a patient with varicocele (VC) during the Valsalva maneuver. In this example of a I° VC the vein diameter dilates from 2.3 to 4.2 mm. In a III° VC, ultrasonography shows multiple, severely dilated scrotal veins of the pampiniform plexus even without the

Valsalva maneuver. (b) Venous backflow in the pampiniform plexus during Valsalva maneuver documented by Doppler sonography (10 MHz probe). (c) Even in the case of a small varicocele retrograde venous flux can be directly visualized by color-coded duplex sonography during Valsalva maneuver. Left: prior to, and right during Valsalva maneuver

testicular tumors. This high rate of testicular tumors among patients attending infertility clinics was recently confirmed in a large-scale study comprising 22,562 men (Walsh et al. 2009). Men with male factor infertility showed a 2.8-fold (95% confidence interval: 1.3–6.0) higher risk of subsequently developing testicular cancer according to a multivariate analysis controlling for age and duration of infertility treatment compared to men without male factor infertility. An earlier study with 3,847 patients with disturbed fertility and compromised semen parameters showed an even 22.9-fold higher risk than a comparable control group (95% confidence interval: 22.4–23.5). The standardized incidence of 18.3 (18.0–18.8) remained significantly increased when patients with testicular tumors were excluded who bore an additional risk

factor because of history of cryptorchidism (Raman et al. 2005).

Because of the high incidence of pathology detected by sonography and because of the high sensitivity and specificity of the method, today ultrasonography of the scrotal contents should be routinely performed in every patient with compromised fertility.

6.2 Doppler Sonography of the Plexus Pampiniformis

Doppler sonography enables blood flux through the pampiniform plexus to be measured exactly. By this method any reflux of blood can be detected

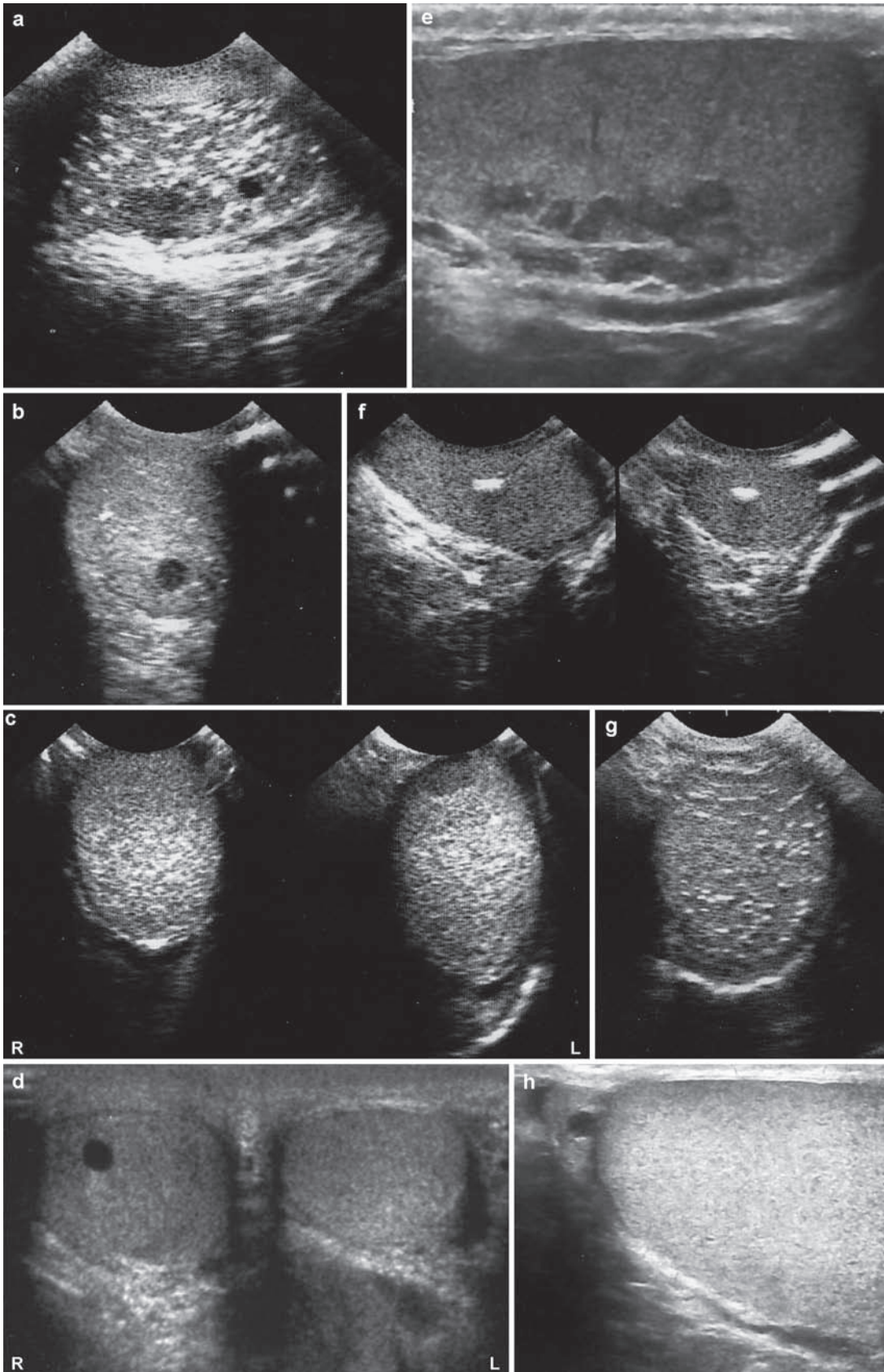

Table 6.1 Findings of scrotal sonography in 3518 consecutive male patients with infertility

Sonographic Findings	Cases (n)	Proportion (%)
Without pathological findings	1604	45.6
Inhomogeneities of testicular parenchyma	424	12.2
Testicular cysts	24	0.7
Testicular tumors	15	0.4
Hydroceles	268	7.6
Epididymal enlargements/ inhomogeneities	365	10.4
Spermatoceles	146	4.2
Varicoceles	672	19.1

acoustically during a Valsalva maneuver, and velocity and duration of the reflux can be quantified (Cina et al. 2006) (Fig. 6.2b). Color-coded duplex sonography can make venous reflux during the Valsalva maneuver additionally visible (Fig. 6.2c). Doppler or duplex sonography is well suited to determine the therapeutic results of surgical or radiological treatment of varicocele and can be used for objective evaluation of relapsing varicoceles.

6.3 Transrectal Ultrasonography of the Prostate Gland and the Seminal Vesicles

Transrectal sonography of the prostate (Fig. 6.4a, b) and the seminal vesicles (Fig. 6.4c, d) has a firm place in the diagnosis of hypogonadism and infertility (Behre et al. 1995). Transverse and longitudinal scans, planimetry or, even better, three-dimensional imaging enable total as well as the inner zone prostate volume in hypogonadal patients before and during testosterone therapy to be determined relatively exactly (Behre

et al. 1994; Tong et al. 1998). Reduced **prostate volume**, characteristic of hypogonadal patients, increases during a few months of testosterone therapy to the age-appropriate normal range without, however, exceeding it, as shown by transrectal volume measurements (Behre et al. 1994).

Intraprostatic cysts and dilatations of the ejaculatory ducts as a cause or result of obstructions can be recognized by prostate ultrasonography in patients with disturbed fertility (see Chap. 15, Fig. 15.1). **Transrectal ultrasonography of the seminal vesicles** can be performed before and after ejaculation and may thus reveal agenesis or aplasia, as well as dysfunction of the seminal vesicles. The extent of such conditions, often associated with infertility, is largely unknown (Meschede et al. 1997). Patients with congenital aplasia of the vas deferens (CBAVD) are characterized by low ejaculate volume, azoospermia and low fructose or α -glucosidase in serum, often associated with aplasia, hypoplasia or cystic dilatations of the seminal ducts (Fig. 6.4d) (von Eckardstein et al. 2000).

6.4 Further Imaging Techniques

Sonographic imaging of the penis for diagnosis of induratio penis plastica (IPP) as well as color-coded duplex sonography for diagnosis of erectile dysfunction is dealt with in detail in Chap. 16.

On suspicion of pathological processes in the pituitary or hypothalamus, **magnetic resonance imaging (MRI)** is the method of choice and is superior to conventional X ray of the sella region or computer tomography (see Chap. 12, Fig. 12.8). Along with laparoscopy routinely recommended, in special cases magnetic resonance imaging is applied when cryptorchidism or

Fig. 6.3 Sonography of the testis and epididymis showing hyperechoic and hypoechoic areas. (a) Inhomogeneous parenchyma with hyperechoic and hypoechoic areas. After surgical removal, histology showed a seminoma of the testis (pT1 N0 M0). (b) Hypoechoic area at the lower testicular pole; small hyperechoic areas and otherwise echonormal parenchyma of the testis. Histology revealed a seminoma (pT1 N0 M0). (c) Hypoechoic area at the upper pole of the left testis. Histology showed a Leydig cell tumor. The right testis (*left* figure) is unremarkable. (d) Intratesticular cyst: echo-free, smoothly limited

round area with dorsal echo enhancement in an otherwise homogenous right testis. The left testis (*right* figure) is unremarkable. (e) Multiple hypoechoic areas in the rete testis of a patient with congenital adrenal hyperplasia (so-called adrenal rest tumors). (f) Intratesticular calcification with dorsal echo extinction. (g) Microlithiasis testis with numerous small, hyperechoic areas and otherwise inconspicuous echogenicity of the testis (“snow-squall”). Histology revealed a Sertoli-cell-only syndrome. (h) Small spermatocele of the epididymis (2 mm in diameter)

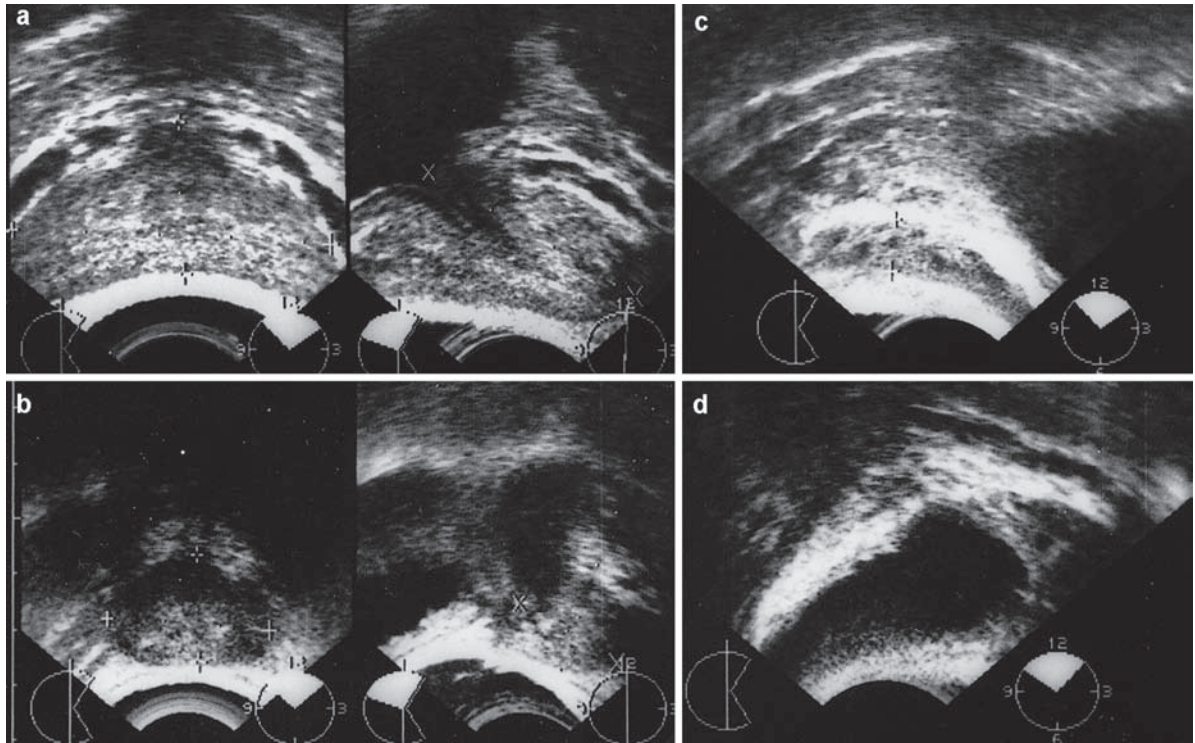

Fig. 6.4 Transrectal sonography of the prostate and seminal vesicles. (a) Normal prostate in transverse (*left* figure) and longitudinal scans (*right* figure). Exact determination of prostate volume by the planimetric method or – as shown here – by the formula for an ellipsoid. Prostate volume: 21 ml. Normal, healthy

man. (b) Hypoechoic and small prostate gland (volume 6 ml) in a hypogonadal patient without substitution therapy. (c) Display of a normal seminal vesicle. (d) Dysfunction of the seminal vesicle. No depletion of an enlarged seminal vesicle is seen after ejaculation (as shown here). Diameter of the seminal vesicle: 22 mm

anorchia (unilateral or bilateral) is suspected and when testicular tissue cannot be visualized by sonography of the scrotum or the inguinal canal (Fig. 6.5).

In younger hypogonadal patients and in boys with delayed puberty, **bone age** is determined by X ray of the left hand according to the appearance of the bones and extent of epiphyseal maturation (e.g., by comparison to the anatomical atlas by Greulich and Pyle 1959). Spinal alterations caused by osteoporosis due to androgen deficiency can be diagnosed by traditional X rays only in advanced stages. **DXA (dual energy X ray absorptiometry)** applied to the lumbar spine and proximal femur has become the method of choice for determining bone density. Volumetric methods such as **quantitative ultrasound** of the peripheral spongiosa-rich bones such as the calcaneus or finger phalanges, free of radioactivity, have also been used to monitor therapy (Zitzmann et al. 2002). These methods can be applied for long-term objective monitoring of bone density of patients under androgen substitution therapy as an adjunct to hormone measurement (Behre et al. 1997; Zitzmann et al. 2002).



Fig. 6.5 Detection of a right ectopic testis in front of the iliac muscle by magnetic resonance imaging in a 35-year-old man. Sonography of the scrotal content and the inguinal region failed to detect testicular tissue on either side. A normal increase of testosterone had been shown by hCG test. After surgical removal, histology revealed a seminoma (pT1N0M0). The patient was asymptomatic and remained free of metastases. No testicular tissue is detectable on the left side

References

- Behre HM, Nashan D, Nieschlag E (1989) Objective measurement of testicular volume by ultrasonography: evaluation of the technique and comparison with orchidometer estimates. *Int J Androl* 12:395–403
- Behre HM, Bohmeyer J, Nieschlag E (1994) Prostate volume in testosterone-treated and untreated hypogonadal men in comparison to age-matched controls. *Clin Endocrinol* 40:341–349
- Behre HM, Kliesch S, Schädel F, Nieschlag E (1995) Clinical relevance of scrotal and transrectal ultrasonography in andrological patients. *Int J Androl* 18(Suppl 2):27–31
- Behre HM, Kliesch S, Leifke E, Link TM, Nieschlag E (1997) Long-term effect of testosterone therapy on bone mineral density in hypogonadal men. *J Clin Endocrinol Metab* 82:2386–2390
- Büchter D, Behre HM, Kliesch S, Nieschlag E (1998) Pulsatile GnRH or human chorionic gonadotropin/human menopausal gonadotropin as effective treatment for men with hypogonadotropic hypogonadism: a review of 42 cases. *Eur J Endocrinol* 139:298–303
- Cina A, Minnetti M, Pirroni T, Vittoria Spampinato M, Canadè A, Oliva G, Ribatti D, Bonomo L (2006) Sonographic quantitative evaluation of scrotal veins in healthy subjects: normative values and implications for the diagnosis of varicocele. *Eur Urol* 50:345–350
- Greulich WW, Pyle SI (1959) Radiographic atlas of skeletal development of the hand and wrist, 2nd edn. Stanford University Press, Stanford, CA
- Isidori AM, Lenzi A (2008) Scrotal ultrasound: morphological and functional atlas. Forum Service Editore s.r.l., Genua.
- Meschede D, Dworniczak B, Behre HM, Kliesch S, Claustres M, Nieschlag E, Horst J (1997) CFTR gene mutations in men with bilateral ejaculatory-duct obstruction and anomalies of the seminal vesicles. *Am J Hum Genet* 61:1200–1202
- Raman JD, Nobert CF, Goldstein M (2005) Increased incidence of testicular cancer in men presenting with infertility and abnormal semen analysis. *J Urol* 174:1819–1822
- Ramasamy R, Yagan N, Schlegel PN (2005) Structural and functional changes to the testis after conventional versus microdissection testicular sperm extraction. *Urology* 65:1190–1194
- Tong S, Cardinal HN, McLoughlin RF, Downey DB, Fenster A (1998) Intra- and inter-observer variability and reliability of prostate volume measurement via two-dimensional and three-dimensional ultrasound imaging. *Ultrasound Med Biol* 24:673–681
- von Eckardstein S, Cooper TG, Rutsch K, Meschede D, Horst J, Nieschlag E (2000) Seminal plasma characteristics as indicators of cystic fibrosis transmembrane conductance regulator (CFTR) gene mutations in men with obstructive azoospermia. *Fertil Steril* 73:1226–1231
- von Eckardstein S, Tsakmakidis G, Kamischke A, Rolf C, Nieschlag E (2001) Sonographic testicular microlithiasis as an indicator of premalignant conditions in normal and infertile men. *J Androl* 22:818–824
- Walsh TJ, Croughan MS, Schembri M, Chan JM, Turek PJ (2009) Increased risk of testicular germ cell cancer among infertile men. *Arch Intern Med* 169:351–356
- Zitzmann M, Brune M, Vieth V, Nieschlag E (2002) Monitoring bone density in hypogonadal men by quantitative phalangeal ultrasound. *Bone* 31:422–429

Contents

7.1 Gonadotropins	109
7.2 GnRH, GnRH Test, GnRH Receptor	111
7.3 Prolactin, TRH Stimulation Test	111
7.4 Testosterone, Free Testosterone, Salivary Testosterone, SHBG	112
7.5 hCG Test	115
7.6 Anti-Mullerian Hormone, Insulin-Like Factor 3 ...	115
7.7 Inhibin B	116
7.8 Further Diagnosis	116
References	116

7.1 Gonadotropins

The evaluation of serum levels of LH and FSH in combination with testosterone provides important information to pinpoint the localization of hypogonadism, which is then decisive for adequate therapy.

High gonadotropin levels in serum in combination with low testosterone levels indicate testicular origin of hypogonadism (**primary hypogonadism**); low gonadotropin levels point to a central cause (**secondary hypogonadism**).

For differentiation between low normal and pathologically low LH and FSH levels, highly sensitive third generation immunometric assays are recommended.

When interpreting basal **LH** values, the physiological **pulsatility of pituitary secretion** with ensuing oscillations of serum levels has to be considered. The combination of pulsatile release and short circulatory half-life (60 min) is the basis for **LH pulsatility**. A normal man shows approximately 8–20 LH pulses per day with measured LH variations of 100% and more between peak and trough levels. For this reason repeated sampling may be necessary. Patients with primary hypogonadism have increased average serum concentrations, as well as elevated LH pulse frequency. When hypothalamic GnRH fails to be secreted, only sporadic LH pulses or none at all can be measured. High LH levels occurring in combination with high testosterone serum concentrations indicate an androgen receptor defect (**androgen resistance**) (see Chap. 17).

Due to its longer half-life of 4–6 h **FSH** displays only minor serum level oscillations, and therefore a single-point measurement is representative. **To a certain extent, FSH serum concentrations mirror**

M. Simoni (✉)
 Department of Medicine, Endocrinology and Metabolism,
 University of Modena and Reggio Emilia, Nuovo Ospedale
 Civile S. Agostino-Estense, Via Giardini, 1355,
 I-41126 Modena, Italy
 e-mail: Manuela.Simoni@unimore.it

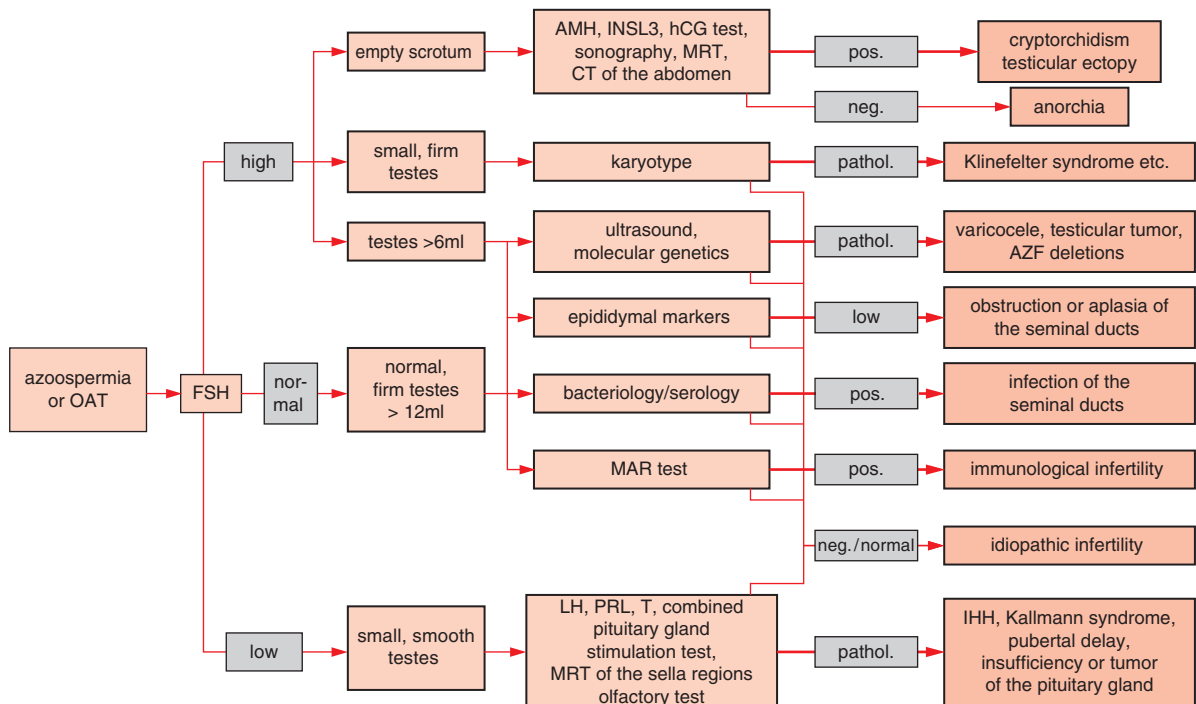

Fig. 7.1 Algorithm for differential diagnosis of male fertility disorders indicating the importance of FSH, along with semen analysis

spermatogenesis. High FSH levels in the presence of small, firm testes (<6 ml) and azoospermia are diagnostic indicators for Klinefelter syndrome; low FSH levels indicate a hypothalamic or pituitary deficiency (Fig. 7.1). If testicular volume exceeds 6 ml and azoospermia or severe oligozoospermia is simultaneously present, then elevated FSH indicates primary impairment of spermatogenesis. Within wide margins, the extent of FSH elevation is correlated with the number of seminiferous tubules lacking germ cells (Sertoli cell-only tubules) (Fig. 7.2) (von Eckardstein et al. 1999). Normal FSH levels, however, may be found in patients with azoospermia or severe oligozoospermia due to defects at late, postmeiotic spermatogenetic stages, which are FSH-independent (Bergmann et al. 1994).

Normal FSH values in combination with azoospermia, normal testicular volume and low levels of glucosidase in the ejaculate, raise suspicion of an obstruction or aplasia of the deferent duct (Fig. 7.1). This constellation, possibly accompanied by ambiguous findings, justifies bilateral testicular biopsy; in case of normal testicular histology, reconstructive surgery of the epididymis or deferent duct or techniques of assisted reproduction are indicated (Goldstein and Tanrikut 2006; see Chap. 15).

For the determination of gonadotropin levels in serum, sensitive non-competitive **immunoassays** such as immunoradiometric assays (IRMA), immunofluorometric assays (IFMA) or enzyme-linked immunosorbent assays (ELISA), are available (Sussman et al. 2008). The **ultrasensitive, third generation LH assays** are useful in cases of low LH levels such as prepubertal state or hypogonadotropic hypogonadism (Sequera et al. 2002). Although **in vitro bioassays** for LH and FSH have been developed in the past, they were not particularly sensitive. Since bioactivity and immunoactivity of gonadotropins are well correlated in most cases, in vitro bioassays are unnecessary for routine clinical diagnosis (Simoni and Nieschlag 1991).

Mutations of gonadotropin genes are rare. Inactivating mutations of the LH- β subunit lead to infertility and failure of spontaneous puberty to occur. Inactivating mutations of the FSH- β subunit cause azoospermia and, hence, infertility (Huhtaniemi and Themmen 2005). Similarly, rare mutations of the **gonadotropin receptor genes** are divided into activating and inactivating mutations. Activating LH receptor mutations cause precocious puberty, whereas inactivating mutations cause Leydig cell hypoplasia and hypogonadism. Inactivating FSH receptor mutations lead to variable disturbances of

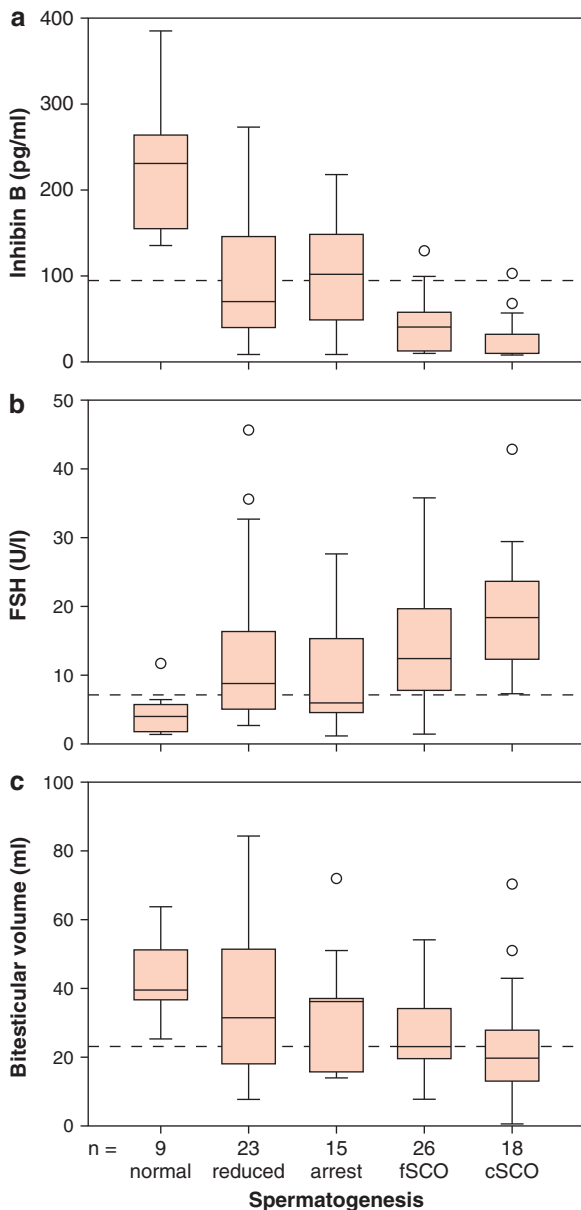

Fig. 7.2 Box plot showing serum concentrations of inhibin B (a) and FSH (b) as well as total testicular volume (c) in 91 infertile men divided into five groups according to testicular histology (*normal*: normal spermatogenesis; *reduced*: qualitatively reduced spermatogenesis; *arrest*: spermatogenic arrest; *fSCO*: focal Sertoli-cell-only syndrome; *cSCO*: complete Sertoli-cell-only syndrome). Broken line shows lower normal levels for inhibin B and total testicular volume as well as upper normal levels of FSH (von Eckardstein et al. 1999)

spermatogenesis (Huhtaniemi and Alevizaki 2006). The only activating FSH receptor mutation described so far maintained spermatogenesis in a hypophysectomized male (overview in Simoni et al. 1997).

7.2 GnRH, GnRH Test, GnRH Receptor

Because of extremely low serum concentrations and short half-life, GnRH cannot be measured in peripheral blood by immunoassay.

The **GnRH test** is performed to determine the gonadotropin reserve capacity of the pituitary and is particularly indicated for low-normal LH and FSH values, which cannot always be differentiated from pathologically low basal values.

The rise of LH should be at least threefold 30–45 min after injection of 100 µg GnRH; the increase in FSH should be 1.5 times over basal. However, the results should be judged by an experienced clinician.

If a hypothalamic disorder is suspected during the first GnRH test and no rise of gonadotropins is observed, a **GnRH pump test** should be performed. After pulsatile GnRH treatment (5 µg GnRH every 120 min) for 36 h to 7 days, the GnRH test is repeated. A significant rise in gonadotropin levels after 7 days points to hypothalamic disease; no rise is typical for pituitary insufficiency (see 7.1). An additional GnRH test after 36 h serves to differentiate constitutionally delayed puberty from idiopathic hypogonadotropic hypogonadism (see 7.5). For further differentiation, medical imaging procedures (e.g., MRT) are necessary. When basal gonadotropin levels are high, which points to a primary testicular disorder, no additional information can be gained from a GnRH test.

Recently **mutations** in the **GnRH receptor** gene and in the GnRH gene as well as in other genes involved in the control of GnRH secretion (*GPR54*, *FGFR1*, etc.; see Chap. 2) were also identified as the cause of hypogonadotropic hypogonadism (Bhagavath and Layman 2007; Bouligand et al. 2009). The molecular genetic diagnostic procedures of these mutations are reported in Chap. 8.

7.3 Prolactin, TRH Stimulation Test

The determination of **prolactin** in male patients of an infertility clinic does not play such a pivotal role as it does in the female. Unclear fertility disorders, erectile dysfunction and loss of libido, gynecomastia, galactorrhea or other symptoms that indicate a pituitary disorder and suspicion of pituitary tumor

should prompt prolactin serum measurements, which are performed by competitive or non-competitive immunoassay. When interpreting results, it should be remembered that numerous drugs, particularly psychiatric medication (dopamin antagonists and catecholamine depletors), and stress increase prolactin secretion.

In most cases pituitary adenomas with endocrine activity produce prolactin (see Chap. 12). Endocrine stimulation tests can be applied to differentiate a prolactinoma from hyperprolactinemia with other causes. For the male the thyrotropin releasing hormone (TRH) stimulation test is best suited. Typically patients with a prolactinoma show a diminished increase of prolactin after TRH administration because of autonomous prolactin production by the tumor, whereas patients with hyperprolactinemia of non-tumor origin respond normally. A prolactin rise of less than 30% over basal after 200 µg TRH i.v. provides a diagnostic hint for a macroprolactinoma (Gspaner et al. 1999). Because of the wide scatter of test results from normal men, no borderline values for microprolactinomas can be given (Le Moli et al. 2003).

It should be known that the current prolactin assays, although generally robust and reliable, are susceptible to interference, especially due to the presence in the serum of some individuals of a high molecular weight form of prolactin bound to IgG and biologically inactive (macroprolactin). Some assays do not allow correct differentiation of patients with true hyperprolactinemia from those with macroprolactinemia, estimated to represent about 10% of all cases of biochemical hyperprolactinemia (Smith et al. 2007).

7.4 Testosterone, Free Testosterone, Salivary Testosterone, SHBG

Testosterone in serum is the laboratory value most important for confirming a clinical suspicion of hypogonadism and for monitoring testosterone substitution therapy. When interpreting testosterone values, **diurnal variations** should be considered as they cause morning serum concentrations to be approximately 20–40% higher than evening values (Fig. 7.3).

Fig. 7.3 Circadian rhythm of serum total testosterone in ten young (23–33 years) and eight elderly men (55–64 years). Highest values are seen between 6.00 and 10.00 in the morning and lowest levels between 17.00 and 21.00 hours in the evening. Elderly men maintain the diurnal rhythm seen in the younger men, although on a lower level and with a lower amplitude (Diver et al. 2003)

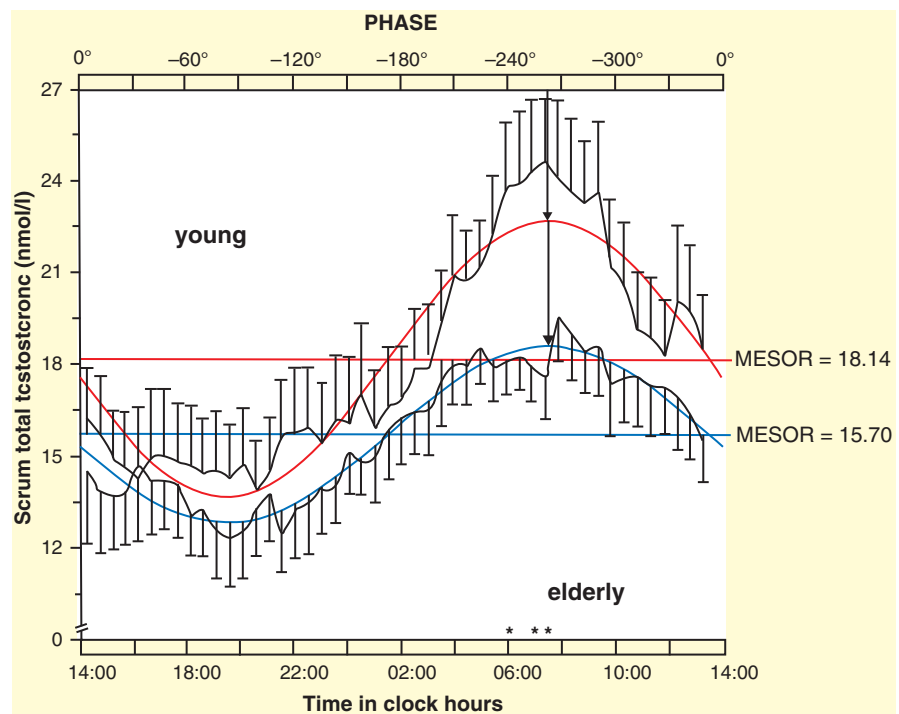

Serum testosterone levels are influenced by many factors under physiological and pathological conditions (Zitzmann and Nieschlag 2001). Short, intensive **physical exercise** can increase serum testosterone concentrations, whereas extended exhausting physical exercise and high-performance sports can bring about a decrease (Schürmeyer et al. 1984; Stroud et al. 1997). Nearly all **chronic diseases**, particularly those of the liver, kidneys and the cardiovascular system, as well as **stress, anesthesia, drugs** and certain **medications** (e.g., ketoconazole) can prompt a decrease in testosterone levels (see Chap. 18).

Serum testosterone levels, especially free testosterone, decrease with age (Zitzmann and Nieschlag 2003; Araujo et al. 2007) (Fig. 7.4). Although it is not clear whether such age-related decrease is physiological or caused by multimorbidity, when serum testosterone levels are below the lower cutoff of the young adult range they may be associated with increased frailty and symptoms of hypogonadism requiring clinical attention. For the time being no separate reference range for the aging

men exists. However, evidence is accumulating that there may not be one threshold between normal and pathological, but that there are symptom-specific thresholds for the various signs of hypogonadism in aging (Zitzmann et al. 2006a) as well as in younger men (Kelleher et al. 2004) (see Chaps. 14 and 21).

Considering these factors, normal serum testosterone concentration in the adult male of all ages lies between 12 and 40 nmol/L during the first half of the day; concentrations below 8 nmol/L are certainly pathological; values between 8 and 12 require additional testing. Prepubertal boys and castrates have serum levels below 4 nmol/L. An algorithm for the diagnoses of hypogonadism, emphasizing the central role of testosterone and SHBG, is shown in Fig. 7.5.

The threshold levels for the diagnosis of hypogonadism vary between countries (Nieschlag et al. 2004). In the light of symptom-specific threshold levels the differences in the diagnosis of hypogonadism and the indication for testosterone therapy must be interpreted as reflections of the physicians' perception of hypogonadism rather than as patient needs. Moreover, an international expert panel on diagnosis and treatment of late-onset hypogonadism (LOH) could only agree upon 8 nmol/L as the unequivocal lower limit of testosterone as indicator for substitution therapy, while the range between 8 and 12 nmol/L is considered a grey area (Nieschlag et al. 2005; Wang et al. 2009). This implies that testosterone therapy has to be tailored individually for each patient. When the modulating effects of the androgen receptor polymorphism are also taken into consideration (see Chaps. 2 and 21), individualized diagnosis and therapy becomes even more compelling. Failure of the serum testosterone levels of a patient to match the clinical picture suggests determination of the **androgen receptor CAG repeats**. For example, symptoms of hypogonadism in the presence of normal serum testosterone levels may be caused by long CAG repeats.

In most laboratories serum total testosterone concentrations are determined by radioimmunoassay, enzyme immunoassay, fluoroimmunoassay or chemiluminescence assay by direct methods without extraction (Simoni 2004). However, the current direct immunoassays for testosterone are inaccurate at low testosterone concentrations (prepubertal boys, women) and measurement after extraction and chromatography followed by either mass spectrometry or immunoassay

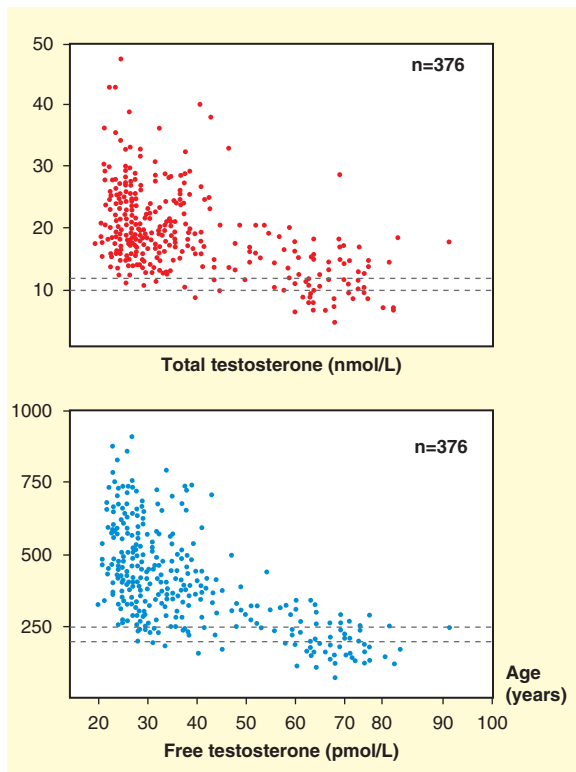

Fig. 7.4 Total and free calculated serum testosterone in 376 healthy men in relation to age in years. The dotted lines indicate the lower limits of normal (Zitzmann and Nieschlag 2003)

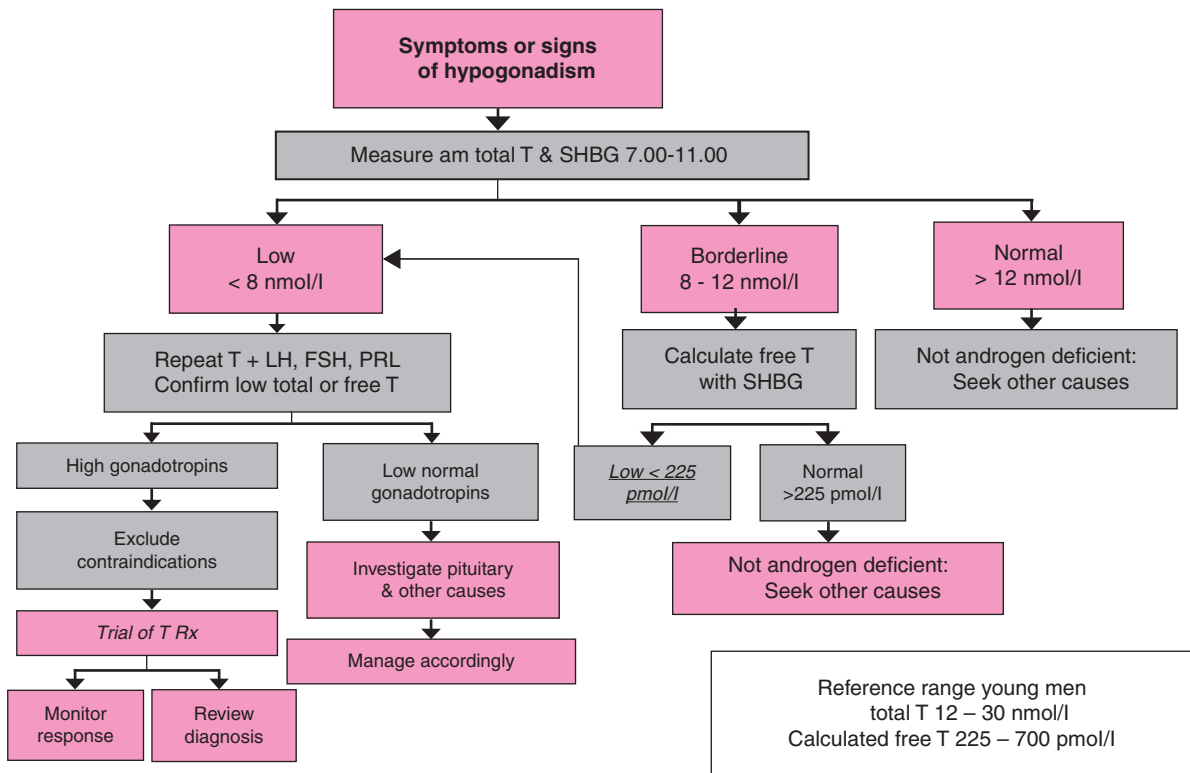

Fig. 7.5 Algorithm for diagnosis in treatment of hypogonadism emphasizing the importance of total testosterone and SHBG measurements

has been recommended by the Endocrine Society (Rosner et al. 2007). High throughput liquid chromatography followed by tandem mass spectrometry (LC-MS/MS) is becoming increasingly popular and allows the simultaneous accurate identification and quantification of several steroids in the same sample (Licea-Perez et al. 2008). Nevertheless, for practical reasons the established immunoassays are sufficient for routine diagnosis, provided the laboratory follows strict quality control criteria and has established its own reference range for healthy men.

Testosterone in serum remains stable even after repeated freezing and thawing. Normally, a single morning blood sample is sufficient for the assessment of testosterone serum levels.

In blood, testosterone is bound to protein, specifically to **sex hormone binding globulin (SHBG)**. Only approximately 2% of testosterone is unbound and available as free testosterone for biological activity. The concentration of **free testosterone**, as a measure of biologically available testosterone, is determined by equilibrium dialysis or as the serum fraction of total

testosterone which is not precipitated by ammonium sulfate. These methods, however, are too complicated for clinical routine. Calculating free testosterone from the serum concentration of total testosterone and SHBG using a standardized formula has proved to be a simple and reliable method for estimating testosterone bioactivity (Vermeulen et al. 1999). Direct free testosterone measurement by the “analog” method is usually inaccurate and not recommended.

Since generally total testosterone is well correlated with free testosterone, separate determination of free testosterone is only necessary in certain cases. As an example, hyperthyroidism and antiepileptic and other drugs and conditions cause an increase in SHBG levels and thereby increased testosterone concentration in serum (Table 7.1), without a parallel increase of the biologically active free testosterone fraction. In extreme obesity low testosterone levels are measured; however, in combination with low SHBG values; accordingly, the free testosterone fraction remains normal, although in the low-normal range (Wu et al. 2008).

Table 7.1 Influences on SHBG concentrations

Simulation of SHBG production	Inhibition of SHBG production
Estrogen application	Androgen therapy
Lack of androgens	Obesity
Growth hormone deficiency	Acromegaly
Hepatitis	Nephrotic syndrome
Liver cirrhosis	Glucocorticoids
Phenytoin application	Hyperinsulinemia
Hyperthyroidism	Gestagens
	Hypothyroidism

Testosterone can also be measured in **saliva** by direct immunoassays (normal range 200–500 pmol/L). Salivary concentrations are correlated with free testosterone in serum. This determination would be especially suited for monitoring testosterone substitution therapy since the patient can produce samples without the help of medical personnel but has many drawbacks which limits its application to clinical routine (Granger et al. 2004).

Beside testosterone, other testicular and adrenal androgens such as 5 α -dihydrotestosterone, androstenedione, dehydroepiandrosterone and its sulphate contribute to overall androgenization. Recently **in vitro bioassays of total androgen bioactivity** in serum were developed. These assays are not for routine laboratory diagnostics, but they provide a useful tool for clinical research in disturbances of androgen production. Other possible applications of these assays are the screening for androgenic and antiandrogenic activity in chemical compounds and environmental samples and when suspecting androgen abuse (Roy et al. 2008).

7.5 hCG Test

The **endocrine reserve capacity of the testis** can be tested by stimulation with human chorionic gonadotropin (hCG). hCG has predominantly LH activity and stimulates testosterone production of the Leydig cells. Today, the test is predominantly used for differentiation between cryptorchidism or ectopy of the testis (rise in testosterone levels present, but diminished) and anorchia (absent testosterone rise) (Fig. 7.1). On the first day of the examination, basal blood samples are obtained between 8.00 and 10.00 hours; immediately thereafter a single injection of 5,000 I.U. hCG is given i.m. Further blood samples are obtained after 48 and/or 72 h. The

rise of testosterone should be 1.5–2.5-fold. Lesser values indicate primary hypogonadism; higher values signal secondary hypogonadism. Failure of values in the castrate range to increase indicates anorchia or complete testicular atrophy. Decreasing reserve capacity of the Leydig cells is a characteristic of the elderly man (see Chap. 14).

7.6 Anti-Mullerian Hormone, Insulin-Like Factor 3

After testis formation, further development of a male phenotype (masculinization) is driven by three hormones from the fetal testis: **anti-mullerian hormone (AMH)**, **insulin-like factor 3 (INSL3)**, and testosterone. AMH, also known as **mullerian inhibiting substance (MIS)**, is secreted by the immature Sertoli cell and is responsible for the regression of the mullerian ducts in the male fetus.

Determining serum levels of AMH is a sensitive and specific test providing evidence for the existence of a testis in the prepubertal male (Josso et al. 2006). Normal values for boys show the presence of testicular tissue; undetectable serum concentrations indicate **anorchia**. Compared to the hCG test, the AMH test is equally specific, but more sensitive and hence its predictive value is higher in prepubertal boys (Lee et al. 1997).

AMH serum concentrations are significantly higher in prepubertal boys with normal testicular function than in boys with disturbed testicular function (Lee et al. 1997). Extremely high values are seen in men with idiopathic hypogonadotropic hypogonadism, where they are caused by deficient pubertal maturation of the Sertoli cell and where they are comparable to values seen in prepubertal boys. hCG or testosterone therapy reduces these levels significantly while FSH treatment increases AMH levels in seminal plasma (Sinisi et al. 2008). AMH serum levels are not significantly altered in men with impaired spermatogenesis but appear to be correlated with spermatogenic parameters in men with maldescended testes, in whom AMH could serve as a Sertoli cell marker (Tüttelmann et al. 2009). Unfortunately, in men undergoing testicular sperm extraction (TESE) AMH measurement does not improve the predictive value of serum FSH and inhibin B values (Goulis et al. 2009).

Insulin-like factor 3 (INSL3) is a peptide of the relaxin-like hormone family. In the male it is expressed

in testicular fetal and adult Leydig cells and is directly responsible for the process of abdominal descent of the testes towards the scrotum during male development. Mutations of the *INSL3* gene or its receptor *RXFP2* cause high intra-abdominal cryptorchidism due to a differentiation failure of testicular ligaments, the gubernacula. Several mutations of these two genes resulting in nonfunctional proteins have been described in patients with testicular maldescent (Foresta et al. 2008). Serum INSL3 levels are currently regarded as a marker of Leydig cell function independent of testosterone. In boys, early postnatal INSL3 is high, decreases later in childhood and increases again at puberty under the differentiating action of LH on Leydig cells. Cord blood and serum INSL3 are reduced in cryptorchid boys (Bay et al. 2007).

Since INSL3 is a specific marker of Leydig cells (it is not measurable in the woman), it can be used to demonstrate the presence of testicular tissue in boys with bilateral cryptorchidism and its absence in serum suggests anorchidism. Serum INSL3 declines significantly with age, independently of testosterone (Anand-Ivell et al. 2006). At present, determination of INSL3 levels is of no use in male infertility.

7.7 Inhibin B

Inhibin B is produced by the Sertoli cells in the testes and plays a role in the regulation of FSH secretion in the pituitary (see Chap. 2). Inhibin A is not produced in the male. Inhibin B is a marker of spermatogonial proliferation and interaction with Sertoli cells and its concentration in serum drops quickly when spermatogonial proliferation stops (Meachem et al. 2001). Overall, inhibin B levels decrease and, consequently FSH concentrations increase in the presence of germ cell depletion (O'Connor and De Kretser 2004).

Inhibin B shows a marked **circadian rhythm**, with high values in the morning, descending to lowest levels in the late afternoon. In healthy and infertile men morning serum concentrations of inhibin B are correlated with FSH serum levels, sperm concentration and testicular volume (Fig. 7.2) (von Eckardstein et al. 1999). As a direct secretory product of the Sertoli cell, inhibin B is slightly more sensitive than FSH as a parameter for evaluating spermatogenesis (von

Eckardstein et al. 1999; Ballescà et al. 2000). However, neither inhibin B nor FSH nor a combination of the two can accurately predict the presence of sperm in testicular biopsies, information which is of great relevance for azoospermic patients who are to undergo testicular sperm extraction (TESE) prior to ICSI therapy. Rather, FSH levels alone seem to be a better predictor of ICSI success (von Eckardstein et al. 1999; Zitzmann et al. 2006b).

7.8 Further Diagnosis

Determining serum concentrations of **17 β estradiol, hCG, androstenedione or 5 α -dihydrotestosterone (DHT) and 5 α -reductase activity** in skin fibroblasts may be necessitated by particular findings, e.g., gynecomastia, suspected testicular tumor, enzyme defects in testosterone biosynthesis or resistance of androgen target organs (see detailed descriptions in Chaps. 8 and 17).

References

- Anand-Ivell R, Wohlgemuth J, Haren MT, Hope PJ, Hatzinikolas G, Wittert G, Ivell R (2006) Peripheral INSL3 concentrations decline with age in a large population of Australian men. *Int J Androl* 29:618–626
- Araujo AB, Esche GR, Kupelian V, O'Donnell AB, Travison TG, Williams RE, Clark RV, McKinlay JB (2007) Prevalence of symptomatic androgen deficiency in men. *J Clin Endocrinol Metab* 92:4241–4247
- Ballescà JL, Balasch J, Calafell JM, Alvarez R, Fábregues F, de Osaba MJ, Ascaso C, Vanrell JA (2000) Serum inhibin B determination is predictive of successful testicular sperm extraction in men with non-obstructive azoospermia. *Hum Reprod* 15:1734–1738
- Bay K, Virtanen HE, Hartung S, Ivell R, Main KM, Skakkebaek NE, Andersson AM, Nordic Cryptorchidism Study Group, Toppari J (2007) Insulin-like factor 3 levels in cord blood and serum from children: effects of age, postnatal hypothalamic-pituitary-gonadal axis activation, and cryptorchidism. *J Clin Endocrinol Metab* 92:4020–4027
- Bergmann M, Behre HM, Nieschlag E (1994) Serum FSH and testicular morphology in male infertility. *Clin Endocrinol* 40:133–136
- Bhagavath B, Layman LC (2007) The genetics of hypogonadotropic hypogonadism. *Semin Reprod Med* 25:272–286
- Bouligand J, Ghervan C, Tello JA, Brailly-Tabard S, Salenave S, Chanson P, Lombès M, Millar RP, Guiochon-Mantel A, Young J (2009) Isolated familial hypogonadotropic hypogonadism and a GnRH1 mutation. *N Engl J Med* 360:2742–2748

- Diver MJ, Imtiaz KE, Ahmad AM, Vora JP, Fraser WD (2003) Diurnal rhythms of serum total, free and bioavailable testosterone and of SHBG in middle-aged men compared with those in young men. *Clin Endocrinol* 58:710–717
- Foresta C, Zuccarello D, Garolla A, Ferlin A (2008) Role of hormones, genes and environment in human cryptorchidism. *Endocr Rev* 29:560–580
- Goldstein M, Tanrikut C (2006) Microsurgical management of male infertility. *Nat Clin Pract Urol* 3:381–391
- Goulis DG, Tsamets C, Iliadou PK, Polychronou P, Kantartzis PD, Tarlatzis BC, Bontis IN, Papadimas I (2009) Serum inhibin B and anti-Müllerian hormone are not superior to follicle-stimulating hormone as predictors of the presence of sperm in testicular fine-needle aspiration in men with azoospermia. *Fertil Steril* 91:1279–1284
- Granger DA, Shirtcliff EA, Booth A, Kivlighan KT, Schwartz EB (2004) The “trouble” with salivary testosterone. *Psychoneuroendocrinology* 29:1229–1240
- Gsponer J, De Tribolet N, Déruaz JP, Janzer R, Uské A, Mirimanoff RO, Reymond MJ, Rey F, Temler E, Gaillard RC, Gomez F (1999) Diagnosis, treatment, and outcome of pituitary tumors and other abnormal intrasellar masses. Retrospective analysis of 353 patients. *Medicine* 78:236–269
- Huhtaniemi I, Alevizaki M (2006) Gonadotrophin resistance. *Best Pract Res Clin Endocrinol Metab* 20:561–576
- Huhtaniemi I, Themmen AP (2005) Mutations in human gonadotropin and gonadotropin-receptor genes. *Endocrine* 26:207–217
- Josso N, Picard JY, Rey R, di Clemente N (2006) Testicular anti-Müllerian hormone: history, genetics, regulation and clinical applications. *Pediatr Endocrinol Rev* 3:347–358
- Kelleher S, Conway AJ, Handelsman DJ (2004) Blood testosterone threshold for androgen deficiency symptoms. *J Clin Endocrinol Metab* 89:3813–3817
- Le Moli R, Enderl E, Fliers E, Prummel MF, Wiersinga WM (2003) Evaluation of endocrine tests. A: the TRH test in patients with hyperprolactinaemia. *Neth J Med* 61:44–48
- Lee MM, Donahoe PK, Silverman BL, Hasegawa T, Hasegawa Y, Gustafson ML, Chang YC, MacLaughlin DT (1997) Measurements of serum mullerian inhibiting substance in the evaluation of children with nonpalpable gonads. *N Engl J Med* 336:1480–1486
- Licea-Perez H, Wang S, Szapacs ME, Yang E (2008) Development of a highly sensitive and selective UPLC/MS/MS method for the simultaneous determination of testosterone and 5 α -dihydrotestosterone in human serum to support testosterone replacement therapy for hypogonadism. *Steroids* 73:601–610
- Meachem SJ, Nieschlag E, Simoni M (2001) Inhibin B in male reproduction: pathophysiology and clinical relevance. *Eur J Endocrinol* 145:561–571
- Nieschlag E, Behre HM, Bouchard P, Corrales JJ, Jones TH, Stalla GK, Webb SM, Wu FC (2004) Testosterone replacement therapy: current trends and future directions. *Hum Reprod Update* 10:409–419
- Nieschlag E, Swerdloff R, Behre HM, Gooren LJ, Kaufman JM, Legros JJ, Lunenfeld B, Morley JE, Schulman C, Wang C, Weidner W, Wu FC (2005) Investigation, treatment and monitoring of late-onset hypogonadism in males: ISA, ISSAM, and EAU recommendations. *Int J Androl* 3:125–127
- O’Connor AE, De Kretser DM (2004) Inhibins in normal male physiology. *Semin Reprod Med* 22:177–185
- Rosner W, Auchus RJ, Azziz R, Sluss PM, Raff H (2007) Utility, limitations, and pitfalls in measuring testosterone: an Endocrine Society position statement. *J Clin Endocrinol Metab* 92:405–413
- Roy P, Alevizaki M, Huhtaniemi I (2008) In vitro bioassays for androgens and their diagnostic applications. *Hum Reprod Update* 14:73–82
- Schürmeyer T, Jung K, Nieschlag E (1984) The effect of an 1100 km run on testicular, adrenal and thyroid hormones. *Int J Androl* 7:276–282
- Sequera AM, Fideleff HL, Boquete HR, Pujol AB, Suárez MG, Ruibal GF (2002) Basal ultrasensitive LH assay: a useful tool in the early diagnosis of male pubertal delay? *J Pediatr Endocrinol Metab* 15:589–596
- Simoni M (2004) Methodology for measuring testosterone, DHT and SHBG in a clinical setting. In: Nieschlag E, Behre HM (eds) *Testosterone action, deficiency, substitution*, 3rd edn. Cambridge University Press, Cambridge, pp 641–664
- Simoni M, Nieschlag E (1991) In vitro bioassays of follicle-stimulating hormone: methods and clinical applications. *J Endocrinol Invest* 14:983–997
- Simoni M, Gromoll J, Nieschlag E (1997) The follicle-stimulating hormone receptor: biochemistry, molecular biology, physiology, and pathophysiology. *Endocr Rev* 18:739–773
- Sinisi AA, Esposito D, Maione L, Quinto MC, Visconti D, De Bellis A, Bellastella A, Conzo G, Bellastella G (2008) Seminal anti-mullerian hormone level is a marker of spermatogenic response during long-term gonadotropin therapy in male hypogonadotropic hypogonadism. *Hum Reprod* 23:1029–1034
- Smith TP, Kavanagh L, Healy ML, McKenna TJ (2007) Technology insight: measuring prolactin in clinical samples. *Nat Clin Pract Endocrinol Metab* 3:279–289
- Stroud MA, Ritz P, Coward PA, Sawyer MB, Constantin-Teodosiu D, Greenhaff PL, Macdonald IA (1997) Energy expenditure using isotope-labelled water (2H218O), exercise performance, skeletal muscle enzyme activities and plasma biochemical parameters in humans during 95 days of endurance exercise with inadequate energy intake. *Eur J Appl Physiol Occup Physiol* 76:243–252
- Sussman EM, Chudnovsky A, Niederberger CS (2008) Hormonal evaluation of the infertile male: has it evolved? *Urol Clin North Am* 35:147–155
- Tüttelmann F, Dykstra N, Themmen AP, Visser JA, Nieschlag E, Simoni M (2009) Anti-Müllerian hormone in men with normal and reduced sperm concentration and men with maldescended testes. *Fertil Steril* 91:1812–1819
- Vermeulen A, Verdonck L, Kaufman JM (1999) A critical evaluation of simple methods for the estimation of free testosterone in serum. *J Clin Endocrinol Metab* 84:3666–3672
- von Eckardstein S, Simoni M, Bergmann M, Weinbauer GF, Gassner P, Schepers AG, Nieschlag E (1999) Serum inhibin B in combination with serum follicle-stimulating hormone (FSH) is a more sensitive marker than serum FSH alone for impaired spermatogenesis in men, but cannot predict the presence of sperm in testicular tissue samples. *J Clin Endocrinol Metab* 84:2496–2501
- Wang C, Nieschlag E, Swerdloff R, Behre HM, Hellstrom WJ, Gooren LJ, Kaufman JM, Legros JJ, Lunenfeld B, Morales A,

- Morley JE, Schulman C, Thompson IM, Weidner W, Wu FC (2009) Investigation, treatment and monitoring of late-onset hypogonadism in males. *Int J Androl* 32:1–10
- Wu FC, Tajar A, Pye SR, Silman AJ, Finn JD, O'Neill TW, Bartfai G, Casanueva F, Forti G, Giwercman A, Huhtaniemi IT, Kula K, Punab M, Boonen S, Vanderschueren D (2008) European male aging study group. *J Clin Endocrinol Metab* 93:2737–2745
- Zitzmann M, Nieschlag E (2001) Testosterone levels in healthy men and the relation to behavioural and physical characteristics: facts and constructs. *Eur J Endocrinol* 144:183–197
- Zitzmann M, Nieschlag E (2003) Hypogonadism in the elderly men. Reliable diagnosis and therapy. *Internist* 44:1313–1321
- Zitzmann M, Faber S, Nieschlag E (2006a) Association of specific symptoms and metabolic risks with serum testosterone in older men. *J Clin Endocrinol Metab* 91:4335–4343
- Zitzmann M, Nordhoff V, von Schönfeldt V, Nordsiek-Mengede A, Kliesch S, Schüring AN, Luetjens CM, Kamischke A, Cooper T, Simoni M, Nieschlag E (2006b) Elevated follicle-stimulating hormone levels and the chances for azoospermic men to become fathers after retrieval of elongated spermatids from cryopreserved testicular tissue. *Fertil Steril* 86:339–347

Contents

8.1 Introduction	119
8.2 Cytogenetic Investigations	119
8.2.1 Conventional Cytogenetic Methods.....	120
8.2.2 Fluorescence In-Situ Hybridization.....	121
8.2.3 Indications for Chromosome Analysis in Andrology	122
8.3 Molecular Genetic Investigations	123
8.3.1 Microdeletions of the Y Chromosome.....	123
8.3.2 Sequencing.....	123
8.3.3 Indications for Genetic Testing.....	123
8.4 Genetic Counselling	124
References	124

8.1 Introduction

Male infertility and hypogonadism may be caused by a genetic defect, which should be investigated by cytogenetic or molecular genetic analysis. The main **indications for genetic testing** in andrology are azoospermia and severe oligozoospermia. In selected cases of hypogonadotropic hypogonadism and Kallmann syndrome, especially those with an evident familial component, mutation screening of the known genes may be indicated. Even if detection of a genetic alteration will not substantially change the treatment, genetic testing should be performed for two reasons: (1) to finalize a causal diagnosis, and (2) to assess the genetic risk for the offspring in case of successful treatment.

The main genetic tests in andrology are: (1) karyotype analysis and other cytogenetic analyses (e.g., fluorescence in situ hybridization: FISH); (2) analysis of microdeletions of the Y chromosome by polymerase chain reaction (PCR); (3) sequencing of selected genes.

8.2 Cytogenetic Investigations

The haploid set of chromosomes resulting from the first meiotic division numbers 23 chromosomes. The somatic cells as well as the spermatogonia and oogonia have a diploid set of chromosomes ($2n = 46$). In the human, most genes are located on the chromosomes of the cell nucleus (nuclear genome), however, some genes are found in the mitochondria (mitochondrial genome). The human haploid genome consists of three billion base pairs, of which only about 1% consists of coding sequences, and contains 25,000–30,000 genes. In contrast, the number of proteins resulting from alternative splicing is markedly higher. The nuclear genome

M. Simoni (✉)
Department of Medicine, Endocrinology and Metabolism,
University of Modena and Reggio Emilia,
I-41126 Modena, Italy
e-mail: Manuela.Simoni@unimore.it

Sensitivity of cytogenetic methods

• Conventional chromosome analysis	6–10 Mb
• Conventional CGH	2 Mb
• Metaphase-FISH	100 Kb
• Interphase-FISH	20 Kb
• Array-CGH	up to < 1 Kb*

Fig. 8.1 Sensitivity of cytogenetic methods. Mb: megabase; Kb: Kilobase

*Depending on array used

consists of single and repetitive sequences. The single segments contain coding sequences, regulatory sequences as well as spacer DNA between regulatory sequences and promoters. The repetitive sequences contain satellite DNA, retroposons, endogenous retrovirus-DNA and transposons. Satellite DNA is characterized according to size of the tandem-like repetitive units into macrosatellites (hundreds to thousands of base pairs), minisatellites (15–100 base pairs) and microsatellites (up to four base pairs).

The human genome shows extraordinary variability, of which the following variations can be distinguished:

- Single nucleotide polymorphisms (SNP) consist of exchanges between nucleotides which may be localized within or outside a gene
- Variable numbers of tandem repeats (VNTR) based on alterations in the number of repetitive sequences
- Copy number variations (CNV) based on deletions or duplications of DNA sequences, which may be as long as several million base pairs

The choice of methods for cytogenetic diagnosis depends on the size of the alterations which are to be investigated (Fig. 8.1).

8.2.1 Conventional Cytogenetic Methods

The chromosomes are best detected during the metaphase, because the chromosomes have maximal condensation during this phase. For routine investigations typically lymphocytes are isolated from a few milliliters of heparinized blood. Mitotic division is stimulated by the mitogen phytohemagglutinine. After 72 h a maximum of cell divisions is generally achieved. In order to arrest these cells in the metaphase the spindle toxin colchicin is added. Consecutive treatment with



Fig. 8.2 Karyogram of an infertile patient with Robertsonian translocation between chromosome 13 and chromosome 14 (GTG staining)

hypotonic salt solution allows the chromosomes to be spread and fixated with a mixture of acetic acid and methanol. This suspension is placed dropwise on a slide and the chromosomes can be visualized after staining, usually at 1,000× magnification.

The most frequently used banding technique is the GTG staining method (G banding after treatment with trypsin and Giemsa staining), which allows identification of the chromosomes. The dark bands are rich in AT, show a high degree of folding and contain fewer genes than the light bands, which are rich in GC. Further staining techniques are Q, G, R, C, DA/DAPI and NOR. To establish the karyotype (“chromosome formula”) appropriate metaphases are photographed or visualized by computer. The chromosomes are then grouped according to size, position of centromere and banding pattern (A to G as well as sex chromosomes), so that a karyogram emerges (Fig. 8.2). Conventional karyotyping is a time-consuming process that cannot yet be automated and requires great experience.

The description of a karyotype follows an internationally uniform system (International System for Cytogenetic Nomenclature, ISCN, 2005). First the number of chromosomes, then – separated by a comma – the constellation of the sex chromosomes (gonosomes) are designated and finally possible aberrations (deletions, duplications, translocations, inversions, insertions or marker chromosomes) are listed according to the nomenclature applicable.

Cytogenetic findings should include the number of cells analyzed, the staining methods used, and the banding level achieved. At a minimum of ten metaphases the number of chromosomes should be identified. When a mosaic is suspected, more metaphases should be analyzed. Of the metaphases identified numerically, at least five should be analyzed structurally. The banding level is important for estimating to what extent structural aberrations could be identified by this investigation. In postnatal investigations a minimum of 400/haploid genome is required as a minimum standard. For certain questions, as for example in repeated miscarriages, a banding level of at least 550 should be ascertained. In conventional cytogenetic investigations deletions or duplications above a size of 5–10Mb (depending on localization) can be recognized.

8.2.2 Fluorescence In-Situ Hybridization

Fluorescence in-situ Hybridization (**FISH**) combines classic cytogenetics with molecular genetic techniques and represents the basic method of molecular cytogenetics. FISH is based on the ability of single-stranded, marked DNA sequences (probes) to bind selectively to single-stranded chromosomal regions according to the complementarity of base pairs. For this purpose chromosomal DNA is denatured and hybridized with DNA probes which were previously marked with fluorochrome. The fluorescing regions are then detected by a microscope fitted with appropriate filters (Fig. 8.3).

FISH is being used increasingly as a supplement to conventional cytogenetic investigation for it has a higher resolution (up to 100 Kb) and can also be applied to interphase nuclei (i.e., without previous cell culture). The choice of probes allows various questions to be asked, for which the following chromosomal regions can be specifically stained:

- Detection of an entire chromosome
- Detection of a chromosome arm
- Detection of one or all centromeres
- Detection of subtelomere regions
- Detection of any chromosome band or region, as the Human Genome Project can theoretically provide probes for all these regions

Recently further methods based on FISH have been developed. By **24-color karyotyping**, such as Multiplex-FISH (M-FISH) or spectral karyotyping FISH (SKY)

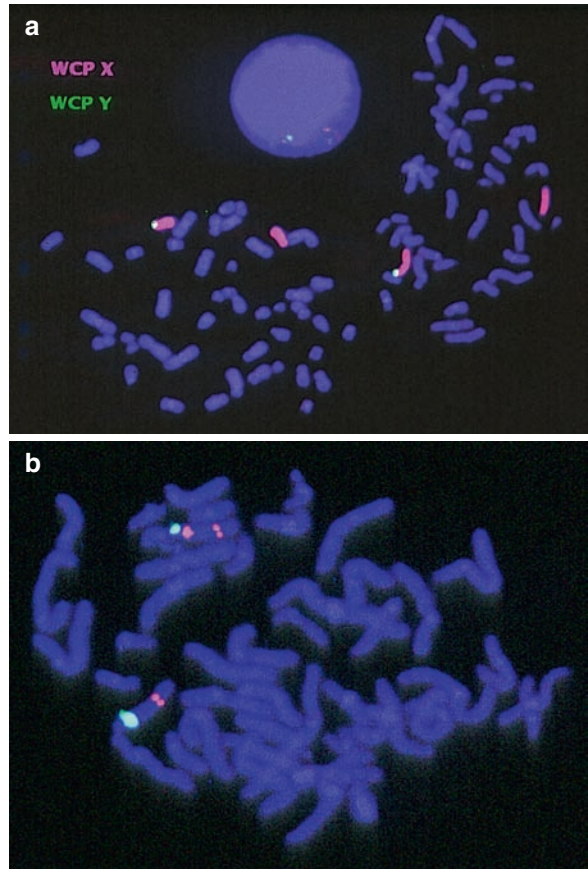
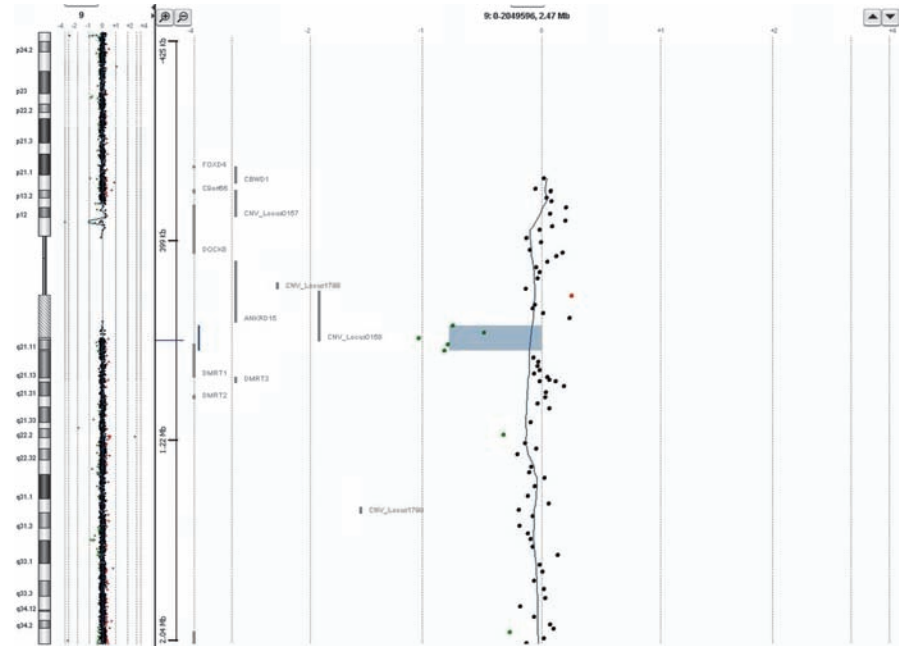

Fig. 8.3 Various FISH analyses. (a) Evidence for a translocation of Y-chromosomal material on the X chromosome in a man with azoospermia and a XX karyotype shown by WCP probes (Whole Chromosome Painting) for the X and Y chromosome. (b) Evidence for a microdeletion on chromosome 15 shown by a locus-specific probe in a patient with Prader-Willi syndrome

all chromosomes are marked by chromosome-specific probes and can be detected by “false colors”. This multicolor hybridization plays a special role in identifying complex interchromosomal aberrations and creates strategies for fully automatic karyotyping.

In **comparative genomic hybridization (CGH)** deletions and amplifications are established in a test DNA. The entire genomic DNA probe to be tested, e.g. from patient leucocytes are isolated, marked with a fluorochrome (e.g., green) and a reference DNA (from a healthy person) is marked with another fluorochrome (e.g., red). There follows a co-hybridization of both DNA probes using metaphases from a healthy person. In the absence of an unbalanced chromosomal disturbance, test and reference DNA will be equally hybridized so that the relationship of red to green will be balanced along all chromosomes. In the event of a deletion, the red-green

Fig. 8.4 Array-CGH with evidence of a deletion of DMRT1 in a female patient with XY gonadal dysgenesis



ratio will favor red, in the case of an amplification, it will be shifted towards green. Even in experienced hands CGH is a demanding procedure. Its advantages are that cell culture is not necessary and the resolution process (about 2 Mb) is better than that of classical cytogenetics.

Array CGH represents a further development of CGH. In contrast to the latter, hybridization is not performed on metaphase chromosomes, but on defined DNA fragments which are fixated on an array, e.g., a glass slide. These DNA fragments can, for example, be synthesized oligonucleotides which represent the entire genome. By this procedure deletions or duplications of less than 100 Kb can be detected and thereby the gap between classical cytogenetics and molecular genetics can be closed (Fig. 8.4).

8.2.3 Indications for Chromosome Analysis in Andrology

Chromosome analysis is indicated in the following situations in reproductive medicine:

1. Chromosome analysis should be carried out in cases of **disorders of sexual differentiation**, as the results are necessary for diagnosis and possible therapy
2. In cases of **male infertility** caused by disturbed spermatogenesis. The frequency of chromosome aberrations

is 6% on average in infertile men and is thus ten times more frequent than in newborns (Egozcue et al. 2000). The probability of a chromosomal disturbance correlates inversely with sperm concentration.

These **chromosomal disorders** are **numeric aberrations** of the sex chromosomes such as 47, XXY in the **Klinefelter syndrome** and **structural aberrations** such as **translocations, inversions, insertions, ring chromosomes or marker chromosomes**. It is especially important to identify patients with chromosomal disorders such as translocations or inversions as in the event of pregnancy (e.g., following ICSI), the likelihood of unbalanced chromosomes in the offspring is clearly increased. In this connection it should be mentioned that the risk of a chromosomal aberration is also increased in women undergoing ICSI. For this reason chromosome analysis should not only be offered to the male with reduced sperm numbers but also to the woman.

- An indication for chromosomal analysis may also arise from the family history. This is, e.g., the case when habitual miscarriages occur caused by a translocation or when heritable chromosomal disturbances can be shown in the **family history**.

The indication for FISH arises when an expected chromosomal alteration, e.g., a microdeletion is not recognizable with conventional chromosomal analysis.

8.3 Molecular Genetic Investigations

8.3.1 Microdeletions of the Y Chromosome

The diagnosis of microdeletions is performed by PCR amplification of selected regions of the long arm of the Y chromosome. For this analysis a sample of decoagulated blood (EDTA or citrate) must be taken for genomic DNA extraction. Lack of PCR amplification suggests the presence of a microdeletion which should be confirmed by a separate PCR reaction based on different primers and following strict quality control rules. According to the current laboratory guidelines issued on behalf of the European Academy of Andrology (EAA) and the European Molecular Genetics Quality Network (EMQN) the method employed should be based on two multiplex PCR reactions using a limited number of robust and well-validated primers covering the three relevant *AZF* regions and including internal controls (Simoni et al. 2004). It is estimated that this basic protocol for routine microdeletion screening is sufficient to detect over 95% of clinically relevant deletions. Commercial kits for routine diagnosis are available but care should be used in the choice of the kit, avoiding those using a too large number of markers which make them prone to analytical errors without improving the diagnostic power. An external quality assessment scheme is currently offered jointly by the EAA and the EMQN (www.emqn.org) and shows that the current molecular diagnostic methods have an accuracy >97%.

8.3.2 Sequencing

Direct DNA sequencing is performed when a mutation of a specific gene is suspected. A sample of decoagulated blood is sent to the laboratory for DNA extraction and analysis. The classical sequencing method of Sanger was based on four separate sequencing reactions to produce labeled DNA fragments which were separated by gel electrophoresis on a denaturing polyacrylamide-urea gel. This method was relatively time-consuming and is now being replaced by modern high throughput methods. The so-called 'dye-terminator sequencing' can be performed in a

single reaction, is rapid and can be automated and performed with computer-controlled sequence analyzers. Each sequencing reaction covers approximately 300–1,000 nucleotides, so large genes need several single reactions. Nevertheless, this method is relatively cheap and suitable for clinical routine. In a well-organized center, results of a sequencing reaction can be provided within a few days.

Sequencing of the *CFTR* gene is indicated in case of obstructive azoospermia with congenital absence of the vas deferens and is routinely performed in genetic centers. Other genes, such as the *KALI*, *GNRHR* and *GPR54* can be analyzed in case of Kallman syndrome or IHH but this analysis is performed in only few centers. National and international external quality assessment schemes are offered for the *CFTR* and other selected genes.

8.3.3 Indications for Genetic Testing

As indicated in Chap. 4, currently a discrete genetic cause can be demonstrated in over 20% of patients presenting with azoospermia and severe oligozoospermia, who are mandatory candidates for genetic screening. Karyotype analysis is indicated in non-obstructive azoospermia, since chromosomal abnormalities are found in about 15% of such patients (mainly Klinefelter syndrome). Translocations are found in about 3% of patients with severe oligozoospermia, who are also candidates for karyotyping, especially if assisted reproduction is planned (Foresta et al. 2005).

Patients with non-obstructive azoospermia or severe oligozoospermia should be investigated for the occurrence of microdeletions of the Y chromosome, which represent one of the few well-recognized genetic causes of spermatogenetic failure resulting in male infertility (Ferlin et al. 2007; Simoni et al. 2008). Patients who may be candidates for ICSI or TESE/ICSI should be offered screening for deletions of the Y chromosome because TESE should not be recommended in cases of complete deletion of the *AZF_a* region, or complete deletion of *AZF_b* or deletions of the *AZF_{b+c}* regions. Moreover, microdeletions of the *AZF_c* region are transmitted to the male offspring if assisted reproduction is performed (Kamischke et al. 1999; Simoni et al. 2004). Therefore, the diagnosis of a deletion has prognostic value and can influence therapeutic options. In general

microdeletion screening is indicated in patients with sperm concentration $<1 \times 10^6/\text{ml}$, a limit above which deletions are extremely rare.

In case of obstructive azoospermia and congenital absence of the vas deferens, the *CFTR* gene should be sequenced.

Several genes involved in the migration and function of GnRH neurones have been discovered which can be mutated in cases of isolated hypogonadotropic hypogonadism with or without anosmia (see Table 12.1) (Simoni and Nieschlag 2007). Search for mutations may be indicated in selected cases, especially in familial cases and considering the mode of inheritance, as discussed in Chap. 12.

8.4 Genetic Counselling

According to the WHO definition, genetic counselling is a communication process dealing with human problems arising from the possible occurrence of a genetic disease within the family.

An attempt is made to help the individual or the family by

- Registering medical facts, including diagnosis, the presumed progression and the treatment available
- Understanding the heritable part of the disease and the likelihood of reoccurrence for certain relatives
- Recognizing the various possibilities for dealing with this likelihood of reoccurrence
- Making a decision appropriate to the risk, the family situation, the ethical and religious beliefs and taking action in accordance with these and
- Dealing as best possible with the handicaps of the afflicted family member

Within the framework of reproductive medicine the following occasions arise for genetic counselling:

- Genetic clarification of male or female infertility or sterility

- Genetic clarification of disturbed sexual differentiation
- Genetic clarification of habitual miscarriage
- Genetic counselling about the risk for offspring following assisted reproduction

Prior to genetic diagnosis, genetic counselling about the meaning and limits of diagnosis should take place. At the very latest genetic counselling is indicated following a suspicious finding, in the course of which the significance of the finding for those seeking help, as well as for relatives and possible offspring is explained.

References

- Egozcue S, Blanco JL, Vendrall JM, Garcia F, Veiga A, Aran B, Barri PN, Vidal F, Egozcue J (2000) Human male infertility: chromosome anomalies, meiotic disorders, abnormal spermatozoa and recurrent abortion. *Hum Reprod Update* 6:93–105
- Ferlin A, Arredi B, Speltra E, Cazzadore C, Selice R, Garolla A, Lenzi A, Foresta C (2007) Molecular and clinical characterization of Y chromosome microdeletions in infertile men: a 10-year experience in Italy. *J Clin Endocrinol Metab* 92:762–770
- Foresta C, Garolla A, Bartoloni L, Bettella A, Ferlin A (2005) Genetic abnormalities among severely oligospermic men who are candidates for intracytoplasmic sperm injection. *J Clin Endocrinol Metab* 90:152–156
- Kamischke A, Gromoll J, Simoni M, Behre HM, Nieschlag E (1999) Transmission of a Y chromosomal deletion involving the deleted in azoospermia (DAZ) and chromodomain (CDY1) genes from father to son through intracytoplasmic sperm injection: case report. *Hum Reprod* 14:2320–2322
- Simoni M, Nieschlag E (2007) Genetics of hypogonadotropic hypogonadism. *Horm Res* 67(Suppl 1):149–154
- Simoni M, Bakker E, Krausz C (2004) EAA/EMQN best practice guidelines for molecular diagnosis of y-chromosomal microdeletions. State of the art 2004. *Int J Androl* 27:240–249
- Simoni M, Tüttelmann F, Gromoll J, Nieschlag E (2008) Clinical consequences of microdeletions of the Y chromosome: the extended Münster experience. *Reprod Biomed Online* 16:289–303

Contents

9.1 Introduction.....	125
9.2 Semen Collection.....	125
9.3 Semen Analysis.....	126
9.3.1 Macroscopic Appearance of the Ejaculate.....	126
9.3.2 Initial Microscopical Examination.....	127
9.3.3 Further Microscopical Analysis.....	127
9.3.4 Additional Analyses.....	131
9.4 Biochemical Analyses of Seminal Fluid.....	132
9.5 Microbiological Tests.....	132
9.6 Objective Semen Analysis.....	133
9.6.1 Sperm Concentration.....	133
9.6.2 Sperm Motility.....	133
9.6.3 Sperm Morphology.....	134
9.7 Quality Control in the Andrology Laboratory.....	134
9.7.1 Internal Quality Control.....	134
9.7.2 External Quality Control.....	134
9.8 Documentation, References Values, Nomenclature and Classification of Semen Parameters.....	135
References.....	137

9.1 Introduction

Semen analysis is performed for evaluation of fertility disorders with or without symptoms of androgen deficiency. The quality of semen analysis varies depending on how and where it is collected, and also on the analytical methods employed. As there are both biological and analytical causes for variations in semen quality, standardizing procedures for the collection and analysis of semen should render results from different laboratories comparable. A minimum number of spermatozoa need to be assessed to achieve acceptable values for total sperm numbers per ejaculate and percentages of motile, viable and morphologically normal cells. The assessment of motility and the rationale for seeking, and how to recognize, morphologically normal spermatozoa are provided.

9.2 Semen Collection

For comparability of results, patients should observe a period of **abstinence** of between 48 h and 7 days. As semen quality reflects the state of sexual arousal and the time it takes to produce the sample (Pound et al. 2002), the conditions of collection are important. The ejaculate should be obtained at the clinic in a suitable room with adjacent toilet and hand basin. This eliminates any effect of temperature and time on a sample that is produced at home and brought to the laboratory; it also ensures a standard time of analysis after collection. The room should contain appropriate illustrated literature, background music and/or video-recordings to provide a suitable atmosphere. Because of the normal variability of the various parameters, an estimation of fertility potential should be based on at least

T. G. Cooper
Centre of Reproductive Medicine and Andrology of the
University, Domagkstrasse 11, D-48129 Münster, Germany
e-mail: TrevorG.Cooper@ukmuenster.de



Fig. 9.1 Wide-mouthed, specially-made glass measuring cylinder and glass rod for the collection and mixing of semen and measurement of its volume

two, and preferably three, semen analyses performed after abstention times of 2–7 days.

The sample should be produced by masturbation into a wide-mouthed, clean glass container in the form of a graduated cylinder, which makes transfer into other vials unnecessary (Fig. 9.1). Alternatively, collection into pre-weighed containers, and reweighing after sample collection, provides the weight (and hence volume) of the sample, as the density of human semen is ~1 g/ml. Transfer of semen from the collection vessel into pipettes, syringes or cylinder to measure its volume is not recommended, as some semen remains in the collecting vessel and volume can be considerably underestimated (Cooper et al. 2007a). It is important that all of the ejaculate is collected (especially the first, sperm-rich fraction) and a record should be made if there has been difficulty in collecting the specimen.

9.3 Semen Analysis

The examination of the ejaculate should always be performed according to the Guidelines of the World Health Organization, which are explained in detail in

the **WHO Laboratory Manual for the Examination and Processing of Human Semen** (WHO 2009). This laboratory handbook belongs in every andrology laboratory and is to be considered a supplement to this book. Only the most important of the standard and optional tests and selected sperm function tests are described in this chapter. The handbook considers semen analysis at three levels:

- Standard tests (macroscopic appearance [appearance, semen volume and pH]), (microscopic appearance [aggregation, agglutination, non-sperm cells]), sperm motility, sperm vitality (if motility is low), sperm numbers, sperm morphology, leukocyte peroxidase activity (if many non-sperm cells are present), mixed antiglobulin reaction test (if much agglutination is present)
- Optional tests (teratozoospermia indices; pan-leukocyte CD4 staining, in vitro mucus penetration tests, biochemical assessments of seminal plasma)
- Research tests (reactive oxygen species, zona interaction tests, induced acrosome reaction tests, hamster oocyte penetration tests).

Semen analysis according to WHO guidelines comprises standard methods, which are robust procedures for determining routine semen variables; optional tests, which may be used in certain situations or by choice of the laboratory; and research tests that are not currently regarded as routine.

9.3.1 Macroscopic Appearance of the Ejaculate

A normal ejaculate has a homogenous grey-opalescent **appearance** and usually liquefies at room temperature within 20 min, when microscopic examination can begin. A **whitish** color may indicate high sperm numbers or presence of leukocytes; a **yellowish** appearance and purulent smell indicate infections; a **reddish-brown** colour indicates the presence of red blood cells (**hemospermia**). For all following examinations the liquefied ejaculate has to be mixed well so that representative samples are obtained. If the **pH, measured soon after liquefaction**, exceeds 8, infection may be suspected, although the pH rises with time after production as CO₂, supporting the buffering capacity, is lost. pH-values (measured with pH paper) lower than 7.0 together with azoospermia indicate

malformation or obstruction of the epididymis, the deferent ducts, the seminal vesicles or the ejaculatory ducts (von Eckardstein et al. 2000).

9.3.2 Initial Microscopical Examination

Microscopical examination can be accomplished with a **phase contrast microscope** on wet preparations of undiluted semen. For these a volume of semen (e.g., 6.5 μ l) is placed on a pre-warmed slide under a cover-slip of appropriate size (e.g., 18 \times 18 mm) to produce a 20 μ m deep chamber. This provides sufficient depth for unrestricted three-dimensional sperm motion meanwhile allowing the spermatozoa to remain in focus. (Other semen volumes and cover slip sizes may be used to achieve this viewing depth.)

9.3.2.1 Sperm Aggregation and Agglutination

Aggregation, the adherence of immotile spermatozoa to debris or other elements of the ejaculate, or motile spermatozoa with non-sperm cells, has to be distinguished from **agglutination** of motile spermatozoa with each other. **Aggregation** is not considered further, since these spermatozoa cannot contribute to fertility. **Agglutination** in the fresh semen sample is suggestive of immunological infertility and is graded according to the type and extent of interaction. Extensive agglutination should be followed by the Mixed Agglutination Reaction (MAR) test to detect anti-sperm antibodies.

9.3.2.2 Non-sperm Cells

Besides spermatozoa, the ejaculate contains **epithelial cells** of the urogenital tract and so-called **round cells** (spermatogenic cells and leukocytes).

Preliminary microscopic observations reveal whether spermatozoa are agglutinated or aggregated, whether non-sperm cell (epithelial cells or round cells [leukocytes, germ cells]) are present and what dilution is needed to assess sperm concentration accurately.

9.3.3 Further Microscopical Analysis

9.3.3.1 Sperm Motility

Sperm motility is examined in the freshly liquefied semen sample at a magnification of \times 400–600. This is performed at room temperature (between 20°C and 24°C) but preferably 37°C, within 60 min of, but preferably by 30 min after, ejaculation on the wet preparation described above. The quality of motility is assessed at 37°C or at room temperature and expressed as the percentage of cells displaying the following classes of motility:

- PR: **progressive** motility (all space-gaining motion, both linear and in large arcs).
- NP: **non-progressive** motility (motion on the spot flagellation or motion in small circles).
- IM: **immotility** (no motion).

Subdivision of the progressively motile spermatozoa into fast and slow is often attempted but it is difficult for technicians to assess velocities accurately (Cooper and Yeung 2006). Where velocities are required, a temperature of 37°C is necessary and CASA systems should be used (see Fig. 9.2). The heads of the normally motile spermatozoa appear globular under light microscopic examination of the ejaculate. So-called **pinhead sperm** are actually sperm tails without heads and can be very motile. As they carry no genetic information they are not included in sperm count, motility or morphology assessments.

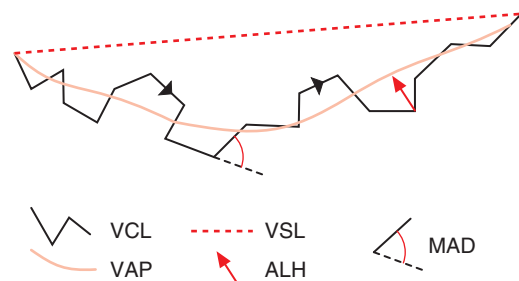

Fig. 9.2 Sperm movement parameters recorded by computer-assisted sperm analysis (CASA). VCL, curvilinear velocity (μ m/s); VAP, averaged path velocity (μ m/s); VSL, straight-line velocity (μ m/s); ALH, amplitude of lateral head displacement (μ m); MAD; mean angular displacement ($^\circ$). Derived parameters: LIN, linearity (VSL/VCL); STR, straightness (VSL/VAP); WOB, wobble (VAP/VCL)

9.3.3.2 Total Sperm Numbers

In a fertile man the number of spermatozoa in the ejaculate can be used both prognostically, as it reflects what he can provide to his partner at coitus, and also diagnostically, since it reflects his testicular sperm output, the patency of the ductal system and epididymal sperm reserves. As the sperm concentration reflects the extent of dilution by accessory gland fluids of the sperm pellet emitted from the epididymides through the urethra at the time of ejaculation, it provides no biologically relevant information about the testis or the accessory glands. It is measured in order to calculate the total sperm number in the ejaculate, which is obtained by multiplying the **sperm concentration** by the **semen volume**.

Sperm concentration is determined in a 100 μ m deep counting chamber, preferably a Neubauer improved chamber, after suitable dilution in a bicarbonate-formalin solution (to fix the cells; this may contain gentian violet or trypan blue solution, to help visualize the spermatozoa). Only intact spermatozoa, with a head and tail (comprising the mid-, principal- and end-piece), are counted. Dilutions, which are designed to permit at least 200 spermatozoa to be observed in the chamber, are chosen according to the number of sperm seen in a $\times 400$ high power field of the

fresh sample. The total number of 400 spermatozoa counted ensures a counting error of 5% for the estimated value. Sperm concentration is derived from the number of cells counted in a known chamber volume and multiplied by the dilution factor.

The number of spermatozoa obtained in an ejaculate depends not only on the abstinence time (Fig. 9.3), but also on the testicular volume (Fig. 9.4). Multiple ejaculates per day further increase the number of spermatozoa recovered (Fig. 9.3), since the epididymis is not emptied at one ejaculation (Cooper et al. 1993). Men with small testicles do not display an abstinence-related increase in sperm numbers (Fig. 9.5). Devices for determining the presence of at least 10×10^6 progressively motile spermatozoa per millilitre semen (Male fertility Test) are available commercially (Fertell.com).

When few spermatozoa are found in semen, it may not be necessary to determine their numbers accurately, if sufficient are available for ART. For contraceptive studies or assessing post-vasectomy semen, counting accurately may be required. **Azoospermia**, defined as the absence of spermatozoa from the ejaculate, is classically assessed by counting spermatozoa in a centrifuged semen pellet (Eliasson 1981). However, whether azoospermia is recorded or not depends on the centrifugation force and time; and not all spermatozoa are brought down at g forces obtainable in routine

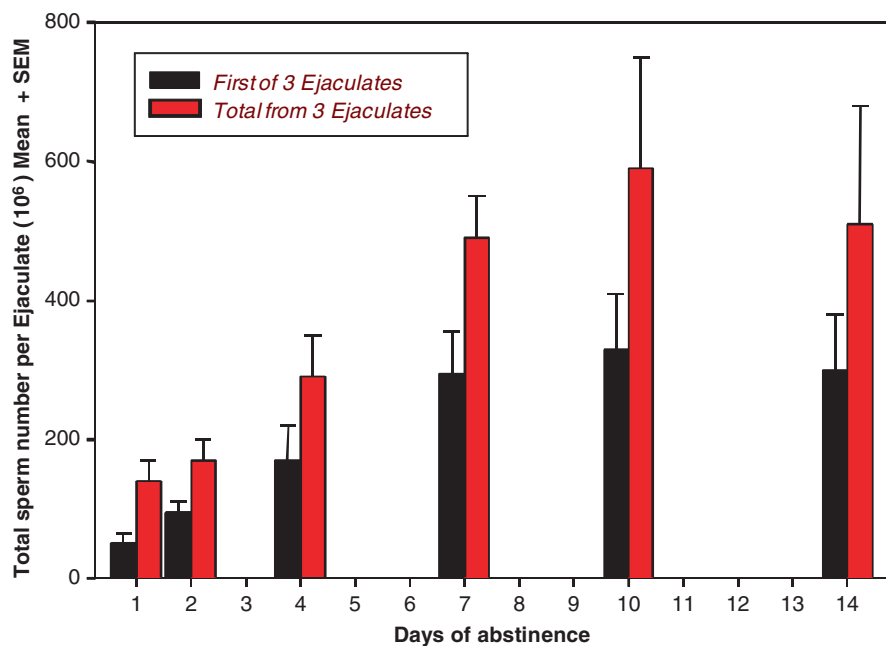

Fig. 9.3 Numbers of spermatozoa in the ejaculates from healthy donors after epididymal emptying (three ejaculates within 4 h on 1 day) followed by a further three ejaculates per day on each day after abstinence times of 1, 2, 4, 7, 10 and 14 days. Total sperm numbers in the first ejaculate (black columns) and in all three ejaculates (red columns) (Adapted from Cooper et al. 1993)

Fig. 9.4 Relationship between sonographically measured paired testicular volumes and total sperm numbers in a single ejaculate of 246 patients (IRM unpublished data)

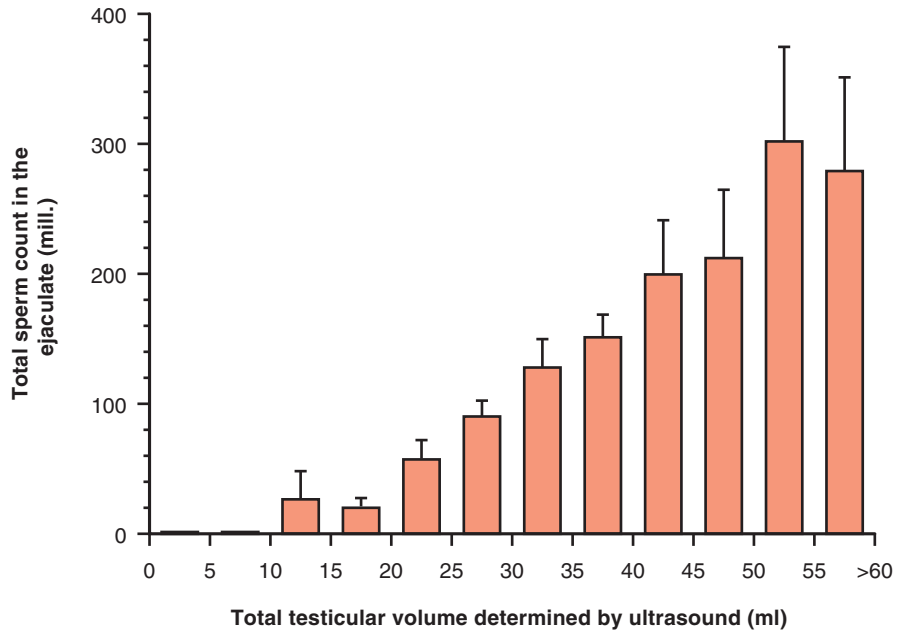
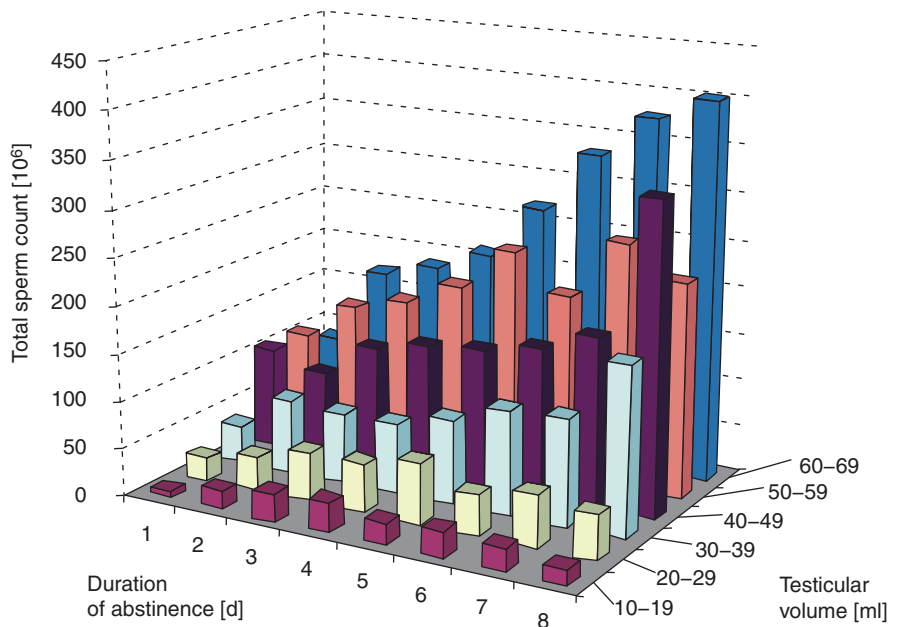

Fig. 9.5 Relationship between testicular volume, abstinence time and total sperm number in 30,965 semen samples from 11,062 infertile men



bench centrifuges (Lindsay et al. 1995; Jaffe et al. 1998; Corea et al. 2005). As examination of the pelleted spermatozoa can therefore never be quantitative, alternative methods are used in which the sensitivity of the assay method for semen is reported. For this, semen is diluted (1 + 1) and the entire Neubauer chamber (all nine grids) is examined for spermatozoa; if fewer than

25 are observed in this volume, the sensitivity of the method (56,000 cells/ml semen) is reported; larger chambers can be used to increase the sensitivity of the assay to 2,000 cells /ml semen (Cooper et al. 2006). Commercially available “dip-stick” tests (SpermCheck) with a sensitivity of 250,000 spermatozoa ml semen are available (Contravac.com).

9.3.3.3 Sperm Morphology

As semen is viscous it cannot be fixed before making a usable microscopical examination smear. Thus sperm morphology is routinely examined in an air-dried, fixed and stained semen smear. Unfortunately, spermatozoa in air-dried smears are smaller than those in living wet preparations, mature sperm heads swell under these conditions and osmotically-sensitive cytoplasmic droplets (present on the majority of motile spermatozoa) are rarely preserved, whereas excess residual cytoplasm (retained on abnormally formed spermatozoa) is retained. Nevertheless, such smears can provide preparations of clearly separated spermatozoa preferentially exposing the flat plane of their heads. The WHO-recommended **Papanicolaou**, **Shorr** and **Diffquik** staining procedures provide adequate coloration for spermatozoa and permits some differentiation of “round” cells.

Normal spermatozoa sought in the ejaculate are those that are biologically selected by reaching endocervical mucus. These spermatozoa, recovered and stained in air-dried fixed smears, exhibit no obvious defects of the head or tail. A similar population of morphologically normal spermatozoa are those that are tightly bound to the zona pellucida (“zona-preferred” spermatozoa [Garrett et al. 1997]). Determining the extent of the mucus-defined subpopulation is the aim of sperm morphology assessment. They have a regular oval-shaped head with an intact and slender midpiece and principal piece displaying no abrupt breaks. The **acrosome** is clearly visible and covers 40–70% of the sperm head area (see Fig. 9.6). Vacuoles do not exceed 20% of the acrosomal area and are not present in the post-acrosomal region. **Cytoplasm** occupying <30% of the head volume are considered droplets and the spermatozoa are normal; if >30%, it is considered excess residual cytoplasm and the spermatozoon is considered abnormal. Men produce few potentially fertilizing spermatozoa since only low proportions of seminal spermatozoa can bind to the zona pellucida (Liu et al. 2003). The ability to detect the presence of the acrosome by lectins (WHO 1999) and specific antibodies (Cross 1995) can be used when specific information about this organelle is required.

Many abnormal forms of spermatozoa are found in semen (large or small oval heads and tapering, pyriform and vacuolated heads [>20% of the head area occupied by unstained vacuolar areas]). Spermatozoa

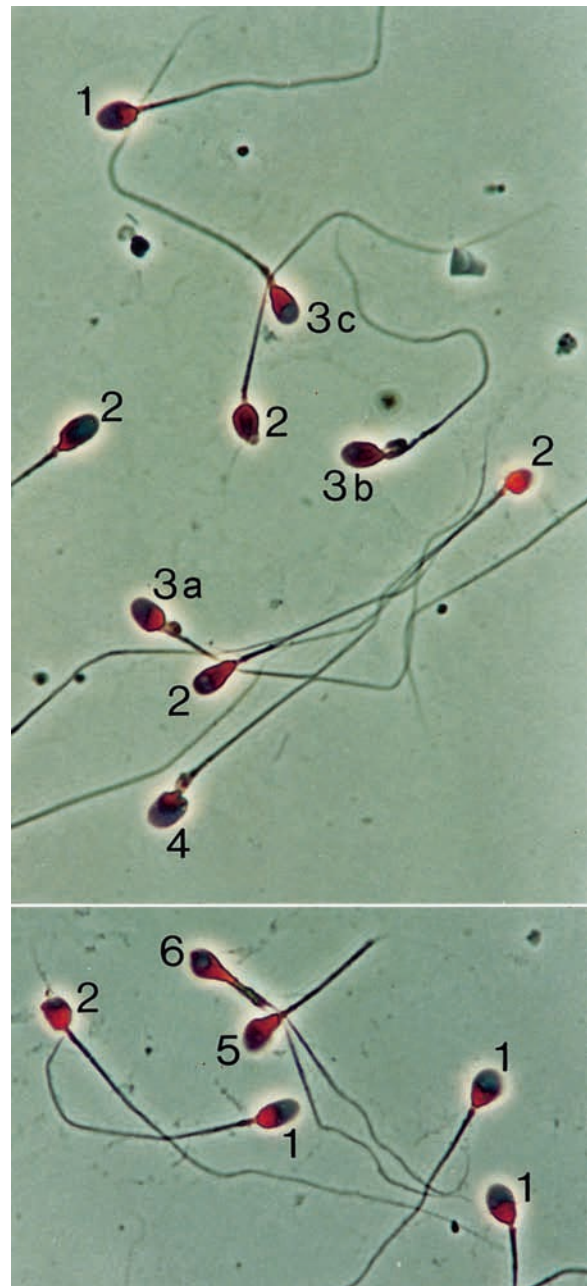

Fig. 9.6 Semen smear after Papanicolaou staining observed with phase contrast optics. Spermatozoa with normal heads (1), abnormal head size or shape (2), cytoplasmic droplet (3a), midpiece defect (3b), excess residual cytoplasm (3c), both head and midpiece defects (4), had and tail defects (5) and head, midpiece and tail defects (6)

without acrosomes have globular heads (**globozospermia**). Some spermatozoa have double heads; heads with irregular forms are classified as amorphous. The midpiece and principal piece can show defects,

tails can be coiled, broken, or doubled. Heads can be separated from tails (decapitation forms) but these are not considered spermatozoa (which are defined as having a head and tail) for the purposes of counting or morphological assessment. Additionally noting the nature of these abnormal forms and calculating morphological indices may be useful in diagnosis.

Standard semen analysis provides information on the total number of spermatozoa per ejaculate as well as the percentage of motile and morphologically normal forms.

9.3.4 Additional Analyses

9.3.4.1 Sperm Vitality

When the percentage of progressively moving spermatozoa is low (<40%), vitality tests are used in order to determine whether spermatozoa have lost their flagellation because of metabolic dysfunction (with a functional axoneme) or axonemal defects (with normal or abnormal metabolism), or are simply dead.

The **eosin test** is based on the fact that membrane-impermeant eosin is excluded by membranes of living cells. The damaged cell membrane of dead spermatozoa can be penetrated by the dye and therefore the heads of such cells are specifically stained red. These can be observed in wet preparations or in smears in which a suspension of nigrosin is included to make sperm heads more readily identifiable. The latter provide samples that can be stored for internal quality control purposes.

The hypo-osmotic swelling (**HOS**) test is a simple test of the integrity of the semi-permeable plasma membrane of the sperm tail (Jeyendran et al. 1984). Semen is diluted with a hypotonic solution so that water enters spermatozoa osmotically. Intact spermatozoa are revealed by swelling-related changes in cell shape that occur to minimize cell area and which enforce a coiling of the flagellum. Swelling is completed by 5 min and by 30 min the various swelling patterns have stabilized and are quantified. In contrast, dead cells with damaged membranes provide no osmotic gradient for swelling to occur.

With the availability of intracytoplasmic sperm injection (ICSI), especially in conjunction with testic-

ular sperm extraction (TESE), the HOS test is of interest, since dead cells can be distinguished from vital but poorly motile cells without the need for a stain, and such a cell can be used for ICSI. Here, culture medium is diluted 1 + 1 to create hypotonicity and only 5 min incubation is employed.

9.3.4.2 Round Cells

A preliminary distinction between leukocytes and spermatogenic cells may be achieved in stained semen smears by the more bluish staining of the former and more pinkish staining of the latter with Papanicolaou staining. Further investigations of the semen for the presence of leukocytes can be made to distinguish the nature of the round cells present.

The detection of peroxidase in wet preparations, which specifically stains **granulocytic leukocytes**, is a simple test for the presence of leukocytes. Their concentration can be measured, as for spermatozoa, from the number of cells in a known chamber volume and taking into account the dilution. The **pan-leukocyte** marker CD45 can be visualized in a more demanding immunocytochemical procedure. Leukocyte concentration can be assessed relative to the number of spermatozoa per unit area (field of view) and from the sperm concentration. The total number of leukocytes per ejaculate is obtained by multiplying their concentration by the semen volume.

9.3.4.3 Immunological Tests

Sperm agglutination in the fresh semen sample may be indicative of the presence of specific sperm antibodies; however, agglutination may not always be caused by antibodies and not all antibodies directed against spermatozoa cause agglutination; others are cytotoxic and interfere with motility disorders.

For the determination of antibodies of the IgA or IgG class directed against sperm antigens, the **mixed antiglobulin reaction (MAR) test** has proved to be useful as a screening test. For this, a fresh semen sample and IgG- or IgA-coated latex particles or erythrocytes are mixed together with antiserum directed against IgA or IgG antibodies. If the respective antibodies are present on the sperm surface, the particles or cells will be bound to the spermatozoa by the

antisera. The proportion of these particle-bound motility sperm can then be quantified. If more than 50% of the spermatozoa are IgG or IgA antibody-coated immunological infertility is likely (Abshagen et al. 1998). If positive, the results may be complemented by sperm mucus interaction tests (**postcoital test**, **Kremer test**) (Paschke et al. 1994).

More sensitive **immunobead tests** on washed spermatozoa can be made and the **indirect immunobead test** permits anti-sperm antibodies in cell-free fluids to be assessed.

For routine screening, vitality tests need not be done unless motility is less than 40%; MAR tests need not be done if there is little agglutination and leukocytes need not be distinguished unless there are many round cells in semen. These tests may be necessary at another visit if the cause of infertility remains uncertain.

9.4 Biochemical Analyses of Seminal Fluid

Different chemical substances in the ejaculate, secreted by specific reproductive organs, can be measured in the ejaculate to serve as markers for these organ's function. As a general principle, a decrease in the concentration of the markers indicates a dysfunction of the secreting organs or an obstruction of the duct system. The determination of specific substances for each level of the post-testicular duct system allows a rough localization of the disorder. However, it should be considered that in the case of bilateral organs, only bilateral dysfunction may cause significant changes of the biochemical markers.

Prostatic function can be gauged by the measurement of **zinc**, **citric acid** and **acid phosphatase**. **Prostaglandins** and **fructose** are secreted mainly by the **seminal vesicles**. Low fructose concentrations in the seminal plasma may indicate bilateral agenesis or severe dysfunction of the seminal vesicles or obstruction of the ejaculatory ducts. In cases of low fructose levels, transrectal ultrasonography of the seminal vesicles before and after ejaculation should be performed for further diagnosis. **L-carnitine**, **glycerophospho-**

choline (GPC) and **neutral α -glucosidase** are markers of **epididymal function** but **carnitine** and **GPC** are also secreted by the seminal vesicles and **acid glucosidase** by the prostate. **Neutral α -glucosidase** is specific for the epididymis and thus has a higher specificity and sensitivity for judgement of epididymal function (Cooper et al. 1990). A severely diminished amount of neutral α -glucosidase in the presence of normal FSH and normal testicular volume is an indication that azoospermia might be caused by bilateral epididymal obstruction or obstruction or agenesis of the vasa deferentia (e.g., CBAVD). Commercial kits are available for the determination of fructose (FertiPro: www.fertipro.com) zinc (Wako Chemicals: www.wako-chemicals.de) and neutral glucosidase (Roche diagnostics: www.roche-applied-science.com).

Seminal biochemistry can provide extra insight into the state of the accessory glands by providing specific information on the seminal vesicles (fructose), prostate (zinc) and epididymis (neutral α -glucosidase), when interpreted together with other clinical parameters.

9.5 Microbiological Tests

Nowadays the classic venereal diseases such as gonorrhoea or syphilis are of minor importance in infertile men in Europe. The predominant microorganisms found are *Chlamydia trachomatis* or *Ureaplasma urealyticum*, as well as gram-negative bacteria typical of urogenital infections (Keck et al. 1998; Weidner et al. 1999). These microorganisms can be identified directly in the urine, ejaculate, prostate exprimate or urethral swab. Leukocyte concentrations higher than 1 million/ml ejaculate alone or with a significant growth of microorganisms in the ejaculate culture may indicate an infection of the efferent seminal system (WHO 1993). Whereas the determination of different microorganisms in an aerobic ejaculate culture is unproblematical, the proof of *Chlamydia* requires special examination techniques. The direct determination of *Chlamydia* in the ejaculate by means of **PCR** (polymerase chain reaction) is considered the "gold standard".

9.6 Objective Semen Analysis

In clinical practice, the classic investigation of the ejaculate retains its central role in the assessment of fertility. However, systematic investigations have shown that the estimation of concentration, motility and morphology of spermatozoa is influenced by significant subjective factors. In addition to standardization of ejaculate analysis by uniform laboratory methods, achieved by use of the WHO Laboratory Manual (WHO 2009), efforts are being made to establish objective laboratory methods.

9.6.1 Sperm Concentration

The use of **DNA flow cytometry** to permit objective and precise determination of **spermatozoa** is based on their extent of **DNA staining**. When incubated with fluorescent propidium iodide (PI) or 4',6-diamidino-2-phenylindole dihydrochloride (DAPI) stains, spermatozoa are characterized by highly condensed (HC) (or condensed chromatin [CC]) peaks, which are less stained and thus lie to the left of the expected haploid (1C or 1N) peak. Since this method allows several thousand cells to be counted in very short time, high precision is possible because statistical counting errors are minimized (Hacker-Klom et al. 1999; Eustache et al. 2001). However, this technique has recently been brought into question since (1) it is not possible to ascertain if the heads assessed have a tail, i.e., are by definition spermatozoa; (2) the volume of liquid assessed, and hence the calculated sperm concentration may not be accurate. Calibration is often performed by co-measurement of fluorescent beads whose concentration is determined by electronic sizer; (3) the HC(CC) peak is not composed solely of spermatozoa:

some cells differ in size or granularity and lack mitochondria (Yeung et al. 2007).

Sperm concentration can also be automatically analyzed by **Computer-Aided Sperm Analysis (CASA) systems** (Table 9.1). Counting the number of sperm cells identified by the size and contrast of the digitized video image of the sperm heads has been hampered by the presence of non-sperm particles (including round cells in the semen recognized by the programme as spermatozoa). Attempts to overcome this problem posed by this contamination include requiring additional criteria such as (1) accepting only oval head shapes, based on measurements of the major and minor axis and their ratio (e.g., Hamilton-Thorne Systems), (2) providing a tail-detection algorithm that scans for projections along the axis of the sperm head (QualiSperm), and (3) recognizing condensed chromatin from fluorescent staining of DNA (Hamilton-Thorne Systems). However, the reliability of these methods to determine sperm concentrations accurately, especially for samples with few spermatozoa, has yet to be established and is hampered by the low depth chambers in which streaming of semen upon filling the chamber causes unequal distribution of spermatozoa (Douglas-Hamilton et al. 2005).

9.6.2 Sperm Motility

Among the various methods for objective measurements of **sperm motility**, the tracking of video images of individual sperm cells by CASA (Table 9.1) provides objective data on velocity. In addition to determining the proportion of motile spermatozoa, these systems allow measurements of kinematic parameters, such as sperm velocity, linearity, amplitude of lateral head displacement and beat cross frequency of the head, although the values are dependent on the settings of the machine (see Fig. 9.2). Correlation with

Table 9.1 Commercially available CASA systems

Equipment	Manufacturer	Address
IVOS	Hamilton Thorne Research, Beverly, MA, USA	http://www.hamiltonthorne.com/research
SCA	Microptics, Barcelona, Spain	http://www.micropticsl.com
ISAS	Proiser, València, Spain	http://proiser.com
MedeaLAB	MTG Vertrieb GmbH, Altdorf, Germany	http://www.medealab.de
QualiSperm	Biophos, Wollerau, Switzerland	http://www.biophos.com

pregnancy rates in vivo or after in vitro fertilization (IVF) showed that evaluation of sperm motility by CASA indeed has predictive value for fertility (De Geyter et al. 1992, 1998; Barratt et al. 1993; Irvine et al. 1994; Garrett et al. 2003). Computers can estimate sperm velocity accurately whereas technicians' subjective assessments of velocity are biased by the overall quality of the sample (Cooper and Yeung 2006).

9.6.3 Sperm Morphology

Standardization of **sperm morphology** is the least developed of all parameters. Computer-aided video techniques are unlikely to be applied soon as improvements. By focusing through the sample, technicians may well be better able to determine if a sperm head is normal, whereas CASA equipment so far depends on images in one plane of focus. Confusion with background seminal protein is also a problem experienced in some semen samples, especially those that do not liquefy easily; problems not present in washed or swim-up samples. Examination of unfixed samples may be useful (Berkovitz et al. 2005) but remain experimental. The achievement of objectivity in the assessment of ejaculate parameters has been only partially successful. Therefore, in clinical practice well-controlled conventional semen analysis remains fundamental in the evaluation of fertility.

CASA investigations are to be considered optional and supplementary for the routine examination of an infertile couple.

9.7 Quality Control in the Andrology Laboratory

The need for effective quality control of ejaculate analysis was demonstrated by a significant discrepancy between different evaluations of sperm concentration and morphology of identical samples analyzed by different laboratories (Neuwinger et al. 1990). Since then initial steps have been taken to establish a strict quality control programme in the andrology laboratory (Cooper et al. 1992, 1999; Clements et al. 1995).

9.7.1 Internal Quality Control

Internal quality control of semen analysis is important for the continuous maintenance of standards throughout the year and for coping with errors arising from changes in personnel. It includes regular determinations of the inter- and intra-technician coefficients of variations for the evaluation of sperm concentration, motility and morphology of the same samples by different technicians (Cooper et al. 1992). Where samples can be stored (morphology and viability slides, fixed semen samples, video-recordings of motility) variation from target (known) values can be performed. In this case the use of video-recording or cryopreserved samples is advantageous (Clements et al. 1995). In large andrology laboratories the calculation of monthly means of all the various determinations can be used for early recognition of a systematic bias in the methods used, provided there is no gross change in clientele (WHO 1999). Determinations of biochemical marker substances in seminal plasma are subjected to the usual internal quality controls of the clinical laboratory.

9.7.2 External Quality Control

All andrology laboratories should enrol in **external quality control** schemes (Table 9.2). These provide information on the overall agreement between laboratories and are thus essential if multi-centre clinical studies are to be performed at separate centres. There are schemes for monitoring sperm concentration, motility, morphology and anti-sperm antibodies. Providing that all technicians in the same laboratory are in good agreement (determined from internal QC), any technician may analyse the external QC sample. Regular feedback of the results to the technicians is mandatory in enforcing consistent application of selection criteria so that eventual agreement with designated values can be reached (Cooper et al. 1999, 2002, 2007b). In Germany this is being considered as obligatory for laboratories performing semen analysis (Richtlinien der Bundesärztekammer). External QC programmes are currently being developed for the determination of biochemical marker substances in seminal plasma.

Table 9.2 List of some EQC programmes for semen analysis

Country	Programme	Address	URL
Australia	External Quality Assurance Schemes for Reproductive Medicine	Fertility Society of Australia, PO Box 1101, West Leederville, Western Australia 6901, Australia	http://www.fsa.au.com/
Denmark	Dansk Institut for Ekstern Kvalitetssikring for Laboratorier	Sundhedssektoren, DEKS 54MI, Herler Universitets sygehns, Herler Ringvej 75, 2730 Herlor Denmark	http://www.deks.dk/
Germany	QuaDeGA	Centre of Reproductive Medicine and Andrology, Domagkstrasse 11, D-48129 Münster, Germany	http://www.dgandrologie.de/
Great Britain	UKNEQAS Schemes for Andrology	Department of Reproductive Medicine, St. Mary's Hospital, Whitworth Park, Manchester M13 0JH, United Kingdom	http://www.ukneqas.org.uk/
Italy	Valutazione Esterna di Qualità	Gruppo Controllo Qualità Analitico Azienda Ospedaliero-Universitaria di Bologna, Policlinico Sant'Orsola-Malpighi	http://legacy.aosp.bo.it/veq/qm/veq-profilo/veq_profilo-andrologico.htm
Scandinavia	NAFA (Nordic Association for Andrology)	Andrology Unit, Reproductive Medicine Centre, Karolinska Hospital, PO Box 140, SE-171 76 Stockholm, Sweden	http://www.eshre.com/emc.asp
Spain	Centro de Estudio e Investigación de la Fertilidad (CEIFER)	Granada, Spain	info@ceifer.com
USA	American Association Bioanalysts Proficiency Testing Service	205 West Levee Brownsville, Texas 78520–5596, USA	http://www.aab.org

9.8 Documentation, Reference Values, Nomenclature and Classification of Semen Parameters

The documentation of semen quality and serum hormones is best managed on an evaluation sheet containing several columns in which the values of ejaculate examinations at different time-points can be entered (Table 9.3). This enables straight-forward evaluation and comparison of the results of several examinations. The values in Table 9.4 are the lower reference limits in semen from men whose partners had time-to-pregnancy of 12 months or less (WHO 2009). Samples with values above or below the lower reference limit can be described by the terminology given in Table 9.5.

The investigation of ejaculate parameters plays a central role in the evaluation of male fertility. Since the occurrence of a pregnancy depends on many factors, particularly on the reproductive functions of the female (see Chap. 20), examination of the ejaculate parameters is only one of many prognostic tests of the couple's fertility. Sharp discrimination between a fertile and infertile male is not possible on the basis of the parameters and diagnoses mentioned above. This is theoretically only possible in the case of azoospermia (but see the problems in assessing this above). Otherwise, semen parameters have value only in relation to female reproductive functions since subnormal semen parameters can be compensated by optimal reproductive functions of the female partner and may be compatible with fertility.

Table 9.3 Specimen documentation form

Name			
Code	Date	Date	Date
Collection (1, at laboratory, 2, at home)			
Collection time (hour: min)			
Sample delivered (hour: min)			
Analysis begun (hour: min)			
Patient			
Abstinence time (days)			
Medication			
Difficulties in collection			
Semen			
Treatment (e.g. Bromelain)			
Complete (1, complete; 2, incomplete)			
Appearance (1, normal; 2, abnormal)			
Viscosity (1, normal; 2, abnormal)			
Liquefaction (1, normal; 2, abnormal (min))			
Agglutination (%)			
pH [>7.2]			
Volume (ml)[>1.5]			
Spermatozoa			
Total number (10^6 /ejaculate) [>39]			
Concentration (10^6 /ml) [>15]			
Vitality (% live) [>58]			
Total motile PR+NP (%) [>40]			
Progressive PR (%) [>32]			
Non-progressive NP (%)			
Immotile IM (%)			
Normal forms (%) [>4]			
Abnormal heads (%)			
Abnormal midpieces (%)			
Abnormal principal pieces (%)			
Excess residual cytoplasm (%)			
Direct MAR-Test IgG (%) (3 or 10 min) [<50]			
Direct MAR-Test IgA (%) (3 or 10 min) [<50]			
Non-sperm cells			
Peroxidase-positive cell concentration (10^6 /ml)			
Accessory gland function			
Zinc (μmol /ejaculate) [≥ 2.4]			
Fructose (μmol /ejaculate) [≥ 13]			
α -Glucosidase (neutral) (mU/ejaculate) [≥ 20]			
Technician			

Table 9.4 Lower reference limits for semen parameters for couples with a time to pregnancy of 12 months or less

Parameter	Suggested normal value (WHO 1999)	Lower reference limit (confidence intervals) (WHO 2009)
Semen volume (ml):	≥ 2.0	1.5 (1.4–1.7)
Total motility (PR + NP, %)		40 (38–42)
Progressive motility (a+b, PR, %)	≥ 50	32 (31–34)
Vitality (%)	≥ 50	58 (55–63)
Total sperm number (10 ⁶ /ejaculate)	≥ 40	39 (33–46)
Sperm concentration (10 ⁶ /ml)	≥ 20	15 (12–16)
Sperm morphology (normal, %)		4 (3–4)
<i>Other consensus values</i>		
pH	≥ 7.2	≥ 7.2
Zinc (μmol/ejaculate)	≥ 2.4	≥ 2.4
Fructose (μmol/ejaculate)	≥ 13	≥ 13
Neutral α-glucosidase (mU/ejaculate)	≥ 20	≥ 20
White blood cells (10 ⁶ /ml)	< 1	< 1
MAR-test (%)	< 50	< 50
Immunobead-test (%)	< 50	< 50

Table 9.5 Descriptive terminology of semen

Terminology	Description
Normozoospermia	Total number or concentration* of, and percentages of progressively motile and morphologically normal, spermatozoa equal to or above the lower reference limits
Oligozoospermia	Total number or concentration* of spermatozoa below the lower reference limit
Asthenozoospermia	Percentage or concentration* of progressively motile spermatozoa below the lower reference limit
Teratozoospermia	Percentage or concentration* of morphologically normal spermatozoa below the lower reference limit
Oligoasthenozoospermia	Total number or concentration* of, and percentage of progressively motile, spermatozoa below the lower reference limits
Oligoteratozoospermia	Total number or concentration* of, and percentage of morphologically normal, spermatozoa below the lower reference limits
Asthenoteratozoospermia	Percentages of both progressively motile and morphologically normal spermatozoa below the lower reference limits
Oligoasthenoteratozoospermia	Total number or concentration* of, and percentages of both progressively motile and morphologically normal, spermatozoa below the lower reference limits
Cryptozoospermia	Spermatozoa absent from fresh preparations but observed in a centrifuged pellet (3,000 g for 15 min)
Necrozoospermia	Low percentage of live, and high percentage of immotile, spermatozoa in the ejaculate
Azoospermia	No spermatozoa in the ejaculate. Given as the lower limit of quantification for the counting method used
Leukospermia	Presence of leukocytes in the ejaculate (leukocytospermia, pyospermia)
Haemospermia	Presence of erythrocytes in the ejaculate (Haematospermia)
Aspermia	No semen (no or retrograde ejaculation)

* depending on study

References

- Abshagen K, Behre HM, Cooper TG, Nieschlag E (1998) Influence of sperm surface antibodies on spontaneous pregnancy rates. *Fertil Steril* 70:355–356
- Barratt CLR, Tomlinson MJ, Cooke ID (1993) Prognostic significance of computerized motility analysis for in vivo fertility. *Fertil Steril* 60:520–525
- Berkovitz A, Eltes F, Yaari S, Katz N, Barr I, Fishman A, Bartoov B (2005) The morphological normalcy of the sperm nucleus and pregnancy rate of intracytoplasmic injection with morphologically selected sperm. *Hum Reprod* 20:185–190
- Clements S, Cooke ID, Barratt CLR (1995) Implementing comprehensive quality control in the andrology laboratory. *Hum Reprod* 10:2096–2106
- Cooper TG, Yeung CH (2006) Computer-aided evaluation of assessment of “grade a” spermatozoa by experienced technicians. *Fertil Steril* 85:220–224
- Cooper TG, Yeung CH, Nashan D, Jockenhoevel F, Nieschlag E (1990) Improvement in the assessment of human epididymal

- function by the use of inhibitors in the assay of α -glucosidase in seminal plasma. *Int J Androl* 13:297–305
- Cooper TG, Neuwinger J, Bahrs S, Nieschlag E (1992) Internal quality control of semen analysis. *Fertil Steril* 58: 172–178
- Cooper TG, Keck C, Oberdieck U, Nieschlag E (1993) Effects of multiple ejaculations after extended periods of sexual abstinence on total, motile and normal sperm numbers, as well as accessory gland secretions from healthy normal and oligozoospermic men. *Hum Reprod* 8: 1251–1258
- Cooper TG, Atkinson AD, Nieschlag E (1999) Experience with external quality control in spermatology. *Hum Reprod* 14:765–769
- Cooper TG, Björndahl L, Vreeburg J, Nieschlag E (2002) Semen analysis and external quality control schemes for semen analysis need global standardization. *Int J Androl* 25: 306–311
- Cooper TG, Hellenkemper B, Jonckheere J, Callewaert N, Grootenhuys AJ, Kersemaekers WM, Leung A, Wang C (2006) Azoospermia: virtual reality or possible to quantify? *J Androl* 27:483–490
- Cooper TG, Brazil C, Swan SH, Overstreet JW (2007a) Ejaculate volume is seriously underestimated when semen is pipetted or decanted into cylinders from the collection vessel. *J Androl* 28:1–4
- Cooper TG, Hellenkemper B, Nieschlag E (2007b) External quality control for semen analysis in Germany – Qualitätskontrolle der Deutschen Gesellschaft für Andrologie (QuaDeGA) the first five years. *J Reprod Med Endocrinol* 4: 331–335
- Corea M, Campagnone J, Sigman M (2005) The diagnosis of azoospermia depends on the force of centrifugation. *Fertil Steril* 83:920–922
- Cross NL (1995) Methods for evaluating the acrosomal status of human sperm. In: Fenichel P, Parinaud J (eds) *Human sperm acrosome reaction*. (Colloques INSERM) John Libbey Eurotext, Collioure, France, pp 277–285
- De Geyter C, De Geyter M, Schneider HPG, Nieschlag E (1992) Interdependent influence of follicular fluid oestradiol concentration and motility characteristics of spermatozoa on in-vitro fertilization results. *Hum Reprod* 7:664–670
- De Geyter C, De Geyter M, Koppers B, Nieschlag E (1998) Diagnostic accuracy of computer-assisted sperm motion analysis. *Hum Reprod* 13:2512–2520
- Douglas-Hamilton DH, Smith NG, Kuster CE, Vermeiden JP, Althouse GC (2005) Capillary-loaded particle fluid dynamics: effect on estimation of sperm concentration. *J Androl* 26:115–122
- Eliasson R (1981) Analysis of semen. In: Burger H, de Kretser D (eds) *The testis*. Raven, New York, pp 381–399
- Eustache F, Jouannet P, Auger J (2001) Evaluation of flow cytometric methods to measure human sperm concentration. *J Androl* 22:558–567
- Garrett C, Liu DY, Baker HW (1997) Selectivity of the human sperm-zona pellucida binding process to sperm head morphology. *Fertil Steril* 67:362–371
- Garrett C, Liu DY, Clarke GN et al (2003) Automated semen analysis: ‘zona pellucida preferred’ sperm morphometry and straight-line velocity are related to pregnancy rate in subfertile couples. *Hum Reprod* 18:1643–1649
- Hacker-Klom UN, Göhde W, Nieschlag E, Behre HM (1999) DNA flow cytometry of human semen. *Hum Reprod* 14: 2506–2512
- Irvine DS, Macleod IC, Templeton AA, Masterton A, Taylor A (1994) A prospective clinical study of the relationship between the computer-assisted assessment of human semen quality and the achievement of pregnancy in vivo. *Hum Reprod* 9:2324–2334
- Jaffe TM, Kim ED, Hoekstra TH, Lipshultz LI (1998) Sperm pellet analysis: a technique to detect the presence of sperm in men considered to have azoospermia by routine semen analysis. *J Urol* 159:1548–1550
- Jeyendran RS, Van der Ven HK, Perez-Palaez M, Crabo BG, Zeaveld LJD (1984) Development of an assay to assess the functional integrity of the human sperm membrane and its relationship to other semen characteristics. *J Reprod Fertil* 70:219–228
- Keck C, Gerber-Schäfer C, Clad A, Wilhelm C, Breckwoldt M (1998) Seminal tract infections: impact on male fertility and treatment options. *Hum Reprod Update* 4:891–903
- Lindsay KS, Floyd I, Swan R (1995) Classification of azoospermic samples. *Lancet* 345:1642
- Liu DY, Garrett C, Baker HW (2003) Low proportions of sperm can bind to the zona pellucida of human oocytes. *Hum Reprod* 18:2382–2389
- Neuwinger J, Behre HM, Nieschlag E (1990) External quality control in the andrology laboratory: an experimental multicenter trial. *Fertil Steril* 54:308–314
- Paschke R, Schulze Bertelsbeck D, Bahrs S, Heinecke A, Behre HM (1994) Seminal sperm antibodies exhibit an unstable spontaneous course and an increased incidence of leucocytospermia. *Int J Androl* 17:135–139
- Pound N, Javed MH, Ruberto C, Shaikh MA, Del Valle AP (2002) Duration of sexual arousal predicts semen parameters for masturbatory ejaculates. *Physiol Behav* 76:685–689
- von Eckardstein S, Cooper TG, Rutscha K, Meschede D, Horst J, Nieschlag E (2000) Seminal plasma characteristics as indicators of cystic fibrosis transmembrane conductance regulator (CFTR) gene mutations in men with obstructive azoospermia. *Fertil Steril* 73:1226–1231
- Weidner W, Krause W, Ludwig M (1999) Relevance of male accessory gland infection for subsequent fertility with special focus on prostatitis. *Hum Reprod Update* 5:421–432
- WHO (1993) WHO Manual for the standardized investigation and diagnosis of the infertile couple. In: Rowe PJ, Hargreave TB, Mellows HJ, Comhaire FH (eds). Cambridge University Press, Cambridge
- WHO (1999) WHO Laboratory manual for the examination of human semen and sperm-cervical mucus interaction. Cambridge University Press, Cambridge
- WHO (2009) WHO Laboratory manual for the examination and processing of human semen. 5th ed. World Health Organization Geneva (in press)
- Yeung CH, Beiglböck-Karau L, Tüttelmann F, Nieschlag E (2007) The presence of germ cells in the semen of azoospermic, cryptozoospermic and severe oligozoospermic patients: stringent flow cytometric analysis and correlations with hormonal status. *Clin Endocrinol* 67:767–775

Contents

10.1 Introduction	140	10.10 Sperm–Egg Fusion	145
10.1.1 Sperm Function in General.....	140	10.10.1 The Hamster Oocyte Penetration (HOP) Test/Sperm Penetration Assay (SPA).....	145
10.2 Sperm Survival	140	10.10.2 Liposome Markers.....	145
10.3 Flagellar Function	140	10.11 Sperm Centrosome	146
10.3.1 Assessment of Sperm Motility.....	140	10.12 Chromosomal Complement	147
10.3.2 Motility in Semen.....	141	10.13 DNA Degradation	147
10.3.3 Motility After Sperm Washing.....	141	10.13.1 Mitochondrial DNA (mtDNA).....	147
10.3.4 Motility Within Mucus.....	141	10.13.2 Nuclear DNA (nDNA).....	147
10.3.5 Passage Through the Cumulus.....	141	10.14 Assays of Chromatin Compaction	147
10.4 Mitochondrial Function	142	10.14.1 Staining Properties of Nucleoproteins....	148
10.5 The Cytoplasmic Component	142	10.14.2 Staining Properties of Nucleic Acids.....	148
10.5.1 Cytoplasmic Droplets as a Normal Structure.....	142	10.14.3 Physical Dispersion of DNA.....	148
10.5.2 Excess Residual Cytoplasm.....	142	10.15 Assays of DNA Fragmentation	149
10.5.3 Reactive Oxygen Species and Lipid Peroxidation.....	142	10.15.1 Detection of DNA Fragmentation.....	149
10.6 Capacitation	143	10.15.2 Biochemical Assays.....	149
10.7 Interaction with the Oviductal Epithelium	143	10.16 DNA Methylation	149
10.8 Interaction with the Zona Pellucida	143	10.17 Clinical Prognostic Value of DNA Status Tests	149
10.8.1 Zona Binding Tests.....	143	10.18 Assays of Sperm RNA	150
10.8.2 Hyaluronic Acid as Zona Surrogate.....	144	10.18.1 Gene Transcripts.....	150
10.8.3 Zona Penetration Test.....	144	10.18.2 Transcript Translation Products.....	150
10.9 Acrosome Reaction	144	10.19 Sperm Proteomics	150
10.9.1 Zona-Induced Acrosome Reactions.....	145	10.20 Conclusion and Future Approaches	151
10.9.2 Recombinant Zona Proteins.....	145	References	151

C.-H. Yeung (✉)
 Centre of Reproductive Medicine and Andrology of the
 University, Domagkstrasse 11, D-48129 Münster, Germany
 e-mail: ChingHei.Yeung@ukmuenster.de

10.1 Introduction

There is a general feeling that the routinely measured semen parameters (sperm number, motility, vitality, morphology) do not monitor sperm function and that they are inadequate for predicting fertility (Lewis 2007). Whereas routine morphological staining may be complemented by specific lectin or immunocytochemical stains of particular sperm structures (WHO 1999a, b; Gomez et al. 1996), additional investigations, in which certain functions of the spermatozoon are assessed, may provide clinically useful prognostic or diagnostic information. These tests should distinguish between fertile and infertile men or indicate the reason for the infertility and hence be of use in suggesting a rational therapy. This chapter discusses the different cellular aspects required of spermatozoa during fertilization that can be tested.

10.1.1 Sperm Function in General

Natural fertilization is a complex sequential process (see Fig. 10.1 and Chap. 3). Spermatozoa are highly specialized to function as single cells in a temporally and spatially precise manner with the ultimate goal of delivering the paternal genome to the oocyte. The spermatozoon comprises different functional compartments and regulation of sperm functions is similarly compartmentalized. It is devoid of much cytoplasm and may not be able to rely on synthesis of functional proteins since transcription and translation processes have generally ceased. Appropriate sperm function in the right place at the right time is controlled by signal transduction mechanisms via secondary messengers, lipid changes in cell membranes, ion fluxes across cell membranes, and post-translational protein modifications, including phosphorylation. Thus molecules located on cellular structures such as the fibrous sheath and acrosome serve as scaffolds to maintain interaction between signal transducers and adjacent substrates in localised regions (see Chap. 3). Some sperm function tests aim to mimic certain aspects of the fertilization process, whereas others probe particular organelles or components (Fig. 10.1). Recent research indicates that some cellular components operate far beyond the cell's entry into the oocyte, with roles in syngamy and initiation of embryo development.

10.2 Sperm Survival

Judging the longevity of spermatozoa by monitoring their survival (duration of motility) in semen is of little predictive value for survival in the female tract as changes in semen pH, due to bacterial growth, will be inconsistent between samples and render the results uninterpretable. However, testing survival of washed preparations may be of value when overnight incubation of spermatozoa, for e.g., in vitro fertilization (IVF), is anticipated. There is as yet no evidence that this is predictive of IVF success or pregnancy. It may only be valid as a test for checking the toxicity of antibiotic-containing sperm preparation media (Claassens et al. 2000).

10.3 Flagellar Function

Spermatozoa need motility to move through mucus, to escape from the oviductal epithelium and penetrate the cumulus oophorus and the zona pellucida.

10.3.1 Assessment of Sperm Motility

In addition to routine, subjective, microscopical analysis of sperm motion in semen (see Chap. 9), objective assessment of sperm motility (different patterns of sperm motility) can be ascertained by computer-aided sperm analysis (CASA) that can quantify various kinematic parameters. These programmes distinguish between progressive motility, which is required for penetration of cervical mucus, and hyperactivation, which is required for detachment from the oviductal epithelium and penetration of the cumulus and zona pellucida.

The characteristic **hyperactivated motility patterns** can be observed in capacitated spermatozoa contained in 20–50µm-deep chambers. By the use of computerized motion analysis (CASA) with pre-set kinematic criteria to distinguish different subpopulations of motile spermatozoa, hyperactivated spermatozoa can be distinguished from those non-hyperactivated by their high VCL (curvilinear velocity), low LIN (linearity, calculated as VSL/VCL (straight line/curvilinear velocity) and large ALH (amplitude of the lateral

head displacement) values of the former (see Chap. 9 for the definitions of these sperm kinematic parameters). The clinical significance of such CASA data is reflected by their correlation with IVF outcomes or natural pregnancy rates (Garrett et al. 2003).

10.3.2 Motility in Semen

The average path velocity (VAP, see Chap. 9) is generally considered an indicator of the efficiency of flagellation and forward progression of the spermatozoon and is important for negotiating the female tract. A seminal population of spermatozoa displaying hyperactivated motility, indicative of precocious capacitation, would not penetrate mucus, and such capacitation-like behavior of native spermatozoa would not auger well for fertilization following natural insemination.

10.3.3 Motility After Sperm Washing

After sperm preparation, the extent of hyperactivation is associated with the extent of zona pellucida-induced acrosome reactions (Liu et al. 2007), whereas the correlation of hyperactivated motility with zona binding is debated (Coddington et al. 1991; Liu et al. 2007). Thus lower percentages of hyperactivated cells may be prognostic of failure in zona penetration and thus failure of *in vitro*, and possibly *in vivo*, fertilization. Testing for hyperactivation in washed sperm preparations may also be useful for deciding between the options as appropriate therapy of *in vitro* fertilization (IVF: when zona binding, the acrosome reaction and zona penetration are necessary) or intracytoplasmic sperm injection (ICSI: no zona binding or acrosome reaction is necessary).

10.3.4 Motility Within Mucus

Standard mucus penetration tests utilize cervical mucus in either a slide test (examining the escape of spermatozoa from the interface of semen and mucus under a cover slip) or measuring the distance of migration of spermatozoa through a mucus-filled capillary

tube. The natural variation in human mucus composition and consistency makes it difficult to interpret purely sperm-associated defects, and similar problems led to the demise of commercially available surrogate bovine mucus. Several synthetic mucus preparations with viscosity similar to mid-cycle cervical mucus have been tested as surrogate mucus. The ability of spermatozoa to penetrate these preparations of hyaluronic acid (Neuwinger et al. 1991; Tang et al. 1999) and methylcellulose (Ivic et al. 2002) provides information on flagellar function, hydrodynamic properties or cell volume regulation (Yeung et al. 2006), as mucus is a barrier to spermatozoa with abnormal head shapes or those that are osmotically swollen. However, these mucus penetration tests will not provide information on anti-sperm antibodies.

Differences in flagellar function of spermatozoa from fertile and infertile men that are not evident within seminal plasma may show up in highly viscous fluid. This may have diagnostic potential to distinguish different causes of infertility stemming from flagellar dysfunction.

10.3.5 Passage Through the Cumulus

Examination of spermatozoa from normozoospermic ejaculates after their passage through a column of cumulus cells (Rijsdijk and Franken 2007) reveals that they display progressive, not hyperactivated, motility and are enriched in morphologically normal, capacitated cells with more compact DNA and better zona-binding ability than those that have not penetrated the cumulus mass. Because many of these cells are already acrosome-reacted, and acrosome-reacted spermatozoa do not bind to the zona pellucida (Liu et al. 2006b), the reserve of capacitated but acrosome-intact and non-hyperactivated spermatozoa would be the potentially fertilizing spermatozoa *in vivo*.

The prognostic or diagnostic importance of this test is not known as it has not been used to compare spermatozoa from fertile and infertile men. The low availability of cumulus cells makes this test currently only of academic interest.

10.4 Mitochondrial Function

The energy that electrons lose in the process of cytochrome oxidation is used to pump protons across the inner mitochondrial membrane (St John et al. 2000). This generates an inner membrane potential that can be monitored by certain fluorescent cationic dyes (e.g., JC-1). Correlations between this membrane potential and progressive motility and IVF success have been documented (Marchetti et al. 2004). Only motile spermatozoa have active mitochondria and spermatozoa from some patients with oligoasthenoatozoospermia lack the mitochondrial enzyme NADH dehydrogenase (ND5); however, no difference has been found in sperm mitochondrial activity between fertile and infertile men (Meseguer et al. 2004).

Although the measurement of mitochondrial membrane potential documents mitochondrial function, it may not provide more clinical information than that indicated by the motility of spermatozoa, since the two parameters are correlated.

10.5 The Cytoplasmic Component

In wet preparations, human spermatozoa contain cytoplasm in a so-called droplet, as found in other species, that may extend from the neck to the end of the mid-piece. The distinction between the cytoplasmic droplets (CDs) of normal spermatozoa, and the excess residual cytoplasm (ERC) of abnormally formed cells, is evident in air-dried semen smears (see Chap. 9). Since CDs are osmotically sensitive, they rupture during morphological preparation and are thus not normally well preserved in stained preparations (<30% the head size). On the other hand, large amounts (>30% the head size) of retained, excess residual cytoplasm, characteristic of spermatozoa from an abnormal spermatogenic process, is incorrectly called a cytoplasmic droplet in many textbooks (Cooper et al. 2004; Cooper 2005).

10.5.1 Cytoplasmic Droplets as a Normal Structure

The cytoplasmic droplet is seen in the majority of motile spermatozoa in wet preparations of semen, in

routine medium and within surrogate mucus (Fetic et al. 2006), disproving that its presence produces or reflects a dysfunctional cell. As the site of ion channels employed by spermatozoa for volume regulation (Yeung and Cooper 2008), and likely the site of osmotic changes, the cytoplasmic droplet may provide an important functional role in volume regulation for fertilizing spermatozoa.

Since spermatozoa from fathers and donors can regulate their volume better than those of patients (Fetic et al. 2006; Yeung and Cooper 2008), observations of the presence of the droplet on live spermatozoa may provide novel diagnostic information on spermatozoa from infertility patients.

10.5.2 Excess Residual Cytoplasm

The retention by spermatozoa of excess cytoplasm, normally shed within the testis and phagocytosed by Sertoli cells to form residual bodies, reflects testicular dysfunction. Retained cytoplasm on spermatozoa is associated with excessive production of reactive oxygen species (ROS), related to supra-normal amounts of NADH oxidase and glucose-6-phosphate dehydrogenase activity in the cell (Gomez et al. 1996). Spermatozoa with ERC display higher lipid peroxidation (Huszar and Vigue 1994), which can be caused by reactive oxygen species (ROS) and ERC-free (normal) spermatozoa can be damaged by ROS generated by abnormal spermatozoa (with ERC).

10.5.3 Reactive Oxygen Species and Lipid Peroxidation

Sperm function can be damaged by inefficient protective systems in semen and sperm cells. Although spermatozoa produce small amounts of reactive oxygen species (ROS), which play a physiological role in promoting sperm function leading to fertilization, excess production by abnormal sperm cytoplasmic remnants or seminal leukocytes can cause oxidative damage (Tremellen 2008). Luminometric assays of ROS can distinguish their production by leukocytes and spermatozoa, from the selective stimulation by specific reagents (WHO

1999a, b). ROS generation by spermatozoa can be measured by chemiluminescence assays in uncontaminated samples (Baker and Aitken 2005) or by fluorescence probes in individual cells (De Iuliis et al. 2006).

Seminal plasma provides a protective environment for spermatozoa by its enzymatic contents including superoxide dismutase, catalase and glutathione peroxidase and non-enzymatic antioxidants such as glutathione, ascorbate, urate, etc. (Saleh and Agarwal 2002), some of which originate in the epididymis (Potts et al. 1999). These can be measured collectively as the total trapping antioxidant potential (TRAP) or total antioxidant capacity (TAC) of seminal plasma (Mahfouz et al. 2008). As damage arises when these protective mechanisms cannot counteract the effects of ROS, a composite ROS-TAC score has been derived for better clinical diagnosis (Sharma et al. 1999).

To assess any resultant deterioration on sperm quality, oxidative damage can also be measured directly. Sperm membrane lipid-peroxidation can be assayed collectively by spectrophotometry (Gomez et al. 1998) or by a fluorescent probe in individual cells (Aitken et al. 2007). Such damage would disrupt processes in the fertilization cascade involving direct interaction with the sperm membrane, besides affecting general motility and survival. Oxidative damage to sperm DNA can also be assessed (see Sect. 10.13), although specific resultant defects in fertilization or embryo development are difficult to pinpoint.

Measurement of the cell types and extent of production of ROS in semen samples, and their anti-oxidant capacity, provide additional information on the potential source of damage to normal spermatozoa.

10.6 Capacitation

The achievement of capacitation is recognized physiologically by the propensity of spermatozoa to respond to physiological stimuli by displaying hyperactivated motility and undergoing the acrosome reaction. Both clinically relevant endpoints can be monitored separately by CASA and specific acrosomal staining, respectively, whereas many sperm molecules involved in these mechanisms have now been identified (Muratori et al. 2008). Tests of capacitation status have been developed to detect these changes. It has been suggested that detecting exposed actin on spermatozoa

may be useful for detecting a capacitated sperm population (Liu et al. 2005).

10.7 Interaction with the Oviductal Epithelium

Before ovulation, uncapacitated spermatozoa in the oviduct bind to its epithelium via their heads. They are released when the products of ovulation stimulate hyperactivated motility (see Chap. 3). Binding to the oviduct can be mimicked *in vitro* with explants of homologous oviductal tissue (Reeve et al. 2003).

This test has not been established for use in the clinic, and as it requires the use of rare human tissue, it is of academic interest only.

10.8 Interaction with the Zona Pellucida

Observations of spermatozoa tightly bound to the zona pellucida of eggs that were not fertilized during therapeutic IVF reveal that most of them have normal morphology (Liu and Baker 1994b), are capacitated (Liu et al. 2006a) and contain normal chromatin (Liu and Baker 2007). These observations indicate that the egg is able to select from a washed sperm preparation a subpopulation of potentially fertilizing spermatozoa (able to undergo the acrosome reaction on the zona and containing non-fragmented DNA) that could be described as normal (or “zona-preferred”: Garrett et al. 1997).

10.8.1 Zona Binding Tests

Two tests of sperm binding to human zonae have been described: the hemi-zona test, in which a single zona is bisected and each zona half is incubated with control and tested sperm suspensions (Burkman et al. 1988) and the sperm-zona binding ratio test, in which a complete zona is incubated with equal numbers of motile spermatozoa from control and test populations, each labelled with a different fluorescent dye (Liu et al. 1988). In each case the number of spermatozoa from each population bound per whole or half zona is

counted and the number of test sperm expressed as a ratio of that of the control.

The disadvantage of the hemi-zona technique is that it requires microdissection equipment and spermatozoa unnaturally bound to the inner zona surface have to be taken into account. The advantage of the complete zona test is that it permits dislodging the bound spermatozoa by passing the zona in and out of a narrow pipette, followed by morphological and biochemical assessment of the eluted spermatozoa, as well as examination of the denuded zona to assess the number of penetrated spermatozoa retained within the zona substance (Liu and Baker 1994b; Liu et al. 2004). It thus provides more information on the sperm population than the hemi-zona test.

The inability of human spermatozoa to bind to the zona pellucida of many mammals (Bedford 1977; Liu et al. 1991; Oehninger et al. 1993) necessitates the use of human zonae in research. As these are available only in limited quantities and not universally accessible, these tests cannot be routine in clinical sperm analysis.

10.8.2 Hyaluronic Acid as Zona Surrogate

Hyaluronic acid (HA) has been considered as a readily-available surrogate for the zona pellucida, since it shares several features with the zona pellucida of selective binding: spermatozoa bind via their heads to droplets of dried HA and are morphologically normal (Cayli et al. 2003), are stained less with aniline blue (i.e., the chromatin is more compacted and the DNA likely to be less fragmented), are more viable and less acrosome-reacted (Huszar et al. 2003) than the original unselected sperm population. Sperm bound to hyaluronic acid exhibit lower rates of disomy and diploidy than unselected spermatozoa (Jakab et al. 2005), as do spermatozoa separated by density gradient centrifugation (Kovanci et al. 2001) and swim-up (Jakab et al. 2003) but even normal-appearing spermatozoa may have abnormal chromatin (Celik-Ozenci et al. 2003).

The benefit of HA-selected individual spermatozoa for therapy over bulk preparations prepared by density gradient centrifugation and swim-up to obtain spermatozoa with euploidy is not established.

10.8.3 Zona Penetration Test

The extent of zona penetration, assessed from the number of spermatozoa still associated with the zona pellucida after physical removal of the tightly bound cells (Liu and Baker 1994b; Liu et al. 2004), is correlated with the extent of the zona pellucida-induced acrosome reaction (ZPIAR: Liu and Baker 1996a), the percentage of acrosome-reacted spermatozoa on the zona and the average number of spermatozoa per zona (Liu and Baker 1996b).

The low availability of human zonae and need for high dexterity in methodology limits the wider application of this test.

10.9 Acrosome Reaction

The acrosome reaction permits the head of the hyperactivated spermatozoon to penetrate the acellular egg investments. As the physiological trigger to the acrosome reaction is the zona pellucida, the most relevant stimulus in a screening test would be the intact zona. Estimating the percentage of acrosome-reacted spermatozoa on the zona has been reported by displacing the bound sperm by passage through a narrow capillary (Liu and Baker 1994b; Liu et al. 2004) and assessing their acrosomal status microscopically. As acrosome-reacted spermatozoa do not bind to the zona (Liu et al. 2006b), the reacted spermatozoa on the zona have undergone the AR as a result of binding. Acid-solubilized zonae have also been used to induce the acrosome reaction in vitro (Franken et al. 2000) but they are less efficient than intact zona (Liu and Baker 1996b), possibly because of differences in the 3D-structure of zona constituents (Green 1997).

The Ca^{2+} ionophore A23187, which mimics the function of ZP by eliciting changes in the second messengers of zona action (intracellular calcium and pH), and the cumulus cell product progesterone (which acts on non-genomic progesterin membrane receptors), are also used as stimuli to the acrosome reaction in vitro. In the “acrosome reaction to ionophore challenge” (ARIC) test (Cummins et al. 1991), the difference in percentage of acrosome-reacted cells in the absence and presence of stimulus is recorded. Tesarik and Mendoza (1993 and Tesarik et al. 1995) described

“acrosome reaction insufficiency” (when <15% of spermatozoa responded to the ionophore A231978 with an acrosome reaction) and “acrosome reaction prematurity” when >20% of his spermatozoa were acrosome-reacted before contact with ionophore.

The ARIC test tests one functional capacity of the spermatozoon, although not necessarily that invoked physiologically by the zona pellucida.

10.9.1 Zona-Induced Acrosome Reactions

There is a direct relationship between the extent of zona-induced acrosome reaction and the extent of zona penetration, however, there is no correlation between the extents of ionophore- and zona pellucida-induced acrosome reactions (Liu and Baker 1996a), and no relationship between ionophore-induced acrosome reactions and zona penetration (Liu and Baker 1996b). Deficiencies in induced acrosome reactions in infertile men have been determined: “disordered acrosome reactions on the zona pellucida” (Liu and Baker 1994a), “defective zona pellucida induced acrosome reaction (DZPIAR)” (Liu and Baker 2000, 2003, 2004), “zona-induced acrosome reaction deficiency” (Franken et al. 2000) and failed acrosome reactions in response to solubilized ZP preparations (Bastiaan et al. 2003): all have been considered predictive of IVF failure.

Knowing that the zona fails to induce an acrosome reaction in spermatozoa is clearly of diagnostic benefit but the limited access to zona material limits the clinical utility of this test.

10.9.2 Recombinant Zona Proteins

Recombinant glycosylated zona pellucida proteins are able to stimulate the human acrosome reaction (Whitmarsh et al. 1996). Although the peptide backbone alone is sufficient stimulus, it requires a long time to act (Chapman et al. 1998) and recently N-glycosylated residues have been shown to be necessary for acrosome reaction induction but not necessarily sperm binding (Chakravarty et al. 2008).

Despite this early promise of a functional alternative to human zonae, there is still no economical, commercially available source of human recombinant ZP3 for use in these tests.

10.10 Sperm–Egg Fusion

10.10.1 The Hamster Oocyte Penetration (HOP) Test/Sperm Penetration Assay (SPA)

After penetrating the zona pellucida, the acrosome-reacted spermatozoon fuses with the vitellus, an aspect of fertilization that can be examined with zona-free eggs. The unvesiculated equatorial region of the acrosome-reacted spermatozoon is the first to fuse with the oolemma of the human egg. As a surrogate, the hamster oocyte can be used to detect the fusinogenic ability of the equatorial region of the acrosome-reacted human spermatozoon (WHO 1999a, b). Swollen, decondensed sperm nuclei, found adjacent to their tails inside the oocyte, provide evidence of sperm penetration. Non-penetrated (still condensed) sperm heads bound to the vitelline membrane indicate the extent to which the acrosome reaction has occurred.

Providing that sufficient motile spermatozoa are present, therapeutic IVF is currently performed as the ultimate sperm function test, and these surrogate oocyte penetration tests are rarely used.

10.10.2 Liposome Markers

An alternative method, employing the same principle, has been developed in which the fusion of fluorescently-labelled, negatively-charged, liposomes of cardiolipin or phosphatidylserine can be observed microscopically (Arts et al. 1993). Fluorescence in both punctuate form, reflecting bound liposomes, and diffuse form, reflecting fused liposomes, was found on the equatorial segment of acrosome reacted spermatozoa. Treatment of acrosome-reacted spermatozoa with proteases or anti-sperm antibodies prevents liposome fusion, whereas similar treatment of acrosome-intact

Fig. 10.1 Sperm function tests and their relation to physiology

Scheme of the steps in the fertilization process (*left column*), the sperm functions involved (*middle column*) and the tests available to check these functions (*right column*). AR, acrosome reaction; CASA, computer-aided sperm analysis; HOP, hamster oocyte penetration; IVF, in vitro fertilization; PN, pronucleus; ZP, zona pellucida. We thank Professor Dr. F Ochsendorf, Centre for Dermatology and Venerology, Johann Wolfgang Goethe University, Frankfurt am Main, for the idea for Fig. 10.1

Step	Function	Test
Penetrate mucus	Progressive motility	CASA (semen)
Cross uterus	(passive)	Survival
Reach oviduct	Progressive motility	CASA (washed)
Bind to epithelium	Binding sites	Oviduct explants
Release from epithelium	Hyperactivated motility	CASA (washed)
Reach oocyte	Chemo-/thermotaxis	Video
Penetrate	Migratory motility	Cumulus columns
Bind to zona	Binding sites	Zona binding tests
Acrosome reaction	Zona response	ZP induced AR
Penetrate zona	Hyperactivated motility	CASA
Bind to vitellus	Binding sites	HOP test
Fuse with vitellus	Fusion proteins	HOP test
Nuclear decondensation	Protamine loss	HOP test
Form male PN	?	IVF
Form zygote	Form spindle	IVF
Form embryo	DNA/mRNA?	IVF, DNA/mRNA

spermatozoa did not prevent fusion after acrosome reactions induction, indicating that the putative fusion protein is not accessible before the AR (Arts et al. 1994).

Whilst such a non-biological probe has advantages over limited biological material, as these liposomes are not commercially available, this remains a research test.

10.11 Sperm Centrosome

The sperm centrosome is crucial for fertilization since it is required for the formation of the microtubule aster necessary to bring the male and female pronuclei together; it is subsequently involved in the formation of the embryonic centrosome (Van Blerkom et al. 1995). Several reports associate defects in syngamy and cleavage with sperm centrosomal abnormalities (Carrell 2008).

The technical demand for a functional test, e.g., injection of the sperm centriole into the oocyte to check for aster formation (Rawe et al. 2008), prevents its clinical implementation.

10.12 Chromosomal Complement

Karyotyping is difficult to perform on spermatozoa, since a metaphase spread is required. As these cells do not divide, this is usually provided after fusion with the zona-free hamster egg. When achieved, data on both chromosomal ploidy, aneuploidy and numerical anomalies are obtained (Moosani et al. 1995).

Far more spermatozoa can be assessed for aneuploidy in less time by fluorescence *in situ* hybridization (FISH) analysis, although the technique provides information only on numerical anomalies. This test usually employs probes against specific chromosomes for assessing particular diseases (Luetjens et al. 2002).

Abnormal spermatozoa that retain excess cytoplasm (ERC) exhibit a greater extent of aneuploidy and diploidy than those without ERC from the same ejaculate whether selected by density gradient centrifugation (Kovanci et al. 2001), swim-up (Jakab et al. 2003) or binding to hyaluronic acid (Jakab et al. 2005). On the other hand, both morphologically normal and abnormal spermatozoa can be disomic or diploid (Celik-Ozenci et al. 2003), or contain damaged DNA (Avendaño et al. 2008), so that selecting normally-looking spermatozoa does not guarantee the absence of a chromosomal abnormality.

Although the chromosome complement of spermatozoa provides additional diagnostic information, it is not possible to select spermatozoa free of chromosomal abnormalities for therapeutic purposes.

10.13 DNA Degradation

Spermatozoa contain mitochondrial as well as nuclear DNA, and damage to either may cause infertility.

10.13.1 Mitochondrial DNA (mtDNA)

mtDNA is compact, double-stranded and circular, and it codes for some electron chain component proteins,

except all those of Complex II (St John et al. 2002). mtDNA deletions are related to male infertility (St John et al. 2000) and there are reports of relationships between these deletions and sperm motility (Carra et al. 2004).

The cause of some cases of low sperm motility may be revealed by examining mutations in mtDNA genes.

10.13.2 Nuclear DNA (nDNA)

Spermatozoa may contain nuclear DNA that has been damaged by various endogenous and exogenous factors (Zini and Libman 2006). However, there is no DNA function test as such, since there is no defined physiological function of sperm DNA that can be tested, other than production of a normal embryo. Nevertheless, there are many laboratory tests for sperm DNA integrity, and around 8% of infertile men have abnormal DNA integrity despite normal semen parameter values (Am Soc Reprod Med 2006). Evidence has accumulated on the predictive power of sperm DNA impairment for negative pregnancy outcomes in natural fertilization and IUI but there is no consistent correlation with fertilization rates in IVF or ICSI (Zini and Libman 2006).

DNA integrity tests may provide indications for counselling infertile couples on the genetic risks associated with choosing IVF or ICSI to increase the chance of pregnancy.

10.14 Assays of Chromatin Compaction

Different assays provide evidence for DNA damage in spermatozoa. Some demonstrate already existing damage to DNA, e.g., nucleoside products indicative of DNA oxidation, whereas others reveal by various methods the presence of DNA strand breaks or specific chromosomes. Other assays only indicate indirectly a potential for such damage by examining the compaction of chromatin from the accessibility of dyes to nucleoproteins or chromatin after challenging spermatozoa with physical insults; this reflects how susceptible the DNA is, or has been, to noxious agents.

10.14.1 Staining Properties of Nucleoproteins

During spermatid development, at least 85% of the spermatid nuclear histone is replaced by protamine via the substitution of intermediate proteins, and infertile men may have an increased sperm histone: protamine ratio compared with fertile men (Zini and Libman 2006). Condensation makes the chromatin more compact and better protected, so the dye has less access to the histones.

Aniline blue binds to the lysine residues of histones that are not fully replaced by protamines during elongated spermatid development, thus high aniline blue staining may reflect the access of the dye to histones in poorly compacted chromatin; this may reflect the susceptibility of the sperm chromatin to damaging agents (Haidl et al. 1994). Highly packaged chromatin can bind little toluidine blue, giving a blue color, but when the chromatin is dissociated, the dye has higher accessibility and at high concentration the dye assumes its metachromatic (polymeric) purple color. Thus the intensity and color of sperm-bound toluidine blue may reflect the chromatin status of the cell (Erenpreiss et al. 2004).

The depth of staining by metachromatic dyes in routine semen smears may provide additional information on the compacted nature of sperm chromatin, and thus potential damage to nDNA.

10.14.2 Staining Properties of Nucleic Acids

Acridine orange (AO), a metachromatic fluorescent dye that intercalates with both double-stranded (ds-, native) and single-stranded (ss-, denatured) nucleic acid, has the property of emitting green or red fluorescence, respectively, in these two states. After being subjected to acid (or heat), spermatozoa are assessed for the intensity of AO staining either subjectively, by fluorescence microscopy (the AO test), by noting the percentage of green (native), red (fragmented) or yellow (partially fragmented) cells, or by flow cytometry (SCSA: sperm chromatin sensitivity assay), where the emission of individual spermatozoa is recorded. In the

latter assay, the ratio of red (R) and green (G) [R/R+G] provides the DNA fragmentation index (DI) reflecting DNA strand breaks (Evenson et al. 2002). The total level of stain taken up (HDS index) may also be informative.

A somewhat more specific probe, chromomycin A3 (CMA3), binds to guanine-cytosine (G-C)-rich areas of DNA. Since the accessibility of CMA3 is inhibited by protamines that compete for CMA3 binding sites (Manicardi et al. 1998), binding of CMA3 is specific to protamine-deficient areas. CMA3 binding thus not only reflects protamine deficiency, but indicates the sites of nicked, partially denatured, DNA (Bianchi et al. 1996).

Detection of these fluorescent dyes may provide additional information on the nature of sperm chromatin and explain some cases of infertility.

10.14.3 Physical Dispersion of DNA

10.14.3.1 Sperm Chromatin Dispersion Assay (SCD)/Sperm Dispersion Assay (SDA)

In sperm chromatin dispersion tests, in addition to acid denaturation, nuclear proteins are removed. The ease with which these are removed reflects the packaging status of the chromatin since only cells with correctly packaged DNA display dispersion of DNA loops, revealing a central core and surrounding “halo” that is detected microscopically.

This relatively easy assay provides the percentage of spermatozoa with poorly packed chromatin but not necessarily DNA damage.

10.14.3.2 Comet Assay

In this assay, single cell electrophoresis is performed on agarose gel-restrained, disrupted spermatozoa whose nuclei display a “comet-like” tail. This comet tail consists of the fragmented, fluorescently labelled, ss- and ds-DNA that migrates away from the core of intact nuclear DNA in an electrophoretic field. The

slides are examined microscopically and quantified as the percentage of cells with comet tails; alternatively the length, width and area can be computed with relevant software. In the “alkaline COMET” assay, the potential for DNA damage is shown by prior alkali treatment to expose any denatured DNA.

These assays reflect the percentage of cells with actual, or potential, DNA damage.

10.15 Assays of DNA Fragmentation

10.15.1 Detection of DNA Fragmentation

10.15.1.1 In Situ Nick Translation Assays

Free ends of denatured DNA, indicative of DNA fragmentation, can be quantified using DNA polymerase I to incorporate dUT into ss-DNA (*in situ* nick translation (ISNT) assays). The TUNEL assay (terminal deoxynucleotidyl transferase-mediated dUTP nick-end labelling, [*in situ* end labelling, ISEL]) also quantifies incorporation of dUT but into both ss- and ds-DNA and fluorescent probes can be evaluated with a microscope or by flow cytometry. Microscopical studies have shown that with this technique, spermatozoa with normally appearing heads can display DNA damage and abnormally-appearing sperm heads may not (Avenidaño et al. 2008).

10.15.1.2 In Situ Hybridization Assays

In DNA breakage detection fluorescence *in situ* hybridisation (DBD-FISH) treatment of spermatozoa within agarose gels with alkali converts DNA strand breaks into ss-DNA. This can serve as target for hybridization probes indicative of the frequency of DNA damage at particular sites in the remaining, nucleus-like structure (nucleoid).

This method permits quantification of DNA fragmentation within individual sperm nuclei.

10.15.2 Biochemical Assays

10.15.2.1 HPLC of DNA Oxidation Products

The detection by HPLC of 7-hydro-8-oxo-2'-deoxyguanosine is a direct measure of oxidation of guanosine (Loft and Poulsen 1999).

10.15.2.2 Alkaline Gel Electrophoresis

Damaged DNA can be observed biochemically by alkaline gel electrophoresis of nuclear DNA, which contains lower molecular weight forms when fragmented (Sawyer et al. 2003).

These assays provide biochemical proof of the presence of DNA damage in a sperm population but not in an individual cell.

10.15.2.3 Q-PCR

Damage can be detected in human sperm nuclear and mitochondrial DNA by quantitative PCR of specific DNA or specific genes (Sawyer et al. 2003). This sensitive technique may hold promise to detect DNA damage in particular target genes but it has not yet been applied to spermatozoa from infertile men.

10.16 DNA Methylation

Studies of DNA methylation and imprinting errors as the basis of diseases have made much progress. As the paternal methylation pattern of offspring is conferred by the fertilizing spermatozoon, sperm DNA methylation analysis offers a useful test of sperm quality (Carrell 2008).

This is still a new field of research and not yet applicable in a clinical setting.

10.17 Clinical Prognostic Value of DNA Status Tests

The results of several of these tests are correlated; for example the extent of aniline blue binding is related to the extent of disomy (Morel et al. 1998); toluidine blue

staining is related to TUNEL and SCSA results (Erenpreiss et al. 2004) and the results of SCSA are correlated with those of TUNEL (Sailer et al. 1995). Thus, regardless of their detecting actual or potential DNA damage, TUNEL, SCSA and SCD all detect the same relative changes in DNA damage in spermatozoa from fertile and infertile men (Chohan et al. 2006). Several of these tests reveal an association with sperm morphology (TUNEL: Said et al. 2005; chromosomal abnormalities: Mateu et al. 2006; CMA3 and aniline blue binding: Franken et al. 1999; Bianchi et al. 1996; the AO test: Liu and Baker 2007).

Some of the above tests have provided information about the probabilities of success of fertility treatment, i.e., in vitro embryo development or pregnancy rates, e.g., TUNEL assay, COMET assay, SCSA although this is dependent on the populations of men studied (Am Soc Reprod Med 2006; Schlegel and Paduch 2005; Zini and Libman 2006). In some cases, it has been argued that the poorer fertilization or pregnancy rates with IUI and IVF dictates that ICSI with its higher fertilization rate be used for these patients with poor DNA qualities to ensure pregnancy (Evenson et al. 2002). However, as even normally-appearing spermatozoa may harbor DNA damage, it is purely chance whether a spermatozoon with defective DNA is injected into the egg.

Correlations between pregnancy outcome and DNA damage obtained from the TUNEL and SCSA tests, employing flow cytometric analysis of high numbers of spermatozoa, are not strong enough to suggest that these assays should be used in the clinical routine work-up (Collins et al. 2008).

10.18 Assays of Sperm RNA

10.18.1 Gene Transcripts

Many sperm mRNA transcripts of important regulatory proteins have been identified within spermatozoa using RT-PCR techniques. These are presumably mainly remnants of RNA found in spermatids, those surviving mitotic and meiotic divisions of germ cells, and those being stored in order to delay translation until the relevant final stages of germ cell development.

Some may be expressed in haploid sperm cells at some chromatin domains with an open conformation where replacement of histone by protamine is incomplete. Global analyses have revealed a large overlap of sperm RNA profiles with those of the testis, including a majority of spermatogenesis-related genes (Ostermeier et al. 2002; Wang et al. 2004).

The role of sperm RNA remains obscure, although recent suggestions (Miller and Ostermeier 2006) include replacing spent proteins, performing a structural role in chromatin packaging, playing roles within the fertilized egg (centriolar support of embryonic development; non-Mendelian inheritance (epigenetic paramutation); gene imprinting; coordination of rapid events that precede pronucleus formation (e.g., deprotamination); pre-zygotic gene transcription from the male pronucleus and post-fertilization demethylation of the sperm genome).

The rich repertoire of both known and unknown protein-encoding and non-encoding RNA species found in ejaculated spermatozoa (Miller et al. 1999) may include micro RNAs (miRNA) which are single-stranded short polynucleotides that can inhibit multi-protein translation from various mRNA species, and small interfering RNAs (siRNA), which are double-stranded oligonucleotides that can inhibit specific gene expression. In the current era of discovery of the components and functions of small regulatory RNA, the suggestion of a possible contribution of sperm RNA in early embryonic development only marks the beginning of research and understanding the role, if any, of sperm RNA in reproduction.

10.18.2 Transcript Translation Products

The recent report on protein translation in capacitating spermatozoa (Gur and Breitbart 2006), if confirmed for more gene products, would also argue for the use of sperm mRNA as well as proteomics as a diagnostic tool for sperm function.

10.19 Sperm Proteomics

Recent advances in laboratory techniques, as well as computational and analytical software, have enabled the generation of sperm proteomic databases and

attempts at resolving the molecular basis of sperm function (Johnston et al. 2005; Aitken and Baker 2007). Differences in sperm proteomic profiles of fertile and infertile men (Pixton et al. 2004) and correlations between sperm DNA integrity and protein expression (de Mateo et al. 2007) illustrate the potentials for the development of multiple protein markers for functional and good quality sperm. Profiles of phosphorylated (Ficarro et al. 2003) and S-nitrosylated proteins (Lefièvre et al. 2007) could further provide probes for defined sperm function such as capacitation.

Future research will provide the evidence of whether ejaculated sperm mRNA or proteomic profiles of fertile men and patients could be used in the non-invasive diagnostic assessment of male fertility.

10.20 Conclusion and Future Approaches

Limitations in most of the sperm function tests mentioned above are that they largely do not mimic the *in vivo* situation of sequential functional changes but merely isolated single events. Where good functional studies have indicated real sperm deficiencies (in zona binding and penetration for example), the wherewithal to perform these tests (zona pellucida, technical skill) is often lacking. The promise of recombinant technology to overcome the supply of zona proteins has not materialized. The novel sperm proteomic approach will bring new but distant prospects in the use of protein markers which may or may not replace physiological testing. The widespread use of artificial reproductive technology with the growing predominance of ICSI in the treatment of male infertility has shifted emphasis away from testing sperm function before entry into the oocyte. Nevertheless, the penetrated sperm cell still needs a functional centrosome and an intact genome with normal epigenetic properties.

Which of the many tests of sperm DNA quality will become dominant may depend on the cost of the necessary equipment; central analysis of frozen samples may be the future. If DNA is of poor quality and underlies the failure of natural fertilization, ICSI is often suggested (Evenson et al. 2002), although with such a high success rate, selecting a spermatozoon free of

DNA damage is impossible and ICSI may become the transmitter of deleterious genes. New techniques in epigenetics have induced novel approaches to study sperm quality. Rich information on sperm RNA will certainly accumulate in the near future on the nature and significance of various sperm transcripts. Sperm RNA profiling in particular, as a non-invasive method of examining certain spermatogenic genes, may permit description and diagnosis. Even then, the establishment of potential biomarkers for fertile spermatozoa would require validation in physiological studies that would be slow in coming, since the many cellular processes of ejaculated sperm to achieve fertilization need to occur in the right sequence with critical temporal and spatial factors.

Overall, despite the plethora of methods providing information on a range of sperm functions, to date there are few data to support their introduction into andrology as an adjunct to routine semen analysis (Collins et al. 2008) and some techniques are too complicated or the requirements for the tests are not met in routine andrology laboratories (Am Soc Reprod Med 2006; Zini and Libman 2006; Lewis 2007).

References

- Aitken RJ, Baker MA (2007) The role of proteomics in understanding sperm cell biology. *Int J Androl* 31:295–302
- Aitken RJ, Wingate JK, De Iulius GN, McLaughlin EA (2007) Analysis of lipid peroxidation in human spermatozoa using BODIPY C11. *Mol Hum Reprod* 13:203–211
- Am Soc Reprod Med (2006) The clinical utility of sperm DNA integrity testing. *Fertil Steril* 86: S35–S37
- Arts EGJM, Kuiken J, Jager S, Hoekstra D (1993) Fusion of artificial membranes with mammalian spermatozoa. Specific involvement of the equatorial segment after acrosome reaction. *Eur J Biochem* 217:1001–1009
- Arts EGJM, Jager S, Hoekstra D (1994) Evidence for the existence of lipid-diffusion barriers in the equatorial segment of human spermatozoa. *Biochem J* 304:211–218
- Avendaño C, Franchi A, Taylor S, Morshedi M, Bocca S, Oehninger S (2008) Fragmentation of DNA in morphologically normal human spermatozoa. *Fertil Steril* [Epub ahead of print]
- Baker MA, Aitken RJ (2005) Reactive oxygen species in spermatozoa: methods for monitoring and significance for the origins of genetic disease and infertility. *Reprod Biol Endocrinol* 3:67
- Bastiaan HS, Windt ML, Menkveld R, Kruger TF, Oehninger S, Franken DR (2003) Relationship between zona pellucida-induced acrosome reaction, sperm morphology, sperm-zona

- pellucida binding, and in vitro fertilization. *Fertil Steril* 79:49–55
- Bedford JM (1977) Sperm/egg interaction: The specificity of human spermatozoa. *Anat Rec* 188:477–487
- Bianchi PG, Maricard GC, Urner F, Campano A, Sakkas D (1996) Chromatin packaging and morphology in ejaculated human spermatozoa: Evidence for hidden anomalies in normal spermatozoa. *Mol Hum Reprod* 2:139–144
- Burkman LJ, Coddington CC, Franken DR, Krugen TF, Rosenwaks Z, Hogen GD (1988). The hemizona assay (HZA): development of a diagnostic test for the binding of human spermatozoa to the human hemizona pellucida to predict fertilization potential. *Fertil Steril* 49:688–697
- Carra E, Sangiorgi D, Gattuccio F, Rinaldi AM (2004) Male infertility and mitochondrial DNA. *Biochem Biophys Res Commun* 322:333–339
- Carrell D (2008) Contributions of spermatozoa to embryogenesis: assays to evaluate their genetics and epigenetics fitness. *Reprod Biol Med Online* 16:474–484
- Cayli S, Jakab A, Ovari L, Delpiano E, Celik-Ozenci C, Sakkas D, Ward D, Huszar G (2003) Biochemical markers of sperm function: male fertility and sperm selection for ICSI. *Reprod Biomed Online* 7:462–468
- Celik-Ozenci C, Catalanotti J, Jakab A, Aksu C, Ward D, Brayward P, Demir R, Huszar G (2003) Human sperm maintain their shape following decondensation and denaturation for fluorescent in situ hybridization: Shape analysis and objective morphometry. *Biol Reprod* 69:1347–1355
- Chakravarty S, Kadunganattil S, Bansal P, Sharma RK, Gupta SK (2008). Relevance of glycosylation of human zona pellucida glycoproteins for their binding to capacitated human spermatozoa and subsequent induction of acrosomal exocytosis. *Mol Reprod Dev* 75:75–88
- Chapman N, Kessopoulou E, Andrews P, Hornby D, Barratt CR (1998). The polypeptide backbone of recombinant human zona pellucida glycoprotein-3 initiates acrosomal exocytosis in human spermatozoa in vitro. *Biochem J* 330:839–845
- Chohan KR, Griffin JT, Lafromboise M, De Jonge CJ, Carrell DT (2006) Comparison of chromatin assays for DNA fragmentation evaluation in human sperm. *J Androl* 27:53–59
- Claassens OE, Wehr JB, Harrison KL (2000) Optimizing sensitivity of the human sperm motility assay for embryo toxicity testing. *Hum Reprod* 15:1586–1591
- Coddington CC, Franken DR, Burkman LJ, Oosthuizen WT, Kruger T, Hodgen GD (1991) Functional aspects of human sperm binding to the zona pellucida using the hemizona assay. *J Androl* 12:1–8
- Collins JA, Barnhart KT, Schlegel PN (2008) Do sperm DNA integrity tests predict pregnancy outcome with in vitro fertilization? *Fertil Steril* 89:823–831
- Cooper TG (2005) Cytoplasmic droplets: the good, the bad or just confusing? *Hum Reprod* 20:9–11
- Cooper TG, Yeung CH, Fetic S, Sobhani A, Nieschlag E (2004) Cytoplasmic droplets are normal structures of human sperm but are not well preserved by routine procedures for assessing sperm morphology. *Hum Reprod* 19:2283–2288
- Cummins JM, Pember SM, Jequier AM, Yovich JL, Hartman PE (1991) A test of the human sperm acrosome reaction following ionophore challenge (ARIC). *J Androl* 12:98–103
- De Iulius GN, Wingate JK, Koppers AJ, McLaughlin EA, Aitken RJ (2006) Definitive evidence for the non-mitochondrial production of superoxide anion by human spermatozoa. *J Clin Endocrinol Metab* 91:1968–1975
- de Mateo S, Martínez-Heredia J, Estanyol JM, Domínguez-Fandos D, Vidal-Taboada JM, Ballescà JL, Oliva R (2007) Marked correlations in protein expression identified by proteomic analysis of human spermatozoa. *Proteomics* 7:4264–4277
- Erenpreiss J, Jepson K, Giwercman A, Tsarev I, Erenpreisa J, Spano M (2004) Toluidine blue cytometry test for sperm DNA conformation: Comparison with the flow cytometric sperm chromatin structure and TUNEL assays. *Hum Reprod* 19:2277–2282
- Evenson DP, Larson KL, Jost LK (2002) Sperm chromatin structure assay: Its clinical use for detecting sperm DNA fragmentation in male infertility and comparisons with other techniques. *J Androl* 23:25–43
- Fetic S, Yeung CH, Sonntag B, Nieschlag E, Cooper TG (2006) Relationship of cytoplasmic droplets to motility, migration in mucus, and volume regulation of human spermatozoa. *J Androl* 27:294–301
- Ficarro S, Chertihin O, Westbrook VA, White F, Jayes F, Kalab P, Marto JA, Shabanowitz J, Herr JC, Hunt DF, Visconti PE (2003) Phosphoproteome analysis of capacitated human sperm. Evidence of tyrosine phosphorylation of a kinase-anchoring protein 3 and valosin-containing protein/p97 during capacitation. *J Biol Chem* 278:11579–11589
- Franken DR, Franken CJ, de la Guerre H, de Villiers A, Franken DR, Franken CJ, de la Guerre H, de Villiers A (1999) Normal sperm morphology and chromatin packaging: Comparison between aniline blue and chromomycin A3 staining. *Andrologia* 31:361–366
- Franken DR, Bastiaan HS, Oehninger SC (2000) Physiological induction of the acrosome reaction in human sperm: Validation of a microassay using minimal volumes of solubilized, homologous zona pellucida. *J Assist Reprod Genet* 17:156–161
- Garrett C, Liu DY, Baker HW (1997) Selectivity of the human sperm-zona pellucida binding process to sperm head morphology. *Fertil Steril* 67:362–371
- Garrett C, Liu DY, Clarke GN, Rushford DD, Baker HW (2003) Automated semen analysis: 'Zona pellucida preferred' sperm morphology and straight-line velocity are related to pregnancy rate in subfertile couples. *Hum Reprod* 18:1643–1649
- Gomez E, Buckingham DW, Brindle J, Lanzafame F, Irving DS, Aitken RJ (1996) Development of an image analysis system to monitor the retention of residual cytoplasm by human spermatozoa: Correlation with biochemical markers of the cytoplasmic space, oxidative stress, and sperm function. *J Androl* 17:276–287
- Gomez E, Irvine DS, Aitken RJ (1998) Evaluation of a spectrophotometric assay for the measurement of malondialdehyde and 4-hydroxyalkenals in human spermatozoa: Relationships with semen quality and sperm function. *Int J Androl* 21:81–94
- Green DP (1997) Three-dimensional structure of the zona pellucida. *Rev Reprod* 2:147–156
- Gur Y, Breitbart H (2006) Mammalian sperm translate nuclear-encoded proteins by mitochondrial-type ribosomes. *Genes Dev* 20:411–416
- Haidl G, Badura B, Schill WB (1994) Function of human epididymal spermatozoa. *J Androl* 15:23S–27ST

- Huszar G, Vigue L (1994) Correlation between the rate of lipid peroxidation and cellular maturity as measured by creatine kinase activity in human spermatozoa. *J Androl* 15:71–77
- Huszar G, Ozenci CC, Cayli S, Zavaczki Z, Hansch E, Vigue L (2003) Hyaluronic acid binding by human sperm indicates cellular maturity, viability, and unreacted acrosomal status. *Fertil Steril* 79(Suppl 3):1616–1624
- Ivic A, Onyeaka H, Girling A, Brewis IA, Ola B, Hammadih N, Papaioannou S, Barratt CL (2002) Critical evaluation of methylcellulose as an alternative medium in sperm migration tests. *Hum Reprod* 17:143–149
- Jakab A, Kovacs T, Zavaczki Z, Borsos A, Bray-Ward P, Ward D, Huszar G (2003) Efficacy of the swim-up method in eliminating sperm with diminished maturity and aneuploidy. *Hum Reprod* 18:1481–1488
- Jakab A, Sakkas D, Delpiano E, Cayli S, Kovanci E, Ward D, Revelli A, Huszar G (2005) Intracytoplasmic sperm injection: a novel selection method for sperm with normal frequency of chromosomal aneuploidies. *Fertil Steril* 84:1665–1673
- Johnston DS, Wooters J, Kopf GS, Qiu Y, Roberts KP (2005) Analysis of the human sperm proteome. *Ann N Y Acad Sci* 1061:190–202
- Kovanci E, Kovacs T, Moretti E, Vigue L, Bray-Ward P, Ward DC, Huszar G (2001) FISH assessment of aneuploidy frequencies in mature and immature human spermatozoa classified by the absence or presence of cytoplasmic retention. *Hum Reprod* 16:1209–1217
- Lefèvre L, Chen Y, Conner SJ, Scott JL, Publicover SJ, Ford WC, Barratt CL (2007) Human spermatozoa contain multiple targets for protein S-nitrosylation: An alternative mechanism of the modulation of sperm function by nitric oxide? *Proteomics* 7:3066–3084
- Lewis SE (2007) Is sperm evaluation useful in predicting human fertility? *Reproduction* 134:31–40
- Liu DY, Baker HW (1994a) Disordered acrosome reaction of spermatozoa bound to the zona pellucida: A newly discovered sperm defect causing infertility with reduced sperm-zona pellucida penetration and reduced fertilization in vitro. *Hum Reprod* 9:1694–1700
- Liu DY, Baker HW (1994b) Acrosome status and morphology of human spermatozoa bound to the zona pellucida and oolemma determined using oocytes that failed to fertilize in vitro. *Hum Reprod* 9:673–679
- Liu DY, Baker HW (1996a) Relationship between the zona pellucida (ZP) and ionophore A23187-induced acrosome reaction and the ability of sperm to penetrate the ZP in men with normal sperm-ZP binding. *Fertil Steril* 66:312–315
- Liu DY, Baker HW (1996b) A simple method for assessment of the human acrosome reaction of spermatozoa bound to the zona pellucida: Lack of relationship with ionophore A23187-induced acrosome reaction. *Hum Reprod* 11:551–557
- Liu DY, Baker HW (2000) Defective sperm-zona pellucida interaction: a major cause of failure of fertilization in clinical in-vitro fertilization. *Hum Reprod* 15:702–708
- Liu DY, Baker HW (2003) Frequency of defective sperm-zona pellucida interaction in severely teratozoospermic infertile men. *Hum Reprod* 18:802–807
- Liu DY, Baker HW (2004) High frequency of defective sperm-zona pellucida interaction in oligozoospermic infertile men. *Hum Reprod* 19:228–233
- Liu DY, Baker HW (2007) Human sperm bound to the zona pellucida have normal nuclear chromatin as assessed by acridine orange fluorescence. *Hum Reprod* 22:1597–1602
- Liu DY, Lopata A, Johnston WI, Baker HW (1988) A human sperm-zona pellucida binding test using oocytes that failed to fertilize in vitro. *Fertil Steril* 50:782–788
- Liu DY, Lopata A, Pantke P, Baker HW (1991) Horse and marmoset monkey sperm bind to the zona pellucida of salt-stored human oocytes. *Fertil Steril* 56:764–767
- Liu DY, Garrett C, Baker HW (2004) Clinical application of sperm-oocyte interaction tests in in vitro fertilization – embryo transfer and intracytoplasmic sperm injection programs. *Fertil Steril* 82:1251–1263
- Liu DY, Clarke GN, Baker HW (2005) Exposure of actin on the surface of the human sperm head during in vitro culture relates to sperm morphology, capacitation and zona binding. *Hum Reprod* 20:999–1005
- Liu DY, Clarke GN, Baker HW (2006a) Tyrosine phosphorylation on capacitated human sperm tail detected by immunofluorescence correlates strongly with sperm-zona pellucida (ZP) binding but not with the ZP-induced acrosome reaction. *Hum Reprod* 21:1002–1008
- Liu DY, Garrett C, Baker HW (2006b) Acrosome-reacted human sperm in insemination medium do not bind to the zona pellucida of human oocytes. *Int J Androl* 29:475–481
- Liu DY, Liu ML, Clarke GN, Baker HW (2007) Hyperactivation of capacitated human sperm correlates with the zona pellucida-induced acrosome reaction of zona pellucida-bound sperm. *Hum Reprod* 22:2632–2638
- Loft S, Poulsen HE (1999) Markers of oxidative damage to DNA: antioxidants and molecular damage. *Methods Enzymol* 300:166–184
- Luetjens CM, Rolf C, Gassner P, Werny JE, Nieschlag E (2002) Sperm aneuploidy rates in younger and older men. *Hum Reprod* 17:1826–1832
- Mahfouz R, Sharma R, Sharma D, Sabanegh E, Agarwal A (2008) Diagnostic value of the total antioxidant capacity (TAC) in human seminal plasma. *Fertil Steril* [Epub ahead of print]
- Manicardi GC, Tombacco A, Bizzaro D, Bianchi U, Bianchi PG, Sakkas D (1998) DNA strand breaks in ejaculated human spermatozoa: Comparison of susceptibility to the nick translation and terminal transferase assays. *Histochem J* 30:33–39
- Marchetti C, Jouy N, Leroy-Martin B, Defossez A, Formstecher P, Marchetti P (2004) Comparison of four fluorochromes for the detection of the inner mitochondrial membrane potential in human spermatozoa and their correlation with sperm motility. *Hum Reprod* 19:2267–2276
- Mateu E, Rodrigo L, Prados N, Gil-Salom M, Remohí J, Pellicer A, Rubio C (2006) High incidence of chromosomal abnormalities in large-headed and multiple-tailed spermatozoa. *J Androl* 27:6–10
- Meseguer M, Garrido N, Martínez-Conejero JA, Simón C, Pellicer A, Remohí J (2004) Relationship between standard semen parameters, calcium, cholesterol contents, and mitochondrial activity in ejaculated spermatozoa from fertile and infertile males. *J Assist Reprod Genet* 21:445–451
- Miller D, Ostermeier GC (2006) Towards a better understanding of RNA carriage by ejaculate spermatozoa. *Hum Reprod Update* 12:757–767

- Miller D, Briggs D, Snowden H, Hamlington J, Rollinson S, Lilford R, Krawetz SA (1999) A complex population of RNAs exists in human ejaculate spermatozoa: Implications for understanding molecular aspects of spermiogenesis. *Gene* 237:385–392
- Moosani N, Pattinson HA, Carter MD, Cox DM, Rademaker AW, Martin RH (1995) Chromosomal analysis of sperm from men with idiopathic infertility using sperm karyotyping and fluorescence in situ hybridization. *Fertil Steril* 64: 811–817
- Morel F, Mercier S, Roux C, Elmrini T, Clavequin MC, Bresson JL (1998) Interindividual variations in the disomy frequencies of human spermatozoa and their correlation with nuclear maturity as evaluated by aniline blue staining. *Fertil Steril* 69:1122–1127
- Muratori M, Luconi M, Marchiani S, Forti G, Baldi E (2008) Molecular markers of human sperm functions. *Int J Androl* [Epub ahead of print]
- Neuwinger J, Cooper TG, Knuth UA, Nieschlag E (1991) Hyaluronic acid as a medium for human sperm migration tests. *Hum Reprod* 6:396–400
- Oehninger S, Mahony MC, Swanson JR, Hodgen GD ((1993) The specificity of human spermatozoa/zona pellucida interaction under hemizona assay conditions. *Mol Reprod Dev* 35:57–61
- Ostermeier GC, Dix DJ, Miller D, Khatri P, Krawetz SA (2002) Spermatozoal RNA profiles of normal fertile men. *Lancet* 360:772–777
- Pixton KL, Deeks ED, Flesch FM, Moseley FL, Björndahl L, Ashton PR, Barratt CL, Brewis IA (2004) Sperm proteome mapping of a patient who experienced failed fertilization at IVF reveals altered expression of at least 20 proteins compared with fertile donors: case report. *Hum Reprod* 19: 1438–1447
- Potts RJ, Jefferies TM, Notarianni LJ (1999) Antioxidant capacity of the epididymis. *Hum Reprod* 14:2513–2516
- Rawe VY, Díaz ES, Abdelmassih R, Wójcik C, Morales P, Sutovsky P, Chemes HE (2008) The role of sperm proteasomes during sperm aster formation and early zygote development: Implications for fertilization failure in humans. *Hum Reprod* 23:573–580
- Reeve L, Ledger WL, Pacey AA (2003) Does the Arg-Gly-Asp (RGD) adhesion sequence play a role in mediating sperm interaction with the human endosalpinx? *Hum Reprod* 18:1461–1468
- Rijsdijk M, Franken D (2007) Use of capillary-cumulus oophorus model for evaluating the selection of spermatozoa. *Fertil Steril* 88:1595–1602
- Said TM, Aziz N, Sharma RK, Lewis-Jones I, Thomas AJ Jr, Agarwal A (2005) Novel association between sperm deformity index and oxidative stress-induced DNA damage in infertile male patients. *Asian J Androl* 7:121–126
- Sailer BL, Jost LK, Evenson DP (1995) Mammalian sperm DNA susceptibility to in situ denaturation associated with the presence of DNA strand breaks as measured by the terminal deoxynucleotidyl transferase assay. *J Androl* 16:80–87
- Saleh RA, Agarwal A (2002) Oxidative stress and male infertility: From research bench to clinical practice. *J Androl* 23: 737–752
- Sawyer DE, Mercer BG, Wiklendt AM, Aitken RJ (2003) Quantitative analysis of gene-specific DNA damage in human spermatozoa. *Mutat Res* 529:21–34
- Schlegel PN, Paduch DA (2005) Yet another test of sperm chromatin structure. *Fertil Steril* 84:854–859
- Sharma RK, Pasqualotto FF, Nelson DR, Thomas AJ, Agarwal A (1999) The reactive oxygen species-total antioxidant capacity score is a new measure of oxidative stress to predict male infertility. *Hum Reprod* 14:2801–2807
- St John JC, Sakkas D, Barratt CL (2000) A role for mitochondrial DNA and sperm survival. *J Androl* 21:189–199
- St John JC, Jokhi RP, Barratt CL (2001) Men with oligoasthenoteratozoospermia harbour higher numbers of multiple mitochondrial DNA deletions in their spermatozoa, but individual deletions are not indicative of overall aetiology. *Mol Hum Reprod* 7:103–111
- Tang S, Garrett C, Baker HW (1999) Comparison of human cervical mucus and artificial sperm penetration media. *Hum Reprod* 14:2812–2817
- Tesarik J, Mendoza, C (1993) Sperm treatment with pentoxifylline improves the fertilizing ability in patients with acrosome reaction insufficiency. *Fertil Steril* 60:141–148
- Tesarik J, Sousa M, Mendoza C (1995) Sperm-induced calcium oscillation of human oocytes show distinct features in oocyte center and periphery. *Mol Reprod Devel* 41:257–263
- Tremellen K (2008) Oxidative stress and male infertility – a clinical perspective. *Hum Reprod Update* 14:243–258
- Van Blerkom J, Davis P, Merriam J, Sinclair J (1995) Nuclear and cytoplasmic dynamics of sperm penetration, pronuclear formation and microtubule organization during fertilization and early preimplantation development in the human. *Hum Reprod Update* 1:429–461
- Wang H, Zhou Z, Xu M, Li J, Xiao J, Xu ZY, Sha J (2004) A spermatogenesis-related gene expression profile in human spermatozoa and its potential clinical applications. *J Mol Med* 82:317–324
- Whitmarsh AJ, Woolnough MJ, Moore HDM, Hornby DP, Barratt CLR (1996) Biological activity of recombinant human ZP3 produced in vitro: Potential for a sperm function test. *Mol Hum Reprod* 2:911–919
- WHO (1999a) WHO laboratory manual for the examination of human semen and sperm-cervical mucus interaction. Cambridge University Press, Cambridge
- WHO (1999b) WHO Laborhandbuch zur Untersuchung des menschlichen Ejakulats und der Spermien-Zervikalschleim-Interaktion Übersetzung von: Nieschlag E, Nieschlag S, Bals-Pratsch M, Behre HM, Knuth UA, Meschede D, Niemeier M, Schick A. 4. Aufl. Springer, Berlin/Heidelberg/New York
- Yeung CH, Cooper TG (2008) Potassium channels involved in human sperm volume regulation-quantitative studies at the protein and mRNA levels. *Mol Reprod Dev* 75:659–668
- Yeung CH, Barfield JP, Cooper TG (2006) Physiological volume regulation by spermatozoa. *Mol Cell Endocrinol* 250:98–105
- Zini A, Libman J (2006) Sperm DNA damage: clinical significance in the era of assisted reproduction. *Can Med Assoc J* 175:495–500

Contents

11.1 Indications for Testicular Biopsy	155
11.2 Surgical Procedures and Tissue Preparation	156
11.2.1 Surgical Techniques.....	156
11.2.2 Multiple Testicular Biopsy	157
11.2.3 Fixation of Testicular Biopsies	158
11.3 Histology	158
11.3.1 Definitions	158
11.3.2 Evaluation.....	159
11.3.3 Score Count Evaluation.....	162
References	165

11.1 Indications for Testicular Biopsy

Indications for testicular biopsy are summarized in [Table 11.1](#). According to the European Association of Urology (EAU) guidelines, a therapeutic testicular biopsy (for testicular sperm extraction, TESE) is indicated (1) in the case of obstructive azoospermia (OA), indicated by normal testicular volume, normal FSH (<7 IU/l), and low levels of epididymal (α -glucosidase, L-carnitine) or seminal vesicle (fructose) markers with no chance for surgical reconstruction (e.g., congenital bilateral aplasia of the vas deferens). Alternatively, microsurgical epididymal sperm aspiration (MESA) can be applied. However, sperm obtained by TESE show better fertilization rates. In the case of microsurgical refertilization (vasovasostomy, vasotubulostomy), after vasectomy a diagnostic biopsy helps to exclude impairment of seminiferous epithelium. In both cases, cryopreservation allows the use of extracted sperm (TESE, MESA) in combination with intracytoplasmic sperm injection (ICSI), if microsurgical refertilization techniques are not applicable or fail.

A therapeutic biopsy is (2) indicated in the case of non-obstructive azoospermia (NOA), either normogonadotropic (FSH <7 IU/l) or hypergonadotropic (FSH \geq 7 IU/l) azoospermia. The latter indicates focal impaired spermatogenesis, associated i.e., with total or focal Sertoli-cell-only syndrome (SCO). In these cases, TESE of remaining focal areas of spermatogenesis within the testis in combination with ICSI/IVF is the only rational therapy (Bergmann et al. 1994; Zitzmann et al. 2006). Testicular tissue is always cryopreserved for later use in ART (EAU Guidelines 2007).

A diagnostic biopsy is (3) indicated to exclude pre-invasive testicular intraepithelial neoplasia (TIN) in

M. Bergmann (✉)
Institute of Veterinary Anatomy, Histology and Embryology,
Justus-Liebig-University, Frankfurter Str. 98,
35392 Gießen/Germany
e-mail: martin.bergmann@vetmed.uni-giessen.de

Table 11.1 Indications and consequences of testicular histology

Indications	Clinical findings	Clinical relevance
Infertility	Hypergonadotropic azoospermia Non-reconstructable obstructive azoospermia	Decision on TESE and ICSI procedures Decision on TESE and ICSI procedures
Sonographic microlithiasis	Obstructive azoospermia Histological evaluation to exclude TIN	Excluding testicular pathology Early prevention of testicular tumor development
Adult cryptorchidism	Histological evaluation of spermatogenesis and exclusion of TIN	Decision on TESE/ICSI procedures and early prevention of testicular tumor development
Presence of testicular germ cell tumor	Histological evaluation to prove or exclude TIN in contralateral testis	Early prevention of secondary testicular tumor development in contralateral testis

the case of inhomogeneous testicular ultrasonography (microlithiasis) (von Eckardstein et al. 2001; de Gouveia Brazao et al. 2004). Biopsy of the contralateral testis is indicated when testicular germ cell cancer is clinically evident, because contralateral TIN is reported to have a prevalence of about 5–6% in testicular cancer patients (Dieckmann et al. 2007). In addition, about 2–4% of men reveal TIN in the case of adult cryptorchidism (Rørth et al. 2000).

Therapeutic biopsy may also be indicated in (4) azoospermic Klinefelter patients, because spermatogenesis, even at a very low rate, might occur, leading to successful TESE and ICSI (Lanfranco et al. 2004; Schiff et al. 2005).

11.2 Surgical Procedures and Tissue Preparation

Preoperative screening includes genital palpation, ultrasonography of the testicles and laboratory analysis with hormone profile. Written informed consent of the patients is a prerequisite of any surgical procedure (open biopsy with or without microsurgical preparations).

When retrieving testicular tissue, sterile conditions are mandatory not only for the surgical procedure itself, but also for transfer of dissected tissue. Moreover, no-touch techniques should be routinely applied to minimize trauma and artefacts of the tissue samples. Usually, testicular tissue is transferred into sterile tubes prepared with medium and cryoprotectant for further processing (cryopreservation and sperm extraction) as well as into tubes with fixatives for further histological analysis. Probe identification is essential including

name, date of birth, site and date of operation. Transfer of tissue can be optimized by temperature control.

11.2.1 Surgical Techniques

Different surgical techniques for obtaining testicular tissue are used. In the very beginning of testicular sperm extraction for ICSI procedures, percutaneous testicular fine needle aspiration (TEFNA) had been recommended for the assessment of spermatogenesis (Craft et al. 1997) as well as for sperm retrieval in non-obstructive azoospermia (Lewin et al. 1999), assuming a less traumatic nature compared to the main approach of open TESE (Silber et al. 1995). However, it was recently shown in a controlled animal model system that TEFNA might also produce progressive and irreversible damage and architectural distortion of seminiferous tubules in the needle's path, especially after repeated punctures leaving only Sertoli cells (SCO) as well as focal chronic inflammation and necrosis. The latter was also shown to occur after TESE in adult male rats, however, with localized scarring and fibrosis, rendering most of the remaining testicle intact (Shufaro et al. 2002) (Fig. 11.1).

In addition, especially in non-obstructive azoospermia, blind puncture of the testicles results in less positive findings of spermatozoa: only 63 out of 452 (14%) patients had positive sperm findings after TEFNA, while in 228 men (50%) with open surgical TESE spermatozoa could be successfully retrieved (Mercan et al. 2000). Friedler et al. (1997) had shown similar results in 37 men with severely impaired spermatogenesis (four positive sperm retrievals after

TEFNA, 16 positive findings after TESE). Finally, fine needle aspiration is not sufficient for histological evaluation.

11.2.2 Multiple Testicular Biopsy

Patients with hypergonadotropic NOA including Klinefelter syndrome generally show Sertoli-cell-only syndrome, but often reveal a focal pattern of seminiferous tubules showing at least qualitatively intact spermatogenesis. Additionally, preinvasive TIN is heterogeneously distributed within the testis (Kliesch et al. 2003; van Casteren et al. 2008). Therefore, most authors recommend multiple testicular sampling in NOA for successful sperm retrieval (Hauser et al. 1998; Amer et al. 2000; Silber 2000; McLachlan et al. 2007) and to increase the safety for detection of TIN (Kliesch et al. 2003; Dieckmann et al. 2007; van Casteren et al. 2008). The association of male infertility and testicular germ cell cancer has been previously shown with an increased incidence of 0.3% (10 of 3,847 men) compared to the normal incidence of about 10:100,000 (0.0001%) males (Raman et al. 2005). By now, infertility is accepted as a risk factor for testicular germ cell cancer (Krege et al. 2008).

Jezek et al. (1998) developed a technique combining cryopreservation, TESE, and histology. It was later improved and published as “EAU Guidelines on Male Infertility 2002” (Weidner et al. 2002; Diemer et al. 2007). This technique includes histological evaluation using a scoring system of three biopsies per testis from different locations considering the testicular vascular-

ization pattern. Two parts of the biopsy are regularly cryo-preserved to recover spermatozoa for ICSI, and to be stored. The third part is fixed and embedded for histological evaluation. Other groups also use multiple biopsy techniques due to focal spread of spermatogenesis and, in addition, to improve the detection rate for TIN (Kliesch et al. 2003). Both techniques lead to comparable results in respect to successful sperm extraction (Fig. 11.1).

For histological evaluation, the biopsy should be about of the size of a grain of rice (5–10 mm length) showing about 25–30 tubular cross sections that have been regarded to be representative for the whole organ (Holstein et al. 1988). Performing multiple biopsies on each side, our own data of score analysis reveal that in the case of OA only 2% of biopsies showed differences of scoring between different specimens in one testicle, in contrast to patients showing NOA, where regional differences within the same testis in respect to spermatogenesis indicating focal impairment occurred in 32%. Concerning the difference between right and left testicle, there may be a difference of more than three points in score counts in up to 7% of patients with obstructive azoospermia and of more than two points in score counts in 13% of men (Pühse et al. 2002).

In recent years, microdissection techniques, either single tubule biopsy or microsurgical biopsies have been evaluated for testicular sperm extraction to increase the rate of successful sperm retrieval in severely impaired spermatogenesis. With microdissection techniques those areas exhibiting tubules are separated and excised, while immature stromal elements can be avoided when harvesting tissue (Schlegel and Li 1998; Amer et al. 2000; Silber 2000; Ramasamy

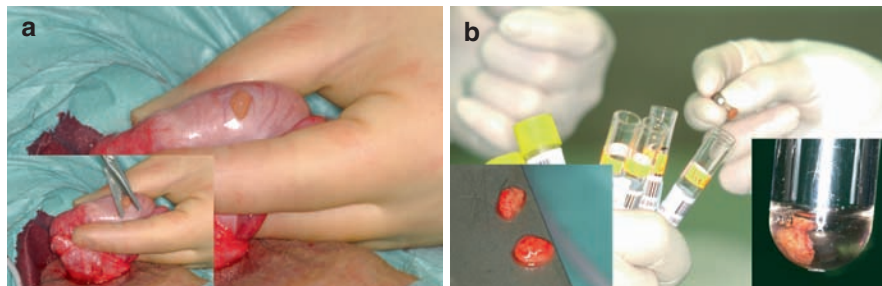

Fig. 11.1 Surgical testicular biopsy for TESE

Fig. 11.1a Scrotal incision of the tunica albuginea after scrotal exploration and excision of small biopsy samples with scissors (Fig. 11.1a, Insert)

Fig 11.1b Transfer of testicular biopsies (Fig. 11.1b, Insert 1) in no-touch-technique into medium. Biopsies must be fully covered by medium for transfer and storage (Fig. 11.1b, Insert 2)

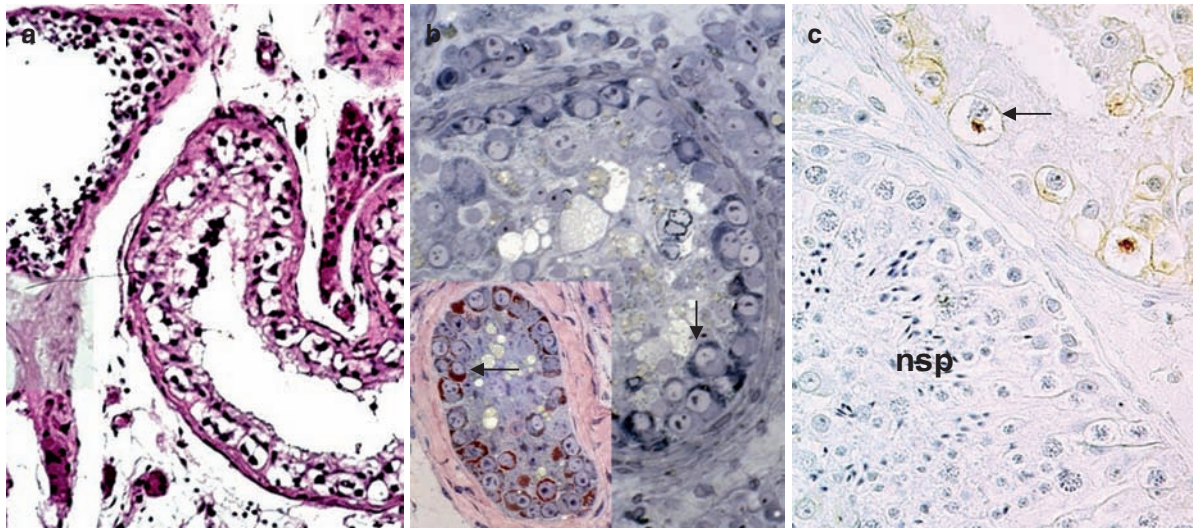

Fig. 11.2 Seminiferous tubules containing TIN. (a) Formalin fixed, paraffin section; hematoxylin eosin staining. Note severe shrinkage artefacts of the tissue (b) Glutaraldehyde fixation, semithin section; methylene blue staining. Note typical large nuclei including numerous nucleoli, and dark cytoplasmic glyco-

gen (arrow) which can be selectively stained by PAS (arrow) (inset). (c) Bouin fixation, paraffin section, immunohistochemical staining against PLAP. Note membrane bound immunoreaction of TIN cells (arrow). nsp: seminiferous epithelium showing intact spermatogenesis. Primary magnification: a, $\times 20$; b, c: $\times 40$

et al. 2005). Recently, the successful use of the measurement of seminiferous tubule diameter for predicting successful sperm retrieval was published (Amer et al. 2008). In seminiferous tubules $\geq 300\mu\text{m}$ in diameter, the sperm retrieval rate was 84% compared to conventional sperm retrieval with 36% in altogether 245 patients. However, none of the groups so far investigated the input on successful sperm retrieval triggered by meticulous searching activities of the biologists and technicians involved!

11.2.3 Fixation of Testicular Biopsies

Formalin fixation of specimens regularly used in pathology cannot be recommended because of severe shrinkage artefacts, making detailed histological evaluation impossible. Fixation in glutaraldehyde and subsequent embedding in epon provides an optimal structural preservation for semithin and ultrathin electron microscopy; the latter permits clear identification of atypical germ cells because of the nuclear structure and large amounts of intracytoplasmic glycogen granules such as TIN cells (see Holstein et al. 1988), but this material does not allow modern histological techniques such as

immunohistochemistry or in situ hybridization that give evidence of gene expression on the protein and mRNA level. Therefore fixation in Bouin's or Stieve's solution and embedding in paraffin wax is recommended (Bergmann 2006) (Fig. 11.2). Structural preservation of Bouin or Stieve-fixed testicular tissue allows precise identification of all cellular components.

11.3 Histology

11.3.1 Definitions

A prerequisite for profound histological analysis is understanding the process of normal spermatogenesis and the relevant terms in order to prepare or to interpret an evaluation report correctly.

The term "spermatogenesis" describes the development of the male gamete within the seminiferous epithelium from diploid spermatogonia, having contact with the basal lamina, up to the release of differentiated haploid germ cells into the lumen of the seminiferous tubule. It includes the proliferation and differentiation of spermatogonia, the meiotic divisions of primary and

secondary spermatocytes, and the transformation of the haploid early round spermatids into spermatozoa. The latter process is termed “spermiogenesis.”

The release of elongated (mature) spermatozoa into the lumen of the seminiferous tubule is termed “spermiation.” The haploid cell within the seminiferous epithelium is called “spermatid,” whereas the term “spermatozoon” describes the haploid male gamete after spermiation. The process of normal spermatogenesis, including the stages of spermatogenesis of different species except for the human stages is described in detail in Chap. 2.

11.3.2 Evaluation

It is necessary to evaluate the histological appearance of (1) every single seminiferous tubule in a given section, i.e., the occurrence of spermatogonia, spermatocytes, round and elongated spermatids, and Sertoli cells, (2) the appearance of the lamina propria, and (3) the composition of the interstitial tissue.

Within a seminiferous tubule it is important to note whether all germ cell components of the seminiferous epithelium represent one of the **six stages of spermatogenesis defined by Clermont (1963)**. These stages of spermatogenesis are defined as a characteristic association of germ cells representing several waves of spermatogenesis that occur simultaneously within the seminiferous epithelium (Fig. 11.3):

Stage I is defined by the occurrence of early round spermatids showing an acrosome vesicle after the second meiotic division. It is composed of spermatogonia Type A and Type B, pachytene primary spermatocytes, round (step 1) and elongating (step 7) spermatids (Fig. 11.3a).

Stage II consists of spermatogonia Type A and Type B, pachytene primary spermatocytes, round (step 8) and elongating (step 2) spermatids (Fig. 11.3b).

Stage III consists of spermatogonia Type A and Type B, pachytene primary spermatocytes, round (step 3) and elongating (step 1) spermatids (Fig. 11.3c).

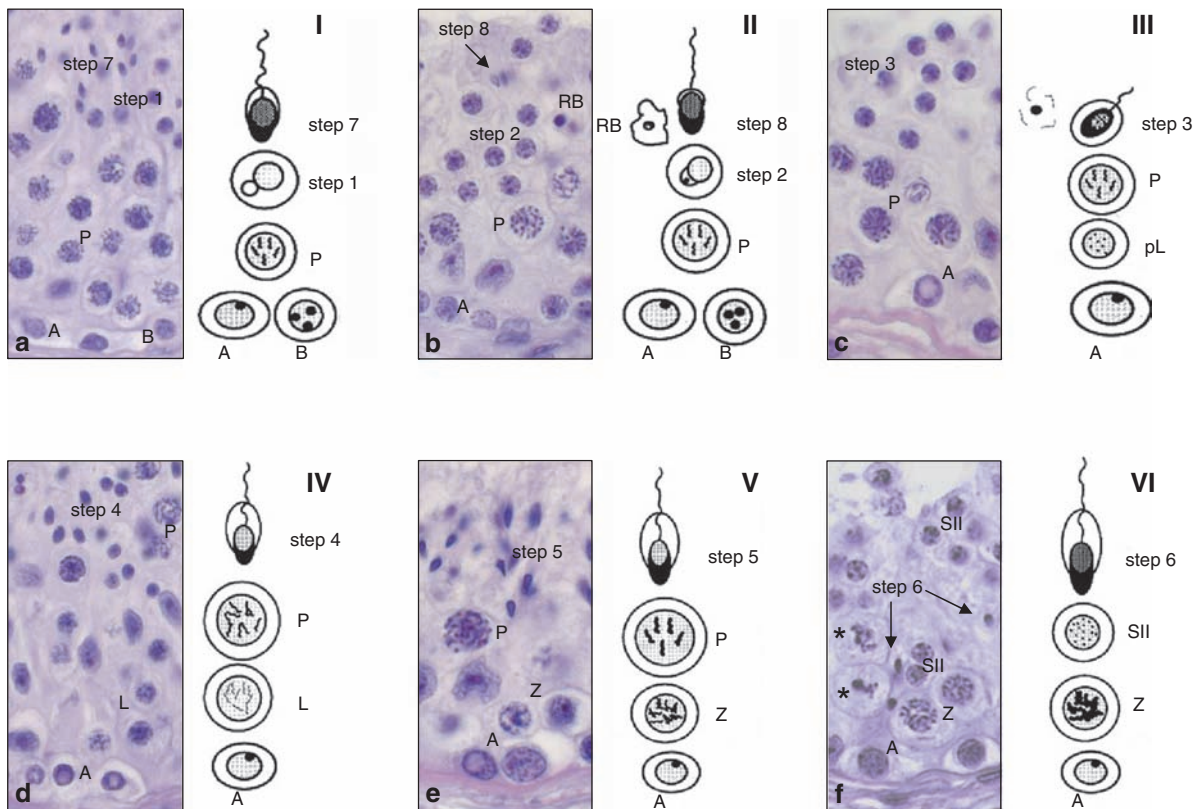

Fig. 11.3 Normal spermatogenesis. (a) Stage I, (b) Stage II, (c) Stage III, (d) Stage IV, (e) Stage V, (f) Stage VI. A, B: spermatogonia type A, type B; P: pachytene primary spermatocytes, L: leptotene primary spermatocytes, Z: zygotene primary

spermatocytes; SII: secondary spermatocytes; step1–8: different steps of spermiogenesis; RB: residual body; *cells in first meiotic division; for details see text. Bouin fixation, paraffin embedded section, hematoxylin eosin staining, primary magnification $\times 40$

(step 2) and elongated (step 8) spermatids and shows residual bodies derived from spermatid cytoplasm within Sertoli cells. After stage II, spermiation takes place (Fig. 11.3b).

Stage III is characterized by the beginning of spermatid nuclear condensation (step 3) and the entrance of Type B spermatogonia into meiosis (preleptotene) (Fig. 11.3c).

Stages IV and V exhibit ongoing condensation of spermatid nuclei (step 4 and step 5), pachytene primary spermatocytes, and can be differentiated by the presence of leptotene (stage IV) and zygotene (stage V) primary spermatocytes (Fig. 11.3d, e). After stage V, pachytene primary spermatocytes undergo diakinesis and the first meiotic division takes place.

Stage VI is characterized by the presence of secondary spermatocytes (Fig. 11.3f). Secondary spermatocytes undergo the second meiotic division after a very short interphase of about 6h, thus stage VI is extremely rare to be found. The human seminiferous epithelium generally shows a multistage arrangement.

If a stage arrangement of the seminiferous epithelium is evident in most of the tubules, then the histology can be classified as “normal spermatogenesis” concerning qualitative and quantitative aspects.

The **cytological descriptive analysis** considers the following aspects:

- If the number of elongated spermatids is reduced or the cellular composition of the seminiferous epithelium is incomplete (Johnson et al. 1992), the term **“hypospermatogenesis”** should be applied (Fig. 11.4a).
- If spermatogenesis ceases at a specific stage such as early round spermatids, primary spermatocytes or spermatogonia in every tubule, the term **“maturation arrest at the level of ...”** applies.
- The term **“Sertoli-cell-only (SCO) syndrome”** describes the fact that the seminiferous epithelium does not show any germ cells, but only Sertoli cells (Fig. 11.4c, 11.5a). This may occur as a total or a focal SCO syndrome.

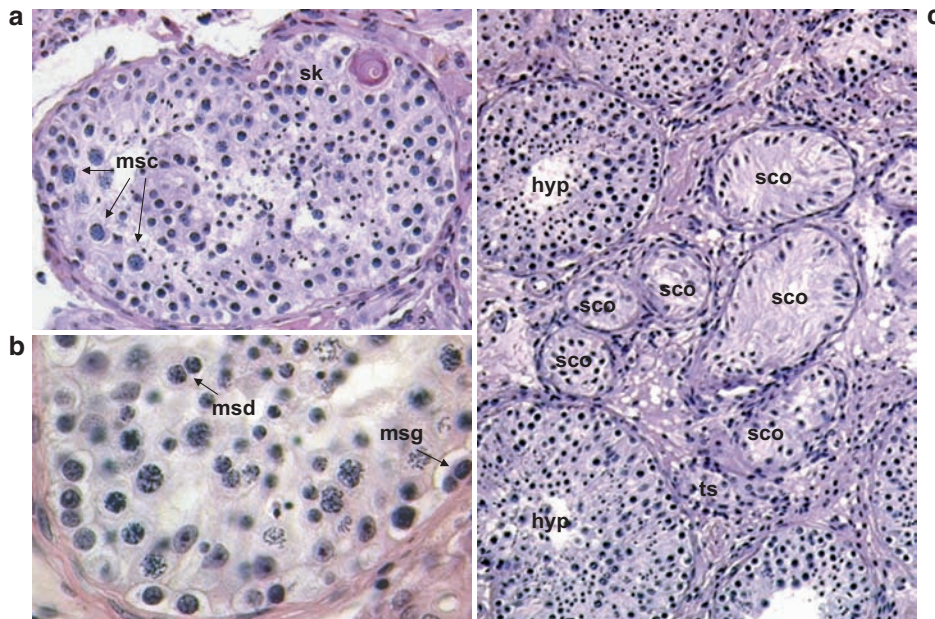

Fig. 11.4 Hypospermatogenesis. (a) Seminiferous epithelium showing only qualitatively intact spermatogenesis, megalospermatocytes (msc), and concentric spherical concretions (sc) deriving from basal lamina. Bouin fixed, paraffin embedded section, hematoxylin eosin staining, primary magnification $\times 20$. (b) Seminiferous epithelium showing only qualitatively intact spermatogenesis, multinuclear spermatogonia (msg) and multi-

nuclear spermatids (msd). Bouin fixed, paraffin embedded section, hematoxylin eosin staining, primary magnification $\times 40$. (c) Mixed atrophy of spermatogenesis showing seminiferous epithelium with hypoplasia (hyp), showing only Sertoli cells (SCO) or total atrophy leaving only thickened lamina propria (tubular shadows: ts). Bouin fixation, paraffin embedded section, hematoxylin eosin staining, primary magnification $\times 10$

- If both germ cells and Sertoli cells are absent, the lamina propria is thickened due to the increase of light microscopically amorphous material, then the term “**tubular hyalinization**” or “**tubular shadows**” should be used (Fig. 11.4c, 11.5a).
- Additionally, nuclear abnormalities such as multinuclear spermatids indicating defects in spermiogenesis (Holstein et al. 1988) and spermatogonia (Fig. 11.4b) or meiotic defects such as “**megalospermatocytes**” (Holstein and Eckmann 1986; Johannisson et al.

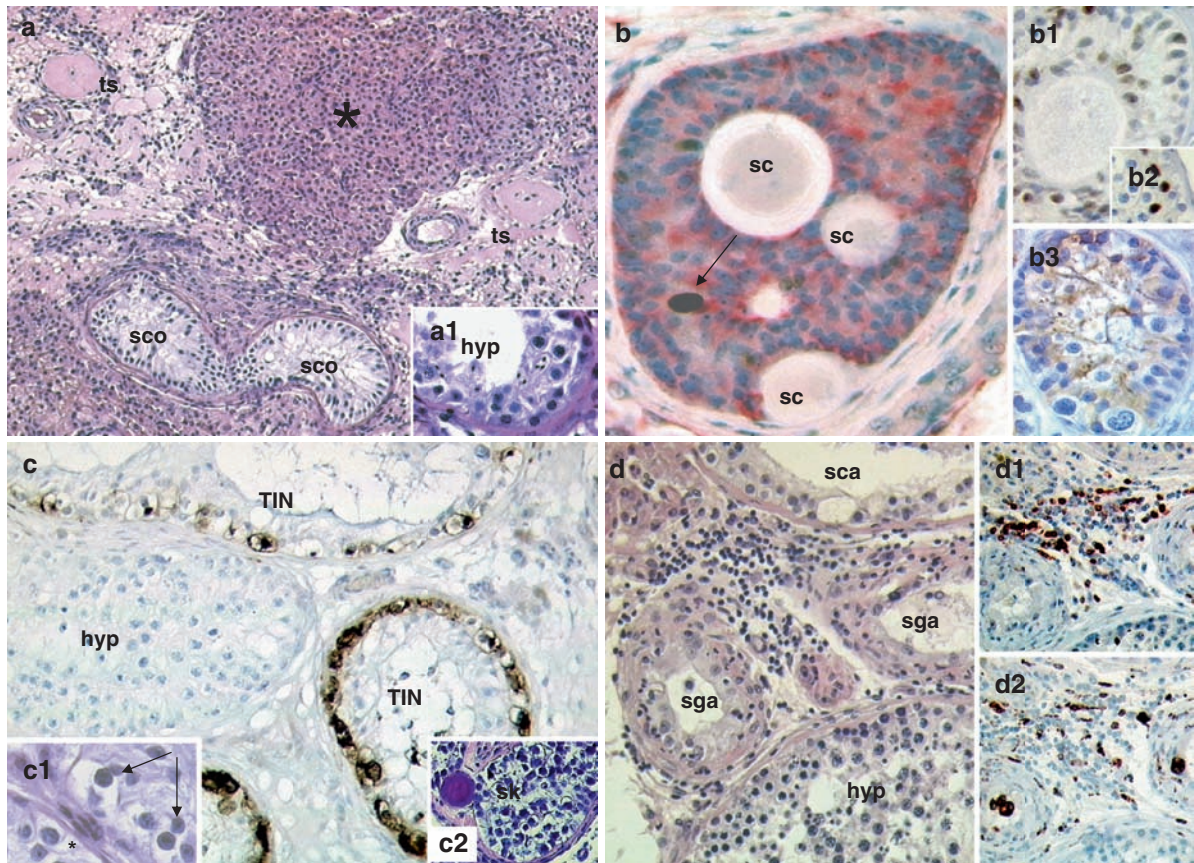

Fig. 11.5a Typical testicular histology of a Klinefelter patient showing Sertoli-cell-only (SCO), tubular shadows (ts) and nodular Leydig cell hyperplasia (*). Bouin fixed, paraffin embedded section, hematoxylin eosin staining, primary magnification $\times 10$. (b) Prepubertal seminiferous cords within an adult testis showing undifferentiated Sertoli cells indicated by round to oval nuclei (b, b1, b3) compared to nuclei of fully differentiated Sertoli cells (b2); note Ki-67 immunoreactivity (arrow) indicating proliferative activity, weak nuclear androgen receptor expression (b1) compared to fully differentiated Sertoli cells (b2), and persistence of anti-müllerian hormone expression (b3); sc: spherical concretions. Bouin fixed, paraffin embedded section; b: double immunostaining against vimentin (red) labelling Sertoli cells and Ki-67 (brown) labelling nuclei in mitotic s-phase; b1, b2: immunostaining against androgen receptor; b3: immunostaining against anti-müllerian hormone; hematoxylin, primary magnification $\times 20$ (b), $\times 40$ (b1–b3). (c) Seminiferous tubules showing PLAP positive

atypical germ cells (TIN) and hypospermatogenesis (hyp). c1: note typical clear cytoplasm and irregular outlined nuclei with numerous nucleoli of atypical germ cells (arrow) compared to normal spermatogonia (*) in routine sections stained with hematoxylin and eosin. c2: association of tubules containing TIN with a thickened lamina propria and spherical concretions (sk) Bouin fixation, paraffin embedded section; c: immunostaining against PLAP; c1, c2: hematoxylin, primary magnification $\times 20$ (c, c2), $\times 40$ (c1). (d) Focal interstitial inflammation associated with seminiferous tubules showing hypospermatogenesis (hyp) or arrest of spermatogenesis at the level of spermatogonia (sga) or primary spermatocytes (sca). Note interstitial location of T-lymphocytes (d1) and intratubular penetration of macrophages (d2). Bouin fixation, paraffin embedded section; d: hematoxylin, eosin; d1, d2: immunostaining against CD4 labelling T-lymphocytes (d1) and CD 68 labelling macrophages (d2); hematoxylin; consecutive sections, primary magnification, $\times 20$

2003), that can easily be recognized on paraffin sections, should be noticed (Fig. 11.4a).

- If **Sertoli cell nuclei** show a round to ovoid instead of irregular outline with deep indentations, they should be characterized as immature. The immature prepubertal nature of these Sertoli cells has been shown by the expression of anti-mullerian hormone and ongoing of – even low – proliferative activity (Sharpe et al. 2003; Brehm et al. 2006) (Fig. 11.5b).
- Finally, **intratubular concentric microliths** deriving from invagination of the basal lamina (Schulze and Schütte 1990) may occur (Fig. 11.4a, 11.5b). Occurrence of microliths, tubular shadows as well as a focal interstitial fibrosis are found to be the histological basis of ultrasonographically diagnosed “microlithiasis” (Vegni-Telluri et al. 1980; von Eckardstein et al. 2001; Kemper et al. 2006).
- **TIN cells** are known to be the precursors of seminomatous and non-seminomatous germ cell tumors with the exception of spermatocytic seminoma (Dieckmann and Loy 1996; Dieckmann et al. 2007). On paraffin sections they can be recognized by their large size compared to normal spermatogonia, clear cytoplasm and large irregularly outlined nuclei with numerous nucleoli (Fig 11.5c1). However, the nature of these atypical spermatogonia has to be proven by the immunohistochemical staining of the membrane-bound placenta-like alkaline phosphatase (PIAP) (Beckstead 1983) (Fig. 11.2c, 11.5c), or other markers such as the nuclear AP-2 γ (for review see McLachlan et al. 2007). If present, possible extratubular localization within the interstitial tissue should be noted, indicating an early invasive state of seminoma.
- Within the intertubular tissue the presence and feature of **Leydig cells** is important. Leydig cells may show a diffuse hyperplasia or focal nodular accumulation (Fig. 11.5a).
- In routine sections, stained with hematoxylin and eosin, the infiltration and focal accumulation of **lymphocytes** may occur in the vicinity of blood vessels, together with tubules showing an arrest of spermatogenesis at the level of spermatogonia (Fig. 11.5d), and most regularly associated with TIN. The evaluation of different types of lymphocytes by immunohistochemistry reveals that most are CD4⁺ and CD8⁺/T-lymphocytes (Fig. 11.5d1), and macrophages can be recognized as non-resident CD68⁺ macrophages (Fig. 11.5d2) (Schuppe et al.

2008). The number of mast cells is regularly increased in infertile patients, especially in cases of SCO (Meineke et al. 2000; Roaiah et al. 2007).

11.3.3 Score Count Evaluation

The occurrence of different forms of morphologically impaired spermatogenesis in the same testis is called “mixed atrophy” (Sigg 1979): the simultaneous occurrence of seminiferous tubules showing at least qualitatively intact spermatogenesis, spermatogenic arrest on different levels of spermatogenesis including SCO tubules or even only lamina propria (tubular shadows) in adjacent tubules within the same testis (Fig. 11.4c). Considering the fact that most biopsies (53% [313 of 586 biopsies performed]) are indicated because of NOA, a semi-quantitative “score count” evaluation focussing on the proportion of tubules containing elongated spermatids is appropriate when counselling infertile patients and deciding whether TESE can be used for potentially successful ICSI or not.

Johnsen (1970) proposed a scoring system for describing spermatogenesis qualitatively. It was later modified by De Kretser and Holstein (1976) and provides a scoring of every tubule within a given histological section. This score is highly recommended in the case of oligozoospermic patients, because a high correlation between testicular biopsy score and sperm count is found. However, oligozoospermia is no longer an indication for testicular biopsy. For NOA, this score may result in a mean tubule score not indicating the absence or presence of elongated spermatids. To illustrate the problem: a mean score of three or four may result from a biopsy containing elongated spermatids or no elongated spermatids (Fig. 11.6).

In contrast, the score according to Bergmann and Kliesch (1998) (Fig. 11.6) is based on the **percentage of tubules showing elongated spermatids**: every tubule present in the histological section is analyzed according to the data sheet (Fig. 11.7). At the end, the total number of tubules is summarized and the percentage of tubules with elongated spermatids given as the final score indicates the presence or absence of elongated spermatids (i.e., score 10 means 100% of tubules contain elongated spermatids, score 1 means 10% of tubules contain elongated spermatids). If less than 10% (9%–1%) of tubules contain elongated spermatids, an

Fig. 11.6 Score evaluation according to Johnsen (1970) and Bergmann and Kliesch (1998)

	Patient x			Patient y		
	number of tubules	score Johnsen	□	number of tubules	score Johnsen	□
many elongated spermatids	5	x 10 =	50	-	-	-
few elongated spermatids	5	x 8 =	40	-	-	-
round spermatids	-	-	-	-	-	-
primary spermatocytes	-	-	-	20	x 5 =	100
spermatogonia	-	-	-	30	x 3 =	90
SCO	20	x 2 =	40	20	x 2 =	40
tubular shadows	10	x 1 =	10	-	-	-
Total	40		140	70		230
	Johnsen			Johnsen		
	$\frac{\text{total of scores } 140}{\text{total of tubules } 40} = \text{score } 3.5$			$\frac{230}{70} = \text{score } 3.0$		
	Bergmann and Kliesch			Bergmann and Kliesch		
	$\frac{\text{number of tubules containing elongated spermatids } 10}{\text{total of tubules } 40}$			$\frac{0}{70}$		
	10 tubules containing elongated spermatids represent 25% of all tubules = score 2.5			0 tubules containing elongated spermatids represent 0% of all tubules = score 0		

extended subclassification of score (0.9–0.1) may be reasonable in the case of planned TESE/ICSI therapy (Table 11.2).

Histological evaluation additionally includes the consideration of cytological alterations i.e., meiotic defects resulting in so-called “megalospermatocytes” or multinucleated spermatids representing defects in spermiogenesis (Fig. 11.4a, b). Bouin-fixed and paraffin specimens provide the opportunity for functional gene and protein expression studies. Studies using antibodies against the s-phase protein Ki-67 or PCNA revealed that spermatogonial mitotic activity is reduced together with spermatogenic impairment (Steger et al. 1998), and apoptosis of germ cells and Sertoli cells is increased in testes showing maturation arrest and SCO (Kim et al. 2007) or in testes after vasectomy (O’Neill et al. 2007). Immunofluorescence revealed that primary meiotic defects due to defects in chromosome synapsis in pachytene primary spermatocytes leads to spermatogenic arrest and can be responsible for NO infertilities (Guichaoua et al. 2005; Sun et al. 2007). In biopsies showing hypospermatogenesis, in situ hybridization revealed a reduced number of spermatids showing protamine gene expression which was later confirmed by quantitative PCR analysis. Data of protamine expression turned out to be of special importance for the

success of ICSI using testicular spermatozoa (Mitchell et al. 2005; Steger et al. 2001, 2003).

Alterations of somatic Sertoli cells are regularly found as signs of differentiation deficiency. This can be suggested on routine paraffin sections by round to oval nuclei of Sertoli cells within immature seminiferous cords compared to normal irregular shape with large and numerous clefts of Sertoli cells within normal seminiferous epithelium (Fig. 11.5), and was first reported by Bruning et al. (1993) using computer-assisted three-dimensional reconstruction. Sertoli cell differentiation deficiency shown by different markers is now widely accepted to be associated with spermatogenic impairment as well as with TIN (Kliesch et al. 1998), and was recently reviewed by Sharpe et al. (2003). Sertoli cells are the only cells within the seminiferous epithelium expressing androgen (Fig. 11.5b) as well as FSH receptors. In cryptorchidism, this androgen receptor expression is significantly reduced when using quantitative immunohistochemistry (Regadera et al. 2001). This is also true for Sertoli cells within premature seminiferous cords found in infertile men (Fig. 11.5b), which additionally show a persistence of anti-Mullerian hormone expression (Fig. 11.5b) (Steger et al. 1996).

Klinefelter patients exhibit a hypergonadotropic NOA associated with SCO or total atrophy (tubular

Evaluation of testicular biopsy

Name, prename: *NU*Date of birth: *XX*Date of biopsy: *XX*Clinic: *XX*Clinical diagnosis: *hypergonadotropic azoospermia*

Criteria	biopsy right			biopsy left		
	number of tubules			number of tubules		
Semiquantitative	1	2	3	1	2	3
spermatogenesis up to						
- elongating spermatids				<i>11</i>		<i>11</i>
- round spermatids						<i>6</i>
- primary spermatocytes						<i>13</i>
- spermatogonia						
Sertoli-cell-only	<i>42</i>	<i>23</i>	<i>10</i>	<i>18</i>	<i>37</i>	<i>35</i>
tubular shadows		<i>20</i>				
total			<i>95</i>			<i>132</i>
score	<i>0</i>	<i>0</i>	<i>0</i>	<i>4</i>	<i>0</i>	<i>2</i>
Morphological evaluation						
tubules containing						
- multinuclear spermatids				<i>8</i>		<i>6</i>
- multinuclear spermatocytes						
- multinuclear spermatogonia						
- megalospermatocytes						
- megalospermatogonia						
- degenerating germ cells						
tubular diverticle						
thickening of lamina propria	<i>partly</i>					
morphology of Sertoli cells						
morphology of Leydig cells						
interstitium						
peculiar features						
Diagnosis	<i>-SCO - focal total atrophy</i>			<i>-SCO - focal spermatogenesis</i>		

Fig. 11.7 Biopsy evaluation of a hypergonadotropic azoospermic patient showing total SCO in the right testis and SCO together with focal areas of qualitatively intact spermatogenesis

with impairment of spermiogenesis resulting in different scores in the left testis

Table 11.2 Score according to Bergmann and Kliesch (1998)

Percentage of tubules with elongated spermatids (%)	Score	Classification
100–95	10	Normal spermatogenesis
94–85	9	
84–75	8	
74–65	7	
64–55	6	Mixed testicular atrophy
54–45	5	
44–35	4	
34–25	3	
24–15	2	
14–10	1	
9–1	0.9–0.1	Predominantly atrophy of seminiferous epithelium and occurrence of single elongated spermatids
0	0	Sertoli-cell-only, spermatogenic arrest, testicular atrophy, tubular shadows

shadows) and diffuse or nodular Leydig cell hyperplasia. However, up to 20% of these patients reveal focal spermatogenesis (Fig. 11.5a) allowing TESE/ICSI therapy. Schiff et al. (2005) could show that 21 children born after TESE and ICSI had a normal karyotype. There is increasing evidence that Klinefelter patients show germ cell degeneration and altered androgen receptor expression together with puberty (Wikström et al. 2007). This could explain the clinical observation of decreasing spermatogenesis (Ichioka et al. 2006) and age as limiting factor of successful sperm extraction in “non-mosaic” Klinefelter patients (Okada et al. 2005).

Taken together, a semiquantitative score count evaluation together with cytological analysis provides the opportunity for causal histological evaluation. With this information, critical counselling of infertile patients concerning successful TESE and ICSI procedures becomes possible. In addition, more detailed analysis of testicular sperm might be of increasing importance in order to improve successful assisted reproduction and to improve our understanding of the underlying causes of spermatogenic impairment.

Testicular biopsy is an invasive surgical operation with high impact for patients with severe spermatogenic

impairment, and should therefore be performed only after strict consideration of indications, surgical procedures and histological evaluation in qualified centers.

References

- Amer M, Ateyah A, Hany R, Zohdy W (2000) Prospective comparative study between microsurgical and conventional testicular sperm extraction in non-obstructive azoospermia: Follow-up by serial ultrasound examinations. *Hum Reprod* 15:653–656
- Amer M, Zohdy W, El Naser TA, Hosny H, Arafa M, Fakhry E (2008) Single tubule biopsy: A new objective microsurgical advancement for testicular sperm retrieval in patients with nonobstructive azoospermia. *Fertil Steril* 89:592–596
- Beckstead JH (1983) Alkaline phosphatase histochemistry in human germ cell neoplasms. *Am J Surg Pathol* 7:341–349
- Bergmann M (2006) Evaluation of testicular biopsy samples from clinical perspective. In: Schill WD, Comhaire FH, Hargreave T (eds) *Andrology for the clinician*. Springer-Verlag, Berlin, pp 454–461
- Bergmann M, Kliesch S (1998) Hodenbiopsie In: Krause W, Weidner W (eds) *Andrologie*. Enke Verlag, Stuttgart, pp 66–71
- Bergmann M, Behre HM, Nieschlag E (1994) Serum FSH and testicular morphology in male infertility. *Clin Endocrinol* 40:133–136
- Brehm R, Rey R, Kliesch S, Steger K, Marks A, Bergmann M (2006) Mitotic activity of Sertoli cells in adult human testis. An immunohistochemical study to characterize Sertoli cells in testicular cords from patients showing testicular dysgenesis syndrome. *Anat Embryol* 211:223–236
- Bruning G, Dierichs R, Stümpel C, Bergmann M (1993) Sertoli cell nuclear changes in human testicular biopsies as revealed by three dimensional reconstruction. *Andrologia* 25:311–316
- Clermont Y (1963) The cycle of the seminiferous epithelium in man. *Am J Anat* 112:35–51
- Craft I, Tsigiotis M, Courtald E, Farrer-Brown G (1997) Testicular needle aspiration as an alternative to biopsy for the assessment of spermatogenesis. *Hum Reprod* 10:1483–1487
- De Gouveia Brazao CA, Pierik FH, Oosterhuis JW, Dohle GR, Looijenga LH, Weber RF (2004) Bilateral testicular microlithiasis predicts the presence of the precursor of testicular germ cell tumors in subfertile men. *J Urol* 171:158–160
- De Kretser DM, Holstein AF (1976) Testicular biopsy and abnormal germ cells. In: Hafez ESE (ed) *The human semen and fertility regulation in men*. Mosby, St. Louis, MO, pp 332–343
- Dieckmann KP, Loy V (1996) Prevalence of contralateral testicular intraepithelial neoplasia in patients with testicular germ cell neoplasms. *J Clin Oncol* 14:3126–3132
- Dieckmann KP, Kulejewski M, Pichlmeier U, Loy V (2007) Diagnosis of contralateral testicular intraepithelial neoplasia (TIN) in patients with testicular germ cell cancer: Systematic two-site biopsies are more sensitive than a single random biopsy. *Eur Urol* 51:175–183

- Diemer T, Schroeder-Printzen I, Weidner W (2007) Operative Spermengewinnung. *Urologe* 46:789–799
- Dohle GR, Jungwirth A, Colpi G, Giwercman A, Diemer T, Hargreave TB (2007). EAU Guidelines on Male Infertility. European Association of Urology, Arnhem, The Netherlands.
- Friedler S, Raziel A, Strassburger D, Soffer Y, Komarovsky D, Ron-El R (1997) Testicular sperm retrieval by percutaneous fine needle sperm aspiration compared with testicular sperm extraction by open biopsy in men with non-obstructive azoospermia. *Hum Reprod* 12:1488–1493
- Guichaoua MR, Perrin J, Metzler-Guillemain C, Saisas-Manan J, Giorgi R, Grillo JM (2005) Meiotic abnormalities in infertile men with severe spermatogenic defects. *Hum Reprod* 20:1897–1902
- Hauser R, Botchan A, Amit A, Ben Yosef D, Gamzu R, Paz G, Lessing JB, Yogev L, Yavetz H (1998) Multiple testicular sampling in non-obstructive azoospermia – is it necessary? *Hum Reprod* 13:3081–3085
- Holstein AF, Eckmann C (1986) Megalospermatocytes: indicators of disturbed meiosis in man. *Andrologia* 18:601–609
- Holstein AF, Schirren C, Roosen-Runge EC (1988) Illustrated pathology of human spermatogenesis. Grosse Verlag, Berlin
- Ichioka K, Utsunomiya N, Kohei N, Ueda N, Inoune K, Terai A (2006) Adult onset of declining spermatogenesis in a man with nonmosaic Klinefelter's syndrome. *Fertil Steril* 85: 1511.e1–1511.e.2
- Jezek D, Knuth UA, Schulze W (1998) Successful testicular sperm extraction (TESE) in spite of high serum follicle stimulating hormone and azoospermia: Correlation between testicular morphology, TESE results, semen analysis and serum hormone values in 103 infertile men. *Hum Reprod* 13: 1230–1234
- Johannisson R, Schulze W, Holstein AF (2003) Megalospermatocytes in the human testis exhibit asynapsis of chromosomes. *Andrologia* 35:146–151
- Johnsen SG (1970) Testicular biopsy score count – a method for registration of spermatogenesis in human testis: normal values and results in 335 hypogonadal males. *Hormones* 1:2–25
- Johnson L, Chaturvedi PK, Williams JD (1992) Missing generations of spermatocytes and spermatids in seminiferous epithelium contribute to low efficiency of spermatogenesis in humans. *Biol Reprod* 47:1091–1098
- Kemper S, Pühse G, Bergmann M, Kliesch S (2006) Untersuchung zum histologischen Korrelat der Mikrolithiasis testis bei Infertilitätspatienten. *Urologe* 45(Suppl):57
- Kim S-K, Yoon Y-D, Park Y-S, Seo JT, Kim J-H (2007) Involvement of the Fas-Fas ligand system and active caspase-3 in abnormal apoptosis in human testes with maturation arrest and Sertoli Cell-only syndrome. *Fertil Steril* 87:547–553
- Kliesch S, Behre HM, Hertle L, Bergmann L (1998) Alteration of Sertoli cell differentiation in the presence of carcinoma in situ in human testes. *J Urol* 160:1894–1898
- Kliesch S, Thomaidis T, Schütte B, Pühse G, Kater B, Roth S, Bergmann M (2003) Update on the diagnostic safety for detection of testicular intraepithelial neoplasia. *APMIS* 111:70–74
- Krege S, Beyer J, Souchon R, et al (2008) European consensus conference on diagnosis and treatment of germ cell cancer: A report of the second meeting of the European Germ Cell Cancer Consensus group (EGCCCG): Part I. *Eur Urol* 53:478–496
- Lanfranco F, Kamischke A, Zitzmann M, Nieschlag E (2004) Klinefelter's syndrome. www.thlancet.com 364:273–284
- Lewin A, Reubinoff B, Porat-Kratz A (1999) Testicular needle aspiration: The alternative method for sperm retrieval in non-obstructive azoospermia. *Hum Reprod* 14:1785–1790
- McLachlan RI, Rajpert-De Meyts E, Hoi-Hansen CE, de Kretser DM, Skakkebaek NE (2007) Histological evaluation of the testis – approaches to optimizing the clinical value of the assessment: Mini Review. *Hum Reprod* 22:2–16
- Meineke V, Frungieri MB, Jessberger B, Vogt H-J, Mayerhofer A (2000) Human testicular mast cells contain tryptase: Increased mast cell number and altered distribution in the testes of infertile men. *Fertil Steril* 74:239–244
- Mercan R, Urman B, Alatas C, Aksoy S, Nuhoglu A, Isiklar A, Balaban B (2000). Outcome of testicular sperm retrieval procedures in non-obstructive azoospermia: percutaneous aspiration versus open biopsy. *Hum Reprod* 15:1548–1551
- Mitchell V, Steger K, Marchetti C, Herbaut J-C, Devos P, Rigot J-M (2005) Cellular expression of protamine 1 and 2 transcripts in testicular spermatids from azoospermic men submitted to TESE-ICSI. *Mol Hum Reprod* 11:373–379
- Okada H, Goda K, Yamamoto Y, Sofikits N, Miyagawa I, Mio Y, Koshida M, Horie S (2005) Age as a limiting factor for successful sperm retrieval in patients with nonmosaic Klinefelter's syndrome. *Fertil Steril* 84:1662–1664
- O'Neill DA, McVicar CM, McClure N, Maxwell P, Cooke I, Pogue KM, Lewis SEM (2007) Reduced sperm yield from testicular biopsies of vasectomized men is due to increased apoptosis. *Fertil Steril* 87:834–841
- Pühse G, Kliesch S, Bergmann M, Hertle L (2002) Korrelation des Histologiescores mit dem Hodenvolumen bei Patienten mit obstruktiver Azoospermie. *Der Urologe* 41:13
- Raman JD, Nobert CF, Goldstein M (2005) Increased incidence of testicular cancer in men presenting with infertility and abnormal semen analysis. *J Urol* 174:1819–1822
- Ramasany R, Yagan N, Schlegel PN (2005) Structural and functional changes to the testis after conventional versus microdissection testicular sperm extraction. *Urol* 65:1190–1194
- Regadera J, Martinez-Garcia F, Gonzalez-Peramato P, Serrano A, Nistal M, Suarez-Quian C (2001) Androgen receptor expression in Sertoli cells as a function of seminiferous tubule maturation in the human cryptorchid testis. *J Clin Endocrinol Metab* 86: 431–421
- Roaiiah MMF, Khatab H, Mostafa T (2007) Mast cells in testicular biopsies of azoospermic men. *Andrologia* 39:185–189
- Rørth M, Rajpert-De Meyts E, Andersson L, Diekmann K-P, Fossa SD, Grigor KM, Hendry WF, Herr HW, Looijenga LH, Oosterhuis JW, Skakkebaek NE (2000) Carcinoma in situ of the testis. *Scand J Urol Nephrol* 205(Suppl): 166–186
- Schiff JD, Palermo GD, Veek LL, Goldstein M, Rosenwaks Z, Schlegel PN (2005) Success of testicular sperm extraction [corrected] and intracytoplasmic sperm injection in men with Klinefelter syndrome. *J Clin Endocrinol Metab* 90: 6263–6267
- Schlegel PN, Li S (1998) Microdissection TESE: sperm retrieval in non-obstructive azoospermia VIDEO. *Hum Reprod Update* 4:439
- Schulze C, Schütte B (1990) Concretions in the human testis are derived from of the basal lamina of seminiferous cords. *Cell Tissue Res* 260:1–12

- Schuppe H-C, Meinhardt A, Allam JP, Bergmann M, Weidner W, Haidl G (2008) Chronic orchitis: A neglected cause of male infertility? *Andrologia* 40:84–91
- Sharpe RM, McKinnell C, Kivlin C, Fisher S (2003) Proliferation and functional maturation of Sertoli cells, and their relevance to disorders of testis function in adulthood. *Reproduction* 125: 769–784
- Shufaro Y, Prus D, Laufer N, Simon A (2002) Impact of repeated testicular fine needle aspirations (TEFNA) and testicular sperm extraction (TESE) on the microscopic morphology of the testis: An animal model. *Hum Reprod* 17:1795–1799
- Sigg C (1979) Klassifizierung tubulärer Hodenatrophien bei Sterilitätsabklärungen. Bedeutung der sogenannten bunten Atrophie. *Schweiz med Wschr* 109:1284–1293
- Silber SJ (2000) Microsurgical TESE and the distribution of spermatogenesis in non-obstructive azoospermia. *Hum Reprod* 15:2278–2284
- Silber SJ, Van Steirteghem AC, Liu J, Nagy Z, Tournaye H, Devroey P (1995) High fertilization and pregnancy rate after intracytoplasmic sperm injection with spermatozoa obtained from testicular biopsy. *Hum Reprod* 10:148–152
- Steger K, Rey R, Kliesch S, Louis F, Schleicher G, Bergmann M (1996) Immuno-histochemical detection of immature Sertoli cell markers in testicular tissue of infertile adult men: A preliminary study. *Int J Androl* 19:122–128
- Steger K, Aleithe I, Behre H-M, Bergmann M (1998) The proliferation of spermatogonia in normal and pathologic human seminiferous epithelium: An immunohistochemical study using monoclonal antibodies against Ki-67 protein and proliferating cell nuclear antigen PCNA. *Molec Hum Reprod* 4:227–233
- Steger K, Failing K, Kliesch S, Behre HM, Manning M, Weidner W, Hertle L, Bergmann M, Kliesch S (2001) Round spermatids from infertile men exhibit decreased levels of protamine-1 and protamine2 mRNA. *Hum Reprod* 16: 709–716
- Steger K, Fink L, Failing K, Bohle RM, Kliesch S, Weidner W, Bergmann M (2003) Decreased protamine-1 transcript levels in testes from infertile men. *Mol Hum Reprod* 9: 331–336
- Sun F, Turek P, Green C, Ko E, Rademaker A, Martin RH (2007) Abnormal progression through meiosis in men with obstructive azoospermia. *Fertil Steril* 87:565–571
- Van Casteren NJ, Boellaard WPA, Dohle GR, Weber RFA, Kuizinga MC, Stoop H, Oosterhuis WJ; Looijenga LHJ (2008) Heterogenous distribution of ITGCNU in an adult testis: Consequences for biopsy-based diagnosis. *Int J Surg Pathol* 16:21–24
- Vegni-Telluri M, Bigliardi E, Vanni MG, Tota G (1980) Testicular microliths: Their origin and structure. *J Urol* 180:105–107
- von Eckardstein S, Tsakmakidis G, Kamischke A, Rolf C, Nieschlag E (2001) Sonographic testicular microlithiasis as an indicator of premalignant conditions in normal and infertile men. *J Androl* 22:818–824
- Weidner W, Colpi GM, Hargreave TB, Papp GK, Pomeroy JM (2002) The EAU working group on male infertility. EAU guidelines on male infertility. *Eur Urol* 42:313–322
- Wikström AM, Hoei-Hansen CE, Dunkel L, Rajpert-De Meyts E (2007) Immunoexpression of androgen receptor and nine markers of maturation in the testes of adolescent boys with Klinefelter syndrome: Evidence for degeneration of germ cells at the onset of meiosis. *J Clin Endocrinol Metab* 92: 714–719
- Zitzmann M, Nordhoff V, von Schönfeld V, Nordsiek-Mengede A, Kliesch S, Schüring AN, Luetjens CM, Kamischke A, Cooper T, Simoni M, Nieschlag E (2006) Elevated follicle-stimulating hormone levels and the chances for azoospermic men to become fathers after retrieval of elongated spermataids from cryopreserved testicular tissue. *Fertil Steril* 86: 339–347

Diseases of the Hypothalamus and the Pituitary Gland

12

Hermann M. Behre, Eberhard Nieschlag, Carl-Joachim Partsch, Peter Wieacker, and Manuela Simoni

Contents

12.1 Isolated/Idiopathic Hypogonadotropic Hypogonadism (IHH) and Kallmann Syndrome	170	12.5.3 Clinical Picture	180
12.1.1 Definition and Prevalence.....	170	12.5.4 Diagnosis	180
12.1.2 Etiology and Pathogenesis.....	170	12.5.5 Treatment.....	181
12.1.3 Clinical Picture	172	12.6 Secondary GnRH Deficiency	181
12.1.4 Diagnosis	173	12.6.1 Etiology and Pathogenesis.....	181
12.1.5 Therapy	174	12.6.2 Clinical Picture	182
12.2 Prader-(Labhart-)Willi Syndrome	176	12.6.3 Diagnosis	182
12.2.1 Etiology and Pathogenesis.....	176	12.6.4 Therapy	182
12.2.2 Clinical Picture and Diagnosis	176	12.7 Hypopituitarism	182
12.2.3 Therapy	177	12.7.1 Etiology and Pathogenesis.....	182
12.2.4 Bardet-Biedl and Laurence-Moon Syndromes	177	12.7.2 Clinical Picture	182
12.3 Cerebellar Ataxia and Hypogonadism	178	12.7.3 Diagnosis	182
12.4 Congenital Adrenal Hypoplasia with Hypogonadotropic Hypogonadism	178	12.7.4 Therapy	183
12.5 Constitutional Delay of Development	179	12.7.5 Hypopituitarism in Heritable Disorders of Pituitary Development	183
12.5.1 Normal Onset of Puberty and Definition of Delayed Puberty	179	12.8 Isolated LH or FSH Deficiency	183
12.5.2 Etiology and Pathogenesis of Constitutional Delay of Puberty	179	12.9 Hyperprolactinemia	184
		12.9.1 Etiology and Pathogenesis.....	184
		12.9.2 Clinical Picture	185
		12.9.3 Diagnosis	185
		12.9.4 Therapy	185
		12.10 Gonadotropin-Secreting Tumors	187
		References	187

H. M. Behre (✉)
Centre for Reproductive Medicine and Andrology
of the University, Ernst-Grube-Str. 40, D-06120 Halle,
Germany
e-mail: hermann.behre@medizin.uni-halle.de

12.1 Isolated/Idiopathic Hypogonadotropic Hypogonadism (IHH) and Kallmann Syndrome

12.1.1 Definition and Prevalence

Isolated/Idiopathic hypogonadotropic hypogonadism (IHH) and Kallmann syndrome (Kallmann et al. 1944) are closely related diseases sharing **disturbed hypothalamic secretion or action of GnRH** as their core pathophysiological feature. Hypogonadism resulting from the GnRH deficiency is the only clinical manifestation of isolated/idiopathic hypogonadotropic hypogonadism. Patients with Kallmann syndrome feature **anosmia** and occasionally some other physical anomalies.

Among males Kallmann syndrome in its fully developed form has a prevalence of about 1 in 10,000. The prevalence in males is four times higher than in females (Seminara et al. 1998). Currently the genetic defect underlying Kallmann syndrome and IHH can be demonstrated in about half of the familial cases and in about 10% of the sporadic cases. The old denomination “idiopathic” hypogonadotropic hypogonadism, which reflects ignorance of the causal defect, therefore appears obsolete. The acronym IHH should stand for “isolated” hypogonadotropic hypogonadism, referring to the inadequacy of gonadotropin secretion as the only defect.

12.1.2 Etiology and Pathogenesis

Deficiency of hypothalamic GnRH or its action constitutes the basic **endocrine abnormality** in both IHH and Kallmann syndrome. Secondary to this, the secretion of gonadotropins from the pituitary is impaired (see Sect. 2.2.3). Owing to LH and FSH deficiency, the gonads can neither produce mature sperm nor sufficient quantities of testosterone. Although not demonstrated in all cases, the cause of IHH and Kallmann syndrome must be regarded as a congenital, genetic defect which results in LH and FSH deficiency by two main pathogenetic mechanisms: (i) interference with the migration and homing of the GnRH-secreting neurons or (ii) lack of activation of the correctly located GnRH-secreting

neurons. In the first case, IHH may (but must not) be accompanied by anosmia and other dysmorphogenetic symptoms (Kallmann syndrome). In the second case IHH remains the only clinical manifestation.

During normal embryonic development precursors of the **GnRH neurones migrate from the nasal olfactory epithelium to their ultimate anatomical destination in the basal hypothalamus** (Fig. 12.1). This neuronal migratory movement is regulated by a number of genes and is disturbed in subjects with Kallmann syndrome. In an embryo with a deletion involving the *KALI* gene it was demonstrated that the precursors of GnRH neurons remain blocked in the olfactory epithelium (Schwanzel-Fukuda et al. 1989). In such an ectopic position, the neurons are unable to stimulate the pituitary gonadotrophs. The genes involved in GnRH neuron migration mutated in Kallmann syndrome identified to date are listed in Table 12.1.

KALI is located on the X chromosome and is mutated or (more rarely) deleted in patients with positive family history and X chromosomal recessive mode of inheritance. Mutations of *KALI* are found in about 15–50% of the X-linked familial cases and in 10% of sporadic cases. The *KALI* gene product, anosmin 1 is a protein of the extracellular matrix localised in the olfactory bulb, which has been proposed to be involved

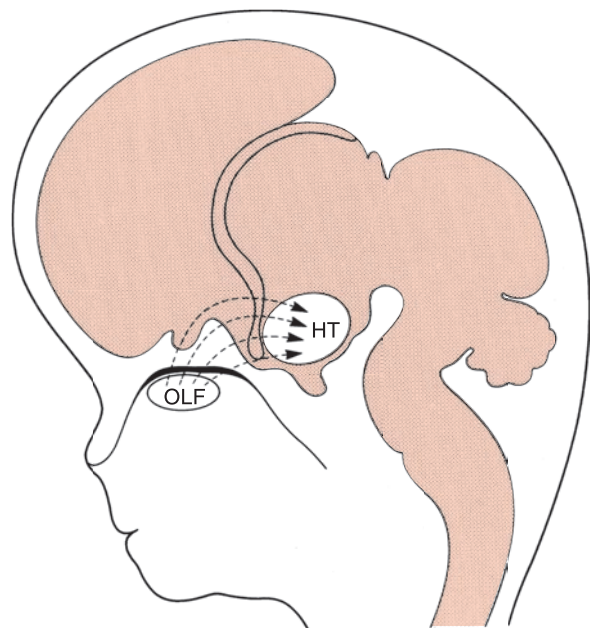

Fig. 12.1 Schematic representation of embryonic migration of GnRH neurons (OLF: nasal olfactory epithelium; HT: hypothalamus)

Table 12.1 Genes that might be mutated in patients with Kallmann syndrome or IHH

Acronym	Name	Location	Gene ID	MIM	Function
<i>KALI</i>	Kallmann syndrome 1 sequence (anosmin 1)	Xp22.32	3730	308700	Possible function in neural cell adhesion and axonal migration
<i>FGFR1</i>	Fibroblast growth factor receptor 1	8p11.2–p11.1	2260	136350	Binds both acidic and basic fibroblast growth factors
<i>FGF8</i>	Fibroblast growth factor 8	10q24	2253	600483	Member of the fibroblast growth factor (FGF) family involved in organogenesis
<i>PROK2</i>	Prokineticin 2	3p13	60675	607002	Chemoattractant for neuronal precursor cells in the olfactory bulb
<i>PROKR2</i>	Prokineticin receptor 2	20p12.3	128674	607123	G protein-coupled receptor for prokineticins
<i>CHD7</i>	Chromodomain helicase DNA binding protein 7	8q12.2	55636	608765, 608892	Expressed in undifferentiated neuroepithelium and in mesenchyme of neural crest origin
<i>KISS1</i>	KiSS-1 metastasis-suppressor (METASTIN)	1q32	3814	603286	Ligand of GPR54: stimulation of GnRH secretion
<i>GPR54</i>	G protein-coupled receptor 54	19p13.3	84634	604161	Receptor for Kiss-1: stimulation of GnRH secretion
<i>TAC3</i>	tachykinin 3 (neurokinin B)	12q13–q21	6866	162330	Influences GnRH secretion
<i>TACR3</i>	tachykinin 3 (neurokinin B) receptor	4q25	6870	162332	Receptor for tachykinin 3
<i>GNRH1</i>	gonadotropin-releasing hormone 1	8q21–p11.2	2796	152760	Ligand of GnRH receptor
<i>GNRHR</i>	Gonadotropin-releasing hormone receptor	4q21.2	2798	138850	Receptor for the gonadotropin-releasing hormone

in the signal transduction of the fibroblast growth factor receptor 1 (FGFR1) (Dodè and Hardelin 2004). Indeed, in families with the autosomal dominant form of the Kallmann syndrome, linkage analysis led to the identification of heterozygous mutations of the *FGFR1* gene (Dodè et al. 2003), found in about 15% all cases (familial and sporadic). Mutations or deletions of the *KALI* gene and of the *FGFR1* (also known as *KAL2*) gene result in the same phenotype, suggesting an interaction between the two factors. The relevant ligand of FGFR1 is FGF8 and missense mutations of the *FGF8* gene were found in patients with IHH with variable olfactory phenotype (Falardeau et al. 2008).

Other genes mutated in Kallmann syndrome and therefore involved in GnRH neuron migration are those encoding for prokineticin 2 (*PROK2*) and its receptor (*PROKR2*) (responsible for about 10% of the disease) (Dodè et al. 2006) and the *CHD7* gene (found in 6% of sporadic cases) (Kim et al. 2008). Mutations of the *CHD7* gene are usually found in the CHARGE syndrome, a multisystem autosomal dominant disorder including anosmia and hypogonadism among the symptoms.

Notwithstanding this expanding number of genes mutated in the Kallmann syndrome, the genetic defect is

not known in about 50% of cases, especially sporadic, suggesting that a plethora of genes involved in olfactory bulb formation and GnRH neuron migration exist. Of note, while anosmia is invariably present in *KALI* mutations, sense of smell might be only reduced or even normal in the case of all other genes. On the other hand, anosmia can be present as isolated symptom in the pedigree of subjects with Kallmann syndrome. Mutations of the *FGFR1*, *PROK2* and *PROKR2* show variable expression, with symptoms ranging from isolated anosmia, IHH or delayed puberty even within the same family (De Roux 2005; Pitteloud et al. 2005). This can be explained as variable phenotypic expression of a uniform gene defect.

The second pathogenetic mechanism of IHH is a defect in activation of the GnRH secreting neurons resulting in lack of secretion or apulsatile secretion of gonadotropins. Known causes are mutations of the *KISS1* gene, the *GPR54*-(*KISS1R*-)gene, the *TAC3* (tachykinin 3 or neurokinin B) gene, the *TACR3* (tachykinin 3 or neurokinin B receptor) gene, and - in case of GnRH resistance - the *GNRHR* gene (see Table 12.1 and Sects. 2.2.2 and 2.2.3). *GNRHR* mutations are the most frequent ones (Bédécarrats and Kaiser 2007), cause subtypes of IHH varying from complete to partial resistance to GnRH and account for less than 50%

of familial IHH cases and a small fraction of sporadic cases. The exact prevalence of TAC3 and TAC3R mutations is not known, yet (Topaloglu et al. 2009). Very recently, mutations of GnRH (gonadotropin-releasing hormone 1) have been shown to cause isolated hypogonadotropic hypogonadism (Bouligand et al. 2009, Chan et al. 2009).

12.1.3 Clinical Picture

Absent or incomplete pubertal development with severe hypogonadism is the **clinical hallmark** of both IHH and Kallmann syndrome. The testis has a mean volume of about 3 ml (normal for adult men: ≥ 12 ml).

The patients frequently present with uni- or bilateral cryptorchidism, or orchidopexy has previously been performed. The scrotum may be hypoplastic and hypopigmented. Other signs of hypogonadism include underdevelopment of the penis and prostate, absent or sparse pubic, axillary and body hair, lack of beard growth, eunuchoid body proportions and a female distribution pattern of adipose tissue (Fig. 12.2). Gynecomastia is a rare finding. Untreated men with IHH and Kallmann syndrome are infertile because of aspermia or azoospermia. Without endocrine substitution these patients have no or reduced sexual activities. Osteoporosis may occur as a secondary complication of longstanding hypogonadism.

The variability of the clinical picture with regard to clinical severity and age of onset should be noted.



Fig. 12.2 Initial presentation of a 33-year-old patient with Kallmann syndrome before (remarkably late) initiation of treatment with testosterone and subsequent treatment with hCG/hMG. Infertility was the primary complaint. Typical presentation with signs of hypogonadism already present before puberty: (a) arm span greater than height (eunuchoid body proportions), female distribution pattern of adipose tissue, no beard growth; (b) straight frontal hair line; and (c) straight pubic hair line,

infantile penis and scrotum, and markedly subnormal testicular volume. Voice mutation had not occurred yet in this patient. Gonadotropin and testosterone levels were subnormal, but LH and FSH concentrations increased appropriately in response to a GnRH bolus. Hematocrit was severely reduced, the prostate was small, ejaculate analysis revealed azoospermia. Bone density as measured by quantitative computed tomography was reduced to 24% of the age-adjusted normal value

Besides the fully expressed disease, minor forms with partial pubertal development or onset of GnRH deficiency in adulthood have been described (Seminará et al. 1998). Notably, *FGF8* mutations have been documented in the rare, adult onset form of IHH (Falardeau et al. 2008).

Anosmia, absent in IHH, represents the second obligatory symptom of Kallmann syndrome. The inability to perceive olfactory stimuli results from **aplasia or hypoplasia of the olfactory bulbs and tracts**. The insensitivity relates only to aromatic olfactants; mucosal irritants such as ammonia evoke a normal reaction.

In addition to hypogonadism and anosmia, **other anomalies may be associated with Kallmann syndrome** (Dodé and Hardelin 2004). 5–10% of patients show impaired hearing or oral anomalies such as cleft lip or high arched palate. Synkinesis of the extremities or unilateral renal aplasia may occur in patients with the X-linked disease. Numerous other malformations and functional problems have been described in single case reports, and may represent expression of the phenotypic variability of the syndrome.

12.1.4 Diagnosis

If IHH or Kallmann syndrome is suspected, the most important endocrine parameters to be checked are the **basal serum levels of LH, FSH, testosterone, and estradiol**. Measurement of prolactin, TSH, ACTH, IGF-1, growth and thyroid hormones, and cortisol allows for evaluation of the other hypothalamic-pituitary axes. In unclear cases a **GnRH test** (see Sect. 7.2), performed both before and after a period of pulsatile GnRH stimulation, are mandatory.

Typically patients with Kallmann syndrome and IHH have markedly subnormal basal levels of LH, FSH and testosterone (hypogonadotropic hypogonadism). Responsiveness of the gonadotropins to GnRH stimulation is poor or altogether absent. This should not be misinterpreted as a sign of a primary abnormality at the pituitary level. Obviously the gonadotrophs only respond to a GnRH stimulus in a physiological fashion after a certain period of “priming”.

To differentiate between real pituitary pathology and the reversible unresponsiveness due to the lack of preceding exposure to GnRH, the **GnRH pump test** may

be performed. For a period of 7 days 5 µg GnRH are applied subcutaneously every 90–120 min using a portable minipump. If the gonadotropin response to a GnRH bolus has normalized after such pretreatment, a hypothalamic source of the hypogonadism is indicated. In contrast, a primary pituitary problem must be suspected if the gonadotrophs remain functionally resistant to a GnRH bolus. In this case mutations of the *GNRHR* gene may be present. Another important differential diagnosis is that between IHH/Kallmann syndrome and constitutional pubertal delay. GnRH bolus testing after 36 h of pulsatile GnRH pretreatment with a minipump may be helpful in this situation (see Sect. 12.5.4). A small subgroup of patients with IHH and Kallmann syndrome may also show low-normal FSH values in the presence of decreased LH levels (Spratt et al. 1987).

Typically, patients with congenital hypogonadotropic hypogonadism have significantly increased serum levels of anti-Muellerian hormone, which can be lowered by hCG or testosterone therapy, and stimulated by FSH (Young et al. 2003; Sinisi et al. 2008).

Proving **anosmia** in Kallmann syndrome is usually a straightforward procedure. The patient can be asked to close his eyes and identify an aromatic substance such as perfumed soap or coffee. More sophisticated testing with a standardized set of olfactants may sometimes be necessary. Mucosal irritants (e.g., ammonia) and gustatory stimuli are perceived normally in patients with Kallmann syndrome.

To the extent that a patient is able to produce a semen sample in view of his testosterone deficiency, low volume with azoospermia or only isolated sperm are to be expected.

Imaging procedures should include testicular and renal **ultrasound** (the latter to detect renal agenesis) and **magnetic resonance imaging** of the hypothalamic-pituitary region. It is of utmost importance not to overlook any intracranial mass which may present with clinical symptoms indistinguishable from IHH or Kallmann syndrome. Measurement of **bone density** should be included in the routine diagnostic workup (see Chap. 6).

As Kallmann syndrome and IHH are a genetic disorder, it is important to take a meticulous **family history**. The patient should be specifically questioned about relatives with absent or delayed puberty, hypogonadism, infertility, or anosmia. Depending on the presence of anosmia and the mode of inheritance, molecular genetic analysis may be indicated. In patients desiring children,

genetic counselling should be offered before initiation of therapy. The recurrence risk is 50% in autosomal dominant Kallmann syndrome or IHH.

12.1.5 Therapy

Treatment in newly diagnosed patients with IHH or Kallmann syndrome is initiated by applying **testosterone** for several months (see Chap. 21). This leads to rapid virilization, a higher level of general physical well-being and activity, and increased sexual drive. Most patients welcome these dramatic physical and psychological changes. Once the initial goal of rapid virilization has been achieved, treatment is redirected at stimulating gametogenesis up to the point that mature spermatozoa are produced. Medication is changed from testosterone to either GnRH or gonadotropins. This therapeutic approach is beneficial both for patients who desire fertility soon, as well as for those who want to have children later on. In the latter group spermatogenesis, once driven to full maturation, can probably be restimulated more effectively when fertility is actually desired (Büchter et al. 1998).

The **pulsatile application of GnRH** by means of a portable minipump most closely simulates normal physiology (Table 12.2). The pump delivers a small bolus of GnRH (usually 5–20 µg/pulse) every 120 min. Application is via a subcutaneous needle that has to be changed on a regular basis. The GnRH pulses induce the secretion of gonadotropins from the pituitary. In turn, the gonadotropins stimulate gonadal steroid production and gamete maturation. Often pulsatile GnRH therapy is not or only weakly effective in patients with mutations of the GnRH receptor (Caron et al. 1999b).

Alternatively, and presently more frequent, treatment with human chorionic gonadotropin (**hCG**, corresponding to LH activity) and recombinant **FSH** or

human menopausal gonadotropin (**hMG**, corresponding to FSH) can be considered (Burgues and Calderon 1997; European Metrodin HP Group 1998; Liu et al. 2002; Bouloux et al. 2002; Warne et al. 2008). In the male hCG and FSH must be injected intramuscularly or subcutaneously two and three times per week, respectively (Table 12.2). Recombinant hCG or LH are also available, but are not (yet) licensed for treatment of male hypogonadotropic hypogonadism.

Treatment is continued either until sperm appear in the ejaculate or a pregnancy has been induced (Fig. 12.3). There is a good chance of achieving fertility in men with IHH and Kallmann syndrome, and sperm production can be induced in nearly all patients (Fig. 12.4) (Liu et al. 1988, 2002; Schopohl et al. 1991; Büchter et al. 1998; European Metrodin HP Group 1998; Barrio et al. 1999; Bouloux et al. 2002; Warne et al. 2008). This may necessitate treatment courses with GnRH or gonadotropins that extend over 2 and more years (Fig. 12.3). Cryptorchidism or markedly subnormal testicular volume is not a contraindication to therapy. Nearly all such patients respond to treatment with a substantial increase in testicular volume (Büchter et al. 1998; Liu et al. 2002; Warne et al. 2008) (Fig. 12.5).

Gonadotropins and GnRH appear to be similarly efficient in stimulating spermatogenesis (Büchter et al. 1998). The therapist continues to be surprised about the low sperm concentrations with which patients under gonadotropin therapy induce pregnancies. The prerequisite for this is, of course, that female reproductive functions be optimized, and the female partner should be strongly encouraged in this direction. When this is the case, recourse to techniques of artificial reproduction is rarely needed.

Both GnRH and hCG/FSH therapy are costly and can only be justified when fertility is actually desired or, in the initial phase of treatment, when spermatogenesis is to be stimulated up to the point of sperm production. Once either goal has been achieved, ther-

Table 12.2 Therapeutic options for stimulation of spermatogenesis in patients with IHH or Kallmann syndrome (only those drugs are listed that are licensed for the respective indication in Germany)

Drug	Trade name	Application	Dose
<i>Pulsatile GnRH</i>	Lutrelif ^{<R>}	Subcutaneous, external minipump (Zyklomat ^{<R>} pulse)	5–20 µg per pulse every 120 min
<i>Alternatively to pulsatile GnRH</i>			
Human chorionic gonadotropin (<i>hCG</i>)	Predalon ^{<R>} Brevactid ^{<R>}	Intramuscular	1,000–2,500 IU 2 times per week
<i>in combination with recombinant FSH</i>	Gonal F ^{<R>} Puregon ^{<R>}	Subcutaneous	150–225 IU 2–3 times per week

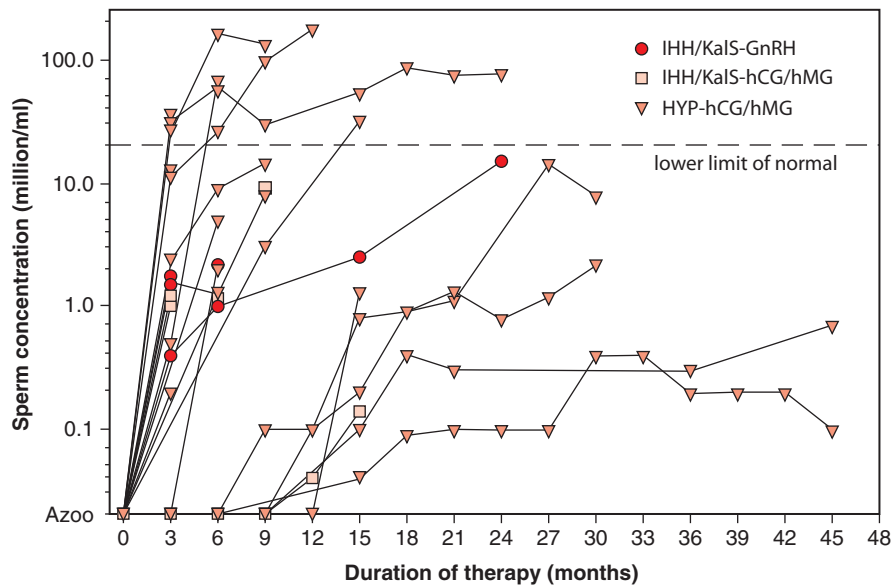

Fig. 12.3 Sperm concentrations in infertile patients with hypogonadotropic hypogonadism (*IHH/KaIS* = isolated hypogonadotropic hypogonadism and Kallmann syndrome; *HYP* = hypogonadism due to pituitary dysfunction). The diagram shows sperm concentrations over the course of hCG/hMG or pulsatile GnRH treatment up to the point when the female partner conceived. Stimulation of

spermatogenesis was achieved more rapidly in “HYP” patients with greater baseline testicular volume. Taken that the reproductive functions in the female partner are optimal, pregnancies occur with sperm concentrations of less than 3 million/ml. It may be necessary to continue treatment over prolonged periods of time. Therapy should not be terminated prematurely

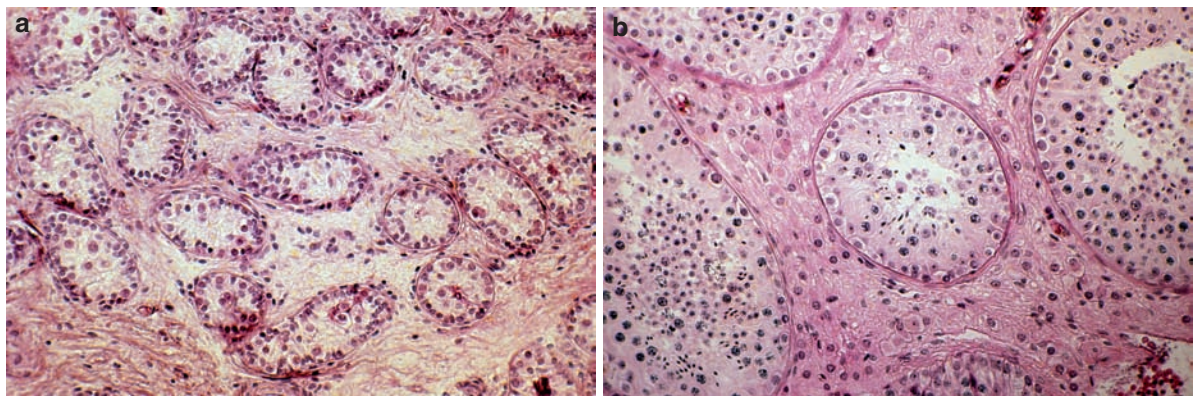

Fig. 12.4 Kallmann syndrome: testicular histology (a) before and (b) during hCG/hMG therapy with presence of elongated spermatids (Provided by Prof. C.A. Paulsen†, MD, University of Washington, Seattle)

apy is switched to hCG alone, which maintains testosterone production and stimulates spermatogenesis for a certain period (Depenbusch et al. 2002). In order to avoid renewed stimulation at a future timepoint, cryopreservation of the ejaculate should be considered (see Chap. 24). Thereafter substitution with testosterone is continued, which is cheaper, and which is

fully sufficient to compensate for the androgen deficiency. In most patients substitution using testosterone preparations (alternatively with GnRH or hCG/FSH when fertility is acutely desired) has to be lifelong to preserve secondary sexual characteristics and androgen-dependent functions and to prevent osteoporosis.

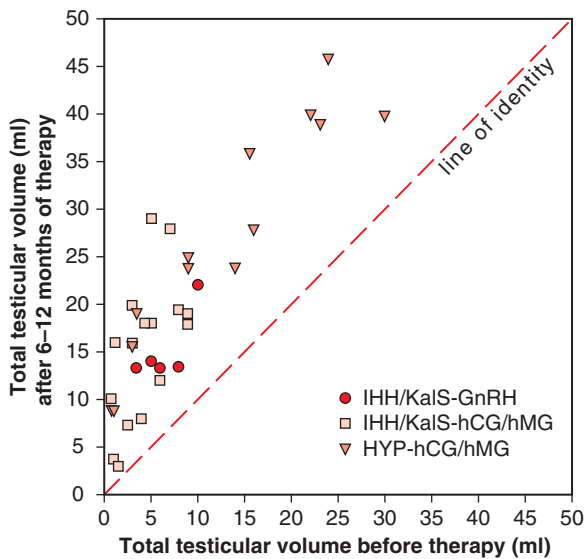

Fig. 12.5 Testicular volume measured by ultrasonography in patients with hypogonadotropic hypogonadism (*IHH/KalS* = isolated hypogonadotropic hypogonadism and Kallmann syndrome; *HYP* = hypogonadism due to pituitary dysfunction) before treatment and during a 6–12 month course of *hCG/hMG* or *pulsatile GnRH*. Note the significantly larger baseline testicular volume in “HYP” patients, who, for example, in a case of pituitary tumor, develop hypogonadism after puberty. However, among “isolated hypogonadotropic hypogonadism/*KalS*” patients a marked increase in testicular size can also be achieved

Spontaneous remission of hypogonadism was observed in about 10% of *IHH* or Kallmann patients after cessation of testosterone substitution (Raivio et al. 2007).

12.2 Prader-(Labhart-)Willi Syndrome

12.2.1 Etiology and Pathogenesis

Roughly one in 10,000 individuals has Prader-Labhart-Willi syndrome (Prader et al. 1956), today usually referred to as Prader-Willi syndrome (PWS). Because of the complex disturbance of their physical and mental development (Cassidy 1997), patients with PWS are most often seen by pediatricians. Today they are cared for by multiprofessional teams (Eiholzer and Whitman 2004). As **the disease must be considered in the differential diagnosis of delayed and incomplete puberty**, it should be familiar to the andrologist.

The **genetic basis** of the mostly sporadic, but occasionally familial Prader-(Labhart-)Willi syndrome is complex and cannot be described in detail in this chapter. Probably the phenotype is not caused by the loss or functional disturbance of a single gene but of a gene cluster in the region 15q11–q13 located on the proximal long arm of chromosome 15. This chromosomal region carries a **genomic imprint**. Genomic imprinting can modify the expression of genes according to their parental origin (Morison and Reeve 1998). Among various candidate genes the role of the *SNRPN* (small nuclear ribonucleoprotein polypeptide N) is the most established in the pathophysiology of the Prader-(Labhart-)Willi syndrome. This gene is essential for parental imprinting of the proximal long arm of chromosome 15 (Dittrich et al. 1996).

In 75% of Prader-(Labhart-)Willi syndrome patients, a **deletion in the chromosomal region 15q11–13** is detectable. It is always the paternally inherited chromosome 15 which carries the deletion. Rarely are these deletions detectable by conventional chromosome analysis, usually sub-microscopic microdeletions are involved. In addition, other structural chromosomal anomalies such as translocations or marker chromosomes may be observed in patients with PWS. In another 25% of the patients, **maternal uniparental disomy** of 15q11–13 is the mechanism underlying Prader-(Labhart-)Willi syndrome. Here *both* copies of the critical chromosomal region are contributed by the mother. Under normal circumstances, they should be inherited in a biparental fashion. As in deletion cases, the active paternal allele of the Prader-(Labhart-)Willi syndrome gene cluster is lacking. A few patients with the syndrome have “**imprinting mutations**” which interfere with the process of parental imprinting of critical chromosomal regions during gametogenesis (Ohta et al. 1999).

12.2.2 Clinical Picture and Diagnosis

Upon suspicion of a PWS, diagnosis is made with the aid of a diagnostic score system (Holm et al. 1993). The score system was revised in 2001 in order to define indications for molecular-genetic diagnosis in the various age groups (Gunay-Aygun et al. 2001). Molecular-genetic diagnosis is required for definitive diagnosis. Newborns and infants with Prader-(Labhart-)Willi syndrome often come to clinical attention because of

generalized and profound muscular hypotonia. Motor development is delayed, and feeding frequently poses a major problem in the first year of life because of reduced fluid intake. While the **children fail to thrive in infancy, as toddlers they tend to become obese**, often to a remarkable extent; leading to considerable morbidity (Partsch et al. 2000). Hyperphagia persisting into adulthood may be difficult to control. In up to 25% of the patients **type 2 diabetes mellitus** develops as a sequel of obesity (Butler et al. 2002). Men with Prader-(Labhart-)Willi syndrome have an average **final adult height of 161.6 ± 8.1 cm** (Wollmann et al. 1998). Even in relation to the short stature, hands and feet appear small, and the hands tend to be narrow. General **hypopigmentation** can be observed in every third patient. Aberrant craniofacial features in Prader-(Labhart-)Willi syndrome include almond-shaped palpebral fissures and a narrow forehead, but usually the face does not appear very dysmorphic. Middle-grade **mental retardation** is present in most, but not all patients with Prader-(Labhart-)Willi syndrome. The mental handicap may be more pronounced in some cases. Various behavior disorders are seen in childhood as well as adulthood (Cassidy 1997).

The **genitalia are hypoplastic** in the vast majority of males with Prader-(Labhart-)Willi syndrome. Children typically have a micropenis, uni- or bilateral maldescended testes, and above all, a hypoplastic scrotum (Crino et al. 2003). **Pubertal development is delayed and incomplete.** While the general state of virilization is poor, pubic hair may be normally developed. In the pubertal age boys with Prader-(Labhart-)Willi syndrome display a specific form of combined secondary (low LH and testosterone) and primary hypogonadism (low inhibin B and high FSH) (Eiholzer et al. 2006). In addition, Leydig cell function may be impaired, as indicated by a subnormal response of testosterone to injected hCG. Testicular biopsies show atrophy of the seminiferous tubules and usually spermatogonia are absent. It is presumed that all men with Prader-(Labhart-)Willi syndrome are **infertile** (Vogels et al. 2008). Offspring of fathers with PWS have not been described in the literature, but this issue has not been systematically studied.

Upon clinical suspicion of PWS, triggered by hypogonadism, slight mental retardation or deficiency, excessive food intake (hyperphagia, compulsive eating), central adiposity and typical behavioral anomalies (Gunay-Aygun et al. 2001), diagnosis should always be confirmed by molecular-genetic **analysis**. A reliable

and highly sensitive molecular test is based on analyzing the methylation pattern in the “critical” gene region (Gillesen-Kaesbach et al. 1995). Three to 5 ml of EDTA blood are required. However, this test does not differentiate between deletion, uniparental disomy and an imprint mutation. For further analysis, additional special tests and blood samples of the parents are needed.

12.2.3 Therapy

No causal treatment of Prader-(Labhart-)Willi syndrome is available (Goldstone et al. 2008). **Testosterone or hCG** can be given to compensate the endocrine hypogonadism (see Chap. 21; Eiholzer et al. 2007). Whether or not such hormonal treatment is initiated has to be decided on an individual basis, taking into account the psychosocial situation of the patient. Fears that behavioral problems typical of PWS patients will worsen by inducing puberty appear unfounded (Eiholzer et al. 2007).

Growth hormone therapy has been available for several years in Germany. It not only normalizes adult height (Angula et al. 2007; Lindgren and Lindberg 2008), but also has a number of positive effects on PWS patients (Burman et al. 2001).

12.2.4 Bardet-Biedl and Laurence-Moon Syndromes

Along with the Prader-(Labhart-)Willi syndrome, the Bardet-Biedl and Laurence-Moon syndromes were previously incorrectly considered as disorders with primary hypothalamic hypogonadism. The **Bardet-Biedl** and **Laurence-Moon** syndromes are very rare familial disorders with predominantly autosomal recessive inheritance. It is not conclusive whether the Laurence-Moon syndrome represents an independent entity. The Bardet-Biedl syndrome (BBS) is heterogenous. At present 12 BBS genes are known (Stoetzel et al. 2007). However, mutations in these 12 genes explain only about 70% of BBS cases. The mode of inheritance may be complicated by digenic inheritance (Burghes et al. 2001; Katsanis 2004). Genes responsible for the Bardet-Biedl syndrome are mapped to chromosomes 2, 3, 4, 7, 8, 9, 11, 12, 14, 15, 16, and 17 (OMIM 209900). The Bardet-Biedl syndrome is characterized by obesity,

progressive retinal dystrophy, renal anomalies and mental retardation as well as hexadactyly. Individuals with Laurence-Moon syndrome display progressive neurological problems, including spastic paraplegia and ataxia (Green et al. 1989; Beales et al. 1999).

Hypogonadism and hypogenitalism occur as facultative features in both conditions. It appears that, in contrast to previous thinking, the hypogonadism does *not* have a **hypothalamic or pituitary** basis. With few exceptions adult male patients have normal LH and FSH serum levels, and FSH may actually be increased. GnRH testing shows a regular gonadotropin response (Soliman et al. 1996). Furthermore, the serum testosterone concentration is usually within the normal range. Neither ejaculate parameters nor testicular histology have been systematically studied in the Bardet-Biedl and Laurence-Moon syndromes. Some case reports suggest that spermatogenesis may be compromised to a variable degree. However, single cases of paternity of males with Bardet-Biedl syndrome have been described (Beales et al. 1999).

12.3 Cerebellar Ataxia and Hypogonadism

Clinically and etiologically cerebellar ataxias constitute a highly **heterogenous group** of disorders whose classification depends on recent genetic findings (Baraitser 1997; Koeppen 1998). **Most cerebellar ataxias are genetically determined.** Several dozen hereditary conditions featuring cerebellar ataxia are known. The so-called pure forms become symptomatic only through cerebellar dysfunction. Another group of disorders combines this feature with extracerebellar signs and symptoms. One of these associations is that between cerebellar ataxia and hypogonadism (Baraitser 1997).

Within this category ataxias with hypo- or hypergonadotropic hypogonadism are to be distinguished. The term cerebellar ataxia with hypergonadotropic hypogonadism has been applied to several different conditions such as the Marinesco-Sjögren syndrome, ataxia teleangiectasia (the Louis-Bar syndrome) and even untypical cases of Klinefelter syndrome. It is beyond the scope of this book to discuss this poorly characterized group of patients.

Similarly, **cerebellar ataxia with hypogonadotropic hypogonadism** does not represent a single entity. The autosomal recessive Boucher-Neuhäuser

syndrome is best defined: it is characterized by absent or incomplete pubertal development with low levels of LH, FSH, testosterone and estradiol, signs of spinocerebellar ataxia and an atypical chorioretinal dystrophy (Rump et al. 1997). The increase of gonadotropins following GnRH administration is subnormal, even after GnRH pretreatment. This makes pituitary involvement probable. There are similarities between the Boucher-Neuhäuser syndrome and the Gordon-Holmes syndrome (Holmes cerebellar ataxia, hypogonadotropic hypogonadism, (spino)-cerebellar ataxia, nystagmus, possibly mental retardation [De Michele et al. 1993]) and the Oliver-McFarlane syndrome (hypogonadotropic hypogonadism, growth retardation, retinal degeneration, trichomegaly of eyelashes and sparse hair [Sampson et al. 1989]). The Gordon-Holmes syndrome is characterized by hypogonadotropic hypogonadism which cannot be treated by pulsatile GnRH (Quinton et al. 1999; Seminara et al. 2002).

12.4 Congenital Adrenal Hypoplasia with Hypogonadotropic Hypogonadism

The cytomegalic form of congenital adrenal hypoplasia is a rare, X-chromosomal recessive disease with a *prevalence* of approximately 1:12,500 (Kelch et al. 1984). It is usually associated with **hypogonadotropic hypogonadism** (Kletter et al. 1991) The LH and FSH deficiency is not present during the first years of life, but develops later (Bassett et al. 1999; Kaiserman et al. 1998; Peter et al. 1998; Takahashi et al. 1997). Whether the hypogonadism is caused by a pituitary or hypothalamic dysfunction cannot be answered conclusively.

In some patients a hypothalamic dysfunction was detected (Kletter et al. 1991; Partsch and Sippell 1989); treatment with pulsatile GnRH was without success in others (Caron et al. 1999a; Habiby et al. 1996; Kletter et al. 1991). In addition, a gonadal defect has been suggested (Caron et al. 1999a). Therefore, it is recommended that first the level of dysfunction should be determined in each patient, and the therapeutic strategy should only be chosen subsequently (see **Sects. 12.1, 12.7** and Chap. 15). The patients need lifelong substitution with gluco- and mineralocorticoids. Their dose must be increased in stressful situations and particularly prior to surgical procedures. *Withdrawal trials* are absolutely **contraindicated**.

In the majority of the patients the disease is caused by **mutations of the DAX-1 gene** (Peter et al. 1998) which is located on the short arm of the X chromosome in the region Xp21.3–21.2. The disease may occur in the form of a “microdeletion syndrome” (Budarf and Emanuel 1997) with Duchenne muscular dystrophy and glycerokinase deficiency. The hypogonadal pathogenesis has not been conclusively explained (Lalli and Sassone-Corsi 2003; Okuhara et al. 2008). Genetic heterogeneity is assumed (Muscatelli et al. 1994; Zanaria et al. 1994). The clinical presentation can be quite variable within one family (Merke et al. 1999). It should be noted that adrenal insufficiency may have its onset even after the neonatal period.

12.5 Constitutional Delay of Development

12.5.1 Normal Onset of Puberty and Definition of Delayed Puberty

Normal male puberty starts with the growth of the scrotum and a change in color and texture of the scrotal skin (stage G2 at 11.2 ± 3 years, mean \pm twice the standard deviation) (Fig. 12.6). A unilateral increase of testicular volume to ≥ 3 ml (11.8 ± 1.8 years) is the most reliable sign for the onset of puberty (Largo and Prader 1983). Thereafter pubertal hair growth, penis growth, growth spurt, beard growth and voice mutation follow. Because of the wide variability in the age of onset of puberty, a **healthy boy** aged between 13 and 14 years could equally well show all, as well as no signs of puberty (Fig. 12.6) (Largo and Prader 1983; Biro et al. 1995). Recently, the

data by Largo and Prader have been confirmed in a large-scale cross-sectional German study (Willers et al. 1996).

Delayed puberty (pubertas tarda) is present in a boy by definition if **pubertal development (genital development, testicular growth) has not started by the age of 14 years** (see Fig. 12.6).

12.5.2 Etiology and Pathogenesis of Constitutional Delay of Puberty

Constitutional delay of puberty (CDP) is by far the **most common cause of delayed puberty (pubertas tarda)**. In males the **prevalence** may be as high as 1:40.

Activation of the GnRH pulse generator with the subsequent increase of hormone production and secretion by endocrine organs (pituitary and testes) initiates pubertal development. The increasingly **pulsatile GnRH secretion is delayed** in boys with CDP. To date it is not clear which neural, endocrine, or metabolic signal causes maturation of hypothalamic centers and the onset of puberty. Similarly, it is not clear why the activation of this mechanism is delayed in some children. Recent studies have shown that in most cases of CDP an autosomal dominant pattern of inheritance exists (Sedlmeyer et al. 2002). Single genetic factors with an autosomal dominant effect are assumed whose penetrance is modified by other genetic and environmental influences (Sedlmeyer et al. 2002; Wehkalampi et al. 2008a). In families with several afflicted members a significant association of CDP with a locus in the pericentromere region of chromosome 2

Fig. 12.6 Schematic diagram of normal pubertal development. Means \pm twice the standard deviation are presented. The broken line represents the upper age limit for normal onset of puberty. Pubertal development commencing thereafter is defined as pubertas tarda

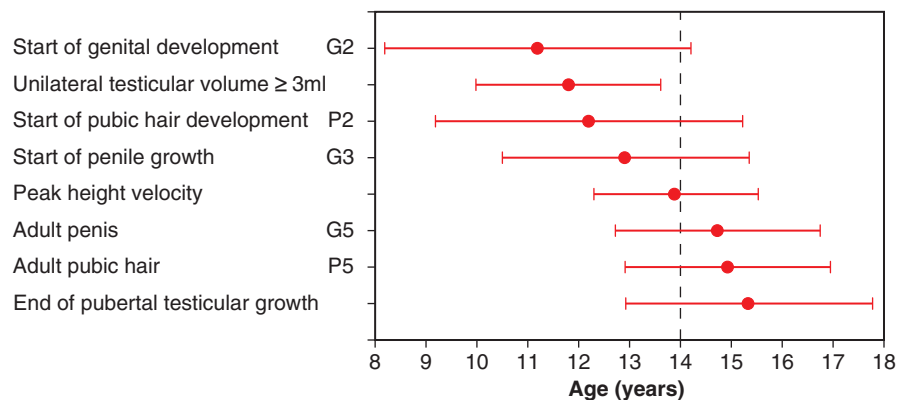

(2p13–2q13) was identified. It is believed that this region contains a gene that is part of the biological clock responsible for timing the beginning of puberty (Wehkalampi et al. 2008b).

The duration and sequence of pubertal events, once puberty has started, is usually normal in boys with CDP. Pubertal development finally ends with complete sexual maturity and normal fertility. CDP must therefore be seen as an **extreme functional variant** of the onset of normal pubertal development. While CDP is not a disease, the delay in pubertal development may be a pressing psychological burden for the adolescent. CDP occurs as a **familial or sporadic** condition (Sedlmeyer and Palmert 2002; Sedlmeyer et al. 2002; Wehkalampi et al. 2008a).

12.5.3 Clinical Picture

The children or adolescents present for two possible reasons: The first reason is **short stature**. Height is decreased compared to age-related standards. Patients who have not yet reached pubertal age may belong to this subgroup. In these cases the diagnostic term of **constitutional delay of growth and puberty (CDGP)** is preferable. These children are usually seen in pediatric departments rather than by andrologists.

The second reason is **delay or arrest of pubertal development**. Patients of pubertal age, older than 14 years, belong to this subgroup. In addition to their lack of virilization these patients may present with short stature which adds to the psychological pressure these patients often feel. Short stature is due to a transitory partial growth hormone deficiency which requires no treatment (Krajewska-Siuda et al. 2006). CDP also occurs in adolescents with body heights in all centiles (Butenandt et al. 2005).

Bone age, which serves as a measure of the individual's biological age, is always **retarded in CDP**. In extreme cases bone age retardation may reach 5 years. Height and pubertal stage are normal in relation to bone age (Sedlmeyer and Palmert 2002). Overall, development is harmonic if related to bone age. However, it must be emphasized that most patients with CDP **do not reach their genetic target height** (Poyrazoglu et al. 2005; Wehkalampi et al. 2007). The

later the pubertal growth spurt occurs in life, the less growth is achieved during the spurt. Patients with CDP or CDGP are likely to present with slightly eunuchoid body proportions owing to their prolonged prepubertal growth phase, which impairs spinal growth (Albanese and Stanhope 1994). This mild dysproportion often persists into adulthood.

12.5.4 Diagnosis

In addition to **anamnesis, growth curve** and complete physical examination, the radiographic determination of **bone age** of the left hand and wrist (including the ulnar and radial epiphyses) is the most important diagnostic procedure. Bone age is determined according to Greulich and Pyle (1959). CDP is the most likely diagnosis in the event that clinical signs are harmonic and normal in relation to bone age. However, the **diagnosis of CDP can only be made after excluding all other possibilities**. The possible causes of CDP are manifold. Fifty different reasons were found in a large case study (Sedlmeyer and Palmert 2002). Thus, it is important to exclude organic forms of hypogonadism such as Kallmann syndrome, multiple pituitary hormone deficiencies, hypercortisolism, syndromal diseases, malabsorption, chronic inflammatory bowel diseases and – in general – severe chronic diseases. Psychosocial deprivation and malnutrition may also lead to pubertal delay.

The major **diagnostic problem** is the **differentiation between CDP and isolated/idiopathic hypogonadotropic hypogonadism** (see Sect. 12.1). This differential diagnosis is important since different therapeutic options may arise and counselling of patients is different. **In both disorders basal gonadotropin levels and serum testosterone are low**. The response of LH and FSH in a standard *GnRH test* is also low. If a marked increase of LH is seen in the GnRH test (cut-off levels to be defined for each laboratory and each assay), the onset of pubertal development is imminent (Partsch et al. 1990).

The short-term **GnRH pump test** is an elegant diagnostic method as it imitates physiology. For diagnostic purposes pulsatile GnRH is given for 36 h (see Sect. 12.1.4). A standard GnRH test (100 µg) after 36 h of pulsatile stimulation (“priming”) has relatively good diagnostic sensitivity and specificity (see Sect. 12.1.4) (Partsch et al. 1985; Smals et al. 1994). In CDP patients

the increase of LH is higher than in isolated hypogonadotropic hypogonadism patients. **The criterion for CDP is an increase of over 3 IU/l LH following the standard GnRH bolus test.** The induction of LH and FSH secretion in patients with isolated hypogonadotropic hypogonadism warrants a stimulation time longer than 36 h. As an alternative to the pulsatile GnRH pump test the GnRH agonist test may be used, for which different modifications exist (Kaspers et al. 2004; Kauschansky et al. 2002; Wilson et al. 2006).

Despite numerous diagnostic tests, however, differential diagnosis between CDP and isolated hypogonadotropic hypogonadism can be made only after long-term follow-up in difficult cases.

12.5.5 Treatment

In most CDP patients spontaneous pubertal development starts before the age of 20 years. The **indication for treatment** is usually not the delay of puberty itself, but the **psychological pressure** caused by lack of virilization and/or short stature. There is some evidence that bone density may be compromised in later life in patients with CDP. Whether the mildly eunuchoid proportions in adulthood can be prevented by early treatment is not known to date. If the patient shows either clinical or hormonal signs of the beginning of pubertal development, therapeutic interventions should not be initiated. Intensive counselling and, in some cases, psychological help should be provided.

The treatment of choice for adolescents without signs of puberty is the intramuscular injection of **testosterone enanthate** at a dose of 50–250 mg every 4 weeks for 3–6 months (DeLuca et al. 2001; Houchin and Rogol 1998; see Chap. 21). This treatment leads to the development of secondary sex characteristics and to a growth spurt. The acceleration of bone maturation is proportional to the gain in height age: there is no decrease in predicted final height due to the short duration of treatment of 3–6 months (Kelly et al. 2003; Poyrazoglu et al. 2005). The effect of treatment should be documented in a standardized **growth chart**. Alternatively, oral testosterone undecanoate at a dose of 20–80 mg may be administered (Brown et al. 1995; Schmidt et al. 1998).

After cessation of treatment, spontaneous activation of the hypothalamic pulse generator and subsequent

endogenous puberty occurs after 3 months in most patients. **Treatment can be repeated** if spontaneous puberty does not occur after the first treatment period. In the event that a patient with bone age >13 years fails to show spontaneous pubertal development, it is likely that he has isolated hypogonadotropic hypogonadism. As an **alternative** to testosterone, **hCG** (1,000–2,000 IU/week i.m.) or **pulsatile GnRH** (see Sect. 12.1.5) can be given for 3 months. Theoretically, these treatment regimens have the advantage that testicular growth and spermatogenesis are stimulated. However, for achieving the goals of treatment in patients with CDP, hCG and pulsatile GnRH have no advantages.

12.6 Secondary GnRH Deficiency

12.6.1 Etiology and Pathogenesis

Any disturbance in the region of the diencephalon can also cause impairment of hypothalamic GnRH secretion. The localization and the extent of the damage determine the clinical picture; an isolated disturbance of GnRH secretion is rare.

Tumors in the region of the diencephalon (**craniopharyngiomas** or **meningiomas**) and **metastases** of other tumors can cause GnRH deficiency. **Granulomatous illnesses** such as sarcoidosis, histiocytosis, tuberculosis, neurolyues or **hemochromatosis** can likewise lead to a hypothalamic dysfunction. **Fractures of the skull base, ischemic and hemorrhagic lesions** in the area of the hypothalamus, as well as **radiotherapy** of malignant tumors or metastases in the region of the nasopharynx, the central nervous system, the orbita and the skull can cause a dysfunction of the hypothalamus and/or pituitary gland (Constine et al. 1993).

Gastrointestinal illnesses such as Crohn's or celiac disease – even without distinctive gastrointestinal symptoms – can lead to pubertal delay (Cacciari et al. 1983). Significant **malnutrition** (malabsorption syndromes, tumor cachexia, anorexia nervosa, etc.) and **chronic diseases** (sickle cell anemia, thalassemia, renal failure etc.) can cause a hypogonadotropic disturbance (see Chap. 18). The probable cause of testicular dysfunction in these cases is a **dysfunction of**

hypothalamic GnRH secretion. A similar mechanism may also cause pubertal delay in young athletes.

12.6.2 Clinical Picture

The clinical picture of the hypogonadism depends on the time of manifestation of the disorder (see Table 5.1) and can be disguised by other symptoms. Any suspicion of a hypothalamic disturbance will emerge from the general clinical appearance.

12.6.3 Diagnosis

Diagnosis takes account of the anamnesis, a physical examination, endocrine investigations including stimulation tests to differentiate between hypothalamic and pituitary lesions and imaging diagnosis (magnetic resonance imaging).

12.6.4 Therapy

Therapy should primarily be **treatment of the cause of the underlying disease** (see Chap. 18). If this is not possible, **symptomatic treatment** is applied by **substitution of the missing hormones**.

12.7 Hypopituitarism

12.7.1 Etiology and Pathogenesis

The most frequent causes of pituitary insufficiency are **tumors (gonadotropin, prolactin, growth hormone, TSH, ACTH secreting or hormone-inactive pituitary adenomas) or metastases of the pituitary and the hypophyseal stalk**, as well as post-operative states and **radiotherapy** of the pituitary area. Likewise, **trauma**, infections, hemochromatosis and vascular disorders can lead to pituitary insufficiency.

Endocrine deficiencies are to be expected if more than 75% of the hypophyseal tissue is destroyed. A disturbance of testicular function caused by a lack of **LH** and **FSH** secretion is often the first sign of an acquired insufficiency. Subsequent decreases in other pituitary hormones (**TSH, ACTH, GH**) cause dysfunction of the thyroid gland, the adrenals and a reduction in growth. In addition, dysfunction of the neurohypophysis causes diabetes insipidus (**panhypopituitarism**).

12.7.2 Clinical Picture

The clinical symptoms are determined by the time at which the insufficiency is manifested (see Table 5.1). **Prepubertal pituitary insufficiency** causes the **changes of body proportions** characteristic of hypogonadism; however, because of **growth-hormone deficiency**, the typical eunuchoid, tall stature is not seen. In addition to the other androgen deficiency symptoms, the clinical picture is determined by symptoms of **thyroid and adrenal dysfunction** and possibly **diabetes insipidus**. Puberty does not begin, or pubertal development is delayed and incomplete. **Hypopituitarism appearing after puberty** causes insufficiency of the thyroid gland and adrenal cortex, may cause diabetes insipidus and may lead to the typical symptoms of postpubertal androgen deficiency (see Table 5.1).

12.7.3 Diagnosis

Diagnosis is made by **magnetic resonance imaging** of the sella region, examination of the **visual fields** and determination of **basal hormone levels** in the serum (LH, FSH, prolactin, TSH, ACTH, GH, thyroid hormones, cortisol, IGF-1) and the absence of a rise in pituitary hormone levels during the **combined pituitary stimulation test** (100 µg GnRH, 200 µg TRH [thyroid-stimulating hormone releasing hormone], 100 µg GRH [growth hormone releasing hormone], 100 µg CRH [corticotropin releasing hormone] intravenously; blood to be sampled before and 30, 60 and 90 min after injection of releasing hormones). If a large pituitary tumor is suspected, pituitary stimulation tests are relatively contra-indicated because of possible complications such as acute tumor necrosis.

12.7.4 Therapy

If a **pituitary tumor** is responsible for the pituitary insufficiency, **neurosurgical removal** should usually be performed, which is preferably accomplished by the **trans-sphenoidal route** with protection of the healthy pituitary tissue. After surgery, regeneration of the remaining pituitary tissue is possible. Some tumors can be primarily **irradiated**. **Prolactinomas** (both micro- as well as macroprolactinomas) are treated primarily by **medical drugs** (see Sect. 12.9).

Substitution therapy of the absent hormones (cortisol, thyroid hormones, growth hormone, testosterone, possibly ADH) is required until restoration of pituitary function, if neurosurgical removal is not possible or if the pituitary is completely destroyed. Infertility is treated by hCG/FSH injections (see Sect. 12.1.5 and Figs. 12.3, 12.4). Compared to gonadotropin therapy for IHH, induction of pregnancy in partners of patients with hypopituitarism is more successful, especially if the pituitary insufficiency only occurs after completion of puberty. Once spermatogenesis has been induced physiologically, it is easier to reinduce it using gonadotropins than to stimulate the testis for the first time.

12.7.5 Hypopituitarism in Heritable Disorders of Pituitary Development

Congenital hypopituitarism is rare, but can be caused by mutations of transcription factor genes. These factors are important for pituitary development. A gene defect of the transcription factor *POU1F1* (formerly Pit-1) leads to pituitary deficiency of growth hormone, prolactin and TSH, but **not** to hypogonadism. The gene defect of the **transcription factor PROPI** causes an additional deficiency of LH and FSH. *PROPI* mutations are the most frequent cause of congenital panhypopituitarism (Mehta and Dattani 2008). The inheritance is autosomal recessive. The clinical appearance is variable. Short stature and hypothyroidism are predominant during the first years of life. Most of the patients experience spontaneous puberty; gonadotropin deficiency develops later in life (Deladoey et al. 1999; Flück et al. 1998). Hypogonadism is a constant symptom in adults (Rosenbloom et al. 1999). Familial

aggregation and prolactin deficiency point to mutations in the *PROPI* gene. A series of further transcription factors with their associated diseases has been identified in recent years (Mehta and Dattani 2008).

An important differential diagnosis of hypopituitarism during childhood is **septo-optic dysplasia** (Willnow et al. 1996). This is a highly heterogenous disease with a variable phenotype consisting of optic nerve anomalies, agenesis of the septum pellucidum and pituitary hormone deficiency. The prevalence is 6.3–10.9 in 100,000. Hypogonadotrophic hypogonadism is not obligatory, but always occurs in septo-optical dysplasia along with other pituitary deficiencies. The genes identified as causal to date are *HESX1*, *SOX2* and *SOX3* (Kelberman and Dattani 2008).

A familial form of X chromosomal recessive panhypopituitarism is associated with variable degrees of mental retardation (Lagerström-Fermér et al. 1997). A genetic amplification caused by interstitial duplication in the Xq26.1-q27.3 region containing the *SOX3* gene is assumed to be causal (Solomon et al. 2004).

12.8 Isolated LH or FSH Deficiency

Isolated LH or FSH deficiency are exceptionally rare forms of IHH in which only one of the two gonadotropins is lacking. In **isolated LH deficiency (Pasqualini syndrome)** [Pasqualini and Burr 1950], “**fertile eunuchs**”) there is a striking discordance between the clinical picture of hypogonadism, already evident prepubertally, and almost normal testicular volume. Testicular histology shows qualitatively preserved, quantitatively reduced spermatogenesis and atrophy of the Leydig cells. Endocrine investigations show decreased LH and normal FSH serum levels. A homozygous mutation of the *GNRHR* gene was demonstrated in one case (Pitteloud et al. 2001). Administration of hCG (LH activity) led to normalization of testosterone serum levels and to quantitatively normal spermatogenesis. Interestingly, following cessation of hCG therapy, the patient demonstrated reversal of hypogonadism with normal serum testosterone levels.

Inactivating mutations of the LH- β subunit gene are rare and, only four patients have been identified so far (Lofrano-Porto et al. 2008 and references therein). Men with *LHB* mutations (homozygous or compound

heterozygous) present with hypogonadism, delayed puberty and small testicular volume. Serum FSH is elevated while LH levels range from undetectable to elevated, depending on whether the mutation disrupts the immunogenicity of the molecule. Testicular histology shows an arrest of spermatogenesis and absence of Leydig cells. Long-term hCG treatment results in normal testicular volume, virilization and induction of spermatogenesis.

Isolated FSH deficiency due to mutations of the *FSHB* gene is rare (only three cases described so far) (Lofrano-Porto et al. 2008 and references therein). All cases presented with azoospermia but two men had normal puberty with normal to low normal testosterone and high LH levels, while the third man had low testosterone and absent puberty.

Occasionally isolated FSH deficiency was demonstrated in the presence of a normal *FSHB* gene sequence. These men have decreased spermatogenesis, while LH activity and thus androgenization is normal (Mantovani et al. 2003). The cause of FSH deficiency in these patients is unknown.

12.9 Hyperprolactinemia

12.9.1 Etiology and Pathogenesis

The peptide hormone prolactin, which is produced in the anterior lobe of the pituitary gland, has no known physiological function in the adult male. The **causes** of hyperprolactinemia in man are multiple (Fig. 12.7).

Small increases of prolactin levels can be caused by **physical** or **psychological “stress”**. In certain patients, even the atmosphere of the consulting room or the announcement of taking blood can cause an increase in prolactin levels.

Prolactin-secreting pituitary adenomas (prolactinomas) are the most frequent cause of hyperprolactinemia. Prolactinomas can be divided into **microprolactinomas** (with a diameter <10 mm) and **macroprolactinomas** (Fig. 12.9). The latter are large, rapidly proliferating tumors that exceed the margins of the sella and can lead to the destruction of surrounding structures, particularly the optic nerves.

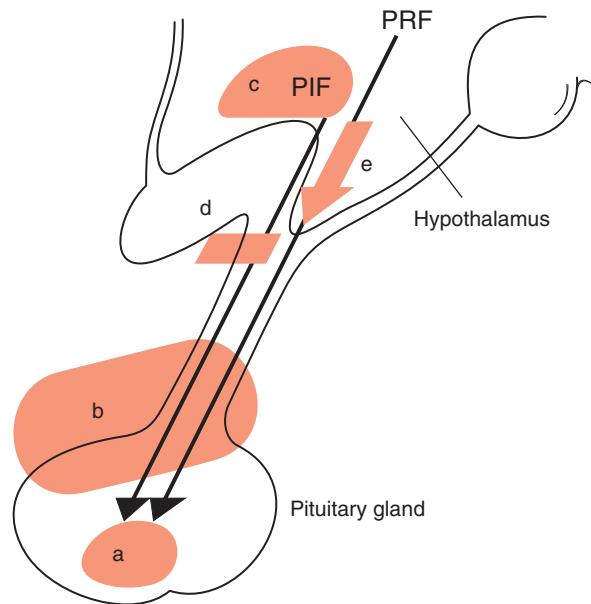

Fig. 12.7 Schematic diagram of possible causes of hyperprolactinemia: (a) prolactin-secreting tumor; (b) inhibition of transport of the prolactin-inhibiting factor (*PIF*, *dopamine*), e.g., by a suprasellar pituitary tumor; (c) destruction of the *PIF*-producing hypothalamic nuclei, e.g., by a tumor; (d) pharmacological inhibition of the secretion or biological action of *PIF*; (e) increased secretion of hypothalamic prolactin-releasing factor (*PRF*)

Classification of prolactinomas should not consider only the size of the adenomas but also their rate of growth, as macroprolactinomas also once began as small, rapidly growing adenomas. The basal level of prolactin is correlated, within broad limits, with the size of the adenoma. Malignant prolactinomas are extremely rare (Mancini et al. 2008). Familial prolactinomas have also been described (Berezin and Karasik 1995; Melmed 2008), but in most cases prolactinomas occur sporadically.

Prolactin secretion by the pituitary is regulated by the suppressive effect of **dopamine** secreted by the hypothalamus (Fig. 12.7). Lesions of the hypothalamus or the hypophyseal stalk can, therefore, induce excessive prolactin secretion (disconnection hyperprolactinemia) (Melmed 2008). **Pituitary tumors not secreting prolactin, craniopharyngiomas** and other **processes in the sella region** can also cause hyperprolactinemia. Primary hypothalamic disturbances can probably cause an **increased stimulation of the pituitary** by increased levels of **prolactin releasing factors** (Fig. 12.7), as is assumed for TRH, vasopressin and vasoactive intestinal polypeptides (VIP) (Mancini et al. 2008). In most cases of disconnection hyperprolactinemia serum prolactin levels do not exceed 2,000 mU/l; higher levels are

usually found only in macroprolactinomas (Karavitaki et al. 2006).

Drug-induced hyperprolactinemia is caused by the dopamine-antagonistic effects of the substances administered (e.g., butyrophenones, phenothiazines, imipramine, metoclopramide), their interference with dopamine synthesis (e.g., α -methyldopa), the depletion of dopamine stores (e.g., reserpine) or the direct stimulation of prolactin synthesis and secretion (e.g., H_2 -blockers, estrogens). Additional important causes for hyperprolactinemia are **chronic renal failure** and **hypothyroidism** (Schlechte 2003).

Hyperprolactinemia can cause disturbances of male reproductive functions via various mechanisms. At the hypothalamic level, hyperprolactinemia can **impair pulsatile GnRH release**. As a consequence of suppressed LH and FSH levels, secondary gonadal insufficiency develops with low testosterone levels and suppressed spermatogenesis. Hyperprolactinemia does not cause simultaneous gonadotropin deficiency in all cases: sellar and suprasellar processes of different kinds can cause both hyperprolactinemia (Fig. 12.7) and a simultaneous blockade of GnRH flux to the gonadotropic cells of the pituitary.

The second, and clinically more important, mechanism of impaired testicular function due to hyperprolactinemia is the **displacement and destruction of gonadotropic cells of the pituitary by macroprolactinomas**, resulting in suppression of LH and FSH levels (see Sect. 12.7, Fig. 12.8). A direct inhibitory effect of prolactin on the testis has not yet been demonstrated.

12.9.2 Clinical Picture

Hyperprolactinemia in men is manifested clinically by signs of **androgen deficiency and infertility**. Primarily, some of the patients complain of **disturbances of libido and erectile function**, and may **rarely develop gynecomastia and galactorrhea**. Some men with documented hyperprolactinemia are free of symptoms and complaints. Processes in the sella region can cause additional symptoms according to location and size, e.g., headaches or visual field defects.

12.9.3 Diagnosis

Diagnosis is based on **increased prolactin serum levels**. For evaluation of hypophyseal function, the basal

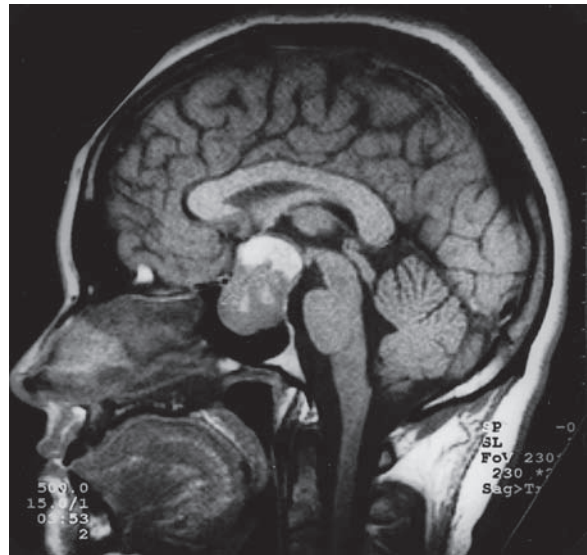

Fig. 12.8 Magnetic resonance image of a newly diagnosed macroprolactinoma

hormone levels (LH, FSH, TSH, ACTH, GH, thyroid hormones, cortisol, IGF-1; as described in Sect. 12.7.3) are measured and, in certain cases, a combined pituitary function test (GnRH, TRH, GRH, CRH) may be performed.

In stress-induced hyperprolactinemia the basal prolactin levels generally do not exceed twice the upper normal limit of 500 mU/l. Very high values (>5,000 mU/l) are typical for a macroprolactinoma; serum levels, however, can be variable. In each case of repeatedly measured, significantly increased prolactin levels **magnetic resonance imaging** of the hypothalamus/pituitary region should be performed to check for a prolactinoma or other tumors which might cause hyperprolactinemia. Likewise, a **visual field examination** is performed if suprasellar expansion of the tumor is suspected.

In general, dynamic tests of prolactin secretion are not suited for differential diagnosis of hyperprolactinemia (Schlechte 2003; Casanueva et al. 2006).

12.9.4 Therapy

There is no need for treatment of stress-induced hyperprolactinemia. For therapy of prolactinomas primarily the **dopamine agonists** are used. Long-range experience exists for bromocriptine (*Pravidel*[®], *Kirim*[®] and others) (Mancini et al. 2008), which has been applied

for over 25 years. Because of the hypotensive effect of bromocriptine, therapy should begin with low doses given in the late evening just before the patient retires (1.25 mg/day). The dose is raised slowly and is distributed over the course of the day (morning – noon – evening), until prolactin levels become normal (Fig. 12.9). The decrease of prolactin will be accompanied by a diminution in size of the prolactinoma (Bevan et al. 1992). At the beginning of therapy, side-effects can appear as decreased blood pressure, fatigue, headaches or gastrointestinal disturbances; occasional long-term side-effects include headaches, dry nasal mucosa, and digital vasospasms upon exposure to cold (Mancini et al. 2008).

Because of high efficacy and fewer side-effects than bromocriptine, today the long-lasting, **dopamine agonist cabergoline** (*Dostinex*[®] and others) can be used (De Rosa et al. 1998; Cannavo et al. 1999; Gillam et al. 2006). Usually therapy is initiated with 0.25–0.5 mg once or twice weekly and is increased monthly until prolactin levels normalize (Casanueva et al. 2006). Recently cardiac valve disease was reported as a potential side-effect in Parkinson patients taking high doses of cabergoline (>3 mg daily) (Zanettini et al. 2007). These effects were not seen for the usual dose of 0.25–3 mg/week given patients with prolactinoma (Kars et al. 2008; Herring et al. 2009); however, at higher

doses increased cardiac valve disease was also reported for prolactinoma patients (Colao et al. 2008). In view of these ambiguous connections it is presently recommended that patients with prolactinomas undergo echocardiography before and during long-range therapy with cabergoline (Kars et al. 2008; Sherlock et al. 2009).

In the event of side-effects with bromocriptine or cabergoline, alternatively quinagolide (Norprolac[®]), lisuride (Dopergin[®]) or metergoline (Liserdol[®]) are available.

For patients with prolactinomas on long-term treatment with dopamine agonists who no longer show tumor tissue in magnetic resonance imaging withdrawal trials can be attempted after 2–3 years (Calao et al. 2003; Gillam et al. 2006; Casanueva et al. 2006). After cessation of therapy, serum prolactin should be monitored regularly especially during the first year (Gillam et al. 2006; Schlechte 2007). Permanent normalization of prolactin without renewed tumor growth is often variously observed depending on studies and initial findings, may, however, be expected in 20–30% of treated patients with macroprolactinomas (Gillam et al. 2006; Schlechte 2007).

Today, **trans-sphenoidal excision of prolactinomas** is rarely indicated because of the effective drug treatments available, i.e., in less than 10% of patients,

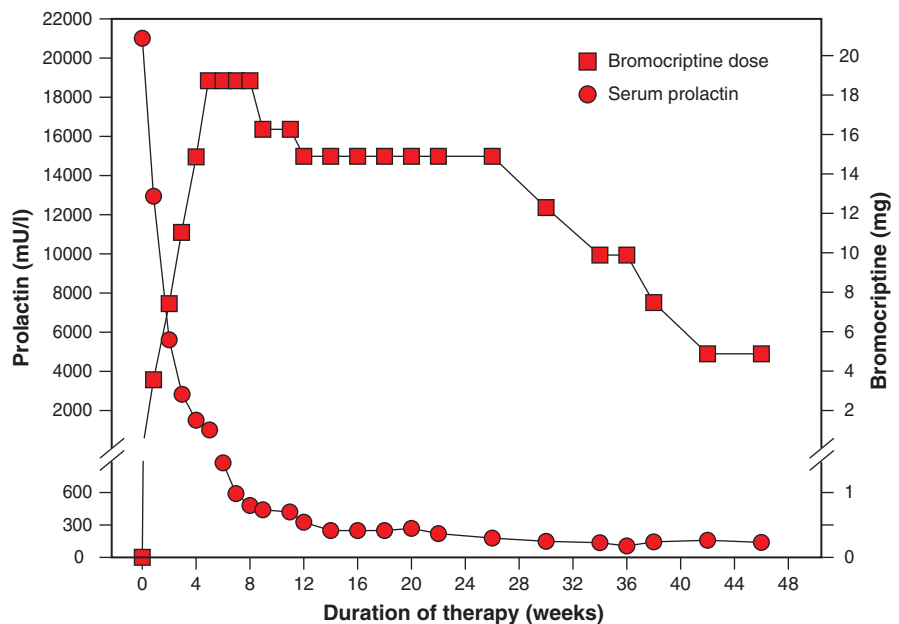

Fig. 12.9 Graphic display of prolactin serum levels during dopamine agonist therapy (*Pravidel*[®]) in a patient with a macroprolactinoma. After initial suppression of prolactin levels by high doses of *Pravidel*[®] it is possible to reduce the dose slowly, while prolactin levels remain suppressed

and only when pharmacological treatment is ineffective (Casanueva et al. 2006; Gillam et al. 2006; Mancini et al. 2008). The primary indication for neurosurgery or neuroradiotherapy is hyperprolactinemia caused by other tumors (Fig. 12.7).

Under effective therapy with dopamine agonists, normal LH pulsatility reappears and testosterone serum levels soon rise. **Persisting androgen deficiency** must be treated with adequate androgen substitution (see Chap. 21). At the beginning of dopamine agonist therapy, however, a “wait and see” approach can be taken according to the degree of androgen deficiency, or transdermal or oral androgen therapy can be initiated in order to interfere with pituitary function as little as possible. If hypogonadism persists despite therapy, or if neurosurgery or neuroradiotherapy has been performed, resulting in a loss of pituitary function, adequate testosterone substitution therapy is necessary (see Chap. 21) in addition to substitution with thyroid hormones and cortisol (see Sect. 12.7). In patients with persistent gonadotropin suppression seeking paternity, hCG plus FSH therapy can be initiated (see Sect. 12.1)

12.10 Gonadotropin-Secreting Tumors

Histologically verified gonadotropin-secreting pituitary tumors are relatively frequent (approximately 25% of all pituitary tumors) (Saeger et al. 2007). Only in isolated cases do these tumors secrete intact LH and/or FSH and thus cause precocious puberty or supra-physiological serum testosterone or macroorchia (Chaidaran and Klibanski 2002). In most cases these tumors become clinically evident by significant tumor growth, resulting in neurological symptoms and visual field defects (Jaffe 2006).

Standard therapy for gonadotropin-secreting macroadenomas (diameter ≥ 1 cm) is trans-sphenoidal surgery (Jaffe 2006). Because of the generally slow growth of microadenomas (diameter < 1 cm), observation accompanied by regular endocrinological monitoring and MRI seems justified in the absence of clinical symptoms (Jaffe 2006). No effective drug therapy of gonadotropin-secreting pituitary tumors has yet been established; radiotherapy is only indicated in special cases such as residual or recurrent tumors after trans-sphenoidal surgery (Chaidaran and Klibanski 2002; Melmed 2008).

References

- Albanese A, Stanhope R (1994) Pathogenetic mechanisms and management priorities in constitutional delay. In: Savage MO, Bourguignon JP, Grossman AB (eds) *Frontiers in paediatric neuroendocrinology*. Blackwell, Oxford, pp 33–37
- Angulo MA, Castro-Magna M, Lamerson M, Arguello R, Accacha S, Khan A (2007) Final adult height in children with Prader-Willi syndrome with and without growth hormone treatment. *Am J Med Genet* 143A:1456–1461
- Baraitser M (ed) (1997) *Cerebellar ataxia*. In: *The genetics of neurological disorders*, 3rd edn. Oxford University Press, Oxford, pp 146–165
- Barrio R, de Luis D, Alonso M, Lamas A, Moreno JC (1999) Induction of puberty with human chorionic gonadotropin and follicle-stimulating hormone in adolescent males with hypogonadotropic hypogonadism. *Fertil Steril* 71:244–248
- Bassett JH, O'Halloran DJ, Williams GR, Beardwell CG, Shalet SM, Thakker RV (1999) Novel DAX-1 mutations in X-linked adrenal hypoplasia congenita and hypogonadotropic hypogonadism. *Clin Endocrinol* 50:69–75
- Beales PL, Elcioglu N, Woolf AS, Parker D, Flintner FA (1999) New criteria for improved diagnosis of Bardet-Biedl syndrome: results of a population survey. *J Med Genet* 36:437–446
- Bédécarrats GY, Kaiser UB (2007) Mutations in the human gonadotropin-releasing hormone receptor: insights into receptor biology and function. *Semin Reprod Med* 25:368–378
- Berezin M, Karasik A (1995) Familial prolactinoma. *Clin Endocrinol* 42:483–486
- Bevan JS, Webster J, Burke C, Scanlon MF (1992) Dopamine agonists and pituitary tumor shrinkage. *Endocr Rev* 13:220–240
- Biro FM, Lucky AW, Huster GA, Morrison JA (1995) Pubertal staging in boys. *J Pediatr* 127:100–102
- Bouligand J, Gervan C, Tello JA, Brailly-Tabard S, Salenave S, Chanson P, Lombès M, Millar RP, Guiochon-Mantel A, Young J (2009) Isolated familial hypogonadotropic hypogonadism and a GNRH1 mutation. *N Engl J Med* 360:2742–2748
- Bouloux P, Warne DW, Loumaye E, FSH Study Group in Men's Infertility (2002) Efficacy and safety of recombinant human follicle-stimulating hormone in men with isolated hypogonadotropic hypogonadism. *Fertil Steril* 77:270–273
- Brown DC, Butler GE, Kelnar CJ, Wu FC (1995) A double blind, placebo controlled study of the effects of low dose testosterone undecanoate on the growth of small for age, prepubertal boys. *Arch Dis Child* 73:131–135
- Büchter D, Behre HM, Kliesch S, Nieschlag E (1998) Pulsatile GnRH or human chorionic gonadotropin/human menopausal gonadotropin as effective treatment for men with hypogonadotropic hypogonadism: a review of 42 cases. *Eur J Endocrinol* 139:298–303
- Budarf ML, Emanuel BS (1997) Progress in the autosomal segmental aneusomy syndromes (SASs): single or multi-locus disorders? *Hum Molec Genet* 6:1657–1665
- Burghes AH, Vaessin HE, de La Chapelle A (2001) The land between Mendelian and multifactorial inheritance. *Science* 293:2213–2214

- Burgues S, Calderon MD (1997) Subcutaneous self-administration of highly purified follicle stimulating hormone and human chorionic gonadotrophin for the treatment of male hypogonadotropic hypogonadism. Spanish Collaborative Group on Male Hypogonadotropic Hypogonadism. *Hum Reprod* 12:980–986
- Burman P, Ritzen EM, Lindgren C (2001) Endocrine dysfunction in Prader-Willi syndrome: a review with special reference to GH. *Endocr Rev* 22:787–799
- Butenandt O, Bechtold S, Meidert A (2005) Final height in patients with constitutional delay of growth and development from tall statured families. *J Pediatr Endocrinol Metab* 18:165–169
- Butler JV, Whittington JE, Holland AJ, Boer H, Clark D, Webb T (2002) Prevalence of, and risk factors for, physical ill-health in people with Prader-Willi syndrome: a population-based study. *Dev Med Child Neurol* 44:248–255
- Cacciari E, Salardi S, Lazzari R (1983) Short stature and celiac disease: a relationship to consider even in patients with no gastrointestinal tract symptoms. *J Pediatr* 103:708–711
- Cannavo S, Curto L, Squadrito S, Almoto B, Vieni A, Trimarchi F (1999) Cabergoline: a first-choice treatment in patients with previously untreated prolactin-secreting pituitary adenoma. *J Endocrinol Invest* 22:354–359
- Caron P, Imbeaud S, Bennet A, Plantavid M, Camerino G, Rochiccioli P (1999a) Combined hypothalamic-pituitary-gonadal defect in a hypogonadic man with a novel mutation in the DAX-1 gene. *J Clin Endocrinol Metab* 84:3563–3569
- Caron P, Chauvin S, Christin-Maitre S, Bennet A, Lahlou N, Counis R, Bouchard P, Kottler M-L (1999b) Resistance of hypogonadic patients with mutated GnRH receptor genes to pulsatile GnRH administration. *J Clin Endocrinol Metab* 84:990–996
- Casanueva FF, Molitch ME, Schlechte JA, Abs R, Bonert V, Bronstein MD, Brue T, Cappabianca P, Colao A, Fahlbusch R, Fideleff H, Hadani M, Kelly P, Kleinberg D, Laws E, Marek J, Scanlon M, Sobrinho LG, Wass JA, Giustina A (2006) Guidelines of the Pituitary Society for the diagnosis and management of prolactinomas. *Clin Endocrinol* 65:265–273
- Cassidy SB (1997) Prader-Willi syndrome. *J Med Genet* 34:917–923
- Chaidarun SS, Klibanski A (2002) Gonadotropinomas. *Semin Reprod Med* 20:339–348
- Chan YM, de Guillebon A, Lang-Muritano M, Plummer L, Cerrato F, Tsiaras S, Gaspert A, Lavoie HB, Wu CH, Crowley WF Jr, Amory JK, Pitteloud N, Seminara SB (2009) GNRH1 mutations in patients with idiopathic hypogonadotropic hypogonadism. *Proc Natl Acad Sci USA*. 106:11703–11708
- Colao A, Di Sarno A, Cappabianca P, Di Somma C, Pivonello R, Lombardi G (2003) Withdrawal of long-term cabergoline therapy for tumoral and nontumoral hyperprolactinemia. *N Engl J Med* 349:2023–2033
- Colao A, Galderisi M, Di Sarno A, Pardo M, Gaccione M, D'Andrea M, Guerra E, Pivonello R, Lerro G, Lombardi G (2008) Increased prevalence of tricuspid regurgitation in patients with prolactinomas chronically treated with cabergoline. *J Clin Endocrinol Metab* 93:3777–3784
- Constine LS, Woolf PD, Cann D, Mick G, McCormick K, Raubertas RF, Rubin P (1993) Hypothalamic-pituitary dysfunction after radiation for brain tumors. *N Engl J Med* 328:87–94
- Crino A, Schiaffini R, Ciampalini P, Spera S, Beccaria L, Benzi F, Bosio L, Corrias A, Gargantini L, Salvatoni A, Tonini G, Trifiro G, Livieri C, Genetic obesity study group of Italian Society of Pediatric Endocrinology and Diabetology (SIEDP) (2003) Hypogonadism and pubertal development in Prader-Willi-syndrome. *Eur J Pediatr* 162:327–333
- De Luca F, Argente J, Cavallo L, Crowne E, Delemarre-Van de Waal HA, De Sanctis C, Di Maio S, Norjavaara E, Oostdijk W, Severi F, Tonini G, Trifiro G, Voorhoeve PG, Wu F, International Workshop on Management of Puberty for Optimum Auxological Results (2001) Management of puberty in constitutional delay of growth and puberty. *J Pediatr Endocrinol Metab* 14(2):953–957
- De Michele G, Filla A, Striano S, Rimoldi M, Campanella G (1993) Heterogenous findings in four cases of cerebellar ataxia associated with hypogonadism (Holmes' type ataxia). *Clin Neurol Neurosurg* 95:23–28
- De Rosa M, Colao A, Di Sarno A, Ferone D, Landi ML, Zarrilli S, Paesano L, Merola B, Lombardi G (1998) Cabergoline treatment rapidly improves gonadal function in hyperprolactinemic males: a comparison with bromocriptine. *Eur J Endocrinol* 138:286–293
- De Roux N (2005) Isolated gonadotropic deficiency with and without anosmia: a developmental defect or a neuroendocrine regulation abnormality of the gonadotropic axis. *Horm Res* 64(2):48–55
- Deladoey J, Flück C, Büyükgebiz A, Kuhlmann BV, Eblé A, Hindmarsh PC, Wu W, Mullis PE (1999) "Hot spot" in the PRO1 gene responsible for combined pituitary hormone deficiency. *J Clin Endocrinol Metab* 84:1645–1650
- Depenbusch M, von Eckardstein S, Simoni M, Nieschlag E (2002) Maintenance of spermatogenesis in hypogonadotropic hypogonadal men with hCG alone. *Eur J Endocrinol* 147:617–624
- Dittrich B, Buiting K, Korn B, Rickard S, Buxton J, Saitoh S, Nicholls RD, Poustka A, Winterpacht A, Zabel B, Horsthemke B (1996) Imprint switching on human chromosome 15 may involve alternative transcripts of the SNRPN gene. *Nat Genet* 14:163–170
- Dodé C, Hardelin JP (2004) Kallmann syndrome: fibroblast growth factor signaling insufficiency? *J Mol Med* 82:725–734
- Dodé C, Levilliers J, Dupont JM, De Paepe A, Le Dû N, Soussi-Yanicostas N, Coimbra RS, Delmaghani S, Compain-Nouaille S, Baverel F, Pêcheux C, Le Tessier D, Cruaud C, Delpech M, Speleman F, Vermeulen S, Amalfitano A, Bachelot Y, Bouchard P, Cabrol S, Carel JC, Delemarre-van de Waal H, Goulet-Salmon B, Kottler ML, Richard O, Sanchez-Franco F, Saura R, Young J, Petit C, Hardelin JP (2003) Loss-of-function mutations in FGFR1 cause autosomal dominant Kallmann syndrome. *Nat Genet* 33:463–465
- Dodé C, Teixeira L, Levilliers J, Fouveaut C, Bouchard P, Kottler ML, Lespinasse J, Lienhardt-Roussie A, Mathieu M, Moerman A, Morgan G, Murat A, Toubanc JE, Wolczynski S, Delpech M, Petit C, Young J, Hardelin JP (2006) Kallmann syndrome: mutations in the genes encoding prokineticin-2 and prokineticin receptor-2. *PLoS Genet* 2:e175
- Eiholzer U, Whitman BY (2004) A comprehensive team approach to the management of patients with Prader-Willi syndrome. *J Pediatr Endocrinol Metab* 17:1153–1175

- Eiholzer U, l'Allemand D, Rousson V, Schlumpf M, Gasser T, Girard J, Grüters A, Simoni M (2006) Hypothalamic and gonadal components of hypogonadism in boys with Prader-Labhart-Willi syndrome. *J Clin Endocrinol Metab* 91: 892–898
- Eiholzer U, Grieser J, Schlumpf M, l'Allemand D (2007) Clinical effects of treatment for hypogonadism in male adolescents with Prader-Labhart-Willi syndrome. *Horm Res* 68:178–184
- European Metrodin HP Study Group (1998) Efficacy and safety of highly purified urinary follicle-stimulating hormone with human chorionic gonadotropin for treating men with isolated hypogonadotropic hypogonadism. *Fertil Steril* 70: 256–262
- Falardeau J, Chung WC, Beenken A, Raivio T, Plummer L, Sidis Y, Jacobson-Dickman EE, Eliseenkova AV, Ma J, Dwyer A, Quinton R, Na S, Hall JE, Huot C, Alois N, Pearce SH, Cole LW, Hughes V, Mohammadi M, Tsai P, Pitteloud N (2008) Decreased FGF8 signaling causes deficiency of gonadotropin-releasing hormone in humans and mice. *J Clin Invest* 118:2822–2831
- Flück C, Deladoey J, Rutishauser K, Eblé A, Marti U, Wu W, Mullis PE (1998) Phenotypic variability in familial combined pituitary hormone deficiency caused by a PROP1 gene mutation resulting in the substitution of Arg → Cys at codon 120 (R120C). *J Clin Endocrinol Metab* 83:3727–3734
- Gillam MP, Molitch ME, Lombardi G, Colao A (2006) Advances in the treatment of prolactinomas. *Endocr Rev* 27:485–534
- Gillessen-Kaesbach G, Gross S, Kaya-Westerloh S, Passarge E, Horsthemke B (1995) DNA methylation based testing of 450 patients suspected of having Prader-Willi syndrome. *J Med Genet* 32:88–92
- Goldstone AP, Holland AJ, Hauffa BP, Hokken-Koelega AC, Tauber M, on behalf of speakers and contributors at the Second Expert Meeting of the Comprehensive Care of Patients with PWS (2008) Recommendations for the diagnosis and management of Prader-Willi syndrome. *J Clin Endocrinol Metab* 93:4183–4197
- Green JS, Parfrey PS, Harnett JD, Farid NR, Cramer BC, Johnson G, Heath O, McManamon PJ, O'Leary E, Pryse-Phillips W (1989) The cardinal manifestations of Bardet-Biedl syndrome, a form of Laurence-Moon-Biedl syndrome. *N Engl J Med* 321:1002–1009
- Greulich WW, Pyle SI (1959) Radiographic atlas of skeletal development of the hand and wrist, 2nd edn. Stanford University Press, Stanford, CA
- Gunay-Aygun M, Schwartz S, Hegger S, O'Riordan MA, Cassidy S (2001) The changing purpose of Prader-Willi syndrome clinical diagnostic criteria and proposed revised criteria. *Pediatrics* 108:e92
- Habiby RL, Boepple P, Nachtigall L, Sluss PM, Crowley WF, Jameson JL (1996) Adrenal hypoplasia congenita with hypogonadotropic hypogonadism: evidence that DAX-1 mutations lead to combined hypothalamic and pituitary defects in gonadotropin production. *J Clin Invest* 98:1055–1062
- Herring N, Szmigielski C, Becher H, Karavitaki N, Wass JA (2009) Valvular heart disease and the use of cabergoline for the treatment of prolactinoma. *Clin Endocrinol* 70:104–108
- Holm VA, Cassidy SB, Butler MG, Hanchett JM, Greenswag LR, Whitman BY, Greenberg F (1993) Prader-Willi syndrome consensus diagnostic criteria. *Pediatrics* 91:398–402
- Houchin LD, Rogol AD (1998) Androgen replacement in children with constitutional delay of puberty: the case for aggressive therapy. *Bailliere Clin Endoc* 12:427–440
- Jaffe CA (2006) Clinically non-functioning pituitary adenoma. *Pituitary* 9:317–321
- Kaisermann KB, Nakamoto JM, Geffner ME, McCabe ER (1998) Minipuberty of infancy and adolescent pubertal function in adrenal hypoplasia congenita. *J Pediatr* 133:300–302
- Kallmann FJ, Schoenfeld WA, Barrera SE (1944) The genetic aspects of primary eunuchoidism. *Amer J Ment Defic* 48:203–236
- Karavitaki N, Thanabalasingham G, Shore HC, Trifanescu R, Ansong O, Meston N, Turner HE, Wass JA (2006) Do the limits of serum prolactin in disconnection hyperprolactinaemia need re-definition? A study of 226 patients with histologically verified non-functioning pituitary macroadenoma. *Clin Endocrinol* 65:524–529
- Kars M, Pereira AM, Bax JJ, Romijn JA (2008) Cabergoline and cardiac valve disease in prolactinoma patients: additional studies during long-term treatment are required. *Eur J Endocrinol* 159:363–367
- Kaspers S, Richter-Unruh A, Schmittmann-Ohters K, Hauffa BP (2004) Buserelin testing in 70 adolescents with delayed puberty. *Horm Res* 62(2):80(P2–282)
- Katsanis N (2004) The oligogenic properties of Bardet-Biedl syndrome. *Hum Mol Genet* 13 Spec No 1:R65–71
- Kauschansky A, Dickerman Z, Phillip N, Weintrob N, Strich D (2002) Use of GnRH agonist and human chorionic gonadotrophin tests for differentiating constitutional delayed puberty from gonadotrophin deficiency in boys. *Clin Endocrinol* 56:603–607
- Kelberman D, Dattani MT (2008) Septo-optic dysplasia - novel insights into the aetiology. *Horm Res* 69:257–265
- Kelch RP, Virdis R, Rappaport R, Greig F, Levine LS, New MI (1984) Congenital adrenal hypoplasia. *Pediatr Adolesc Endocrinol* 13:156–161
- Kelly BP, Paterson WF, Donaldson MD (2003) Final height outcome and value of height prediction in boys with constitutional delay in growth and adolescence treated with intramuscular testosterone 125 mg per month for 3 months. *Clin Endocrinol* 58:267–272
- Kim HG, Kurth I, Lan F, Melicani I, Wenzel W, Eom SH, Kang GB, Rosenberger G, Tekin M, Ozata M, Bick DP, Sherins RJ, Walker SL, Shi Y, Gusella JF, Layman LC (2008) Mutations in CHD7, Encoding a chromatin-remodeling protein, cause idiopathic hypogonadotropic hypogonadism and Kallmann syndrome. *Am J Hum Genet* 83:511–519
- Kletter GB, Gorski JL, Kelch RP (1991) Congenital adrenal hypoplasia and isolated gonadotropin deficiency. *Trends Endocrinol Metab* 2:123–128
- Koeppen AH (1998) The hereditary ataxias. *J Neuropathol Exp Neurol* 57:531–543
- Krajewska-Siuda E, Malecka-Tendera E, Krajewski-Siuda A (2006) Are short boys with constitutional delay of growth and puberty candidates for rGH therapy according to FDA recommendations? *Horm Res* 65:192–196
- Lagerström-Fermér M, Sundvall M, Johnsen E, Warne GL, Forrest SM, Zajac JD, Rickards A, Ravine D, Landegren U, Pettersson U (1997) X-linked recessive panhypopituitarism associated with a regional duplication in Xq25-q26. *Am J Hum Genet* 60:910–916

- Lalli E, Sassone-Corsi P (2003) DAX-1, an unusual orphan receptor at the crossroads of steroidogenic function and sexual differentiation. *Mol Endocrinol* 17:1445–1453
- Largo RH, Prader A (1983) Pubertal development of Swiss boys. *Helv Paediatr Acta* 38: 211–228
- Lindgren AC, Lindberg A (2008) Growth hormone treatment completely normalizes adult height and improves body composition in Prader-Willi syndrome: experience from KIGS (Pfizer International Growth Database). *Horm Res* 70:182–187
- Liu L, Chaudhari N, Corle D, Sherins RJ (1988) Comparison of pulsatile subcutaneous gonadotropin-releasing hormone and exogenous gonadotropins in the treatment of men with isolated hypogonadotropic hypogonadism. *Fertil Steril* 49:302–308
- Liu PY, GebSKI VJ, Turner L, Conway AJ, Wishart SM, Handelsman DJ (2002) Predicting pregnancy and spermatogenesis by survival analysis during gonadotrophin treatment of gonadotrophin-deficient infertile men. *Hum Reprod* 17:625–633
- Lofrano-Porto A, Casulari LA, Nascimento PP, Giacomini L, Naves LA, da Motta LD, Layman LC (2008) Effects of follicle-stimulating hormone and human chorionic gonadotropin on gonadal steroidogenesis in two siblings with a follicle-stimulating hormone beta subunit mutation. *Fertil Steril* 90:1169–1174
- Mancini T, Casanueva FF, Giustina A. Hyperprolactinemia and prolactinomas (2008) *Endocrinol Metab Clin North Am* 37:67–99
- Mantovani G, Borgato S, Beck-Peccoz P, Romoli R, Borretta G, Persani L (2003) Isolated follicle-stimulating hormone (FSH) deficiency in a young man with normal virilization who did not have mutations in the FSHbeta gene. *Fertil Steril* 79:434–436
- Mehta A, Dattani MT (2008) Developmental disorders of the hypothalamus and pituitary gland associated with congenital hypopituitarism. *Best Pract Res Clin Endocrinol Metab* 22:191–206
- Melmed S (2008) Update in pituitary disease. *J Clin Endocrinol Metab* 93:331–338
- Merke DP, Tajima T, Baron J, Cutler GB (1999) Hypogonadotropic hypogonadism in a female caused by an X-linked recessive mutation in the DAX1 gene. *N Engl J Med* 340:1248–1252
- Morison IM, Reeve AE (1998) A catalogue of imprinted genes and parent-of-origin effects in humans and animals. *Hum Molec Genet* 7:1599–1609
- Muscattelli F, Strom TM, Walker AP, Zanaria E, Récan D, Meindl A, Bardoni B, Guioli S, Zehetner G, Rabl W, Schwarz HP, Kaplan JC, Camerino G, Meitinger T, Monaco AP (1994) An unusual member of the nuclear hormone receptor superfamily responsible for X-linked adrenal hypoplasia congenita. *Nature* 372:672–676
- Ohta T, Gray TA, Rogan PK, Buiting K, Gabriel JM, Saitoh S, Muralidhar B, Bilienska B, Krajewska-Walasek M, Driscoll DJ, Horsthemke B, Butler MG, Nicholls RD (1999) Imprinting-mutation mechanisms in Prader-Willi syndrome. *Am J Hum Genet* 64:397–413
- Okuhara K, Abe S, Kondo T, Fujita K, Koda N, Mochizuki K, Fujieda K, Tajima T (2008) Four Japanese patients with adrenal hypoplasia congenita and hypogonadotropic hypogonadism caused by DAX-1 gene mutations: mutant DAX-1 failed to repress steroidogenic acute regulatory protein (StAR) and luteinizing hormone beta-subunit gene promoter activity. *Endocr J* 55: 97–103
- Partsch C-J, Sippell WG (1989) Hypothalamic hypogonadism in congenital adrenal hypoplasia. *Horm Metab Res* 11: 623–625
- Partsch C-J, Hermanussen M, Sippell WG (1985) Differentiation of male hypogonadotropic hypogonadism and constitutional delay of puberty by pulsatile administration of gonadotropin-releasing hormone. *J Clin Endocrinol Metab* 60: 1196–1203
- Partsch C-J, Hümmelink R, Sippell WG (1990) Reference ranges for lutropin and follitropin in the luteal test in prepubertal and pubertal children using a monoclonal immunoradiometric assay. *J Clin Chem Clin Biochem* 28:49–52
- Partsch C-J, Lämmer C, Gillesen-Kaesbach G, Pankau R (2000) Adult patients with Prader-Willi syndrome: clinical characteristics, life circumstances and growth hormone secretion. *Growth Horm IGF Res* 10(Suppl B):S81–S85
- Pasqualini RQ, Burr GE (1950) Síndrome hipoadrogénica con gametogénesis conservada. Clasificación del la insuficiencia testicular. *Rev Asoc Med Argent* 64:6–19
- Peter M, Viemann M, Partsch C-J, Sippell WG (1998) Congenital adrenal hypoplasia: clinical spectrum, experience with hormonal diagnosis, and report on new points mutations of the DAX-1-Gene. *J Clin Endocrinol Metab* 83:2666–2674
- Pitteloud N, Boepple PA, DeCruz S, Valkenburgh SB, Crowley WF Jr, Hayes FJ (2001) The fertile eunuch variant of idiopathic hypogonadotropic hypogonadism: spontaneous reversal associated with a homozygous mutation in the gonadotropin-releasing hormone receptor. *J Clin Endocrinol Metab* 86:2470–2475
- Pitteloud N, Acierno JS Jr, Meysing AU, Dwyer AA, Hayes FJ, Crowley WF Jr (2005) Reversible Kallmann syndrome, delayed puberty, and isolated anosmia occurring in a single family with a mutation in the fibroblast growth factor receptor 1 gene. *J Clin Endocrinol Metab* 90:1317–1322
- Poyrazoglu S, Günöz H, Drendeliler F, Saka N, Bundak R, Bas F (2005) Constitutional delay of growth and puberty: from presentation to final height. *J Pediatr Endocrinol Metab* 18: 171–179
- Prader A, Labhart A, Willi H (1956) Ein Syndrom von Adipositas, Kleinwuchs, Kryptorchismus und Oligophrenie nach myoatonieartigem Zustand im Neugeborenenalter. *Schweiz Med Wschr* 86:1260–1261
- Quinton R, Barnett P, Coskeran P, Bouloux PM (1999) Gordon Holmes spinocerebellar ataxia: a gonadotrophin deficiency syndrome resistant to treatment with pulsatile gonadotropin-releasing hormone. *Clin Endocrinol* 51:525–529
- Raivio T, Falardeau J, Dwyer A, Quinton R, Hayes FJ, Hughes VA, Cole LW, Pearce SH, Lee H, Boepple P, Crowley WF Jr, Pitteloud N (2007) Reversal of idiopathic hypogonadotropic hypogonadism. *N Engl J Med* 357:863–873
- Rosenbloom AL, Almonte SA, Brown MR, Fisher DA, Baumbach L, Parks JS (1999) Clinical and biochemical phenotype of familial anterior hypopituitarism from mutations of the PROP1 gene. *J Clin Endocrinol Metab* 84:50–57
- Rump P, Hamel BCJ, Pinckers AJLG, van Dop PA (1997) Two sibs with chorioretinal dystrophy, hypogonadotropic hypogonadism, and cerebellar ataxia: Boucher-Neuhäuser syndrome. *J Med Genet* 34:767–771

- Saeger W, Lüdecke DK, Buchfelder M, Fahlbusch R, Quabbe HJ, Petersenn S (2007) Pathohistological classification of pituitary tumors: 10 years of experience with the German Pituitary Tumor Registry. *Eur J Endocrinol* 156:203–216
- Sampson JR, Tolmie JL, Cant JS (1989) Oliver McFarlane syndrome: a 25-year follow-up. *Am J Med Genet* 34:199–201
- Schlechte JA (2003) Clinical practice. Prolactinoma. *N Engl J Med* 349:2035–2041
- Schlechte JA (2007) Long-term management of prolactinoma. *J Clin Endocrinol Metab* 92:2861–2865
- Schmidt H, Knorr D, Schwarz HP (1998) Oral testosterone undecanoate for the induction of puberty in anorchid boys. *Arch Dis Child* 78:395
- Schopohl J, Mehlretter G, von Zumbusch R, Eversmann T, von Werder K (1991) Comparison of gonadotropin-releasing hormone and gonadotropin therapy in male patients with idiopathic hypothalamic hypogonadism. *Fertil Steril* 56:1143–1150
- Schwanzel-Fukuda M, Bick D, Pfaff DW (1989) Luteinizing hormone-releasing hormone (LHRH)-expressing cells do not migrate normally in an inherited hypogonadal (Kallmann) syndrome. *Mol Brain Res* 6:311–326
- Sedlmeyer IL, Palmert MR (2002) Delayed puberty: analysis of a large case series from an academic center. *J Clin Endocrinol Metab* 87:1613–1620
- Sedlmeyer IL, Hirschhorn JN, Palmert MR (2002) Pedigree analysis of constitutional delay of growth and maturation: determination of familial aggregation and inheritance patterns. *J Clin Endocrinol Metab* 87:5581–5586
- Seminara SB, Hayes FJ, Crowley WF (1998) Gonadotropin-releasing hormone deficiency in the human (idiopathic hypogonadotropic hypogonadism and Kallmann's syndrome): pathophysiological and genetic considerations. *Endocr Rev* 19:521–539
- Seminara SB, Acierna JS Jr, Abdulwahid NA, Crowley WF Jr, Marglin DH (2002) Hypogonadotropic hypogonadism and cerebellar ataxia: detailed phenotypic characterization of a large, extended kindred. *J Clin Endocrinol Metab* 87:1607–1612
- Sherlock M, Toogood AA, Steeds R (2009) Dopamine agonist therapy for hyperprolactinaemia and cardiac valve fibrosis; a lot done but much more to do. *Heart* [Epub ahead of print]
- Sinisi AA, Esposito D, Maione L, Quinto MC, Visconti D, De Bellis A, Bellastella A, Conzo G, Bellastella G (2008) Seminal anti-Müllerian hormone level is a marker of spermatogenic response during long-term gonadotropin therapy in male hypogonadotropic hypogonadism. *Hum Reprod* 23:1029–1034
- Smals AGH, Hermus ARM, Boers GHJ, Pieters GFF, Benraad TJ, Kloppenborg PWC (1994) Predictive value of luteinizing hormone releasing hormone (LHRH) bolus testing before and after 36-hour pulsatile LHRH administration in the differential diagnosis of constitutional delay of puberty and male hypogonadotropic hypogonadism. *J Clin Endocrinol Metab* 78:602–608
- Soliman AT, Rajab A, AlSalmi I, Asfour MG (1996) Empty sellae, impaired testosterone secretion, and defective hypothalamic-pituitary growth and gonadal axes in children with Bardet-Biedl syndrome. *Metabolism* 45:1230–1234
- Solomon NM, Ross SA, Morgan T, Belsky JL, Hol FA, Karnes PS, Hopwood NJ, Myers SE, Tan AS, Warne GL, Forrest SM, Thomas PQ (2004) Array comparative genomic hybridisation analysis of boys with X linked hypopituitarism identifies a 3.9Mb duplicated critical region at Xq27 containing SOX3. *J Med Genet* 41:669–678
- Spratt DI, Carr DB, Merriam GR, Scully RE, Rao PN, Crowley WF Jr (1987) The spectrum of abnormal patterns of gonadotropin-releasing hormone secretion in men with idiopathic hypogonadotropic hypogonadism: clinical and laboratory correlations. *J Clin Endocrinol Metab* 64:283–291
- Stoetzel C, Muller J, Laurier V, Davis EE, Zaghoulou NA, Vicaire S, Jacquelin C, Plewniak F, Leitch CC, Sarda P, Hamel C, de Ravel TJ, Lewis RA, Friederich E, Thibault C, Danse JM, Verloes A, Bonneau D, Katsanis N, Poch O, Mandel JL, Dollfus H (2007) Identification of a novel BBS gene (BBS12) highlights the major role of a vertebrate-specific branch of chaperonin-related proteins in Bardet-Biedl syndrome. *Am J Hum Genet* 80:1–11
- Takahashi T, Shoji Y, Haraguchi N, Takahashi I, Takada G (1997) Active hypothalamic-pituitary-gonadal axis in an infant with X-linked adrenal hypoplasia congenita. *J Pediatr* 130:485–488
- Topaloglu AK, Reimann F, Guclu M, Yalin AS, Kotan LD, Porter KM, Serin A, Mungan NO, Cook JR, Ozbek MN, Imamoglu S, Akalin NS, Yuksel B, O'Rahilly S, Semple RK (2009) TAC3 and TACR3 mutations in familiar hypogonadotropic hypogonadism reveal a key role for Neurokinin B in the central control of reproduction. *Nat Genet*. 41:354–358
- Vogels A, Moerman P, Frijns JP, Bogaert GA (2008) Testicular histology in boys with Prader-Willi syndrome: fertile or infertile? *J Urol* 180(4):1800–1804
- Warne DW, Decosterd G, Okada H, Yano Y, Koide N, Howles CM (2008) A combined analysis of data to identify predictive factors for spermatogenesis in men with hypogonadotropic hypogonadism treated with recombinant human follicle-stimulating hormone and human chorionic gonadotropin. *Fertil Steril* [Epub ahead of print]
- Wehkalampi K, Vangonen K, Laine T, Dunkel L (2007) Progressive reduction of relative height in childhood predicts adult stature below target height in boys with constitutional delay of growth and puberty. *Horm Res* 68:99–104
- Wehkalampi K, Widen E, Laine T, Palotie A, Dunkel L (2008a) Patterns of inheritance of constitutional delay of growth and puberty in families of adolescent girls and boys referred to specialist pediatric care. *J Clin Endocrinol Metab* 93:723–728
- Wehkalampi K, Widen E, Laine T, Palotie A, Dunkel L (2008b) Association of the timing of puberty with a chromosome 2 locus. *J Clin Endocrinol Metab* [Epub ahead of print]
- Willers B, Engelhardt L, Pelz L (1996) Sexual maturation in East German boys. *Acta Paediatr* 85:785–788
- Willnow S, Kiess W, Butenandt O, Dörr HG, Enders A, Strasser-Vogel B, Egger J, Schwarz HP (1996) Endocrine disorders in septo-optic dysplasia (De Morsier syndrome) – evaluation and follow up of 18 patients. *Eur J Pediatr* 155:179–184
- Wilson DA, Hofman PL, Miles HL, Unwin KE, McGrail CE, Cutfield WS (2006) Evaluation of the buserelin stimulation test in diagnosing gonadotropin deficiency in males with delayed puberty. *J Pediatr* 148:89–94
- Wollmann HA, Schultz U, Grauer ML, Ranke MB (1998) Reference values for height and weight in Prader-Willi syndrome based on 315 patients. *Eur J Pediatr* 157:634–642
- Young J, Rey R, Schaison G, Chanson P (2003) Hypogonadotropic hypogonadism as a model of post-natal testicular anti-Müllerian

- hormone secretion in humans. *Mol Cell Endocrinol* 211: 51–54
- Zanaria E, Muscatelli F, Bardoni B, Strom TM, Guioli S, Weiwen G, Lalli E, Moser C, Walker AP, McCabe ERB, Meitinger T, Monaco AP, Sassone-Corsi P, Camerino G (1994) An unusual member of the nuclear hormone receptor superfamily responsible for X-linked adrenal hypoplasia congenita. *Nature* 372:635–641
- Zanettini R, Antonini A, Gatto G, Gentile R, Tesei S, Pezzoli G (2007) Valvular heart disease and the use of dopamine agonists for Parkinson's disease. *N Engl J Med* 356: 39–46

Contents

13.1 Anorchia	194	13.7.3 Diagnosis	208
13.1.1 Congenital Anorchia	194	13.7.4 Therapy	208
13.1.2 Acquired Anorchia	195	13.8 Specific Structural Sperm Defects	208
13.2 Polyorchidism	197	13.8.1 Globozoospermia	208
13.3 Maldescended Testes	197	13.8.2 9 + 0 Syndrome	209
13.3.1 Pathophysiology and Classification	197	13.8.3 Syndrome of Immotile Cilia	209
13.3.2 Infertility and Risk of Malignancy	198	13.8.4 Clinical Picture	209
13.3.3 Diagnosis	199	13.8.5 Diagnosis	209
13.3.4 Therapy	199	13.8.6 Therapy	209
13.4 Varicocele	200	13.9 Klinefelter Syndrome	210
13.4.1 Pathophysiology	200	13.9.1 Incidence and Etiology	210
13.4.2 Prevalence and Influence of Varicocele on Fertility	201	13.9.2 Clinical Picture	211
13.4.3 Clinical Picture	201	13.9.3 Diagnosis	212
13.4.4 Diagnosis	202	13.9.4 Therapy	213
13.4.5 Influence of Therapy on Fertility	202	13.10 XX Male Syndrome	214
13.4.6 Meta-analysis of Studies on Treatment	204	13.11 XYY Syndrome	216
13.4.7 Treatment Modalities	204	13.12 Noonan Syndrome	216
13.4.8 Varicocele in Adolescence	205	13.13 Structural Chromosome Abnormalities	216
13.5 Orchitis	206	13.13.1 Structural Abnormalities of Sex Chromosomes	217
13.5.1 Clinical Picture and Diagnosis	206	13.13.2 Y Chromosome Microdeletions	218
13.5.2 Therapy	206	13.13.3 Structural Abnormalities of the Autosomes	220
13.6 Germ Cell Aplasia (SCO Syndrome)	206	13.14 Oviduct Persistence	220
13.6.1 Pathophysiology	206	13.15 Gonadal Dysgenesis	221
13.6.2 Clinical Picture and Diagnosis	207	13.15.1 Definition	221
13.6.3 Therapy	207	13.15.2 Clinical Picture	221
13.7 Spermatogenic Arrest	207	13.15.3 Diagnosis	221
13.7.1 Pathophysiology	207	13.15.4 Therapy	222
13.7.2 Clinical Picture	208	13.16 46,XY Disorders of Sexual Development (DSD) due to Disturbed Testosterone Synthesis	222
		13.16.1 Definition	222
		13.16.2 Etiology	222
		13.16.3 Clinical Picture	222
		13.16.4 Diagnosis	223
		13.16.5 Therapy	223

E. Nieschlag (✉)
Centre of Reproductive Medicine and Andrology
of the University, Domagkstr. 11, D-48149 Münster, Germany
e-mail: Eberhard.Nieschlag@ukmuenster.de

13.17 Mutations of Gonadotropin Receptors	224
13.17.1 Inactivating LH Receptor Mutations: Leydig Cell Hypoplasia	224
13.17.2 Activating LH Receptor Mutations.....	225
13.17.3 Inactivating FSH Receptor Mutations	225
13.17.4 Activating FSH Receptor Mutations.....	226
13.18 Ovotesticular Disturbances of Sexual Development (DSD)	226
13.18.1 Definition and Etiology	226
13.18.2 Clinical Picture	226
13.18.3 Diagnosis	226
13.18.4 Therapy	226
13.19 Testicular Tumors	227
13.19.1 Incidence.....	227
13.19.2 Testicular Intraepithelial Neoplasia (TIN).....	227
13.19.3 Germ Cell Tumors	228
13.19.4 Testicular Tumors with Endocrine Activity	231
References	231

13.1 Anorchia

Unilateral or bilateral absence of testicular tissue in genetic males is called **anorchia**. Anorchia has to be differentiated from partial or complete testicular atrophy, e.g., following torsion or orchitis, when, at least histologically, degenerated remains of a male gonad can be found. Anorchia can be congenital or acquired.

13.1.1 Congenital Anorchia

Bilateral congenital anorchia occurs only in one of 20,000 males. **Unilateral congenital anorchia** is about four times as frequent. Vascular and genetic disturbances, intrauterine infections, trauma or teratogenic factors are discussed as causes for the loss of one or both testes. A suspected abnormality in the sex-determining region of the Y chromosome, the SRY gene, could not be confirmed so far (Lobacarro et al. 1993). Nor could mutations in other genes responsible for testicular development and descent be clearly identified to date (Vinci et al. 2004; Philibert et al. 2007). Currently **intrauterine torsion** is favored as the most probable cause.

The morphological findings in bilateral congenital anorchia can be directly derived from the embryonic development of the male genital system. In the 8th week of pregnancy the testes developing from the undifferentiated gonadal system start to secrete anti-Muellerian hormone (AMH) and, only at a later stage, testosterone. If the testicular tissue is lost before testosterone production begins, the Muellierian ducts have regressed; however, the androgen-dependent differentiation of the Wolffian ducts as well as the masculinization of the urogenital sinus and the external genitalia have not yet started. If the testes originally present are destroyed after they have produced testosterone for a certain period, the androgen-dependent target organs of the urogenital tract are more or less completely differentiated towards the male phenotype (Josso et al. 2006).

Subjects with **bilateral congenital anorchia**, in whom the testes had produced AMH but no testosterone, present with the **phenotype of male pseudohermaphroditism** including female external genitalia. Neither gonads nor derivatives of the Muellierian ducts

(oviducts, uterus, upper vagina) nor the Wolffian ducts (epididymis, ductus deferens, seminal vesicles) can be found. If the testes have produced testosterone during embryonal development, the external genitalia are male and the Wolffian duct derivatives are developed. A small penis may indicate diminished androgen-dependent growth during fetal development. If left untreated, pubertal development will not start in patients with bilateral congenital anorchia and the typical phenotype of **eunuchoidism** develops. Since a single intact testis is functionally sufficient, disorders of sexual differentiation and pubertal development do not occur in **congenital unilateral anorchia** although unilateral retention of Mullerian ducts can be present (depending on timing of testicular loss).

13.1.1.1 Diagnosis

In patients with **congenital bilateral anorchia** testicular tissue cannot be demonstrated either by morphological or by endocrine techniques (see Chap. 6). FSH and LH serum levels may already be elevated in children and rise to castrate levels from the age of puberty onwards. In contrast, testosterone is very low. For a **differential diagnosis** cryptorchidism must be ruled out (see Sect. 13.3). The **hCG-test** is used for differentiation (see Chap. 7). While a rise in serum testosterone can be measured in patients with cryptorchidism, the values remain low even after a 7-day period of stimulation in patients with bilateral anorchia (Davenport et al. 1995; McEachern et al. 2004). In addition, AMH, which is lacking in anorchia, should be measured since it shows a higher sensitivity, but equal specificity compared to testosterone (Lee et al. 1997). In cases with suspected **unilateral anorchia** the absence of gonadal tissue must be ascertained by **imaging diagnostic procedures** (sonography, computer tomography, MRT) and if necessary by **exploratory surgery/laparoscopy**, since non-descended and dysgenetic gonads have a high rate of malignant degeneration.

13.1.1.2 Therapy

Unilateral anorchia does not require therapy as long as testosterone production is sufficient. In phenotypically male patients with bilateral congenital anorchia **testosterone substitution** has to be implemented at the time of

expected puberty (see Chap. 21). In phenotypically female patients estrogen substitution will be started. Intersexual external genitalia may be corrected by **plastic surgery**. For cosmetic reasons, testicular protheses may be implanted into the scrotum. Infertility in bilateral anorchia cannot be treated.

13.1.2 Acquired Anorchia

13.1.2.1 Accidental Castration

Testes can be lost due to trauma, tumors, severe inflammation, torsion, surgical accidents (e.g., during herniotomy or orchidopexy) or surgical removal (e.g. because of a testosterone-dependent tumor such as prostate carcinoma) and very rarely after self-mutilation. The loss of one testis will be compensated for by the remaining testis if it is normal concerning fertility and testosterone production, and therapy will not be necessary. However, some authors argue in favor of removing testicular tissue remaining after treatment for torsion because in some unexplained manner the function of the remaining organ can be negatively affected (Arap et al. 2007). In cases of acute bilateral testicular loss it should be remembered that sperm may still be found weeks after the acute incident and should be cryopreserved for paternity unless the man has definitely completed his family (Fig. 13.1) (see Chap. 24).

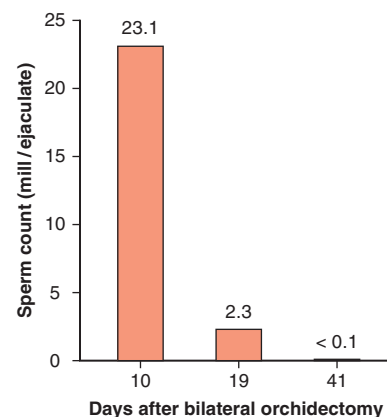

Fig. 13.1 Sperm in the ejaculate of a 15-year-old boy following bilateral orchidectomy due to delayed discovery of testicular torsion. Although several ejaculations had taken place, even 10 days after surgery (when the patient was first seen by us), enough sperm were present to make cryopreservation worthwhile

The **clinical symptoms** of bilateral testicular loss depend on the time when testicular function is lost. Before puberty, testicular loss leads to the characteristic phenotype of eunuchoidism; after puberty it will lead to the phenotype of postpubertal testosterone deficiency (see Chap. 5, Table 5.1).

When both testes are lost, **testosterone must be permanently substituted** from the time of the expected beginning of puberty in order to induce pubertal development and in an adult immediately after testicular loss to maintain the various androgen-dependent functions (see Chap. 21). Testicular protheses (usually silastic) may be implanted for psychological or cosmetic reasons.

13.1.2.2 Medical and Legal Castration

If the testes have been removed because of prostate carcinoma or as a legal prophylactic procedure in sexual delinquents, **testosterone** must certainly **not be substituted** since the elimination of its effect is the intended therapeutic purpose in these cases. In some countries castration is a legal procedure for sexual delinquency in order to avoid imprisonment. For example, in the Federal Republic of Germany 400 men were castrated between 1970 and 1980 on the basis of the “law for voluntary castration” (1969, amended 1973) (Wille 1991). In other countries this procedure is illegal. In some countries medical castration (e.g., by anti-androgens) is used instead but this is also controversial ethically. In Germany, surgical castration is currently not practised nor is chemical castration applied. Instead, psychosocial treatment modalities are preferred.

13.1.2.3 Socio-cultural Castration

Beyond medical purposes, castration has been and is still performed for socio-cultural reasons. Societies practicing polygamy have been known to employ castrates as **overseers (eunuchs as harem guards)** who may then have gained political influence. For example, at the Chinese imperial court castration consisting of amputation of penis, testes and scrotum without anesthesia was performed in adult men. These procedures were extremely painful and accompanied frequently by severe complications so that 25% of those undergoing this “treatment” did not survive. Since,

however, lucrative positions were the possible rewards, many candidates underwent the risk (Wagenseil 1993; Mitamura 1992; Wilson and Roehrborn 1999). The last castrate of the Chinese empire, terminated by revolution in 1912, Sun Yaoting, died at the age of 93 in 1996.

Castration before puberty maintains the high voice of boys so that in the adult **soprano and alto voices** with the acoustic volume of a male result. Such high-pitched voices were considered desirable among music-lovers. Prepubertal castrates belonged to casts of operas in the seventeenth and eighteenth century and in the Vatican choirs these voices could be heard until the early twentieth century (Ortkemper 1993).

Roman physicians recommended castration for the treatment of leprosy and epilepsy; in the seventeenth century it was practised to cure gout and dementia. Until the early twentieth century castration was practised in the USA for treatment of the mentally handicapped for the reason that it made them more easily manageable.

Castration has also been reported as self-mutilation for **religious reasons** since ancient times. The early church father Origines (186–254) is one of the most prominent examples. More recently, castration was practised in southern Russia among members of the **Scoptic sect** founded in the eighteenth century. The largest contemporary groups of castrates are the **Hijras** in India. They function as professional well-wishers at birth rites and receive considerable financial rewards. Several thousand of them exist.

Patients with acquired anorchia could (involuntarily) contribute to the question whether the **shorter life expectancy of men compared to woman** (Fig. 21.1) may be caused by testosterone or the presence of testes, as has often been claimed. Astonishing little, however, is known about this “model”. A retrospective analysis of the life expectancy of inmates of an institution for the mentally handicapped in the USA came to the conclusion that early castration may lead to a higher life expectancy (Hamilton and Mestler 1969). However, this may be explained by the preference for castration of physically active inmates whereas lack of mobility is the major predictor of shortened life expectancy among institutionalized men. In contrast, we could find no difference in the lifespan of intact and prepubertally castrated singers from the sixteenth to the nineteenth century when analyzing their biographical data (Fig. 13.2) (Nieschlag et al. 1993b). Since neither the investigation of mentally

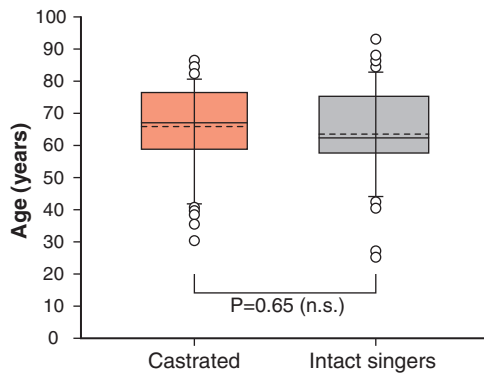

Fig. 13.2 Lifespan of castrated and intact singers from the sixteenth to nineteenth centuries. In each group 50 singers with similar birthdates were selected. Box and whisker plot: solid line = median, dotted line = average (Nieschlag et al. 1993b)

handicapped nor historical analysis can be considered representative for the present normal population, these studies can only provide hints, while the question concerning the 7-year shorter life expectancy of men as opposed to women remains unresolved. Analysis of lifespan of 292 female opera singers who died between 1900 and 1995 revealed that sopranos, being more highly estrogenized, live significantly longer than altos, who are more highly androgenized. This was interpreted to mean that isosexual hormones tend to increase lifespan. Among the 505 male opera singers analyzed, basses, as opposed to tenors, showed only a tendency towards longer life expectancy (Nieschlag et al. 2003).

13.2 Polyorchidism

Supernumerary testes are a rare finding with little more than 100 cases reported in the literature. In most instances a third testis is found (**triorchidism**), predominantly on the left side. The most likely explanation for this condition is a transverse division or doubling over of the genital ridge caused by peritoneal bands in early embryonic development (4th to 6th week). The duplication may only concern the testis, but doubling of the epididymis and vas deferens may also be found (Leung 1988; O’Sullivan et al. 1995) so that the supernumerary testis may either have its own or a joint epididymis and seminal duct together with the neighboring testis (type A) or has no excurrent duct (type B) (Bergholz et al. 2007).

Most patients have no symptoms and the supernumerary testis may be discovered incidentally. Fertility may be normal. However, malignancies and torsions may occur in the third testis and require acute intervention. Most are discovered in association with hernias or because of maldescent. A third testis with epididymis and vas may be the rare cause of persistent fertility following vasectomy (Hakami and Mosavi 1975).

In recent years sonography and magnetic resonance imaging have aided the diagnosis and may make surgical exploration for histological confirmation superfluous (Oner et al. 2005).

Therapeutic management must be decided on a case-to-case basis. While tumors and torsion require surgical removal, the testis may remain in situ in other cases. Such cases should be followed by regular investigations including sonography and tumor markers for early discovery of a tumor.

In the medical literature polyorchidism was first documented in 1880 (Ahlfeld 1880). Historically, supernumerary testes have often been associated with extraordinary strength and sexual vigour of their bearers. Several such cases have been reported anecdotally. Of these, the Venetian admiral Bartolomeo Colleoni (1400–1475) achieved special fame (“colleoni” in Italian means “testes” and nowadays is spelled “coglioni”) and in 1539 Philipp Count of Hesse (1504–1567) was granted permission by Martin Luther to take a second wife simultaneously because of an alleged third testis.

13.3 Maldescented Testes

13.3.1 Pathophysiology and Classification

About the end of the first trimester of early embryonic development the testes move from the region of the kidneys to the inner opening of the inguinal channel. During the last 2 months of gestation the testes descend from the position close to the inner opening of the inguinal channel into the scrotum. At the time of birth, testicular descent is normally completed and is a characteristic sign of maturity of a newborn. Descent may, however, come to a halt at various positions. According to the location of the testes, the following anomalies are differentiated:



Fig. 13.3 Thirty-two-year-old patient with bilateral inguinal testis

- **Cryptorchidism:** The testis lies above the inner inguinal channel intraabdominally or retroperitoneally and can neither be seen nor palpated.
- **Inguinal testis:** The testis is positioned firmly in the inguinal channel (Fig. 13.3).
- **Retractile testis:** The testis lies at the orifice of the inguinal channel and can be pushed into the scrotum, but returns to the original position when released. In other cases the testis alternates its position spontaneously from the scrotum into the inguinal channel and back. This movement will also be induced by the cremasteric reflex when exposed to cold or during coitus.
- **Testicular ectopy:** The testis lies outside the normal route of descent, e.g., femorally or in the groin.

Unilateral maldescent is five times as frequent as bilateral maldescent. Retractile testes occur relatively frequently and rarely have pathological significance. The incidence of other anomalies of descent was summarized in a large systematic analysis encompassing 46 studies and 704,225 patients (Sijstermans et al. 2007). Male newborns born at term and/or weighing ≥ 2.5 kg showed maldescended testes in 1–4.6%. By 1 year of age the incidence was only 1–1.5%. In premature infants and/or weighing < 2.5 kg the incidence was 0.1–9.0%, declining to 1.1–2.1% by completion of the 1st year of life. In 15 year-old boys the incidence was 1.6–2.2%. It must be noted that the 46 studies were partly performed using different criteria and definitions and that no longitudinal investigations were done. In adult men maldescent is still seen in 0.5% cases.

In most cases the **etiology** of testicular maldescent is unclear, so that in 85% a so-called idiopathic maldescent is diagnosed. Presumably, the etiology is multifactorial. Since in most cases the incompletely descended testis has passed the inner opening of the inguinal channel, disturbances of inguinal scrotal descent are assumed. INSL3 and its receptor LGR8, secreted by the Leydig cells, are responsible for the transabdominal phase of descent from the kidney region to the inguinal canal. Testosterone is required for the inguinal-scrotal phase of descent and development of the gubernaculum (Hutson and Hasthorpe 2005; Virtanen and Toppari 2008). In addition to endocrine disturbances, defects in neurotransmitter secretion from a not fully matured genitor-femoral nerve are involved.

Testicular maldescent is frequently found in patients with hypothalamic-pituitary disturbances (see Chap. 12) or in patients with disorders of testosterone synthesis or testosterone action. Next to endocrine causes, anatomical abnormalities could be identified as causes of maldescent as well as reduced abdominal wall tension leading to lowered intraabdominal pressure (e.g., prune-belly syndrome, bladder exstrophy, omphalocele, gastroschisis). Maldescent is also frequently found in primary testicular disorders such as Klinefelter syndrome (see Sect. 13.9), Noonan syndrome (see Sect. 13.12), XX men (see Sect. 13.10) and in gonadal dysgenesis (see Sect. 13.15).

13.3.2 Infertility and Risk of Malignancy

Abnormal testicular location is associated with a disturbance of the germinal epithelium. Many men, even with unilaterally maldescended testis have **impaired fertility** (Lee 2005). In our infertility clinic the percentage of patients with successfully treated or still existing maldescended testes is 8.4% and thus significantly higher than the prevalence of 0.5% in the general male population. Patients with azoospermia were represented by a percentage as high as 17.2% (Table 4.2).

Fertility-reducing alterations may occur very early and not – as once assumed – only at the time of puberty. Morphological alterations of the testis can be demonstrated even in the 1st years of life. Thus the maturation of gonocytes to A-spermatogonia as first step of postnatal spermatogenesis is disturbed (Huff et al. 1991). The longer the maldescent exists, the more pronounced the

morphological alterations will be. In 163 men with a history of maldescended testes from our own fertility clinic who underwent biopsy, 28% showed moderate **hypospermatogenesis** and in two thirds a **Sertoli-cell-only syndrome** or **spermatogenetic arrest** was diagnosed. In nine of these patients a **carcinoma in situ** or a **seminoma** was found. Maldescended testes usually do not show impaired endocrine function.

In addition to impaired fertility, patients with maldescended testes show an increased risk of **testicular tumors**. The risk of malignancy remains increased even in testes which are brought into the scrotum by orchidopexy as well as in the contralateral, always-scrotal, testis. However, these testes are more accessible for diagnostic purposes after orchidopexy. In 2.8% of 599 men with maldescended testes a testicular tumor or a carcinoma in situ was histologically ascertained in one or both testes (Giwerzman et al. 1993). The risk of developing a testicular tumor is 4–5 times higher in men with maldescended testes than in the general male population. It must be assumed that intrinsic congenital factors influence the potential for infertility and malignancy in the maldescended as well as in the contralateral testis. Successful treatment before the 13th year of life reduces the relative risk of malignancy to 2.2 but is 5.4 for patients treated after the age of 13 (Pettersson et al. 2007).

13.3.3 Diagnosis

When investigating the patient, the testis should first be investigated with the patient standing. When the result of this palpation remains unclear, he should be reexamined in a recumbent position. Exposure to cold and stimulation should be avoided since they may induce the cremasteric reflex and retraction of the testes. Occasionally it may even be necessary to examine the scrotum after a warm bath. Testicular volume measured with an orchidometer or ultrasound should be recorded. Imaging sonography supports the diagnosis when the testis is in a still higher position. In bilateral cryptorchidism the hCG-test is essential for differentiating from anorchia if the baseline testosterone is in the castrate range (see Sect. 13.1.1). If testosterone rises under hCG-stimulation and confirms the existence of testicular tissue, the testes should be searched for by imaging diagnostic procedures such as CT or MRI.

13.3.4 Therapy

Testicular maldescend should be treated **as early as possible** but, because of the high rate of spontaneous descent, not before the 6th month (Ritzen et al. 2007). Treatment should be completed by the end of the 1st year. For premature infants the corrected age should be followed (AWMF 2008). A large number of medicinal therapeutic regimes are recommended. The current guidelines recommend one for the sake of simplicity and standardization. If the testes do not descend by the end of the first 6th months presurgical, **hormonal therapy** (see below) should be initiated. According to the guidelines, $3 \times 400 \mu\text{g/day}$ GnRH (3x daily one aerosol application of $200 \mu\text{g}$ in each nostril) for 4 weeks and immediately thereafter (as a continued therapy block) hCG at a dose of $1 \times 500 \text{ IU}$ for 3 weeks should be applied (AWMF 2008). This regime with GnRH and hCG induces descent with a 20% success rate (Henna et al. 2004).

Under hCG and GnRH therapy erections may occur, some pubic hair may grow, testicular volume may increase and the boys may appear more aggressive. These testosterone-dependent side-effects are reversible after the end of therapy. Additional administration of FSH does not improve therapeutic results (Hoorweg-Nijman et al. 1994). This underlines the role of Leydig cell secretory products as leading factors in testicular descent. The lower the testis is located prior to treatment and the younger the patient is (< or >4 years) the higher the success of hormonal therapy will be (Pyörälä et al. 1995). hCG-induced testicular damage observed in rats (Kaleva et al. 1996) continues to be discussed controversially for humans (Cortes et al. 2000) but is one reason, in addition to the low success rates, why Scandinavian pediatricians do not favor hormonal treatment (Ritzen et al. 2007).

If hormonal treatment does not induce testicular descent, **surgical orchidopexy** may be required, which likewise should be performed by the age of 12 months (AWMF 2008). If a hernia exists in addition or if the testis is in an ectopic position, surgical correction should be performed either through open surgery or by laparoscopy. Success rates are 85% for abdominal testes and 95% for inguinal testes (Taran and Elder 2006). Orchidopexy followed by GnRH analogue treatment has been found to result in better semen parameters in later adulthood (Hadziselimovic and Herzog 1997). Autotransplantation of high intraabdominal testes into

the scrotum may be attempted (Bukowski et al. 1995). This operation may be indicated particularly in cases of bilateral cryptorchidism; it should be performed as early in childhood as possible. However, successful operations in adolescence and young adults have been reported. “Success” means correction of the location of the testis and maintenance of the endocrine function, while fertility will rarely be achieved in bilateral cryptorchidism. Biopsy of testicular tissue should not be undertaken as, for unclear reasons, this often results in testicular tumors later in life (Swerdlow et al. 1997).

In adults hCG and GnRH therapy are useless. If orchidopexy is not or cannot be performed, regular check-ups – e.g., at annual or semi-annual intervals – for signs of malignancy are mandatory. Imaging sonography is of decisive importance in the framework of these preventive procedures to diagnose a malignancy early (see Chap. 6). The sonographic picture will influence the frequency of check-ups. Even successfully treated maldescended testes should be regularly palpated and investigated by ultrasonography because of the increased incidence of malignant degeneration. Finally, the patient should be instructed in regular self-palpation and should consult his physician if he encounters suspicious alterations.

The general **recommendation of early therapy** for maldescended testes is based on findings of alterations in testicular morphology which have been documented as early as the 1st year of life. Treatment shortly before or during puberty as practised in earlier times could not prevent testicular damage. It is now hoped but not proven that timely therapy will **reduce the incidence of infertility and malignancy**. However, since early treatment has been generally practised for less than 2 decades and not enough patients have reached the stage when they want to father children, it cannot yet be ascertained that early treatment will indeed help to avoid infertility in patients with maldescended testes (Lee 2005). Only large-scale investigations of patients treated early according to the new therapeutic scheme and who have reached reproductive age will clarify this question.

For adult infertile patients with a history of maldescended testes currently no rational therapy is available; as symptomatic treatment, techniques of assisted fertilization may be considered and applied (see Chap. 23).

Although a large number of patients are affected by maldescendent, to date there are no uncontroversial

guidelines for treatment. This is made abundantly clear by the the guidelines simultaneously published in Germany (AWMF 2008) and by Scandinavian countries (Ritzen et al. 2007), i.e., by countries with few ethnic and cultural differences. These controversies are at least in part due to differing definitions and classifications (Süsterman et al. 2007), but which suffer above all from a lack of representative controlled and randomized therapy studies which would have to cover a time span of about 30 years. To date there has been no initiative for such tedious studies.

13.4 Varicocele

13.4.1 Pathophysiology

The term varicocele denotes a tortuous convoluted formation of the internal spermatic vein forming the pampiniform plexus in the scrotum.

The varicose alteration is favored by the extended free passage of the testicular vein in the retroperitoneum, by the lack of supporting muscle pump, by congenitally weak vessel walls or by an atonic cremaster muscle in part accompanying the spermatic vein. For many years it was assumed that the condition was caused by incompetence or aplasia of the spermatic venous valves. More recently conducted cadaver studies and angiographic investigations have revealed that men without varicocele may also lack valves (Ergün et al. 1996). Probably because of hemodynamically unfavorable merging of the spermatic vein into the renal vein – the right spermatic vein leads directly into the v. cava inferior – a varicocele is found on the left side in about 95% of patients. When the internal spermatic vein is compressed by a neoplasm (e.g., a kidney tumor) one speaks of a **secondary varicocele**.

By just what mechanism varicocele influences fertility remains unclear. Various possibilities continue to be discussed: **reduced perfusion** of the affected testis because of increased venous pressure leading to atrophy with typical reduction of testicular volume; an **increase in scrotal temperature** or insufficient removal or *backflow of toxic substances* of renal origin. The hypothesis that a varicocele is nature’s attempt to

compensate for an otherwise damaged testis is also unproven.

13.4.2 Prevalence and Influence of Varicocele on Fertility

The **prevalence of idiopathic varicocele is high** with estimates varying greatly. This is in part due to the nature and origin of the study population examined. Beyond this, the diagnosis of varicocele remains partly subjective, all attempts to achieve objectivity notwithstanding. This applies above all to first and second degree varicoceles. In general, a prevalence of 15–20% is assumed in the male population. Seventeen percent of three million recruits for the German army, born between 1937 and 1945, were found to have a varicocele (Nöske and Weidner 1999). When, however, stricter diagnostic criteria were applied to sperm donors (Handelsman et al. 1998) and volunteers in clinical studies (Lemcke et al. 1996), a prevalence of 20% was found. It is generally assumed that the proportion of men with varicocele and disturbed fertility is even higher than that in the normal population. Here too estimates range up to 40%, depending on the composition of the investigator's population and it stands to reason that these estimates are higher due to referral bias when made by surgically orientated urologists than by endocrinologists. We found a varicocele in 14.8% of nearly 13,000 consecutive patients attending our institute (Table 4.2). This corresponds to statistics from other comparable centers of reproductive medicine. While this makes **varicocele the second most frequent pathological finding** after idiopathic infertility, it does not give any indication of the importance of the finding and whether it is really a cause of infertility at all.

In general, a certain degree of uncertainty surrounds the prevalence of varicocele in the normal population and in men attending a fertility clinic. There is urgent need for clarification. The situation is even less clear concerning the **influence of varicocele on fertility**. The varying frequency of varicocele observed in proven fathers and in patients attending the infertility clinic prompted some investigators to assume a connection between fertility and varicocele. The fact that varicocele does not exclude paternity, however, causes some investigators to deny this connection. This overlooks the complexity of a couple's fertility. Slight disturbance

in one partner can usually be overcome by particularly good reproductive functions of the other. Only when disturbances in both partners coincide do problems arise (see Sect. 1.4). Investigations in fathers with and without varicocele suggest that varicocele may be associated with poor semen and hormone parameters (Nagao et al. 1986; Pasqualetto et al. 2005). Further, it is assumed that the connections between varicocele and testicular function are not static. Although initially fertility parameters may be largely normal, these are said to decline over the course of years, considerable individual variations notwithstanding (Chehval and Persel 1992). These results are based on rather small patient groups and in our own patient population we are not able to corroborate any increase in the prevalence of varicocele with the age of patients (for the proportion of patients with varicocele is just as high in those patients over 50 years as in 30-year-old patients).

Thus to date there is no indisputable evidence that varicocele itself reduces fertility, and the hypothesis that it is at most a cofactor for infertility in combination with other genetic and molecular events is gaining importance (Marmar 2001).

13.4.3 Clinical Picture

Infertility observed with varicocele manifests itself in a spermogram characterized by oligo-, astheno- or teratozoospermia, or a variable combination of these findings, without a causal connection necessarily existing between these conditions and varicocele. Varicoceles can also be found in azoospermic patients (Table 4.2). Varicoceles may also be associated with increased FSH values, indicating **damage of the germinal epithelium** and a poor prognosis. It should be emphasized that not all men bearing a varicocele show decreased sperm parameters and impaired fertility. Some patients mention **feelings of pressure or sometimes pain** in the afflicted testis or in the scrotum which can worsen after longer periods of standing or sitting in unchanged position. The cut of trousers and underwear may also cause pain. Occasionally a varicocele can become so enlarged as to represent a **mechanical problem**, especially in the elderly.

13.4.4 Diagnosis

Careful **palpation** of the pampiniform plexus while the patient is standing is an important diagnostic measure. The **Valsalva maneuver** can provoke engorgement of the pampiniform plexus. Longstanding varicocele can also induce a **reduction in volume and consistency of the afflicted testis**. According to results from palpation the varicocele can be classified into three degrees of severity.

- **Varicocele grade I:** Enlargement of the pampiniform plexus, only palpable following Valsalva maneuver
- **Varicocele grade II:** Clearly palpable enlargement of the pampiniform plexus
- **Varicocele grade III:** Visible enlargement of the pampiniform plexus (Fig. 13.4)

While grade III varicoceles are clinically easily identifiable, the diagnosis of low grade varicocele very much depends on the experience of the examiner. Moreover, palpation may be made more difficult by previous surgery, hydroceles or when the testis is positioned in the upper scrotum. In these cases, Doppler



Fig. 13.4 Twenty-eight-year-old patient with grade III varicocele

and **imaging sonography** is a valuable tool for corroborating diagnosis. Enlargement of the diameter of a varicose vein can also be objectified by sonographic imaging (see Chap. 6).

13.4.5 Influence of Therapy on Fertility

There is as little evidence that therapy improves fertility as there is no firm connection between a varicocele and disturbed fertility. Since the early 1950s **ligation of the spermatic vein** has held a firm place among the therapies offered by andrologists to improve fertility in cases of varicocele. A review of 50 publications comprising 5,471 patients showed an average pregnancy rate of 36% with a range of 0–50% after ligation of the spermatic vein (Mordel et al. 1990). The great variability is probably due to the size, composition and period of observation characteristic of very heterogeneous populations. In general, the larger, more representative studies have been interpreted as suggesting that surgery has a beneficial influence on fertility. Thus, varicocele treatment represented an oasis of hope in the otherwise desolate landscape of ineffective medical treatments for male idiopathic infertility. The development of new **angiographic methods** for occlusion of the spermatic vein provided new avenues of treatment without altering the outcome.

However, not many efforts at **critical evaluation of invasive interventions** were completed, although several investigators indicated the urgency of the situation. The first of these studies concluded that in varicocele the pregnancy rate is roughly equal, both with and without treatment if only the female is adequately treated (Rodriguez-Rigau et al. 1978). A further study, likewise limited by the lack of a suitable control group, came to similar conclusions (Vermeulen et al. 1986). Randomization was performed in a third study which again showed no improved pregnancy rates with varicocele treatment (Nilsson et al. 1979).

With this background and following the tenets of evidence-based medicine, several controlled studies on the effectiveness of therapy in varicocele were performed. These studies aimed not only at the physical effect of surgery (negative Valsalva maneuver), but along with semen parameters, especially considered the resultant pregnancy rates. An initial study concluded that invasive treatment of the spermatic vein increased chances of inducing a pregnancy within the

following year (Madgar et al. 1995). The study was part of a larger WHO multicenter study which came to similar conclusions. This study comprised 238 couples and registered 35% pregnancies in the ligature group as opposed to 17% in the untreated group. However, because of massive criticism of the design this study failed to be published in a peer-reviewed journal (Hargreave 1997) and its credibility remains doubtful. In contrast, we conducted a single-center study in which varicocele patients with surgical (high ligature) or angiographic occlusive treatment had the same pregnancy rates in the year following treatment as those not subjected to therapy (pregnancy rate of 29% of 62 couples as opposed to 25.4% of 63 couples) (Fig. 13.5) (Nieschlag et al. 1998). We found a slight temporary rise of testicular volume and of sperm concentration in treated patients. No difference was found between groups in duration of involuntary infertility. **Female partners** of patients inducing pregnancies were **significantly younger** than those failing to achieve pregnancy within 12 months (28.8 ± 0.6 versus 31.2 ± 0.3 years). As patients had been selected on the basis of comparable criteria, at first sight the results of these two studies seem contradictory. The patients in our study were seen every 3 months for examination and intensive counselling and the reproductive functions of the female partners were regularly checked by a gynecologist and, if necessary, optimized. In contrast, non-treated couples were not seen in the WHO study. It would be justified to conclude that treatment of infertile couples in which the male has a varicocele is not superfluous.

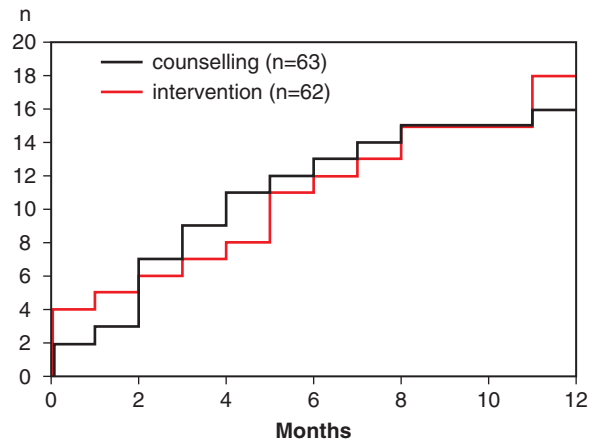
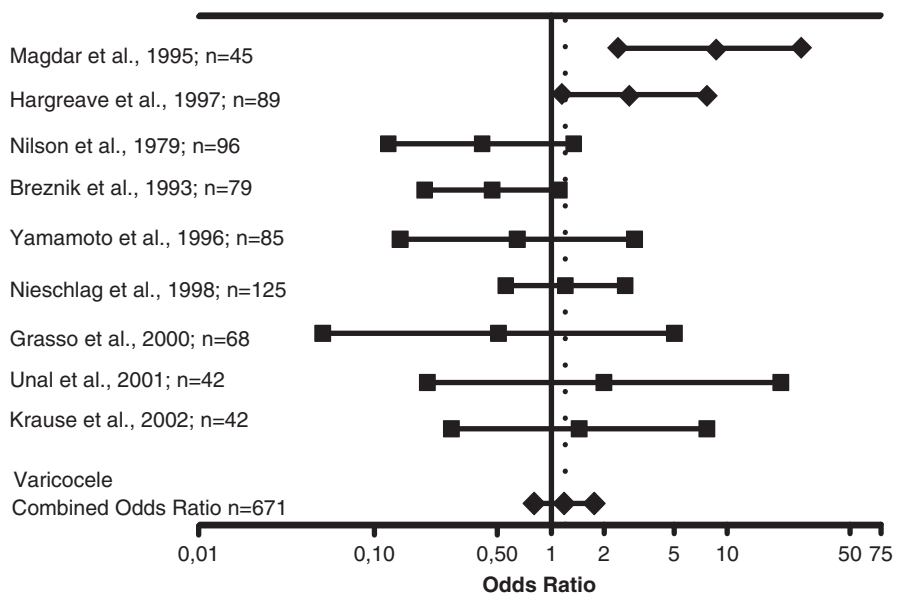

Fig. 13.5 Cumulative pregnancy rates over 12 months in 62 untreated varicocele patients and 63 patients treated surgically or angiographically (Nieschlag et al. 1998)

This study allows the conclusion that regular and intensive examination and counselling of these couples is as effective in regard to pregnancy rates as interventional treatment of varicoceles.

As a result of our study other studies on varicocele therapy (Grasso et al. 2000; Unal et al. 2001), one of them under the aegis of the German Society for Urology (Krause et al. 2002), were carried out. None of these studies (Fig. 13.6) was able to show any effect of treatment with regard to improvement of pregnancy rates.

Fig. 13.6 Individual (squares/hexagons) and combined (COR: diamonds) odds ratios (95% confidence intervals) for pregnancies in randomized controlled studies on therapy of varicocele. The dotted line shows the COR (Kamischke and Nieschlag 2001 updated)



13.4.6 Meta-analysis of Studies on Treatment

The above-mentioned studies show that **at present occlusion of the spermatic vein does not represent a proven modality for treatment of varicocele**. After including the controversial WHO study (Hargeave 1997), an update of our meta-analysis (Kamischke and Nieschlag 2001) shows that a total of 41 patients would have to be treated to gain one additional pregnancy (Fig. 13.6). In view of the costs and surgical interventions this does not seem justified. This statement is supported by a Cochrane meta-analysis which included all peer-reviewed randomized studies on the therapy of varicocele.

Thus the influence of varicocele therapy on pregnancy rates continues to remain controversial. For example, a review article concentrating solely on surgical procedures and including two randomized and three non-randomized controlled studies on patients with higher-grade varicocele and disturbed semen parameters found a significant improvement of pregnancy rates in the operated group (Marmar et al. 2007).

Further studies taking into consideration the placebo-effect of counselling and the identification of subgroups requiring treatment will be necessary to clarify these issues. Carrying out such a study will hardly be possible as, in addition to a surgical group, a non-treated group and a placebo-group, as well as a fourth sham-operated group would have to be included. Owing to the risks of anesthesia and surgery, however, such a study would be unethical, although supporters could be found (Höring and Müller 2002). Furthermore it is becoming increasingly difficult to recruit patients for such a study in view of the fact that assisted reproduction may produce results faster (Zini et al. 2008).

Considering all controversies on therapy of varicocele the most recent Cochrane review states: "There is no evidence that treatment of varicoceles in men from couples with otherwise unexplained subfertility improves the couple's chance of conception" (Evers et al. 2008).

13.4.7 Treatment Modalities

Notwithstanding, some physicians continue to consider a varicocele as a reason for intervention. In that event the **decision for treatment should be made according to the following minimal criteria:**

- Involuntary childlessness persisting at least 1 year
- Varicocele confirmed by physical and technical examinations
- Lower volume of the affected testis
- Subnormal semen parameters
- FSH not elevated above the upper limit of normal

Clarification of female reproductive functions without untreatable disturbances. Varicoceles causing discomfort and pain or a mechanical problem because of size may require intervention independent of desire for paternity.

Once a decision in favor of active intervention has been made, surgical or angiographic procedures available today can be applied. All these procedures have the same goal, i.e., to interrupt the main branch(es) of the spermatic vein in order to divert the venous reflux into collaterals with intact venous valves.

13.4.7.1 Surgical Procedures

Surgical intervention is the classical procedure for varicocele treatment, ligating the internal spermatic vein. For the preferred **high ligation** an incision medial to the anterior iliac spine is made and the spermatic vein is ligated at a "high" location, i.e., close to where it merges into the renal vein.

For **low ligation**, access is made through a suprapubic incision on the left and each vein lying under the spermatic fascia is individually ligated. More recently, the spermatic vein has also been ligated **laparoscopically** and using **microsurgical techniques**. In a comparative randomized study of all three surgical techniques improved sperm concentration and motility were found in the group where microsurgical techniques were used but no significantly increased pregnancy rates were observed after 1 year (Al-Said et al. 2008).

Therapeutic success is evaluated by detumescence of the venous plexus in the scrotum, a negative Valsalva maneuver and a lack of reflux documented by Doppler or ultrasonography. Almost 5% of operations are

technical failures by these criteria and in about 10%, varicoceles reappear. On a long-term basis therapeutic success may be evaluated by increased testicular volume which can best be documented by ultrasonography and by improved semen parameters. Accidental ligation of the lymph vessels accompanying the spermatic vein may cause hydroceles to develop in about 5% of all cases. Other post-operative sequelae such as epididymitis or hematomas occur at a low incidence of 1–3%.

13.4.7.2 Angiographic Procedures

Attempts to clarify lack of success of surgical procedures by phlebography led to the development of angiographic occlusion of the spermatic vein. **Sclerosing of the spermatic vein** by hypotonic solutions injected directly into the vein was first introduced at the end of the 1970s. This was followed by **angiographic occlusion** of the spermatic vein by locally **polymerizing tissue adhesives** or by **balloons or spirals** inserted into the vein. Usually, the lead catheter will be introduced from the right femoral vein under local anesthesia. Most recently, **antegrade sclerosing of the spermatic vein** has been practised, in which access to the vein is obtained from the scrotum. However, convincing improvements in pregnancy rates have not been reported (Zucchi et al. 2005).

Complications resulting from disturbed lymph drainage seen after surgical procedures do not occur. The sclerosing agent used may, however, enter the testicular or renal area and thrombophlebitis, epididymitis, testicular atrophy and perinephritis may result. These disadvantages do not arise when embolization procedures using tissue adhesives are applied. The rate of recurrence is lower in embolization than in sclerosing. In a prospective, randomized study comparing a surgical method (high ligation) with an angiographic method (embolization with tissue adhesives) we were able to show that in a total of 71 patients both methods produced nearly identical pregnancy rates of 29% or 33% respectively within 12 months (Nieschlag et al. 1993a). The advantage of the angiographic method is that it can be performed on an outpatient basis avoiding hospitalization and general anesthesia. In addition, healthy patients appreciate the lesser amount of time required for the procedure.

13.4.8 Varicocele in Adolescence

Varicocele in adolescence raises the general question of prophylaxis. As cross-sectional and longitudinal observations show, varicocele develops concomitantly with testicular growth at puberty. Usually varicoceles do not exist before puberty. In 6,200 Bulgarian boys aged 10–19 years the incidence of varicocele was on average 7.9%, but clearly higher in the older than in the younger boys (Kumanov et al. 2008). In 2,470 Polish boys aged 10–20 years grade I varicoceles were found in 18%, grade II in 12% and grade III in 5% (Niedzielski et al. 1997). At the end of puberty the incidence of varicocele reaches a plateau. Several authors argue in favor of prophylactic ligation or occlusion of the spermatic vein, but adequate studies supporting this position are lacking. Reduced growth or volume of the afflicted testis relative to the contralateral organ has been documented as an indication of reduced circulation. Also morphological alterations of intratesticular vessels and germinal epithelium as seen in adults with varicocele have been described. Whether timely treatment will lead to long-term normalization and undisturbed fertility has not been proven. Short-term increases in testicular volume and in semen parameters have been observed (Laven et al. 1992). Rates of recurrence in long-term fertility studies are not known. In order to resolve the question of safety and efficacy of early varicocele treatment, studies lasting at least 10–15 years are necessary.

These circumstances argue in favor of a cautious position. A finding of varicocele does not automatically justify treatment. Initially, a careful physical diagnosis should be made. Care should specifically be taken to determine testicular volume exactly. As soon as possible, semen parameters should be investigated. Usually it is more difficult to convince parents of the necessity of this measure than sons. A 1–2 year period of observation should follow, during which the development of the varicocele, testicular volume and semen and hormone parameters are checked. Whether subnormal semen parameters can be correctly ascribed to incomplete pubertal development or to the varicocele can only be resolved at the end of puberty by controlled studies. If the varicocele is progressive, if testicular volume is clearly reduced and if semen parameters remain subnormal, treatment may be considered. A particularly enlarged varicocele representing a physical hindrance

may indicate the need for timely intervention. After treatment, both physical findings and laboratory parameters should be checked at yearly intervals.

13.5 Orchitis

Isolated inflammation of the testis (**orchitis**) is extremely rare and usually occurs in association with an inflammation of the epididymis (**epididymo-orchitis**).

Viral orchitis is most frequent. Mumps virus, Coxsackie virus, lymphocytic choriomeningitis (LCM) virus, Marburg virus, group B arbo virus, Dengue virus, varicella-zoster virus and various similar viruses can cause damage to the testes. The testes may become affected in cases of nephritis, prostatitis, vesiculitis or epididymitis caused by gonococci or unspecific bacteria, usually chlamydia. In children pneumococci and salmonella can cause **unspecific orchitis**. **Specific infections** (syphilis, tuberculosis, leprosy) no longer play a dominant role in most European countries. **Non-specific granulomatous orchitis** is rare and presumably of autoimmune origin. It usually affects older men with disturbed bladder function. **Chronic orchitis** often goes unrecognized and is not discovered until inflammatory reactions are found in testicular biopsies (Schuppe et al. 2008).

13.5.1 Clinical Picture and Diagnosis

When **mumps** occurs after puberty **orchitis** develops in about 25% of patients; in about one third of these cases both testes are afflicted. Usually, orchitis develops after parotitis occurs, but may also precede it. Isolated mumps orchitis without parotitis is rare, but it may also go unrecognized. The acute phase of infection is accompanied by painful testicular swelling, fever and generalized symptoms. Increased intratesticular pressure, resulting ischemia or the virus itself may lead to irreversible damage of spermatogenesis. Decreased Leydig cell function, present during the acute stage, is usually rapidly restored.

Whereas acute orchitis represents a relatively clear clinical picture, the prevalence, diagnosis and clinical picture of **chronic inflammation of the testis** are largely obscure. Chronic asymptomatic orchitis can temporar-

ily or permanently affect spermatogenesis and lead to reduced sperm numbers and quality. This applies especially to patients with previously intact spermatogenesis whose semen parameters have progressively declined in following examinations – although no other causes could be identified (e.g., testicular tumor) (European Association of Urology 2004). In chronic subclinical orchitis histological investigation shows patchy inflamed areas distributed throughout the testis accompanied by reduced testicular volume (Schuppe et al. 2008).

13.5.2 Therapy

Vaccination against mumps in childhood may prevent orchitis as a complication ensuing from the infection.

Only **symptomatic treatment** is possible in **acute viral orchitis** and consists of elevating and cooling the scrotum and administering glucocorticoids for about 10 days (60mg prednisone daily followed by gradually decreasing doses). In addition, anti-inflammatory, antiphlogistic and antipyretic drugs may be useful adjunctive therapy. This usually produces rapid reduction of swelling and relief from pain. When IgM antibodies can be detected, therapy with α -interferon- α 2B has been tried (Ku et al. 1999). It is not unequivocally clear to what extent this therapy may also improve testicular function especially in chronic infection. **Bacterial orchitis** is treated according to antibiotic sensitivity results from bacteria cultured from the ejaculate. During the acute phase of infection **sperm parameters** are suppressed, but may recover. Permanent infertility is also possible.

There is no therapy for disturbed testicular function following orchitis which is directed at improving semen parameters. Only methods of assisted reproduction may be considered. Even in azoospermic patients an attempt with TESE may be warranted as focal spermatogenesis may still be present. Any resulting androgen deficiency must be substituted with testosterone.

13.6 Germ Cell Aplasia (SCO Syndrome)

13.6.1 Pathophysiology

Germ cell aplasia does not represent a diagnosis but rather a characteristic histopathologic phenotype first described by Del Castillo et al. in 1947, initially

referred to by his name and which can be caused by different endogenous and exogenous factors.

In **complete germ cell aplasia** the tubules, which are reduced in diameter, contain only Sertoli cells and no other cells involved in spermatogenesis (**Sertoli-cell-only syndrome = SCO syndrome**); the patients are infertile.

In the more frequent **focal SCO syndrome** a variable percentage of tubules contain germ cells, but in these tubules spermatogenesis is often limited in both quantitative and qualitative terms. The SCO syndrome is the most frequent cause of **non-obstructive** azospermia.

About 30% of our infertile patients in whom testicular biopsies were performed present with focal or complete SCO syndrome. Eight percent of this group suffer from **bilateral SCO syndrome**. In view of the possibility of retrieving sperm from testicular tissue to be used in techniques of assisted reproduction (TESE), the question arises how representative a testicular biopsy is. Under all circumstances the biopsied tissue must be screened most scrupulously before a firm diagnosis of complete SCO can be established. In such cases diagnostic-therapeutic TESE with cryopreservation must be carried out.

Testosterone production in the Leydig cells is usually undisturbed so that patients are usually normally androgenized and only infertility prompts them to seek medical advice.

In **congenital germ cell aplasia** for some unexplained reason the germ cells do not migrate into or survive in the epithelium of the tubule. Microdeletions of the Y chromosome (see Sect. 13.13.2) represent an important genetic cause of the SCO syndrome (Simoni et al. 2008). The syndrome of germ cell aplasia can also be caused by severe **endogenous and exogenous damage**, such as **maldescended testes, irradiation, cytostatic drugs** and **viral infections** and thus represents the testicular reaction to severe damage.

13.6.2 Clinical Picture and Diagnosis

Patients with the complete form of germ cell aplasia are always azospermic; the focal SCO syndrome is characterized by **oligoasthenoteratozoospermia** of

varying degrees. In such cases elongated spermatids may be found in the biopsy which are suitable for TESE/ICSI. Usually **testicular volume** is reduced, but may be in the lower normal range. FSH is generally elevated, with serum levels correlating positively with the degree of severity of germ cell aplasia (Bergmann et al. 1994). Determination of inhibin B, correlating negatively with the degree of testicular damage, may improve the diagnostic sensitivity, but also provides no certainty concerning the presence or absence of sperm in the biopsy (von Eckardstein et al. 1999).

Diagnosis can only be made by **testicular biopsy**, which should discriminate between total and focal SCO syndrome in view of ICSI. A testicular biopsy should therefore be planned as a diagnostic-therapeutic procedure including the possibility of TESE (Chap. 11).

13.6.3 Therapy

There is no therapy for complete SCO syndrome leading to improvement of spermatogenesis. Nor can current knowledge increase the number of sperm produced by any residual functions. Therefore, in most cases ICSI possibly combined with TESE provides symptomatic therapy (see above and Chap. 23).

13.7 Spermatogenic Arrest

13.7.1 Pathophysiology

Spermatogenic arrest is the interruption of germ cell maturation leading from spermatogonia to sperm. Like the SCO syndrome, spermatogenic arrest is a histopathological phenomenon with many possible causes.

Spermatogenic arrest can occur **at the level of spermatogonia, primary or secondary spermatocytes or round spermatids**. Patients with fertility disturbances show a prevalence of spermatogenic arrest of about 4–30% of testicular biopsies according to the literature. In a series of 293 patients from our clinic undergoing

diagnostic testicular biopsy, 23% showed spermatogenic arrest localized mostly at the level of primary spermatocytes. In almost one third of these patients the arrest was bilateral.

The reasons may be primarily genetic or may be traced to secondary influences. Primary genetic reasons occur in trisomy, in balanced-autosomal anomalies (translocations, inversions) or in deletions in the Y chromosome (Yq11) (see Sect. 13.13.2). Secondary factors such as toxic causes (radiotherapy, chemotherapy, antibiotics), heat or general diseases (liver or kidney insufficiency, sickle cell anemia) may be causative (Matin-du Pan and Campana 1993). In some patients with arrest at the round spermatid level the **cAMP Responsive Element Modulator (CREM)** is reduced or missing. Since CREM-negative spermatids do not develop further, the lack of this signal transduction factor is considered the cause of the arrest (Weinbauer et al. 1998). Over the past decade a number of transgenic mouse models have revealed spermatogenic arrest and many genes were identified that might be involved in the pathogenesis of this condition without providing a clear clue to this condition in the human.

13.7.2 Clinical Picture

Patients with complete arrest of spermatogenesis are **azoospermic**. In cases of partial arrest varying degrees of **oligoasthenoteratozoospermia** occur, but sperm production may be so low that azoospermia occurs and sperm can only be extracted from testicular tissue (TESE) (see Chaps. 11 and 23). Testicular volume as well as FSH and inhibin B values may lie in their normal ranges, but may also be elevated or decreased, respectively.

13.7.3 Diagnosis

A definite diagnosis can only be made by **testicular biopsy**. Azoospermia and severe oligoasthenoteratozoospermia with normal FSH serum values and normal testicular volume require a testicular biopsy to distinguish arrest from obstruction of the excurrent ducts (Hung et al. 2007).

13.7.4 Therapy

There is no known therapy for spermatogenic arrest. Attempts to increase sperm production have not been successful. For the application of techniques of assisted reproduction the statement in Sect. 13.6.3 referring to SCO syndrome is also relevant here.

Initial success in culturing spermatogenic cells in vitro give rise to the hope that one day spermatogenic arrest may be overcome in patients by in vitro spermatogenesis (Lee et al. 2007).

13.8 Specific Structural Sperm Defects

Even in normal fertile men spermatozoa viewed by light microscopy show considerable morphological variability so that an unequivocal definition of a “normal” sperm cell is not without its problems (WHO 2009). In a minority of infertile patients it is possible to ascertain specific anomalies of sperm cell structure but often only with the help of electron microscopy (Dadoune 1988; Holstein et al. 1988). It is possible to distinguish between head defects, which may occur with and without midpiece defects and tail defects. A normal sperm tail has nine pairs of microtubules arranged concentrically around a central pair (9 + 2). The tubules of each pair are connected with each other by dynein arms and with the central pair by radial spokes (see Chap. 3, Fig. 3.6).

13.8.1 Globozoospermia

Globozoospermia is a structural disturbance of spermiogenesis in which the Golgi-apparatus is not transformed into the acrosome needed for fertilization of an egg cell. The ejaculated sperm lack the acrosomal cap so that they have round heads (Dam et al. 2007).

Such sperm are occasionally found in ejaculates of normal men, but in a few patients all sperm show

this structural defect. This condition is classified as “globozoospermia”. In some cases familial occurrence is observed, indicating a possible genetic cause. Various knock-out mouse models also indicate the likelihood of genetic origin. Considering the importance of the acrosome for the fertilizing process (see Chap. 3) it becomes clear that under natural conditions these sperm cannot interact with egg cells and cannot penetrate them.

13.8.2 9 + 0 Syndrome

This syndrome is characterized by a structural defect of the sperm tail. The central pair of microtubules is missing, leading to **immotility** (Neugebauer et al. 1990).

Only few cases have been described to date. One of 1,000 patients of our infertility clinic could be identified as having this diagnosis (Neugebauer et al. 1990). Usually all sperm are affected by this condition and show complete immotility. Occurrence in brothers indicates a genetic basis of this disorder.

13.8.3 Syndrome of Immotile Cilia

As the cilia of the respiratory epithelium may show the same structural features, afflicted patients often suffer from recurrent sino-respiratory infections and bronchiectasis. If a situs inversus and bronchiectasis are simultaneously present, it is called the **Kartagener syndrome**.

Pedigree studies have provided convincing evidence that the syndrome of immotile cilia including the Kartagener syndrome is genetically determined; in most cases the disorder is autosomal recessive. Three genes coding for dynein proteins are associated with this syndrome: DNA11, DNAH5 and DNAH11 (Storm van's Gravesande and Omran 2005). Accordingly mutations in these genes have been described for patients with complete sperm immotility (Zuccarello et al. 2008).

13.8.4 Clinical Picture

Structural sperm defects lead to infertility. A spermogram often reveals terato- and/or asthenozoospermia despite normal sperm concentration. In addition, the immotile cilia syndrome is often accompanied by chronic bronchitis, rhinitis, sinusitis or otitis media, for which the patient must be specifically asked as they often do not connect these symptoms with infertility.

13.8.5 Diagnosis

In *globozoospermia* the heads of normally motile sperm appear round when viewed in the light microscope. Notably disturbed motility in the presence of otherwise almost normal sperm parameters raises the suspicion of **9 + 0 syndrome and the immotile cilia syndrome**. In the latter case the *saccharine test* is used to screen for cilia dysfunction. The speed with which the beat of the cilia propels saccharine from the nose to the epipharyngeal space is measured. The disturbed cilia motility can be directly demonstrated in nasal mucosal cells. To differentiate between immotile, but viable, and dead sperm in the ejaculate the **eosin test** is used (see Sect. 9.3.4.1). Electron microscopy of the sperm tail confirms the diagnosis. FSH in serum is usually normal. The **Kartagener syndrome** is additionally diagnosed by an X-ray of the thorax.

13.8.6 Therapy

At the present time there is no causal therapy available. In cases of globozoospermia ICSI can be attempted as symptomatic therapy. The results are, however, worse than for other ICSI indications. Better results from using calcium ionophores in the incubation medium indicate that the sperm-associated oocyte-activating factor is disturbed in these patients (see Chap. 3) (Review in Dam et al. 2007). An ICSI-attempt can also be made in patients with immotile cilia for which the HOS test may be useful for choosing vital sperm (see Sect. 9.3.4.1). Births of healthy children conceived in this manner have been reported (Peeraer et al. 2004).

13.9 Klinefelter Syndrome

13.9.1 Incidence and Etiology

With a prevalence of 0.2% (i.e., 1:500) of the male population the Klinefelter syndrome is the most frequent form of male hypogonadism. The incidence is about 10× higher in an andrological clinic (Lanfranco et al. 2004).

Accordingly there must be about 80,000 cases in Germany. Based on central and cytogenetic patient registers in Denmark it must be assumed that only

about one quarter of all cases are diagnosed (Bojesen et al. 2003). In about 80% of cases the disease is due to the **congenital numerical chromosome aberration 47,XXY**. The other 20% are represented either by 46,XY/47,XXY mosaics, one or more additional Y chromosomes (e.g., 48,XXYY), higher-grade X chromosomal aneuploidies (48,XXXYY; 49,XXXXYY) or structurally abnormal additional X-chromosomes. Patients with a pure 47,XXY karyotype in circulating lymphocytes may show a mosaic in testicular tissue (Bergère et al. 2002) and Klinefelter patients with sperm in the ejaculate also may show several 47,XY lymphocytes (Lenz et al. 2005).

The numerical aberrations arise from **non-disjunction** in the meiotic divisions during germ cell development of the parents (Fig. 13.7). Incorrect

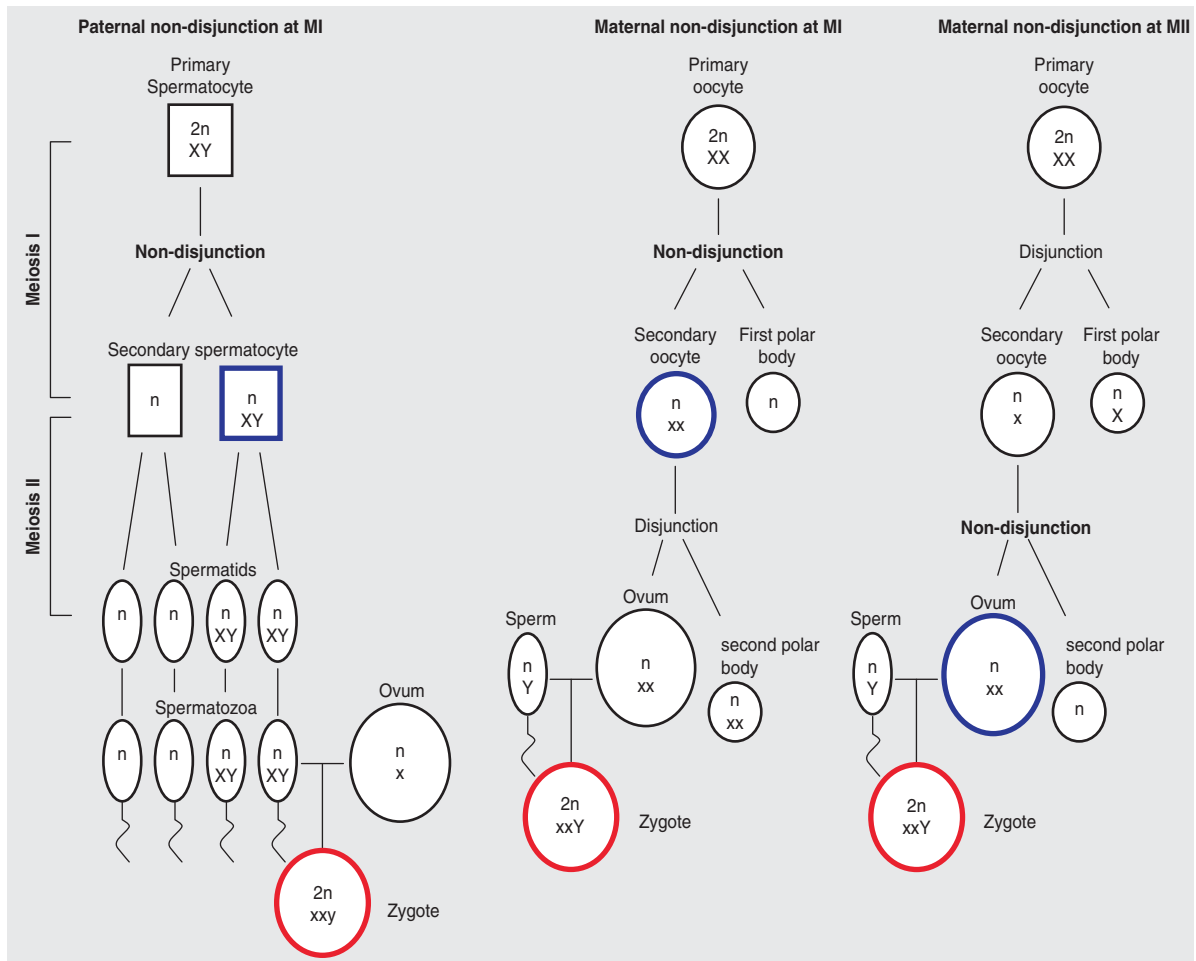

Fig. 13.7 Etiology of the Klinefelter syndrome: non-disjunction of the sex chromosomes in paternal or maternal meiosis I or in maternal meiosis II (Modified from Lanfranco et al. 2004)

meiotic divisions are predominant; in two thirds of cases non-disjunction derives from maternal oogenesis, one third from paternal spermatogenesis. Advanced maternal or paternal age was always discussed as a risk factor but could not be verified in our own series of 228 patients (Lanfranco et al. 2004). In contrast to many other aneuploidies, the Klinefelter syndrome is not associated with an increased rate of abortion and does not represent a lethal factor.

Although primordial germ cells are present in the testes of Klinefelter patients, they degenerate unusually fast, so that by the time of puberty, none or only few germ cells are present (Aks glaede et al. 2006). Simultaneously in a kind of counterreaction the Leydig cells become hyperplastic. However, since the testes remain very small because of the lack of spermatogenesis, the total number of Leydig cells remains low and an androgen deficit with varying expression ensues. The early loss of germ cells explains why elongated spermatids tend to be found in the testes of younger patients than in older patients (Ichioka et al. 2006).

13.9.2 Clinical Picture

Patients with Klinefelter syndrome (Fig. 13.8) usually go unnoticed until after puberty so that often diagnosis is relatively late, although before and during puberty a discrete Leydig cell insufficiency exists (Bastida et al. 2007). **Prior to puberty** only discrete physical anomalies may be noticed, e.g., maldescent in one quarter of cases, slightly reduced testicular volume or **long-leggedness**. A portion of the children have **learning difficulties** and their **verbal expressiveness** is limited. In the **adolescent and in the adult** the syndrome is typically characterized by the constellation of **small firm testes, infertility and symptoms of androgen deficiency**. The testicular volume of an adult patient with a 47,XXY-karyotype is generally in the range of 1–3 ml, rarely over 4 ml (Fig. 5.4).

There is a great range of variations in the **degree of virilization**. Because of initially still normal serum androgen levels, about 60% of patients have a penis of normal length. At the time of normal puberty characteristic skeletal proportions begin to develop. The patients are often of greater than normal height. In contrast to typical eunuchoid tall stature, the arm span



Fig. 13.8 Thirty-year old man with Klinefelter syndrome. Sparse virile hair pattern with horizontal pubic hairline, bilateral gynecomastia and bilateral testicular volume of 2 ml each, venous varicosities of both legs

seldom exceeds total body height; the **legs**, however, **are remarkably longer than the trunk** (lower height > upper height). After the age of 25 about 70% of patients complain of **decreasing libido and potency**. Normal **beard** growth is present only in about one fifth of patients. As a result of reduced androgen production often muscle strength declines and **osteoporosis** with increased fractures, as well as **varicosis** of the legs with ulcerations may occur; the latter may also occur without varicosis because of an increase of the plasminogen activating inhibitor-1 (LAI-1) (Zollner et al. 1997). **Pulmonary embolism** occurs more often than in the normal population. Frequently **obesity**, reduced glucose tolerance and **diabetes mellitus** and the **metabolic syndrome** are observed (Bojesen et al. 2006). More **epilepsy** and other neurological disturbances occur in Klinefelter patients.

During puberty bilateral painless **gynecomastia** of varying degrees develops in about 40% of the cases. The gynecomastia may be associated with a slightly higher incidence of **breast carcinoma**. In addition to the latter, **mediastenal non-seminomatous germ cell tumors** are found with a predilection age between 15 and 30 years. Neurological and psychological illnesses occur more frequently. Altogether an increased risk for morbidity and mortality are found for almost all organ systems in the Klinefelter syndrome (Bojesen et al. 2004, 2006; Swerdlow 2005a, b).

The **intellectual capacity** may be completely normal. Boys with Klinefelter syndrome may come to attention because of deficits in **verbal and cognitive abilities** and may develop school difficulties. Attention deficits may arise and socialization causes problems. Often they fail to reach the level of achievement or professional niveau of their families (Ratcliff 1999; Simm and Zacharin 2006).

13.9.3 Diagnosis

A suspected diagnosis can usually be based on the combination of typical clinical findings (Table 13.1). The most important of these are **very low testicular volume** (1–3 ml) and **firm consistency of the testes**. Symptoms described above of varying degrees provide additional indications. Often **involuntary childlessness** leads to medical consultation – and provokes diagnosis. Usually **azoospermia** is established. In some

Table 13.1 Clinical diagnosis of the Klinefelter syndrome

Increased height (but only increased leg length)
Gynecomastia (in 38%)
Small, firm testes (in 100%)
Symptoms of hypogonadism
Sparse beard growth
Sparse pubic hair
Loss of libido
Erectile dysfunction
Osteoporosis
Lowgrade anemia
Possible psychosocial problems
Limited verbalization
Attention deficit
Learning difficulties
Legasthenia
Failure to achieve family's professional level

patients few sperm or severe oligoasthenoteratospermia can be found. **Testicular histology** reveals hyalinizing fibrosis of the seminiferous tubules, lack of spermatogenesis and Leydig cell hyperplasia. In isolated cases several tubules may show intact spermatogenesis with elongated spermatids and sperm (Akslaede et al. 2005). Spontaneous **paternity** in Klinefelter patients is an extremely rare occurrence worthy of publication.

In clinical routine the occurrence of **Barr bodies** which represent the inactivated supernumerary X chromosome **in a buccal smear** has proved to be a rapid and simple diagnostic method. As a screening procedure this test has high specificity (95%) and sufficient sensitivity (82%) (Kamischke et al. 2003). Ultimately diagnosis of a Klinefelter syndrome is confirmed cytogenetically by establishing the **karyotype**.

FISH analysis of lymphocytes in the inter- or metaphase offers an additional diagnostic option because it allows analysis of a greater number of cells and better correlation with clinical findings (Lenz et al. 2005).

Serum testosterone values are reduced in about 80% of patients with 47,XXY karyotype. On average estradiol is higher than in normal men. Simultaneously **SHBG** serum concentrations are elevated, causing a further reduction of biologically active free testosterone. Development of gynecomastia depends on the ratio of estrogens to serum androgen levels. The gonadotropins **LH and FSH** are above normal levels. **FSH may be highly increased** (see Fig. 13.9). An hCG-test will show reduced Leydig cell reserve capacity, a GnRH-test an extreme increase of the elevated gonadotropins. Neither test is necessary for routine diagnosis.

Fig. 13.9 Hormone concentrations in 228 Klinefelter patients and 224 infertile men with normal karyotype. The shaded areas represent the normal ranges of each hormone. Represented by box-and-whiskers plots, the asterisks indicate significant differences (Lanfranco et al. 2004)

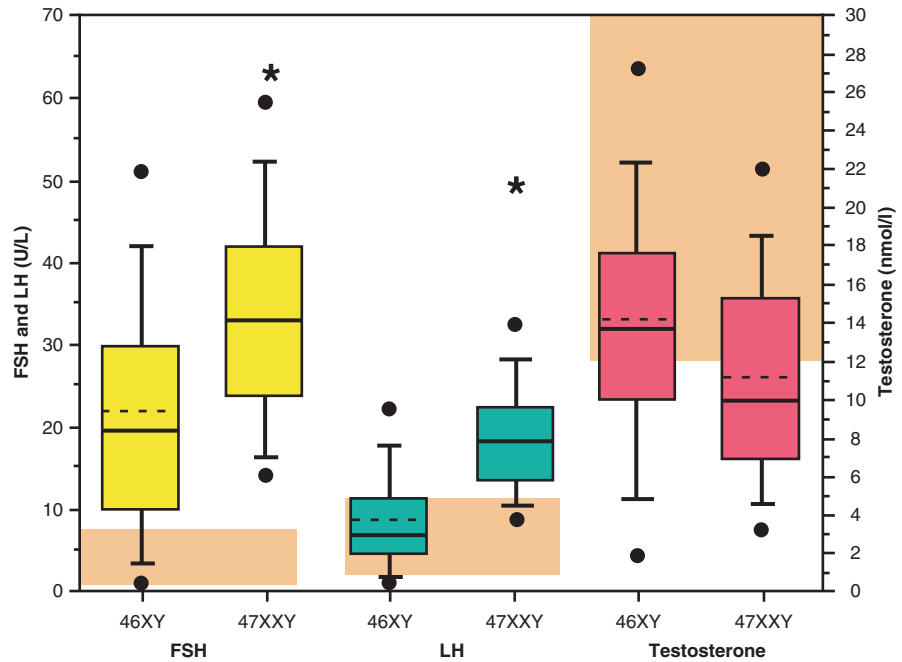

The large variety in the clinical phenotype of Klinefelter patients can be explained in part by differing testosterone production rates and mosaic forms. In addition, in classic 47,XXY Klinefelter patients **polymorphisms of the androgen receptor** play a role. Thus patients with longer CAG triplets show more extreme symptoms of hypogonadism than patients with shorter CAG triplets; patients with short CAG triplets achieve higher levels of education and live in stable relationships. This gives rise to the assumption that patients with shorter CAG triplets tend to seek out centers of reproductive medicine because of involuntary childlessness while those with longer CAG repeats tend to visit an endocrinological center because of prevailing symptoms of androgen deficiency (Zitzmann et al. 2004).

Patients with mosaics may have marked oligozoospermia.

Practically all ejaculates from patients with 47,XXY karyotype show **azoospermia**. Very rarely can sperm be observed and the literature reports some exceptional cases of spontaneous paternity (e.g., Terzoli et al. 1992). A testicular biopsy is not required for diagnosis (see below).

If a Klinefelter syndrome is identified by chance during **prenatal diagnosis** genetic counselling is urgently required to inform the parents confronted with this dilemma about the extent of the disease.

Whereas numerous publications report decisions for pregnancy termination in 50% of cases, in some centers induced abortions in only 15% are performed (Meschede et al. 1998).

13.9.4 Therapy

Substitution with testosterone should be prescribed generously for the adult Klinefelter patient as this improves the quality of life and prevents later adverse effects. Especially generally increased masculinity with corresponding muscle strength and bone density as well as secondary hair and beard growth and normalization of red blood can be achieved. Loss of libido and erectile dysfunction as well as depressive moods and loss of vigor can be reduced or abolished. As testosterone causes an increase of insulin sensitivity and induces muscle mass at the expense of fat, the tendency towards the metabolic syndrome is reduced. Available results of investigations, however, do not allow to conclude whether increased morbidity and mortality rates in Klinefelter patients can be reduced by systematic testosterone substitution. All studies and experience indicate that substitution should not be withheld from Klinefelter patients, which is very often still the case.

When serum testosterone levels are below normal, substitution therapy must be applied as outlined in Chap. 21. To avoid androgen deficiency symptoms and their sequelae hormonal substitution should be implemented as early as possible.

Whether substitution should already begin during **puberty** is difficult to decide since there are only few and no controlled studies on the subject. The experience of some investigators supports substitution as early as possible so that better physical, psychological and educational development are achieved as well as social integration (Kubler et al. 1992; Simm and Zacharin 2006). Psychological support is advisable in any case.

Gynecomastia is hardly influenced by hormone therapy. Aromatase inhibitors and antiestrogens are effective only in isolated cases. If it disturbs the patient, a plastic surgeon experienced in cosmetic breast surgery can perform a **mastectomy**.

Treatment of **infertility** is only rarely successful. As mentioned, spontaneous pregnancies are extremely seldom. To date only few pregnancies resulting from ICSI with semen from Klinefelter patients have been reported. However, pregnancies after **TESE with ICSI** are more frequent. An overview of 22 publications encompasses 227 patients in whom TESE was attempted and in whom 125 of these attempts yielded sperm from testicular biopsies; its use led to 64 live births (Lanfranco et al. 2004; Schiff et al. 2005). Best results were reported following premedication with hCG and/or antiestrogens (Schiff et al. 2005). This study, however, was uncontrolled and it remains questionable whether premedication actually was of influence as it was not successful in other forms of male infertility in controlled double blind studies (see Chap. 22). It is more likely that those patients in whom sperm were found had short CAG triplets in the androgen receptor and had remaining spermatogenesis. Evidence for this is still awaited.

There are also indications that sperm are more likely to be found in the testes of younger Klinefelter patients than in older patients (see above) but here too systematic studies are lacking. Finally, it is more likely to recover sperm from patients with mosaics than from patients with 47,XXY karyotypes.

In any event, when offspring is desired, testosterone substitution is not indicated because it will suppress

any remaining spermatogenesis. Substitution must be suspended for at least 3–6 months.

Even if the few children produced in this manner by Klinefelter patients have normal karyotypes, the parents must be informed that embryos and offspring are at higher risk for aneuploidy – not only with regard to the sex chromosomes, but also for chromosomes 18 and 21. For this reason **preimplantation diagnosis** before transfer is recommended or at least meticulous **prenatal diagnosis** in countries like Germany, where preimplantation diagnosis is not performed (overview in Lanfranco et al. 2004).

On the whole infertility in Klinefelter patients can only be successfully treated in exceptional cases and during counselling the patients' hopes should not be overly encouraged.

In therapeutic terms **patients with a criminal record** represent a special case. According to their serum testosterone values and clinical symptoms they should be substituted. Because of the widely held belief that testosterone induces aggressive behavior, a cautionary stance seems advisable. Since, however, androgen deficiency may provoke social maladjustment, and “being different” and “trying to prove one’s manhood” may be causes for criminal behavior, carefully supervised replacement therapy should be considered for these patients. In cooperation with psychiatrists and social workers positive experience in a number of cases has been reported. For such patients replacement without exceeding upper normal values is especially well suited.

13.10 XX Male Syndrome

XX men with female karyotype (46,XX) are phenotypically male and have neither internal nor external female genitalia. This disorder shows a prevalence of 1:10,000 to 1:20,000.

In about 90% of patients this finding, which seems a paradox in a male individual, can be explained by the

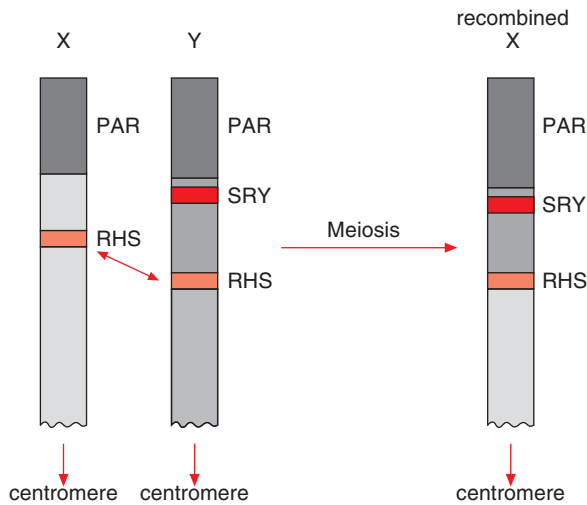

Fig. 13.10 Schematic illustration of the abnormal meiotic X/Y-exchange leading to translocation of the X chromosome. This abnormal exchange occurs during meiosis in the XX male's father. PAR pseudoautosomal region (identical sequences on X and Y). SRY "sex determining region Y" gene; RHS recombination hot spot location most favored for abnormal X-Y recombination. Pink area X-chromosome-specific sequences, red Y-chromosome-specific sequences. This X-Y exchange causes 5% of XX males (according to Weil et al. 1994)

presence of genetic information specific to the Y chromosome appearing on one of two X chromosomes. Translocation of a DNA-segment from the Y to the X chromosome takes place during paternal meiosis. Among others, the testis-determining gene SRY (Sex Determining Region Y) becomes attached to the X chromosome (Fechner et al. 1993) (see Fig. 13.10). The presence of the gene is sufficient to cause the initially indifferent gonad to develop into a testis. However, during translocation other essential genes responsible for the induction of spermatogenesis, e.g., the AZF region, are lost, and so XX males are infertile. In addition to the SRY-positive XX men there is also a more rarely occurring SRY-negative variant. These patients are less virilized than SRY-positive men and show malformations of the genital organs such as maldescended testes, bifid scrotum or hypospadias (Fig. 13.11).

It is estimated that to date about 250 cases have been described, of which 11 patients seen by us represent the largest group published (Bonayed Abdelmoula et al. 2003; Vorona et al. 2007). In clinical terms, XX males are hardly distinguishable from Klinefelter



Fig. 13.11 Twenty-seven-year-old male with XX-syndrome

patients and only a karyotype provides certainty. The essential phenotypical difference to Klinefelter patients is that of **lower height**: 170.6 ± 6 cm ($n = 11$) vs. 183.4 ± 9.4 ($n = 101$). The **testes** are **small** (1–2 ml) and **firm** as in Klinefelter patients, and, similarly, endocrine testicular function is usually insufficient with **decreased serum testosterone** and elevated gonadotropin levels. Fat distribution often shows a female configuration; maldescend and **bilateral gynecomastia** occur more frequently than in Klinefelter patients; the incidence of hypospadias is increased. Patients have normal intelligence. The semen is **azoospermic**, and to date no case of paternity has been reported following TESE/ICSI. In case of endocrine testicular insufficiency **testosterone replacement therapy** must be initiated (see Chap. 21).

13.11 XYY Syndrome

In clinical terms individuals with a 47,XYY karyotype are not remarkable. The presumed incidence is 1:2,000. Considered as a group they are of **above average stature**, about 7 cm, and have larger teeth than men with a normal set of chromosomes. In contrast to Klinefelter patients, these men are fertile and their intelligence is normal. Therefore the finding of a 47,XYY karyotype should not be considered the cause of impaired fertility in an infertile male. The intelligence quotient (IQ) lies within the normal range, but on average ten points below the mean of chromosomally normal men.

Much attention has been given to the finding that 47,XYY individuals show criminal tendencies more often than other men, predominantly crimes of theft. However, this is probably an artefact due to selection bias. In this connection it must be stressed that the majority of 47,XYY men are fully normal in terms of behavior and any stigmatization on the basis of the karyotype must be avoided (Propping 1989). Children and adolescents with a 47,XY karyotype often cause problems due to impulsiveness, increased frustration, decreased tolerance and maladjustments.

The chromosomal aneuploidy is caused by **non-disjunction in paternal meiosis**. Usually the finding is incidental, occurring when karyotyping has been undertaken for another indication. If in a 47,XYY man semen parameters are impaired, the same treatment as in idiopathic infertility is applicable. Children of 47,XYY men almost always have a normal karyotype. Nevertheless, to be safe, prenatal diagnosis should be offered, especially when pregnancy is induced by ICSI. If an XYY syndrome is discovered in the course of prenatal diagnosis, parents opt for pregnancy termination in one half of the cases.

13.12 Noonan Syndrome

The Noonan syndrome is of genetic origin and is caused by mutations in the PTPN11, KRAS, SOS1 and RAF1 genes. Its prevalence is estimated at 1:1,000–1:5,000. The term “male Turner syndrome” formerly used was based on a certain overlap of the clinical picture with “true” Turner syndrome, is misleading and should no longer be used.

Well-proportioned short stature is typical, with height often being below the third percentile (Sharland et al. 1992). Growth is parallel to the percentile curves in the somatogram. Delayed or incomplete pubertal development, bone age delayed by an average of 2 years, disturbed testicular descent and reduced testicular volume may occur. Disturbed fertility, the origin of which is disputed, is frequent in men (Elsawi et al. 1994; Marcus et al. 2008). The impression of “typical Noonan” facial characteristics arises from mild ptosis, ocular hypertelorism, low-set ears, broad nasal bridge and an anti-mongoloid palpebral slant. Other somatic anomalies such as short and broad neck up to the presence of pterygia, cubitus valgus, clinodactyly of the fifth fingers as well as a malformed sternum with pectus carinatum cranially and pectus excavatum caudally may occur. The most serious malformations are **congenital cardiac defects**, especially pulmonary valve stenosis and hypertrophy of the ventricular septum, which characterize 80% of patients and are documented by echocardiography.

If pubertal development is delayed the same schedule should be followed as for constitutionally delayed puberty (see Chap. 12). Maldescended testes must be corrected early (see Sect. 8.3). Diagnosis and therapy of functionally significant heart defects and disturbed hearing and vision should be made as early as possible. It is important to inform the patient about the genetic basis of the disease; if offspring is desired, genetic counselling should follow.

13.13 Structural Chromosome Abnormalities

Aside from numerical chromosome abnormalities (e.g., Klinefelter syndrome), **structural chromosomal aberrations** constitute a separate category of pathological karyotypes which are important for the clinical andrologist (examples in Fig. 13.12). Structural anomalies of the sex chromosomes (gonosomes) are distinguished from anomalies of the autosomes. In addition, aside from the chromosomes involved in the anomaly, a further distinction between deletions, translocations, inversions etc. is made according to the mechanism that gave rise to the anomaly. When evaluating a structural chromosomal anomaly for clinical purposes, it must be kept in mind whether the **karyotype is balanced or unbalanced**.

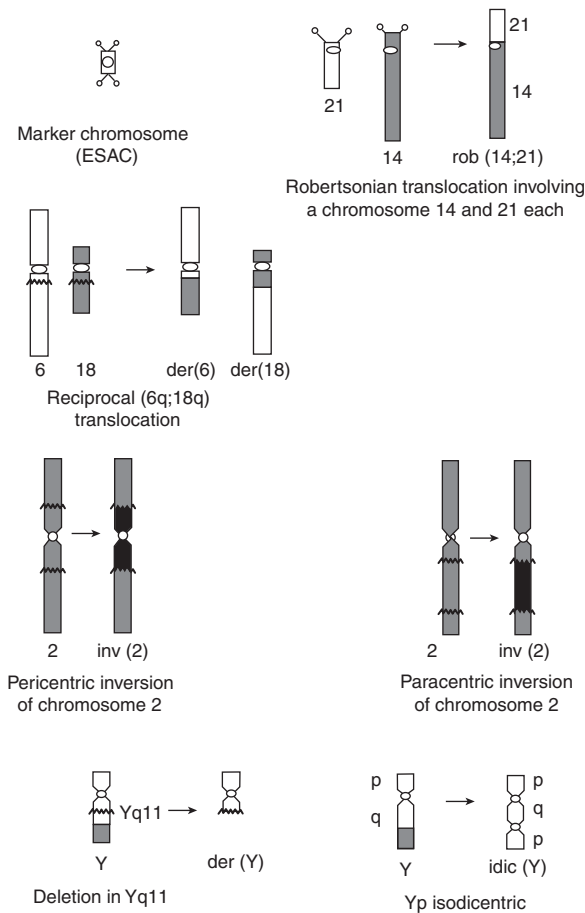

Fig. 13.12 Structural chromosome anomalies important for andrology

The latter is the case when genetic material is missing or an excess is present in the “net balance” of the cell. For example, a deletion leads to an effective loss of a chromosomal segment and thus to an unbalanced karyotype. On the other hand, the genetic balance is maintained in a reciprocal translocation (counter exchange between two chromosomes); the karyotype is balanced.

Both balanced and unbalanced structural chromosomal anomalies can cause disturbances in the male reproductive system (Van Assche et al. 1996; Meschede and Horst 1999). Almost all unbalanced karyotypes are associated with severe disturbances of general health, if they are at all compatible with the bearer’s survival. Severe congenital physical and mental handicaps are the rule. In this regard, aberrant chromosomal findings of this kind play an important role in pediatrics and clinical genetics, but not in andrology. One

exception are deletions of the Y chromosome. They may limit reproductive functions selectively, and are therefore of importance in reproductive medicine.

No causal treatment of chromosome abnormalities is yet available. Symptomatic treatment modalities such as assisted fertilization (see Chap. 23) can be applied in some infertile patients with chromosomal aberrations. However, success rates may be lower than in couples with normal karyotypes (Montag et al. 1997). It should also be considered that unbalanced karyotypes of the embryo may result from balanced parental chromosomal anomalies (Meschede et al. 1997). Genetic counselling should be obligatory to estimate the risk of potential and prenatal diagnostic options.

13.13.1 Structural Abnormalities of Sex Chromosomes

An intact **Y chromosome** is essential for the normal structure and function of the male reproductive system. The **SRY gene** is localized on its short arm and it influences differentiation of the embryonic gonad in the testicular pathway (see Sect. 13.10). In addition, the Y chromosome contains areas responsible for regular spermatogenesis. The long arm of the Y chromosome is of particular importance for spermatogenesis. Submicroscopic microdeletions on the long arm of the Y chromosome are dealt with in Sect. 13.13.2.

When speaking of **deletions of the Y chromosome**, those of the short and the long arm must be distinguished (see Sect. 8.3.1). If the entire short arm or its distal parts are lost, the patient will lack the SRY gene. The cascade of embryonic development will be disturbed at the level of gonadal differentiation. Clinically, a Turner syndrome-like phenotype with gonadal dysgenesis will result. If the deletion affects the long arm, the phenotype will be male and, depending on the size of the lost segment, spermatogenesis will be affected to varying degrees. A proximal euchromatic and a distal heterochromatic portion (chromosome band Yq12) are distinguished. The latter is variable from man to man and there are no active genes. Its loss is without negative consequences, although a very small Y chromosome is found upon analysis. The strong band of fluorescence, typical of the long arm of the Y chromosome, will be absent. If the deletion extends into the euchromatic area of the long arm, i.e., that bearing

Fig. 13.13 Y chromosome with classic AZFa, b and c deletions and repetitive sequences (palindroms, in color) explaining the occurrence of these and other (b2/b3, gr/gr) through homologous recombination between similar areas (Modified from Noordam and Repping 2006)

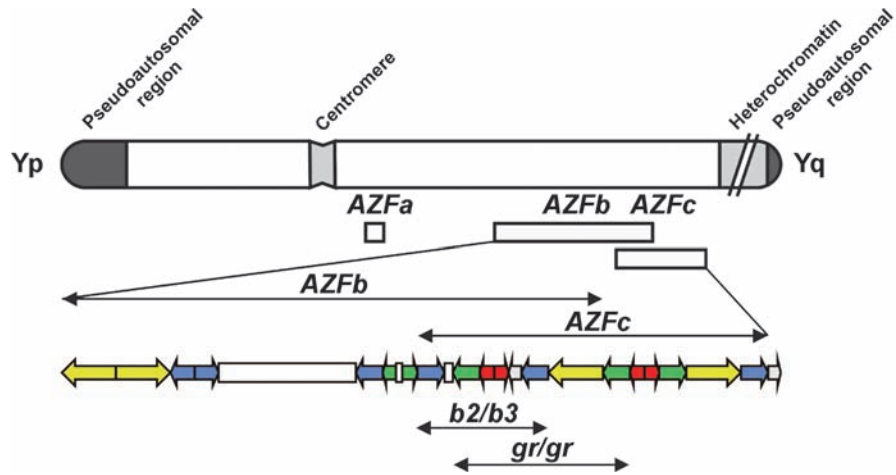

active genes (chromosome band Yq11), a severe disturbance of germ cell formation with azoospermia or marked oligozoospermia will result. Some of these patients show short stature and undervirilization as further pathological findings.

In addition to deletions and microdeletions, a series of further structural anomalies of the Y chromosome are known (Fig. 13.12). An **isodicentric Y chromosome** is a more complex aberration nearly always occurring as a mosaic with a 45,X-cell line. The phenotype may be male, female or indeterminate. Patients with a male phenotype are usually infertile. **Reciprocal translocations** between the Y chromosome and one of the autosomes are rare. Mostly spermatogenesis is severely disturbed, several men with this karyotype are, however, fertile. **Translocations between the X and Y chromosomes** occur in several variations; often the karyotype is unbalanced. The correlation between karyotype and clinical presentation is complex.

The **X chromosome** contains numerous genes essential to survival. Every major deletion of this chromosome has a lethal effect in the male sex. The loss of a small segment of the distal short arm (Xp22-pter) is, however, compatible with life. The Xp22 contiguous gene syndrome is characterized by severe disturbances. Ichthyosis congenita, chondrodysplasia punctata, short stature, mental retardation as well as the **Kallmann syndrome** appear in variable combinations. The latter component, prompted by loss of the KAL-1-gene (see Chap. 12) affects about half of the patients. Translocations between the X chromosome and an autosome usually results in azoospermia or oligozoospermia.

Conversely, inversions of the X chromosome do not substantially affect male fertility.

13.13.2 Y Chromosome Microdeletions

The long arm of the Y chromosome contains three distinct regions, the integrity of which is essential for normal spermatogenesis. The loss of one of these loci, designated as “**azoospermia factors**” (AZFa, AZFb, AZFc) and caused by spontaneous mutation in the paternal germ line, leads to severely disturbed fertility (Ferlin et al. 2007; Vogt 2005; Simoni et al. 2008) (Fig. 13.13). The deleted regions are usually of submicroscopic dimensions and are known as **Y chromosomal microdeletions**. Their prevalence in men with non-obstructive azoospermia lies up to 20%, up to 10% in cases of severe oligozoospermia and $\leq 1\%$ among all infertile men. The prevalence depends on the ethnicity of the patients. Thus the prevalence in Germany and Sweden is lower than that, e.g., in Italy or other countries within or outside Europe (Fig. 13.14) (Simoni et al. 2008).

The complete sequencing of the Y chromosome was able to decipher the mechanism by which the AZF deletions occur: the homologous recombination between repetitive sequences (palindroms) leads to the loss of intermittent regions (Noordam and Repping 2006). In addition, smaller deletions of the AZFc regions have been described (b2/b3 deletion, gr/gr deletion) (see Fig. 13.13) whose importance as a pathological entity or variation of norm (polymorphism)

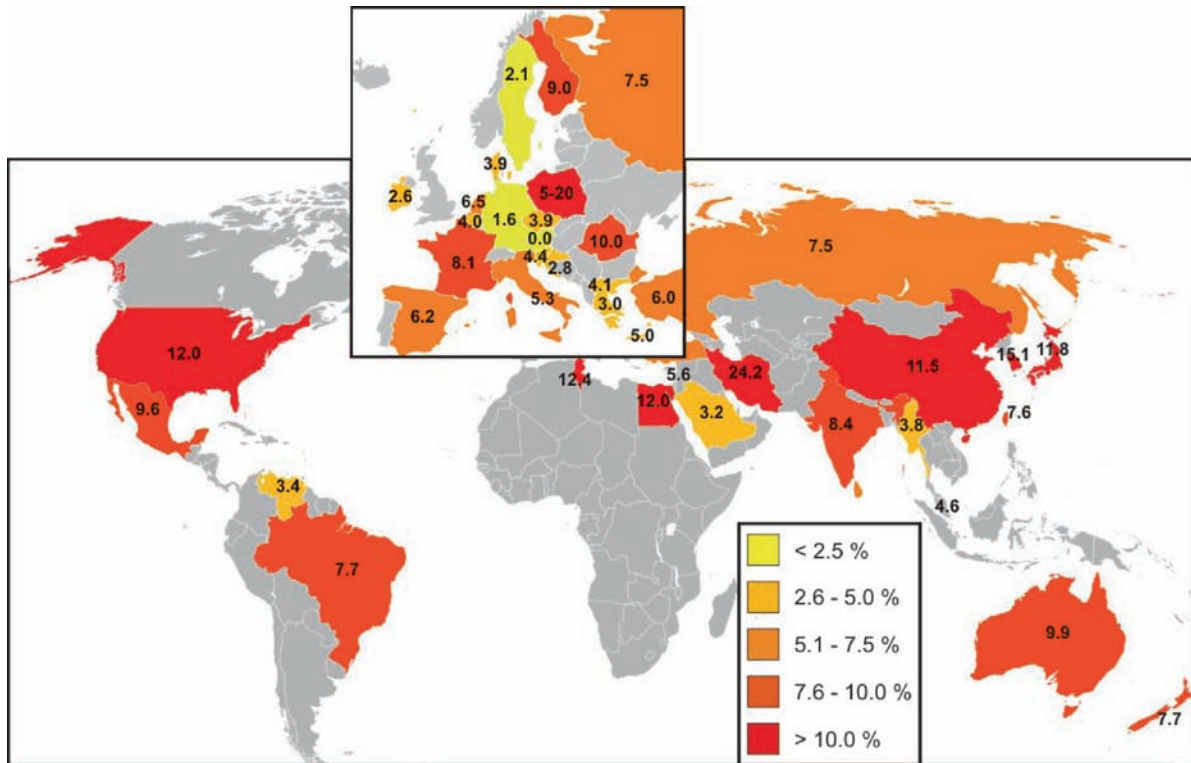

Fig. 13.14 Incidence of AZF deletions in different countries (Simoni et al. 2008)

has not yet been completely clarified. Gr/gr deletions have been found in infertile men as well as in men with normal sperm concentrations (Hucklenbroich et al. 2005; Simoni et al. 2008). Thus their importance as risk factors for poorer spermatogenesis or sperm concentration is presently unclear and their molecular genetic analysis within the framework of fertility diagnosis is not indicated for clinical routine (in all stages up to round spermatids).

Clinically the patients present with severely **disturbed spermatogenesis**; endocrine testicular function remains unaffected by the microdeletion. **AZF α deletions** (about 10% of all AZF deletions) always cause azoospermia and histologically the Sertoli-cell-only syndrome (SCOS) is seen, so that, in the event of desired parenthood, a testicular biopsy and TESE remain unsuccessful. Similarly azoospermia is always present in patients with **AZF β deletions**, usually along with SCOS, partially with arrest of meiosis (in all stages up to round spermatids) and rarely are elongated spermatids found in a testicular biopsy. In contrast, **AZF γ deletions** present a very heterogeneous picture in semen analysis and testicular histology, ranging from

azoospermia caused by SCOS (40–60%) or meiosis arrest up to severe oligozoospermia due to focal SCOS, or mixed atrophy of spermatogenesis (see Fig. 13.15).

Investigations using **specific molecular genetic** techniques are required for diagnosis. The test is based on the polymerase chain reaction (PCR) (see Chap. 8) which enables certain selected marker

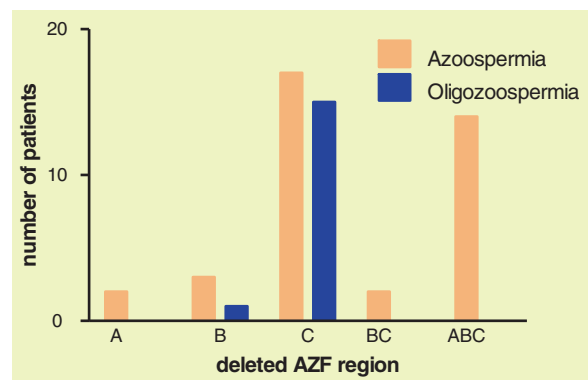

Fig. 13.15 AZF deletions in 40 out of 1,609 infertile men with $< 1 \times 10^6/\text{ml}$ sperm (2.5%) seen at the Institute for Reproductive Medicine, University of Münster

sequences of the long arm of the Y chromosome of patient DNA to be amplified and analyzed. This test should be performed in all men with severely disturbed spermatogenesis of unclear origin. It can be used as a **screening procedure** in these patients without further selection. A first important step towards technical optimization and scientific evaluation of the test was the establishment of laboratory guidelines for the diagnosis of Y chromosome microdeletions (Simoni et al. 2004).

Single cases of spontaneous transmission of an AZFc deletion from father to son have been described (Kühnert et al. 2004). Although there is a 50% chance that sperm will be found in a testicular biopsy with TESE from patients with an AZFc deletion, success rates of ICSI of under 10% seem to be low, possibly due to a high rate of aneuploid sperm. In any event before beginning assisted reproduction genetic counselling is necessary as every son of such a patient will carry the paternal Y chromosome microdeletion and will probably inherit disturbed male fertility (Kamischke et al. 1999).

13.13.3 Structural Abnormalities of the Autosomes

Structural anomalies of the autosomes (chromosome pairs 1–22) may lead to disturbances of male fertility. Their prevalence among infertile men is about 1–2%. For reasons explained in Sect. 13.13 only balanced karyotypes are relevant; for the detailed effects of unbalanced chromosome sets reference should be made to cytogenetic textbooks.

Balanced autosomal anomalies may interfere with the meiotic pairing of the chromosomes and thus adversely affect spermatogenesis. If, and to what extent, disturbed fertility may occur, can hardly be foreseen for individual cases, unlike gonosomal aberrations. The same balanced autosomal aberration can have a severe effect on spermatogenesis in one patient and none at all or only slightly so in another patient. Even between brothers with the same pathological karyotype results from spermograms can differ widely. Therefore, in cases of unclear azoospermia or severe oligozoospermia karyotyping is generally advised.

Often the non-specialist overinterprets the frequent, but functionally irrelevant **chromosomal polymorphisms of the autosomes**, believing them to be pathological. Two particularly frequent findings of this type are small pericentric inversions of chromosome 9 and the enlargement of the pericentromeric heterochromatin of this chromosome (9qh+). These and similar findings have no pathological significance and should not be mentioned to the patient.

In contrast, **reciprocal and Robertsonian translocations** as well as **peri- and paracentric inversions** may have real pathogenic significance. The impact of a given chromosome anomaly of this kind on the spermogram is impossible to predict for the individual case. However, since translocations and inversions are found much more often in infertile men than in unselected neonates, there is no doubt that a pathogenetic relation exists. The most frequent situation arising in clinical practice is that a translocation or inversion is found in a patient with a clearly pathological spermogram, and the question arises whether this is the underlying cause for disturbed spermatogenesis. The question will have to be answered positively if, after all due care, all other reasons for infertility have been excluded. In contrast to numeric chromosomal disturbances and structural anomalies of the gonosomes, autosomal structural aberrations tend to be associated with oligo- rather than with azoospermia.

Translocations and inversions usually represent cases of *familial chromosomal aberrations*. Often an infertile patient is the first family member in whom the aberration is identified. In such a situation a family study should be encouraged. In this manner, often substantial number of relatives may be identified with the same chromosomal aberration as the index patient. The presence of a translocation or inversion is often associated with a higher rate of abortion and, in some cases, the risk for the birth of a severely handicapped child.

13.14 Oviduct Persistence

If the Mullerian inhibiting hormone (MIH) or anti-Muller-hormone (AMH) is not produced at the time of fetal sex differentiation, the Mullerian ducts will fail to regress even in male individuals. Alongside male genitalia, Fallopian tubes and uterus develop from Mullerian ducts. Mutations in the AMH gene or the

AMH receptor gene were described as causes (Imbeaud et al. 1996). As the function of the Leydig cells is not affected, masculine sexual differentiation and puberty takes its normal course. Testicular maldescent and disturbed fertility may, however, be observed. Usually, Fallopian tubes and uterus are coincidentally discovered during herniotomy or laparotomy, or not until autopsy. For therapeutic purposes, uterus and oviducts should be removed; care must be taken that the vasa deferentia, passing through the round ligament, not be injured. If possible, an attempt should be made to position the testes in the scrotum (Josso et al. 2005).

13.15 Gonadal Dysgenesis

13.15.1 Definition

The concept of gonadal dysgenesis covers a group of disorders of genetic origin affecting gonadal differentiation (Berkowitz 1992). A synonym for gonadal dysgenesis is “**streak gonads**”. They are characterized by the **absence of germ cells as well as the lack of Sertoli/granulosa cells**. Histologically, only stromal tissue is found. Three major forms of gonadal dysgenesis can be distinguished:

- Gonadal dysgenesis with 45,X karyotype (Turner syndrome)
- **Pure gonadal dysgenesis** as well as
- **Mixed gonadal dysgenesis**

Pure gonadal dysgenesis is characterized by the presence of bilateral streak gonads, whereas the **mixed form** may have a unilateral streak gonad and contralaterally a more or less completely differentiated and descended testis. XY gonadal dysgenesis can be caused by mutation in different genes involved in testicular development such as WT1, SF1, SRY, SOX9 and DHH (Overview in Hughes et al. 2006, 2008).

13.15.2 Clinical Picture

Individuals with **pure gonadal dysgenesis** and a 46,XX karyotype are phenotypically female, but fail to develop sexually at the anticipated age of puberty. The clinical

picture of individuals with true gonadal dysgenesis and 46,XY karyotypes (Swyer syndrome) is identical, occasionally partial virilization occurs at the expected age of puberty. A typical course of pure gonadal dysgenesis occurs in both XX and XY forms. Females with pure gonadal dysgenesis of the 46,XX-type sometimes have residual ovarian function which allows them to have menstrual cycles for a certain time. In some patients with 46,XY karyotype partial virilization of the external genitalia is present at birth.

Patients with **mixed gonadal dysgenesis**, most of whom bear a chromosomal mosaic of 45,X/46,XY-type, may have intersexual genitalia. Uterus, vagina and oviducts are almost always present, the position of the testis is intra-abdominal, less often inguinal or scrotal. Breast development is rare. The degree of virilization of the external genitals shows considerable variability. Most of these patients are raised as females. The most typical symptoms of patients with a male phenotype are hypospadias and cryptorchidism, as well as androgen deficiency and azoospermia in later life. Growth pattern varies between eunuchoid, normal and Turner-like appearance.

13.15.3 Diagnosis

Aside from patients with established Turner syndrome the diagnosis of pure gonadal dysgenesis can only be ascertained by laparoscopy with gonadal biopsy. In pure gonadal dysgenesis with **46,XX karyotype** LH and FSH are elevated, while estrogens and gestagens are low. Sometimes gonadal dysgenesis occurs in a pedigree; however, mutations in the FSH receptor gene could only be traced in Finnish patients (Aittomäki et al. 1995). The endocrine findings in 46,XY patients are identical with those of the **46,XX variant**. In some patients a mutation of the SRY gene can be found. Mutations in the sex-determining genes (see above) must be sought specifically (Hughes 2008).

In **mixed gonadal dysgenesis** gonadotropin levels are clearly increased. Testosterone is usually below normal for males, but above normal for females. Administration of hCG is often followed by a low, but significant testosterone increase. Laparoscopy always reveals at least vestiges of Mullerian ducts. Biopsies from intra-abdominal streak gonads almost always show only connective tissue similar to ovarian stroma

with no indication of germ cells. Testicular biopsies have revealed single cases of precursor stages of germ cells, but absence of Sertoli cells and of Leydig cell hyperplasia. The karyotype has to be established. Because of phenotypically similar appearance pure gonadal dysgenesis should be considered for differential diagnosis. Moreover, anorchia or bilateral cryptorchidism should be considered as differential diagnosis.

13.15.4 Therapy

At the anticipated age of puberty adequate hormone replacement therapy must be initiated. In cases of intersexual genitalia, surgical correction should enable the affected child to grow up with an unambiguous sexual identity. There is a high risk of neoplastic transformation (gonadoblastoma, seminoma, dysgerminoma, carcinoma in situ) for all patients with a cell line bearing a Y chromosome (Savage and Low 1990). For this reason, streak gonads should be removed surgically in cases where regular check-ups of gonads by ultrasonography are not possible. There is no therapy for infertility. In patients with pure gonadal dysgenesis, pregnancies have been successfully induced following IVF with donor egg cells.

13.16 46,XY Disorders of Sexual Development (DSD) due to Disturbed Testosterone Synthesis

13.16.1 Definition

Whereas in ovotesticular disturbances (formerly known as true hermaphroditism) both testicular as well as ovarian gonadal tissue occurs, a 46,XY disorder of sexual development (formerly male pseudohermaphroditism) is characterized by unambiguous male gonadal and chromosomal sex, but with female or intersexual internal and external genitalia.

Although these patients have testes, phenotypically they appear female – although to highly varying degrees – and consult the physician as females. Enzyme

defects in testosterone biosynthesis as a cause for disturbed sexual development are discussed below, whereas androgen receptor defects in the target organs which also lead to similar clinical manifestations are dealt with in Chap. 17.

13.16.2 Etiology

Disturbances of steroid biosynthesis from cholesterol (see Chap. 2) can take place at every enzymatic step. These may lead to symptoms of mineral or glucocorticoid deficiency as well as to hypogonadism. Enzymatic defects in 20,22-desmolase (P450_{scc}, cholesterol side chain cleavage enzyme), 3 β -hydroxysteroid dehydrogenase and 17 α -hydroxylase which are involved in the synthesis of mineral- or glucocorticoids can also lead to congenital adrenal hyperplasia. Enzyme defects selectively affecting **testosterone biosynthesis** are the **17,20-desmolase-defect** (17,20-lyase defect) and the **17 β -hydroxysteroid-dehydrogenase-defect**. In pathogenetic terms an autosomal recessive mutation in the cytochrome p450_{17 α} -gene is responsible for both the 17,20-desmolase defect and the 17 α -hydroxylase defect. The protein product of this gene (p450c17) has both 17,20-desmolase as well as 17 α -hydroxylase activity.

13.16.3 Clinical Picture

The spectrum of phenotypical variation is broad because of the many aspects of androgen-dependent development and ranges from almost **normal male genitalia** with **mild hypospadias** to formation of **female external genitalia with complete lower vagina, labia and clitoris** (Fig. 13.16). The **testes** are usually **inguinal**, but may also be located **intra-abdominally**, which makes clinical diagnosis especially difficult. The age of puberty often marks the onset of increasing **virilization**, as a consequence of which untreated patients may seek reorientation of their psycho-social gender. Most phenotypically female patients seek medical help because of **hirsutism** and **primary amenorrhoea**. It should be noted that several of the enzyme defects are associated with adrenal insufficiency or hypertension caused by mineral corticoid excess. Particularly in neonates and

Fig. 13.16 Patient with 46,XY disorder of sexual development caused by a 17β -hydroxysteroid-dehydrogenase defect in testosterone biosynthesis. The patient was raised as a girl and sought medical advice for primary amenorrhea without being diagnosed. Diagnosis was not made until the age of 29, when a herniotomy led to the discovery of the intra-abdominal testes. Estrogen substitution therapy was implemented following gonadal exstirpation. (a) Full body view showing male proportions. (b) External genitalia showing “clitoris” hypertrophy and a vaginal introitus



infants the adrenal dysfunction can cause an emergency situation.

13.16.4 Diagnosis

Patients with partial enzyme defects and with **low serum testosterone** levels can be diagnosed because of the accumulation of steroids proximal to the enzyme block. Determination of **$\Delta 4$ -androstendione**, possibly following hGC-stimulation, is of diagnostic relevance for 17β -hydroxysteroid-dehydrogenase defects. As androgens are also estrogen precursors, the concentration of estradiol in serum is also reduced. Diseases of the androgen target organs (androgen resistance) must be excluded by differential diagnosis and screening the androgen receptor for mutations (see Chap. 17).

13.16.5 Therapy

The decision whether neonates are to be raised as girls or boys must be made on an individual basis and depends on the extent of ambiguity of the external genitalia. In addition to necessary surgical correction, sex hormone levels should be monitored closely at the time of expected puberty in order to initiate timely hormone replacement therapy. **Depending on the phenotype, lifelong estrogen or testosterone substitution is indicated** from the time of anticipated puberty. In male phenotypes, non-descended testes should be brought into the scrotum surgically; they should be palpated regularly and monitored by ultrasonography, because of the danger of tumor development. For the same reason, testes should be removed in patients who are brought up and continue their life as females.

For treatment of the possibly coexisting adrenal disturbances reference is made to textbooks of endocrinology.

13.17 Mutations of Gonadotropin Receptors

Specific receptors enable the gonadotropins LH and FSH to become effective in the Leydig or Sertoli cells (see Chap. 2). Mutations in the receptors cause functional alterations in these cells with drastic clinical consequences. Principally **inactivating mutations** must be distinguished from **activating mutations**. Whereas the former lead to a loss of function, the latter mutations cause constitutive i.e., autonomous activity of the target cells without the need for LH or FSH. An overview of the diseases caused by mutations of gonadotropin receptors is provided in [Table 13.2](#).

While investigations into the molecular biology of gonadotropin receptors have allowed highly interesting disease entities to be identified, they have not yet contributed much to the treatment of hypogonadism and infertility because of the rarity of these diseases.

13.17.1 Inactivating LH Receptor Mutations: Leydig Cell Hypoplasia

Leydig cell hypoplasia or Leydig cell agenesis is a very rare disease with an approximate incidence of

1:1,000,000, occurring only in the male sex with a limited autosomal recessive inheritance. The name of the syndrome, Leydig cell agenesis, is misleading as Leydig cells are present but are unable to develop because of an inactivating mutation of the LH receptor which fails to provide the necessary stimulation (Huhtaniemi and Alevizaki 2006).

The phenotype is highly dependent on the extent of intrauterine testosterone secretion. Consequently either (1) **a male phenotype with slight virilization and microphallus** or (2) **hypogonadism with delayed puberty** or (3) a 46,XY disturbance of sexual development (former male pseudohermaphroditism) ([Fig. 13.17](#)) develops. Several inactivating mutations in the LH receptor gene have been described. In a patient with hypogonadism and delayed puberty a mutation in exon 10 of the LH receptor was described which reacts to hCG but not to LH (Gromoll et al. 2000). Thus maternal hCG can stimulate intrauterine testosterone production and male sexual differentiation but postnatally the Leydig cells fail to respond to LH.

The possible appearance of the external genitalia ranges from an unremarkable female phenotype to intersexual genitalia to a predominantly male habitus with microphallus. In the mostly maldescended testes seminiferous tubules can be found. Leydig cells are not present or appear only in immature preliminary stages. Epididymides and deferent ducts are usually present, leading to the conclusion that local intrauterine testosterone production was sufficient for the anlage of these organs. Uterus, tubes or upper vagina are not found in these patients. In those cases where ambivalent genitalia did not lead to diagnosis, delayed puberty usually does.

In such cases basal hormone status, usually with normal FSH, elevated LH and low testosterone provides an initial diagnostic hint of the underlying defect. Depending on the type of LH receptor defect, hCG stimulates either no or a pronounced rise in testosterone. Diagnosis is confirmed by testicular biopsy showing Leydig cell hypoplasia or aplasia and by techniques of molecular biology revealing mutations of the LH receptor gene.

Differential diagnosis should especially differentiate the disease from other 46,XY disorders (formerly male pseudohermaphroditism) on the basis of testosterone synthesis defects, from the adrenogenital syndrome, from 5 α -reductase deficiency and from androgen receptor defects. Early gender assignment,

Table 13.2 Clinical effects of gonadotropin receptor mutations in men

<i>Inactivating LH receptor mutations</i> (Depending on type of mutation)
46,XY disorder of sexual development
Hypogonadism and delayed puberty
Undervirilization and micropenis
<i>Activating LH receptor mutations</i>
Precocious puberty
<i>Inactivating FSH receptor mutations</i>
Infertility
<i>Activating FSH receptor mutations</i>
Intact spermatogenesis despite complete pituitary insufficiency



Fig. 13.17 Patient with Leydig cell hypoplasia and resulting 46,XY disturbance of sexual development (formerly male pseudohermaphroditism) caused by the LH receptor mutation described by Kremer et al. (1995) (Photograph kindly provided by Dr. A. Themmen, Rotterdam)

with microsurgical support, is important. Depending on gender assignment, when the expected age of puberty is reached, lifelong substitution with estrogens or androgens must follow.

13.17.2 Activating LH Receptor Mutations

Activating LH receptor mutations lead to constitutive, LH-independent activity of the Leydig cells, causing **precocious puberty limited to male family members** and often becoming manifest before the 4th year of life. The syndrome is mentioned here for the sake of completeness; reference is made to reviews (e.g., Themmen et al. 1998) and to textbooks of pediatrics or endocrinology.

Activating LH receptor mutations are also described in the section dealing with **Leydig cell tumors** (see Sect. 13.19.4).

13.17.3 Inactivating FSH Receptor Mutations

Inactivating FSH receptor mutations may cause **infertility** (Simoni et al. 1997). In Finland five males were identified bearing an autosomal recessively inherited Cys-189-Thr mutation of the FSH receptor. Although testicular volume was reduced, two males proved to be fertile, one was definitely infertile and the status of the other cases remained unclear (Tapanainen et al. 1997). It is not surprising that complete infertility was not observed, considering that spermatogenesis is guarded by a double safety mechanism through FSH and LH, and the fact that spermatogenesis can be maintained, albeit in reduced form, by LH stimulation alone (Nieschlag et al. 1999).

Wide screening for inactivating FSH receptor mutations revealed that these mutations are largely confined to the Finnish population (Jiang et al. 1998). However, the **FSH receptor shows polymorphism**, mostly affecting amino acid positions 307 (Thr or Ala) and 680 (Asn or Ser). These isoforms of the FSH receptor are equally distributed among fertile and infertile populations (Simoni et al. 1999a, b).

13.17.4 Activating FSH Receptor Mutations

Men with activating mutations of the FSH receptor are difficult to distinguish clinically as they have hardly any characteristic phenotypical traits. So far only one case has been described. This man had intact spermatogenesis despite complete hypophysectomy with loss of gonadotropins and required only testosterone substitution in order to achieve multiple paternity naturally. In his FSH receptor gene an exchange of amino acid Asp and Gly was found in position 567 which was responsible for the constitutive activation of the receptor (Gromoll et al. 1996).

13.18 Ovotesticular Disturbances of Sexual Development (DSD)

13.18.1 Definition and Etiology

An ovotesticular disturbance of sexual development (formerly **true hermaphroditism**) (Hughes et al. 2006) is present when a patient **possesses both testicular and ovarian tissue**. The gonads may consist of uni- or bilateral **ovotestes** with testicular and ovarian tissue. An ovary may also be present on one side and a testis on the other side or there may be combinations with ovotestis.

The exact incidence is not known, only several hundred patients have been described. The largest single series comprised 24 South Africans (Van Niekerk 1974). About two thirds of all patients have a 46,XX karyotype, 10% a 46,XY karyotype, the remaining patients show a chromosomal mosaic with at least one Y cell line. One patient observed by us showed a 46,XX/47,XXY-mosaic (Bergmann et al. 1989). Another patient showed a 45,X/46,X,idic(Y) mosaic. Patients with a Y chromosome reveal the “testis-determining factor” (TDF), in whose presence the primary ambiguous gonads undergo differentiation into testes (McElreavey and Fellous 1997). The etiology of the disease is puzzling in patients with highly differentiated testicular tissue where no Y chromosome can be seen. Abnormal X to Y exchange during paternal meiosis is presumed to be the cause in some 46,XX patients

in whom genetic material of Y chromosomal origin is found. In true “hermaphrodites” without detectable Y chromosomal material, X chromosomal or autosomal genes controlled by SRY are considered as the origin of this condition. The simultaneous occurrence of SRY-negative XX men and 46,XX hermaphroditism indicates an autosomal mutation which may interfere with normal sexual differentiation to various extents.

13.18.2 Clinical Picture

Phenotypically, 90% of patients with ovotesticular disturbance of sexual development (DSD) show intersexual genitalia at birth. The remaining 10% have unambiguous female or male external genitalia, 75% of the patients grow up as males. At the time of puberty, virilization takes place and gynecomastia develops. About half of phenotypic females menstruate and pregnancies have been reported in patients with a 46,XX or 46,XX/46,XY karyotype (first reported by Narita et al. 1975). About one quarter of the phenotypically male patients show cyclic hematuria, whereas ovulation in the ovotestis is taken for testicular pain. In the ovotestis normal spermatogenesis does not take place, whereas in the testes spermatogenesis is observed in about 10% of patients.

13.18.3 Diagnosis

Gonadotropins may be normal or elevated in patients with ovotesticular DSD the serum estrogen and progesterone concentrations depend on a possible ovarian cycle. Diagnosis is made on the basis of biopsy evidence of seminiferous tubules as well as follicle and ovarian stroma in the gonads. Karyotyping is essential in all cases. Diagnosis should differentiate ovotesticular DSD from gonadal dysgenesis, 46,XY DSD, congenital adrenal hyperplasia and androgen resistance.

13.18.4 Therapy

In ovotesticular DSD gender assignment should be made as early as possible and should be supported by plastic surgery of the genitalia if necessary. Neoplastic transformation occurs in about 10% of patients with a Y chromosome and in 4% of patients without a Y

chromosome and is thus a much lower risk than in gonadal dysgenesis. Any decision in favor of excision of the gonads must consider the patient's fertility and hormonal status, along with karyotyping.

In phenotypically male patients with ovotesticular DSD all ovarian tissue must be completely removed. In phenotypically female patients with true hermaphroditism all testicular tissue must be removed to avoid progressive virilization and because of the increased risk of tumors. If the gonads are not removed, close ultrasonographic monitoring is mandatory. If they are removed, lifelong estrogen or androgen hormonal replacement therapy must follow according to the phenotype after puberty.

13.19 Testicular Tumors

13.19.1 Incidence

A testicular tumor is a rare disease among men, with 95% of testicular tumors being malignant germ cell tumors, ca. 2–3% tumors of the stromal cells (Leydig cell and Sertoli cell tumors) and 1–2% secondary tumors of other diseases (e.g., lymphoma metastases, leukemic infiltrates). These are to be differentiated from extratesticular tumors, as e.g., rhabdomyosarcomas of the spermatic chord during childhood or benign tumors (rarely malignant) of the spermatic chord or epididymis (Kliesch 1998).

The malignant germ cell tumor is the most frequent malignant disease of men between the ages of 25 and 40. Its highest incidence is among Caucasians, with lowest frequency in the black population. The incidence of testicular tumors has increased globally by a factor of 3–4 particularly during the last 4–5 decades. The highest rate of growth and total incidence is seen in Scandinavia, Germany, Poland, Switzerland and Hungary, with a doubling in incidence every 15–25 years (Adami et al. 1997). The reasons for this increase are largely unknown. The incidence of testicular tumors varies between 0.7 (USA, black population) and 8.8 (Switzerland) newly reported cases per 100,000 men and year (Buetow 1995).

In addition to **geographic** and **ethnic factors** relevant for these tumors, a series of other **risk factors** is also known. The risk of testicular cancer/carcinoma in situ (CIS) is clearly elevated in men with **mal descended testes** (3%), a **contralateral testicular tumor**

(5–6%), an **extragonadal germ cell tumor** (50%) and **gonadal dysgenesis** (30%). During recent years evidence-based studies identified infertility as an additional risk factor (Raman et al. 2006). Moreover, relatives with testicular tumors (brother, father, uncle) represent additional risk factors (see also current European Consensus Guidelines, Krege et al. 2008).

Several factors are probably responsible for an elevated incidence of testicular tumors in **infertility**. The highest incidence occurs at an age when involuntary childlessness becomes evident. Mal descent can lead to infertility as well as to an increased risk of testicular cancer (see Sect. 13.3). More than other primarily non-testicular diseases, a testicular tumor can lead to **reduced fertility**. Fifty percent of patients with a germ cell tumor have sperm concentrations below 10–15 million/ml (Petersen et al. 1999b). Preexisting disturbances of spermatogenesis along with other causative factors are probably responsible. This is suggested by severely disturbed spermatogenesis seen in 25% of biopsies of the contralateral testis in unilateral germ cell tumors (Berthelsen and Skakkebaek 1983). Testicular atrophy and sonographic inhomogeneities bear an increased risk for testicular tumors especially in patients with severe oligozoospermia (<3 million/ml), testicular atrophy and inhomogeneous sonographic echo pattern (Giwerzman et al. 1997).

Since the introduction of routine ultrasound examination of the testes we have found a testicular tumor in **one of 200 patients consulting for infertility**.

Fifty-nine percent of testicular cancers are germ cell tumors, with seminoma alone representing about half of the cases (Bosl and Motzer 1997). Leydig cell and Sertoli cell tumors represent only a fraction of the total. Testicular intraepithelial neoplasia (TIN) is important as an obligatory precancerous stage of all germ cell tumors (synonymous with CIS) (carcinoma in situ) with the exception of spermatocytic seminoma.

13.19.2 Testicular Intraepithelial Neoplasia (TIN)

TIN is considered an obligatory precancerous stage of a testicular tumor. It is defined as a typical neoplastic gonocyte which is distinguished from normal

spermatogonia both morphologically and immunohistochemically and shares several morphological and immunohistochemical characteristics with embryonic germ cells (see Chap. 11). Without therapeutic intervention 70% of TIN-bearing testes will develop into malignant germ cell tumors within 7 years (Skakkebaek et al. 1987), so that long-range development of a germ cell tumor must be reckoned with. Both seminomas and non-seminomas may develop from a TIN. According to present knowledge the potential for a TIN cell is already present in the anlage of the gonocytes. Just which factors ultimately provoke an invasive germ cell tumor to develop from a TIN cell is not yet understood. However, it is assumed that from a morphological point of view, destruction of the intact wall of the seminal duct during increasing cell divisions of the TIN causes invasion into the peritubular space and leads to further development of the germ cell tumor (Donner et al. 2004).

Both clinical and diagnostic presentation of TIN are heterogenous. Leading symptoms may be decreased seminal parameters along with an inhomogenous sonographic appearance of the testis (microlithiasis testis, see Chap. 6). Diagnosis is only possible by testicular biopsy (fixed in Stieve or Bouin's solution), followed by histological and immunohistological (P1AP, M2A, c-kit, 43-9F, TRA-1-60) tests. Tubules with TIN are normally distributed throughout the affected testis; few, many or all may be affected. Biopsies should always be performed bilaterally. Today it is accepted practice to perform multiple biopsies to assure diagnosis (Kliesch et al. 2003; Diekmann et al. 2007; Krege et al. 2008).

Therapy for TIN depends greatly on biopsy results. If only one of two healthy testes is affected, surgical **ablation** of the affected testis is the safest method. If the remaining testis is affected by TIN (e.g., in a germ cell tumor with contralateral TIN or in a single testis remaining for other reasons), local **irradiation** with 20 Gy (10 fractions of 2 Gy) is the method of choice, as it allows endocrine function to be maintained in the majority of cases even when tubular function is lost (Bamberg et al. 1997; Giwercman et al. 1991). Till recently a reduction of the irradiation dose was not possible for reasons of therapeutic safety (Classen et al. 2003). When chemotherapy is anticipated because of metastases or additional indications, irradiation should be delayed for 6 months after completion of chemotherapy, when a second biopsy should be performed for control purposes. Only if TIN persists should irradiation be carried out. The evidence for this, however, is not strong as

recurrence of TIN can still be observed 10 years after conclusion of chemotherapy. For reasons of safety radiotherapy of the testis can be discussed with the patient after conclusion of chemotherapy. Alternatively lifelong monitoring of the single testis by ultrasound and possibly repeated biopsy may be necessary. Orchidectomy (loss of tubular and endocrine function) is only indicated in exceptional cases when only one remaining testis is affected if Leydig cell function is reduced and if clinical hypogonadism requiring testosterone substitution occurs. Watchful waiting in the sense of active surveillance is necessary in the event of active desire for offspring and remaining spermatogenesis with good semen parameters makes spontaneous conception or active therapy with ART seem likely (Kliesch et al. 1997; Peteren et al. 1999a; Krege et al. 2008).

If both testes are affected by TIN, the same procedures should be followed. When both testes are affected it must be decided, depending on tumor size and localization, which one should be removed (inguinal ablation of the testis) and which one should be treated by organ-sparing tumor enucleation combined with radiotherapy (20 Gy) (Heidenreich et al. 2001; Krege et al. 2008).

13.19.3 Germ Cell Tumors

Malignant cells of TIN can transform into both **seminoma** (with the exception of spermatocytic seminoma) and **non-seminoma** (Table 13.3), for which reason the same risk factors apply as for TIN. Seminoma and non-seminoma account for 95% of all testicular tumors (Bosl and Motzer 1997). Most seminoma reach their peak in the fourth and fifth decade of life, non-seminoma in the third. Almost all germ cell tumors and TIN have an isochromosome on the short arm of chromosome 12 (iso-p12) as a specific chromosome marker (Bosl and Motzer 1997).

- In clinical **stage I** the germ cell tumor is limited to scrotal contents.
- In **stage II** lymphatic metastases are present below the diaphragm and are smaller than 2 cm (IIA), between 2–5 cm (IIB) or larger than 5 cm (IIC, bulky disease).
- Clinical **stage III** is characterized by lymphatic metastases above the diaphragm as extranodular metastases (Bosl and Motzer 1997).

Table 13.3 WHO histological classification of testicular tumors (simplified representation)

Testicular intraepithelial neoplasias (TIN), unclassified
<i>Germ cell tumors</i>
Seminoma
Classic
With syncytiotrophoblastic cells
Spermatocytic seminoma
Embryonic carcinoma
Yolksac tumor
Trophoblastic tumors
Chorion carcinoma
Trophoblastic tumors other than chorion carcinoma
Teratoma
Dermoid cysts
Monodermal teratoma
Teratoma with somatic signs of malignancy
Mixed germ cell tumors
<i>Stromal tumors</i>
Leydig cell tumor
Malignant Leydig cell tumor
Sertoli cell tumor
Malignant Sertoli cell tumor
Granulosa cell tumor
<i>Mixed germinal cell/stromal tumors</i>
Gonadoblastoma
<i>Paratesticular tumor</i>
Adenomatoid tumor
Adenocarcinoma of the testis
Malignant mesothelioma
Mesenchymal tumors of the spermatic chord and testicular adnexes
Secondary testicular tumors

The **clinical picture** of seminoma and non-seminoma is highly variable. The classic complaint is painless testicular swelling. However, testicular pain occurs in 30% of patients so that the most frequent initial false diagnosis is epididymitis (or orchitis). Tumor growth may precipitate rapid decline of ejaculate parameters combined with altered testicular consistency. To the extent that tumor size prompts suspicious findings during palpation, mostly induration with or without an even surface is found. Compromised semen parameters may range from azoospermia to oligoasthenoteratozoospermia of various degrees. A sudden decline of semen parameters should always prompt thorough investigation of the testes. Retroperitoneal lymph node metastases may contribute to development of varicocele and abdominal complaints. About 10% of patients first come to attention because of secondary symptoms (back pain, dyspnoe/hemoptysis). Five percent observe

gynecomastia, which may be one-sided or bilateral and is generally associated with increased β -hCG and consequently with an imbalance between testosterone and estradiol.

When clinical symptoms arise, diagnosis is made by **palpation** and **sonographic investigation**. When tumors are small and at an early stage, palpation rarely indicates intratesticular events. Suspicion arises when sides differ and when alterations in consistency and volume are observed. Of those patients in our clinic in whom a testicular tumor was discovered only **less than one third had a suspicious finding on the basis of palpation; the remainder were discovered exclusively with the aid of ultrasonography** (see Chap. 6). Next to palpation, ultrasonography has become a preeminent tool for the diagnosis of testicular tumors. In ultrasound imaging, testicular tumors appear mostly inhomogenous with areas of increased or reduced echo density.

A further important role in diagnosis and therapy is played by the **tumor markers AFP and β -hCG** which are elevated in one to two thirds of germ cell tumors (especially in non-seminomas) (AFP and β -hCG) and in about 20% of seminomas (only β -hCG). A further marker is **lactate dehydrogenase (LDH)** which correlates with the prognosis of metastasis stage and therefore complements the specific markers. **Placental alkaline phosphatase (PLAP)** (in seminomas) is not a valid marker and no longer plays a role in diagnosis or staging (Krege et al. 2008). Diagnostic certainty is achieved by **testicular biopsy** after inguinal severance of the spermatic chord, possibly with interoperative rapid section diagnostics in cases where the findings are equivocal. The tumor-bearing testis is exposed via inguinal incision, the spermatic chord is fixed by tourniquet and the testis is excised. Histological work-up of the testicular XXX within the framework of this so-called primary therapy is of elemental importance for planning further therapy (Kliesch 2004).

Following surgery the tumor markers are checked and staging is performed by computer tomography of the thorax and abdomen. CT of the skull and skeleton scintigraphy are only indicated if extensive metastases were found during previous examinations (Krege et al. 2008). A contralateral biopsy should be recommended to all patients with a testicular tumor to exclude the possibility of TIN. In cases of testicular atrophy the risk of TIN is clearly increased (Krege et al. 2008).

Thanks to the establishment of multidisciplinary treatment concepts and the introduction of cisplatin to

testicular cancer therapy, germ cell tumors have become a largely curable disease. The first therapeutic step is ablation of the testis on the affected side. When both testes are involved and when paternity is desired possibly only one side can be enucleated (singular tumor <2 cm) and the other side can be ablated.

In addition to distinguishing pure seminoma from non-seminoma the clinical determination of disease stage is of great importance for further therapy. The following evidence-based recommendations were made by the interdisciplinary German Testicular Cancer Study Group (AUO, AIO and ARO) as well as on a European level by the European Germ Cell Cancer Collaborative Group (EGCCCG) concerned with diagnosis and treatment of testicular tumors.

- For **stage I seminoma (high risk)** standard therapy consists of irradiation of infradiaphragmatic para-aortal lymph nodes (20 Gy) or carboplatin monotherapy. Surveillance is recommended for seminoma I without risk factors for metastasing.
- **In stage II seminoma** infradiaphragmatic para-aortal and ipsilateral iliac lymph nodes are irradiated with 30 Gy (stage IIA) or 36 Gy (stage IIB).
- From **stage IIC** onward seminoma chemotherapy with cisplatin follows ablation. Three cycles for patients in the good prognosis group according to

IGCCCG (prognosis groups of the International Germ Cell Cancer Collaborative Group), four cycles with PEB (cisplatin, etoposid, bleomycin) for the intermediate prognosis group as standard therapy.

- For **stage I non-seminoma** a risk-adapted scheme exists: low-risk tumors (risk of metastasis 20%) surveillance is recommended; high-risk tumors (risk of metastasis 50%) polychemotherapy with two cycles PEB. Modified retroperitoneal lymphadenectomy may be an alternative if surveillance and/or chemotherapy are rejected or not practicable.
- For **stage IIA/B** of non-seminomas nerve-sparing lymphadenectomy with or without additional chemotherapy in marker-negative stage IIA or primary chemotherapy and later residual tumor resection is performed in marker-positive stage IIA as well as stage IIB (marker-/marker+).
- For patients with non-seminomas in stage IIC or III therapy follows prognosis criteria (see below).

For patients with advanced stages of disease, therapy plans follow the classification of the International Germ Cell Cancer Collaborative Group (Table 13.4). Patients with good or medium prognosis receive three cycles of PEB. Patients with poor prognosis are treated with four cycles of PEI (cisplatin, etoposid, ifosfamid) or high-dose chemotherapy in the salvage situation.

Table 13.4 Risk classification of the International Germ Cell Cancer Classification Group (Krege et al. 2008)

Good risk (36% of patients) (5 year survival rate 90%)		
Nonseminoma	Gonadal or retroperitoneal primary tumor and "low" markers and non-pulmonary visceral metastases	Low markers: AFP <1000 ng/ml and hCG <1000 ng/ml (5000 IU/l and LDH < 1.5 x upper limit of normal
Seminoma	Any primary site and any marker elevation and nonpulmonary visceral metastases	Low markers: AFP <1000 ng/ml and hCG <1000 ng/ml (5000 IU/l and LDH < 1.5 x upper limit of normal
Intermediate risk (28% of patients) (5 year survival rate 78%)		
Nonseminoma	Gonadal or retroperitoneal primary tumor and "intermediate" markers and nonpulmonary visceral metastases	Intermediate markers: AFP 1000-10000 ng/ml or hCG 1000-10000 ng/ml (5000-50000 IU/L) or LDH 1.5-10 x upper limit of normal
Seminoma	Any primary site and any marker elevation and nonpulmonary visceral metastases present (e.g. bone, liver, brain, CNS)	Intermediate markers: AFP 1000-10000 ng/ml or hCG 1000-10000 ng/ml (5000-50000 IU/L) or LDH 1.5-10 x upper limit of normal
Poor risk (16% of patients) (5 year survival rate 45%)		
Nonseminoma	Mediastinal primary site or gonadal or retroperitoneal primary tumor with nonpulmonary visceral metastases present or high markers	High markers: AFP > 10000 ng/ml or hCG >10000 ng/ml (50000 IU/L) or LDH >10 x upper limit of normal

Residual tumors with metastasizing seminomas are surveilled by PET and only receive further therapy when PET results are positive. Residual tumors in non-seminomas are removed surgically regardless of the size of the remaining lesion.

Prior to bilateral orchidectomy, chemotherapy, testicular or retroperitoneal irradiation or retroperitoneal lymphadenectomy, patients must be given the possibility of cryopreserving their sperm to preserve fertility (see Chap. 24).

During therapy of testicular tumors, unilateral orchidectomy may cause a reduction of sperm concentration along with elevated FSH. If nerve-protective modified retroperitoneal lymphadenectomy is performed, 10% of cases will show disturbed ejaculation (especially retrograde ejaculation) (Kliesch 2003). When nerve-sparing modified retroperitoneal lymphadenectomy or residual tumor resection is performed the rates of retrograde ejaculation or anejaculation lie between 30% and 50%, in radical surgery the rate is 100%. When irradiation is performed (Chap. 19), disturbed spermatogenesis may follow because of scattered rays affecting the remaining testis (ca. 1.7 Gy without, 0.5 Gy with gonad protection); this is mostly reversible (Greiner 1982; Hansen et al. 1990). The standard therapy of testicular tumors based on cisplatin almost always acutely causes azoospermia with elevated FSH. As for irradiation, precise prognosis of possible long-term effects of chemotherapy on spermatogenesis is not possible because of great individual variation. Chemotherapy dose, basal seminal values and duration of follow-up intervals are among those factors influencing such variation. Most patients experience at least a partial recovery of spermatogenesis during the 2nd to 4th year following cessation of chemotherapy. Patients receiving a cumulative total dose of more than 600 mg/m² cisplatin must reckon with permanent azoospermia or severe oligozoospermia. Elevation of LH may follow ablation, irradiation or chemotherapy. Testosterone levels usually remain in the normal range. Twenty-five percent of all patients with germ cell tumors experience testosterone deficiency (often subclinical) following termination of oncological therapy (Pühse et al. 2005). Should **testosterone deficiency** occur, testosterone must be substituted as after bilateral orchidectomy (see Chap. 21).

In total today the rate of cure of germ cell tumors is excellent, and is 99–100% in stage I for seminomas and non-seminomas and at least 96% for stages II A/B.

In advanced metastasizing stages (at least IIC) the probability of cure is 90% in the good prognosis group (56% of patients), 78% for the middle prognosis group (28% of patients), and 45% for the poor prognosis group (16% of patients).

13.19.4 Testicular Tumors with Endocrine Activity

Along with germ cell tumors, the rarely occurring Leydig cell tumors and Sertoli cell tumors, both stromal tumors, always show endocrine activity.

Leydig cell tumors are generally benign neoplasms and account for about 1–2% of all testicular tumors. They usually measure less than 5 cm. The larger they are, the greater the chance of malignancy. Prospective data on this topic are not available. Within the framework of the Leydig Cell Tumor Register of the AUO, one tumor with retroperitoneal metastasis could be identified among 85 consecutively registered patients (Kliesch unpublished). Prior to puberty they are almost always benign (Freeman 1986). Whereas before puberty they mostly produce androgens, thus leading to **precocious pseudopuberty**, after puberty they tend to produce estrogens without necessarily producing measurable levels.

Causes of Leydig cell tumors were long unknown. In recent times, however, activating mutations of the LH receptor in Leydig cell tumors were described in boys (Liu et al. 1999) as well as in adults (Fragoso et al. 1998). These arginine-to-cysteine (Arg 201 cys) or asparagine-to-histidine (Asp 578 his) mutations may cause tumor development as well as possible alterations in the expression of a relaxin-like factor (Klonisch et al. 1999).

In adult patients feminization occurs with a characteristic **triad of symptoms: gynecomastia, impotence and testicular tumor** (Fig. 17.8).

Clinical symptoms, however, may be very discrete. The contralateral testis and the tissue surrounding the tumor may atrophy via feedback inhibition of the hypothalamic/pituitary function by estrogens. Spermatogenesis comes to a halt; the patient may be azoospermic or

oligozoospermic. After enucleation or removal of the afflicted testis (if paternity is desired, enucleation with rapid section diagnosis should be performed), symptoms usually disappear quickly. Malignancy occurs in about 10%; it cannot be established on the basis of histology of the Leydig cell tumor. When metastases are found, they must be removed surgically as Leydig cell tumors are not radio- or chemosensitive.

Sertoli cell tumors are very rare and occur mostly in adolescents (Chang et al. 1998). They are almost always benign and may be associated with a Peutz-Jeghers syndrome. About 24% of patients with Sertoli cell tumors show signs of feminization because of increased estrogen production and symptoms seen in Leydig cell tumors (Gabrilove et al. 1980). Gynecomastia occurs in about 16% of patients with benign and in 60% of patients with malignant Sertoli cell tumors. Orchiectomy is the therapy of choice.

References

- Ahlfeld F (1880) Die Missbildungen des Menschen. Grunow, Leipzig
- Aittomäki K, Lucena JLD, Pakaranin P, Sistonen P, Tapanainen J, Gromoll J, Kashikari R, Sankila E-M, Lehtväslaiho H, Engel AR, Nieschlag E, Huhtaniemi I, de la Chapelle A (1995) Mutation in the follicle-stimulating hormone receptor gene causes hereditary hypergonadotropic ovarian failure. *Cell* 82:959–959
- Akslaade L, Wikström AM, Rajpert-De Meyts E, Dunkel L, Skakkebaek NE, Juul A (2006) Natural history of seminiferous tubule degeneration in Klinefelter syndrome. *Hum Reprod Update* 12:39–48
- Al-Said S, Al-Naimi A, Al-Ansari A, Younis N, Shamsodini A, A-Sadiq K, Shokeir AA (2008) Varicocelectomy for male infertility: a comparative study of open, laparoscopic and microsurgical approaches. *J Urol* 180:266–270
- Arap MA, Vicentini FC, Cocuzza M, Hallak J, Athayde K, Lucon AM, Arap S, Srougi M (2007) Late hormonal levels, semen parameters and presence of antisperm antibodies in patients treated for testicular torsion. *J Androl* 28:528–532
- AWMF-Leitlinie (2009) Hodenhochstand Nr. 006/022
- Bastida MG, Rey RA, Bergadá I, Bedecarrás P, Andreone L, del Rey G, Boywitt A, Ropelato MG, Cassinelli H, Arcari A, Campo S, Gottlieb S (2007) Establishment of testicular endocrine function impairment during childhood and puberty in boys with Klinefelter syndrome. *Clin Endocrinol* 67: 863–870
- Bates SE (1991) Clinical applications of serum tumor markers. *Ann Intern Med* 115:623–638
- Bergère M, Wainer R, Nataf V, Bailly M, Gombault M, Ville Y, Selva J (2002) Biopsied testis cells of four 47,XXY patients: fluorescence in-situ hybridization and ICSI results. *Hum Reprod* 17:32–37
- Bergholz R, Koch B, Spieker T, Lohse K (2007) Polyorchidism: a case report and classification. *J Pediatric Surgery* 42:1933–1935
- Bergmann M, Schleicher G, Böcker R, Nieschlag E (1989) True hermaphroditism with bilateral ovotestis: a case report. *J Androl* 12:139–147
- Bergmann M, Behre HM, Nieschlag E (1994) Serum FSH and testicular morphology in male infertility. *Clin Endocrinol* 40:133–136
- Berthelsen JG, Skakkebaek NE (1983) Gonadal function in men with testis cancer. *Fertil Steril* 39:68–75
- Bojesen A, Juul S, Gravholt CH (2003) Prenatal and postnatal prevalence of Klinefelter syndrome: a national registry study. *J Clin Endocrinol Metab* 88:622–626
- Bojesen A, Juul S, Birkebaek NH, Gravholt CH (2006a) Morbidity in Klinefelter syndrome: a Danish register study based on hospital discharge diagnoses. *J Clin Endocrinol Metab* 91:1254–1260
- Bojesen A, Kristensen K, Birkebaek NH, Fedder J, Mosekilde L, Bennett P, Laurberg P, Frystyk J, Flyvbjerg A, Christiansen JS, Gravholt CH (2006b) The metabolic syndrome is frequent in Klinefelter's syndrome and is associated with abdominal obesity and hypogonadism. *Diab Care* 29:1591–1598
- Bosl GJ, Motzer RJ (1997) Testicular germ-cell cancer. *N Engl J Med* 337:242–253
- Bouayed Abdelmoula N, Portnoi MF, Keskes L, Recan D, Bahloul A, Boudawara T, Saad A, Rebai T (2003) Skewed X-chromosome inactivation pattern in SRY positive XX maleness: A case report and review of literature. *Ann Genet* 46:11–18
- Bukowski TP, Wacksman J, Billmire DA, Lewis AG, Sheldon CA (1995) Testicular autotransplantation: A 17-year review of an effective approach to the management of the intraabdominal testis. *J Urol* 154:558–561
- Carrell DT, Emery BR, Liu L (1999) Characterization of aneuploidy rates, protamine levels, ultrastructure, and functional ability of roundheaded sperm from two siblings and implications for intracytoplasmic sperm injection. *Fertil Steril* 71:511–516
- Chandley AC, Cooke HJ (1994) Human male fertility – Y-linked genes and spermatogenesis. *Hum Molec Genet* 3:1449–1452
- Chang B, Borer JG, Tan PE, Diamond DA (1998) Large-cell calcifying Sertoli cell tumor of the testis: case report and review of the literature. *Urology* 52:520–523
- Chehval MJ, Purcell RN (1992) Deterioration of semen parameters over time in men with untreated varicocele: evidence of progressive testicular damage. *Fertil Steril* 57:174
- Classen J, Dieckmann K, M, Souchon R, Kliesch S, Kuehn M, Loy V; German Testicular Cancer Study Group (2003) Radiotherapy with 16 Gy may fail to eradicate testicular intraepithelial neoplasia: preliminary communication of a dose-reduction trial of the German Testicular Cancer Study Group. 88:828–831
- Cools M, Drop SLS, Wolffenbuttel KP, Oosterhuis JW, Looijenga LHJ (2006) Germ cell tumors in the intersex gonad: old paths, new directions, moving frontiers. *Endocr Rev* 27:468–484
- Cortes D, Thorup J, Visfeldt J (2000) Hormonal treatment may harm the germ cells in 1 to 3-year-old boys with cryptorchidism. *J Urol* 163:1290–1292
- Dadoune JP (1988) Ultrastructural abnormalities of human spermatozoa. *Hum Reprod* 3:311–318

- Dam AHDM, Feenstra I, Westphal JR, Ramos L, van Golde RJT, Kremer JAM (2007) Globozoospermia revisited. *Hum Reprod Update* 13:63–75
- Davenport M, Brain C, Vandenberg C, Zappala S, Duffy P, Ransley PG, Grant D (1995) The use of the hCG stimulation test in the endocrine evaluation of cryptorchidism. *Br J Urol* 76:790–794
- Del Castillo EB, Trabucco A, de la Balze A (1947) Syndrome produced by absence of the germinal epithelium without impairment of the Sertoli or Leydig cells. *J Clin Endocr* 7:493
- Deutsche Gesellschaft für Endokrinologie (DGE) (1991) Zur Therapie des Hodenhochstandes. *Endokrinologie-Informationen* pp 20–22
- Dieckmann KP, Kulejewski M, Pichlmeier U, Loy V (2007) Diagnosis of contralateral testicular intraepithelial neoplasia (TIN) in patients with testicular germ cell cancer: systematic two-site biopsies are more sensitive than a single random biopsy. *Eur Urol* 51:175–183
- Donner J, Kliesch S, Brehm R, Bergmann M (2004) From carcinoma in situ to testicular germ cell tumour. *APMIS* 112:79–88
- von Eckardstein S, Simoni M, Bergmann M, Weinbauer GF, Gassner P, Schepers AG, Nieschlag E (1999) Serum inhibin B in combination with serum follicle-stimulating hormone (FSH) is a more sensitive marker than serum FSH alone for impaired spermatogenesis in men, but cannot predict the presence of sperm in testicular tissue samples. *J Clin Endocrinol Metab* 84:2496–2501
- Elsawi MM, Pryor JP, Klufio G, Barnes C, Patton MA (1994) Genital tract function in men with Noonan syndrome. *Med Genet* 31:468–470
- Ergün S, Bruns T, Tauber R (1996) Die vaskuläre Organisation des Plexus pampiniformis beim Mann und ihre Bedeutung bei der antegraden Sklerosierung der Varikozele testis. *Urologe A* 35:463–467
- European Association of Urology. Guidelines on male infertility. Dohle GR, Weidner W, Jungwirth A, Colpi G, Papp G, Pomeroy J, Hargreave TB (2004) Urology online
- Evers JL, Collins JA (2003) Assessment of efficacy of varicocele repair for male subfertility: a systematic review. *Lancet* 361:1849–1852
- Evers JH, Collins J, Clarke J (2008) Surgery or embolisation for varicoceles in subfertile men. *Cochrane Database Syst Rev* CD000479
- Fechner PY, Marcantonio SM, Jaswaney V, Stetten G, Goodfellow PN, Migeon CJ, Smith KD, Berkovitz GD (1993) The role of the sex-determining region Y gene in the etiology of 46,XX maleness. *J Clin Endocrinol Metab* 76:690–695
- Ferlin A, Arredi B, Speltra E, Cazzadore C, Selice R, Garolla A, Lenzi A, Foresta C (2007) Molecular and clinical characterization of Y chromosome microdeletions in infertile men: a 10-year experience in Italy. *J Clin Endocrinol Metab* 92:762–770
- Forman D, Moller H (1994) Testicular cancer. *Cancer Surv* 19–20:323–341
- Fragoso MC, Latronico AC, Carvalho FM, Zerbini MC, Marcondes JA, Araujo LM, Lando VS, Frazzatto ET, Mendonca BB, Villares SM (1998) Activating mutation of the stimulatory G protein (gsp) as a putative cause of ovarian and testicular human stromal Leydig cell tumors. *J Clin Endocrinol Metab* 83:2074–2078
- Freeman DA (1986) Steroid hormone-producing tumors in man. *Endocr Rev* 7:204–220
- Gabrilove JL, Freiberg EK, Leiter E, Nicolis GL (1980) Feminizing and non-feminizing Sertoli cell tumors. *J Urol* 124:757–767
- Garner MJ, Turner MC, Ghadirian P, Krewski D (2005) Epidemiology of testicular cancer: an overview. *Int J Cancer* 116:331–339
- Giwerzman A, von der Maase H, Berthelsen JG, Rorth M, Bertelsen A, Skakkebaek NE (1991) Localized irradiation of testes with carcinoma in situ: effects on Leydig cell function and eradication of malignant germ cells in 20 patients. *J Clin Endocr Metab* 72:596–603
- Giwerzman A, von der Maase H, Skakkebaek NE (1993) Epidemiological and clinical aspects of carcinoma in situ of the testis. *Eur Urol* 23:104–114
- Giwerzman A, Thomsen JK, Hertz J, Berthelsen JG, Jensen V, Meinecke B, Thormann L, Storm HH, Skakkebaek NE (1997) Prevalence of carcinoma in situ of the testis in 207 oligozoospermic men from infertile couples: prospective study of testicular biopsies. *BMJ* 315:989–991
- Grasso M, Lania C, Castelli M, Galli L, Franzoso F, Rigatti P (2000) Lowgrade left varicocele in patients over 30 years old: the effect of spermatic vein ligation on fertility. *BJU Int* 85: 305–307
- Gromoll J, Simoni M, Nieschlag E (1996) An activating mutation of the follicle-stimulating hormone receptor autonomously sustains spermatogenesis in a hypophysectomized man. *J Clin Endocrinol Metab* 81:1367–1370
- Gromoll J, Eiholzer U, Nieschlag E, Simoni M (2000) Male hypogonadism caused by a homozygous deletion of exon 10 of the luteinizing hormone receptor. *J Clin Endocr Metab* 85:2281–2286
- Hadziselimovic F, Herzog B (1997) Treatment with a luteinizing hormone-releasing hormone analogue after successful orchiopexy markedly improves the chance of fertility later in life. *J Urol* 158:1193–1195
- Hakami M, Mosavy SH (1975) Triorchidism with normal spermatogenesis: an unusual cause for failure of vasectomy. *Br J Surg* 62:633
- Hamilton JB, Mestler GE (1969) Mortality and survival: comparison of eunuchs with intact men and women in a mentally retarded population. *J Gerontol* 24:395–411
- Handelsman DJ, Conway AJ, Boylan LM, Turtle JR (1984) Testicular function in potential sperm donors: normal ranges and the effects of smoking and varicocele. *Int J Androl* 7:369–382
- Hansen PV, Trykker H, Svennekjaer IL, Hvolby J (1990) Long-term recovery of spermatogenesis after radiotherapy in patients with testicular cancer. *Radiother Oncol* 18: 117–125
- Hargreave TB (1997) Varicocele: Overview and commentary on the results of the WHO varicocele trial. In: Waites GMH, Frick J, Baker GUH (eds) *Current advances in andrology*. Monduzzi, Bologna, pp 31–44
- Hasle H, Mellempgaard A, Nielsen J, Hansen J (1995) Cancer incidence in men with Klinefelter syndrome. *Br J Cancer* 71:416–420
- Heidenreich A, Weissbach L, Hörtl W, Albers P, Kliesch S, Köhrmann KU, Dieckmann KP; German Testicular Cancer Study Group (2001) Organ sparing surgery of malignant germ cell tumor of the testis. *J Urol* 166:2161–2165

- Henna MR, Del Nero RG, Smapaio CZ, Atalah AN, Schettini ST, Castro AA, Soares BG (2004) Hormonal cryptorchidism therapy: systematic review with metanalysis of randomized clinical trials. *Pediatr Surg Int* 20:357–359
- Hiort O, Wünsch L, Holterhus PM (2005) Differenzialdiagnostische Überlegungen beim Hodenhochstand. *Monatsschrift Kinderheilkd* 153:430–435
- Holstein AF, Roosen-Runge EC, Schirren C (1988) Illustrated pathology of human spermatogenesis. Grosse, Berlin
- Hoorweg-Nijman JJG, Havers HM, Delemarre-van de Waal HA (1994) Effect of human chorionic gonadotrophin (hCG)/follicle-stimulating hormone treatment versus hCG treatment alone on testicular descent: a double-blind placebo-controlled study. *Eur J Endocrinol* 130:60–64
- Horing S, Miller FG (2002) Is placebo surgery unethical? *N Engl J Med* 347:137–139
- Horowitz M, Wishart JM, O'Loughlin PD, Morris HA, Need AG, Nordin BEC (1992) Osteoporosis and Klinefelter's syndrome. *Clin Endocrinol* 36:113–118
- Horwich A, Shipley J, Huddart R (2006) Testicular germ-cell cancer. *Lancet* 367:754–765
- Hucklenbroich K, Gromoll J, Heinrich M, Hohoff C, Nieschlag E, Simoni M (2005) Partial deletions in the AZFc region of the Y chromosome occur in men with impaired as well as normal spermatogenesis. *Hum Reprod* 20:191–197
- Huff DS, Hadziselimovic F, Sayder III HM, Beyth B, Duckett JW (1991) Early postnatal testicular maldevelopment in cryptorchidism. *J Urol* 146:624–626
- Hughes IA, Houk C, Ahmed SF, Lee PA; LWPES Consensus Group; ESPE Consensus Group (2006) Consensus statement on management of intersex disorders. *Arch Dis Child* 91:554–563
- Hughes IA (2008) Disorders of sex development: a new definition and classification. *Best Pract Res Clin Endocrinol Metab* 22:119–134
- Huhtaniemi I, Alevizaki M (2006) Gonadotrophin resistance. *Best Pract Res Clin Endocrinol Metab* 20:561–576
- Hung AJ, King P, Schlegel PN (2007) Uniform testicular maturation arrest: a unique subset of men with nonobstructive azoospermia. *J Urol* 178:608–612
- Hutson JM, Hasthorpe S (2005) Testicular descent and cryptorchidism: the state of the art in 2004. *J Pediatr Surg* 40:297–302
- Ichioka K, Utsunomiya N, Kohei N, Ueda N, Inoue K, Terai A (2006) Adult onset of declining spermatogenesis in a man with nonmosaic Klinefelter's syndrome. *Fertil Steril* 85:1511–1512
- Imbeaud S, Belville C, Messika-Zeitoun L, Rey R, di Clemente N, Josso N, Picard J-Y (1996) A 27 base-pair deletion of the anti-Müllerian type II receptor gene is the most common cause of persistent Müllerian duct syndrome. *Hum Molec Genet* 5:1269–1277
- Jacobeit J, Kliesch S (2008) Diagnostik und Therapie der Gynäkomastie. *DMW* 133:2567–2571
- Jiang M, Aittomäki K, Nilsson C, Pakarinen P, Iitia A, Torresani T, Simonsen H, Goh V, Petterson K, de la Chapelle A, Huhtaniemi I (1998) The frequency of an inactivating point mutation (566C→T) of the human follicle-stimulating hormone receptor gene in four populations using allele-specific hybridization and time-resolved fluorometry. *J Clin Endocrinol Metab* 83:4338–4343
- Josso N, Belville C, di Clemente N, Picard JY (2005) AMH and AMH receptor defects in persistent Müllerian duct syndrome. *Hum Reprod Update* 11:351–156
- Josso N, Picard JY, Rey R, di Clemente N (2006) Testicular anti-Müllerian hormone: history, genetics, regulation and clinical applications. *Pediatr Endocrinol Rev* 3:347–358
- Kaleva M, Arsalo A, Louhimo I, Rapola J, Perheentupa J, Henriksen K, Toppari J (1996) Treatment with human chorionic gonadotrophin for cryptorchidism: clinical and histological effects. *Int J Androl* 19:293–298
- Kamischke A, Gromoll J, Simoni M, Behre HM, Nieschlag E (1999) Transmission of a Y chromosomal deletion involving the deleted in azoospermia (DAZ) and chromodomain (CDY1) genes from father to son through intracytoplasmic sperm injection: case report. *Hum Reprod* 14:2320–2322
- Kamischke A, Nieschlag E (2001) Varicocele treatment in the light of evidence-based andrology. *Hum Reprod Update* 7:65–69
- Kamischke A, Baumgardt A, Horst J, Nieschlag E (2003) Clinical and diagnostic features of patients with suspected Klinefelter syndrome: *J Androl* 24:41–48
- Kliesch S (1998) Tumoren und Fehlbildungen des Nebenhodens und des Samenstranges. In: Krause W, Weidner W (Hrsg) *Andrologie–Krankheiten der männlichen Geschlechtsorgane*. 3. Aufl Enke, Stuttgart, pp 220–223
- Kliesch S (2003) Fertilität bei Patienten mit Hodentumorerkrankungen. *Der Onkologe* 9:955–961
- Kliesch S (2004) Diagnostik und Primärtherapie des Hodentumors. *Urologe* 43:1494–1499
- Kliesch S, Bergmann M, Hertle L, Nieschlag E, Behre HM (1997) Semen parameters and testicular pathology in men with testicular cancer and contralateral carcinoma in situ or bilateral testicular malignancies. *Hum Reprod* 12:2830–2835
- Kliesch S, Thomaidis T, Schütte B, Pühse G, Kater B, Roth S, Bergmann M (2003) Update on the diagnostic safety for detection of testicular intraepithelial neoplasia (TIN). *APMIS* 111:70–74
- Klonisch T, Ivell R, Balvers M, Kliesch S, Fischer B, Bergmann M, Steger K (1999) Expression of relaxin-like factor is down-regulated in human testicular Leydig cell neoplasia. *Molecular Human Reproduction* 5:104–108
- Kostiner DR, Turek PJ, Reijo RA (1998) Male infertility: analysis of the markers and genes on the human Y chromosome. *Hum Reprod* 13:3032–3038
- Krause W, Müller HH, Schäfer H, Weidner W (2002) Does treatment of varicocele improve male fertility? Results of the Deutsche Varikozelenstudie, a multicentre study of 14 collaborating centres. *Andrologia*, 34:164–171
- Krege S, Beyer J, Souchon R, Albers P, Albrecht W, Algaba F, Bamberg M, Bodrogi I, Bokemeyer C, Cavallin-Stähl E, Classen J, Clemm C, Cohn-Cedermark G, Culine S, Daugaard G, De Mulder PH, De Santis M, de Wit M, de Wit R, Derigs HG, Dieckmann KP, Dieing A, Droz JP, Fenner M, Fizazi K, Flechon A, Fosså SD, del Muro XG, Gauler T, Geczi L, Gerl A, Germa-Lluch JR, Gillissen S, Hartmann JT, Hartmann M, Heidenreich A, Hoeltl W, Horwich A, Huddart R, Jewett M, Joffe J, Jones WG, Kisbenedek L, Klepp O, Kliesch S, Koehrmann KU, Kollmannsberger C, Kuczyk M, Laguna P, Galvis OL, Loy V, Mason MD, Mead GM, Mueller R, Nichols C, Nicolai N, Oliver T, Ondrus D, Oosterhof GO, Ares LP, Pizzocaro G, Pont J, Pottek T, Powles T, Rick O, Rosti G, Salvioni R, Scheiderbauer J, Schmelz HU, Schmidberger H,

- Schmoll HJ, Schrader M, Sedlmayer F, Skakkebaek NE, Sohaib A, Tjulandin S, Warde P, Weinknecht S, Weissbach L, Wittekind C, Winter E, Wood L, von der Maase H. (2008) European consensus conference on diagnosis and treatment of germ cell cancer: a report of the second meeting of the European Germ Cell Cancer Consensus group (EGCCCG): Part I. *Eur Urol* 53:478–496; Part II *Eur Urol* 53:497–513
- Kremer H, Kraaij R, Toledo SPA, Post M, Fridman JB, Hayashida CY, van Reen M, Milgrom E, Ropers H-H, Mariman E, Themmen APN, Brunner HG (1995) Male pseudohermaphroditism due to a homozygous missense mutation of the luteinizing hormone receptor gene. *Nat Genet* 9:160–164
- Ku JH, Kim YH, Jeon YS, Lee NK (1999) The preventive effect of systemic treatment with interferon- α 2B for infertility from mumps orchitis. *BJU Int* 84:839–842
- Kubler A, Schulz G, Cordes U, Beyer J, Krause U (1992) The influence of testosterone substitution on bone mineral density in patients with Klinefelter's syndrome. *Exp Clin Endocrinol* 100:129–132
- Kühnert B, Gromoll J, Kostova E, Tschanter P, Luetjens CM, Simoni M, Nieschlag E (2004) Case report: natural transmission of an AZFc Y-chromosomal microdeletion from father to his sons. *Hum Reprod* 19:886–888
- Kuhn JM, Mahoudeau JA, Billaud L, Joly J, Rieu M, Gance A, Archambeaud-Mouvieroux F, Steg A, Luton JP (1987) Evaluation of diagnostic criteria for Leydig cell tumours in adult men revealed by gynaecomastia. *Clin Endocrinol* 26:407–416
- Kumanov P, Robeva RN, Tomova A (2008) Adolescent varicocele: who is at risk? *Pediatrics* 121:e53–e57
- Lanfranco F, Kamischke A, Zitzmann M, Nieschlag E (2004) Klinefelter's syndrome. *Lancet* 364:273–283
- Latronico AC, Anasti J, Arnhold IJP, Rapaport R, Menodona BB, Bloise W, Castro M, Tsigos C, Chrousos GP (1996) Testicular and ovarian resistance to luteinizing hormone caused by inactivating mutations of the luteinizing hormone receptor gene. *New Engl J Med* 334:507–512
- Latronico AC, Chai Y, Arnhold IJP, Liu X, Mendonca BB, Segaloff DL (1998) A homozygous microdeletion in helix 7 of the luteinizing hormone receptor associated with familial testicular and ovarian resistance is due to both decreased cell surface expression and impaired effector activation by the cell surface receptor. *Mol Endocrinol* 12:442–450
- Laue L, Wu SM, Kudo M, Hsueh AJ, Cutler Jr GB, Griffin JE, Wilson JD, Brain C, Berry AC, Grant DB (1995) A nonsense mutation of the luteinizing hormone receptor gene in Leydig cell hypoplasia. *Hum Mol Gen* 4:1429–1433
- Laue L, Wu SM, Kudo M, Bourdony CJ, Cutler GB, Hsueh AJW, Chan WY (1996) Compound heterozygous mutations of the luteinizing hormone receptor gene in Leydig cell hypoplasia. *Mol Endocrinol* 10:987–997
- Laven JSE, Haans CF, Mali WPTM, te Velde ER, Wensing CJG, Eimers JM (1992) Effect of varicocele treatment in adolescents: a randomized study. *Fertil Steril* 58:756
- Lee JH, Gye MC, Choi KW, Hong JY, Lee YB, Park DW, Lee SJ, Min CK (2007) In vitro differentiation of germ cells from nonobstructive azoospermic patients using three-dimensional culture in a collagen gel matrix. *Fertil Steril* 87:824–833
- Lee MM, Donahoe PK, Silverman BL, Hasegawa T, Hasegawa Y, Gustafson ML, Chang Y, MacLaughlin DT (1997) Measurements of serum Müllerian inhibiting substance in the evaluation of children with nonpalpable gonads. *N Engl J Med* 336:1480–1486
- Lee PA (2005) Fertility in cryptorchidism: epidemiology and other outcome studies. *Urology* 66:427–431
- Lemcke B, Zentgraf J, Behre HM, Kliesch S, Nieschlag E (1996) Longterm effects on testicular function of high-dose testosterone treatment for excessively tall stature. *J Clin Endocrinol Metab* 81:144–152
- Lenz P, Luetjens CM, Kamischke A, Kühnert B, Kennerknecht I, Nieschlag E (2005) Mosaic status in lymphocytes of infertile men with or without Klinefelter syndrome. *Hum Reprod* 20:1248–1255
- Leung AKC (1988) Polyorchidism. *AFP* 38:153–156
- Liu G, Duranteau L, Carel JC, Monroe J, Doyle DA, Shenker A (1999) Leydig cell tumors caused by an activating mutation of the gene encoding the luteinizing hormone receptor. *New Engl J Med* 341:1731–1736
- Liu J, Nagy Z, Joris H, Tournaye H, Devroey P, van Steirteghem A (1995) Successful fertilization and establishment of pregnancies after intracytoplasmic sperm injection in patients with globozoospermia. *Hum Reprod* 10:626–629
- Lobacarro J-M, Medlej R, Berta P, Belon C, Galifer R-B, Guthmann J-P, Chevalier C, Czernichow P, Dumas R, Sultan C (1993) PCR analysis and sequencing of the SRY sex determining gene in four patients with bilateral congenital anorchia. *Clin Endocrinol* 38:197–201
- Loy V, Dieckmann KP (1993) Prevalence of contralateral testicular intraepithelial neoplasia (carcinoma in situ) in patients with testicular germ cell tumour. *Eur Urol* 23:120–122
- Luddi A, Margollicci M, Gambera L, Serafini F, Cioni M, De Leo V, Balestri P, Piomboni P (2009) Spermatogenesis in a man with complete deletion of USP9Y. *N Engl J Med* 360:881–885
- Madgar I, Weissenberg R, Lunenfeld B, Karasik A, Goldwasser B (1995) Controlled trial of high spermatic vein ligation for varicocele in infertile men. *Fertil Steril* 63:120–124
- Marcus KA, Sweep CG, van der Burgt I, Noordam C (2008) Impaired Sertoli cell function in males diagnosed with Noonan syndrome. *J Pediatr Endocrinol Metab* 21: 1079–1084
- Marmar JL (2001) Varicocele and male infertility: Part II. The pathophysiology of varicoceles in the light of current molecular and genetic information. *Hum Reprod Update* 7:461–472
- Marmar JL, Agarwal A, Prabakaran S, Agarwal R, Short RA, Benoff S, Thomas AJ (2007) Reassessing the value of varicolectomy as a treatment for male subfertility with a new meta-analysis. *Fertil Steril* 88:639–648
- Martens JWM, Verhoef-Post M, Abelin N, Ezabella M, Toledo SPA, Brunner HG, Themmen APN (1998) A homozygous mutation in the luteinizing hormone receptor causes partial Leydig cell hypoplasia: correlation between receptor activity and phenotype. *Mol Endocrinol* 12:775–784
- Martin-du Pan RC, Campana A (1993) Physiopathology of spermatogenic arrest. *Fertil Steril* 60:937–946
- McEachern R, Houle AM, Garel L, Van Vliet G (2004) Lost and found testes: the importance of the hCG stimulation test and other testicular markers to confirm a surgical declaration of anorchia. *Horm Res* 62:124–128
- McElreavey K, Fellous M (1997) Sex-determining genes. *Trends Endocr Metab* 8:342–346

- McElreavey K, Krausz C (1999) Male infertility and the Y chromosome. *Am J Hum Genet* 64:928–933
- Meschede D, Horst J (1999) Indikationen, Möglichkeiten, Grenzen und Perspektiven cytogenetischer Untersuchungen für die Reproduktionsmedizin. *Med Genetik* 11:365–368
- Meschede D, Louwen F, Eiben B, Horst J (1997) Intracytoplasmic sperm injection pregnancy with fetal trisomy 9p resulting from a balanced paternal translocation. *Hum Reprod* 12:1913–1914
- Meschede D, Louwen F, Nippert I, Holzgreve W, Miny P, Horst J (1998) Low rates of pregnancy termination for prenatally diagnosed Klinefelter syndrome and other sex chromosome polysomies. *Am J Med Genet* 80:330–334
- Misrahi M, Meduri G, Pissard S, Bouvattier C, Beau I, Loosfelt H, Jolivet A, Rappaport R, Milgrom E, Bougneres P (1997) Comparison of immunocytochemical and molecular features with the phenotype in a case of incomplete male pseudohermaphroditism associated with a mutation of the luteinizing hormone receptor. *J Clin Endocrinol Metab* 82:2159–2165
- Mitamura T (1992) Chinese eunuchs. The structure of intimate politics. Tuttle Company, Rutland, Tokyo
- Montag M, van der Ven K, Ved S, Schmutzler A, Prietl G, Krebs D, Peschka B, Schwanitz G, Albers P, Haidl G, van der Ven H (1997) Success of intracytoplasmic sperm injection in couples with male and/or female chromosome aberrations. *Hum Reprod* 12:2635–2640
- Mordel N, Mor-Yosef S, Margalioth EJ et al (1990) Spermatic vein ligation as treatment for male infertility. *J Reprod Med* 35:123–127
- Nagao RR, Plymate SR, Berger RE, Perin EB, Paulsen CA (1986) Comparison of gonadal function between fertile and infertile men with varicoceles. *Fertil Steril* 46:930–933
- Narita O, Manba S, Nakanishi T, Ishizuka N (1975) Pregnancy and childbirth in a true hermaphrodite. *Obst Gynecol* 45:593–595
- Neugebauer DCh, Neuwinger J, Jockenhövel F, Nieschlag E (1990) 9+0 axoneme in spermatozoa and some nasal cilia of a patient with totally immotile spermatozoa associated with thickened sheath and short midpiece. *Hum Reprod* 5:981–986
- Niedzielski J, Paduch D, Raczynski P (1997) Assessment of adolescent varicocele. *Pediatr Surg Int* 12:410–413
- van Niekerk WA (1974) True hermaphroditism. Clinical, morphological and cytogenetic aspects. Harper and Row, New York
- Nielsen J, Pelsen B, Sornensen K (1988) Follow-up of 30 Klinefelter males treated with testosterone. *Clin Genet* 33:262–269
- Nieschlag E (1992) Testosteron, Anabolika und aggressives Verhalten bei Männern. *Dt Arztebl* 89:2967–2972
- Nieschlag E, Behre HM, Schlingheider A, Nashan D, Pohl J, Fishedick AR (1993a) Surgical ligation vs. angiographic embolization of the vena spermatica: a prospective randomized study for the treatment of varicocele-related infertility. *Andrologia* 25:233–237
- Nieschlag E, Nieschlag S, Behre HM (1993b) Lifespan and testosterone. *Nature* 366:215
- Nieschlag E, Hertle L, Fishedick A, Abshagen K, Behre HM (1998) Update on treatment of varicocele: counselling as effective as occlusion of the vena spermatica. *Hum Reprod* 13:2147–2150
- Nieschlag E, Simoni M, Gromoll J, Weinbauer GF (1999) Role of FSH in the regulation of spermatogenesis: clinical aspects. *Clin Endocrinol* 51:139–146
- Nieschlag E, Kremer, Nieschlag S (2003) Androgens shorten the longevity of women: sopranos last longer. *Exp Clin Endocrinol Diabetes* 111:230–231
- Nilsson S, Edvinsson A, Nilsson B (1979) Improvement of semen and pregnancy rate after ligation and division of the internal spermatic vein: fact or fiction? *Brit J Urol* 51:591
- Nöske H-D, Weidner W (1999) Varicocele – a historical perspective. *World J Urol* 17:151–157
- Noordam MJ, Repping S (2006) The human Y chromosome: a masculine chromosome. *Curr Opin Genet Dev* 16:225–232
- Okada H, Goda K, Yamamoto Y, Sofikitis N, Miyagawa I, Mio Y, Koshida M, Horie S (2005) Age as a limiting factor for successful sperm retrieval in patients with nonmosaic Klinefelter's syndrome. *Fertil Steril* 84:1662–1664
- Oner AY, Sahin C, Pöcan S, Kizilkaya E (2005) Poyorchidism: sonographic and magnetic resonance image findings. *Acta Radiol* 46:769–771
- Ortkemper H (1993) Engel wider Willen: Die Welt der Kastraten. Henschel, Berlin
- O'Sullivan DC, Biyani CS, Heal MR (1995) Polyorchidism: causation and management. *Postgrad Med J* 71:317–318
- Parma P, Radi O, Vidal V, Chaboissier MC, Dellambra E, Valentini S, Guerra L, Schedl A, Camerino G (2006) R-spondin1 is essential in sex determination, skin differentiation and malignency. *Nat Genet* 38:1304–1309
- Pasqualotto FF, Lucon AM, de Goés PM, Sobreiro BP, Hallak J, Pasqualotto EB, Arap S (2005) Semen profile, testicular volume, and hormonal levels in infertile patients with varicoceles compared with fertile men with and without varicoceles. *Fertil Steril* 83:74–77
- Peeraer K, Nijs M, Raick D, Ombelet W (2004) Pregnancy after ICSI with ejaculated immotile spermatozoa from a patient with immotile cilia syndrome: a case report and review of the literature. *Reprod Biomed Online* 9:659–663
- Petersen PM, Giwercman A, Skakkebaek NE, Rorth M (1998) Gonadal function in men with testicular cancer. *Semin Oncol* 25:224–233
- Petersen PM, Giwercman A, Hansen SW, Berthelsen JG, Daugaard G, Rørth M, Skakkebaek NE (1999) Impaired testicular function in patients with carcinoma-in-situ of the testis. *J Clin Oncol* 17:173–179
- Petersen PM, Skakkebaek NE, Vistisen K, Rørth M, Giwercman A (1999) Semen quality and reproductive hormones before orchietomy in men with testicular cancer. *J Clin Oncol* 17:941–947
- Pettersson A, Richiardi L, Nordenskjöld A, Kaijser M, Akre O (2007) Age at surgery for undescended testis and risk of testicular cancer. *N Engl J Med* 356:1835–1841
- Philibert P, Zenaty D, Lin L, Soskin S, Audran F, Léger J, Achermann JC, Sultan C (2007) Mutational analysis of steroidogenic factor 1 (NR5a1) in 24 boys with bilateral anorchia: a French collaborative study. *Hum Reprod* 22:3255–3261
- Pühse G., Secker A., Kemper S, Hertle L., Kliesch S. (2005) Predictability of androgen deficiency in testicular germ cell cancer patients by residual testicular volume. American Urological Association, 100th Annual Meeting, San Antonio, Texas, USA, May 22nd 2005. *J Urol* 173:119
- Pyörälä S, Huttunen N-P, Uhari M (1995) A review and meta-analysis of hormonal treatment of cryptorchidism. *J Clin Endocrinol Metab* 80:2795–2799

- Raman JD, Nobert CF, Goldstein M (2005) Increased incidence of testicular cancer in men presenting with infertility and abnormal semen analysis. *174:1819–1822*
- Ratcliffe S (1999) Long-term outcome in children of sex chromosome abnormalities. *Arch Dis Child 80:192–195*
- Ritzen M, Bergh A, Bjerknes R, Christiansen P, Cortes D, Haugen SE, Jörgensen N, Kollin C, Lindahl S, Läckgren G, Mai KM, Nordenskjöld A, Rajpert-De Meyts E, Söder O, Taskinen S, Thorsson A, Thorup J, Toppari J, Virtanen H (2007) Nordic consensus on treatment of undescended testes. *Acta Paediatrica 96:638–643*
- Rodriguez-Rigau L, Smith K, Steinberger E (1978) Relationship of varicocele to sperm output and fertility of male partners in infertile couples. *J Urol 120:691–694*
- Savage MO, Lowe DG (1990) Gonadal neoplasia and abnormal sexual differentiation. *Clin Endocrinol 32:519–533*
- Schiff JD, Palermo GD, Veeck LL, Goldstein M, Rosenwaks Z, Schlegel PN (2005) Success of testicular sperm injection and intracytoplasmic sperm injection in men with Klinefelter syndrome. *J Clin Endocrinol Metab 90:6263–6267*
- Schoeneich G, Brändle E (1994) Therapiealternativverhalten bei idiopathischer Varicocele testis. *Akt Urol 25:272–276*
- Schulze W, Thoms F, Knuth UA (1999) Testicular sperm extraction: comprehensive analysis with simultaneously performed histology in 1418 biopsies from 766 subfertile men. *Hum Reprod 14:82–96*
- Schuppe HC, Meinhardt A, Allam JP et al (2008) Chronic orchitis: a neglected cause of male infertility? *Andrologia 40:84–91*
- Selman H, De Santo M, Sterzik K, Cipollone G, Aragona C, El-Danasouri I (2006) Rescue of spermatogenesis arrest in azoospermic men after long-term gonadotropin treatment. *Fertil Steril 86:466–468*
- Sharland M, Burch M, McKenna WM, Paton MA (1992) A clinical study of Noonan syndrome. *Arch Dis Child 67:178–183*
- Sharland M, Morgan M, Smith G, Burch M, Paton MA (1993) Genetic counselling in Noonan syndrome. *Am J Med Genet 45:437–440*
- Sijstermans K, Hack WWM, Meijert RW, van der Voort-Doedens LM (2007) The frequency of undescended testis from birth to adulthood: a review. *Int J Androl 31:1–11*
- Simm PJ, Zacharin MR (2006) The psychosocial impact of Klinefelter syndrome – a 10 year review. *J Ped Endocrinol Metab 19:499–505*
- Simoni M, Gromoll J, Nieschlag E (1997) The follicle-stimulating hormone receptor: biochemistry, molecular biology, physiology, and pathophysiology. *Endocr Rev 18:739–773*
- Simoni M, Gromoll J, Hoppner W, Kamischke A, Krafft T, Stahle D, Nieschlag E (1999) Mutational analysis of the follicle-stimulating hormone (FSH) receptor in normal and infertile men: identification and characterization of two discrete FSH receptor isoforms. *J Clin Endocrinol Metab 84:751–755*
- Simoni M, Bakker E, Krausz C (2004) EAA/EMQN best practice guidelines for molecular diagnosis of Y-chromosomal microdeletions. State of the art 2004. *Int J Androl 27:240–249*
- Simoni M, Tüttelmann F, Gromoll J, Nieschlag E (2008) Clinical consequences of microdeletions of the Y chromosome: the extended Münster experience. *Reprod Biomed Online 16:289–303*
- Skakkebaek NE, Berthelsen JC, Giwercman A, Müller J (1987) Carcinoma-in-situ of the testis: possible origin from gonocytes and precursor of all types of germ cell tumours except spermatocytoma. *10:19–28*
- Slaney SF, Chalmers, IJ, Affaar NA, Chitty LS (1998) An autosomal or X linked mutation results in true hermaphrodites and 46,XX males in the same family. *J Med Genet 35:17–22*
- Stavrou SS, Zhu YS, Cai LQ, Katz MD, Herrera C, Defillo-Ricart M, Imperato-McGinley J (1998) A novel mutation of the human luteinizing hormone receptor in 46XY and 46XX sisters. *J Clin Endocrinol Metab 83:2091–2098*
- Storm van's Gravesande K, Omran H (2005) Primary ciliary dyskinesia: clinical presentation, diagnosis and genetics. *Ann Med 37:439–449*
- Swerdlow AJ, Higgins CD, Pike MC (1997) Risk of testicular cancer in cohort of boys with cryptorchidism. *BMJ 314:1507–1511*
- Swerdlow AJ, Higgins CD, Schoemaker MJ, Wright AF, Jacobs PA (2005a) Mortality in patients with Klinefelter syndrome in Britain: a cohort study. *J Clin Endocrinol Metab 90:6516–6522*
- Swerdlow AJ, Schoemaker MJ, Higgins CD, Wright AF, Jacobs PA (2005b) Cancer incidence and mortality in men with Klinefelter syndrome: a cohort study. *J Nat Cancer Inst 97:1204–1210*
- Tapanainen JS, Aittomaki K, Min J, Vaskivuo T, Huhtaniemi I (1997) Men homozygous for an inactivating mutation of the follicle-stimulating hormone (FSH) receptor gene present variable suppression of spermatogenesis and fertility. *Nat Genet 15:205–206*
- Taran I, Elder JS (2006) Results of orchiopexy for the undescended testis. *World J Urol 24:231–239*
- Templeton A, Cooke I, Shaugh O'Brien PM, eds (1998) Evidencebased fertility treatment. Royal College of Obstetricians and Gynecologists Press, London, p 399
- Terzoli G, Simoni G, Lalatta F, Colucci G, Lobbiani A (1992) Fertility in a 47,XXY patient: assessment of biological paternity by deoxyribonucleic acid fingerprinting. *Fertil Steril 58:821–825*
- Themmen APN, Huhtaniemi IT (2000) Mutations of gonadotropins and gonadotropin receptors. *Endocr Rev 21:551–583*
- Toledo SPA, Brunner HG, Kraaij, R, Post M, Dahia PLM, Hayashida CY, Kremer H, Themmen APN (1996) An inactivating mutation of the luteinizing hormone receptor causes amenorrhea in a 46,XX female. *J Clin Endocrinol Metab 81:3850–3854*
- Unal D, Yeni E, Verit A (2001) Clomiphene citrate versus varicocelectomy in treatment of subclinical varicocele: a prospective randomized study. *Int J Urol 8:227–230*
- Van Assche E, Bonduelle M, Tournaye H, Joris H, Verheyen G, Devroey P, van Steirteghem A, Liebaers I (1996) Cytogenetics of infertile men. *Hum Reprod 11 (Suppl 4):1–26*
- Vermeulen A, Vandeweghe M, Deslypere JP (1986) Prognosis of subfertility in men with corrected or uncorrected varicocele. *J Androl 7:147–155*
- Vinci G, Anjot MN, Trivin C, Lottmann H, Brauner R, McElreavey K (2004) An analysis of the genetic factors involved in testicular descent in a cohort of 14 male patients with anorchia. *J Clin Endocrinol Metab 89:6282–6285*
- Virtanen HE, Toppari J (2008) Epidemiology and pathogenesis of cryptorchidism. *Hum Reprod Update 14:49–58*

- Vogt PH, Edelmann A, Kirsch S, Henegariu O, Hirschmann P, Kiesewetter F, Kohn FM, Schill WB, Farah S, Ramos C, Hartmann M, Hartschuh W, Meschede D, Behre HM, Castel A, Nieschlag E, Weidner W, Grone HJ, Jung A, Engel W, Haidl G (1996) Human Y chromosome azoospermia factors (AZF) mapped to different subregions in Yq11. *Hum Mol Genet* 5:933–943
- Vogt PH (2005) AZF deletions and Y chromosomal haplogroups: history and update based on sequence. *Hum Reprod Update* 11:319–336
- Vorona E, Zitzmann M, Gromoll J, Schüring AN, Nieschlag E (2007) Clinical, endocrinological, and epigenetic features of the 46,XX male syndrome, compared with 47,XXY Klinefelter patients. *J Clin Endocrinol Metab* 92:3458–3465
- Wagenseil F (1933) Chinesische Eunuchen (Zugleich ein Beitrag zur Kenntnis der Kastrationsfolgen und der rassialen und körperbaulichen Bedeutung der anthropologischen Merkmale). *Ztschr Morphol Anthropol* 32:415–468
- Weil D, Wang I, Dietrich A, Poustka A, Weissenbach J, Petit C (1994) Highly homologous loci on the X and Y chromosomes are hotspots for ectopic recombinations leading to XX maleness. *Nat Genet* 7:414–419
- Weinbauer GF, Behr R, Bergmann M, Nieschlag E (1998) Testicular cAMP responsive element modulator (CREM) protein is expressed in round spermatids but is absent or reduced in men with round spermatid maturation arrest. *Mol Hum Reprod* 4:9–15
- Wikström AM, Raivio T, Hadziselimovic F, Wikström S, Tuuri T, Dunkel L (2004) *J Clin Endocrinol Metab* 89:2263–2270
- Wille R (1991) Kastration in Deutschland. *Dt Arztebl* 88:95–96
- Wilson JD, Roehrborn C (1999) Long-term consequences of castration in men: lessons from the Skoptzy and the eunuchs of the Chinese and Ottoman courts. *J Clin Endocrinol Metab* 84:4324–4331
- WHO Laboratory Manual for the Examination and Processing of Human Sperm, Geneva (in press)
- Wu SM, Hallermeier KM, Laue L, Brain C, Berry AC, Grant DB, Griffin JE, Wilson JD, Cutler Jr GB, Chan WY (1998) Inactivation of the luteinizing hormone/chorionic gonadotropin receptor by an insertional mutation in Leydig cell hypoplasia. *Mol Endocrinol* 12:1651–1660
- Yang Y, Ma MY, Xiao CY, Li L, Li SW, Zhang SZ (2007) Massive deletion in AZFb/b+c and azoospermia with Sertoli cell only and/or maturation arrest. *Int J Androl* 31:573–578
- Zini A, Boman J, Baazeem A, Jarvi K, Libman J (2007) Natural history of varicocele management in the era of intracytoplasmic sperm injection. *Fertil Steril* 90:2251–2256
- Zitzmann M, Deppenbusch M, Gromoll J, Nieschlag E (2004) X-chromosome inactivation patterns and androgen receptor functionality influence phenotype and social characteristics as well as pharmacogenetics of testosterone therapy in Klinefelter patients. *J Clin Endocrinol Metab* 89:6208–6217
- Zollner TM, Veraart JC, Wolter M, Hesse S, Villemur B, Wenke A, Werner RJ, Boehncke WH, Jost SS, Scharrer I, Kaufmann R (1997) Leg ulcers in Klinefelter's syndrome – further evidence for an involvement of plasminogen activator inhibitor-1. *Br J Dermatol* 136:341–344
- Zuccarello D, Ferlin A, Cazzadore C, Pepe A, Garolla A, Moretti A, Cordeschi G, Francavilla S, Foresta C (2008) Mutations in dynein genes in patients affected by isolated non-syndromic asthenozoospermia. *Hum Reprod* 23:1957–1962
- Zucchi A, Mearini L, Mearini E, Constantini E, Bini V, Porena M (2005) Treatment of varicocele: randomized prospective study on open surgery versus Tauber antegrade sclerotherapy. *J Androl* 26:328–332

Contents

14.1	Physiology of Aging	239
14.2	Theories of Aging	240
14.3	Sexuality in Senescence	240
14.4	General Endocrinological Changes in Advanced Age	241
14.5	Reproductive Functions of Older Men	242
14.5.1	Sex Hormones in Older Men	242
14.5.2	Testicular Morphology in Advanced Age	244
14.5.3	Semen Parameters in Older Men	244
14.5.4	Fertility of the Aging Male	246
14.5.5	Reproductive Risks Associated with Advanced Paternal Age	248
14.6	Late-Onset Hypogonadism	249
14.6.1	Definition	249
14.6.2	Mortality and Testosterone Deficiency	249
14.6.3	Symptoms of Late-Onset Hypogonadism (LOH)	250
14.6.4	Hormone Substitution in Advanced Age	253
14.7	Diseases of the Prostate in Older Men	256
14.7.1	Benign Prostate Hyperplasia (BPH)	256
14.7.2	Prostate Cancer	257
14.8	Outlook	257
References	258

14.1 Physiology of Aging

Increasing longevity in most western industrial nations and its social, medical and also economic consequences have become a growing matter of public concern. Thus during the last 100 years in Germany the mean life expectancy has nearly doubled (Fig. 14.1). This also worldwide development is largely due to improved hygiene, reduction of newborn mortality and more effective therapy and prevention of acute diseases in adult age. With larger numbers of people reaching advanced age, health problems as well as social and psychological problems of older men play an increasingly important role in clinical medicine and in research. Not only is life expectancy increasing, but altered individual life planning and effective methods of contraception will continue to delay the timepoint of starting a family until later in life, when in any event female fertility is distinctly reduced.

Specific diseases of age do not exist. However, the incidence of simultaneous occurrence of diseases increases in age. The increase of **multimorbidity** raises problems for the therapy of individual diseases. Due to a higher number of contraindications of surgical or pharmacological treatment strategies, therapeutic options often are reduced. To what extent normal processes of aging influence the beginning and course of diseases and, conversely, to what extent pathological changes accelerate the physiological aging process cannot be determined reliably.

Aging is a normal physiological process. During the process of aging, the human organism undergoes a series of morphological and functional modifications within all organs and tissues characterized by a general tendency towards reduced physiological efficiency and atrophy of various organs and systems.

C. Rolf (✉)
St. Josef Hospital, Wiener Str. 1, D-27568 Bremerhaven,
Germany
e-mail: clausrolf@web.de

Fig. 14.1 Average life expectancy at birth of men and women from 1876 to 2006 (Data derived from Statistisches Bundesamt 2008)

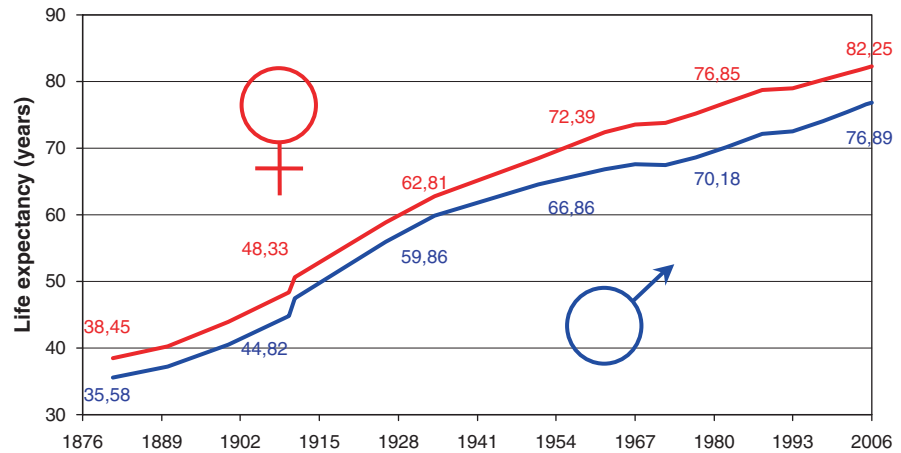

14.2 Theories of Aging

There are numerous, often incoherent theories of aging. It is estimated that about 30% of life expectancy is determined by genetics.

Whereas most theories of aging attempt to explain its cause, the **evolution theory** investigates the various concepts of evolutionary biology. Its main argument is the question of how to achieve the highest possible reproductive fitness under various environmental conditions, i.e., to have a high representation in the gene pool of the following generation (Kirkwood 2008). Age-determined changes of an individual are seen as significant for the survival of the species, as put forth in Darwin's evolutionary principles. Individual achievement of old age is per se not the goal of a species in terms of evolution biology.

In contrast to this theory, many others try to explain the causes of aging. These see achievement of a long life as the goal of every individual and explore biological causes for the various life expectancies.

According to the **program theory**, the process of aging is genetically fixed and death is a kind of pre-determined self-extinction.

At the end of each chromosome several thousand copies of a certain DNA sequence consisting of six base pairs are to be found, the so called **telomeres**. In the course of each cell division the chromosomes of somatic cells lose about 200 base pairs. According to the **telomere theory** the length of the telomere limits the lifespan of the somatic cells and thus of the entire human organism (Finkel 1998).

According to the **mutation theory** of aging, in senescence increased numbers of spontaneous mutations lead to functional and morphological changes which influence the entire organism. As an alternative to this theory age-dependent disturbances of the DNA repair mechanisms are postulated. Mitochondrial DNA is particularly susceptible to increased mutations in advancing age (Michikawa et al. 1999).

According to the theory of **accumulation of waste products**, accumulation of certain substances (i.e., lipofuscin) damages cells and tissues and causes the changes found in age. Moreover, free oxygen radicals, which occur physiologically in oxidative metabolism and result in the damage of macromolecules may be one reason for aging.

According to the **autoimmune theory** abnormal substances are produced in age. These are not recognized by the immunocompetent cells, especially by lymphocytes, plasma cells and mast cells, resulting in the formation of specific antibodies which produce irreversible cell damage.

Physiological changes of endocrine organs are also discussed as causing the process of aging.

14.3 Sexuality in Senescence

Generally, both women as well as men are able to maintain sexual feelings and enjoy an active sexual life in advanced age.

In the aging man, however, **changes in the sexual response cycle** can be observed. The **excitement phase**

is extended and achievement of **erection** delayed. The **plateau phase**, the time from erection to ejaculation, is often prolonged; often erections necessitate more prolonged, intense and direct stimulation. In general, although control of **ejaculation** in old men is clearly improved, the duration of the **orgasmic phase** is shorter. The intensity of semen propulsion decreases. After ejaculation the aging man experiences increasingly rapid dissipation of erection. The **refractory phase**, the period of time after orgasm in which further sexual stimulation will not produce subsequent orgasm, significantly increases for the aging man. The frequency and the duration of **nocturnal penile tumescence** in aging men is diminished, compared with that in younger men (Elliot 1990). Erectile dysfunction is increasingly present in aging men and erection problems are the most common sexual dysfunction of aging men. Diagnosis and therapy of **erectile dysfunction** are described in Chap. 16.

About 90% of men over 60 years report sexual activity; in a group of healthy men over 80 years 60% report having coition. The presence of a female partner plays a decisive role since married men are sexually more active than single men (Morley et al. 1990).

Several pathophysiological causes may be the reason for **reduced frequency of sexual intercourse** with age. The increasing incidence of multimorbidity in aging men, i.e., the high frequency of cardiovascular diseases, hypertonus, rheumatic diseases, renal diseases or diabetes mellitus, has unfavorable effects on sexuality. Also, many drugs such as antihypertensiva and psychopharmaka may have a negative influence on sexuality. A decrease of sexual activity is often caused by psychosocial reasons such as prolonged disease or death of the spouse. Another important reason for reduced sexual activity is the negative attitude of broad parts of society towards sexuality in age. Often elderly persons are not expected to have their own sexuality; living circumstances, particularly in many homes for senior citizens with strict rules, restrict any expression of intimacy, and prohibit sexual interaction (Elliot 1990). The film “Cloud 9” by Andreas Dresen (2008) reflects gradual changing of attitudes on the part of society towards sexuality among older people.

Inadequate or unsatisfactory sexual life may in turn also be responsible for psychosomatic diseases such as gastritis, colitis, obstipation or attacks of angina pectoris or dyspnoea in older men.

14.4 General Endocrinological Changes in Advanced Age

Impaired performance arising in advancing age is not necessarily caused by age as such and should not be dismissed as not requiring diagnosis and therapy. Within the diagnostic workup endocrine causes for impaired performance must also be taken into consideration. Because of multimorbidity in advanced age and often altered symptoms of hormone deficiency, endocrinologically determined reasons for impaired performance will often go unnoticed.

An age-dependent decrease of **growth hormone** production (hGH) is well known. Daily hGH secretion reaches its maximum at puberty and thereafter decreases continuously. hGH pulse frequency (especially during the night) and GHRH-induced hGH secretion also decrease with age. Consequently reduced hGH levels result in a decrease of general performance, reduced muscle strength and an increased tendency towards obesity (increased body mass index). Patients with manifest hGH deficiency are subject to a notably increased mortality rate caused by cardiovascular disease (Vance and Mauras 1999).

In prepubertal boys and in hypogonadal men, treatment with testosterone or hCG increases mean growth hormone levels, pulse amplitude, and **IGF-1** levels in serum. Low IGF-1 levels and changes in growth hormone levels may be related to reduced testosterone levels and relative hypogonadism. This possibility has not yet been adequately explored.

The **cortisol** concentration in serum remains constant in age. Also in chronically ill, alcoholic, or obese patients as well as in patients with hyperplasia of the prostate no significant changes in cortisol level are detectable (Gray et al. 1991). Older men, however, with relatively high cortisol levels are characterized by reduced bone density as well as an increased rate of fractures (Dennison et al. 1999; Greendale et al. 1999).

Dehydroepiandrosterone (DHEA) and **dehydroepiandrosterone sulphate (DHEAS)** are produced in the adrenal cortex as precursors of the testosterone synthesis with weak androgenic effects. Highest plasma concentrations are reached at the age of 20–25 years. Thereafter plasma levels decrease continuously,

so that by the age of 60 only a third or less of DHEA(S) can be detected (Herbert 1995).

In patients with a history of coronary heart disease significantly lower DHEAS plasma levels could be observed compared with an age-matched control group. Similarly correlations between reduced DHEA(S) levels and diabetes mellitus type II, rheumatoid arthritis, some carcinomas and body fat distribution were found. Whether DHEA(S) plasma level decreases reactively in cases of chronic disease or whether increased DHEA levels have a protective function is unknown. A meta-analysis by the Cochrane database showed that DHEA supplementation in older men provides no benefit to cognitive function or mood. It is, however, noted that final conclusions await more comprehensive studies with adequate numbers of cases (Grimey Evans et al. 2006).

Melatonin is secreted from the pineal gland and is responsible for day/night rhythmicity. In senescence melatonin concentration in serum decreases. Moreover, melatonin concentration in age is reduced in insomniac men compared to healthy men without insomnia (Garfinkel et al. 1995). To date any physiological relevance of melatonin substitution of aging men has not been demonstrated. Whether melatonin influences other endocrine functions and whether it has an inhibiting effect on aging by acting as a potential and efficient radical scavenger, as shown in vitro and in experimental animals, remains to be further elucidated (Garfinkel and Berner 1998).

The incidence of **thyroid diseases** increases with age. The typical symptoms often are no longer clearly recognizable and may lead to misdiagnosis or no diagnosis at all. Whether plasma levels of **TSH**, **T₃** and **T₄** show a general tendency to decrease in age or whether the changes are secondary and are caused by accompanying disease is discussed controversially (Mariotti 2002). Both hypo- as well as hyperthyroidism occur less often in men than in women of advanced age, but older men more often tend to develop thyroid cancer (Morganti et al. 2007).

Testosterone serum levels as well as **SHBG** levels (sex hormone-binding protein) are higher in patients with hyperthyroidism; the proportion of free bioactive testosterone remains unchanged. Both hyperthyroidism as well as hypothyroidism can result in reduced male fertility (Krassas and Perros 2003).

Non-insulin-dependent **diabetes mellitus type 2** is very often also a disease of advanced age. Usually hyperinsulinism is present, resulting in a reduction of insulin

receptors in the periphery. Erectile dysfunction and retrograde ejaculations resulting from diabetes mellitus occur frequently and often independently of the duration of the disease. These symptoms are caused by diabetogenic neuropathy as well as microangiopathy. Testosterone and SHBG serum levels in diabetics tend to be lower than those in healthy men of a similar age; the incidence of diabetes is slightly elevated in men with low testosterone (Kapoor et al. 2005). Comparing diabetic and age-matched, non-diabetic healthy men, increased sperm concentration, but reduced ejaculate volume and reduced motility were observed in the patient with diabetes (Ali et al. 1993). It is, however, unlikely that diabetes mellitus has a positive influence on spermatogenesis; more probably the reduced frequency of ejaculation, especially in patients with polyneuropathies, leads to an increase in sperm number accompanied by reduced motility.

14.5 Reproductive Functions of Older Men

14.5.1 Sex Hormones in Older Men

A “**male climacteric**” as an abrupt age-dependent change in testicular functions, comparable to the menopause, **does not exist**. A sudden loss of fertility does not occur. Aging men without accompanying diseases may have testosterone levels and testicular volumes comparable to those of younger men.

Whether a general decrease of **testosterone production** exists was discussed controversially in the past (Kaufman and Vermeulen 2005). The results from early epidemiological studies are contradictory owing to inconsistent selection of volunteers (reconvalescent old patients, patients from geriatric wards, men from a home for senior citizens, healthy volunteers). While decreased **testosterone serum levels** in older men were reported in the 1960s, in the 1970s it seemed that testosterone levels in healthy older men were not lower than in control groups of younger volunteers. In recent large scale epidemiological studies a general mean decline in serum levels of testosterone in older men was reported, but with considerable variance (Araujo et al. 2007; Wu et al. 2008).

Three different factors are responsible for changes in serum testosterone levels in older men.

On the testicular level the **reserve capacity of the Leydig cells is lowered** following stimulation. This reduction of reserve capacity of the Leydig cells is accompanied by a drop in the number of Leydig cells in advanced age (Neaves et al. 1985). In older men the increase of serum testosterone following hCG stimulation is lower. Similarly following stimulation by GnRH, LH shows a minor, but significant decrease in older men (Nieschlag et al. 1982).

Along with falling testicular testosterone production with age, there is a slight **rise in serum LH**. However, this increase is very small and older men with lower serum testosterone levels often show normal serum LH. Moreover, the slight LH increase can be explained by reduced plasma clearance, at least in part.

The main reason for these changes is increasing **incompetence of the hypothalamic-hypophyseal-gonadal feedback mechanism**, probably caused by the aging process. In the face of low testosterone concentrations, the reduced reactivity of the central pulse generators then results in inadequate, low-normal serum LH levels. This represents the pathophysiological concept of **late-onset hypogonadism** (Kaufmann and Vermeulen 2005).

The greater proportion of testosterone in serum is bound to proteins. Only the free, unbound testosterone is biologically active. With age the amount of sex hormone binding globulin (SHBG) increases in serum, so that the proportion of bioactive free testosterone decreases (Fig. 14.2). Whereas in healthy young men an increase in SHBG leads to an increase of total testosterone, in older men this rise does not take place because of increasing testicular and hypophyseal-hypothalamic insufficiency (Kaufmann and Vermeulen 2005).

The circadian rhythm of serum testosterone concentration with highest values in the early morning is also maintained in older men, albeit at a lower level and with lower amplitude (Diver et al. 2003). The number of men with serum testosterone concentrations in the hypogonadal range (i.e., <12 nmol/l) increases with age and accounts for 20% among 60–80-year-olds and 33% among men over 80 (Araujo et al. 2007) (Fig. 14.3). For patients other values prevail: in a large study on

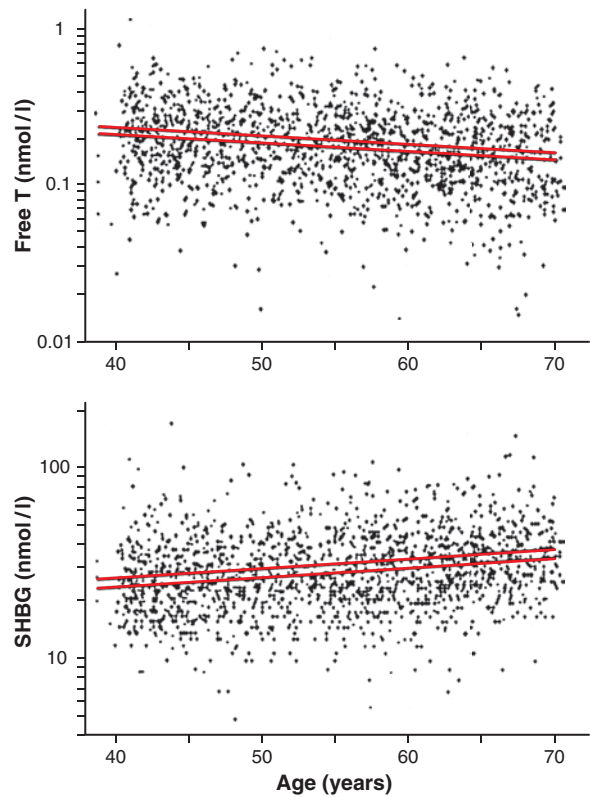

Fig. 14.2 Age-dependent changes of free testosterone and SHBG levels. Results of the Massachusetts Male Aging Study (Gray et al. 1991)

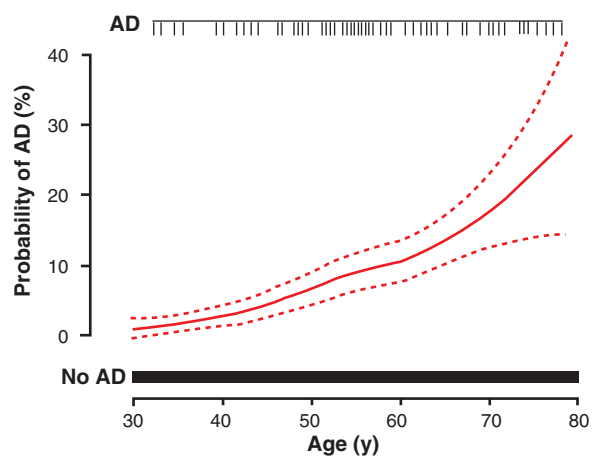

Fig. 14.3 Probability of androgen deficiency (AD) and late-onset hypogonadism (LOH) ($T < 10.4$ nmol/l) based on 1,475 men from the Boston Area Community Health (BACH) survey (Araujo et al. 2007)

men (aged >45) who attended a so-called “primary care center” in the USA, the percentage of hypogonadal men was 40% (Mulligan et al. 2006).

The basal concentrations of LH (luteotropin) and FSH (follicle-stimulating hormone) in serum increase slightly between the ages of 40 and 70 and clearly thereafter.

LH is secreted in a pulsatile fashion, the amplitude of the hypophyseal LH-pulse is reduced with advancing age, but the frequency and length of pulsatile secretion increases with higher basal secretion (Liu et al. 2005).

A mild decrease of **prolactin** levels is observed in aging men. The serum level of **estradiol** (E2) and **estrone** (E1) as well as of estrone sulphate remain constant in age. Lower testosterone levels and higher SHBG levels can intensify the influence of estrogens on the organism, which may explain the increased incidence of gynecomastia in senescent men (Morley et al. 1990). Elevated estradiol levels relative to testosterone levels can also be found in men with benign prostate hypertrophy (Gann et al. 1995; Suzuki et al. 1995). The serum levels of the testosterone metabolite 5α – dihydrotestosterone (DHT) do not decrease with age; however, in chronically ill patients lower levels are described (see Chap. 18).

14.5.2 Testicular Morphology in Advanced Age

The interpretation of histological findings of testes from older men is hampered by the fact that examining testes or samples of testicular biopsies of healthy volunteers is not justifiable. Knowledge about the morphology of testes is therefore based on autopsy material or on testes removed in the course of treatment of prostatic carcinoma.

In many cases these testes of old men show no differences to those of younger men. A general decrease in **testicular volume** cannot be observed (Handelsman and Staraj 1985). In 27 of 102 testes examined from men over 90 years **testis morphology** was perfectly normal (Schlüter 1978). However, in testes of some older men alterations exist ranging from isolated anomalies to full testicular atrophy. On occasion, both normal and atrophic seminiferous tubules are seen side by side in the same testis. When signs of atrophy and

hyalinization are present, in most cases **arteriosclerotic alterations** of the blood vessels can also be observed. The dimension of degenerative changes of the testes correlates with the extent of general arteriosclerosis. In some cases abnormal variants of type A pale spermatogonia and an unusual multilayered arrangement of spermatogonia were observed, a phenomenon rarely seen in younger men. Several results demonstrate that the **spermatogenetic efficiency**, i.e., the number of spermatozoa from one cell division of a single spermatogonia is reduced (lower in men anyway than in most animal species) with increasing age (Johnson et al. 1990). In the testes of aging patients with prostate cancer regressive changes of the germ cells were observed, with new degenerative forms of spermatogonia, spermatocytes and spermatids not appearing in younger men (Holstein 1989). Similarly the number of spermatogonia, spermatocytes and Sertoli cells in the testes decreases with age (Dakouane et al. 2005).

Histomorphometric investigations of testes from accident victims showed that the volume of individual Leydig cells does not change. However, a **decrease in total Leydig cell number** occurs as a function of age.

14.5.3 Semen Parameters in Older Men

Representative data from longitudinal studies on semen parameters of aging men are not available. The sexuality of aging men in general is still a taboo, shared both by society in general as well as by the medical profession. This may also explain why little is known about semen parameters in older men.

When investigating the semen parameters of healthy grandfathers, i.e., of men over 60 years, who had proven their fertility earlier in life, and of men over 50 years old visiting our clinic for couple infertility the seminal parameters were in good agreement with those of the control group of younger fathers or younger infertile men respectively (Figs. 14.4 and 14.5) (Nieschlag et al. 1982; Rolf et al. 1996). **Progressive sperm motility** was significantly lower in the older men, whereas the group of grandfathers showed higher **sperm concentrations**. These changes can be explained as a result of the lowered **ejaculatory frequency** in the older men. In **sperm function tests** (hamster-ovum-penetration test) no differences could be observed between the different age groups (Nieschlag et al. 1982).

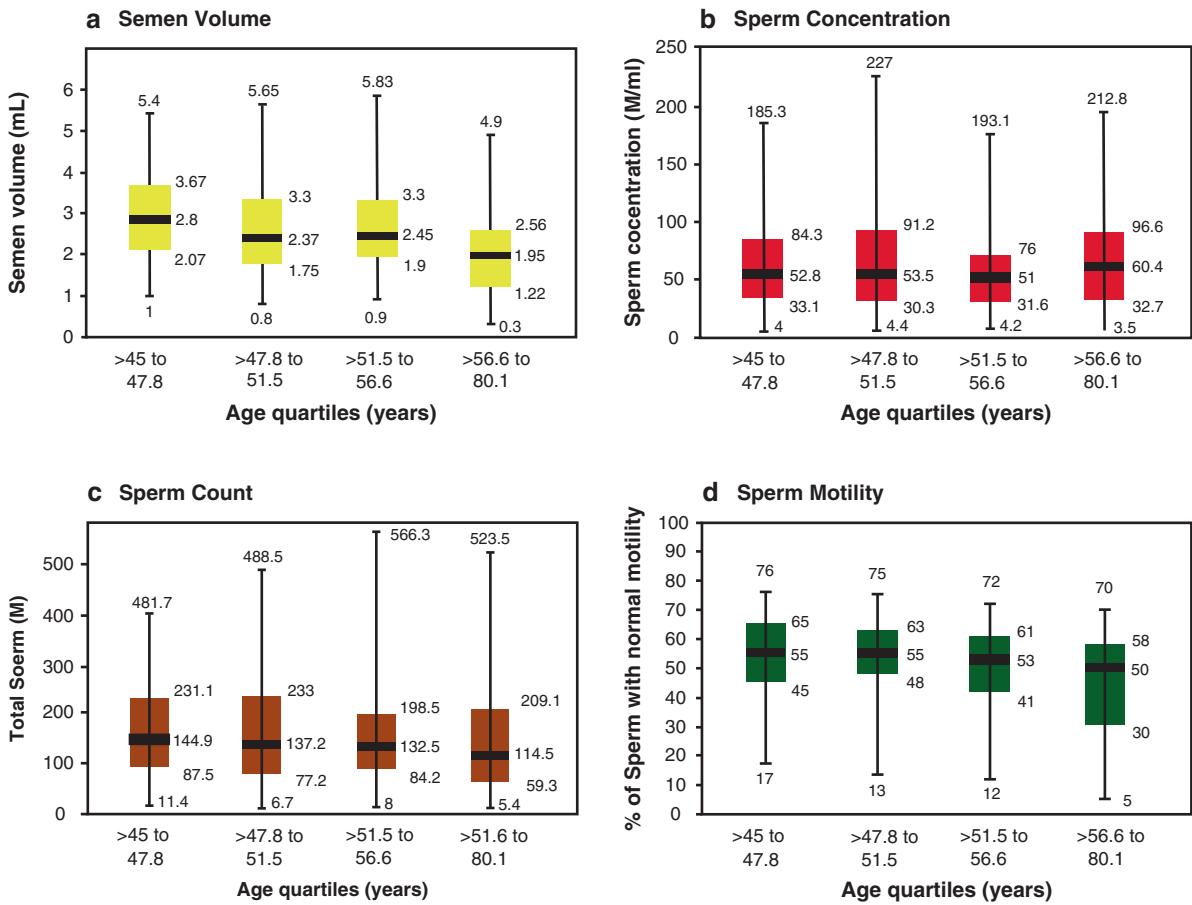

Fig. 14.4 Influence of age on semen parameters of 1,177 men aged 45–80 years (average 52.9) (Hellstrom et al. 2006)

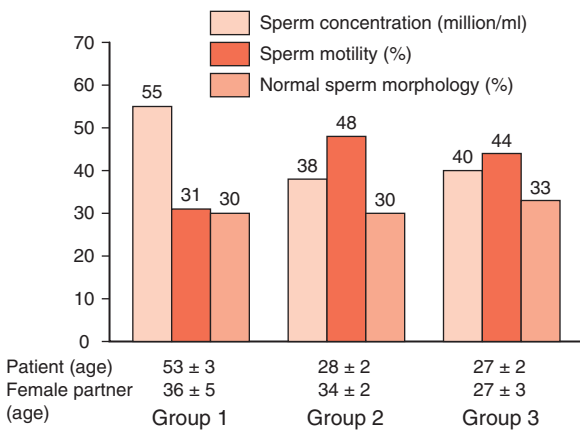

Fig. 14.5 Comparison of semen parameters between older and younger men of infertile couples (Rolf et al. 1996)

In the group of older infertile men the **ejaculate volume** was significantly lower compared to the control groups. **Fructose concentration**, as a marker for seminal vesicle function, was lower; the others markers of accessory gland function showed no changes. Sperm production and ejaculate parameters decrease with **reduced general health** and the ability to produce an ejaculate may disappear in cases of serious diseases (Nieschlag and Michel 1986).

With advancing age the number of morphologically normal sperm declines continuously; a decline of 0.2–0.9% per year was reported (Kidd et al. 2001; Kühnert and Nieschlag 2004). The portion of sperm with progressive motility in men with normozoospermia declines with age (Levitas et al. 2007). Less than half of all volunteers over 45 taking part in a study on medical treatment of erectile dysfunction showed normal ejaculate

parameters according to WHO criteria; in the age group of 45–80-year-olds a significant reduction of normally formed and progressively motile sperm, sperm numbers and ejaculate volume but unchanged sperm concentration were noted (Fig. 14.5) (Hellstrom et al. 2006).

It is unknown whether a relationship between decreased testosterone production and reduced spermatogenesis exists. In patients of our clinic presenting with couple infertility in whom manifest hypogonadism was excluded, no correlation between testosterone serum levels and ejaculate parameters could be observed. This may indicate a testosterone-independent reduced productivity of testes and accessory glands in older men. The age-dependent changes in ejaculate parameters are associated with a significant rise in serum FSH levels and a moderate but significant decline of inhibin B serum levels (Mahmoud et al. 2003).

The incidence of varicocele remains constant in patients with advanced age visiting the infertility clinic (Rolf et al. 1996). Andrological diseases acquired in adulthood such as infections of the efferent ducts as well as sperm antibodies, however, are diagnosed more frequently in older patients (Rolf et al. 2002a).

Even if sperm numbers do not decrease with age, acquired infections of the efferent ducts may cause a partial or even complete obstruction so that a

progreident reduction of seminal parameters cannot be excluded if adequate antibiotic therapy is not initiated. This would mean that not age per se but longer exposure to infection may be responsible for deteriorating ejaculate parameters.

14.5.4 Fertility of the Aging Male

Pablo Picasso, Charley Chaplin, Anthony Quinn, Julio Iglesias and Marlon Brando are prominent examples of men who fathered children at a relatively advanced age. All these men had considerably younger female partners. Sustained fertility, however, is not a privilege of VIPs; birth statistics show that a substantial number of fathers of neonates is over 50 years, but only very few mothers in this age group are recorded. Not only in Germany, but also in Japan, a country with a completely different sociocultural and ethnic background, relatively many older men father children (Fig. 14.6).

In several large-scale retrospective and prospective epidemiological population studies among highly varied population groups, however, a small yet significant negative correlation between advanced male age and the fertility of a couple could be demonstrated (Kühnert and Nieschlag 2004).

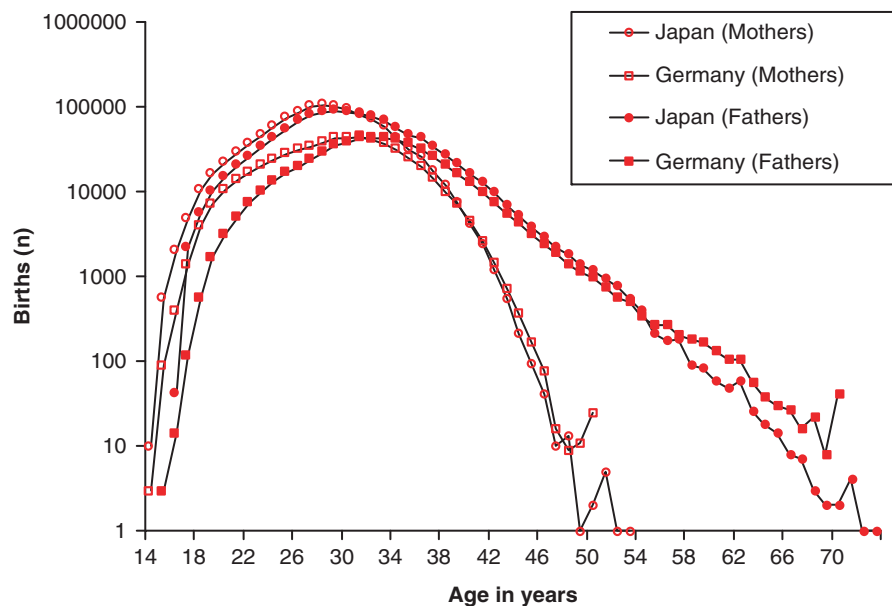
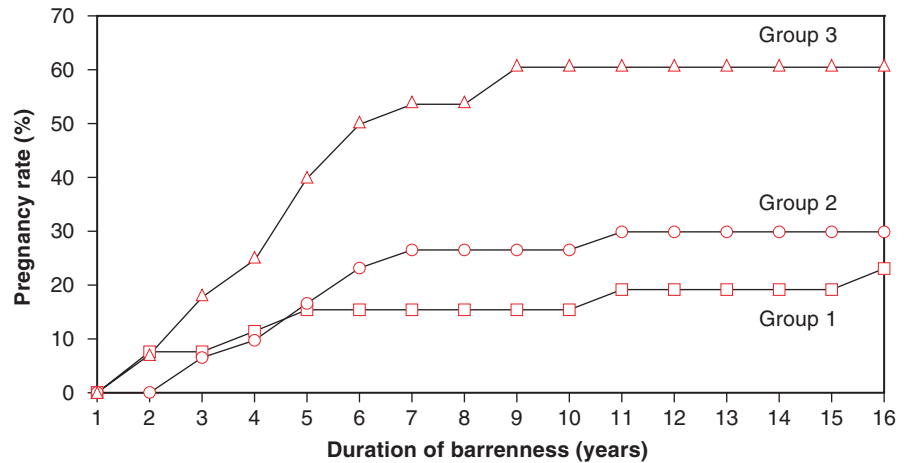

Fig. 14.6 Age distribution of fathers and mothers in Germany ($n = 550,659$) and in Japan ($n = 1,135,222$) (Kühnert and Nieschlag 2004)

Fig. 14.7 Cumulative pregnancy rates of couples visiting the Institute of Reproductive Medicine for infertility. Mean ages of patients with infertility in group 1, men: 53 years \pm 3; women: 36 \pm 5; group 2, men: 28 years \pm 2; women: 34 \pm 3; group 3, men: 27 \pm 2, women 27 \pm 3 (Rolf et al. 1996)



Age-dependent alterations of fertility in older men may have different causes. Aside from age per se, other factors such as reduced frequency of intercourse, increasing occurrence of urogenital infections, an increasing incidence of arterial circulatory disturbances or also an accumulation of toxic substances possibly damaging to spermatogenesis may be responsible for declining fertility.

Information on the fertility pattern of older men can also be obtained from the infertility clinic. Comparing the number of pregnancies of men over 50 years with men under 30 years, whose wives were at a comparable (advanced) age (37 \pm vs. 34 \pm years) at the time of conception, demonstrates that the pregnancy rates do not differ significantly. In comparison, men with younger female partners have a higher probability of fathering a child (Rolf et al. 1996) (Fig. 14.7).

Often older men seeking paternity have wives whose reproductive capacity is limited because of age. For this reason a study on “time-to-pregnancy” (TTP) carried out in 638 couples is of special interest; the women were all under 25 years of age. Up to the male age of 40, TTP was on average 7 months, over the age of 40 TTP increased threefold (Hassan and Kilick 2003) (Fig. 14.8). In countries where IVF treatment with heterologous oocytes is permitted, the fertilizing potential of the sperm of older men can be evaluated independent of oocyte quality. In the case of such heterologous IVF treatment, advanced age of the male causes no change in the fertilization rate or implantation rate (Gallardo et al. 1996). However, the rate of successfully completed pregnancies declines because of an increased rate of miscarriage when paternal age is over 50 (Gallardo et al. 1996; Frattarelli et al. 2008). So too within the framework of treatment with interuterine insemination, which requires higher sperm quality, success rates decline with paternal age over 50 (Kühnert and Nieschlag 2004).

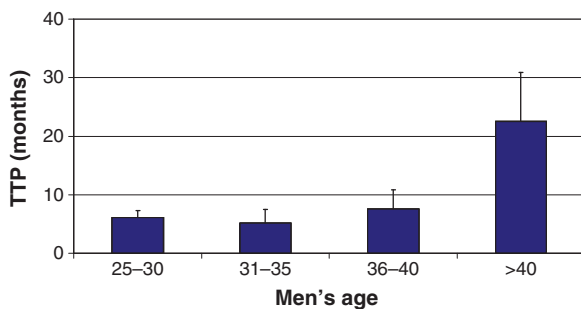

Fig. 14.8 Time-to-pregnancy (TTP) in women under 25 (n = 638) in relation to partner's age (Hassan and Kilick 2003)

The ability to initiate a pregnancy declines slightly with advanced paternal age. The fact of relatively rare fatherhood in men over 60 years can rather be mainly explained by reduced or extinct fertility of the female partners. Impaired fertility in aging men should be diagnosed and treated as younger patients. Age alone is no reason to eschew suitable contraception, if the female partner is of reproductive age and if there is no indication of impaired fertility.

14.5.5 Reproductive Risks Associated with Advanced Paternal Age

14.5.5.1 Miscarriage and Paternal Age

It is estimated that 30–70% of all pregnancies end in miscarriage, most of them going unnoticed. Well-known risk factors are advanced maternal age, previous miscarriage or abortion, excessive maternal alcohol consumption, maternal overweight or underweight. Pregnancies induced by fathers over the age of 50 bear an almost double risk of ending in miscarriage (Nybo Andersen et al. 2004). A further large-scale study showed that especially women over 30 are at risk if the father is older; the greatest risk is borne by couples in whom both partners are of advanced reproductive age (de la Rochebrochard and Thonneau 2002).

14.5.5.2 Chromosome Abnormalities and Advanced Paternal Age

An increased incidence of chromosome abnormalities in offspring from mothers of advanced age is proven (Nieschlag et al. 2000).

The main reason for **aneuploidy**, i.e., for **numerical chromosomal abnormality**, is a non-disjunction of homologous chromosomes during the meiotic division of the gametes. In men, meiotic divisions of the spermatocytes begin after puberty. Non-disjunctions during spermatogenesis are not rare. For example, in 4.7% of sperm of healthy men abnormal chromosome numbers were observed (Bordson and Leonardo 1991). Numeric chromosome abnormalities occur more frequently in infertile men with reduced sperm quality.

Although investigation of sperm revealed an age-dependent increase in the rate of anomalies of numeric sex chromosomes, there was no evidence for increased anomalies of numeric chromosomes of autosomes (Kühnert and Nieschlag 2004).

Trisomy 21 (Morbus Down) is one of the most frequent chromosome anomalies, for which advanced maternal age has been known as a risk factor; only 10% are transmitted by the father. More recent large-scale studies attribute a slightly elevated risk to advanced paternal age if maternal age is also advanced (Kühnert and Nieschlag 2004). In addition, no relationship could be found between the incidence of relatively

frequent (and hence clinically relevant) chromosome aneuploidies characterizing trisomy 13, trisomy 18, Turner syndrome (45, XO) and Klinefelter syndrome (47, XXY) and paternal age (Bordson and Leonardo 1991; Luetjens et al. 2002).

There are indications of increasing **structural chromosomal abnormalities** in the sperm of older men. However, in living neonates or fetuses subject to prenatal diagnosis no increase of new structural chromosomal abnormalities was found (Kühnert and Nieschlag 2004). Reciprocal translocations in children of older fathers are considered to occur at a higher frequency.

14.5.5.3 Genetic Disturbances and Advanced Paternal Age

Genetic mutations are the result of errors in DNA-replication. Up to the time of puberty approximately 30 cell divisions lead to a large pool of undifferentiated spermatogonia. These undergo 23 divisions per year, so that the number of divisions of a sperm in a 20-year old man is 200, 430 for a 30-year old and 770 divisions for a 45 year old man (Crow 1997). At each division *de novo* mutations can take place. Thus, it is obvious that in old men increased errors of DNA transcription may occur. Late spermatids, similar to spermatozoa, lack their own DNA repair system. The effectiveness of antioxidative protective mechanisms in seminal plasma and sperm declines with increasing age; thus sperm of old men are more vulnerable to mutagens than the sperm of younger man (Tarin et al. 1998).

It is now widely accepted that the incidence of autosomal dominant diseases, such as achondroplasia, polyposis coli, Marfan syndrome, Apert syndrome and basal cell naevi are associated with advanced paternal age. The incidence of other diseases such as neurofibromatosis, retinoblastoma or the Soto syndrome increase only minimally with increased paternal age (Crow 1997). About 5% of all cardiac defects in children whose fathers are older than 35 are said to be due to advanced paternal age; this indicates that some defects are caused by newly arising dominant mutations (Crow 1997).

Hence even if offspring of older men have a slightly increased incidence of certain genetic diseases, the individual risk of such a new disease must be considered as extremely small (for review see Sartorius and Nieschlag 2009).

While according to the guidelines of the German Medical Board on prenatal diagnosis and predisposition to diseases, advanced age of the pregnant woman is considered as a possible justification for specific intensive prenatal diagnosis, **advanced paternal age is no explicit indication for intensified prenatal diagnosis** (Bachmann et al. 2007).

14.6 Late-Onset Hypogonadism

14.6.1 Definition

Late-onset hypogonadism (LOH) is a clinically and biochemically defined disease of older men with serum testosterone levels below the reference parameters of younger healthy men and with symptoms of testosterone deficiency. Pronounced disturbances of the quality of life and harmful effects on multiple organ systems may ultimately result (Nieschlag et al. 2005; Wang et al. 2008).

In the aging male testosterone is not only responsible for secondary sex characteristics, libido and potency, but also influences mood and intellectual capacity, erythropoiesis, bone metabolism, protein anabolism and muscle mass, and fat distribution. In the aging

male testosterone is important for sexual life and vital functions. In clinical terms a decrease of serum testosterone may elicit a reduction of libido and potency as well as fatigue, diminution of muscle mass, osteoporosis and lowgrade anemia. As an isolated symptom, erectile dysfunction may be due less to testosterone deficiency than to an accompanying disease such as arteriosclerosis or diabetes mellitus. Especially neural and vascular organic alterations of the penis and pelvis are factors contributing to disturbed potency.

14.6.2 Mortality and Testosterone Deficiency

The mortality of patients with testosterone deficiency is significantly higher than that of patients with normal serum testosterone, even if mortality caused by the disease leading to current hospitalization is disregarded (Shores et al. 2006) (Fig. 14.9).

Recently published prospective studies showed that mortality of unselected older men with serum testosterone levels in the lowest quartile was significantly higher with respect to age, BMI, accompanying diseases, blood pressure or lipid parameters than in men with relatively high serum testosterone (Khaw et al. 2007; Laughlin et al. 2008). While the mortality of men with the low testosterone levels was increased by 30% or 40% in successive years, relatively high serum testosterone values were not associated with reduced mortality.

Fig. 14.9 Relationship between serum testosterone concentrations of 858 patients at admission to the Veterans Administration Hospital, Seattle (prostate and testicular cancer excluded) and mortality followed over the next 8 years. Normal testosterone levels at admission are associated with lower mortality (Shores et al. 2006)

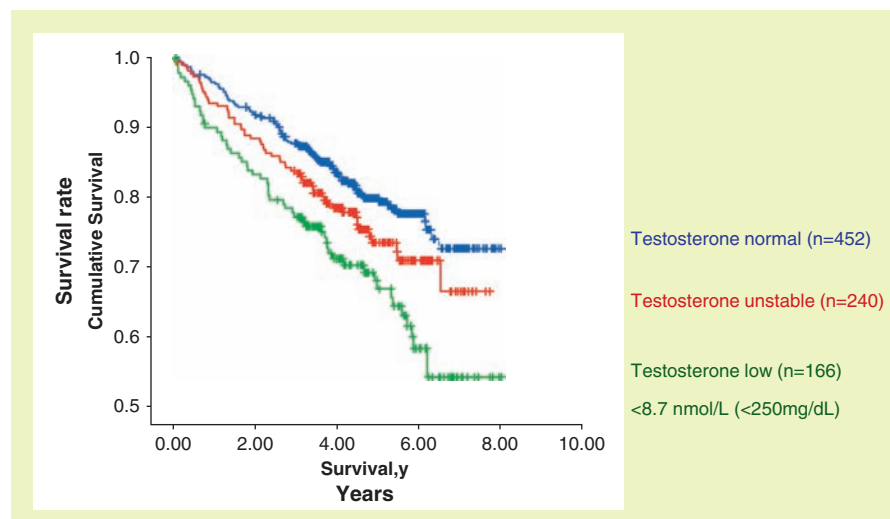

Low free serum testosterone as well as elevated free serum estradiol levels are independent risk parameters for peripheral arterial occlusion disease (Tivesten et al. 2007).

14.6.3 Symptoms of Late-Onset Hypogonadism (LOH)

14.6.3.1 General Symptoms

Along with lower serum testosterone levels, corresponding symptoms of androgen deficiency must be present for the diagnosis of late-onset hypogonadism (Nieschlag et al. 2005; Bhasin et al. 2006; Wang et al. 2008). The main symptom is **reduced libido**, however, **erectile dysfunction, reduced muscle mass and strength, increasing body fat, reduction of bone density and lessening of general performance and depressed mood** indicate androgen deficiency. At least one of these symptoms, along with low serum testosterone, is required for the diagnosis of LOH (Kelleher et al. 2004; Zitzmann et al. 2006).

It is evident that specific symptoms of LOH are associated with certain levels of testosterone concentrations. The complex of complaints tends to start with a loss of libido and energy; further declining testosterone levels are associated with an accumulation of visceral fat, depressions and hot flushes. Finally the picture of hypogonadism is completed by erectile dysfunction (Zitzmann et al. 2006) (see Chap. 21 and Fig. 21.1).

A **transitory androgen deficiency** caused by an intermittent acute disease must be excluded. **Chronic diseases** which may cause LOH are diabetes mellitus, COPD, chronic arthritis, renal disease and HIV with consecutive ancillary diseases.

14.6.3.2 Osteoporosis

Osteoporosis is understood as a systemic skeletal disease caused by reduced bone mass and deteriorated micro-architecture of bone tissue leading to increased frequency of fractures. **Primary osteoporosis** without a recognizable cause is distinguished from **secondary osteoporosis**, resulting from another

disease or therapy, although this distinction is often not evident.

Hypogonadism is a generally acknowledged risk factor for osteoporosis, as is testosterone substitution an accepted therapeutic measure for prevention of osteoporosis as well as for improving bone mass in patients with manifest hypogonadism. In women the frequency of osteoporosis increases after menopause and it is generally accepted that the climacteric alterations are its cause. On average comparable osteoporotic changes are observed in men approximately 10 years later than in women. The incidence of hip fractures increases significantly with lowered serum testosterone and estradiol levels (Amin et al. 2006; Meier et al. 2008) (Fig. 14.10). Considering the relatively high incidence of LOH and the close correlation between osteoporosis and sex hormone deficiency in men as well, it seems prudent to check for testosterone deficiency in every patient presenting with osteoporosis, and to initiate the usual basic measures for testosterone substitution.

14.6.3.3 Metabolic Syndrome

During the last century, living conditions in industrial nations changed considerably: the extent of physical activity has declined, while simultaneously an abundance of high-caloric food, rich in fats, has become available. This has resulted in increasing prevalence of obesity, particularly in the last 2 decades. The accumulation of visceral fat as a highly active endocrine organ represents a particular problem which manifests itself as a complex pathological entity with **increased blood pressure** as well as disturbed **fat metabolism** and **glucose tolerance** which is known as the **metabolic syndrome**. Visceral fat secretes inflammatory cytokines, pro-coagulative substances as well as substances which activate the angiotensin-aldosterone system. Thus persons with the metabolic syndrome have a threefold increased risk for clinically manifest cardiovascular events or stroke. The risk of developing type 2 diabetes mellitus is increased fivefold (Anderson et al. 2001; Eisenmann 2003; Cassells and Haffner 2006). The International Diabetes Federation has recently updated criteria for diagnosing the metabolic syndrome and identified abdominal girth, as the measure of visceral fat as a central factor. The borderline measure for European men is given as **94 cm for abdominal girth**.

Fig. 14.10 Percentage of 609 Australian men over 60 years with low-trauma fractures in relation to serum testosterone levels (Meier et al. 2008)

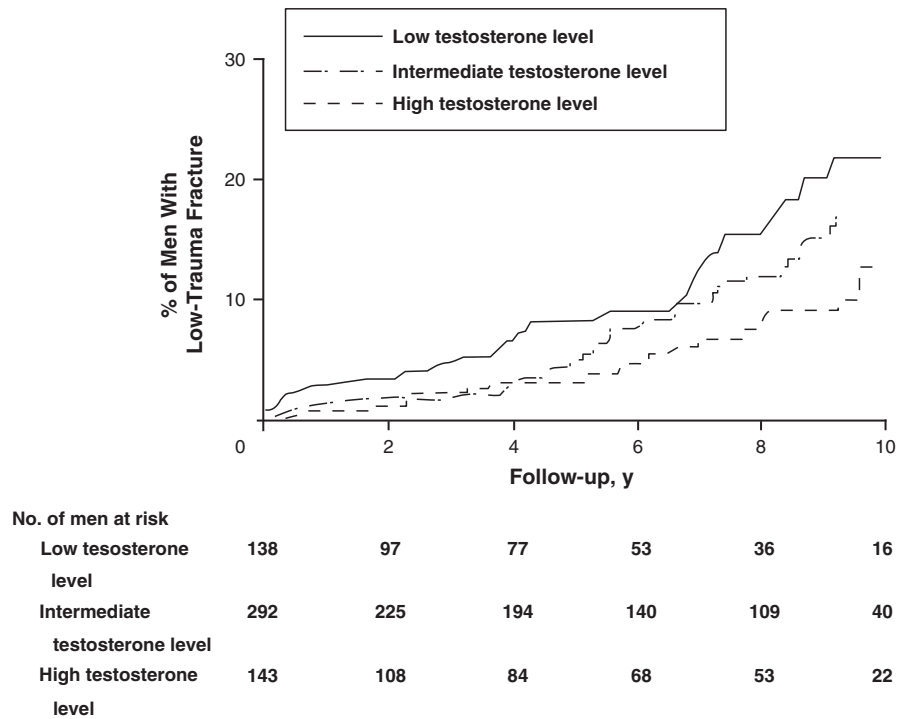

In men, as a key component of the metabolic syndrome, central obesity is often associated with testosterone deficiency (Fig. 14.11). Correspondingly longitudinal epidemiological studies show that a testosterone deficit represents an independent predictor for the development of a metabolic syndrome; conversely, a metabolic syndrome represents a risk for developing a testosterone deficit. This apparently affects not only men with an increased body mass index (BMI), but also persons with normal weight but increased abdominal girth (Muller et al. 2005; Laaksonen et al. 2004; Kupelian et al. 2006).

Pathophysiological correlates are seen *in vitro* when, under conditions of androgen deficiency, mesenchymal pluripotent stem cells with the possibility of further development into adipocytes or myocytes tend to prefer the adipogene lineage, whereas testosterone substitution furthers differentiation into muscle cells in a dose-dependent manner (Woodhouse et al. 2004). Similarly when hypogonadal men are given testosterone, visceral fat is reduced and muscle mass increases, as evidenced by computer spin tomographic studies in a placebo-controlled study (Allan et al. 2008).

Therefore it is not surprising that insulin sensitivity improves with testosterone application, for this is dependent upon mitochondrial function within the

muscle cell as well as on processes translated by the androgen receptor in fat cells. Thus men with type 2 diabetes mellitus displayed significantly improved insulin resistance and glycemic control when given testosterone *i.m.* in a placebo-controlled study, as well as reduced visceral fat and lessened dyslipidemia (Kapoor et al. 2006). This is supported by long-term observations of hypogonadal men who received testosterone undecanoate as a long-acting *i.m.* depot: fat metabolism and blood pressure profiles showed significant alterations toward normalization of metabolism (Zitzmann and Nieschlag 2007).

While these observations are promising, they continue to refer to sub-components of the metabolic syndrome in small cohorts. Longer-range multicenter studies on testosterone administration in hypogonadal men with endpoints such as changes in body composition, glucose metabolism and finally, mortality with reference to cardiovascular components, are necessary and are currently being carried out.

14.6.3.4 Psychosomatic Aspects

Although complaints associated with androgen deficiency are in part non-specific and could equally well

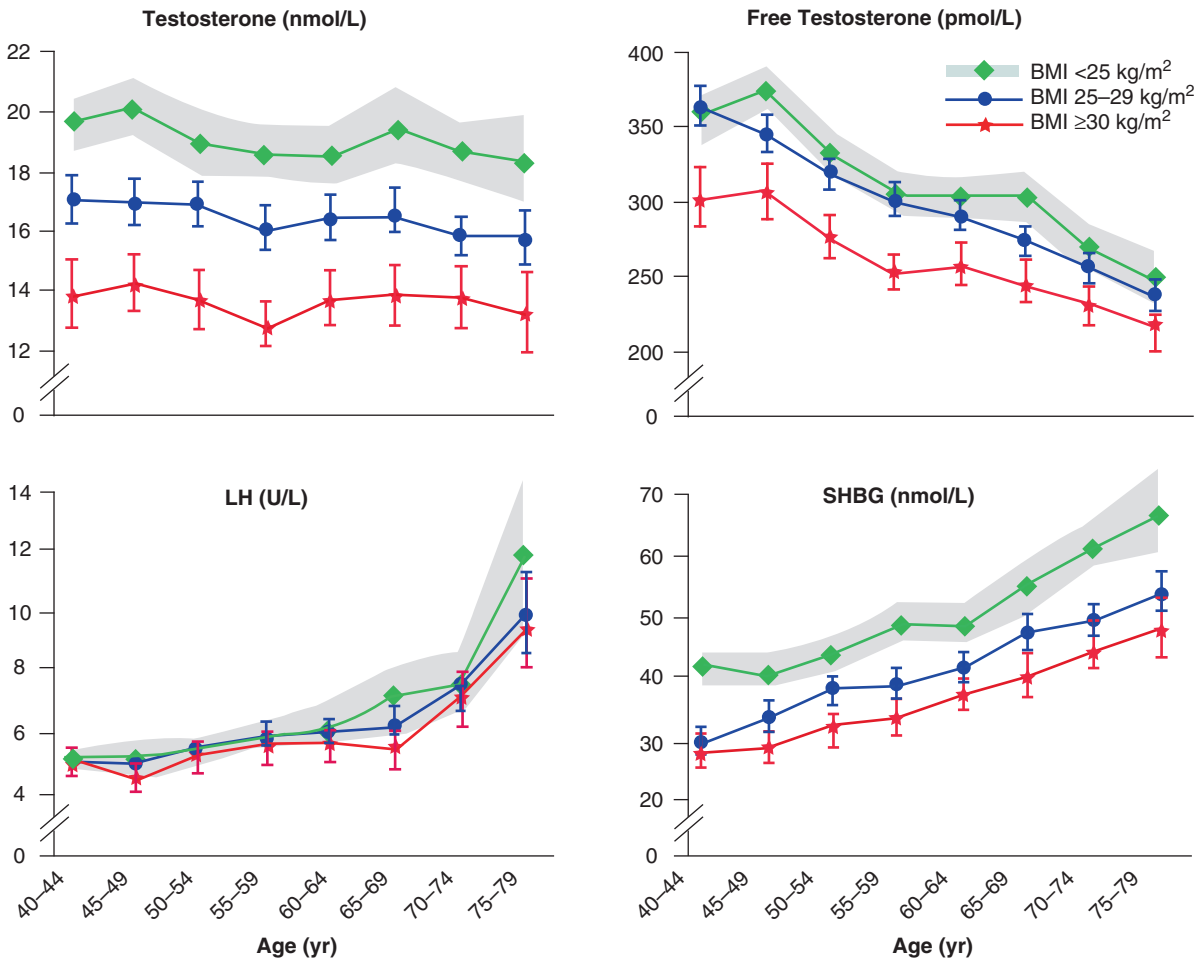

Fig. 14.11 Relationship between total and free (calculated) testosterone, LH and SHBG in 3,200 European men between 40 and 75 years of age (Wu et al. 2008)

apply to various psychosomatic syndromes, screening of androgen levels is not part of the standard diagnostic repertoire of psychosomatic medicine. Conversely male patients with non-specific physical complaints often seek clarification by an andrologist; about half of these patients suffer from androgen deficiency (Zitzmann 2006; Zitzmann et al. 2006). It is assumed that these clientele are in part identical; their subjective understanding of their complaints is manipulated by patients and referring physicians. This would mean that a certain percentage of patients presenting for psychosomatic therapy in whom a testosterone deficiency is co-morbid or responsible for their complaints, generally are not diagnosed and remain untreated. In analogy it can be assumed that a certain percentage of andrological patients suffer from psychic

disorders (depression, fearfulness, physical disorders) who similarly remain undiagnosed and untreated.

The following provides a summary of studies dealing with the connections between androgen deficiency and psychic symptoms. The results are not always consistent, as different samples in epidemiological cross-sections and also in intervention studies were examined. Most studies present a connection between androgens and depression. Generally a negative partial correlation between depression scores and testosterone levels is found. Hypogonadal men show significantly higher depression scores. While there are no significant differences for fearfulness, hypogonadal men have higher scores for “physical symptoms” than eugonadal men (Wang et al. 1996; Seidman et al. 2001).

An explanation why investigations of androgens in a normal population are sometimes inconsistent may be that the connection between low androgens and depressivity can only be determined in certain subgroups in which the CNS-testosterone interaction is modulated by further factors. One study which includes the CAG repeat polymorphism of the androgen receptor gene points in this direction: a Finnish group investigated the connection between CAG repeat length of the androgen receptor gene in a sample of 172 men aged 41–70 years. It found a positive correlation between CAG-repeat length and depression, i.e., decreased androgen effects were associated with the wish to be dead ($r = 0.45$), increased depressivity ($r = 0.23$), fearfulness ($r = 0.15$) and reduced general well-being (Haarkonen et al. 2003).

Those physical complaints mentioned in connection with androgen deficiency were: sleep disturbances, hot flushes, physical weakness, increased fatigue, reduced libido and subjective worsening of memory. These are unspecific physical complaints, which may be associated with a diagnosis of depression or dysthymia, but which may also appear independent of a marked impairment of mood along with other psychosomatic disorders, e.g., fearfulness, neurasthenia, posttraumatic stress and physical disturbances. Often connections between low testosterone levels and higher scores for fearfulness, depressivity and attention deficits are found (Zitzmann 2006).

Frequently bodily complaints represent a special aspect: they are characterized by disturbances that limit the patient's well-being but which are not explained or are not adequately explained by organic findings, although generally the patient is convinced of an organic cause and demands further physical tests, which may put pressure on the physician-patient relationship and tax the health care system considerably. Hypogonadal men have higher scores for "physical symptoms" on the GHQ scale than eugonadal men (Delhez et al. 2003).

A larger study with over 400 older men (aged over 50 years) attending an andrological clinic showed that psychosomatic complaints tend to be grouped in clusters showing an inverse relationship with testosterone levels. Especially lack of energy, loss of libido and depressive mood are found here simultaneously with hot flushes and general bodily weakness in late-onset hypogonadism (Zitzmann et al. 2006).

Studies on testosterone substitution and depressive mood confirm the epidemiological cross-sectional investigations: 22 hypogonadal depressive men were treated either with testosterone gel or placebo. Previous antidepressant treatment was maintained. Those men receiving testosterone had significantly higher improvement of depression symptoms on the Hamilton Depression Rating Scale than those receiving placebo (Pope et al. 2003). A large non-controlled trial with testosterone gel revealed definite improvement of mood in a large population of older hypogonadal men, as could be shown by various psychometric scales (Wang et al. 1996).

Altogether presently available data clearly indicate that testosterone supplementation can significantly improve psychosomatic parameters of hypogonadal men. Larger placebo-controlled studies are currently being carried out.

14.6.4 Hormone Substitution in Advanced Age

14.6.4.1 Testosterone Substitution

If clinical evidence for a latent or overt testosterone deficiency is present and serum testosterone levels in the morning are below the normal value for younger men of 12.0 nmol/l, testosterone substitution should be considered. Substitution should be performed according to international recommendations (Wang et al. 2008) and according to principles and dosage stated in Chap. 21.

In general, **muscle mass** decreases with age. In hypogonadal young patients usually muscularity is also reduced, which can be improved by testosterone substitution. In aging men testosterone substitution increased lean body mass at the expense of abdominal fat (improvement of lean body mass index) (Allan et al. 2008). With increasing age in healthy volunteers a gain in weight and percent of fat mass is measured correlating to the decline in testosterone. In contrast, in hypogonadal patients receiving adequate testosterone substitution no alteration in

body weight and proportion of fat is seen because no age-dependent decrease in testosterone is present (Rolf et al. 2002b).

As previously noted, men with type 2 diabetes mellitus treated with intramuscular injections of testosterone showed a **significant improvement of insulin resistance and glycemic control as well as a reduction of visceral fat and reduction of dislipidemia** (Kapor et al. 2006).

Preliminary results with testosterone substitution therapy in orthopedic patients with knee prostheses were promising. In some autoimmune diseases androgens may have a protective effect. The incidence of most autoimmune diseases is higher in aging men than in younger men. In women and in hypogonadal men the incidence is also higher than in healthy men, therefore several autoimmune diseases may be mitigated by testosterone substitution (Tenover 1994). Only in the last few years has it been recognized that **osteoporosis** poses a major health problem not only in postmenopausal women but also in aging men as well. In diagnosis and therapy of both senile as well as secondary osteoporosis in relation to other diseases changes of androgen levels must be taken into consideration. In patients with pathologic testosterone levels therapy with androgens should be considered (Francis 1999). Thus a clear improvement in bone mineral density resulted in osteoporotic patients with chronic obstructive lung diseases being treated with cortisone when they underwent additional testosterone therapy (Reid et al. 1996).

According to the results from short-term studies, testosterone treatment in patients with documented testosterone deficiency improved physical and psychic well-being in advanced age (Bagatell et al. 1994; Tenover 1994).

In a first large-scale placebo-controlled study extending over 36 months transdermal testosterone substitution of older man led to an increase in muscle mass as well as bone mineral density (Snyder et al. 1999a, b). The volunteers reported a subjective improvement of physical capacity. A clear increase of bone mineral density was especially noted in older man with reduced basal testosterone levels, while volunteers with normal levels prior to onset of therapy only showed a marginal increase in bone density.

In a small placebo-controlled study on patients with coronary heart disease testosterone therapy was able to reduce the frequency of angina pectoris attacks (von Eckardstein and Wu 2004). Furthermore, oral testos-

terone therapy improved perfusion of heart muscle areas not affected by arteriosclerosis, while the contractility of heart muscle which was supplied by coronary arteries affected by arteriosclerosis did not improve (Webb et al. 2008).

To date there are no data indicating that testosterone substitution induces **prostate cancer**. The molecular processes by which androgens influence prostate growth are not yet completely understood. Androgens are essential for normal prostate growth. In the absence of androgens the prostate maintains neither its function nor its size. Exogenous testosterone substitution in hypogonadal men causes the prostate to grow until the corresponding prostate size of age-dependent healthy volunteers is reached (Behre et al. 1994). Surprisingly, in a retrospective study older men receiving testosterone over several years developed BPH symptoms less frequently than the untreated men of a control group (Hajjar et al. 1997). As androgens are known to stimulate the growth of overt prostate cancer, prostate cancer is a contraindication for androgen substitution. Case reports of prostate cancer in older patients under testosterone substitution have been published (Rolf and Nieschlag 1998). However, the incidence of prostate carcinoma in a meta-analysis of 22 studies was not increased in the testosterone-treated subjects compared to the placebo groups (Calof et al. 2005).

The prostate should be monitored regularly by digital palpation and measurement of PSA (prostate-specific antigen) before and during substitution therapy. According to LOH recommendations (Wang et al. 2008) these investigations should be undertaken 3–6 months and 12 months after initiation of testosterone substitution as well as in yearly intervals thereafter. Supplementary transrectal sonography remains optional.

High doses of testosterone can lead to **polycythemia**. Elevated hematocrit values are found relatively often among older men substituted with testosterone (Hajjar et al. 1997; Sih et al. 1997; Calof et al. 2005); these values should be checked regularly during treatment. Special attention should be given to patients living at high altitudes. To avoid the complications of polycythemia the dose must be reduced, mode of application should be changed to transdermal testosterone or treatment should be stopped immediately.

Long-range multicenter studies on testosterone therapy for hypogonadal men with endpoints such as alteration of body composition, glucose metabolism and, finally, cardiovascular mortality are therefore necessary and are currently being carried out.

14.6.4.2 Other Hormone Substitution

As described above, a decrease of testosterone production is not the only endocrine change in senescence (Table 14.1). In recent years increased attention has been given to reduced secretion of **growth hormone** (GH) and **insulin-like growth-factor-1** (IGF-1). It is accepted that reduced growth hormone levels in aging man are responsible for changes in body composition. With recombinant growth hormone the possibility of substitution became available. An initial controlled study carried out in 1990 was able to show that administration of growth hormone to older men with growth hormone levels below normal for healthy young men was able to induce anabolic metabolism and reduction of fat mass in favor of protein (Rudmann et al. 1990). Further studies showed positive effects on body composition, but no improvement of muscle strength or maximum oxygen uptake under stress (Vance 2003). Simultaneously, however, reduced glucose tolerance and elevated blood pressure were observed (Rudmann et al. 1990). It is therefore possible that during extended substitution therapy hypertonus, diabetes mellitus or cardiomegaly may develop. Older controlled studies with in part relatively high growth hormone doses report that more than 10% of the patients complained about

peripheral edemas or arthralgia (Bryant et al. 2002). Since acromegalic patients show a markedly increased incidence of **colon polyps** and **carcinoma**, it cannot be excluded that growth hormone substitution therapy induces malignant growth. Similarly it was shown that the incidence of **prostate carcinoma** is elevated in men with high IGF-1 serum concentration.

Administration of human **pituitary growth hormone** to children and young adults may lead to an increased risk of carcinoma in adulthood (Swerdlow 2006). Children who were treated with recombinant growth hormone following malignant disease because of growth hormone deficiency showed a slightly elevated risk of a second neoplasia (Ergun-Longmire et al. 2006). However, no increased risk for carcinoma was found following growth hormone therapy for constitutional dwarfism. In view of the potential risks, at the present time growth hormone substitution in older men with physiological low growth hormone levels is not indicated (Ho 2007; Lombard et al. 2005). Results of controlled studies of substitution with synthetic growth hormone releasing hormone analogs (GHRH) or IGF-1 have not been published so far.

Substitution with **growth hormone**, GH releasing-hormone or IGF-1 must be considered as experimental and, on the basis of present knowledge, should be performed only in controlled studies.

Table 14.1 Endocrine changes with age (related to the means of large populations, which have wide variances)

Testosterone (total)	Decrease
Free testosterone	Decrease
LH	Increase
FSH	Increase
SHBG	Increase
Prolactin	Decrease
Estradiol (E2)	Constant
Estrone (E1)	Constant
Dihydrotestosterone (DHT)	Constant
Cortisol	Constant
Growth hormone (GH)	Decrease
Dehydroepiandrosterone (DHEA)	Decrease
Melatonin	Decrease

In a first clinically controlled study **DHEA substitution** induced an increase of IGF-1 levels. Seventy percent of the patients reported an improvement of general well-being. Further studies demonstrated an activation of the immune system with an increase of monocytes, activated T-lymphocytes and natural killer cells in older men as well as in postmenopausal women. A further large-scale placebo-controlled study, however, found no benefits of DHEA administration (Flynn et al. 1999). While a slight improvement in lumbar bone density was observed after oral DHEA substitution in healthy older women, no such improvement was seen in older men (von Mühlen et al. 2008). Further studies are needed to assess the effectiveness of DHEA therapy.

Melatonin substitution in the evening improves the sleep quality of older people (Garfinkel et al. 1995; Valtonen et al. 2005). Frequently discussed in the

media, melatonin substitution was reported to prevent tumors. No human studies exist to indicate any such effect (Garfinkel and Berner 1998).

Some gynecologists advocate **estrogen substitution** of older men (Umbreit 1993). Results from controlled studies continue to be long awaited. Physiologically convincing evidence for such substitution therapy is not known. In controlled clinical studies with high-dose estrogen preparations for the prevention of coronary heart diseases, as well as for treatment of prostate carcinoma, an increased incidence of thromboembolism as well as cardiovascular complications was noted. Moreover, estrogen serum levels favoured the development of BPH in men with relatively low testosterone levels (Gann et al. 1995; Suzuki et al. 1995). Therefore, according to the actual state of knowledge estrogen substitution in men cannot be justified.

14.7 Diseases of the Prostate in Older Men

14.7.1 Benign Prostate Hyperplasia (BPH)

In recent years the concept of **Lower Urinary Tract Symptoms (LUTS)** has become increasingly established in professional circles but also in the lay press. According to the definition of the International Continence Society, the LUTS symptom complex includes retention symptoms, voiding symptoms as well as symptoms following emptying of the bladder (Abrams et al. 2003). Its causes may be enlargement of the prostate, infection or tumor of the bladder or prostate and a stricture of the urethra with a normally sized prostate. Thus a symptom complex is subsumed under the concept of LUTS, while benign prostate hyperplasia is understood to mean hyperplasia of the periurethral inner zone of the prostate with consecutive urinary obstruction.

Benign prostatic hypertrophy (BPH) is a widespread disease in older men. Worldwide 15–22% of men between the ages of 50 and 59, 15–33% of men between the ages of 60 and 69 and 25% to over 40% of men between 70 and 79 show medium to severe symptoms of LUTS (Lepor 2004); in autopsy studies 50% of men aged between 51 and 60, 70% of men between 61 and 70 and 90% of men between 81 and 90 benign prostate hypertrophy (BPH) was evident histologically (McVary 2006). Its exact etiology is not clear. **Endocrine**

imbalance in senescence is considered a possible reason. In men castrated prior to puberty BPH is not seen. In the prostate testosterone is metabolized to **dihydrotestosterone (DHT)** irreversibly via 5α -reductase. In men with 5α -reductase deficiency the prostate remains rudimentary. Whether, however, increased DHT levels in the prostate are a reason for BPH or a consequence of the enlarged gland, is not fully settled (Lepor 2004). Statistically significant changes in testosterone levels in patients with BPH were not found. An increase of estrogen levels and decreased androgen efficiency are also discussed as a reason for BPH (Gann et al. 1995; Suzuki et al. 1995).

Possibly genetic differences in the androgen receptor also determine a disposition towards BPH. Men with a lower number of **CAG triplets on the androgen receptor** gene have a higher probability of developing BPH than those with more CAG triplets (Giovannucci et al. 1999). In hypogonadal patients receiving testosterone therapy prostate growth correlates inversely with the number of CAG triplets (Zitzmann et al. 2003).

The prostates of men with acromegaly are noticeably larger than those of healthy men of equal age, despite their secondary hypogonadism (Colao et al. 1998). Normalization of growth hormone levels leads to a reduction of prostate volume. Growth hormone stimulates hepatic IgF-1 synthesis. A higher quotient of IgF-1 and its binding protein IGFBP-3 represents a risk factor for developing BPH, especially in overweight men (Neuhouser et al. 2008). Thus growth hormone also has an influence on prostate growth.

The first **symptoms of BPH** often are pollakisuria, dysuria and nykturia. However, in the early stage a complete emptying of the bladder is still possible (Harzmann et al. 1998). In the retentive stage complete emptying of the bladder is no longer possible, due to the slackening of the bladder's muscular system. In the stage of bladder insufficiency the muscular system and innervation adapt to this condition. Due to obstruction in the ureter and kidneys, renal insufficiency is imminent. Furthermore it remains unclear whether BPH is a predisposing factor for prostate cancer.

The **diagnosis of BPH** is based on clinical history including medications, physical examination including rectal-digital palpitation, transrectal sonography, measurement of prostate-specific antigen (PSA) and serum creatinin, uroflowmetry and cystoscopy. The internationally accepted **International Prostate Symptom Score (IPSS)** allows patients to be categorized according to

symptoms. This score with a total of 35 possible points shall indicate therapy. In the diagnosis of BPH particularly prostatitis and prostate cancer must be excluded (Harzmann et al. 1998).

- Mild symptoms of BPH (**IPSS score 0–7**) require no therapy; patients should be checked regularly.
- Patients with moderate symptoms (**IPSS score 8–19**) should be treated with α -receptor blockers or 5 α -reductase blockers. Unlike α -receptor blockers the 5- α -reductase blocker Finasteride reduces prostate volume. Finasteride therapy is promising when the IPSS score is between 8 and 19 and the prostate volume exceeds 40 ml (Madersbacher et al. 2004). For widespread phytotherapy for treatment of BPH no effectiveness could be shown according to criteria of evidence-based medicine and it is not recommended (Madersbacher et al. 2008).
- Severe symptoms (**IPSS score 20–35**) and after unsuccessful conservative therapy require transurethral resection of the prostate. Next to transurethral incision, particularly indicated for small prostates, transurethral resection of the prostate is the therapy of choice. In cases of very large prostate volume transvesical prostate adenoma enucleation should be performed. Transurethral laser therapy is a relatively new minimally invasive alternative with promising results, especially for patients under oral anticoagulation or also for those wishing to maintain erectile capacity (Madersbacher et al. 2004).

14.7.2 Prostate Cancer

Similarly prostate cancer is almost exclusively a disease of advanced age. The incidence of prostate cancer in systematically performed autopsies is significantly higher than the incidence of clinically manifested cases. Within the recent past an increase in the frequency of prostate cancer was observed in many countries with aging populations, particularly in men below 60 years (Quinn and Babb 2002). In part this can be attributed to improved regular checkups, especially to awareness that PSA concentrations even below 4 μ g/L with suspicious digital findings should be followed by biopsy. Today 10–12 biopsies performed under ultrasound guidance are recommended.

The first **symptoms of prostate cancer** often resemble the symptoms of benign prostatic hyperplasia;

however, dysuria occurs more frequently and pollakiuria less often. Hematuria is also often present. Often the first symptoms are due to bone metastases with lumbar or pelvic pain. Digital rectal examination remains the most practicable method for early diagnosis. Further screening examinations are determination of PSA and transrectal ultrasonography with prostate biopsy. Since in many cases prostate cancer is not clinically overt, the optimal intensity of adequate screening is subject to controversial discussion (Heidenreich et al. 2008). However, it was shown that annual PSA determination beginning at age 50 clearly reduced the mortality rate (Labrie et al. 1999). A yearly urological checkup is recommended for men from the ages of 45–50 onwards (Heidenreich et al. 2008).

Due to the 5 α -reductase blocker finasteride the incidence of a newly diagnosed prostate cancer during a 7-year treatment duration could be reduced by almost 25%, but the frequency of undifferentiated aggressively growing tumors increased (Thompson et al. 2003). There is, however, increased evidence that highly malignant tumors could be diagnosed earlier through the reduction of prostate volume and the suppression of low malignant tumors in the finasteride treatment arm (Lucia et al. 2007).

The **treatment strategy of prostate cancer** depends on the stage of disease at diagnosis, on the age and the general well-being of the patient and on histological differentiation. In general radical prostatectomy, orchidectomy, radiation therapy, chemotherapy, hormonal treatment with antiandrogens, and today, preferably with GnRH-analogues are available modalities (Heidenreich et al. 2008).

For patients with preserved erectile function a “nerve sparing” surgical method should be considered in which the cavernosal nerves which run in immediate proximity to the prostate should be spared. The risk of postoperative erectile dysfunction can be strongly reduced; controlled comparative studies on long-term success are not available.

14.8 Outlook

Concerning reproductive as well as endocrine functions of older men, many questions are still open. Intensified investigation of the physiology of aging men is necessary. According to the actual state of

knowledge uncontrolled substitution with androgens or various other hormones can be considered as irresponsible. Further studies, especially prospective placebo-controlled long-term interdisciplinary studies investigating the possible beneficial and adverse consequences of androgen substitution are urgently required. Whether tissue-specific androgen receptor agonists (SARMS) currently in clinical trials will provide optimized specific androgen substitution remains to be seen.

References

- Abrams P, Cardozo L, Fall M, Griffiths D, Rosier P, Ulmsten U, Van Kerrebroeck P, Victor A, Wein A (2003) The standardisation of terminology in lower urinary tract function: report from the standardisation sub-committee of the International Continence Society. *Urology* 61:37–49
- Ali ST, Shaik RN, Siddiqi NA, Siddiqi PQ (1993) Semen analysis in insulin-dependent/non-insulin-dependent diabetic men with/without neuropathy. *Arch Androl* 30:47–54
- Allan CA, Strauss BJ, Burger HG, Forbes EA, McLachlan RI (2008) Testosterone therapy prevents gain in visceral adipose tissue and loss of skeletal muscle in nonobese aging men. *J Clin Endocrinol Metab* 93:139–146
- Amin S, Zhang Y, Felson DT, Sawin CT, Hannan MT, Wilson PW, Kiel DP (2006) Estradiol, testosterone, and the risk for hip fractures in elderly men from the Framingham Study. *Am J Med* 119:426–433
- Anderson PJ, Critchley JA, Chan JC, Cockram CS, Lee ZS, Thomas GN, Tomlinson B (2001) Factor analysis of the metabolic syndrome: obesity vs. insulin resistance as the central abnormality. *Int J Obesity* 25:1782–1788
- Araujo AB, Esche GR, Kupelian V, O'Donnell AB, Travison TG, Williams RE, Clark RV, McKinlay JB (2007) Prevalence of symptomatic androgen deficiency in men. *J Clin Endocrinol Metab* 92:4241–4247
- Bachmann R, Happle R, Held KR, Holzgreve W, Kunze J, Rauskolb R, Rehder H, Sewig K-Fr, Schmidtke J, Wolff G, Wollersheim U, Wissenschaftlicher Beirat der Bundesärztekammer (2007) Richtlinien zur pränatalen Diagnostik von Krankheiten und Krankheitsdispositionen (<http://www.bundesärztekammer.de>)
- Bagatell CJ, Heiman JR, Matsumoto AM, Rivier JE, Bremner WJ (1994) Metabolic and behavioral effects of high-dose, exogenous testosterone in healthy men. *J Clin Endocrinol Metab* 79:561–567
- Behre HM, Bohmeyer J, Nieschlag E (1994) Prostate volume in testosterone-treated and untreated hypogonadal men in comparison to age-matched normal controls. *Clin Endocrinol* 40:341–349
- Bhasin S, Cunningham GR, Hayes FJ, Matsumoto AM, Snyder PJ, Swerdloff RS, Montori VM (2006) Testosterone therapy in adult men with androgen deficiency syndromes: an endocrine society clinical practice guideline. *J Clin Endocrinol Metab* 91:1995–2010
- Bordson BL, Leonardo VS (1991) The appropriate upper age limit for semen donors: a review of the genetic effects of paternal age. *Fertil Steril* 56:397–401
- Bryant J, Loveman E, Cave C, Chase D, Milne R (2002) Endocrinology trial design: adverse event reporting in randomised controlled trials of recombinant human GH in GH-deficient adults. *J Endocrinol* 175:545–552
- Calof OM, Singh AB, Lee ML, Kenny AM, Urban RJ, Tenover JL, Bhasin S (2005) Adverse events associated with testosterone replacement in middle-aged and older men: a meta-analysis of randomized, placebo-controlled trials. *J Gerontol A Biol Sci Med Sci* 60:1451–1357
- Cassells HB, Haffner SM (2006) The metabolic syndrome: risk factors and management. *J Cardiovasc Nurs* 21:306–313
- Colao A, Marzullo P, Ferone D, Spiezia S, Cerbone G, Marino V, Di Sarno A, Merola B, Lombardi G (1998) Prostatic hyperplasia: an unknown feature of acromegaly. *J Clin Endocrinol Metab* 83:775–779
- Crow JF (1997) The high spontaneous mutation rate: is it a health risk? *Proc Natl Acad Sci USA* 94:8380–8386
- Dakouane M, Bicchieray L, Bergere M, Albert M, Vialard F, Selva J (2005) A histomorphometric and cytogenetic study of testis from men 29–102 years old. *Fertil Steril* 83:923–928
- de la Rochebrochard E, Thonneau P (2002) Paternal age and maternal age are risk factors for miscarriage; results of a multicentre European study. *Hum Reprod* 17:1649–1656
- Delhez M, Hansenne M, Legros JJ (2003) Andropause and psychopathology: minor symptoms rather than pathological ones. *Psychoneuroendocrinology* 28:863–874
- Dennison E, Hindmarsh P, Fall C, Kellingray S, Barker D, Phillips D, Cooper C (1999) Profiles of endogenous circulating cortisol and bone mineral density in healthy elderly men. *J Clin Endocrinol Metab* 84:3058–3063
- Diver MJ, Imtiaz KE, Ahmad AM, Vora JP, Fraser WD (2003) Diurnal rhythms of serum total, free and bioavailable testosterone and of SHBG in middle-aged men compared with those in young men. *Clin Endocrinol* 58:710–717
- Eisenmann JC (2003) Secular trends in variables associated with the metabolic syndrome of North American children and adolescents: a review and synthesis. *Am J Hum Biol* 15:786–794
- Elliot ML (1990) Psychological aspects of sexual dysfunction in the elderly. In: *Armbrecht HJ, Coe RM, Wongsurawat N (eds) Endocrine function and age*. Springer, Heidelberg, pp 136–146
- Ergun-Longmire B, Mertens AC, Mitby P, Qin J, Heller G, Shi W, Yasui Y, Robison LL, Sklar CA (2006) Growth hormone treatment and risk of second neoplasms in the childhood cancer survivor. *J Clin Endocrinol Metab* 91:3494–3498
- Finkel E (1998) Telomeres: keys to senescence and cancer. *Lancet* 351:1186
- Flynn MA, Weaver-Osterholtz D, Sharpe-Timms KL, Allen S, Krause G (1999) Dehydroepiandrosterone replacement in aging humans. *J Clin Endocrinol Metab* 84:1527–1533
- Francis RM (1999) The effects of testosterone on osteoporosis in men. *Clin Endocrinol* 50:411–414
- Frattarelli JL, Miller KA, Miller BT, Elkind-Hirsch K, Scott RT Jr (2008) Male age negatively impacts embryo development and reproductive outcome in donor oocyte assisted reproductive technology cycles. *Fertil Steril* 90:97–103

- Gallardo E, Simon C, Levy M, Guanes PP, Remohi J, Pellicer A (1996) Effect of age on sperm fertility potential: oocyte donation as a model. *Fertil Steril* 66:260–264
- Gann PH, Hennekens CH, Longcope C, Verhoek-Oftedahl W, Grodstein F, Stampfer MJ (1995) A prospective study of plasma hormone levels, nonhormonal factors, and development of benign prostatic hyperplasia. *Prostate* 26:40–49
- Garfinkel D, Berner YN (1998) Antioxidants and aging: is melatonin a possible, practical new hope? *Nutrition* 14:712–713
- Garfinkel D, Laudon M, Nof D, Zisapel N (1995) Improvement of sleep quality in elderly people by controlled-release melatonin. *Lancet* 346:541–544
- Giovannucci E, Platz EA, Stampfer MJ, Chan A, Krithivas K, Kawachi I, Willett WC, Kantoff PW (1999) The CAG repeat within the androgen receptor gene and benign prostatic hyperplasia. *Urology* 53:121–125
- Gray A, Feldman HA, McKinlay JB, Longcope C (1991) Age, and changing sex hormone levels in middle-aged men: results of the Massachusetts male aging study. *J Clin Endocrinol Metab* 73:1016–1025
- Greendale GA, Unger JB, Rowe JW, Seeman TE (1999) The relation between cortisol excretion and fractures in healthy older people: results from the MacArthur studies-Mac. *J Am Geriatr Soc* 47:799–803
- Grimley Evans J, Malouf R, Huppert F, van Niekerk JK (2006) Dehydroepiandrosterone (DHEA) supplementation for cognitive function in healthy elderly people. *Cochrane Database Syst* 18:BCD006221
- Hajjar RR, Kaiser FE, Morley JE (1997) Outcomes of long-term testosterone replacement in older hypogonadal males: a retrospective analysis. *J Clin Endocrinol Metab* 82:3793–3796
- Handelsman DJ, Staraj S (1985) Testicular size: the effects of aging, malnutrition, and illness. *J Androl* 6:144–151
- Harkonen K, Huhtaniemi I, Makinen J, Hubler D, Irjala K, Koskenvuo M, Oettel M, Raitakari O, Saad F, Pollanen P (2003) The polymorphic androgen receptor gene CAG repeat, pituitary-testicular function and andropausal symptoms in ageing men. *Int J Androl* 26:187–194
- Harzmann R, Weckermann D, Wawroschek F (1998) Treatment of benign prostate hyperplasia. *Z Arztl Fortbild Qualitatssich* 92:319–324
- Hassan MA, Killick SR (2003) Effect of male age on fertility: evidence for the decline in male fertility with increasing age. *Fertil Steril* 79:1520–1527
- Heidenreich A, Aus G, Bolla M, Joniau S, Matveev VB, Schmid HP, Zattoni F, European Association of Urology (2008) EAU guidelines on prostate cancer. *Eur Urol* 53:68–80
- Hellstrom WJ, Overstreet JW, Sikka SC, Denne J, Ahuja S, Hoover AM, Sides GD, Cordell WH, Harrison LM, Whitaker JS (2006) Semen and sperm reference ranges for men 45 years of age and older. *J Androl* 27:421–428
- Herbert J (1995) The age of dehydroepiandrosterone. *Lancet* 345:1193–1194
- Ho KK (2007) GH Deficiency Consensus Workshop Participants. Consensus guidelines for the diagnosis and treatment of adults with GH deficiency II: a statement of the GH Research Society in association with the European Society for Pediatric Endocrinology, Lawson Wilkins Society, European Society of Endocrinology, Japan Endocrine Society, and Endocrine Society of Australia. *Eur J Endocrinol* 157:695–700
- Holstein AF (1989) Morphological evidence for the involution of spermatogenesis during senescence. In: Holstein AF, Voigt KD, Grässlin D (eds) *Reproductive biology and medicine*. Diesbach Verlag, Berlin, pp 66–77
- Johnson L, Grumbles JS, Bagheri A, Petty CS (1990) Increased germ cell degeneration during postprophase of meiosis is related to increased serum follicle-stimulating hormone concentrations and reduced daily sperm production in aged men. *Biol Reprod* 42:281–287
- Kapoor D, Malkin CJ, Channer KS, Jones TH. (2005) Androgens, insulin resistance and vascular disease in men. *Clin Endocrinol* 63:239–250
- Kapoor D, Goodwin E, Channer KS, Jones TH (2006). Testosterone replacement therapy improves insulin resistance, glycaemic control, visceral adiposity and hypercholesterolaemia in hypogonadal men with type 2 diabetes. *Eur J Endocrinol* 154:899–906
- Kaufman JM, Vermeulen A (2005) The decline of androgen levels in elderly men and its clinical and therapeutic implications. *Endocr Rev* 26:833–876
- Kelleher S, Conway AJ, Handelsman DJ (2004) Blood testosterone threshold for androgen deficiency symptoms. *J Clin Endocrinol Metab* 89:3813–3817
- Khaw KT, Dowsett M, Folkard E, Bingham S, Wareham N, Luben R, Welch A, Day N (2007) Endogenous testosterone and mortality due to all causes, cardiovascular disease, and cancer in men: European prospective investigation into cancer in Norfolk (EPIC-Norfolk) Prospective Population Study. *Circulation* 116:2694–2697
- Kidd SA, Eskenazi B, Wyrobek A (2001) Effects of male age on semen quality and fertility: a review of the literature. *Fertil Steril* 75:237–248
- Kirkwood TB (2008) Understanding ageing from an evolutionary perspective. *J Intern Med* 263:117–127
- Krassas GE, Perros P (2003) Thyroid disease and male reproductive function. *J Endocrinol Invest* 26:372–380
- Kühnert B, Nieschlag E (2004) Reproductive functions of the ageing male. *Hum Reprod Update* 10:327–339
- Kupelian V, Page ST, Araujo AB, Travison TG, Bremner WJ, McKinlay JB (2006) Low sex hormone-binding globulin, total testosterone, and symptomatic androgen deficiency are associated with development of the metabolic syndrome in non-obese men. *J Clin Endocrinol Metab* 91:843–850
- Laaksonen DE, Niskanen L, Punnonen K, Nyyssonen K, Tuomainen TP, Valkonen VP, Salonen R, Salonen JT (2004) Testosterone and sex hormone-binding globulin predict the metabolic syndrome and diabetes in middle-aged men. *Diabetes Care* 27:1036–1041
- Labrie F, Candas B, Dupont A, Cusan L, Gomez JL, Suburu RE, Diamond P, Levesque J, Belanger A (1999) Screening decreases prostate cancer death: first analysis of the 1988 Quebec prospective randomized controlled trial. *Prostate* 38:83–91
- Laughlin GA, Barrett-Connor E, Bergstrom J (2008) Low serum testosterone and mortality in older men. *J Clin Endocrinol Metab* 93:68–75
- Lepor H (2004) Pathophysiology, epidemiology, and natural history of benign prostatic hyperplasia. *Rev Urol* 6:3–10
- Levitas E, Lunenfeld E, Weisz N, Friger M, Potashnik G (2007) Relationship between age and semen parameters in men

- with normal sperm concentration: analysis of 6022 semen samples. *Andrologia* 39:45–50
- Liu PY, Iranmesh A, Nehra AX, Keenan DM, Veldhuis JD (2005) Mechanisms of hypoandrogenemia in healthy aging men. *Endocrinol Metab Clin North Am* 34:935–955
- Lombardi G, Di Somma C, Rota F, Colao A (2005) Associated hormonal decline in aging: is there a role for GH therapy in aging men? *J Endocrinol Invest* 28:99–108
- Lucia MS, Epstein JI, Goodman PJ, Darke AK, Reuter VE, Civantos F, Tangen CM, Parnes HL, Lippman SM, La Rosa FG, Kattan MW, Crawford ED, Ford LG, Coltman CA Jr, Thompson IM (2007) Finasteride and high-grade prostate cancer in the Prostate Cancer Prevention Trial. *J Natl Cancer Inst* 99:1375–1383
- Luetjens CM, Rolf C, Gassner P, Werny JE, Nieschlag E (2002) Sperm aneuploidy rates in younger and older men. *Hum Reprod* 17:1826–1832
- Madersbacher S, Alivizatos G, Nordling J, Sanz CR, Emberton M, de la Rosette JJ (2004) EAU 2004 guidelines on assessment, therapy and follow-up of men with lower urinary tract symptoms suggestive of benign prostatic obstruction (BPH guidelines). *Eur Urol* 46:547–554
- Madersbacher S, Berger I, Ponholzer A, Marszalek M (2008) Plant extracts: sense or nonsense? *Curr Opin Urol* 18:16–20
- Mahmoud AM, Goemaere S, El-Garem Y, Van Pottelberg Y, Comhaire FH, Kaufman JM (2003) Testicular volume in relation to hormonal indices of gonadal function in community-dwelling elderly men. *J Clin Endocrinol Metab* 88:179–184
- Mariotti S (2002) Ageing and thyroid diseases. In: Wass JAH, Shalet SM (eds) *Oxford textbook of endocrinology and diabetes*. Oxford University Press, Oxford, pp 1425–1422
- McVary KT (2006) BPH: epidemiology and comorbidities. *Am J Manag Care* 12:122–128
- Meier C, Nguyen TV, Handelsman DJ, Schindler C, Kushnir MM, Rockwood AL, Meikle AW, Center JR, Eisman JA, Seibel MJ (2008). Endogenous sex hormones and incident fracture risk in older men: the Dubbo Osteoporosis Epidemiology Study. *Arch Intern Med* 14:47–54
- Michikawa Y, Mazzucchelli F, Bresolin N, Scarlato G, Attardi G (1999) Aging-dependent large accumulation of point mutations in the human mtDNA control region for replication. *Science* 286:774–779
- Morganti S, Ceda GP, Saccani M, Milli B, Ugolotti D, Prampolini R, Maggio M, Valenti G, Ceresini G (2007) Thyroid disease in the elderly: sex-related differences in clinical expression. *J Endocrinol Invest* 28:101–104
- Morley JE, Kaiser FE, Johnson LE (1990) Male sexual function. In: Cassel CK, Riesenber DE, Sorensen LB, Walsh JR (eds) *Geriatric medicine*, 2nd edn. Springer, Berlin/Heidelberg/New York/Tokyo, pp 256–270
- Muller M, Grobbee DE, den Tonkelaar I, Lamberts SW, van der Schouw YT (2005) Endogenous sex hormones and metabolic syndrome in aging men. *J Clin Endocrinol Metab* 90:2618–2623
- Mulligan T, Frick MF, Zuraw QC, Stemhagen A, McWhirter C (2006) Prevalence of hypogonadism in males aged at least 45 years: the HIM study. *Int J Clin Pract* 60:762–769
- Neaves WB, Johnson L, Porter JC, Parker CR, Petty CS (1985) Leydig cell numbers, daily sperm production, and serum gonadotropin-levels in aging men. *J Clin Endocrinol Metab* 59:756–763
- Neuhouser ML, Schenk J, Song YJ, Tangen CM, Goodman PJ, Pollak M, Penson DF, Thompson IM, Kristal AR (2008) Insulin-like growth factor-1, insulin-like growth factor binding protein-3 and risk of benign prostate hyperplasia in the prostate cancer prevention trial. *Prostate* 68:1477–1486
- Nieschlag E, Michel E (1986) Reproductive functions in grandfathers. In: Mastroianni L, Paulsen CA (eds) *Aging, reproduction, and the climacteric*. Plenum, New York, pp 59–71
- Nieschlag E, Lammers U, Freischem CW, Langer K, Wickings EJ (1982) Reproductive functions in young fathers and grandfathers. *J Clin Endocrinol Metab* 55:676–681
- Nieschlag E, Brinkworth M, Rolf C, Lerchl A (2000) Fertility and fertility related problems in the ageing male. Proceedings of the 9th International Menopause Society, World Congress of the Menopause, Parthenon, London
- Nieschlag E, Swerdloff R, Behre HM, Gooren LJ, Kaufman JM, Legros JJ, Lunenfeld B, Morley JE, Schulman C, Wang C, Weidner W, Wu FC (2005) Investigation, treatment and monitoring of late-onset hypogonadism in males: ISA, ISSAM, and EAU recommendations. *Int J Androl* 28:125–127
- Nybo Andersen AM, Hansen KD, Andersen PK, Davey Smith G (2004) Advanced paternal age and risk of fetal death: a cohort study. *Am J Epidemiol* 160:1214–1222
- Pope HG Jr, Cohane GH, Kanayama G, Siegel AJ, Hudson JI (2003) Testosterone gel supplementation for men with refractory depression: a randomized, placebo-controlled trial. *Am J Psychiatry* 160:105–111
- Quinn M, Babb P (2002) Patterns and trends in prostate cancer incidence, survival, prevalence and mortality. Part I: international comparisons. *BJU Int* 90:162–173
- Reid IR, Wattie DJ, Evans MC, Stapleton JP (1996) Testosterone therapy in glucocorticoid-treated men. *Arch Intern Med* 156:1173–1177
- Rolf C, Nieschlag E (1998) Potential adverse effects of long-term testosterone therapy. *Baillieres Clin Endocrinol Metab* 12:521–534
- Rolf C, Behre HM, Nieschlag E (1996) Reproductive parameters of older compared to younger men of infertile couples. *Int J Androl* 19:135–142
- Rolf C, Kenkel S, Nieschlag E (2002a) Age-related disease pattern in infertile men: increasing incidence of infections in older patients. *Andrologia* 34:209–217
- Rolf C, von Eckardstein S, Koken U, Nieschlag E (2002b) Testosterone substitution of hypogonadal men prevents the age-dependent increases in body mass index, body fat and leptin seen in healthy ageing men: results of a cross-sectional study. *Eur J Endocrinol* 146:505–511
- Rudman D, Feller AG, Nagraj HS, Nagraj HS, Gergans GA, Lalitha PY, Goldberg AF, Schlenker RA, Cohn L, Rudman IW, Mattson DE (1990) Effects of human growth hormone in men over 60 years old. *N Engl J Med* 323:1–6
- Sartorius G, Nieschlag E (2009) Paternal age and reproduction. *Hum Reprod Update* epub Aug. 20
- Schlüter D (1978) Die endokrinen Organe der Über-Neunzigjährigen. Dissertation Universität Hamburg
- Seidman SN, Araujo AB, Roose SP, McKinlay JB (2001) Testosterone level, androgen receptor polymorphism, and

- depressive symptoms in middle-aged men. *Biol Psychiatry* 50:371–376
- Shores MM, Matsumoto AM, Sloan KL, Kivlahan DR (2006) Low serum testosterone and mortality in male veterans. *Arch Intern Med* 166:1660–1665
- Sih R, Morley JE, Kaiser FE, Perry HM 3rd, Patrick P, Ross C (1997) Testosterone replacement in older hypogonadal men: a 12-month randomized controlled trial. *J Clin Endocrinol Metab* 82:1661–1667
- Snyder PJ, Peachey H, Hannoush P, Berlin JA, Loh L, Holmes JH, Dlewati A, Staley J, Santanna J, Kapoor SC, Attie MF, Haddad JG Jr, Strom BL (1999a) Effect of testosterone treatment on bone mineral density in men over 65 years of age. *J Clin Endocrinol Metab* 84:1966–1972
- Snyder PJ, Peachey H, Hannoush P, Berlin JA, Loh L, Lenrow DA, Holmes JH, Dlewati A, Santanna J, Rosen CJ, Strom BL (1999b) Effect of testosterone treatment on body composition and muscle strength in men over 65 years of age. *J Clin Endocrinol Metab* 84:2647–2653
- Statistisches Bundesamt (Hrsg) *Statistische Jahrbücher* (1980–2008) für die Bundesrepublik Deutschland. Metzler Poeschel Verlag, Stuttgart
- Suzuki K, Ito K, Ichinose Y, Kurokawa K, Suzuki T, Imai K, Yamanaka H, Honma S (1995) Endocrine environment of benign prostatic hyperplasia: prostate size and volume are correlated with serum estrogen concentration. *Scand J Urol Nephrol* 29:65–68
- Swerdlow AJ (2006) Does growth hormone therapy increase the risk of cancer? *Nat Clin Pract Endocrinol Metab* 2:530–531
- Tarin JJ, Brines J, Cano A (1998) Long-term effects of delayed parenthood. *Hum Reprod* 13:2371–2376
- Tenover JS (1994) Androgen administration to aging men. *Endocrinol Metab Clin North Am* 23:878–892
- Thompson IM, Goodman PJ, Tangen CM, Lucia MS, Miller GJ, Ford LG, Lieber MM, Cespedes RD, Atkins JN, Lippman SM, Carlin SM, Ryan A, Szczepanek CM, Crowley JJ, Coltman CA Jr (2003) The influence of finasteride on the development of prostate cancer. *N Engl J Med* 349: 215–224
- Tivesten A, Mellström D, Jutberger H, Fagerberg B, Lernfelt B, Orwoll E, Karlsson MK, Ljunggren O, Ohlsson C (2007) Low serum testosterone and high serum estradiol associate with lower extremity peripheral arterial disease in elderly men. The MrOS Study in Sweden. *J Am Coll Cardiol* 50:1070–1076
- Umbreit K (1993) Ist eine Substitution mit Estradiol auch bei Männern angezeigt? *Gyne* 14:56–60
- Valtonen M, Niskanen L, Kangas AP, Koskinen T (2005) Effect of melatonin-rich night-time milk on sleep and activity in elderly institutionalized subjects. *Nord J Psychiatry* 59:217–221
- Vance ML (2003) Can growth hormone prevent aging? *N Engl J Med* 348:779–780
- Vance ML, Mauras N (1999) Growth hormone therapy in adults and children. *N Engl J Med* 341:1206–1216
- Vermeulen A, Kaufman JM (1995) Ageing of the hypothalamo-pituitary-testicular axis in men. *Horm Res* 43:25–28
- von Eckardstein A, Wu FCW (2004) Testosterone and cardiovascular diseases. In: Nieschlag E, Behre HM (eds) *Testosterone: action, deficiency, substitution*, 3rd edn. Cambridge University Press, Cambridge, pp 297–332
- von Mühlen D, Laughlin GA, Kritiz-Silverstein D, Bergstrom J, Bettencourt R (2008) Effect of dehydroepiandrosterone supplementation on bone mineral density, bone markers, and body composition in older adults: the DAWN trial. *Osteoporos Int* 19:699–670
- Wang C, Alexander G, Berman N, Salehian B, Davidson T, McDonald V, Steiner B, Hull L, Callegari C, Swerdloff RS (1996) Testosterone replacement therapy improves mood in hypogonadal men – a clinical research center study. *J Clin Endocrinol Metab* 81:3578–3583
- Wang C, Nieschlag E, Swerdloff RS, Behre H, Hellstrom WJ, Gooren LJ, Kaufman JM, Legros JJ, Lunenfeld B, Morales A, Morley JE, Schulman C, Thompson IM, Weidner W, Wu FC (2008) ISA, ISSAM, EAU, EAA and ASA recommendations: investigation, treatment and monitoring of late-onset hypogonadism in males. *Aging Male* 1:1–8
- Webb CM, Elkington AG, Kraidly MM, Keenan N, Pennell DJ, Collins P (2008) Effects of oral testosterone treatment on myocardial perfusion and vascular function in men with low plasma testosterone and coronary heart disease. *Am J Cardiol* 101:618–624
- Woodhouse LJ, Gupta N, Bhasin M, Singh AB, Ross R, Phillips J, Bhasin S (2004) Dose-dependent effects of testosterone on regional adipose tissue distribution in healthy young men. *J Clin Endocrinol Metab* 89:718–726
- Wu FC, Tajar A, Pye SR, Silman AJ, Finn JD, O'Neill TW, Bartfai G, Casanueva F, Forti G, Giwercman A, Huhtaniemi IT, Kula K, Punab M, Boonen S, Vaderschueren D, European Male Aging Study Group (2008) Hypothalamic-pituitary-testicular axis disruptions in older men are differentially linked to age and modifiable risk factors: the European Male Aging Study. *J Clin Endocrinol Metab* 93:2737–2745
- Zitzmann M (2006) Testosterone and the brain. *Aging Male* 9:195–199
- Zitzmann M, Nieschlag E (2007) Androgen receptor gene CAG repeat length and body mass index modulate the safety of long-term intramuscular testosterone undecanoate therapy in hypogonadal men. *J Clin Endocrinol Metab* 92: 3844–3853
- Zitzmann M, Depenbusch M, Gromoll J, Nieschlag E (2003) Prostate volume and growth in testosterone-substituted hypogonadal men are dependent on the CAG repeat polymorphism of the androgen receptor gene: a longitudinal pharmacogenetic study. *J Clin Endocrinol Metab* 88:2049–2054
- Zitzmann M, Faber S, Nieschlag E (2006) Association of specific symptoms and metabolic risks with serum testosterone in older men. *J Clin Endocrinol Metab* 91:4335–4343

Hermann M. Behre, Eberhard Nieschlag,
Wolfgang Weidner, and Peter Wieacker

Contents

15.1	Infections of the Seminal Ducts	264	15.5.2	Therapy	273
	15.1.1 Etiology and Pathogenesis	264	15.6	Disorders of Liquefaction	273
	15.1.2 Clinical Picture and Diagnosis	264	15.7	Immunological Infertility	273
	15.1.3 Therapy	266		15.7.1 Etiology and Pathogenesis.....	273
15.2	Obstructions	266		15.7.2 Clinical Picture	273
	15.2.1 Etiology and Pathogenesis	266		15.7.3 Diagnosis	274
	15.2.2 Clinical Picture	267		15.7.4 Therapy	274
	15.2.3 Diagnosis	267	References		275
	15.2.4 Therapy	268			
15.3	Cystic Fibrosis	268			
	15.3.1 Etiology and Pathogenesis.....	268			
	15.3.2 Clinical Picture and Diagnosis	269			
	15.3.3 Therapy	269			
15.4	Congenital Absence of the Vas Deferens	270			
	15.4.1 Etiology and Pathogenesis	270			
	15.4.2 Clinical Picture and Diagnosis	271			
	15.4.3 Therapy	271			
	15.4.4 Unilateral Absence of the Vas Deferens	271			
	15.4.5 Bilateral Obstruction of the Ejaculatory Ducts	272			
15.5	Young Syndrome	272			
	15.5.1 Etiology and Pathogenesis.....	272			
	15.5.2 Clinical Picture and Diagnosis	272			

H. M. Behre (✉)
Centre for Reproductive Medicine and Andrology
of the University, Ernst-Grube-Str. 40,
D-06120 Halle, Germany
e-mail: hermann.behre@medizin.uni-halle.de

15.1 Infections of the Seminal Ducts

15.1.1 Etiology and Pathogenesis

Infections of the seminal ducts can lead to male infertility by different mechanisms. **Direct damage of spermatozoa** is caused by microorganisms or their secretory products (Diemer et al. 2000, 2003), while **secondary inflammation** is produced by increased numbers of activated leukocytes and an elevated secretion of lymphokines and monokines. In addition, increased formation of reactive oxygen species (ROS) can reduce the fertilization capacity of the spermatozoa (De Geyter et al. 1994; Comhaire et al. 1999; Weidner et al. 1999; Agarwal and Salek 2002). Infections can also lead to **uni- or bilateral obstructions** of the seminal ducts, as well as to **dysfunction of cohabitation and ejaculation** (Purvis and Christiansen 1993; WHO 1993). Furthermore, acute epididymitis can lead to infection of the testis (**epididymoorchitis**) (Ludwig 2008).

Whereas obstructive azoospermia caused by the classic venereal diseases, such as **gonorrhea**, was formerly a common reason for male infertility among European men (i.e., before antibiotics became generally available), nowadays **Chlamydia trachomatis** and **Mycoplasma spp.**, and particularly **Ureaplasma urealyticum**, as well as **gram-negative bacteria typical of urogenital infections** are the predominant microorganisms causing an infection of the seminal ducts (Paavonen and Eggert-Kruse 1999; Weidner et al. 1999; Schneede et al. 2003). The infections are manifested along the seminal ducts (see Fig. 3.5) in the forms of **urethritis**, **prostatitis**, **vesiculitis** or **epididymitis**, but can often present without clinical symptoms. For **orchitis** see Sect. 13.5.

15.1.2 Clinical Picture and Diagnosis

Acute **epididymitis** is characterized by scrotal pain as well as local swelling and tenderness; it can cause fever and general malaise. Sonography of the scrotal content allows direct visualization of the epididymides, which are enlarged and hypo-echoic when inflamed.

The testis can be involved in the process as epididymo-orchitis (Ludwig 2008). The type of pathogen varies with the age of the patient. Among younger men infections are often caused by *Chlamydia trachomatis* and *Neisseria gonorrhoeae* (Weidner et al. 1999). *Escherichia coli*, *Pseudomonas aeruginosa* and typical bacteria for urinary tract infections are more common in older men. **Chronic epididymitis** with infiltrations, which occur in approximately 15% of patients, can eventually lead to scar formation in the tubules and thereby to obstruction. In these patients, extended diagnostics of infections, uroflowmetry and sonography are needed. When findings are pathological, diagnostic work-up can be completed by cystoscopy, voiding cystourethrography and manometry (Tracy et al. 2008).

According to the National Institutes of Health (NIH; Nickel 1998), **prostatitis** is classified as follows:

- **Acute bacterial prostatitis** (category I: leukocytes and uropathogenic bacteria in midstream urine)
- **Chronic bacterial prostatitis** (category II: leukocytes and uropathogenic bacteria in expressed prostatic secretions or urine after prostatic massage; chronic or recurrent infections)
- **Chronic abacterial prostatitis** (category IIIA: leukocytes in expressed prostatic secretions, urine after prostatic massage or ejaculate, no detection of uropathogenic bacteria; category IIIB: no leukocytes or uropathogenic bacteria in expressed prostatic secretions or ejaculate)
- **Asymptomatic inflammatory prostatitis** (category IV: leukocytes in expressed prostatic secretions, urine after prostatic massage or ejaculate, no clinical symptoms)

More than 10–15 leukocytes per high-power field ($\times 1,000$) in expressed prostatic secretions or ≥ 3 leukocytes per high-power field in the urine after prostate massage can be considered as significant (Weidner et al. 1999). Only in case of purulent prostatic secretions is the **four-specimen test** for bacterial localization to be applied for further diagnostics (Weidner and Anderson 2008).

Acute prostatitis can be diagnosed by acute febrile symptoms and the detection of the respective pathogens. A prostatic abscess is characterized by typical rectal palpation, positive urinary culture and an abscess cavity in transrectal ultrasonography. The diagnostics of **chronic prostatitis** can be difficult because of uncharacteristic

rectal palpation. The main indications for diagnosis are the detection of leukocytes in urine, expressed prostatic specimens, and ejaculate. A chronic bacterial prostatitis is probable if the number of pathogens in the urine is ten times higher after prostate massage compared to urine before (Nickel 1998). *Escherichia coli* is the most common pathogen in bacterial prostatitis (Weidner et al. 1999; Weidner and Anderson 2008).

Inflammation of the seminal glands (**vesiculitis**) is not a distinct entity but appears clinically as male **ad-nexitis** or **prostatovesiculitis**. The symptoms of *prostatovesiculitis* can range from non-specific complaints in the perineal region to an acute clinical picture with high fever, purulent bacterial inflammation and abscesses. Tenderness to pressure and pasty consistency of the prostate and seminal gland can be found at rectal palpation. Hematospermia is a characteristic symptom (Munkelwitz et al. 1997; Furuya et al. 1999). Patients with prostatovesiculitis often show inhomogeneities or calcifications of the prostate, intraprostatic cysts, cysts of the ejaculatory ducts, and enlargements, asymmetries, disturbances of depletion and cysts of the seminal vesicles. These findings are, however, not proof of an infection or of inflammatory origin; this also applies to elevated PSA levels (Weidner et al. 2008). In addition to clinical symptoms, increased numbers of leukocytes or pathogenic bacteria in the native ejaculate or after prostatic massage are typical for the diagnosis of prostatovesiculitis.

Patients with manifest **urethritis** complain of dysuria and urethral discharge, itching or pain. Redness of the glans and external orificium are typical. Infectious urethritis is often caused by *Neisseria gonorrhoeae*, *Chlamydia trachomatis* and *Ureaplasma urealyticum* (Schiefer 1998). If urethral discharge is not present, the detection of granulocytes (≥ 15 per microscopic field at 400 \times) in the sediment of 3 ml of the first part of voided bladder urine is pathognomonic.

In infertile men inflammations of the seminal ducts are often **clinically silent**. Sometimes these patients have previously had infections of the urinary tract or **sexually transmitted diseases (STD)**.

The suspicion of an infection of the seminal ducts has to be clarified by **microbiological investigations**. The microorganisms can be identified directly from the **ejaculate, expressed prostatic secretion** or a **urethral swab**. A concentration of $\geq 1,000$ colony forming units/ml ejaculate of gram-negative bacteria typical of urogenital infections or *Ureaplasma urealyticum* is significant (Weidner et al. 1999). It must be emphasized, however, that the

detection of *Chlamydia trachomatis* infection by culture is complicated by the presence of cytotoxic components of the seminal plasma and is not recommended. For this reason, the indirect proof of the infection by determination of IgA- or IgG-antibodies against *Chlamydia* in seminal plasma was attempted. If at all, proof of secretory IgA seems to be indicative (Mazzoli et al. 2007). Studies applying direct detection of *Chlamydia*-DNA by means of the polymerase chain reaction (**PCR**) show, however, no direct association between antibodies and the actual presence of microorganisms in the ejaculate (Dieterle et al. 1995) so that PCR detection from the first voided urine fraction can still be considered as the “gold standard” in the diagnosis of *Chlamydia trachomatis* infection.

If direct detection of microorganisms is not possible, an **increased leukocyte concentration (≥ 1 million/ml ejaculate)** is often indicative of infection (WHO 2009). The detection of granulocytes by peroxidase staining (see Sect. 9.3.4.2) is sufficient in most cases (Wang et al. 1994); however, an exact characterization of the leukocyte subpopulations and their level of activity is only possible by **immunocytology** (Wolff 1995). It should be noted, however, that leukocytospermia is not always associated with bacterial or viral infections. In addition to the determination of leukocytes, biochemical markers of inflammation (granulocyte elastase, complement factor C3, ceruloplasmin) have been used to detect infection of the seminal ducts. Increased concentrations of **granulocyte elastase** (>600 ng/ml ejaculate) indicate infection (Ludwig et al. 1998). Interleukin 8 is being discussed as a new predictive marker for the chronic pelvic pain syndrome (Penna et al. 2007).

Seminal duct infections can also lead to increased ejaculate viscosity, lower ejaculate volume, increased pH, as well as to decreased levels of the markers for accessory gland function in the ejaculate (e.g., **α -glucosidase** for the epididymis, **fructose** for the seminal vesicles, **zinc** for the prostate gland, see Sect. 9.4) (Comhaire et al. 1989; Cooper et al. 1990; WHO 1999).

In individual cases, diagnosis of an infection of the seminal ducts can be complicated, since neither normal leukocyte concentrations nor the failure to detect microorganisms in the ejaculate can categorically exclude an infection. Therefore, for practical reasons, the combination of a significant number of microorganisms and an increased leukocyte concentration in the ejaculate or the combination of one of these parameters with clinical symptoms is required for the diagnosis of an infection of the seminal ducts (WHO 1993).

15.1.3 Therapy

The therapy of an infection in the seminal ducts should be based on the respective microorganisms and the resistogram (Krieger 1995; Seligson et al. 1998; Centers for Disease Control and Prevention 2006, 2007; Grabe et al. 2009). Azithromycin or **tetracyclines** are the drugs of choice for ***Chlamydia trachomatis*** infections (e.g., azithromycin 1 g p.o. single dose, doxycycline 2 × 100 mg/day p.o. for 7–14 days). ***Ureaplasma urealyticum*** infections can be treated with **tetracycline** (dosage as above) or **erythromycine** (2 g/day p.o. for 7–10 days). Because of a high co-infection with *Chlamydia trachomatis*, **gonorrhoea** is treated with cefixim (400 mg p.o. single dose) or **ceftriaxone** (125 mg i.m. single dose) combined with azithromycin or **tetracyclines** (dosage see above) (Centers for Disease Control and Prevention 2007). An uncomplicated **epididymitis** should be treated with **ceftriaxone** (250 mg i.m. single dose) **in combination with** 2 × 100 mg/day **doxycycline** p.o. for 10 days, and an acute epididymitis most likely caused by enteric organisms or with negative gonococcal culture or nucleic acid amplification test should be treated with ofloxacin 300 mg orally twice a day 10 days or with levofloxacin 500 mg orally once daily for 10 days (Centers for Disease Control and Prevention 2007). *Gardnerella vaginalis* or *Trichomonas vaginalis* infections are treated with metronidazole (2 g p.o., single dose).

Acute, bacterial **prostatitis** is treated for at least four weeks with a broad-spectrum penicillin, a third-generation cephalosporin, or a fluoroquinolone which might be combined with an aminoglycoside for initial therapy, and in many instances with additional suprapubic bladder drainage (Weidner et al. 2008; Grabe et al. 2009). In less severe cases, a fluoroquinolone may be given orally for 10 days. In general, surgery should be avoided in the treatment of prostatitis patients, except for drainage of prostatic abscesses. Chronic bacterial prostatitis is treated with fluorochinolones for at least 4–6 weeks (Weidner et al. 2008). If unsuccessful, patients should receive long-term therapy with 50 mg/day trimethoprim or nitrofurantoin for 3–6 months. Causal therapy of abacterial prostatitis (NIH III) is not possible. It must be stressed that from an andrological point of view, this symptomatic therapy currently under discussion may lead to complications (Weidner et al. 2008) (Table 15.1).

Four to eight weeks after the completion of a course of antibiotic treatment the patients should be re-examined to test for therapeutic efficacy. It must be remembered, however, that antibiotics can temporarily lead to a dete-

Table 15.1 Suggested symptomatic therapy of chronic prostatitis/chronic pelvic pain syndrome and potential andrological side-effects

Symptomatic therapy	Andrological side effects
Alpha-blockers	Retrograde ejaculation, reduced ejaculate volume
Intraprostatic antibiotic injections	Hemospermia
Finasteride	Sexual dysfunction
Intraprostatic Botox®-injections	Hemospermia
Pentosan-polysulfate instillation	Hematuria, hemospermia

rioration of the ejaculate parameters and fertilization capacity (DeGeyter et al. 1994) as a result of direct negative effects on spermatogenesis and sperm function (Schlegel et al. 1991).

The **simultaneous diagnosis and therapy of the female partner** is highly important for effective therapy of an STD-infection of the seminal ducts, as otherwise “ping-pong” – infections between both partners may occur (see Chap. 20). Circumcision can be regarded as effective prevention of HIV infections transmitted by sexual intercourse (Padian et al. 2008).

15.2 Obstructions

15.2.1 Etiology and Pathogenesis

Obstructions of the seminal ducts can occur in the epididymis and the deferent and ejaculatory ducts (see Fig. 3.5). In addition to congenital aplasia of the deferent ducts and bilateral obstruction of the ejaculatory ducts, which is described separately in Sects. 15.3 and 15.4, and the rare Young syndrome (see Sect. 15.5), acute or chronic epididymitis or inflammations of the seminal vesicles and prostate gland can lead to obstruction (see Sect. 15.1, Table 15.2). Iatrogenic obstruction can be a complication arising from a herniotomy (particularly in childhood), from operations in the region of the ejaculatory ducts, and vasography of the seminal ducts with irritating contrast media. Sperm recovery from the epididymis (**PESA** [percutaneous epididymal sperm aspiration], more rarely **MESA** [microsurgical epididymal sperm aspiration]) or inadvertently performed incisions or biopsies of the epididymis lead, in most cases, to an iatrogenic obstruction. Bilateral vasectomy can be regarded as an acquired obstruction of the seminal ducts.

Recent investigations show that alterations in the region of the ejaculatory ducts can cause obstructions of

Table 15.2 Causes of obstruction in the seminal ducts

Epididymis
<ul style="list-style-type: none"> • Acute or chronic epididymitis (past or present) • (Accidental) Incision or biopsy of the epididymis • PESA (percutaneous epididymal sperm aspiration), MESA (microsurgical epididymal sperm aspiration)
Deferent duct
<ul style="list-style-type: none"> • Aplasia/hypoplasia of the deferent duct and distal epididymis • Vasectomy • Vasography with irritant contrast media • Herniotomy with accidental ligation of the deferent duct
Ejaculatory duct
<ul style="list-style-type: none"> • Congenital cysts (utricular cysts), prostatic cysts, cysts of the seminal vesicles • Infection • Trauma • Postoperative

the seminal ducts more frequently than formerly thought. Examples are utricular or intraprostatic cysts, in which external pressure can lead to obstruction of the ejaculatory ducts (see Fig. 15.1), or internal stenosis and cystic enlargements of the ejaculatory ducts (Pryor and Hendry 1991; Meacham et al. 1993) (see Sect. 15.4.5).

15.2.2 Clinical Picture

Complete bilateral obstruction of the seminal ducts leads to **azoospermia** and therefore to infertility. A **unilateral obstruction can be compensated**

completely by the contralateral side, if this testis and seminal ducts are intact, and thus may remain symptomless. **Partial obstructions** on both sides can lead, according to the degree of obstruction, to a significant deterioration of the ejaculate parameters with severe oligo(astheno)teratozoospermia.

If the obstruction is proximal to the ejaculatory ducts, the **ejaculate volume** generally remains normal, since the largest part of the seminal plasma originates from the seminal vesicles and prostate gland. A distal obstruction, however, leads to parvispermia (ejaculate volume <2 ml).

15.2.3 Diagnosis

Obstructive azoospermia is the principal differential diagnosis of **normal testicular volume, normal FSH** in combination with **azoospermia** (see Fig. 7.1). Thickening and induration of the epididymis, and aplasia or hypoplasia of the deferent duct can be detected by palpation. **Ultrasonography** of the scrotal content allows direct imaging of cystic alterations of the epididymis which must be considered as causes of the obstruction (see Chap. 6), while changes in the region of the prostate gland and seminal vesicles (infectious alterations, anomalies, cysts in the area of the ejaculatory ducts) are detected by transrectal ultrasonography (Fig. 15.1, see Chap. 6).

The most helpful variables for differential diagnosis of an obstruction are the **marker substances** for the **epididymis** (α -glucosidase), **seminal vesicle** (fructose)

Fig. 15.1 Large utricular cyst (◄) with secondary obstruction of the ejaculatory ducts as demonstrated by transrectal ultrasonography

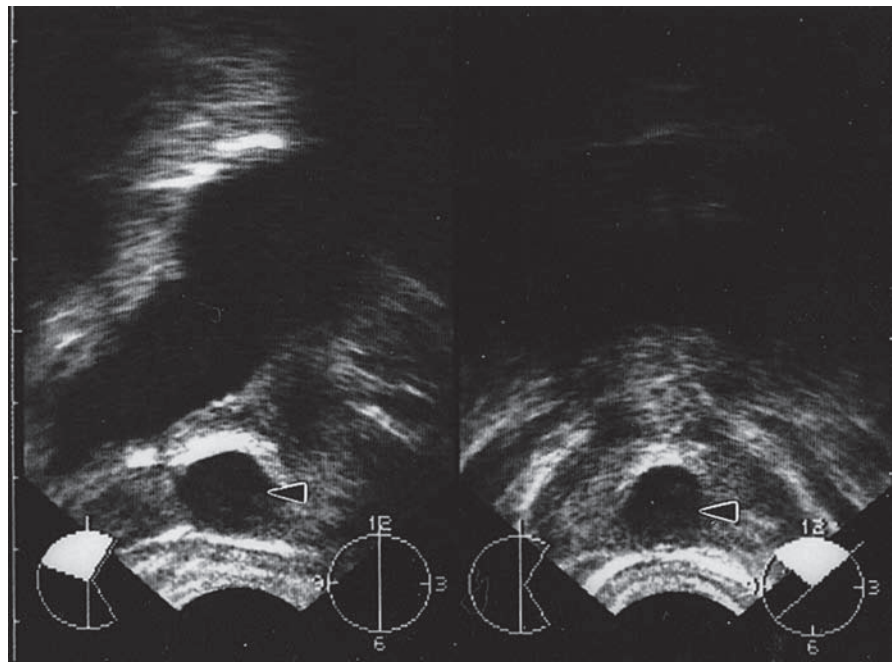

and prostate gland (zinc) in the seminal plasma (see Sect. 9.4). If a patient has a bilateral obstruction, marker substances secreted above the level of obstruction are not demonstrable in the ejaculate, while the levels of the markers secreted by organs distal to the obstruction are normal. Differential diagnosis can be difficult if the obstruction is unilateral or only partial. It is controversial whether a **bilateral testicular biopsy** for the evaluation of spermatogenesis should be obligatory for the evaluation of spermatogenesis before microsurgical re-anastomosis (Lee et al. 2009). It should, however, be performed when spermatogenic arrest is suspected which may occur in the presence of normal testicular volume and normal FSH values; if this suspicion is confirmed by biopsy it spares the patient unnecessary reconstructive surgery.

15.2.4 Therapy

In patients with an obstruction of the seminal ducts and in the presence of probable or histologically confirmed at least qualitatively normal spermatogenesis, a **vasoepididymostomy** (epididymal obstruction) or a **vasovasostomy** (e.g., after vasectomy, see Chap. 28) can be performed. The success of the operation as regards patency of the seminal ducts is dependent on the primary cause of obstruction, its duration and the surgical technique employed (Belker et al. 1991). In obstructive azoospermia and possible re-anastomosis microsurgical techniques are superior to techniques of assisted reproduction regarding long-term pregnancy rates and costs and should be applied on first instance (Kolettis and Thomas 1997). The patient must be informed, however, that even if patency is re-established, fertility can remain reduced because of anti-sperm antibodies (see Sect. 15.7), and that a secondary obstruction can occur.

In principle, **microsurgical techniques** should be used for epididymo- or vasovasostomy because of higher patency rates. Preferably they should be performed in specialized centers, as the success rate clearly rises with the number of microsurgical operations per year performed by one operating team (Schlegel and Goldstein 1993).

Transurethral resection of obstructed ejaculatory ducts and cysts can lead to significant improvements in ejaculate parameters and pregnancy rates (Meacham et al. 1993).

If patency of the seminal ducts cannot be achieved, or microsurgery is indicated because of the anatomical

conditions, direct microsurgical sperm aspiration from the epididymis (**MESA**) or sperm extraction from the testis (**TESE**) in combination with **assisted fertilization (ICSI: intracytoplasmic sperm injection)** can be offered to the couple (see Chap. 23). Here, spermatozoa aspirated from the epididymis should, in parallel, be cryopreserved for a possible second ICSI attempt or if another pregnancy is desired in the future (see Chap. 24). Because of variability of anatomical structures, increased trauma and inferior efficacy, **fine needle biopsy or percutaneous sperm aspiration from the testis or epididymis** should not be applied for sperm recovery (Ezeh et al. 1998; Sperling 1999; Tournaye 1999).

15.3 Cystic Fibrosis

15.3.1 Etiology and Pathogenesis

Cystic fibrosis (CF) is one of the most **common autosomal recessive disorders** in Caucasian populations, where it affects approximately one in 2,500 children. Until recently, only pediatricians were concerned with cystic fibrosis. Improved therapy allows increasing numbers of these patients to reach adulthood. The current mean life expectancy for Middle European CF patients has reached 30 years and is further increasing. While formerly fertility and parenthood could not be considered for individuals affected with CF, these issues are now gaining importance in the clinical management of the disorder.

Mutations in the CFTR gene are the basic cause of cystic fibrosis. The acronym CFTR is derived from “cystic fibrosis transmembrane conductance regulator”, a name that points to the function of the CFTR protein as a membrane-bound ion channel. Extending over 230,000 base pairs and 27 exons, CFTR is a large gene. Since it was cloned in 1989 more than 800 different mutations have been characterized. Among patients of Middle European ancestry **pF508del** is responsible for 70% of the CF alleles; there is evidence of a north-south gradient (about 87% in Denmark and 50% in Italy). This is a three base pair deletion resulting in the loss of a phenylalanine residue on the protein level. About ten other mutations are responsible for a further 10–15% of CF alleles. All other mutations are exceedingly rare. Owing to the size of the gene and the highly heterogeneous mutational spectrum, routine analysis

characterizes only 85% of all CF alleles. When it appears necessary it is possible to sequence the CFTR gene. There is a limited correlation between clinical phenotype and the type of mutation (Kerem and Kerem 1996). Probably other genes can modify the effects of CFTR mutations. This would explain the considerable clinical variability observed in patients with an identical CFTR genotype (Zielenski et al. 1999).

15.3.2 Clinical Picture and Diagnosis

The CFTR protein is strongly expressed in the **airway epithelia**, where it acts as a regulator of electrolyte transport. If the protein is deficient or dysfunctional because of a mutation, the bronchial secretions become abnormally viscous. Obstruction and bacterial colonization of the airways ensue, and progressive impairment of lung function and right ventricular failure develop as secondary complications. The pulmonary disease process usually determines the long-term course of cystic fibrosis. 85% of the patients have **pancreatic insufficiency**. Meconium ileus is a severe complication of CF in the newborn.

An **increased sweat chloride concentration** is the laboratory hallmark of cystic fibrosis (Stern 1997). Sweat secretion must be stimulated by local pilocarpin electrophoresis. To provide reliable results, the test needs to be carried out under strictly standardized conditions. Owing to its susceptibility to technical error, this diagnostic procedure should be performed only by laboratories with special expertise. A sweat chloride concentration of more than 60 mmol/l is diagnostic of CF. Borderline levels in the range from 40 to 60 mmol/l neither exclude nor confirm cystic fibrosis and are difficult to interpret.

Obstructive azoospermia is found in more than 95% of all men affected with CF. Most have a bilateral congenital occlusion of the proximal vas deferens or the epididymis (Kaplan et al. 1968). However, in some patients it is impossible to determine the exact level of the seminal duct obstruction (Wilschanski et al. 1996).

In typical cases the intrascrotal portion of the **vas** is **either totally absent or reduced to a cordlike structure** without a lumen. Mostly, the **epididymal corpus and cauda** are **hypo- or aplastic**. The **head of the epididymis**, not a derivative of the Wolffian ducts, is

usually preserved and markedly **dilated**. Most men with CF have an **intact testicular parenchyma**, but nonspecific histological abnormalities are occasionally observed. These probably result from the long-term obstruction of the seminal ducts or the poor general health of these men. Sonography of the testes sometimes shows calcifications, cystic or hypoechoic areas (Wilschanski et al. 1996) (see Chap. 6). Aplasia of the deferent duct and epididymis is typically associated with **abnormalities of the seminal vesicles**, the latter being quite variable from patient to patient. Aplasia or hypoplasia, obstruction, dilatation and cystic degeneration may be observed. The seminal vesicle anomalies explain the almost universal finding of a **subnormal ejaculate volume**.

A small **minority of male CF patients have normal or only gradually impaired fertility**. They tend to have a **generally milder course of the disease**. Pancreatic function is often preserved, and the destruction of lung tissue proceeds at a slower pace than usual. Many of these patients are compound heterozygous for CFTR mutations (e.g., p.P508del and p.R117H) (Stern et al. 1995).

The **diagnostic work-up** of men with CF does not principally deviate from the standard procedures employed for other forms of obstructive azoospermia (see Fig. 7.1). Measurement of ejaculate volume, pH, and **fructose and α -glucosidase** concentrations (or other markers of seminal vesicle and epididymal function) is of particular importance. The vas deferens and epididymal malformations may be diagnosable by **scrotal palpation**, but this is not universally the case (Wilschanski et al. 1996). The ampullary vas deferens, the ejaculatory ducts and the seminal vesicles can be visualized by **transrectal ultrasound**. If treatment by assisted reproduction is considered, the integrity of spermatogenesis should be checked by **testicular biopsy**. This is not only of value for histology, but at the same time sperm can be extracted and cryopreserved. In fact, this therapeutic aspect is now a major reason for performing testicular biopsy (see below).

15.3.3 Therapy

As cystic fibrosis is an autosomal recessive disorder, it can recur in the offspring of CF patients only when the partner is also affected or heterozygous. While the former should be rare, asymptomatic carriership for CF is common in Caucasian populations. The heterozygote

frequency ranges around 4–5%. For this reason, **CFTR gene mutation analysis** for the **female partners** of male cystic fibrosis patients is essential. If routine testing in the partner does not reveal a mutation and her family history is negative for cystic fibrosis, the residual risk for CF in offspring of the couple is only about 0.5%. The probability of such recurrence can be modified by sequencing the CFTR gene in the woman. On the other hand, the risk may be up to 50% if the partner tests positive for a CFTR mutation. The percentages given here are only applicable to patients of German ancestry. For individuals with another ethnic background the risk calculation must be modified, as both the prevalence and the spectrum of CFTR mutations show strong regional variation (Stuhrmann 1998).

Infertile couples in whom one of the partners is affected with CF should undergo **genetic counselling** prior to initiation of treatment. This also provides an opportunity to discuss the options of **prenatal diagnosis**. If an infertile couple desires treatment despite a significant recurrence risk for CF, this can be accepted as an autonomous decision (Meschede et al. 1997a). There is broad consensus that eugenic considerations should have no place in deciding about the fertility treatment for patients with heritable disorders. This notwithstanding, the physician is obliged to clarify the potentially grave implications for the health for the couple's children. In azoospermic patients with CF, **surgical reconstruction** of the seminal ducts is impossible. **Assisted reproduction** therefore represents the only workable option for these patients to have biological children. With microsurgical techniques, spermatozoa can be retrieved from the epididymis or directly from the testicular parenchyma (**MESA or TESE**, see Sect. 15.2) for subsequent **intracytoplasmic sperm injection (ICSI)**. Conventional IVF is not advisable because of poor pregnancy rates (Xu et al. 2007).

15.4 Congenital Absence of the Vas Deferens

15.4.1 Etiology and Pathogenesis

Congenital bilateral absence of the vas deferens (CBAVD) occurs as an **isolated anomaly** or as **part of the systemic disease CF** (see Sect. 15.3)

(De Braekeleer and Férec 1996; Meschede et al. 1998). Traditionally, these two variants have been treated as separate entities, which, from a clinical point of view, is still appropriate. However, molecular studies have clearly shown that most cases of “isolated” CBAVD represent a **minor variant of cystic fibrosis** and are caused by mutations in the CFTR gene (Dörk et al. 1997; Stuhrmann 1998).

Only a general outline of the complex **molecular pathology** of CBAVD can be given here. CFTR gene mutations are broadly classified into “severe” and “mild.” While the former result in full-blown CF when present in the state of homozygosity, the latter are associated with less pronounced phenotypic abnormalities, such as chronic bronchitis. Apart from these mutations, a polymorphism in intron 8 of the CFTR gene plays an important role in the molecular pathology of CBAVD. The polymorphic sequence consists of either 5, 7 or 9 thymidine residues, also known as the 5T, 7T and 9T alleles, respectively. While the 7T and the 9T alleles are functionally neutral, the 5T allele interferes with the splicing of the CFTR mRNA (Rave-Harel et al. 1997). A high percentage of mRNA lacks exon 9, and it cannot be translated into active CFTR protein. From a functional perspective, the 5T allele is similar to a “mild” mutation.

A valid rule of thumb is that patients with **full-blown CF** carry **two severe CFTR mutations**. In contrast, the most common genotypes of men with **CBAVD** are heterozygosity for a **severe and a mild mutation** or a **severe mutation and a 5T allele**. An intensified molecular screen of the CFTR gene reveals two mutations or one mutation plus a 5T allele in 75% of men with CBAVD, a single mutation or 5T allele in another 10%, and no mutation or 5T allele in 15% (Dörk et al. 1997). Routine laboratory protocols have a somewhat lower yield of positive findings.

As indicated by molecular family studies and painstaking clinical analysis, 10–20% of CBAVD cases are not due to CFTR gene mutations (Rave-Harel et al. 1995; Jarvi et al. 1998; Stuhrmann 1998). Notably, in patients with CBAVD and concomitant **renal anomalies** (unilateral aplasia, ectopy, horseshoe kidney) the risk of CFTR mutations is not increased. This is also true for men with CBAVD and normal ultrasound anatomy of the seminal vesicles and ampullary vas deferens. Obviously, congenital bilateral absence of the vas deferens is an **etiologically heterogenous** condition.

15.4.2 Clinical Picture and Diagnosis

The **anatomical abnormalities** of the genital tract and the ejaculate parameters are similar in CBAVD and cystic fibrosis (see Sect. 15.3.2). Azoospermic men carrying a CFTR mutation have a significantly **lower volume, pH and fructose concentration of the ejaculate** than fertile men or azoospermic patients without a detectable mutation (see Fig. 15.2) (von Eckardstein et al. 2000).

Urinary tract anomalies have an increased prevalence in men with CBAVD and point to the disease

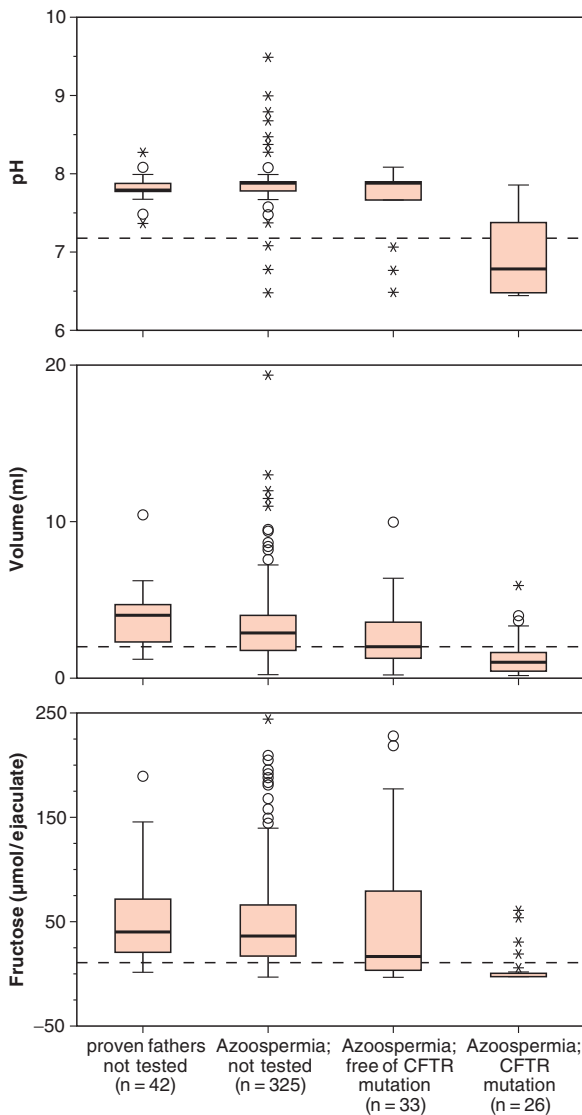

Fig. 15.2 PH (upper panel), volume (middle panel), and fructose concentration (lower panel) of the ejaculate in 42 proven fathers, 325 azoospermic patients, 33 azoospermic patients free of CFTR mutations and 26 patients with known CFTR mutations (von Eckardstein et al. 2000)

variant not associated with CFTR mutations. A **renal ultrasound** should be performed routinely for all men with CBAVD.

Every second patient with CBAVD reports symptoms indicative of **mild upper airway disease**. Recurrent bronchitis and sinusitis is quite typical, as is a history of pneumonia in infancy or childhood. Importantly, a progressive worsening of the bronchopulmonary symptoms does not occur. Occasionally signs and symptoms of maldigestion are reported, which may be due to mild pancreatic dysfunction. Some patients have somewhat elevated liver enzymes. The sweat chloride concentration may exceed the upper normal limit of 60 mmol/l, but this is not the rule (Meschede et al. 1995; Stuhmann 1998; Dohle et al. 1999).

15.4.3 Therapy

As in cystic fibrosis, assisted reproduction for patients with CBAVD should be preceded by **genetic counseling**. CFTR mutation analysis in the female partner is of utmost importance. The risk for CF in children of the couple depends on how many CFTR mutations can be excluded. If a mutation is found in the female partner the risk for cystic fibrosis in any child of the couple may amount to 25–50%. In this event, depending on the type of mutation, the risk of cystic fibrosis and CBAVD must be weighed. The risk figures given here do not universally apply to all couples. Family history and ethnic background may modify them substantially (Stuhmann 1998).

Sperm retrieval through **MESA** or **TESE** and **subsequent ICSI** is now the standard therapeutic approach to male infertility due to CBAVD (see Sects. 15.2. and 15.3). The pregnancy rates are not notably affected by the presence of a CFTR mutation (Schlegel et al. 1995; Silber et al. 1995) (Fig. 15.3).

15.4.4 Unilateral Absence of the Vas Deferens

Congenital unilateral absence of the vas deferens (CUAVD) is compatible with **normal fertility**, and probably many cases never come to clinical attention. The diagnosis may be made accidentally on occasion of a vasectomy. However, unilateral vas deferens aplasia is occasionally found in men with abnormal semen

parameters or even azoospermia. Strictly speaking, this condition should be referred to as unilateral “intra-scrotal” vas deferens aplasia, as the distal parts of the vas are inaccessible to palpation. Many patients with CUAVD have a **contralateral obstruction of the seminal ducts** at a more distal level. Most patients from this particular group (azoospermia, unilateral vas deferens aplasia, more distal contralateral obstruction) carry **mutations of the CFTR gene**. In contrast, such mutations are rare among men with CUAVD who have a patent seminal duct on the other side. Similar to CBAVD, unilateral vas deferens aplasia is sometimes accompanied by **urinary tract anomalies**, most notably unilateral renal agenesis. These patients usually have no increased risk for mutations in the CFTR gene (Mickle et al. 1995).

15.4.5 Bilateral Obstruction of the Ejaculatory Ducts

The short intraprostatic segment of the vas deferens distal to the seminal vesicles is called the ejaculatory duct (see Fig. 3.5). An obstruction at this level of the seminal ducts result in **azoospermia** and a **subnormal volume, pH and fructose content of the ejaculate**. Once CBAVD has been ruled out, this constellation is pathognomonic of ejaculatory duct obstruction. Transrectal ultrasound allows this abnormality to be visualized. The obstruction can be caused by accidental or iatrogenic trauma, infections, tumours, prostatic calcifications, or cysts (Pryor and Hendry 1991; Meacham et al. 1993; Werthman 1999). Patients may present with symptoms similar to acute or chronic prostatitis. Others report pain on ejaculation or hematospermia. The **surgical management** of ejaculatory duct obstruction must be tailored to the individual anatomical situation (Pryor and Hendry 1991; Meacham et al. 1993; Werthman 1999).

In some men with this disease none of the above mentioned etiologies is apparent. This probably represents a constitutional disorder, as substantiated by the finding of CFTR gene mutations in most of these patients (Meschede et al. 1997b). Apparently this form of ejaculatory duct obstruction is another **minor variant of cystic fibrosis**. Genetic diagnosis and counseling follow the procedures as for CBAVD.

An attempt at removing the obstruction by the transurethral route may be undertaken. If this fails (or as the

primary therapeutic approach), surgical sperm retrieval with MESA or TESE with consecutive intracytoplasmic sperm injection is applicable.

15.5 Young Syndrome

15.5.1 Etiology and Pathogenesis

The combined occurrence of **obstructive azoospermia** and **chronic sinobronchial disease** is the hallmark of Young syndrome (Young 1970). Although there may be similarities in presentation, it is clinically and etiologically distinct both from CF and congenital absence of the vas deferens (Handelsman et al. 1984).

Azoospermia in Young syndrome is caused by an obstruction in the middle segment in the epididymis, the lumen being occluded at this level by an **amorphous mass**. Several patients have been reported to have fathered children before the diagnosis was made, and biological parenthood was confirmed by genetic testing. This makes it likely that the occlusion develops over time in a primarily unobstructed epididymis, perhaps through inspissated secretions. Young syndrome is notable for the absence of structural abnormalities of the vas deferens, epididymis, and seminal vesicles. Volume and fructose content of the ejaculate are normal, another feature distinguishing this condition from CF and CBAVD. Testicular palpation, biopsy, and measurement of FSH and the other reproductive hormones usually yield normal results. Quantitative electron microscopy shows that the sperm tails of men with Young syndrome more often than usual lack the central pair of microtubules, the radial spokes or the inner dynein arms. This may result in impaired ciliary and sperm tail function (Wilton et al. 1991).

15.5.2 Clinical Picture and Diagnosis

Patients affected with Young syndrome have a characteristic history of coughing, sputum production, and recurrent sinobronchitis since early infancy. These problems usually improve during adolescence. **Bron-**

chiectases are a frequent finding, but lung involvement does not progress as in CF. Pulmonary function tests may reveal some minor abnormalities. This usually does not have a perceptible effect on general physical fitness. Pancreatic function and sweat chloride levels are normal; again, in contrast to CF.

It is unclear whether Young syndrome has a genetic or an environmental basis. Some affected sibs have been reported, but familial aggregation is the exception rather than the rule. Because of the clinical similarities with CF, the CFTR gene (see Sect. 15.3) has been analyzed in men with Young syndrome. The largest study addressing this issue had a negative result (Le Lannou et al. 1995). However, other authors have occasionally demonstrated CFTR mutations in patients with Young syndrome (Hirsh et al. 1993; Wellesey and Schwarz 1998). Perhaps these were cases of atypical cystic fibrosis or CBAVD or mere coincidence.

As only few countries have reported the Young syndrome and the disease has not been observed in Great Britain since 1955, causative environmental factors have been sought. To date no such exogenous factor could be identified. In view of the unclear pathogenesis and lack of data concerning incidence, it is not certain whether the Young syndrome represents a pathological entity on its own (Arya et al. 2009).

15.5.2 Therapy

Attempts at surgically deobstructing the seminal ducts have met with no or only temporary success. Sperm retrieval from the epididymis or testis by means of **MESA** or **TESE** and subsequent **intracytoplasmic sperm injection** are thus the therapeutic options of choice for patients who wish to have children.

15.6 Disorders of Liquefaction

The human ejaculate normally liquefies within 15 min after ejaculation. Non-liquefaction can cause infertility. Since the liquefaction of the ejaculate is an enzyme-dependent process for which – in addition to other factors – a peptidase and proteinase similar to collagenase are responsible, the addition of **α -amylase** (Vermeiden et al. 1989) or **α -chymotrypsin** (Freischem

et al. 1983) to the ejaculate can lead to an increased pregnancy rate after insemination or IVF.

15.7 Immunological Infertility

15.7.1 Etiology and Pathogenesis

Meiotic and postmeiotic male germ cells express surface antigens that occur neither on somatic cells nor on premeiotic germ cells. During contact with immunocompetent cells, these antigens are recognized as foreign, and an autoimmune reaction can be initiated. Normally this reaction is prevented by the blood-testis-barrier, which is formed by the Sertoli cells, and other immunoregulatory mechanisms (see Chap. 2.5). If the integrity of the blood-testis barrier is destroyed (e.g., by trauma or surgery [e.g., vasectomy]), **anti-sperm antibodies** can be produced. The association of anti-sperm antibodies with anti-nuclear and thyroglobulin-antibodies in serum suggests an “autoimmune disposition” of affected patients (Paschke et al. 1994).

Anti-sperm antibodies can be detected in seminal plasma, either unbound or bound to spermatozoa, and in serum. In the ejaculate, **antibodies of the IgG- and IgA-class** are found almost exclusively, the latter are of particular clinical relevance. Anti-sperm antibodies can lead to infertility, as they impair sperm motility or reduce sperm penetration into the cervical mucus. Furthermore, they can interfere with the acrosome reaction and with sperm binding to the zona pellucida of the oocyte (Bandoh et al. 1992; Francavilla et al. 1997; Harrison et al. 1998; Shibahara et al. 2003; Bohring and Krause 2005; vanWeert et al. 2008).

15.7.2 Clinical Picture

The only clinical correlate for the existence of anti-sperm antibodies is otherwise unexplained **infertility**, which can be associated with normozoospermia or isolated astheno(terato)zoospermia (Fig. 15.3). **Vasectomized men** have a high prevalence of anti-sperm

Fig. 15.3 Cumulative pregnancy rate in patients with anti-sperm antibodies. Circles, proportion of anti-sperm antibody coated sperm 10–49%; squares, 50–90%; triangles, >90%. Left panel, IgG anti-sperm antibodies; right panel, IgA anti-sperm antibodies (Abshagen et al. 1998)

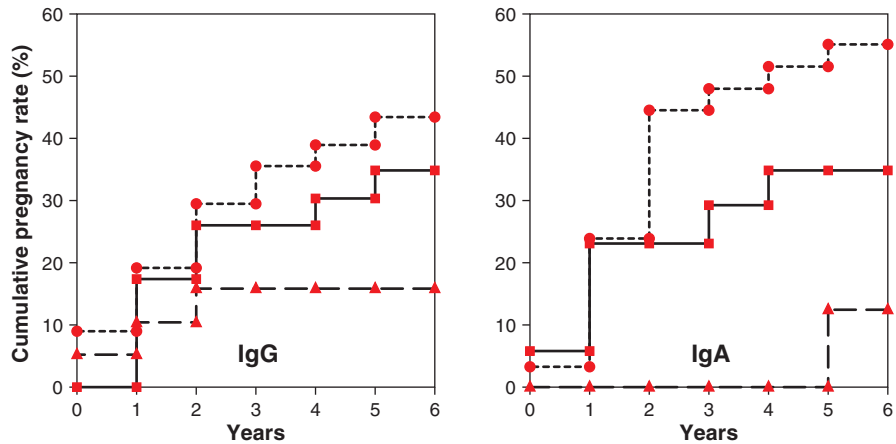

antibodies, which may increase following surgery. Therefore, anti-sperm antibodies in the ejaculate should be determined after microsurgical reanastomosis of the vas if pregnancy fails to occur. According to recent investigations, it is unlikely that previous **infections** (see Sect. 15.1) can also lead to antibody formation (Marconi et al. 2009).

15.7.3 Diagnosis

Sperm agglutinations in the fresh semen sample are suggestive of anti-sperm antibodies and may be caused by antibodies attached to spermatozoa. Their presence is determined by the direct **MAR test** (mixed antiglobulin reaction test) or **immunobead test** (see Sect. 9.3.4.3). Due to high inter-assay variability, the detection of anti-sperm antibodies by the indirect MAR test is of minor clinical relevance (Bohring and Krause 2002).

Detection of anti-sperm antibodies does not always allow the diagnosis of immunological infertility. Immunological infertility is only present when antibodies cause a significant disturbance of sperm function (e.g., mucus penetration, binding to the zona pellucida or to a disturbance of the acrosome reaction) (WHO 2009). Fertility disturbed by immunological factors is probable when over 50% of sperm with IgA or IgG antibodies are demonstrable, with IgA antibodies being more important for fertility (Abshagen et al. 1998; Leushuis et al. 2008; WHO 2009).

Antibodies against sperm in the serum of either the man or the woman have no clinical relevance and, with the exception of special cases, need not be determined

(Kohl et al. 1992; Andreou et al. 1995; Lee et al. 2009). The clinical significance of anti-sperm antibodies in the ejaculate or in the cervical mucus of the partner should be further clarified by sperm-mucus-interaction tests (see Sect. 20.5).

Anti-sperm antibodies can also be detected by **flow cytometry** (Räsänen et al. 1992). This method is particularly suited for the diagnosis of immunological infertility, since IgG- and IgA-antibodies (and possibly other anti-sperm antibodies) can be determined simultaneously on individual spermatozoa. Dead sperm, which bind antibodies non-specifically, can be sorted out by flow cytometry, and thousands of sperm measured within a few seconds (Räsänen et al. 1992). Flow cytometry has the additional advantage that not only the presence of anti-sperm antibodies but also the exact number of the different types of antibodies on the surface of the spermatozoa can be determined (Räsänen et al. 1992). Whether a more exact diagnosis and more highly differentiated classification of immunological infertility will be made possible by flow cytometry and whether the sorting of antibody-bound and unbound sperm will lead to new therapeutic options for the infertile couple, has not yet been demonstrated by randomized clinical studies.

15.7.4 Therapy

Immunosuppressive therapy of immunological infertility with **corticosteroids** resulted in an improvement of the pregnancy rate in only two of four randomized studies (Table 15.3). Lengthy treatment seems to be required for the success of this therapy but this leads to

Table 15.3 Prospective, randomized studies with corticosteroids for treatment of immunological infertility in man

Author	Therapy	Observation time	Number of couples	Pregnancy rate (%)
Haas and Manganiello (1987)	Verum	3 Cycles	20	15 ^{n.s.}
	Placebo		15	7
Hendry et al. (1990)	Verum ^(Cross-over design)	9 Months	33	27 ^{p < 0.05}
	Placebo		21	4
Bals-Pratsch et al. (1992)	Verum ^(Cross-over-design)	3 Cycles	20	0
	Placebo		20	0
Omu et al. (1996)	Verum	12–18 Months	40	20 ^{p < 0.01}
	No therapy		37	5

corticosteroid-induced side-effects including significant decreases of bone mineral density in up to 60% of the patients (Hendry et al. 1990; Sharma et al. 1995; Pearce et al. 1998). It has been shown by flow cytometry that corticosteroid therapy may only be effective on sperm with low numbers of attached anti-sperm antibodies (Räsänen et al. 1996).

Intrauterine insemination or **in vitro fertilization** are of minor efficacy in patients with anti-sperm antibodies (Vazquez-Levin et al. 1997; van Weert et al. 2008), and additional corticosteroid therapy will not improve pregnancy rates (Lahteenmaki et al. 1995; Grigoriou et al. 1996). In patients with significant anti-sperm antibodies, **intracytoplasmic sperm injection** can be regarded as the therapy of choice (Clarke et al. 1997; Esteves et al. 2007).

References

- Abshagen K, Behre HM, Cooper TG, Nieschlag E (1998) Influence of sperm surface antibodies on spontaneous pregnancy rates. *Fertil Steril* 70:355–356
- Agarwal A, Salek H (2002) Role of oxidants in male infertility: Rationale, significance and treatment. *Urol Clin North Am* 29:817–827
- Andreou E, Mahmoud A, Vermeulen L, Schoonjans F, Comhaire F (1995) Comparison of different methods for the investigation of antisperm antibodies on spermatozoa, in seminal plasma and in serum. *Hum Reprod* 10:125–131
- Arya AK, Beer HL, Benton J, Lewis-Jones I, Swift AC (2009) Does Young's syndrome exist? *J Laryngol Otol* 8:1–5 [Epub ahead of print]
- Bals-Pratsch M, Dören M, Karbowski B, Schneider HPG, Nieschlag E (1992) Cyclic corticosteroid immunosuppression is unsuccessful in the treatment of sperm antibody-related male infertility: A controlled study. *Hum Reprod* 7:99–104
- Bandoh R, Yamano S, Kamada M, Daitoh T, Aono T (1992) Effect of sperm-immobilizing antibodies on the acrosome reaction of human spermatozoa. *Fertil Steril* 57:387–392
- Belker AM, Thomas AJ, Fuchs EF (1991) Results of 1,469 microsurgical reversals by vasovasostomy study group. *J Urol* 145:505–511
- Bohring C, Krause W (2002) Interlaboratory variability of the indirect mixed antiglobulin reaction in the assessment of antisperm antibodies. *Fertil Steril* 78:1336–1338
- Bohring C, Krause W (2005) The role of antisperm antibodies during fertilization and for immunological infertility. *Chem Immunol Allergy* 88:15–26
- Centers for Disease Control and Prevention (2006) Sexually transmitted diseases treatment guidelines. *MMWR* 55(No. RR-11):1–94
- Centers for Disease Control and Prevention (2007) Update to CDC's sexually transmitted diseases treatment guidelines, 2006: Fluoroquinolones no longer recommended for treatment of gonococcal infections. *MMWR* 56:332–336
- Clarke GN, Bourne H, Baker HW (1997) Intracytoplasmic sperm injection for treating infertility associated with sperm autoimmunity. *Fertil Steril* 68:112–117
- Comhaire FH, Vermeulen L, Pieters O (1989) Study of the accuracy of physical and biochemical markers in semen to detect infectious dysfunction of the accessory sex glands. *J Androl* 10:50–53
- Comhaire FH, Mahmoud AM, Depuydt CE, Zalata AA, Christophe AB (1999) Mechanisms and effects of male genital tract infection on sperm quality and fertilizing potential: The andrologist's viewpoint. *Hum Reprod Update* 5:393–398
- Cooper TG, Weidner W, Nieschlag E (1990) The influence of inflammation of the human male genital tract on secretion of the seminal markers alpha-glucosidase, glycerophosphocholine, carnitine, fructose and citric acid. *Int J Androl* 13:329–336
- De Braekeleer M, Férec C (1996) Mutations in the cystic fibrosis gene in men with congenital bilateral absence of the vas deferens. *Molec Hum Reprod* 2:669–677.
- De Geyter C, De Geyter M, Behre HM, Schneider HPG, Nieschlag E (1994) Peroxidase-positive round cells and microorganisms in human semen together with antibiotic treatment adversely influence the outcome of in vitro fertilization and embryo transfer. *Int J Androl* 17:127–134
- Diemer T, Huwe P, Michelmann HW, Mayer F, Schiefer HG, Weidner W (2000) E. coli induced alterations of human spermatozoa: an electron microscopy analysis. *Int J Androl* 23:178–186
- Diemer T, Huwe P, Ludwig M, Hauck EW, Weidner W (2003) Urogenital infections and sperm motility. *Andrologia* 35: 283–287

- Dieterle S, Mahony JB, Luinstra KE, Stibbe W (1995) Chlamydial immunoglobulin IgG and IgA antibodies in serum and semen are not associated with the presence of Chlamydia trachomatis DNA or rRNA in semen from male partners of infertile couples. *Hum Reprod* 10:315–319
- Dohle GR, Veeze HJ, Overbeek SE, van den Ouweland AMW, Halley DJJ, Weber RFA, Niermeijer MF (1999) The complex relationship between cystic fibrosis and congenital bilateral absence of the vas deferens: clinical, electrophysiological and genetic data. *Hum Reprod* 14:371–374
- Dörk T, Dworniczak B, Aulehla-Scholz C, Wiczorek D, Böhm I, Mayerova A, Seydewitz HH, Nieschlag E, Meschede D, Horst J, Pander H-J, Sperling H, Ratjen F, Passarge E, Schmidtke J, Stuhmann M (1997) Distinct spectrum of CFTR gene mutations in congenital absence of vas deferens. *Hum Genet* 100:365–377
- Esteves SC, Schneider DT, Verza S Jr. (2007) Influence of anti-sperm antibodies in the semen on intracytoplasmic sperm injection outcome. *Int Braz J Urol* 33:795–802
- Ezeh UI, Moore HD, Cooke ID (1998) A prospective study of multiple needle biopsies versus a single open biopsy for testicular sperm extraction in men with non-obstructive azoospermia. *Hum Reprod* 13:3075–3080
- Francavilla F, Romano R, Santucci R, Marrone V, Properzi G, Ruvolo G (1997) Interference of antisperm antibodies with the induction of the acrosome reaction by zona pellucida (ZP) and its relationship with the inhibition of ZP binding. *Fertil Steril* 67:1128–1133
- Freischem CW, Bordt J, Hanker JP, Schneider HPG, Nieschlag E (1983) Schwangerschaft nach Behandlung des Ejakulates mit α -Chymotrypsin wegen fehlender Liquefizierung. *Geburtsh Frauenheilk* 43:490–491
- Furuya S, Ogura H, Saitoh N, Tsukamoto T, Kumamoto Y, Tanaka Y (1999) Hematospermia: an investigation of the bleeding site and underlying lesions. *Int J Urol* 6:539–547
- Grabe M, Bishop MC, Bjerklund-Johansen TE, Botto H, Cek M, Lobel B, Naber KG, Palou J, Tenke P, Wagenlehner F (2009) Guidelines on urological infections. European Association of Urology (Hrsg.) EAU Urological Guidelines, Arnhem, www.uroweb.org
- Grigoriou O, Konidaris S, Antonaki V, Papadias C, Antoniou G, Gargaropoulos A (1996) Corticosteroid treatment does not improve the results of intrauterine insemination in male subfertility caused by antisperm antibodies. *Eur J Obstet Gynecol Reprod Biol* 65:227–230
- Haas GG, Manganiello P (1987) A double-blind, placebo-controlled study of the use of methylprednisolone in infertile men with sperm-associated immunoglobulins. *Fertil Steril* 47:295–301
- Handelman DJ, Conway AJ, Boylan LM, Turtle JR (1984) Young's syndrome. Obstructive azoospermia and chronic sinopulmonary infections. *N Engl J Med* 310:3–9
- Harrison S, Hull G, Pillai S (1998) Sperm acrosome status and sperm antibodies in infertility. *J Urol* 159:1554–1558
- Hendry WF, Hughes L, Scammell G, Pryor JP, Hargreave TB (1990) Comparison of prednisolone and placebo in subfertile men with antibodies to spermatozoa. *Lancet* 335:85–88
- Hirsh A, Williams C, Williamson B (1993) Young's syndrome and cystic fibrosis mutation $\Delta F508$. *Lancet* 342:118
- Jarvi K, McCallum S, Zielenski J, Durie P, Tullis E, Wilchanski M, Margolis M, Asch M, Ginzburg B, Martin S, Buckspan MB, Tsui L-C (1998) Heterogeneity of reproductive tract abnormalities in men with absence of the vas deferens: Role of cystic fibrosis transmembrane conductance regulator gene mutations. *Fertil Steril* 70: 724–728
- Kaplan E, Shwachman H, Perlmutter AD, Rule A, Khaw K-T, Holsclaw DS (1968) Reproductive failure in males with cystic fibrosis. *N Engl J Med* 279:65–69
- Kerem B, Kerem E (1996) The molecular basis for disease variability in cystic fibrosis. *Eur J Hum Genet* 4:65–73
- Kohl B, Kohl H, Krause W, Deichert U (1992) The clinical significance of antisperm antibodies in infertile couples. *Hum Reprod* 10:1384–1387
- Kolettis PN, Thomas AJ Jr (1997) Vasoepididymostomy for vasectomy reversal: a critical assessment in the era of intracytoplasmic sperm injection *J Urol* 158:467–470
- Krieger JN (1995) New sexually transmitted diseases treatment guidelines. *J Urol* 154:209–213
- Lahteenmaki A, Rasanen M, Hovatta O (1995) Low-dose prednisolone does not improve the outcome of in-vitro fertilization in male immunological infertility. *Hum Reprod* 10:3124–3129
- Lee R, Goldstein M, Ullery BW, Ehrlich J, Soares M, Razzano RA, Herman MP, Callahan MA, Li PS, Schlegel PN, Witkin SS (2009) Value of serum antisperm antibodies in diagnosing obstructive azoospermia. *J Urol* 181:264–269
- Le Lannou D, Jezequel P, Blayau M, Dorval I, Lemoine P, Dabie A, Roussey M, Le Marec B, Legall JY (1995) Obstructive azoospermia with agenesis of vas deferens or with bronchiectasia (Young's syndrome): a genetic approach. *Hum Reprod* 10:338–341
- Leushuis E, van der Steeg JW, Steures P, Repping S, Schöls W, van der Veen F, Mol BW, Hompes PG (2008) Immunoglobulin G antisperm antibodies and prediction of spontaneous pregnancy. *Fertil Steril* 2008 Oct 29 [Epub ahead of print]
- Ludwig M (2008) Diagnosis and therapy of acute prostatitis, epididymitis and orchitis. *Andrologia* 40:76–80
- Ludwig M, Kümmel C, Schroeder-Prinzen I, Ringert RH, Weidner W (1998) Evaluation of seminal plasma parameters in patients with chronic prostatitis of leukocytospermia. *Andrologia* 30(Suppl 1):41–47
- Marconi M, Pilatz A, Wagenlehner F, Diemer T, Weidner W (2009) Are antisperm antibodies really associated with proven chronic inflammatory and infectious disease of the male reproductive tract? *Eur Urol* (in press)
- Mazzoli S, Cai T, Rupealta V, Gavazzi A, Castricchi Pagliai R, Mondaini N, Bartoletti R (2007) Interleukin 8 and anti-Chlamydia trachomatis mucosal IgA as urogenital immunologic markers in patients with C. trachomatis prostatic infections. *Eur Urol* 51:1385–1393
- Meacham RB, Hellerstein DK, Lipshultz LI (1993) Evaluation and treatment of ejaculatory duct obstruction in the infertile male. *Fertil Steril* 59:393–397
- Meschede D, Dworniczak B, Eigel A, Behre HM, Bergmann M, Schulze Everding A, Fischer R, Horst J, Nieschlag E (1995) Mutationsanalyse und genetische Beratung bei Männern mit kongenitaler Aplasie der Samenleiter. *Fertilität* 11:22–26
- Meschede D, Nieschlag E, Horst J (1997a). Assisted reproduction for infertile couples at high genetic risk: An ethical consideration. *Biomedical Ethics* 2:4–6
- Meschede D, Dworniczak B, Behre HM, Kliesch S, Claustres M, Nieschlag E, Horst J (1997b) CFTR gene mutations in

- men with bilateral ejaculatory-duct obstruction and anomalies of the seminal vesicles. *Am J Hum Genet* 61: 1200–1202
- Meschede D, Dworniczak B, Nieschlag E, Horst J (1998) Genetic disorders of the seminal ducts. *Biomed Pharmacother* 52:197–203
- Mickle J, Milunsky A, Amos JA, Oates RD (1995) Congenital unilateral absence of the vas deferens: a heterogeneous disorder with two distinct subpopulations based upon aetiology and mutational status of the cystic fibrosis gene. *Hum Reprod* 10:1728–1735
- Munkelwitz R, Krasnokutsky S, Lie J, Shah SM, Bayshtok J, Khan SA (1997) Current perspectives on hematospermia: A review. *J Androl* 18:6–14
- Nickel JC (1998) Prostatitis: Myths and realities. *Urology* 51:362–366
- Omu AE, al-Qattan F, Abdul Hamada B (1996) Effect of low dose continuous corticosteroid therapy in men with anti-sperm antibodies on spermatozoal quality and conception rate. *Eur J Obstet Gynecol Reprod Biol* 69:129–134
- Paavonen J, Eggert-Kruse W (1999) Chlamydia trachomatis: impact on human reproduction. *Hum Reprod Update* 5: 433–447
- Padian NS, Buvé A, Balkus J, Serwadda D, Cates W Jr. (2008) Biomedical interventions to prevent HIV infection: Evidence, challenges, and way forward. *Lancet* 372:585–599
- Paschke R, Schulze Bertelsbeck D, Tsalimalma K, Nieschlag E (1994) Association of sperm antibodies with other autoantibodies in infertile men. *Am J Reprod Immunol* 32:88–94
- Pearce G, Tabensky DA, Delmas PD, Baker HW, Seeman E (1998) Corticosteroid-induced bone loss in men. *J Clin Endocrinol Metab* 83:801–806
- Penna G, Mondaini N, Amuchastegui S, Innocenti S, Carini M, Giubilei G, Fibbi B, Colli E, Maggi M, Adorini L (2007) Seminal plasma cytokines and chemokines in prostate inflammation: Interleukin 8 as a predictive biomarker in CP/CPPS and benign prostatic hyperplasia. *Eur Urol* 51: 524–533
- Pryor JP, Hendry WF (1991) Ejaculatory duct obstruction in subfertile males: Analysis of 87 patients. *Fertil Steril* 56:725–730
- Purvis K, Christiansen E (1993) Infection in the male reproductive tract. Impact, diagnosis and treatment in relation to male infertility. *Int J Androl* 16:1–13
- Räsänen ML, Hovatta OL, Penttilä IM, Agrawal YP (1992) Detection and quantification of sperm-bound antibodies by flow cytometry of human semen. *J Androl* 13:55–64
- Räsänen M, Lahteenmaki A, Agrawal YP, Saarikoski S, Hovatta O (1996) A placebo-controlled flow cytometric study of the effect of low-dose prednisolone treatment on sperm-bound antibody levels. *Int J Androl* 19:150–154
- Rave-Harel N, Kerem E, Nissim-Rafinia M, Madjar I, Goshen R, Augarten A, Rahat A, Hurwitz A, Darvasi A, Kerem B (1997) The molecular basis of partial penetrance of splicing mutations in cystic fibrosis. *Am J Hum Genet* 60:87–94
- Rave-Harel N, Madjar I, Goshen T, Nissim-Rafinia M, Zaidni A, Rahat A, Chiba O, Kalman YM, Brautbar C, Levison D, Augarten A, Kerem E, Kerem B (1995) CFTR haplotype analysis reveals genetic heterogeneity in the etiology of congenital bilateral aplasia of the vas deferens. *Am J Hum Genet* 56:1359–1366
- Schiefer HG (1998) Microbiology of male urethroadnexitis: diagnostic procedures and criteria for aetiological classification. *Andrologia* 30(Suppl 1):7–13
- Schlegel PN, Goldstein M (1993) Microsurgical vasoepididymostomy: Refinements and results. *J Urol* 150:1165–1168
- Schlegel PN, Chang TSK, Marshall FF (1991) Antibiotics: Potential hazards to male fertility. *Fertil Steril* 55:235–242
- Schlegel PN, Cohen J, Goldstein M., Alikani M, Adler A, Gilbert BR, Palermo GD, Rosenwaks Z (1995) Cystic fibrosis gene mutations do not affect sperm function during in vitro fertilization with micromanipulation for men with bilateral congenital absence of vas deferens. *Fertil Steril* 64:421–426
- Schneede P, Trenke P, Hofstetter AG, Urinary Tract Infection Working Group of the Health Care Office of the European Association of Urology (2003) Sexually transmitted diseases – a synoptic overview for urologists. *Eur Urol* 44:1–7
- Seligson RA, Pollack CV Jr, Section Editors, Talan DA, Moran GJ, Pinner RW (1998) Update on emerging infections: News from the Centers for Disease Control and Prevention. *Ann Emerg Med* 32:748–750
- Sharma KK, Barratt CLR, Pearson MJ, Cooke ID (1995) Oral steroid therapy for subfertile males with antisperm antibodies in the semen: prediction of the responders. *Hum Reprod* 10:103–109
- Shibahara H, Shiraishi Y, Hirano Y, Suzuki T, Takamizawa S, Suzuki M (2003) Diversity of the inhibitory effects on fertilization by anti-sperm antibodies bound to the surface of ejaculated human sperm. *Hum Reprod* 18:1469–1473
- Silber SJ, Nagy Z, Liu J, Tournaye H, Lissens W, Férec C, Liebaers I, Devroey P, van Steirteghem AC (1995) The use of epididymal and testicular spermatozoa for intracytoplasmic sperm injection: the genetic implications for male infertility. *Hum Reprod* 10:2031–2043
- Sperling H (1999) Operative sperm retrieval – the urological aspects. *Urologe A* 38:563–568
- Stern RC (1997) The diagnosis of cystic fibrosis. *N Engl J Med* 336:487–491
- Stern RC, Doershuk CF, Drumm ML (1995) 3849 + 10 kb C → T mutation and disease severity in cystic fibrosis. *Lancet* 346:274–276
- Stuhrmann M (1998) Das klinische Spektrum von Fertilitätsstörungen durch Mutationen im CFTR-Gen. *Reproduktionsmedizin* 14:54–65
- Tournaye H (1999) Surgical sperm recovery for intracytoplasmic sperm injection: Which method is to be preferred? *Hum Reprod* 14(Suppl 1):71–81
- Tracy CR, Steers WD, Costabile RD (2008) Diagnosis and management of epididymitis. *Urol Clin North Am* 35:101–108
- van Weert JM, Repping S, van der Steeg JW, Steures P, van der Veen F, Mol BW (2008) A prediction model for ongoing pregnancy after in vitro fertilization in couples with male subfertility. *J Reprod Med* 53:250–256.
- Vazquez-Levin MH, Notrica JA, Polak de Fried E (1997) Male immunologic infertility: sperm performance on in vitro fertilization. *Fertil Steril* 68:675–681
- Vermeiden JPW, Bernardus RE, ten Brug CS, Statema-Lohmeijer CH, Willemsen-Brugma AM, Schoemaker J (1989) Pregnancy rate is significantly higher in vitro fertilization procedure with spermatozoa isolated from nonliquefying semen in which liquefaction is induced by α -amylase. *Fertil Steril* 51:149–152

- von Eckardstein S, Cooper TG, Rutscha K, Meschede D, Horst J, Nieschlag E (2000) Seminal plasma characteristics as indicators of cystic fibrosis transmembrane conductance regulator (CFTR) gene mutations in men with obstructive azoospermia. *Fertil Steril* 73:1226–1231
- Wang AW, Politch J, Anderson D (1994) Leukocytospermia in male infertility patients in China. *Andrologia* 26:167–172
- Weidner W, Anderson RU (2008) Evaluation of acute and chronic bacterial prostatitis and diagnostic management of chronic prostatitis/chronic pelvic pain syndrome with special reference to infection/inflammation. *Int J Antimicrob Agents* 31:91–95
- Weidner W, Krause W, Ludwig M (1999) Relevance of male accessory gland infection for subsequent fertility with special focus on prostatitis. *Hum Reprod Update* 5:421–432
- Weidner W, Wagenlehner FME, Marconi M, Pilatz A, Pantke KH, Diener T (2008) Acute bacterial prostatitis and chronic prostatitis/chronic pelvic pain syndrome: Andrological implications. *Andrologia* 40:105–112
- Wellesey D, Schwarz M (1998) Cystic fibrosis, Young's syndrome, and normal sweat chloride. *Lancet* 352:38
- Werthman PE (1999) Disorders of ejaculation and ejaculatory duct obstruction. *Infert Reprod Med Clin North Amer* 10:517–537
- WHO Laboratory Manual for the Examination and Processing of Human Semen (2009) 5th edn. World Health Organization, Geneva (in press)
- WHO Manual for the standardized investigation and diagnosis of the infertile couple (1993) Rowe PJ, Comhaire FH, Hargreave TB, Mellows HJ (eds.). Cambridge University Press, Cambridge
- Wilschanski M, Corey M, Durie P, Tullis E, Bain J, Asch M, Ginzburg B, Jarvi K, Backspan M, Hartwick W (1996) Diversity of reproductive tract abnormalities in men with cystic fibrosis. *JAMA* 276:607–608
- Wilton LJ, Teichtahl H, Temple-Smith PD, Johnson JL, Southwick GJ, Burger HG, de Kretser DM (1991) Young's syndrome (obstructive azoospermia and chronic sinobronchial infection): A quantitative study of axonemal ultrastructure and function. *Fertil Steril* 55:144–151
- Wolff H (1995) The biological significance of white blood cells in semen. *Fertil Steril* 63:1143–1157
- Xu WM, Shi QX, Chen WY, Zhou CX, Ni Y, Rowlands DK, Yi Liu G, Zhu H, Ma ZG, Wang XF, Chen ZH, Zhou SC, Dong HS, Zhang XH, Chung YW, Yuan YY, Yang WX, Chan HC (2007) Cystic fibrosis transmembrane conductance regulator is vital to sperm fertilizing capacity and male fertility. *Proc Natl Acad Sci USA* 104:9816–9821
- Young D (1970) Surgical treatment of male infertility. *J Reprod Fertil* 23:541–542
- Zielenski J, Corey M, Rozmahel R, Markiewicz D, Aznarez I, Casals T, Larriba S, Mercier B, Cutting GR, Krebsova A, Macek M, Langfelder-Schwind E, Marshall BC, DeCeli-Germana J, Claustres M, Palacio A, Bal J, Nowakowska A, Ferec C, Estivill X, Durie P, Tsui L-C (1999) Detection of cystic fibrosis modifier locus for meconium ileus on human chromosome 19q13. *Nat Genet* 22:128–129

Contents

16.1	Penile Alterations	279
16.1.1	Hypospadias and Epispadias	279
16.1.2	Phimosis.....	280
16.1.3	Penile Deviation.....	280
16.2	Erectile Dysfunction (ED)	283
16.2.1	Epidemiology.....	283
16.2.2	Functional Anatomy	284
16.2.3	Physiology of Erection	285
16.2.4	Pathophysiology of Erection.....	288
16.2.5	Diagnostic Workup in Erectile Dysfunction	290
16.2.6	Therapy of Erectile Dysfunction	300
16.3	Ejaculation Disorders	316
16.3.1	Anejaculation and Retrograde Ejaculation	317
16.3.2	Premature Ejaculation.....	317
References		318

16.1 Penile Alterations

Congenital or acquired anatomical abnormalities of the penis may interfere with cohabitation and normal deposition of semen. These congenital anatomical variations especially include abnormal position of the urethral meatus (hypospadias/epispadias), but also, penile deviations due to induratio penis plastica (IPP; Peyronie's disease) which represents the most common clinical problem.

16.1.1 Hypospadias and Epispadias

In **hypospadias** the **urethra** does not extend to the glans and the meatus is situated on the **underside of the penis**. Depending on the severity of the abnormality, the meatus can be located at varying distance from the regular position somewhere between the glans and the perineum. In the majority of cases, **glandular, coronal or distal penile cases** are observed, severe **penoscrotal** or even **perineal forms** represent only a relatively small percentage.

In the vast majority of cases **surgical correction** with a distal advancement of the meatus within the first 2 years of life will allow normal sperm deposition. Therefore, patients with a straight penis, distal position and normal caliber of the meatus will experience no impairment of erection or fertility and the **hypospadias represents a cosmetic rather than a functional problem**. Mechanical problems, however, can result in cases with a chordee, resulting in ventral penile deviation during erection. Therefore, apart from optimization of the meatal position, complete resection of an existing chordee as part of the primary operation is essential in surgical correction of hypospadias. If

H. van Ahlen (✉)
Klinik für Urologie und Kinderurologie, Klinikum Osnabrück
GmbH, D-49028 Osnabrück, Germany
e-mail: hermann.vanahlen@klinikum-os.de

surgery fails and the anatomical situation does not allow normal sperm deposition in the vaginal tract, **intrauterine insemination** is the method of choice.

Epispadias is another congenital malformation of the urethra. The urinary meatus is located on the **dorsum of the penis** and often forms a **broad open urethral groove or cleft** in these cases. It is often part of a major genital abnormality and is regularly found in patients with bladder exstrophy. Epispadias will lead to severe dorsal deviation and fixation in the majority of cases which makes intercourse very difficult or even impossible. Cosmetically and functionally satisfactory surgical correction of this malformation requires a high degree of proficiency and postoperative results do not always meet the expectations of the patient.

In **epispadias cohabitation problems due to penile deviation often lead to disturbances of sperm deposition** because of the proximal position of the meatus. Should offspring be desired, insemination is the therapy of choice. Even after successful surgical correction of the mechanical components, disturbances of ejaculation due to anatomical malformation of the bladder neck are possible. In many cases insufficient closure of the bladder neck results in retrograde ejaculation, in other patients anejaculation is observed.

16.1.2 Phimosis

A phimosis is defined as a narrowing of the foreskin of the penis, mostly of congenital origin. Secondary forms usually follow infections, especially in patients with diabetes mellitus, severe balanitis or lichen sclerosus et atrophicus. In **complete phimosis** the foreskin cannot be withdrawn over the glans penis in the flaccid state. In **relative phimosis** this is only the case during erection and **paraphimosis** may occur (inability of the retracted foreskin to be repositioned over the glans with severe edema and strangulation of the glans penis resulting). In individual cases, uncorrected phimosis may impair semen deposition and cause infertility. The therapy of choice is usually plastic or radical circumcision.

16.1.3 Penile Deviation

Penile deviations can be classified according to **congenital and acquired forms**. Insignificant deviations of the

penis from the longitudinal axis are clinically uneventful and can be considered only cosmetic problems. **Surgical therapy is only indicated when cohabitation is mechanically impaired**, regardless of the cause for this penile deviation, or when pain occurs at erection or during intercourse. Clinical findings should be documented with autophotographs taken at three levels to give the urologist a three-dimensional view of the disorder.

16.1.3.1 Congenital Penile Deviation

These disorders represent an entity of their own based on **asymmetric corpora cavernosa** or their bony fixation. Clinically it leads to a **curvature of the penis**. This can be gradual or sharply angled, the deviation of the penis itself can point in any direction. In ventral deviations a relative shortening of the urethra (short urethra) or hypospadias can be the cause. While slight dorsal deviations are functionally without any significance, lateral and ventral deviations can severely **impair capability for cohabitation** and may prevent intercourse. The erectile capacity of these patients is usually not impaired.

Therapeutically, **surgical correction** is the only option in severe cases. The main principle is the relative shortening of the tunica albuginea and the convexity of the curvature. Relative shortening of the corpus cavernosum leads to elimination of the curvature. The most popular surgical method is the **corporal resection** as first described by Nesbit who excised one or more segments of the tunica albuginea and readapted the edges of the resulting defects (Nesbit 1954). Meticulous placement of segments and sutures enable not only lateral and ventral deviations to be corrected, but also slight torsion components. Alternatively, tapering techniques have been described, in which longitudinal parallel sutures with non-resorbable material are placed without previous excision of the tunica albuginea. The major advantage of this procedure is reduced surgical effort with shorter operating times. The main advantage of the original method described by Nesbit, however, is the formation of a very solid scar of the tunica albuginea which is not dependent on the stability of the suture material.

Postoperative results in these congenital deviations are very good; major complications are not observed if care is taken not to damage the structures of the dorsal nerves and vessels.

16.1.3.2 Acquired Penile Deviation

Secondary penile deviations can result from blunt trauma, bleeding into the corpora cavernosa after penile fractures, from urethral strictures and their treatment by urethrotomy or as a result of long-term cavernosal autoinjection therapy in patients with erectile dysfunction. In the majority of cases it is, however, due to **penile induration**, which is usually referred to as **Peyronie's disease**.

Peyronie's Disease (Induratio Penis Plastica, IPP)

The disease is characterized by a localized and often progressive fibrosis at the borderline between cavernosal tissue and the tunica albuginea (Fig. 16.1a). Subsequent plaque formation is histologically preceded by a perivascular inflammatory reaction of which the etiology is still

not completely clear. Along with traumatic causes, genetic, immunological, infectious and also toxic causes are discussed. Plaques probably result from repeated coital microtrauma leading to an overreaction during wound healing; stretching of the tunica albuginea, in turn causes scar formation (Hauck et al. 2006).

Clinically the disease usually occurs in the fifth decade and can affect 0.5–3% of the male population, but has also been described in young men in their 20s. In its initial phase it is characterized by **pain during erection**, but also in a resting state. With spontaneous regression of the acute inflammatory reaction, pain usually subsides within approximately 3 months. Secondary to the consolidation of the inflammatory reaction, a progressive fibrosis with deposition of collagenous tissue is observed. Clinically this leads to palpable plaque formation. In approximately 15% of patients a simultaneous Dupuytren contracture of the **palmar aponeurosis** is seen. In up to 30% of cases ectopic calcification of plaques ensues with true bone formation of the penis (Fig. 16.1b). The majority of the plaques are situated at the dorsal aspect of the penis. They can, however, also occur on the lateral or relatively seldom on the ventral side. Depending on the extent and localisation of these plaques the insufficient elasticity of the tunica albuginea in the area of plaque formation will lead to **penile deviation**, mostly dorsal, due to scars and hence shrinkage. This can attain varying degrees of severity and may lead to grotesque deviations which make sexual intercourse impossible. Involvement of the corpora cavernosa can lead to bandlike stricture and deformation of the penile shaft, causing insufficient engorgement of the distal corpora cavernosa with reduced rigidity or formation of a pseudojoint and consequent inability to perform intercourse.

The **spontaneous course** of the disease can be highly **variable** and often unpredictable. While initial pain at erection usually subsides without treatment after a certain period of time, there are no reliable anamnestic or clinical findings that allow the kind and extent of a later plaque formation or penile deviation to be predicted. The period up to final consolidation with a fixed clinical state of deviation usually extends from 12 to 18 months. In most cases the final extent of the deviation and the resulting subjective impairment of the patient or the partner will determine further therapeutic strategy. In several cases spontaneous resolution of the plaques with straightening of the penis has been described even without any therapy at all.

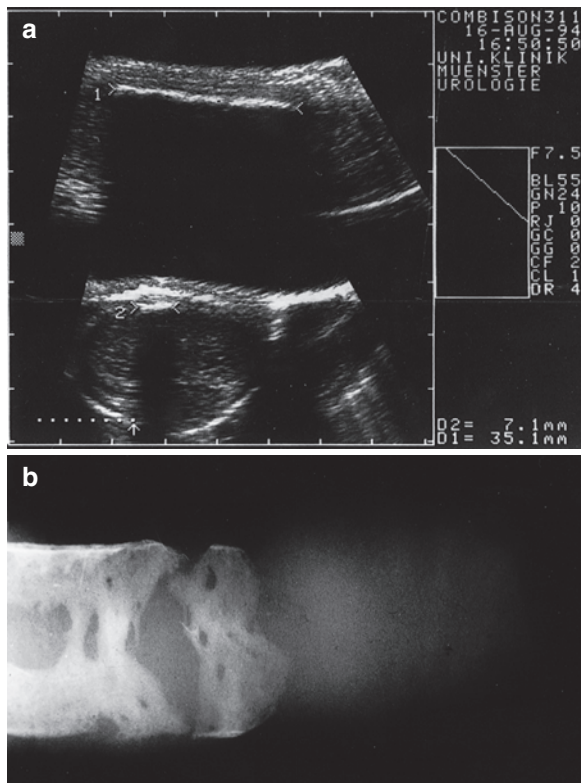

Fig. 16.1 (Alt 10.1) Typical findings in Peyronie's disease. (a) Sonography of the penis with extensive dorsal plaque formation (> <) (upper half longitudinal, lower half transverse section). (b) Soft tissue X-Ray of the penis in the mammography technique with extensive ectopic calcifications

Diagnosis is usually based on the finding of a palpable plaque during clinical examination. These plaques or progressive penile deviation usually prompt the patient to consult his physician. Additional investigations are usually not necessary for diagnosis, although they serve to objectify initial observations at a later point. Size may be determined by ultrasound, in cases with suspected calcifications an additional X-ray using mammography technique can be performed (Fig. 16.1a, b).

16.1.3.3 Therapy of Penile Deviations and IPP

Conservative Therapy of IPP

Depending on clinical presentation therapy may consist of symptomatic antiphlogistic measures to relieve pain, oral or local drug therapy, radiation therapy or various surgical solutions. In cases with minor pain and without significant deviation a purely symptomatic, conservative therapy is justified since in up to 30–50% of the patients spontaneous remission with straightening of the penis can be observed eventually (Table 16.1). Of the various drugs tried, only potassium para-aminobenzoate (Potaba®) seems to have a significant influence on the clinical progression of the disease, as recent studies have shown (Weidner et al. 2005). Intralesional injections of orgotein advocated earlier have been abandoned because

of lethal allergic reactions. Intralesional injection therapy with Ca-antagonists or steroids will not have any verifiable effects on the plaque itself. Radiation therapy is especially successful in management of pain of early lesions; significant changes of the plaques or the deviation are not to be expected and severe fibrosis of the corpora cavernosa has been documented. In controlled studies extracorporal shock wave lithotripsy has shown a significant effect on pain reduction but has failed to reduce plaques or correct penile deviations (Hauck et al. 2006). In the case of congenital penile deviations conservative therapy is without effect.

Surgical Therapy of Penis Deviations

If, independent of etiology, penile deviation reaches an angle of more than 30°, thus either permitting intercourse only under severe pain, or not at all, surgical procedures are indicated. Generally the disease should come to a clinical standstill at least 6 months before surgery with no increase of penile deviation during this time. Otherwise the risk of postoperative recurrences with newly developing deviations is markedly increased. For most patients whose erectile capacity is not markedly impaired prior to surgery, the above-mentioned correction with the Nesbit-technique or with other shortening procedures, e.g., according to Schroeder-Essed

Table 16.1 Medicinal therapy of IPP

Substance	Effectiveness	Studies	Patient Nos.	Author
Potassium-paraaminobenzoate (Potaba®)	Yes	Placebo controlled, double blind	103	Weidner et al. (2005)
Acetyl-L-carnitine	Yes (pain, deviation, progress)	Controlled (Tamoxifen), randomized	48	Biagiotti and Cavallini (2001)
Propoleum	Yes (pain, deviation) (only available in Cuba)	Placebo controlled, double blind	34	Lemourt et al. (1998)
Colchicine	No	Placebo controlled, randomized, double blind	84	Safarinejad (2004)
Propionyl-L-Carnitine	No	Placebo controlled, randomized, double blind	236	Safarinejad et al. (2007)
Tamoxifen	No	Placebo controlled, randomized, double blind	25	Teloken et al. (1999)
Vitamin E	No	Placebo controlled, randomized, double blind	236	Safarinejad et al. (2007)

are the therapy of choice. Postoperative results are good, in most cases surgical shortening of the penis is without any clinical significance and deterioration of erectile function is not to be expected (Kelami 1985). However, it is important to inform the patient about the (presurgical) shortening of the penis which is characteristic of Peyronie's disease and to tell him that per surgically corrected 10°, ca. 1 mm length will be sacrificed. Even if this often has no functional consequence, the patient's high expectations and possibly ensuing dissatisfaction can be a problem. Whereas in the Nesbit technique the tunica is excised in an ellipsoid manner and then sutured, the Schroeder-Essed technique features only shortening by plication without excision of tissue using non-resorbable suture material. This procedure is accompanied by a somewhat higher relapse rate. In principle the deviation should be corrected by denuding the penis shaft with the sleeve technique combined with a sparing or radical circumcision for better exposition and avoidance of postoperative foreskin necrosis (Hauck et al. 2006). In dorsal deviations the urethra must be carefully prepared; in ventral or lateral deviations the nerve-vessel bundle must be carefully protected. In cases with extensive plaques due to Peyronie's disease excision of these plaques may appear desirable. Plaque reduction and venous patching techniques described earlier have not proved effective (Kim and McVary 1995a). The main problem with all plaque resections which are performed in combination with various patch techniques to cover up the defect is the markedly increased incidence of postoperative erectile dysfunction.

Today mostly small incision techniques are used because they are less traumatizing: after removal of the dorsal nerve-vessel bundle a single or double H-form incision is made (without damaging the corpora cavernosa) and the defects resulting from stretching are covered. Various materials serve as grafts, such as tissue (V. saphena magna, bovine pericardium, skin) or also material replacing tissue. Postoperative healing time requires up to 6 months; functional and cosmetic results are acceptable in the hands of experienced surgeons, whereby the preoperative situation and counseling of the patient concerning postoperative sequela (alterations of glans sensitivity, limited erectile function, surgical complications) and good postoperative care are of decisive importance for the patient (Hauck et al. 2006; Bella et al. 2007).

In cases with preoperatively impaired erectile capacity these surgical techniques will often lead to a

straightening of the penis but erectile dysfunction will also increase. Apart from psychological factors and arterial problems, especially disturbances of the cavernosal occlusive mechanism or scarring of the corpora cavernosa can be involved in the previously existing ED. Thorough preoperative diagnosis should provide information on the causes underlying erectile dysfunction. Organic findings are usually so severe that primary implantation of a prosthesis, in selected cases, combined with plaque incision, appears indicated. Only when the patient refuses such invasive measures but appears inclined to accept later injection therapy may deviation correction be warranted in very selected cases.

16.2 Erectile Dysfunction (ED)

Until recently disturbances of penile erection were often regarded as psychogenic or of age-dependent physiological origin. New diagnostic procedures evolving in the 1980s and 1990s revolutionized the understanding of physiology and pathophysiology of human penile erection and laid the groundwork for reducing the taboos held by both physicians and patients. Contrary to earlier opinions, nowadays pathogenetically important organic disturbances are found in up to 50–80% of patients. One should, however, be aware of the fact that an accompanying psychological component is present in any patient with erectile dysfunction. With increasing knowledge about possible disturbances of penile erection, new organically oriented therapeutic options have been developed which have revolutionized the treatment of ED but also the classification of the problem within a much more comprehensive medical context. The following sections deal with physiology, diagnostic workup and therapy of erectile dysfunction (ED).

16.2.1 Epidemiology

According to large epidemiological studies the mean incidence of erectile disturbances requiring therapy is about 20% in Germany and also internationally. It is strongly age-dependent, rising to over 70% in patients over 70 years. In the group of 40-year-old men 5% complain about complete erectile dysfunction, and

about 17% about moderate dysfunction (Feldman et al. 1994; Braun et al. 2000).

In recent years new findings on the pathogenesis and the role of endothelial dysfunction have placed ED in a completely new context. Thus large epidemiological studies show a marked coincidence of ED with various other diseases of the cardiovascular system which are associated with endothelial dysfunction. Twenty to 70% of all patients with **diabetes mellitus, hypertension and disturbances of lipid metabolism** develop clinically relevant erectile problems in the course of these diseases. A large epidemiological study with ca. 28,000 respondents and over 4,000 patients found that the prevalence of these accompanying diseases in patients with manifest ED were twice as high as in an age-matched comparable population and that about 65% of all ED patients had at least one of these risk factors (Rosen et al. 2004). Thus in some of these patients ED functions as an early indicator of various diseases and often serves as a clinical predictor of serious vascular events. Depending on the patient population, up to 25% of all ED patients revealed previously diagnosed diabetes, a further 17% showed previously undiagnosed manifest diabetes or disturbed glucose tolerance with increased fasting glucose levels at an early stage and initial manifestation of the disease (Sairam et al. 2001). In 162 patients with **chronic coronary heart disease and/ or myocardial infarction**, coronary angiography revealed a clear correlation between the incidence of ED and the number of affected coronary vessels (Montorsi et al. 2005). Two thirds of patients with multiple vessel disease suffered from ED which preceded cardiological symptoms by a mean of 25 months in over 70% of cases.

Because of the increasing amount of data accumulating in recent years about associations of ED and cardiovascular disease, the second Princeton Consensus Conference recommended focusing on patient history and clinical exploration of possible risk factors (Jackson et al. 2006b). As a minimal demand, during initial presentation of an ED patient the typical accompanying diseases of diabetes mellitus, hypertension and lipid metabolism must be excluded (Kostis et al. 2005).

16.2.2 Functional Anatomy

Arterial inflow of the penis is provided via the internal pudendal artery. Significant variations up to unilateral perfusion without any disturbances of erectile function have been described. A pelvic floor branch leaves the internal pudendal artery before the penile artery divides into the dorsal penile artery, the deep penile artery and the urethral artery (Fig. 16.2a).

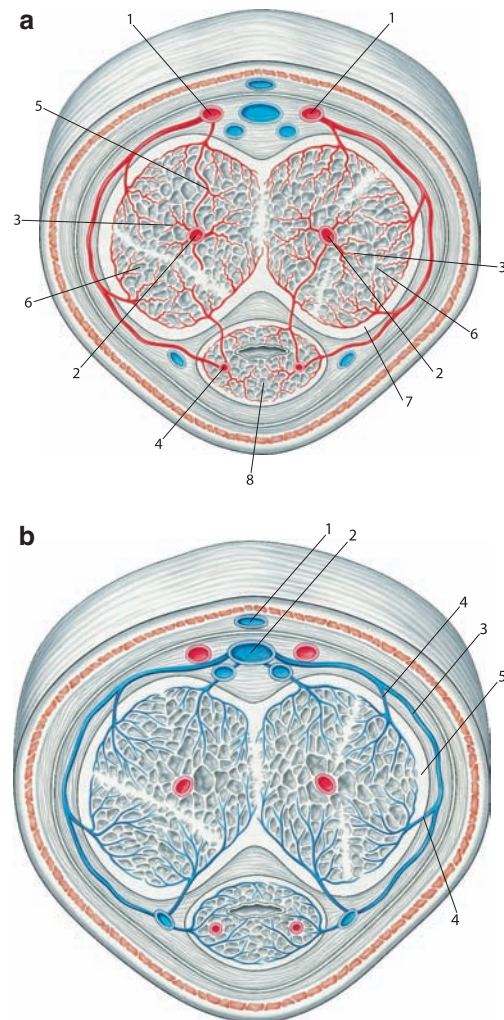

Fig. 16.2 Cross-section of the penis. **(a)** Arterial supply: 1: A. dorsalis penis; 2: A. profunda penis; 3: Helicine arteries; 4: A. urethralis; 5: Anastomoses between A. dorsalis and A. profunda penis; 6: Sinusoids of the corpora cavernosa; 7: Tunica albuginea; 8: Corpus spongiosum. **(b)** Venous supply: 1: V. dorsalis superficialis; 2: V. dorsalis profunda; 3: V. circumflexa; 4: V. emissaria

The dorsal artery runs alongside the deep dorsal vein and the dorsal nerve between the deep penile fascia (Buck) and the tunica albuginea and perfuses the skin and the glans penis. In many patients there are anastomoses between these superficial vessels and the intracavernosal vasculature as well as the corpus spongiosum.

From the deep penile artery (arteria profunda penis) helix arteries branch off that are contracted in the flaccid state of the penis and show a three-dimensional corkscrew orientation. It is a characteristic feature of the vasculature of the human corpus cavernosum that these vessels drain directly into wide, communicating sinusoids. Between these helix arteries and the cavernosal veins there is only a very short arterial capillary bed. This functions as a kind of arterial venous fistula, providing only minimal nutritive perfusion of the corpora cavernosa (CC) in the flaccid, non-erect penis with contracted arterial vessels.

The trabeculae of the **cavernous sinusoids** consist of smooth muscle cells covered with endothelium on the interior of the sinusoidal space. The intracavernous arteria helicinae and the draining veins run into these trabeculae. In contrast to the arteries, the **veins** (Fig. 16.2b) do not have their own musculature and their diameter is largely dependent on the tension of the trabeculae. These draining veins and intermedial veins join in a subtunical plexus from which the emissary veins arise. These emerge from the corpora cavernosa dorsally and laterally and join directly or via the venae circumflexae with the deep dorsal vein. Proximally they join the cavernous and crural veins, from which the latter form the internal pudendal vein. The superficial dorsal vein, similar to the dorsal artery, only drains the outer skin layers and the glans penis and sometimes forms a joint with the vena saphena magna.

The stability of the corpora cavernosa is guaranteed by the tunica albuginea and multiple septa that produce a fixed three-dimensional structure. Therefore, changes in the rigor of the cavernosal muscle cells will influence the whole system comprised of tunica albuginea, trabeculae and draining veins, and not only separate components. The septum penis is incomplete in humans so that clinically the corpora cavernosa represent a functional unit (Fig. 16.2).

The **innervation** of the penis is twofold and involves the autonomic and the somatosensory nerve system. Parasympathetic fibers arise from the sacral erection centre (S2–S4). Sympathetic fibers have their origin in the thoracolumbal area (Th12–L2) and run along the preaortal plexus into the plexus hypogastricus.

Preganglionic parasympathetic fibers from the sacral erection centre unite with sympathetic fibers from the plexus hypogastricus in the pelvic plexus and form the nervi cavernosi, which represent the autonomic innervation of the corpora cavernosa. These nervi cavernosi follow the pudendal arteries and enter the corpora immediately after running just laterocaudal to the apex of the prostate. This very exposed anatomical pathway explains the possible damage to penile innervation and arterial perfusion in patients with severe proximal urethral trauma or radical pelvic surgery.

Somatosensory innervation is represented by the dorsal penile nerve, a terminal branch of the pudendal nerve. Sensory afferent information reaches the dorsal roots of the sacral segments S2–S4, from there being conducted via the anterolateral spinothalamic pathways to the integrative medial preoptic area (MPOA). The pudendal nerve, however, also has efferent motoric fibers leading to the musculature of the pelvic floor, innervating the bulbocavernosal and the ischiocavernosal muscles. During erection these compress the corpora cavernosa against the bony structure of the pelvis and thereby increase intracavernosal pressure.

16.2.3 Physiology of Erection

16.2.3.1 Hemodynamics

Three **hemodynamic factors** are essential for erection (Fig. 16.3a, b):

- Intracavernosal **reduction of resistance** due to relaxation of the cavernosal muscle cells
- **Increase of arterial inflow** by dilatation of the arterial vessels
- **Restriction of venous outflow** by compression of intracavernosal and subtunical venous plexus

Reduction of the tone of all muscular structures of the corpus cavernosum accompanied by relaxation of the sinusoids results in increased arterial inflow. Clinically this correlates with increasing tumescence and elongation of the penis (Fig. 16.3a). In the venous system uninhibited drainage is reduced in the flaccid organ state by a marked decrease of the venous diameter.

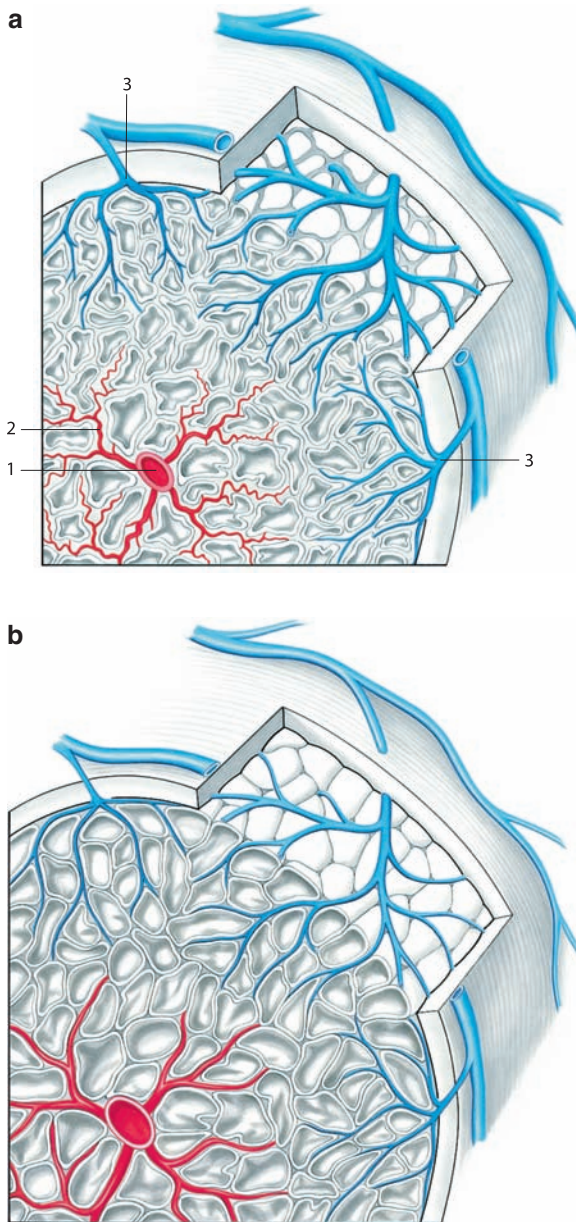

Fig. 16.3 Physiology of erection. (a) Contracted A. profunda penis (1), helicene arteries (2), and sinusoids in the flaccid state, unrestricted venous outflow of cavernosal blood via emissary veins (3). (b) During tumescence marked dilatation of the A. profunda penis and the sinusoids, elongation of the helicene arteries, compression of the intersinusoidal venules and mechanical occlusion of the subtunical emissary veins

By the maximal extension of the cavernosal sinoids the venules in the trabeculae and the emissary veins passing through the tunica albuginea are increasingly compressed. These changes finally lead to complete penile erection (Fig. 16.3b).

Table 16.2 The 5 phases of erection

I. Latency phase	Penile shaft elongation, constant intracavernosal pressure due to a decrease of the cavernosal resistance
II. Tumescence phase	Increase of tumescence and rigidity with increase of arterial inflow, cavernosal volume and intracorporal pressure
III. Erection phase	Completely elongated, pulsating penile shaft, stabilization of intracavernosal pressure at a plateau, 10–20 mmHg below systolic blood pressure; constant penile volume due to a reduction of the arterial inflow to baseline values
IV. Rigidity phase	Full tumescence and rigidity with intracorporal pressure that can clearly exceed systolic blood pressure due to the bulbo-cavernosus reflex; only minimal arterial inflow but complete venous occlusion
V. Detumescence phase	Loss of rigidity, decrease of penile volume and intracavernosal pressure with in- and outflow from the corpora cavernosa reaching baseline values

Hemodynamically **five erectile phases** can be distinguished (Table 16.2). The **latency phase** is characterized by a drop in intracavernosal pressure following stimulation of the nervi cavernosi. This is accompanied by an increase in arterial perfusion. Due to the elastic-fibromuscular structure of the corpora cavernosa this leads to elongation of the penis without any changes in intracavernosal pressure. During the **tumescence phase** increasing compression of the venous outflow slowly develops. When intracavernosal pressure is just below systolic blood pressure a plateau is established which is hemodynamically characterized by a steady state of arterial inflow and the only minimal venous outflow (**erection phase**). Maximal rigidity will be achieved by contraction of the pelvic floor muscles, allowing pressure inside the corpora cavernosa far in excess of systolic pressure (**rigidity phase**). When nervous impulses terminate, rigidity and tumescence will decrease (**detumescence phase**).

16.2.3.2 Neurophysiology

Clinically **three different types of erection** can be differentiated: reflexogenic, psychogenic and nocturnal

erection. **Reflexogenic** erections are induced by direct stimulation of the genital area and are transmitted by the dorsal penile nerve. Intraspinally there is a transfer to efferent parasympathetic fibres (nervi erigentes). After transformation in the pelvic plexus erection is induced via the cavernosal nerves. The somatic portion of the pudendal nerve induces contraction of the pelvic floor musculature with adequate rigidity. These pathophysiological circumstances explain the existence of normal reflexogenic erections in cases of supranuclear lesions of the spinal cord, while central perception can be maintained or abolished to various extents in these patients.

Psychogenic erections occur when neurotransmitters, especially dopamine and nitric oxide (NO), are released following erotic stimuli in the central sexual centers. The signals are transmitted to the corpora cavernosa via activation of the parasympathetic nervous system and a signal transfer in the sacral erectile center, where NO and the vasoactive intestinal polypeptide (VIP) act as the main transmitters. Mainly inhibitory effects stem from the thoracolumbar erection center (TH 11/12–L 2/3). After signal transformation in the plexus hypogastricus the sympathetic fibers, along with the parasympathetic fibers in the Nn. cavernosi, reach the penis. Here the sympathetic fibers reach the α -1 receptors of the corpora cavernosa muscle cells or α -2 receptors of the penile arteries. These have an inhibitory effect on smooth muscles of the erectile tissue of the penis. This is supported by clinical experience that penile erection may be absent in the presence of high sympathetic tone.

Physiologically the corpora cavernosa are more under the influence of erection-inhibiting factors than erection-facilitating factors. This explains why the penis remains in a contracted i.e., flaccid state when at rest.

Nocturnal erections result from the day/night reversal and the parasympathetic tone which predominates during the night, leading to intermittent automatic erections.

16.2.3.3 Local Control of Erection

Parasympathetic erection-facilitating nerve endings are largely of non-adrenergic, non-cholinergic nature. NO (nitric oxide) is the neurotransmitter most important for penile erection. On the one hand NO is released

from the NANC nerve ends of the Nn. cavernosi, on the other hand it is released from all sinusoids and the penile vessels lining the endothelial cells. Local synthesis follows under the influence of testosterone-dependent endothelial or neuronal nitric oxide synthase (eNOS or nNOS), L-arginine serves as substrate. Whereas eNOS is down-regulated, especially in hypoxia, nNOS is influenced primarily by the various metabolic factors (diabetes, elevated LDL, hypertension, metabolic syndrome).

Upon sexual stimulation neuronal NO is initially released. In turn NO activates the membrane-bound guanylyl cyclase, causing cyclization of 3'5'cyclic-guanosine monophosphate (cGMP) from GTP. This second messenger is the most important transmitter, leading to activation of cGMP-dependent protein kinase G (PKG). Under the influence of PKG, free intracellular calcium is taken up by the endoplasmic reticulum, causing reduced Ca flux and increased potassium flux from the cell, ultimately leading to depolarization thence to smooth muscle relaxation with consecutive increased blood inflow (Burnett 2004). Supported by mechanical alterations and stretching of the musculature, further activation of endothelial NOS is accompanied by release of endothelial NO, which contributes to the maintenance of smooth muscle relaxation and thus erection. The formation of cAMP is analogous to that of cGMP when membrane-bound adenylyl cyclase is activated by VIP cAMP. Both second messengers are subject to physiological metabolism by various phosphate diesterases, of which type 3 and type 5 are clinically relevant. These lead to a reduction of cGMP to 5'GMP or cAMP to 5'AMP, which are biologically inactive.

Sympathetic innervation follows largely via adrenergic α -1 and α -2 receptors, causing an increase of intercellular calcium levels and the contraction of muscle cells.

In addition, various local substances are synthesized in the penile erectile tissue which have largely inhibitory influence, e.g., prostanoids, endothelin and angiotensin. In addition, local control of erection is more strongly influenced by testosterone than was previously believed. Thus a protracted testosterone deficiency causes a reduction of the NO-synthetase-containing nerve fibers, downregulation of nNOS and eNOS as well as to a continuous reduction in the number of smooth muscle cells by apoptosis.

16.2.4 Pathophysiology of Erection

Separately or in variable combinations psychogenic, vascular, neurogenic, hormonal or direct myogenic disturbances can cause **erectile dysfunction**. The development of new diagnostic procedures has revolutionized earlier opinions that in the vast majority of cases erectile dysfunction is of psychogenic origin. These new diagnostic procedures allow objectivity and quantitation of the decisive functions that are responsible for induction or maintenance of erection. However, the development of these diagnostic procedures led to the assumption that up to 80% of patients suffered from purely organic erectile dysfunctions, leaving psychogenic factors, which affect any patient with longstanding erectile dysfunction, to go unobserved.

16.2.4.1 Psychogenic Erectile Dysfunction

Psychogenic stimuli such as sensory or mental stimuli can be very strong promoters of erection. Contrary reactions, especially fear or earlier traumatic experiences, can, on the other hand, impair erectile capability significantly and may lead to complete erectile dysfunction. In primary disturbances the reasons are often found in the social situation and upbringing. Secondary disturbances usually occur acutely and may be dependent on specific situations or partners. They are often accompanied by other characteristic sexual disturbances. Prognostically and therapeutically it is important to evaluate whether the disorder is characterized mainly by a reduction of libido or whether an initial erection cannot be maintained owing to fear of failure or other problems. Disturbances of libido may be derived from organic causes; in psychogenic impotence, however, they are usually a sign of partner problems and therefore have a relatively poor prognosis.

16.2.4.2 Vasculogenic Erectile Dysfunction

To induce an erection sufficient arterial influx into the cavernosal arteries and a competent cavernosal occlusion mechanism are mandatory. Therefore in general alterations with **arterial inflow can be differentiated from those with venous outflow disturbances**.

Fifty to 80% of all organically caused erectile dysfunction is due to **arterial insufficiency of the penile vessels**.

As discussed in the section on epidemiology (see Sect. 16.2.1), the majority of patients have one or several of the well-known risk factors of arteriosclerosis such as severe nicotine abuse, arterial hypertension, diabetes mellitus or disturbances of lipid metabolism. Along with arteriosclerotic alterations, perineal trauma with injuries of the pudendal vessels or iatrogenic causes (vascular or radical pelvic surgery) have to be taken into account. Clinically purely arterial disturbances are characterized by diminished and delayed induction of erection after application of vasoactive substances. Symptoms usually develop over time and are generally not partner- or situation-dependent.

Disturbances of the cavernosal occlusion mechanism can be due to various reasons:

- Congenital disturbances of venous drainage (ectopic veins)
- Morphological alterations of the smooth muscle cells of the corpora cavernosa with reduced ability for relaxation due to different pathological circumstances
- Functional changes of the smooth muscle cells of the corpora cavernosa (disturbances of neurotransmitters or receptors)
- Morphological alterations of the tunica albuginea (age, Peyronie's disease, penile fracture)
- Pathological shunts between corpus cavernosum and glans penis/corpus spongiosum

Ectopic veins are one of the very rare causes of primary erectile dysfunction. They can be corrected by a very simple surgical procedure by resecting the ectopic vein. Secondary venous and cavernosal erectile dysfunctions are usually due to alterations of the cavernosal tissue itself or the tunica albuginea. In most cases degenerative changes of these muscle cells with a replacement by connective tissue and fibroblasts and consecutive loss of elasticity are responsible for the incompetence of the cavernosal occlusion mechanism and the resultant increased venous drainage of the corpora cavernosa. Such changes are often observed in the presence of

arterial insufficiency and show the same pathophysiological mechanisms well known from other organ systems. Extensive fibrosis can also be observed after priapisms or trauma. Impairment of the perfusion of the small intracavernosal vessels (small vessel disease) and simultaneous presence of morphological changes of the tunica albuginea lead to insufficient activation of the cavernosal occlusion mechanism by reduced filling of the corpora, which will in turn induce relative venous or cavernosal insufficiency.

The possibilities of functional impairment of the smooth muscle cells of the corpora cavernosa caused by reduced release or diminished contents of neurotransmitters, a competitive receptor blockage or quantitative disturbances of receptor status also have to be taken into account. In patients with diabetes mellitus a significantly reduced number of neurotransmitters could be demonstrated, as well as impaired relaxation capacity dependent on the endothelium and electrical stimuli. Competitive receptor blockage can also be caused by medication. Such competitive blockage can also be observed in patients with psychogenic erectile dysfunction when adrenergic tone prevents adequate relaxation of the smooth muscle cells of the corpora cavernosa. Morphological changes of the tunica albuginea (e.g., IPP) are much more frequent than functional or quantitative changes of intracavernosal receptors.

Clinically patients present with an insufficient or extremely short erection with a rapid loss of primary rigidity, in advanced cases with complete erectile dysfunction. Many of these cases will be diagnosed as having a combination of reduced arterial perfusion and cavernosal insufficiency.

16.2.4.3 Neurogenic Erectile Dysfunction

Neurological disturbances on various levels of stimulation or its transmission can lead to erectile problems. Spinal lesions are among the most common causes. In approximately 95% of patients with supranuclear lesions reflexogenic erections are maintained, but only 25% of the patients with sacral lesions report normal psychogenic erections. This proves the dominant role of the sacral erection center compared to the thoracolumbal center.

Systemic diseases such as Morbus Parkinson, encephalitis disseminata, inflammatory or tumorous lesions display highly variable findings. In these cases erectile dysfunction is often a symptom of the imbalance between excitatory and inhibitory influences and clinical presentation can be very heterogenous. Peripheral neuropathies are usually observed in metabolic disorders such as **diabetes mellitus** and severe alcohol abuse. In diabetes mellitus **erectile dysfunction may be the primary manifestation**. Like vascular changes, neuropathy usually occurs with increasing duration of the disease and is only partly dependent on the quality of medical therapy. Reactive psychogenic disturbances due to major changes in lifestyle are a problem that is probably often overlooked.

16.2.4.4 Endocrine Erectile Dysfunction

The role of androgens in the regulation of erection is not clearly defined. Low serum testosterone levels are often associated with disturbances of libido and other functional sexual problems, reduced sperm production and reduction of nocturnal erections. However, complete rigid erections occur in infants and castrates (Greenstein et al. 1995). In hypogonadism, testosterone replacement will lead to a marked increase in nocturnal penile erections and libido; conversely, in patients with normal serum levels, substitution will not be beneficial compared to placebo (see Chap. 21). Severe androgen deficiency is by definition correlated with low testosterone and only few cases of hypogonadism will be primarily diagnosed by the symptom of erectile dysfunction, despite the fact that androgen deficiency causes a decrease of NO-containing nerve fibers and apoptosis of smooth muscles, and consequently induces compromised signal transmission in the corpora cavernosa.

Altogether, endocrine factors are an essential etiological factor in erectile dysfunction, accounting for 2–5% of patients.

16.2.4.5 Drug-Induced Erectile Dysfunction

A wide variety of different groups of medication can play a significant role in the pathogenesis of erectile dysfunction. In most cases these drugs act on the **central nervous system**, influencing the

hypothalamus-pituitary-gonadal axis, or the autonomic nervous system. Antihypertensive drugs are of particular importance, especially the group of non-cardioselective beta blockers, as well as thiazide-diuretics which are regularly blamed for increased prevalence of ED. Especially beta blockers often lead to considerable disturbances of libido.

Antihypertensive therapy with angiotensin-2-antagonists and ACE inhibitors do not influence erection or are erection-protective; whereas alpha blockers and sartans may be considered beneficial. Most cardiac medication e.g., those containing digitalis or antiarrhythmic drugs may worsen erectile function.

Another group of medications that may lead to disturbed erectile function are psychotropic drugs, especially **tranquilizers** and **antidepressants** show strong sedative but also anti-cholinergic and anti-dopaminergic actions. These include both tricyclic antidepressive drugs as well as serotonin reuptake inhibitors, which have become predominant in recent years. These lead to inhibition of erection and ejaculation centers especially on the cerebral level.

Certainly a series of other drugs like **clofibrates**, **anti-histamins**, **antimycotic drugs etc.** are associated with disturbed erection. In many cases patients are dependent on various substances owing to different diseases, so that on the one hand, it is difficult to evaluate correctly the role of single medications, while on the other hand there may be no therapeutic alternatives. Especially in the case of antihypertensive medication it is worth considering whether beta blockers or thiazides cannot be replaced by medication that is erection-friendly

16.2.5 Diagnostic Workup in Erectile Dysfunction

The complexity of the physiological process of erection and the often multifactorial etiology of erectile dysfunction would make extensive and subtle diagnostic workup, as was regularly carried out in the past, appear useful and positive. The age of restricted budgets and inadequate remuneration for the physician, an age which brought with it oral pharmacological therapy adequate for most patients, has seen the advent of **diagnostic nihilism**. Adequate diagnosis, however, cannot be dispensed with completely, even in the age of oral therapeutics. It provides the patient with a sense

of security and satisfies his basic need for a rational justification for his clinical complaints. Especially in view of accompanying diseases so often the underlying cause, documenting pathological vascular findings becomes particularly important. Because of these basic considerations, diagnostic workup will be treated in greater depth than is often the case in practice today.

History and a clinical examination provide the first important hints concerning the pathogenesis of an erectile problem. To evaluate further the individual cause of impotence it is usually necessary to choose those investigations from a variety of procedures that will lead to a sound diagnosis, taking into account the availability, objectivity and invasiveness, as well as time and economic aspects. All these will finally lead to a therapeutic decision that takes into account the individual etiology of the erectile dysfunction and the patient's personal preference. Therefore an established **differential diagnostic workup** will help to exclude or quantify organic factors in patients with erectile dysfunction (Fig. 16.4).

16.2.5.1 History and Clinical Presentation

For most patients (and for some physicians) the first conversation will necessarily deal with the embarrassing subject of sexual disturbances, requiring great effort on the part of the patient. It will be the most important step towards a good patient-physician relationship. Often this first interview will give a decisive clue for classifying the sexual disturbance and can suggest further diagnostic and therapeutic procedures. It is essential that this interview be performed without undue disturbances (such as telephone calls) in a quiet and intimate setting without undue haste, if necessary outside normal office hours.

Above all the general history must cover **predisposing illnesses** possibly leading to arteriosclerosis, especially diabetes mellitus, arterial hypertension and disturbed lipid metabolism. The recommendations of the Second Princeton Consensus Conference demand increased diagnostic efforts for patients presenting with ED as primary symptom (Jackson et al. 2006b). Another factor of importance is **nicotine abuse**, which, apart from acute impairment of arterial perfusion, can lead to diminished occlusive function of the smooth musculature of the corpora cavernosa and thus may be important as a modifiable co-factor of ED. The history should

Fig. 16.4 Flowchart for the diagnosis and principal therapeutic options for erectile dysfunction

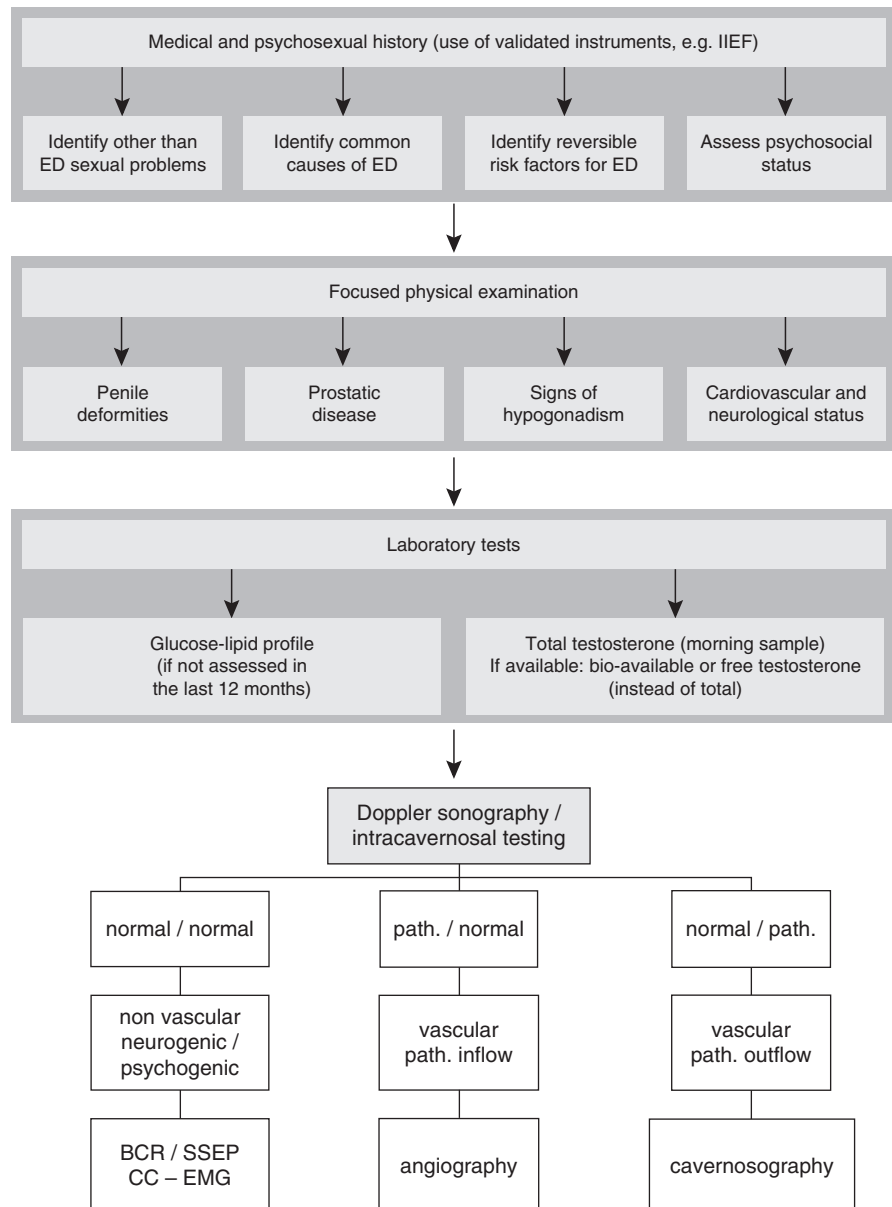

take note of **alcohol abuse** as well as life-style drugs. In addition to all cardiovascular diseases, neurologic systematic diseases such as epilepsy or multiple sclerosis should be inquired after, in patients with paraplegia the kind and extent of neurological deficits have to be registered. Major pelvic surgery can interfere not only with penile perfusion, but also with innervation of the corpora cavernosa and therefore needs to be noted. Not only surgery for urological tumors, but also sigma and

rectum resection as well as reconstructive vascular surgery (aorta and iliaca) are to be inquired after. Depending on the kind and extent of the laceration, pelvic trauma can also interfere with penile perfusion and/or innervation. Unlike prostate surgery or urethral surgery, very often **blunt trauma** to the perineum is only remembered if asked for explicitly.

A detailed **drug history** is essential since a number of widely used substances, especially anti-hypertensives

and diuretics or substances against fatty acid metabolism disorders may lead to disturbances of erectile function; conversely, cardiac or other adjuvant medication containing nitrates, alpha blockers and others can influence possibilities of oral therapy.

Finally, the general history should also evaluate the social and psychological situation of the patient since latent depression may play an important role in temporary functional erectile dysfunction. An extensive sexual history provides first insights into the kind of sexual disturbance. Generally, disturbances of libido, erection and ejaculation have to be differentiated. The evaluation and interpretation of any clinical presentation should take into account all these aspects of sexuality.

Primary erectile dysfunction usually exists from puberty and in most cases is due to congenital vascular abnormalities. **Secondary erectile dysfunction** is characterized by onset after a period of normal sexual activity and normal erectile function. Often differential diagnosis requires a precise description of the kind of sexual disturbance. Erectile dysfunction as the primary subjective symptom is evaluated by questioning the quality of erection and frequency of intercourse. Frequency of intercourse diminishes with increasing age, a fact often not accepted by the patient. Therefore it is important to clarify how the patient would judge his personal situation before the onset of erectile dysfunction.

Discontinuous problems that occur in specific situations or with specific partners usually point towards mainly psychogenic etiology. The same would apply to problems that are only connected with intercourse, but where early morning and nocturnal erections are not impaired and where a rigid and full erection is observed during masturbation. Similarly, these problems are usually of functional, non-organic origin. A premature ejaculation will also point to a significant functional non-organic factor. These patients should be seen by an experienced psychotherapist or psychologist early in the course of evaluation and therapy. Psychosexual disturbances of development and partner problems should be an indication to **involve the partner in psychosexual evaluation**. Sexual deviations make consultation by a psychiatric colleague mandatory. Ultimately, however, a diagnosis of psychogenic or “idiopathic” impotence should be established only in patients in whom significant organic pathologies have been excluded.

16.2.5.2 Clinical Examination

The clinical examination pays special attention to the secondary sexual features and the genitalia. Obvious changes in intensity of beard growth, hair distribution, body fat distribution and general constitution as well as accompanying symptoms such as fatigue, sleep disturbances, increased sweating or loss of libido may indicate hypogonadism. Since a pronounced androgen deficiency is generally accompanied by testicular atrophy, evaluation of size and consistency of the testes is of great importance. Many cases of hypogonadism, including patients with Klinefelter syndrome, are diagnosed because of an erectile dysfunction presenting as a primary symptom. **Palpation of the penis** will reveal cases with induratio penis plastica (Morbus Peyronie), which can lead not only to penile deviation but also to erectile dysfunction. Congenital penile deviation, however, will not show any pathological findings at physical examination and can only be diagnosed during erection (photographic documentation).

16.2.5.3 Laboratory Tests

To exclude endocrine causes of erectile dysfunction primarily serum testosterone and **SHBG** levels are necessary. Blood samples must be taken in the morning between 8.00 and 10.00 o'clock because of the circadian rhythm of testosterone. If values are low, LH should be measured to evaluate the pituitary-gonadal axis; as should prolactin, to exclude an inapparent prolactinoma (see Chap. 7). Free testosterone is calculated from total testosterone and SHBG (see Chap. 7). Other laboratory investigations should be performed to exclude latent diabetes mellitus (fasting glucose and HbA1) and disturbed lipid metabolism (lipid profile). For later treatment of ED, blood chemistry, liver values and PSA are important. Measurement of thyroid hormones, often recommended, can be restricted to hypogonadal patients; FSH is only necessary for patients with special clinical indications.

16.2.5.4 Intracavernosal Testing with Vasoactive Substances

Even today the diagnostic workup of erectile dysfunction by **intracavernosal testing** with vasoactive

substances plays a **central role** (Porst 1990). Injection of vasoactive substances usually enables a largely physiological erection to be induced. Thus, by eliminating nervous stimuli, vascular perfusion reserve and functional integrity of the smooth muscle cells of the corpora cavernosa, and therefore of the cavernosal occlusion mechanism, can be evaluated. By this procedure especially vascular disturbances can be evaluated or ruled out. The induction of a full rigid erection after small doses of vasoactive substances, however, will allow first insights into neurogenic or functional/psychogenic disturbances, especially when vasoactive testing is combined with other clinical investigations (Fig. 16.4).

Injection of vasoactive substances into the corpora cavernosa is performed after careful disinfection from a lateral position on either side with a 27 G-insulin canula to exclude laceration of the dorsal nerves and vessels and the urethra. Owing to the anatomical connections between the two corpora, an even distribution of the drug is guaranteed. Additional compression at the base of the penis is usually not necessary (Fig. 16.5).

Fifteen minutes after intracavernosal injection of vasoactive substance in a standing position the result of the test is evaluated with reference to tumescence and rigidity. Several different rating scales are available; in most cases the following will be used:

- No visible reaction
- Slight tumescence, no rigidity
- Medium tumescence, no rigidity
- Full tumescence, no rigidity
- Full tumescence, medium rigidity (sufficient for intercourse)
- Full tumescence, full rigidity

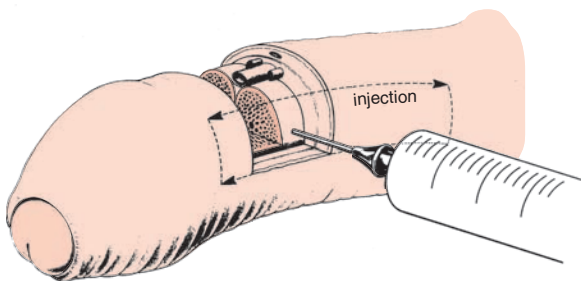

Fig. 16.5 (Alt 10.5) Technique of intracavernosal injection

A reaction between E0 and E3 is considered a negative vasoactive test; the patient is classified as a “non-responder”. If, after injection of the vasoactive substance a rigid erection sufficient for intercourse (E4–E5) occurs, this is classified as a **positive test** and the patient will be declared a responder. In patients who need additional testing, this diagnostic phase can be the first opportunity for the patient to be instructed in basic techniques of drug handling for self-injection therapy.

Evaluation of intracavernosal vasoactive testing has to take into account not only the quality of the induced erection, but also the latency of the induction and the duration of the erection. The procedure and final result of the tests together provide important clues to the etiology of erectile dysfunction (Fig. 16.4):

- If during intracavernosal testing with a low dose of vasoactive substance the patient shows a rapid and continuing full rigid erection with normal Doppler sonography of the penile vessels, arterial disorder and venous/cavernosal insufficiency are virtually excluded. Vascular abnormalities are very unlikely and for differential diagnosis between neurogenic and psychogenic etiology of erectile dysfunction, a further neurological workup may be helpful.
- If the erection only occurs after prolonged latency of 15–30 min but the patient reaches a full rigid erection, a hemodynamically relevant **arterial reduction of penile perfusion** appears very likely. This can be documented by pathological results of Doppler sonography of the penile vessels.
- A **positive result** in vasoactive testing will practically exclude a relevant venous or cavernosal insufficiency as the cause of erectile dysfunction.
- A **negative result** in vasoactive testing correlates in over 90% of cases with a venous/cavernosal insufficiency and an impairment of the cavernosal occlusion mechanism. In individual cases pharmacocavernosonography may be necessary for further evaluation.

In routine diagnostic workup today **prostaglandin E₁ (PGE₁)** as vasoactive substance has replaced **papaverine** alone, or in combination with the α -adrenoceptor antagonist. Papaverine is an opium alkaloid. By blockade of the phosphodiesterase intracellular cAMP is

increased and will lead to a release of calcium from the smooth muscle cells. The rationale for the use of α -adrenoceptor antagonists is the fact that the sympathetic tone is responsible for the flaccid resting state of the penis. Given alone they usually show a very limited clinical effect; in combination with papaverine or other drugs they facilitate the induction of an erection by reduction of the sympathetic tone and therefore a marked increase in the efficacy of other drugs.

Prostanoids in vitro have a different effect on the human cavernosal tissue. Under PGE₁ especially there is a marked relaxation of the human corpus cavernosum by an increase of intracellular cAMP via specific PGE₁ receptors. Additionally, PGE₁ in vitro inhibits the electrically-stimulated release of noradrenaline via presynaptic PGE₁ receptors which lead to a modulation of the endogenous sympathetic tone (Molderings et al. 1992). In vivo PGE₁ leads to strong vasodilatation. The substance is rapidly metabolized; degradation takes place mainly in the lung.

Generally, intracavernosal testing is possible with all of the above-mentioned vasoactive drugs. In addition to **papaverine** alone (Paveron®), the **combination of papaverine and phentolamine** (Androskat®) and **prostaglandin E₁** (Viridal®, Caverjet®) is well established; the combination of all three substances is also used (**triple drug therapy**). Within the usual therapeutic dose range **prostaglandin E₁** is the most potent monosubstance.

The efficacy of the various vasoactive substances can vary intra- and inter-individually concerning quality and duration of an erection. From the patient's history alone the effect of the drug is often not well predictable. Since the efficacy of the substances is usually proportional to the applied dose and an erection should not exceed 2–3 h in duration even in primary testing, it is always advisable to start with a low initial dose. If this low initial dose proves to be insufficient to induce a complete erection, further testing with increased doses is necessary. There should be a gradual increase in dose, with a time interval between two injections of at least 24 h.

Initial dosing and dose escalation for the various substances are:

- PGE₁ 5; 10; 20; (40) μ g
- Papaverine/phentolamine (30 mg + 1 mg/ml) – 0.5; 1; 2 ml

Escalation of the dose of PGE₁ above 20 μ g, however, has a beneficial effect in only 20% of patients, since in most cases there will be a saturation of the intracavernosal receptors at this dose.

Contraindications for intracavernosal vasoactive testing are:

- Severe decompensated cardiac and vascular insufficiency
- Critical coronary heart disease
- Severe disturbances of liver function (papaverine)
- Glaucoma (papaverine)
- Pronounced benign hyperplasia of the prostate with increased residual urine (papaverine)

Anticoagulant therapy with cumarins, low molecular heparins or aspirin represent only relative contraindications since no increased rate of complications has been observed when these patients use vasoactive substances.

Adverse side-effects can occur:

- Hematoma
- Intracavernosal pain
- Prolonged erections (3–6 h)
- Priapism (>6 h)
- Infections of the corpora cavernosa

Pain in the glans is described by 10–80% of the patients after papaverine/phentolamine during injection of the substance. This pain is usually of very short duration and subsides within a few minutes (Lue and Tanagho 1987). With PGE₁ 10–40% of patients complain of a very irritating feeling of increased intracavernosal pressure, in some patients severe pain may persist for several hours and even show a duration longer than the erection itself. In only about 2% of these patients is this discomfort and pain so strong that it will prevent them from having intercourse. The cause of these complaints is unclear and a connection with various solvents is being discussed. With papaverine a slight reduction in blood pressure with dizziness is sometimes reported.

Complications of intracavernosal testing with vasoactive drugs are mostly small, insignificant hematomas that will resolve spontaneously and that do not require specific therapy. **Septicemic infections of the corpora cavernosa** are dangerous but extremely rare. The most important complications of intracavernosal testing with vasoactive substances, however, are **prolonged erections** and **priapism**. The borderline between a prolonged erection and priapism is not clearly defined and some authors classify 3–6 h of full erection as prolonged. Such a situation usually requires no or limited therapeutic measures, depending on the substance used. Priapism is characterized by duration of the artificial erection of more than 6 h. Depending on the elapsed time and the consequent metabolic changes with acidosis in the corpora cavernosa the situation may lead to complete destruction of the smooth muscle cells with consecutive fibrosis. Irreversible damage is usually seen after priapism of more than 12 h duration (Porst and van Ahlen 1989).

Therapy of choice is usually the puncture of the corpora cavernosa with drainage of 50–200 ml of cavernosal blood until marked arterialization of the cavernosal blood can be visually identified. After this α -sympathomimetic drugs will be applied in slowly escalating doses. The use of these substances should always be accompanied by close observation of blood pressure and cardiovascular function, since vital circulatory complications with hypertensive crisis may occur. The practice of administering prophylactic doses of nitroglycerine (e.g., Adalat® 10–20 mg) simultaneously with the onset of drug-induced hypertension is well established.

Aside from lower effectiveness, the significantly greater frequency of prolonged erections and priapism occurring after papaverine or the combination of papaverine and phentolamine during the test and dose-finding phase of injection therapy has made PGE₁ the substance of choice (7%). The reason for the markedly reduced incidence of priapism under PGE₁ may be the local intracavernosal metabolism of prostaglandin (van Ahlen et al. 1995).

When choosing a vasoactive substance, theoretically papaverine has the advantage of **very low cost**, combined with a comparatively high diagnostic risk. Aside from its limited efficacy, slow dose escalation may lead to an increased number of necessary injections.

Prostaglandin E₁ is by far more expensive, but because of its superior efficacy and broad therapeutic safety requires a low number of injections.

16.2.5.5 Doppler Sonography

To date **Doppler sonography of the penile vessels** remains a mandatory part of organically oriented diagnostics. As a **non-invasive, cost-effective method** it will pick up disturbances of the **arterial penile circulation** which are one of the most important etiological factors in the pathogenesis of erectile dysfunction. Only after the introduction of smooth muscle stimulation by intracavernosal injection of vasoactive substances did the systematic examination of the deep penile artery perfusing the corpora cavernosa become possible. In the flaccid state of the penis this artery has a very small diameter of approximately 0.5 mm, since most of the penile perfusion will be extracavernous. Therefore in a flaccid state visualization will be difficult even with high-resolution ultrasound of 8–10 MHz. Nowadays Doppler sonography should always be performed in combination with the application of vasoactive substances into the corpora cavernosa during vasoactive testing.

In earlier times most investigators tried to establish baseline findings on the dorsal penile artery and, if possible, also on the deep penile artery before application of vasoactive substances. Today most investigators will perform Doppler sonography only 5–10 min after injection of the vasoactive substances, with still increasing tumescence of the penis. Only an examination before induction of a full rigid erection will allow reliable judgement of the dilatatory capacity and the perfusion reserve of the examined vessel, since physiologically arterial perfusion will be markedly reduced after induction of phase III of the erection, when blood flow usually drops to baseline levels (see Table 16.2).

Purely acoustic judgement of the Doppler signal is clearly not adequate. Registration of the Doppler curve with a *continuous-wave-Doppler* (cw-Doppler) is a minimum technical requirement. Since the cw-Doppler will record all vessels within the Doppler signal it is essential to differentiate superficial branches of the dorsal penile artery from the cavernosal arteries. This is usually achieved by slight compression of the penile skin and by the different character of the recorded Doppler signal.

Evaluation of Doppler sonography usually takes into account the absolute height of the Doppler curve and the maximal perfusion velocity, as well as the relative increase compared to the base line examination just before application of the vasoactive substance.

A broad pulse curve with reduced initial velocity and low amplitude are typical signs of insufficient arterial perfusion.

16.2.5.6 Duplex Sonography

In duplex sonography, which, like cw-Doppler sonography, is always combined with intracavernosal application of vasoactive substances, the penile arteries are examined by a **combination of conventional ultrasound (B-image) and a pulsed Doppler**. This will allow the examiner to position the cursor and thereby the measuring point of the pulsed Doppler exactly inside the lumen of the investigated penile vessel, under direct visual control. Apart from a precise sonographic documentation of an isolated vessel, this allows highly precise registration of Doppler curves and thus makes measurements of arterial perfusion possible. Apart from changes in diameter of specific arteries, one can calculate systolic and diastolic velocities of blood flow (Fig. 16.6a).

After injection of vasoactive substances a diameter of 1 mm of the cavernosal arteries together with visible pulsations of the vessel and a drug-induced dilatation by at least 75% compared to the base line findings are regarded as normal values. Maximal blood flow velocity should be above 25 cm/s to exclude a major impairment of arterial circulation (Rhee et al. 1995).

Since blood flow velocity will increase physically in areas of stenosis, both flow velocity and diameter increase should always be taken into account when judging the arterial status of the penis. Maximal flow velocity as the only criterion has to be seen very critically. The measurement of blood flow itself in volume/time (ml/min) has not found wide acceptance owing to considerable variation. The reliability of the examinations can be increased by an additional evaluation of the form of the Doppler curve and measurements of the systolic rising velocity. Short times below 110 ms reveal unimpaired dilatation capacity of the examined artery and documents the integrity of arterial perfusion (Oates et al. 1995). Increased diastolic flow velocities above 5 cm/s can be a hint for insufficient relaxation of the smooth muscle cells of the corpora cavernosa and for the existence of a cavernosal insufficiency with increased venous drainage (Golijanin et al. 2007) (Fig. 16.6b). Furthermore determination of the resistance index (RI) is an accepted parameter for judging the venous

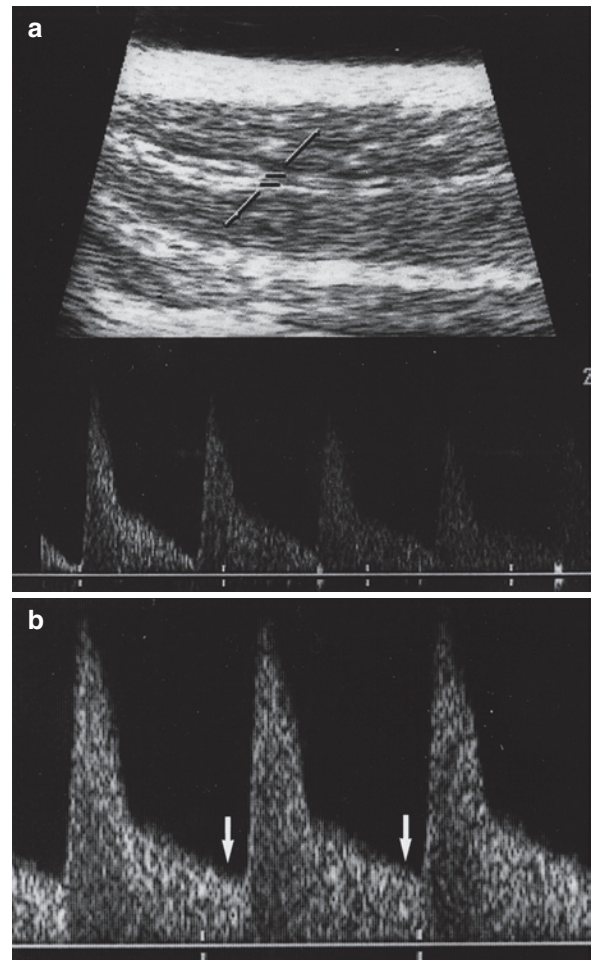

Fig. 16.6 Duplex sonography of the cavernosal artery after intracavernosal injection of $10\mu\text{g PGE}_1$. (a) Upper half: sonography of the corpus cavernosum of the cavernosal artery. The probe of the Doppler is positioned in the lumen of the cavernosal artery. Lower half: simultaneous registration of the pulsed Doppler curve. (b) Registration of the pulsed curve of the cavernosal artery with increased diastolic flow (arrow) as a possible indication of disturbed cavernosal occlusion

intactness of the system and is dependent on the final diastolic flow. An RI < 0.8 with normal systolic flow rate and incomplete erectile reaction is an indication of a venoocclusive insufficiency (Altinkilic et al. 2004).

Whereas a few years ago pulsed Doppler sonography hardly appeared widely applicable, owing to very high equipment costs, it has by now been established as a routine procedure. Nowadays it appears to be the **almost ideal screening investigation** for the evaluation of arterial perfusion and has replaced conventional cw-Doppler sonography almost completely. It is easy to learn and

there is practically no additional effort compared to conventional Doppler. A combination of morphological and functional evaluation allows much better judgement of the functional perfusion reserve than would be possible with conventional Doppler sonography.

Another technical improvement of pulsed duplex sonography is **color-coded duplex sonography**. The ultrasound signals that are reflected from the moving erythrocytes are color-coded depending on flow direction and velocity so that arterial and venous vessels can be rapidly differentiated. This new technique not only allows quantitative measurements of flow velocity but also visualization of perfusion of the whole penile course of the vessel. Therefore different areas of the vessel can be recorded at the same time with visualization of blood flow into the helix arteries and into possible collaterals between superficial and deep arteries.

16.2.5.7 Penile Angiography

In the past angiography of penile arteries was often regarded as the gold standard in the evaluation of vascular disturbances. It is, however, a very invasive diagnostic procedure that is not without risk. Even the conventional cw-Doppler sonography under vasoactive stimulation, however, correlates in over 90% with the results of selective angiography (Porst et al. 1988a). Since the technical progress of non-invasive, cheap and less time-consuming sonography, especially duplex sonography, angiography today is only indicated in a forensic setting or in patients with a primary erectile dysfunction with suspected congenital vascular dysplasia or malformation. Presurgical visualization of the internal pudendal artery and the inferior epigastric artery before reconstructive vascular surgery remains a therapeutic indication.

Like Doppler sonography, angiography will only be reliable after intracavernosal injection of vasoactive substances. Since it will only provide morphological information in dubious cases, the hemodynamic relevance of these angiographic findings has to be cross-checked by duplex sonography.

16.2.5.8 Evaluation of Venous Drainage

In approximately 10% of patients with erectile dysfunction even the highest doses and appropriate

combinations of the usual vasoactive substances are not able to induce an adequate erection, intracavernosal pharmacological testing is negative and the patient is classified as a non-responder. Usually this situation is a sign of the incompetence of the cavernosal occlusion mechanism with increased drainage of venous blood from the corpora cavernosa, a phenomenon that has in the past often been classified as venous leakage.

The indication for quantification and visualization of the venous drainage from the corpora cavernosa must be judged carefully owing to the relatively high costs, invasiveness of the examination and limited therapeutic consequences. Therefore pharmacocavernosography should only be performed in cases with a history of incomplete or rapidly declining erections and when sufficient erection cannot be induced even under high doses of vasoactive substances. Positive test results will exclude clinically relevant venous or cavernosal insufficiency. Following disappointing long-term results of vascular surgery the therapeutic consequence of cavernosometry and cavernosography is reconstructive vascular surgery or, in the majority of cases, implantation of penile prostheses which are generally not accepted by a large number of patients. As a result today **pharmacocavernosography** is not generally recommended and is performed only in **exceptional cases**.

The diagnostic workup of the cavernosal occlusive mechanism consists of two parts. It includes **intracavernosal pressure readings under the circumstances of an artificial erection** following the infusion of saline under controlled flow rates. By means of an intracavernosal canula, saline is infused into the corpus cavernosum while a second canula continuously registers intracavernosal pressure. This part of the examination is called **cavernosometry** (Fig. 16.7).

Since adequate compression of the draining veins via the relaxed cavernosal sinoids is only achieved during increasing rigidity, nowadays the investigation is always performed with the use of vasoactive substances and is then classified as **pharmacocavernosography**. High doses of the vasoactive substances are necessary because the indication for pharmacocavernosography is a negative result in vasoactive testing. To achieve complete relaxation of the smooth muscles of the corpora cavernosa, additional small doses of vasoactive substances after an initial injection of a high dose may be necessary. Experimental data show that only a limited percentage of patients will reach this

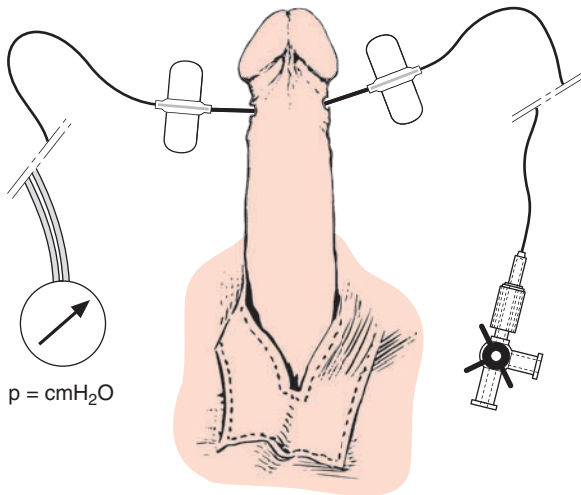

Fig. 16.7 Principle of cavernosometry and cavernosography

complete relaxation with a single dose of vasoactive substances (Hatzichristou et al. 1995).

In cavernosometry the infusion flow rate is reduced after a supersystolic pressure plateau has been reached. The flow rate/minute to maintain a defined intracavernosal pressure will be measured and is defined as the maintenance flow, one of the most important criteria in the evaluation of cavernosal compliance. A linear correlation of maintenance flow rates and intracavernosal pressures is an indication for complete relaxation of the cavernosal smooth muscles. Maintenance flow rates below 5 ml/min are regarded as normal.

Another parameter that appears to be a relevant criterion in the evaluation of cavernosal occlusive function is the pressure decay time. After reaching a defined

pressure plateau the intracavernosal infusion is stopped and the pressure decay is measured over a period of 30 s. Normally there is a slow linear decline of intracavernosal pressure. Exponentially dropping pressure values with a half-life of less than 1 min and a pressure reduction of more than 50 mmHg within 30 s indicate a severe cavernous/venous disturbance.

In cases with increased maintenance flow rates the application of contrast medium can allow radiological documentation and localization of the venous leakage and the draining veins under direct visual control (cavernosography). Without previous vasoactive stimulation venous outflow from the corpora cavernosa shows great anatomical variability. In most cases the proximal corpus cavernosum will be drained by cavernosal veins while the drainage from the middle and distal parts of the corpora cavernosa will take place via the emissary veins and the circumflex veins into the superficial and deep dorsal veins. Ectopic veins which drain cavernosal blood directly into the femoral vein are relatively rare (Fig. 16.8a). In most cases of cavernosal insufficiency the increased drainage will be via physiological veins. Those types of insufficiency where the increased drainage appears via crural veins or via the glans penis and the corpus spongiosum especially will often prevent sufficient surgical therapy (Fig. 16.8b).

Complications of cavernosometry and cavernosography are often local hematomas which are usually resolved within a few days. With correct positioning and sufficient length of the needles penile edema is a rare complication and declines rapidly. Local infections of the corpora cavernosa have been described in the literature but are extremely rare so

Fig. 16.8 Pathological findings in cavernosography. (a) Isolated insufficiency of the dorsal vein complex with minimal filling of the corpora cavernosa and rapid venous drainage of the applied contrast media via the V. dorsalis profunda. (b) Increased drainage via crural veins, which leave the corpora cavernosa dorsomedially

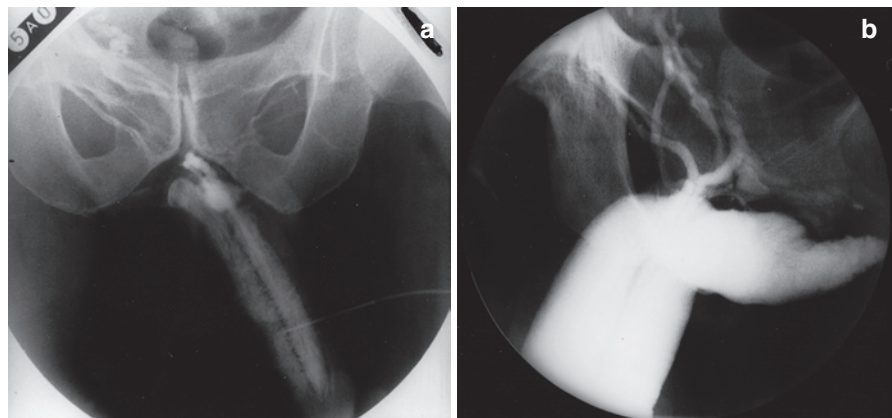

that routine antibiotic prophylaxis does not seem to be justified. In the event of local inflammatory changes of the penis the investigation should be postponed. Of course, allergies to the contrast medium can also occur with the use of non-ionic contrast media and have to be explained to the patient. In patients with cardiac insufficiency a critical fluid load will rapidly be reached in conventional dynamic cavernosometry. The introduction of pharmaconcavernosometry and cavernosography has reduced the necessary flow rates markedly and has thereby increased the safety of the investigation, especially in critical patients. In most patients, however, the indication for pharmaconcavernosography should be critically evaluated since therapeutic consequences of this invasive investigation are usually surgical.

As a non-invasive method for morphological evaluation of the corpus cavernosum magnetic resonance imaging of the penis is preferable and can similarly be performed with pharmacological stimulation. Currently there are no clinical studies on the diagnostic value of penis MRT.

16.2.5.9 Neurophysiological Investigations

From the patient's history, accompanying symptoms have to be questioned that might be an indication for **motory or sensory lesions** due to a neurologic disorder. Most of the systematic neurological diseases are already known and therefore easy to evaluate. The primary manifestation of a neurological disease by erectile dysfunction is extremely rare.

Clinically and electrophysiologically the most easily measurable reflex is the bulbus-cavernosus-reflex (BCR), which represents the nervous conduction between the penis and the sacral erectile center (S2–S4). A defined electrical impulse is applied via circular electrodes on the penile shaft and the reflex latency can be measured bilaterally via needle electrodes in the bulbocavernosal muscles (Porst et al. 1988b). Simultaneous registration of cortically evoked potentials is performed at known reference points at the scalp (somatosensory evoked potentials; SSEP). The absolute latency of the BCR and differences between the two sides after repeated application of identical stimuli will provide information on the integrity of the

short tracts between the penis and the sacral erectile spine. The potentials evoked are largely influenced by the patient's height which will allow the detection of disturbances of the long cerebrospinal tracts. Only a standardization of these diagnostic procedures made analysis of the somatosensory aspect of penile innervation, as well as of neurogenic erectile dysfunction, objectively possible (Kaneko and Bradley 1987; Lavoisier et al. 1989).

Another part of the efferent fibers belongs to the parasympathetic system, coming from the inferior hypogastric plexus and reaching the corpora cavernosa as the cavernosal nerve which inhibits the tonic activity of the smooth muscle cells. Direct diagnosis of lesions below the level of the pelvic floor has not been possible up to now. Indirect signs of disturbances of autonomous innervation are reduced urinary flow rates or impairment of bladder emptying without any other distinguishable cause. Direct measurement of the electrical activity of single smooth muscle cells of the corpus cavernosum (corpus cavernosum EMG, formerly also known as single potential analysis of cavernous electrical activity, "SPACE") is possible today (Stief 1993).

The interpretation of accumulated data, however, is difficult and often unclear, independent of the method of qualitative, semi-quantitative or computer-aided registration. Despite acceptable reproducibility, the diagnostic role of this procedure cannot yet be finally judged. Other indicators of disturbed sympathetic innervation can be a reduced or absent sympathetic skin reflex. In combined problems, but also in patients with normal somatosensory innervation and normal BCR, the sympathetic skin reflex is able to prove a neurogenic etiology in some patients and may be performed in selected cases (Dettmers et al. 1994).

As somatic and autonomic nerve fibers follow a separate anatomical course in some regions, iatrogenic or traumatic lesions can be the reason for certain patterns of damage. In many cases parasympathetic innervation can be very difficult to evaluate and therefore the patient's history and clinical data have to be given special attention. In forensic questions especially, anamnestic and clinical data need to be considered in addition to electrophysiological findings. In the face of elaborate and time-consuming diagnostics the lack of therapeutic relevance has diminished the importance of all these procedures.

16.2.5.10 Nocturnal Penile Tumescence and Rigidity Measurements (NPT)

In normal males there are 3 to 5 erection phases of 20–30 min duration which occur physiologically during the rapid eye movement phase of sleep. On the assumption that psychological factors do not influence this type of erection, measurement of nocturnal penile erections has long been regarded as the reference method for differentiating organic and psychogenic erectile dysfunction (Davis-Joseph et al. 1995).

While investigations in sleep laboratories are very personnel and time-intensive, nowadays several different methods for registering nocturnal penile erections are available. Simple methods like the stamp test or the snap-gauge device only allow judgement of achieved tumescence and are therefore suitable for a rough estimation that does not include penile rigidity. With the **registration of nocturnal penile erections** by a RigiScan®, changes in tumescence can be measured continuously and separately at the tip and the base of the penis and can be correlated with relative rigidity, which is the most relevant parameter concerning ability for penetration. Sensitivity and specificity of the method are, however, much lower than has been previously assumed and the findings can only be interpreted in conjunction with other organically oriented investigations. Since nocturnal penile tumescence measurements will register the quality of penile erections, but not the quality of nocturnal sleep, the results of these tests cannot be used in patients with sleep disturbances. Different medications and psychogenic psychiatric disturbances like depression can interfere with nocturnal erections. Also, with increasing age and in patients with hypogonadism, the number and rigidity of nocturnal erections is markedly reduced. In several neurological systematic diseases like multiple sclerosis nocturnal erections can be maintained, but psychogenic and refluxogenic erections can still be severely impaired, making intercourse impossible (Morales et al. 1990).

Owing to the low sensitivity and specificity and the high costs of the apparatus, the method is not suited to routine diagnostic work-up. For clinical questions the method is only used today if simultaneously a sleep clinic is also available. It rather plays a role in forensic questions and in the evaluation of post-operative or post-traumatic erectile dysfunction, especially if isolated lesions of the autonomous innervation (nervi

cavernosi) or scientific investigations on penile rehabilitation are questions under discussion.

A valid criticism of all diagnostic procedures discussed here is that even in cases with pathological organic findings often clear-cut cause-and-effect relationships cannot be established so that diagnoses, which may appear to be scientifically founded, should be considered with caution and initially as a working diagnosis. It is not infrequent that patients without clinical manifestation of erectile dysfunction will show organic findings comparable to those found in patients with pronounced symptoms. Furthermore, few cases have only a single cause. In the majority of cases several factors are involved in the etiology of erectile dysfunction, so that not only a multidisciplinary approach but also an adequate therapeutic strategy should be aimed for. Despite revolutionary developments in the therapeutic sector, even today thorough diagnostic classification is mandatory.

Despite revolutionary developments in recent years on the therapeutic level, increasing economic pressure on physicians and the often iterated lack of therapeutic consequences of all diagnostic procedures, in the interest of many patients, basic diagnostic evaluation cannot generally be dispensed with.

16.2.6 Therapy of Erectile Dysfunction

Generally, therapy of erectile dysfunction can be classified into conservative, non- or minimal invasive and surgical treatment forms. Conservative methods include the various psychologically orientated treatments, transcutaneous topic and oral pharmacological efforts and the application of external vacuum devices. Injection therapy can be classified as minimally invasive.

16.2.6.1 Psychological Treatment

Strictly speaking, psychological treatment really begins with the initial evaluation of the patient and the discussion of his sexual disturbance. In many cases with short-term, non-fixated sexual disturbance without any relevant organic deficit only a few

conversations will be sufficient. It is not infrequent that one of the main problems is a completely unrealistic, exaggerated expectation concerning sexual capacity, often produced or worsened by public media. The patient's attitude concerning his sexuality should be questioned. His own expectations and fear of failure should be clarified and the physiology of human erection should be explained. In many patients it has proven extremely helpful to explain the biochemical connections between fear of failure and increased sympathetic tone on the one hand, and a functional erectile problem on the other. Such counselling should prompt the patient and his partner to analyze their relationship. The aim of psychological counselling and treatment should not be limited to therapy of erectile dysfunction, but should also try to improve communication within the partnership.

In recent years classical psychodynamic therapies have been largely replaced by sexual therapeutic methods. Sexual therapy again relies on experience from other treatment forms such as couple therapy, family therapy or behavioral therapy. Overcoming fear of failure is one of the most important aspects of sexual therapy, as promulgated by Masters and Johnson (Masters and Johnson 1970). To reach this aim, the couple will usually be asked to refrain from coitus for a limited period of time, which will help to limit these fears of failure. One of the main aims of the therapy is to produce an atmosphere free of tension and fear and to promote and develop non-coital sexual practices. In most cases this alone will lead to a significant improvement of communicative ability and of the partner relationship. In most cases it is beneficial to involve both partners in the therapeutic process. Longstanding disturbances, additional severe problems in the partnership or a marked loss of libido have an unfavorable prognosis (see Chap. 26).

The results of sexual therapy as a causal therapeutic intervention in psychogenic erectile dysfunction are very good and reach success rates of approximately 90% when therapy is of adequate duration. In many cases the involvement of the partner can be understood as one of the main reasons for such excellent results. The treatment, however, is very time-consuming and often numerous sessions are necessary which may be one of the main reasons for poor compliance. Problems of practicability result not only from the great investment in time, but from insufficient availability of adequately trained sexual therapists.

Psychologically oriented therapy should not only be performed for purely psychogenic disturbances, but should also be discussed and offered to the patient if the origin of his erectile dysfunction is mainly organic. It is rare that erectile disturbances are of single cause and even in patients with a severe organic finding, especially if longstanding, psychogenic components are rarely absent. On the other hand, patients with erectile dysfunction of mainly psychogenic origin may benefit from additional organically oriented treatment. Recent studies have clearly demonstrated the highly beneficial effect of such combined treatment, often either in conjunction with injection or vacuum therapy (Hartmann and Langer 1993).

16.2.6.2 Hormone Therapy

Generally, hormonal therapy should be limited to those patients with erectile dysfunction of endocrine origin. Even in the absence of other measurable organic or psychogenic factors, a severe androgen deficiency is present when testosterone values are below 12 nmol/l. Values in the low normal range or slightly below should first be checked. The initiation of testosterone substitution is not justified on the basis of a single borderline measurement. Testosterone should always be determined in the early morning hours as the serum level, particularly in younger men, shows considerable circadian rhythm and may show individual variations of up to 30% (see Chap. 7). Since androgen substitution is not superior to placebo when serum testosterone is normal, hormone therapy without proven deficit makes little sense and is questionable because of potential side effects. When, however, testosterone values are repeatedly subnormal, it must be considered that testosterone is a decisive conditioning factor for central, but also for peripheral intracavernosal signal transduction on which NO synthetase depends. In such cases increasing low testosterone levels to the physiological range may lead to improvement of the effectiveness of PD5 inhibitors or, in individual cases, to spontaneous normalization of erectile function (see also technique of testosterone substitution, Chap. 21).

In hyperprolactinemia slight stress-induced elevations of the serum levels should be ruled out by repeated measurements. Pharmacological causes for elevated prolactin levels should be excluded and in patients

with a prolactinoma, treatment with a dopamine antagonist should be initiated.

16.2.6.3 Topical Therapy

Various substances potentially facilitating erections have been used on the penis. **Nitroglycerine** paste, for example increases arterial perfusion to a limited extent and facilitates erection under visual stimulation; its efficacy in improving cohabitation and patients' ability for sexual intercourse has not yet been proven. The use of condoms in this therapy is obligatory since **severe headaches** may be induced in the patient and in the partner. A positive effect on erection can only be expected in patients with psychogenic problems or minimal reduction of arterial perfusion: in patients with severe impairment of penile circulation they do not represent a reasonable therapeutic option.

The external application of prostaglandin gel or gels containing papaverine was ineffective because of inadequate local resorption through the tunica albuginea into the corpora cavernosa.

So far all efforts to overcome this problem have been without success.

Intraurethral application of prostaglandin E₁ can avoid the problem of local resorption, at least in part by instilling the substance in the penile urethra using a one-time applicator. MUSE[®], commercially available since 1998, has the advantage of simple needle-less application (Padma-Nathan et al. 1977). Despite doses of 500–1,000 µg its effectiveness is not comparable to intracavernosal use of vasoactive substances. The main side-effect is a considerable burning sensation in the urethra. No reliable data are available concerning complications with long-term use of excessive doses. The dropout rate after 15 months (ca. 75%) was very high. Today it is mainly used in treating post-operative ED.

The high dose of PGE₁ makes condom use obligatory if the partner is pregnant.

16.2.6.4 Oral Therapy

The introduction of highly effective substances, particularly oral medication, has revolutionized therapy of erectile dysfunction. Preparations with a central mode of action (yohimbine, apomorphine) can be dis-

tinguished from those with peripheral effects (yohimbine, phentolamine, PDE-5 inhibitors).

One of the oldest substances is **yohimbine**. Different prospective, randomized studies demonstrate a success rate of about 30% in patients with psychogenic erectile dysfunction and in those without severely compromised arterial perfusion. The main mode of action is based on central and peripheral α -2-adrenolytic effects (Ernst and Pittler 1998; Vogt et al. 1997). It becomes fully effective after about 4–8 weeks. 3 × 5 to 3 × 10 mg daily are required. Alternatively “on demand” therapy can be administered 1 h before intercourse. Since the side-effects are relatively low, it is **suitable as a primary treatment option** for patients with no or only minor organic disturbances and who reject more invasive methods.

Of those substances with a central mode of action **trazodone** has been well investigated. In some cases it causes priapism, although therapeutic effectiveness tends to be inadequate at a dose of 100–200 mg. Because of its antidepressant effect it is suitable for psychogenic cases. It has not become standard therapy.

Great expectations were placed in **apomorphine**. This substance has been known for a long time and affects central dopamine receptors. Altered formulation with sublingual application improved its tolerability (gastrointestinal side effects) while maintaining its therapeutic potential for erectile dysfunction treatment (Heaton et al. 1995). Although it is still licensed, because of its inadequate and unreliable effectiveness in clinical application it is no longer produced and is thus no longer available.

Exogenous and endogenous opiates have shown pronounced inhibitory effects on sexual functions in animals and humans. Stress factors lead to a physiological stimulation of the endogenous opiate system and the tonic hyperactivity of the central opiate system may be responsible for erectile dysfunction in a selected number of patients. Placebo-controlled investigations with the **opiate antagonist naltrexone** show a limited efficacy of the drug in selected patients without relevant organic deficit (Fabbri et al. 1989; van Ahlen et al. 1995). The effectiveness of the substance is not sufficient.

The well-known adrenolytic effect of α -receptor blockers led to trials with oral **phentolamine** (Vasomax[®]), a nonselective α 1/ α 2 receptor blocker with mainly peripheral effects. It is applied ca. 1 h before intercourse. The results of different international phase II

multicenter trials varied considerably. While in Germany doses of up to 60 mg were no more effective than placebo, in the USA licensing bodies found its effectiveness was greater, reaching responder rates of up to 48% with 80 mg, as opposed to 22% responders with placebo. Side-effects seen in trials were slight. Because of diverging results and limited clinical effectiveness compared to PDE-5 inhibitors, the substance was not submitted for licensing.

In the past few years revolutionary changes in the therapy of erectile dysfunction, accompanied by hitherto unheard of journalistic attention, resulted when the first oral phosphodiesterase inhibitor, sildenafil, was introduced in 1998. Physicians of all specializations suddenly became acknowledged experts on erectile dysfunction and healthy men became patients overnight, unfortunately in some cases not without lethal consequences. In the meantime the phosphodiesterase inhibitors have established themselves as reliable and safe medications (Goldstein et al. 1998; Carson et al. 2004; Padma-Nathan 2006; Rubio-Aurioles et al. 2006; Rosenberg 2007) whose applications have increasingly gone beyond treatment of ED and which have in the meantime also been licensed for the treatment of pulmonary hypertension. Ultimately awareness that erectile dysfunction is a marker or at

least an accompanying symptom of serious cardiovascular disease often preceding grave cardiac events by 2–3 years has lastingly changed opinions on the part of both patient and physician. Thus phosphodiesterase inhibitors are now recommended as first-line therapy in the current Guidelines of the AUA (AUA 2005).

The mechanism of action of the group of substances is based on a biochemically caused modulation of the relaxation of smooth muscle cells. A parasympathetic erection-inducing nervous impulse leads to the release of NO at the endothelial cells of the cavernosal tissue. By activation of guanylyl cyclase guanosine triphosphate and second messenger cGMP are metabolized. As shown in Sect. 16.2.3, cGMP leads to relaxation of smooth muscle cells by depletion of intercellular calcium. By inhibiting local phosphodiesterase, PDE-5 inhibitors lead to reduced metabolism of cGMP, which accumulates in the cavernosal tissue and thus impairs relaxation of the smooth musculature of the corpora cavernosa of the sinusoids as a storage battery of penile vessels, resulting in increased perfusion and thus improved erection (Fig. 16.9). Thus the effectiveness of PDE-5 inhibitors depends on the transmittal of a nervous impulse via an intact peripheral reflex system, not least by means of adequate sexual stimulation, and on the presence of sufficient amounts of NO in erectile tissue.

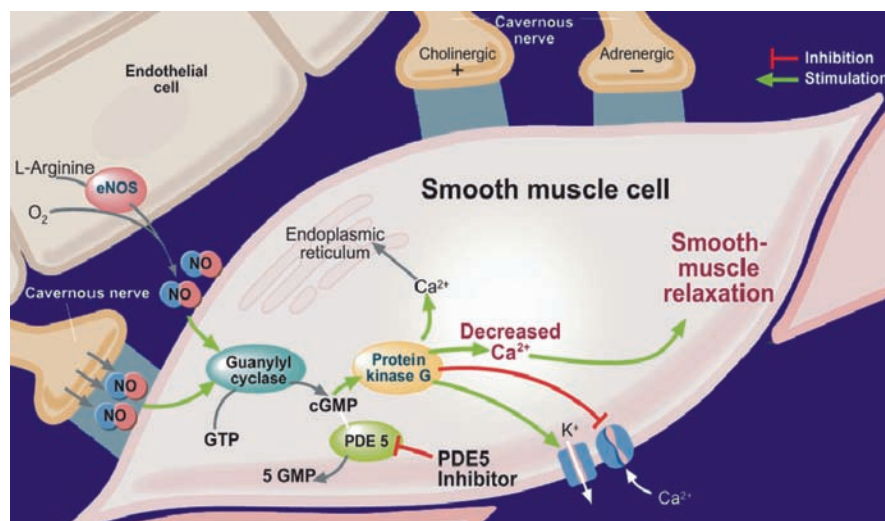

Fig. 16.9 Mechanism of action of phosphodiesterase inhibitors on the smooth muscle of the corpora cavernosa. Following stimulation NO activates the guanylyl cyclase and GTP (guanosine triphosphate) is converted into cyclic guanosine monophosphate (cGMP). cGMP activates protein kinase G (PK G), leading to uptake of free intracellular calcium. The decrease of intracellular

Ca²⁺ levels causes relaxation of smooth muscle. Application of phosphodiesterase inhibitors blocks the function of PDE-5 so that cGMP is not metabolized to 5'-GMP. Enhancement of cGMP results in increased activity of protein kinase, thus further reducing intracellular calcium concentrations and mediating improved relaxation of the smooth musculature

Phosphodiesterases are enzymes with at least 11 subtypes and are ubiquitous in the body. In erectile tissue types three to five predominate. Types 3 and 4 catalyze the metabolism of cAMP in smooth muscle cells, type 5, which is especially frequent in penile vessels and in the intracavernosal endothelium, concentrates on cGMP. PDE-6 is found in the retina and is responsible for the cross reactions occasionally occurring with higher doses of sildenafil (slightly blurred and blue vision). Higher concentrations of PDE-11 have been demonstrated in the testes and prostate; the exact function of the enzyme in these organs has not yet been exactly defined.

Treatment of erectile dysfunction with PDE-5 inhibitors has become internationally established and is recommended as primary therapy by various professional organizations (AUA 2005).

Currently three substances are available: **sildenafil (Viagra®)**, the first oral substance to be licensed worldwide for the treatment of ED, as well as **vardeafil (Levitra®)** and **tadalafil (Cialis®)**. The substances differ in their pharmacological properties and have different pharmacokinetic characteristics. In vitro vardenafil has the lowest concentration of IC_{50} (the concentration at which 50% of enzyme activity is inhibited) and the highest receptor affinity and binding power and pharmacologically is the most effective substance in vivo (Blount et al. 2004). In clinical terms no relevant differences in effectiveness of the substances were found in the licensing investigations or clinical experience at the maximal therapeutic doses. Clinical comparative studies are often highly biased and objections may arise concerning study design and interpretation of

results (Mulhull and Montorsi 2006). Relevant clinical differences may possibly lie in their effectiveness at submaximal doses of the substances. Of the three substances, vardenafil has the strongest selectivity for PDE-5. Tadalafil shows the lowest interaction with PDE-6 (visual disturbances) but there are considerable cross-reactions with testicular PDE-11, whose function is not completely clear.

The most relevant difference among the three substances is their pharmacokinetics. Along with rate of resorption, the half life is different (Fig. 16.10). Whereas onset (T_{max}) is approximately 40 min for vardenafil or 70 min for sildenafil, the mean onset time for tadalafil is 120 min. Clinically all three substances can induce a good erection before T_{max} , which is attributable to the inhibition that has already taken place by this time. Thus sildenafil and vardenafil can induce erections in some patients after 10–15 min and more than 50% of responders taking vardenafil achieve erections adequate for intercourse after 25 min. Similarly a number of patients using tadalafil achieve an erection after 30 min, but because of the pharmacokinetics, individuals report considerably longer intervals. These pharmacokinetic differences are usually not clinically relevant for the individual.

Prior food and alcohol intake influence speed of resorption and maximal plasma levels for vardenafil and sildenafil slower substances, this is not the case for tadalafil. For sildenafil and vardenafil the halflife is identically about 4 h, whereas it is about 17.5 h for tadalafil. Clinical effectiveness is two to three times the halflife for all three substances, i.e., 8–12 or 36 or more hours. During this period an erection can be induced,

Parameter	Vardenafil 20 mg*	Sildenafil 100 mg**	Tadalafil 20 mg***
T_{max} (min)	40 (15–180)	70 ± 59	120 (30–720)
$T_{1/2}$ (h)	3.94 ± 1,31	3.82 ± 0.84	17.5

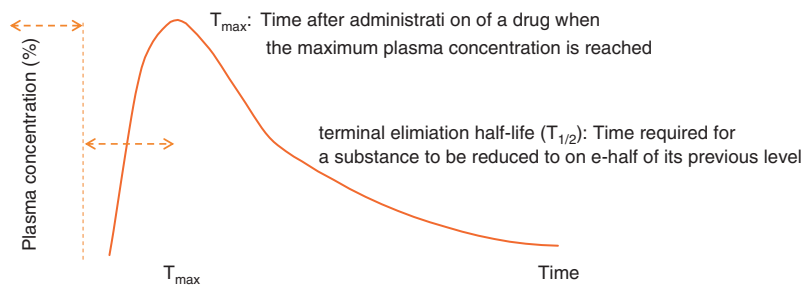

Fig. 16.10 Pharmacokinetics of available phosphodiesterase inhibitors (Klotz et al. 2002*, Viagra product monograph**, Patterson et al. 2002***)

providing adequate stimulation is present (Blount et al. 2004; Del Popolo et al. 2002; Seftel 2004).

It has proved especially important to advise the patient specifically about the necessity for adequate stimulation, as the occurrence of an adequate erection does not represent an automatic process induced solely pharmacologically, as is the case in cavernosal self-injection therapy. This is often also of particular importance for the partner, as the necessity for stimulation stresses the importance of her role and reduces worries concerning increased libido independent of the person. This offers the therapist the possibility of pointing out the importance of communication within a partnership that is burdened by the existence of ED, and possibly laying the groundwork for successful therapy (see also Chap. 26). Recent studies have convincingly argued that the male's ED negatively influences both partners' sexuality and that successful treatment has a significantly positive effect on the couple's sexuality and partnership. Not only the individual life quality of patient and partner but that of the couple is significantly improved and in many cases, a level of shared sexual satisfaction can be achieved comparable to that prior to the development of ED (Ralph et al. 2007; Rosen et al. 2007).

In general, PDE-5 inhibitors display excellent effectiveness in erectile dysfunction of various etiologies. It achieves success rates of up to 80% in patients with organically caused dysfunction, and more in patients with predominantly psychologically caused disturbances. Their effectiveness is excellent in patients whose ED results from vascular disturbances due to various pathologies such as arterial hypertension, lipid metabolism or diabetes with predominant angiopathy. The prerequisite is intact neuronal induction of erection via the Nn. cavernosi. Clearly more negative results are to be expected in diabetes patients and those with latent or manifest polyneuropathy in whom signal transduction is disturbed by the neuropathy and in whom impoverished peripheral transmittal occurs in the course of the disease. Nor is it surprising that success rates of over 80% are reached in large-scale studies in paraplegic patients with intact reflexes (Del Popolo et al. 2004).

The *therapeutic dose* required depends on the etiology of the underlying ED. Since generally doses of 25–50 mg (sildenafil) or 5–10 mg (vardenafil, tadalafil) are entirely adequate in cases of psychogenic ED, in organic causes the dose can be increased up to 100 mg (sildenafil) or 20 mg (vardenafil, tadalafil). The therapeutically effective plasma concentrations and

concomitant duration increase with higher doses. Clinically this correlates in part with a certain increase of the time in which an erection can be induced. In contrast, the effectiveness of the substance can only be increased by about 10% per dose stage. Often increased dosage is also accompanied by an increase of side effects. As in other therapy modalities, stepwise dose-finding and adjustment are advised to avoid unnecessary side effects.

The occurrence of such side effects, the varying effectiveness of the drugs at first use, and the exceptionally high expectations on the part of both patient and partner after long-term disturbed erectile function make the first visit particularly important. At this checkup the effectiveness of the medication, the occurrence and intensity of side effects should be registered in order to make individual dose adjustments. Only 60% of patients experience satisfactory intercourse after the initial dose and achieve full effectiveness only after 2–4 applications. This is the reason why some therapists deliberately use high doses initially despite the possibility of side effects in order to achieve early optimal treatment success. Other therapists start with lower doses in order to accustom the patients to the particularities of PDE-5 inhibitors and to relieve the patients of initial fears.

Regardless of the strategy chosen, renewed consultation is required especially when initial attempts show inadequate effectivity. Intensified counselling is required concerning details of tablet use (food and alcohol consumption, timing of tablet use and sexual activity depending on substance used), and the required sexual stimulation (“**re-counselling**”). This evaluation of therapy and renewed counselling are of decisive importance for the success of therapy as about 60% of patients discontinue therapy after two unsuccessful attempts (Valiquette et al. 2008).

In general most patients use PDE-5 inhibitors as on-demand medication. This corresponds to the particular nature of the symptoms but takes into account the lack of reimbursement by insurances. Often after successful initiation of treatment the dose can be reduced, on the other hand, genuine, organically induced improvement of erectile quality after a 6-month treatment period cannot be observed with use of PDE-5 inhibitors (Zumbé et al. 2008), as occasionally can be seen by histologically evidenced hypertrophy of smooth musculature after injection therapy. Effectiveness of the substances is good even after years of use, tachyphylaxis has not been observed for any of them.

Daily application of longacting tadalafil (Cialis®) at a dose of 5 mg is an alternative for patients regularly taking two tablets or more per week. Despite the low single dose (and concomitant few side effects), its long half-life and resulting accumulation achieve therapeutically adequate levels. The patient has the advantage of the same financial burden achieving continuous effectiveness and quasi restoration of normal erectile capability (Porst et al. 2008; Rajfer et al. 2007). To what extent this is of psychological advantage to the patient and whether quality of life is influenced by this drug regimen as opposed to on-demand therapy is unclear. It must be stressed that daily administration is possible and licensed for all substances, even if the advantage of continuous serum levels due to shorter half-life is lost, which may be less important if tablets are taken in the evening.

For so-called **non-responders** undergoing primary therapy re-counselling, increased dosage to maximal therapeutic levels and repeated application within a narrow timeframe, PDE-5 inhibitors can achieve adequate effectiveness in about half the patients. The patient can be classified as a non-responder only after at least 8–10 attempts with repeated applications of the maximum therapeutic dose which fail to allow successful intercourse. In these cases **further diagnostic steps** should be taken. At this point at the very latest, serum *testosterone* should be measured in order to exclude any relevant deficiency. In such a case or when values are in the lower normal range simultaneously accompanied by clinical symptoms, substitution must follow, as often this also clearly improves the effectiveness of PDE-5 inhibitors (Behre 2004).

A further possibility in such cases is the **regular daily use of PDE-5 inhibitors** at low doses (usually 1/4 of the maximal dose). By conditioning the corpora cavernosa some of the patients may yet achieve effectiveness of the substances with additional on-demand use of maximal therapeutic doses. After exhausting these possibilities, in individual cases a combination of various therapy options such as PDE-5 inhibitors/ vacuum system or PDE-5 inhibitor/ self-injection therapy remain. Sooner or later all these options fail in most patients because they are not reimbursed by insurers so that, aside from the exclusive use of vacuum systems, only implantation of cavernosa prostheses remains as a therapeutic option.

A special indication for regular use of PDE-5 inhibitors is **penile rehabilitation** after radical pelvic

surgery, especially after radical prostatectomy or cystoprostatectomy (Briganti et al. 2007). In recent years it was increasingly heralded as first-line therapy, after a significant improvement of erectile capability with application of intracavernosal prostaglandin E1 1 year after surgery had been described (Montorsi et al. 1997; Mulhull et al. 2005). So too, regular evening application of low-dose substances (one fourth the maximal dose) also seemed to contribute to more rapid and more complete restitution of erectile capability. The basic idea underlying this procedure is to prevent fibrosis and inactivity atrophy by regular nightly oxygenation of the smooth corpora cavernosa musculature, and thus maintain the functional capacity of the cavernous body (Bannowsky et al. 2008). Different experimental and clinical data seem to support such a concept. The recommended duration of treatment is between 3 and 18 months. According to the literature, the effectiveness of the substances is up to over 90% given the prerequisite of optimal surgical techniques with bilateral preservation of the neurovascular bundle which is not realizable in all patients in view of the oncological situation. Moreover, postoperative erectile capability not only largely depends on the quality of nerve protection but especially on the patient's age and presurgical erectile function. Most recent results from studies have raised considerable doubts whether at least daily use of PDE-5 inhibitors, as opposed to on-demand treatment, offers a reproducible treatment advantage. Thus it seems that, over a 10-month postoperative study period, on-demand therapy following surgery employing a bilateral nerve-protective technique does not produce worse results than daily application of a mean therapeutic dose (Montorsi et al. 2008).

These results confirm that even with regular use and only moderate organic failure, none of the available substances are able to restore erectile capability. Thus independent of treatment duration, after discontinuation of therapy worsening of symptoms to previous levels occurs spontaneously within a few weeks (Zumbé et al. 2008).

Thus daily practice of penile rehabilitation by regular daily application of any PDE-5 inhibitor represents a concept requiring further testing before safe use for the patient can be postulated.

At the present time on-demand therapy seems advisable, in which clinical effectiveness by means of individually adapted doses can be continued as long as the patient deems necessary. If such treatment proves ineffective during the early postoperative phase, this may be a result of a continuing postoperative neuropraxis and can only be evaluated after 12–18 months. In the event of lack of response the patient should be put on intermittent self-injection therapy in order to prevent inactivity atrophy of smooth cavernosal musculature. After 6 and 12 months oral therapy with a PDE-5 inhibitor at maximal dose should be reattempted. With preserved neurovascular tissue, clear improvement has often been observed thereafter (Mulhull and Simmons 2007).

The **spectrum of side effects of PDE-5 inhibitors** results from the effect of phosphodiesterase on other parts of the body and from interaction with other phosphodiesterase isoenzymes. As phosphodiesterase type 5 occurs in relatively high concentrations in vessels of the nasal cavity and the central nervous system, **flu-like symptoms with slight headache, nasal congestion and flushed face** can frequently occur. Slight **gastrointestinal complaints** are not unusual. Effect on **blood pressure** is slight, with a decrease of systolic and diastolic pressure. Interaction with phosphodiesterase type 6 of the retina leads to **disturbed color perception** with slight blue/green shifts, **increased light sensitivity** and **blurred vision**. This side effect, which only occurs with sildenafil, is especially dose-dependent and occurs in only ca. 2% of cases at a dose of 50 mg. At 100 mg 11% report these effects; when raised to 200 mg side effects increased to 40%. On the basis of clinical and experimental data it is assumed that these accompanying effects are no cause for concern. **In patients with retinitis pigmentosa, a genetic defect of the phosphodiesterases in the retina, sildenafil should not be prescribed. The use of the other PDE-5 inhibitors is unobjectionable** (Hellstrom 2007). Nor is there any causal connection between the use of PDE-5 inhibitors and **NAION (nonarteritic anterior ischemic optic neuropathy)**, as has been discussed in recent years. NAION is the most frequent acute disease of the N. opticus which occurs often in patients with risk factors also causing ED (hypertension, diabetes, hypercholesterinemia and nicotine abuse) (Gorkin et al. 2006).

As sildenafil was developed primarily as a medication for angina pectoris and as an alternative to nitrate

therapy, the PDE5 inhibitors carry only few cardiovascular risks. As a general rule, the moderate decrease in blood pressure of 5–10 mmHg is clinically insignificant. Experience to date with **hypertensive patients and antihypertensive medication** shows unchanged effectiveness of the substance when compared with other patient populations. Cardiac side effects are not to be expected as phosphodiesterase type 5 is not active in the heart itself, so that contractability and pulse frequency are not influenced. Recent investigations show that the side effect profile with antihypertensive mono- or combined therapy with up to three antihypertensive medications is not altered (Kloner 1999; Pickering et al. 2004; van Ahlen et al. 2005). Conversely, PDE-5 inhibitors are contraindicated with simultaneous use of nitrates or NO medication. This derives from the substances' mode of action, as nitrates and NO donors affect the same target in vessel musculature, i.e., cGMP. While nitrates and molsidomine clearly increase intracellular concentrations of cGMP, metabolism is inhibited by PDE-5 inhibitors, which may lead to a potentiation of nitrates and NO donors in the circulation. While studies with all substances and simultaneous application of nitrates and PDE-5 inhibitors failed to show any serious changes in blood pressure, it cannot be excluded that in individual cases blood pressure can fall by as much as 40–50 mmHg and thus trigger longlasting syncope-like conditions.

For this reason **therapy with PDE-5 inhibitors is strictly contraindicated in patients under nitrate or NO therapy**. As more than 100 different nitrate and NO preparations are currently available, a detailed drug anamnesis is absolutely necessary prior to PDE-5 inhibitor therapy. Conversely, a patient receiving a nitrate preparation must be prohibited from taking PDE-5 inhibitors. In cardiovascular emergencies the patient must be asked about possible previous PDE-5 inhibitor use. Nitrates may not be applied until 24 h at the earliest after taking vardenafil and sildenafil; for tadalafil 72 h at the earliest is required.

Similar data document that, contrary to early assumptions, the use of PDE-5 inhibitors does not lead to a higher frequency of myocardial infarctions.

Contrary to initial concerns, a retrospective analysis of 80 clinical studies impressively demonstrated that the rate of severe cardiovascular events was not higher in patients using Viagra than in those using placebo (Mittleman et al. 2005). Similar data are available for the other PDE-5 inhibitors which clearly show that, contrary to initial assumptions, they do not lead to higher occurrence of infarction and that the substances are safe (Kloner and Speakman 2002; Kloner et al. 2006; Jackson et al. 2006a; Robert et al. 2002).

As performing sexual intercourse involves no higher exertion (average of 3–4 metabolic units [METs]) than other daily activities such as brisk walking or moderate gardening, the treatment of erectile dysfunction, regardless of the therapy modality, does not represent an incalculable risk. A consensus recently published by British experts pointed out that **for patients with low cardiovascular risk** (controlled blood pressure, slight stable angina pectoris, coronary heart disease following successful revascularization by stent and bypass), no additional cardiological investigations are necessary. In **moderate cardiovascular risk** (several risk factors, latent cardiac insufficiency [stage I or II, NYHA] moderately severe angina pectoris) cardiological diagnosis should be performed by stress ECG. A peak load of 150 W or more with no sign of coronary ischemia presents no cardiological contraindication to erectile dysfunction therapy, regardless of the modality (Kostis et al. 2005).

For **patients with high risk** (unstable angina pectoris, decompensated cardiac insufficiency, uncontrolled hypertension) erectile dysfunction therapy should not be carried out until the cardiac condition has been stabilized (Jackson et al. 2006b; Kostis et al. 2005).

In summary, the introduction of modern orally effective medication has produced a dramatic change in the therapeutic possibilities for erectile dysfunction and has led to a new **stepwise therapeutic plan** (Fig. 16.11). The effectiveness and therapeutic safety of the available oral substances and those under development is very high. Today successful oral treatment of a broad spectrum of psychogenic and organic erectile dysfunction is possible. At the present time PDE-5 inhibitors represent by far the most effective oral class of substances comparable to self-injection therapy. Because of its specific mode of action and the unavoidable contraindications, oral therapy will not, however, completely replace other treatment forms.

16.2.6.5 External Devices

The principle of **venous restriction by compression** at the base of the penis has long been known. Different commercially available rings have been designed to

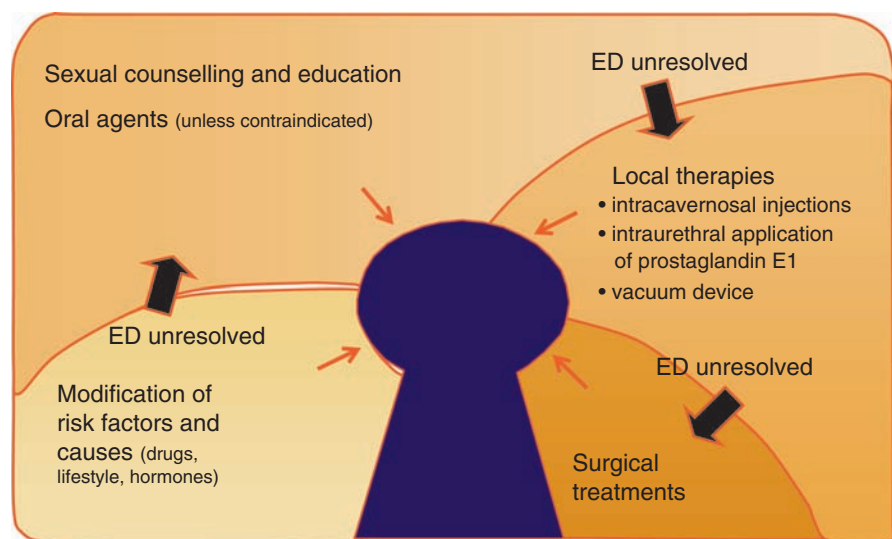

Fig. 16.11 Therapy scheme according to WHO (Jardin et al. 2000)

reduce venous drainage at the penis basis and to facilitate erection. These rings are only beneficial in patients with intact arterial perfusion, mostly young patients with primary erectile dysfunction. Since many cases of cavernosal insufficiency and incompressible cavernosal occlusion mechanism are combined with pronounced impairment of arterial perfusion and secondary degeneration of the smooth musculature, the use of penis rings is very limited as a monotherapy.

External vacuum devices have been successfully used for many years. The various available systems differ mainly in respect to a pump mechanism and the design of the restriction **rings** and bands. The devices consist of a plastic cylinder which is placed over the penis. A vacuum is established in the cylinder with a manual or battery power pump which leads to increasing engorgement of the penis, and to a state very similar to a physiological erection. To prevent premature drainage of blood from the corpora cavernosa and therefore to allow sexual intercourse, a penile ring or restricting rubber band is placed at the penis base after full tumescence has been achieved (Fig. 16.12).

While erection rings are only applicable in patients with adequate arterial perfusion, vacuum pumps can be used universally in patients with any kind of erectile dysfunction. In the majority of these patients, vacuum devices will be able to induce a sufficient erection and rigidity to allow intercourse. This includes patients with severe vascular problems. There may be a limited efficacy of vacuum systems in patients with pronounced intercavernosal scarring, which may be present after

long-term priapisms or after explantation of infected prostheses. In Peyronie's disease with severe angulation of the penis the use of vacuum devices may sometimes be impossible for purely mechanical reasons.

The main advantages of vacuum systems are that they are practically free of side effects, even in long-term treatment. The induced erection, however, is distinguishably different from the normal physiological erection. In general the quality of the erection with respect to rigidity is not always completely satisfying: while in a normal erection only the corpora cavernosa will show enlargement, the entire penile tissue will show a venous enlargement distal to the restriction ring when a vacuum pump is used. This can lead to **petechial bleeding** and **ecchymoses** of the penile skin with subjective **sensations of coldness** and **numbness**. Additionally, **edemas** can be observed in some patients. For these reasons, manufacturers of the vacuum systems usually instruct the patients **not to use the restricting bands or rings for more than 30 min**.

Another typical problem with the use of vacuum devices is insufficient rigidity in the corpora cavernosa proximal to the restricting band which may lead to severe instability at the base of the penis. Ejaculatory problems are not infrequent. They can be caused by mechanical compression of the urethra, but functional causes due to insufficient precoital stimulation are also very common.

The acceptance of vacuum systems varies considerably and is cited as reaching 85% in American investigations (Cookson and Nadig 1993). In Germany

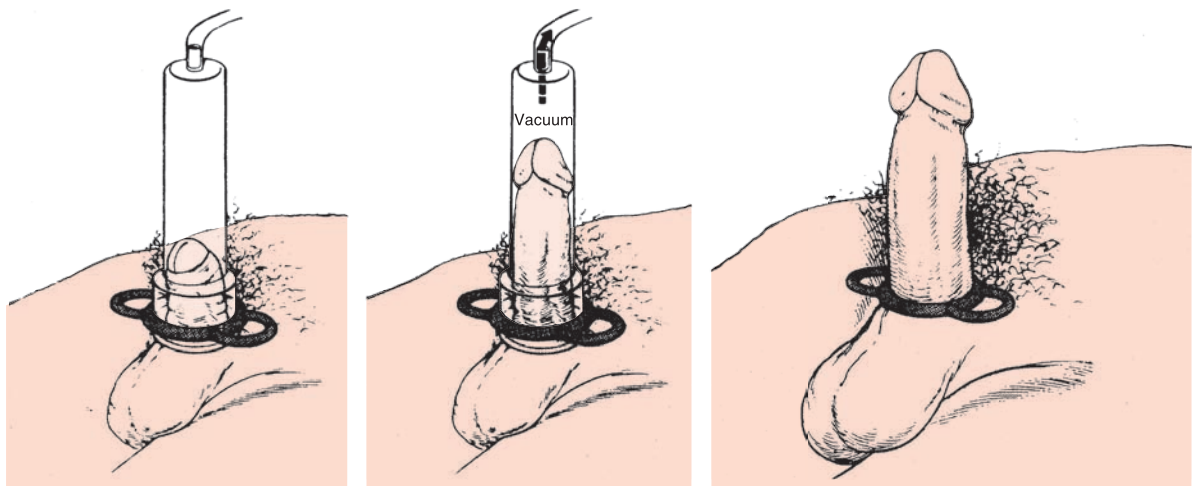

Fig. 16.12 Principle of vacuum devices (With kind permission of the Osbon Company)

acceptance is considerably less and strongly dependent on whether the patients respond to other forms of therapy (Derouet and Zehl 1990). For patients for whom oral or injection therapy is insufficient, the vacuum pump is the much more attractive alternative to venous or implant surgery. Younger patients especially will often refuse vacuum systems owing to their technical aspects and limitations of integrating it into their personal sexuality. In older patients with longstanding partnerships, with slow progressive or postoperative erectile dysfunction, the acceptance of vacuum devices is usually much better. Patients who have adopted this therapy often show better compliance in long term use than patients undergoing injection therapy or taking oral pharmacological medication. Among the reasons for terminating the use of vacuum devices is often the loss of "cosmetic" acceptance, mostly by the patient himself rather than by the partner, insufficient efficacy of the vacuum system concerning rigidity, recurrent pain and subcutaneous hematomas or waning interest in sexual activity.

Particularly in recent times vacuum systems have undergone a renaissance for the treatment of postoperative disturbed erection and IPP. Different studies have shown that regular use of a vacuum system can avoid or at least lessen frequent postsurgical penile retraction following inactivity atrophy of the smooth cavernosal musculature. Admittedly the venous stasis caused by congestion contradicts the concept of arterial oxygenation of the tissue. In IPP regular stretching of the cavernosa can achieve preservation of erectability and, in some cases, reduction of the deviation.

16.2.6.6 Self-injection Therapy

Even during the age of highly effective oral pharmacological therapy with PDE-5 inhibitors, intracavernosal application of vasoactive substances represents a relevant option, not only for diagnostic purposes, but also for therapy. Even today it is the second most important therapeutic option in organic erectile dysfunction. Injection therapy can be offered to all patients, especially those with normal or pathological arterial inflow but with intact cavernosal occlusion mechanism. Patients with neurogenic disturbances are especially suited for this type of treatment since on the one hand, causal therapy is not available, and on the other hand, because PDE-5 inhibitors are limited by their

mechanism of action and their effectiveness strongly depends on the extent of nerve damage. Candidate patients are those with postoperative erectile disturbances due to lesions of the autonomous cavernosal innervation caused by radical pelvic surgery or those with diabetes mellitus with severe polyneuropathy. Especially during the early postoperative phase with morphologically intact penile and cavernosal tissue and a normal circulatory situation, only very small doses of vasoactive substances are needed to induce sufficient erections. With increasingly disturbed perfusion and resulting morphological alterations, i.e., atrophy or fibrosis of the cavernosal musculature, self-injection therapy will become limited and the dose must be increased. The use of a vacuum device can be an excellent alternative; primary implantation of penile protheses is usually refused by the often still relatively young patients. In the meantime oral PDE-5 inhibitor treatment has become standard therapy and has largely replaced injection therapy for patients whose ED is of arterial origin because it is much less invasive and provides excellent and equivalent effectiveness. Delayed onset of action is typical.

Also for patients with mainly psychogenic functional erectile dysfunction, injection therapy as well as the use of orally effective substances can be very useful adjuvant options, accompanying psychologically oriented treatment. In these patients injection therapy can show a beneficial effect on the overall outcome and may reduce duration of treatment significantly. Such additional treatment will give the patient greater security, and will help to reduce fear of failure, especially in patients with refractory or longstanding psychogenic disturbances. Such a strategy can, however, be problematic for psychological reasons and close consensus between the physicians involved is particularly necessary in these patients. Patients without demonstrable organic deficits have to be clearly alerted to potential complications and side-effects of injection therapy. Not least because of these drawbacks has oral therapy largely displaced injection therapy as an adjuvant measure.

Patients with cavernosal insufficiency are unsuited to injection therapy because, owing to the underlying pathophysiological mechanism, they will not react adequately or at all to the injection of vasoactive substances nor to PDE-5 inhibitors. If invasive surgical options are refused, the application of a vacuum system or the combination of various therapy forms

(PDE-5 inhibitors/self-injection/penis ring) can be considered.

From the medical point of view, autoinjection therapy appears to be suitable for the majority of patients with organic causes of erectile dysfunction. However, certain criteria should be fulfilled:

- Adequate patient selection
- Cooperative, reliable patient
- Adequate follow-up
- Experience in dealing with possible side-effects

Autoinjection therapy should only be offered to patients with a current sexual partner and who, apart from their proven organic origin of erectile dysfunction, have proved to have sufficient manual dexterity and intellectual capability. In physically handicapped patients with reduced vision or extreme adipositas the patient will not be able to perform controlled injections himself. The indication must be reevaluated. In these cases, application of the vasoactive substance by the partner can be discussed. In all patients regular follow-up is mandatory due to possible severe side effects of this medication. The physician himself should be experienced in the treatment of acute complications like priapism, and close cooperation with a local hospital department for these rare circumstances is usually advisable.

The contraindications for autoinjection are similar to those that apply to the diagnostic use of vasoactive substances:

- Decompensated cardiac and circulatory insufficiency
- Intellectual incompetence
- Lacking compliance
- Severe psychiatric disorder
- Sexual deviation

Many authors will regard this kind of therapy as not indicated in patients without an existing partnership or with sexually transmitted diseases. These questions, especially whether an HIV patient with erectile dysfunction for whom the vacuum system and other

non-invasive therapeutic options have proven inadequate, or were refused by the patient, can and should be treated with intracavernosal injections, certainly have to be decided on an individual basis. Anticoagulant medication such as cumarin or aspirin does not represent a contraindication since an increased complication rate can be excluded in this often well-motivated and disciplined patient population if adequate compression at the site of injection is guaranteed.

The injection technique is equivalent to that when applying vasoactive substances as a diagnostic procedure. The whole length of the penis can be used and the patient should be instructed to change injection sites. This may reduce the risk of plaque formation at the tunica albuginea or the formation of localized corporal fibrosis.

Principally, two different forms of injection therapy are possible and have become established:

In **periodic interval therapy** the vasoactive substance is injected at fixed intervals by the physician or the patient himself in a previously tested dose. The application interval is usually 1–2 weeks. For this kind of application patients with residual erectile function and only a minor reduction of arterial perfusion are suitable. Patients with psychogenic impotence also often show marked improvement of the symptoms with increased activity of the smooth muscle cells even in the treatment-free interval. This effect has not been demonstrated for oral substances.

In **cavernosal autoinjection therapy** the patient injects the vasoactive substances himself at home, according to his own demand. This therapy is especially suitable for patients with neurogenic or other severe organic erectile dysfunction, especially patients with diabetes mellitus or post-surgical erectile dysfunction. Informed written consent about potential hazards and complications of the treatment is mandatory and intensive pretreatment instructions on the preparation of the substances and the use of the injections is essential. As soon as the patient masters these tasks he can be integrated into an autoinjection programme with a recommended fixed dose and application interval. Regular routine follow-up visits should also be carried out.

The dosage of the vasoactive substances is dependent on their efficacy. An erection duration of 30–60 min is advisable and sufficient. As in the case of diagnostic use of vasoactive substances, dosage will be increased in small steps after initial testing to

evaluate the correct therapeutic dose with a minimal risk of priapism. Often the reaction to a defined drug dose is much better under home conditions, so that in many cases the dose can be reduced by up to 30%. On the one hand, this results from stabilization and other accompanying psychological effects caused by positive experiences following injection therapy. On the other hand, it is probably due to better compliance of the cavernosal vessels and smooth muscle cells. Moreover, with injection just prior to intercourse an additive effect of pharmacological stimulation and sexually induced androgen neurotransmitter release occurs.

Autoinjection therapy requires great patient discipline concerning constant dosage and application interval. In cases where an injection does not produce an adequate erection a second injection on the same day should be strictly avoided because of the danger of prolonged erection and priapism. With reliable patients the incidence of priapism, which formerly occurred with the use of papaverin/phentolamine in up to 10% of cases even with careful patient selection, will not pose a major problem during long-term therapy (Porst and Weller 1989). Nevertheless, patients should be thoroughly informed about the possibility and potential hazards of such drug-induced priapism. Under PGE₁ prolonged erections usually subside spontaneously due to the short half-life of the substance and local metabolism so that the risk of priapism is less than 0.5% even in the diagnostic area (van Ahlen et al. 1994).

The worst long-term complication of autoinjection therapy is localized or generalized fibrosis of

the corpora cavernosa. The main cause of local fibrosis may be the recurrent microtrauma by the needle at the injection site, resorption of small local hematomas or toxic reactions, often seen in erections of long duration due to relative overdosing of the vasoactive substance. The formation of small nodules is clinically without consequences in most cases. During a 3-month treatment pause these changes are usually completely reversible. In severe fibrosis of the tunica albuginea or with a localized intracavernosal scarring with insufficient cavernosal relaxation capability penile deviation can ensue. The worst complication is generalized fibrosis of the corpora cavernosa due to chronic use. Such fibroses are reversible only in about half the patients, even if therapy is stopped immediately (Fig. 16.13). Animal experiments have shown that the incidence of such fibroses varies, but can occur with all vasoactive substances. Histologically, the initial alterations are seen in a pronounced hypertrophy of the smooth muscle cell, later converting to increased intracellular filaments and considerable intracavernosal fibrosis. The incidence of such an event is especially high with papaverine, because of which the substance is no longer used. A combination of papaverine with phentolamine seems to be tolerated much better, as is PGE₁. The hypothesis that the low pH of papaverine (pH 2.7) might be the main reason for scarring of the cavernosal tissue has been ruled out on the basis of blood gas analysis and systematic investigations on the use of solutions with different osmolarity and pH. Probably toxicity specific to the various substances is responsible.

Apart from substance-specific differences there is a clearcut correlation between these toxic fibroses and the

Fig. 16.13 Cavernosal fibrosis after autoinjection therapy. (a) Extensive local fibrosis with a filling defect in cavernosography; clinically palpable induration and penile angulation. (b) Diffuse fibrosis with a lateral filling defect in the midportion of the corpora (*arrow*) as well as a marked narrowing of the distal corporal tips (*arrow*). Marked pathological venous outflow with clinical signs of cavernosal insufficiency

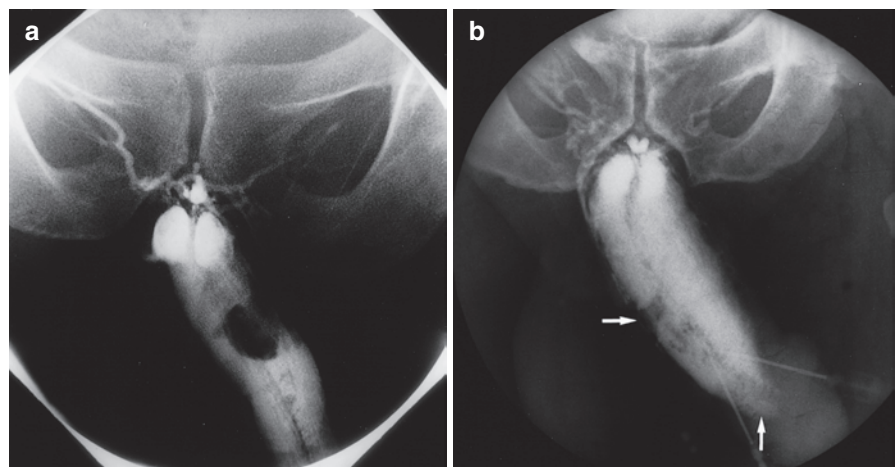

frequency and duration of intracavernosal injections. Therefore the patient should be advised to limit the number of injections to two per week regardless of the vasoactive substance used. The necessity of increasing the dosage of a given drug in injection therapy does not indicate tachyphylaxis of the substance used, but is usually accompanied by deterioration of the cavernosal tissue or the pre-existing disturbance.

In the past this treatment was well accepted by the patient and his partner. Only approximately 20% of potential users refused this kind of therapy because they did not approve of intracavernosal injections. Dropout rates under therapy amount to about 30–50% and are thus absolutely comparable to oral pharmacological therapy. It is astonishing that most patients reacting equally well to autoinjection and oral phosphodiesterase inhibitors display significantly higher patient satisfaction with autoinjection than with oral therapy (Mulhull and Simmons 2007). In most cases drop-outs for all treatment modalities are due to increasing loss of sexual interest for various reasons.

The exceedingly rare but potentially hazardous complications of autoinjection therapy make a multifactorial organic diagnostic work-up mandatory before therapeutic application of vasoactive drugs. The indication should therefore be evaluated very carefully and all requirements concerning informed consent must be fulfilled. All potential patients should be thoroughly informed in writing about possible complications, especially infections and progressive iatrogenic deterioration of the corporal tissue with consecutive fibrosis and complete loss of erectile capability. Regular follow-up examinations are mandatory.

Even if the introduction of orally effective substances has by nature led to a general change in the relative acceptance of the method, autoinjection therapy still represents an essential option in erectile dysfunction. It is technically uncomplicated and can be rapidly learned by the patient. The main advantage is wide reaching stimulation of the normal physiologic erection with a maximum of therapeutically achievable rigidity. After injection of the vasoactive substance an erection sufficient for intercourse is induced after a short latency period. With correct dosage this erection regresses spontaneously after ejaculation.

It has proven effective to start patients with only slight perfusion disturbances and/or severe psychogenic symptoms on interval therapy. Increased arterial perfusion will often lead to an improved condition of

the corporal tissue or will improve the sensitivity of spontaneous erections even in the injection-free interval. Not infrequently these patients will even observe complete normalization of erectile capability and anamnestic and physical findings will have improved after 8–10 injections so that further treatment is not necessary. If this improvement does not occur and the patient continues to be dependent on vasoactive substances, he may be enrolled in a self-injection programme. Patients with neurogenic erectile dysfunction or who have severely disturbed arterial perfusion should be directly treated by self-injection therapy.

In certain patient populations (diabetes mellitus, postsurgical dysfunction) cavernosal self-injection will certainly continue to be important, since up to 90% of the patients can be helped when all methods are applied. Moreover, in principle in severe organically caused cases various oral and vasoactive substances can be combined, even if, in the majority of cases, this exceeds the patients' financial possibilities (Brock et al. 2001).

16.2.6.7 Surgical Treatment

Even if non-invasive therapeutic forms available today offer very effective treatment options, a large number of patients would prefer surgical correction of organic factors to regain undisturbed sexuality free from the use of any auxiliary measures. This understandable desire on the part of the patient can justify surgical measures even when other, less invasive therapeutic options are generally available. Only surgery on the penile vessel offers the patient the possibility of reachieving physiological erections without acute intervention. Here proven organic deficits are a basic requirement for the indication of any kind of surgical therapy. Surgical possibilities can be classified into separate operations on the venous system in patients with increased venous drainage of the corpora cavernosa, into reconstructive vascular surgery in cases of arterial disease and into prosthetic implants in patients with otherwise untreatable erectile dysfunction and specific indications. Although since the introduction of orally effective substances, indications for surgery have further decreased and, for practical purposes, no longer play any role except for prosthetic implantation, the underlying considerations shall be discussed here.

Venous Surgery

Typically patients with cavernosal insufficiency will react adequate to drug as well as to injection therapy, nor will vacuum devices be successful in all patients.

The basic principle of all surgical procedures is to increase the venous drainage resistance. Patients with congenital primary erectile dysfunction due to an ectopic vein are especially good candidates for this type of surgery. Simple surgical resection of this vessel leads to correction of the underlying cause and will abolish the clinical symptoms. Similar success may be achieved in the very rare cases of penile fracture with a fistula with secondary communication between the corpus cavernosum and the corpus spongiosum. Here, spongiosis with closure of the fistula may treat this problem causally.

In all other patients surgical strategy will consist of a radical resection of all accessible drainage pathways that have previously been documented by pharmacocavernosography. In most cases, the superficial and deep dorsal veins are resected with ligation of all circumflex veins at the penile base. The operation is simple and serious complications are practically never observed. With success rates of 25%, long-term results are poor. Severity of leaks documented by cavernosometry and cavernosography show no correlation with results of interventions (Kim and McVary 1995b).

Thus as a rule venous surgery remains a symptomatic therapy and does not abolish the underlying pathomechanism of insufficient venous occlusion on the cavernosal level and the tunica albuginea and thus the cause of the clinical symptoms. Even after successful surgical resection of the deferent veins long term formation of new collateral vessels is preordained. Nor is venous surgery promising in the face of simultaneous severely disturbed arterial perfusion, which is usual, and cavernosal insufficiency.

A completely different approach is the arterialization of the deep dorsal vein. This procedure was first inaugurated by Virag for the vascularization of arterial disturbances. It is supposed to increase blood flow to the penis and the corpora cavernosa itself and significantly increase the drainage resistance in the venous system (Virag et al. 1981). Whether this concept, requiring much greater surgical effort, will lead to an improvement of postoperative success rates has never been verified since controlled studies are lacking (see also "Revascularization Surgery" below).

Although venous surgery has lost its previous importance during the last few years, it should not be overlooked that a few patients with primary ED who do not react adequately to other therapy will benefit from this minimal surgical procedure, especially if there is no concomitant arterial problem, as may be in the rare case of congenital ectopic veins.

Revascularization Surgery

Vascular problems are the most common cause of erectile dysfunction. It appears only logical to make any effort to increase arterial perfusion to the penile musculature in order to restore physiological erection without any auxiliary method. The main aim of all revascularization surgery is therefore optimization of corporal perfusion which may be compromised by arterial obstruction. Direct revascularization of the corpora cavernosa, in which the inferior epigastric artery is anastomosed directly to the tunica albuginea and the corpora cavernosa, suffers from an increased rate of postoperative priapisms and rapid spontaneous closure of the anastomosis. These complications result from the higher flow rates that will regularly lead to hyperplasia with consecutive fibrosis and secondary shunt obstruction and from the poor blood outlet into the corpora cavernosa itself. For an anastomosis between the inferior epigastric artery and the dorsal penile artery a free vascular lumen at the bifurcation of the A. penis is necessary. This allows increased perfusion in the cavernosal artery via a retrograde perfusion of the dorsal penile artery. In cases of bilateral obstruction of the cavernosal artery, arterialization of the deeper dorsal vein is an alternative. It is supposed to increase blood flow to the corpora cavernosa by retrograde perfusion of the emissary veins. These surgical techniques are said to have success rates between 20% and 50%.

The most recent commonly used surgical method is an anastomosis of three vessels (between the inferior epigastric artery, dorsal artery and deep dorsal vein), which combines the principles of the previously mentioned procedures (Hauri 1984). The arterio-venous fistula leads to a decrease in outflow resistance in the arterial part of the anastomosis and results in a considerable increase in flow rates. At the same time this three-vessel anastomosis leads to increased resistance in the venous part. The success rate of this operation is

between 30% and 70%. The main complication is a glans hyperemia which can be seen in up to 20% of the patients. This results from increased arterial perfusion of the glans, can occur up to 2 years after the operation and is clinically associated with congestion edema, meatal stenosis and necrosis, in severe cases, even with glans necrosis. The symptoms can be so pronounced that a distal subcoronal ligature of all superficial veins will not be sufficient and closure of the arterio-venous fistula will be necessary.

Up to very recently, indications for revascularization surgery continued to be unclear. For many years no coherent opinion emerged whether the operation should be performed in patients with cavernosal insufficiency, metabolic disorders such as diabetes mellitus or post-traumatic erectile dysfunction. Especially in posttraumatic ED following straddle trauma neurogenic disturbances may often occur which are clinically relevant even if they cannot be demonstrated by quantification techniques, which make surgery seem highly questionable.

MRT evidence indicates that revascularization surgery in its various modifications does not lead to an effective increase in perfusion of the corpora cavernosa itself. This pathophysiological background makes all kinds of reconstructive operations questionable (Sohn et al. 1992). Very possibly time-consuming penile revascularization is indicated only in patients in whom a pronounced decrease in arterial perfusion can be documented and collaterals between the superficial and deep penile arteries can be demonstrated (Wegner et al. 1995).

The uncertain pathophysiological mechanism leading to largely disappointing surgical results as well as the sometimes considerable complications of the various methods have greatly reduced the optimism initially associated with this therapeutic option and caused it to play only a minor role at present.

Prosthesis Surgery

In the USA prosthesis surgery is offered independently of the pathogenesis of erectile dysfunction as a primary therapeutic option and is well accepted by patients. In Germany, **it represents the final therapeutic option.**

In most instances, it is offered to patients who do not or no longer react adequately to other forms of

therapy or who absolutely refuse them. In vascular disturbances oral medication or autoinjection therapy has usually been attempted. In neurogenic erectile dysfunction the application of vasoactive drugs may have induced recurrent priapisms with consecutive cavernosal fibrosis. In a small number of patients, the development of a retracting penis makes the use of condoms extremely difficult. For such patients a penile implant may be indicated. Another indication may be erectile dysfunction after radical tumor surgery in the pelvis. In the vast majority of cases, the indication for a penile implant is cavernosal insufficiency failing to respond to therapy.

Modern prosthetic surgery goes back to the fundamental developments by Scott et al. (1973) and Small and Carrion (1975). All the different types of prosthesis available to date derive from these prototypes. Apart from semi-rigid flexible prostheses, a variety of different hydraulic implants is available (Fig. 16.14). The implantation of semi-rigid flexible prostheses is technically uncomplicated and due to their simple construction, mechanical problems are rare. However, postoperative results are cosmetically and functionally unsatisfactory since the penis will have a constant size and tumescence at all times.

Hydraulic implants can be classified into different groups. In the single-piece prosthesis a defined, very

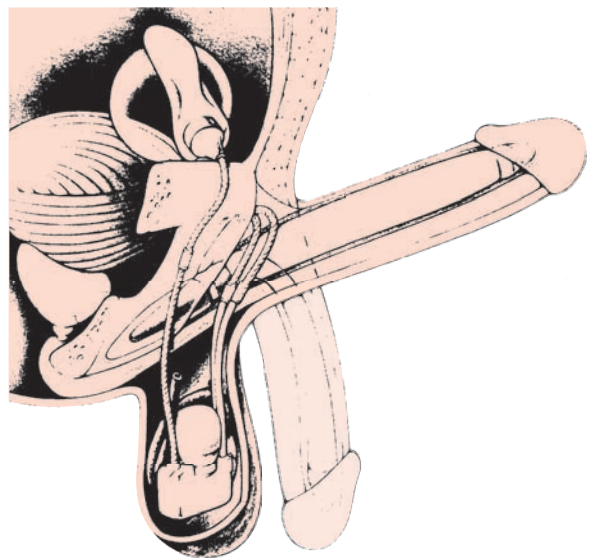

Fig. 16.14 General function of three-piece hydraulic implants in flaccid state and erection (With kind permission of AMS Pfizer Company)

small amount of fluid is transferred between an outer and inner chamber. This prosthesis allows only very limited changes in penile rigidity. The size of the penis in the activated and non-activated status is constant so that compared to semi-rigid implants cosmetic improvements are similar. In the multipiece hydraulic implants the greater transferrable fluid volume allows a considerably better cosmetic result. Here the patient himself can control tumescence and detumescence. As may be expected, two-piece prostheses in which pump and reservoir are integrated into one functional unit will give slightly inferior results, both cosmetic and functional, than three-piece models due to the relatively small transfer volume. The usual three-piece implants in general use will show an increase in diameter only with increasing rigidity due to a unidirectional dilatatory capacity. The development of bidirectional elastic materials enables a certain increase in penile length to be reached in the activated status. The major advantage of these implants is the functional principle which is very similar to the physiological erection. By means of a scrotal pump fluid is transferred from the intraperitoneal or extraperitoneal paravesical reservoir into the corpora cavernosa. Practically on demand, an enlargement of the penis which is very similar to a natural erection with an increase not only in rigidity, but also in penile growth and length can be imitated (Fig. 16.14).

For implant acceptance not only optimal longitudinal rigidity, but also sufficient flexibility in rest is the most important point. If permanent pressure on the tissue is reduced the danger of local pressure lesions with perforation of the prosthesis proximate or distally may be diminished. This risk is especially high in paraplegic patients with reduced sensitivity and trophic problems due to the underlying disease. Another typical complication, especially with semi-rigid prostheses is the so-called Concorde-phenomenon when the insufficiently perfused glans is ventrally dislocated. The increased mobility of the glans may produce significant clinical problems for the patient and increase the risk of a distal perforation.

The reliability of hydraulic implants has been significantly improved over the last 10 years so that mechanical defects rarely occur during the first 10 years (Grein et al. 1989; Wilson et al. 2006). Altogether the most serious complication in implant surgery is infection. The rate of this in primary operations will be between 2% and 4%; in revision surgery in diabetic patients it

may reach 15–20%. In most cases, normal cutaneous bacteria play a major role (*staphylococcus aureus*). Clinically, these implant infections can present with very different symptoms, late infections can manifest even months after the primary operation and not infrequently fever and leukocytosis will be a major symptom. Due to the fact that bacteria invade the silicon substance and reside within the wall of the implant, antibiotic treatment is usually not successful so that in the vast majority of such cases removal of the whole implant is necessary. Taking together major and minor postoperative complications, even in large series the rate of later revisions 5 years after primary surgery has to be judged as approximately 20–30% (Nathalie et al. 2008). Antibiotic impregnation of modern three-piece implants is a pathbreaking development which has clearly reduced infection rates in recent times (Droggin et al. 2005).

The acceptance of penile implants is very high in patients with good indications. Subjective satisfaction rates of 80–90% in both partners can be reached after longer follow-up which is astonishingly high (Nathalie et al. 2008). However, it presumes that prior to surgery both partners are extensively informed about the possibilities, but also about the limitations of such an implant. Counselling should include the fact that implantation of a penile prosthesis will not result in “normal” erections. Both partners have to be well aware of the fact that even with the new bidirectionally expandable implants, the penis will often be relatively thinner and slightly shorter than before the occurrence of erectile dysfunction. The additional gain in length made possible by new materials is clinically less spectacular than in the demonstration model. Since with all implants there is only a prosthetic augmentation of the corpora cavernosa and not of the glans, in contrast to a normal physiological erection, the glans will remain small and soft, which is sometimes experienced as a definite drawback by some patients and partners. Apart from these organic factors both partners have to be aware that a penile implant will not be able to improve or rescue an inadequate partner relationship.

16.3 Ejaculation Disorders

Ejaculation is a complex event characterized by the emission of the semen and seminal plasma, which consists mainly of seminal vesicle fluid, into the prostatic

urethra, the simultaneous closure of the bladder neck and the expulsion of the ejaculate. Emission and closure of the bladder neck are phenomena that are under sympathetic control by the thoraco-lumbar-segments TH9-L3, while the expulsion of the semen is transmitted by an involuntary reflex (S2–4) from the pudendal nerve.

16.3.1 *Anejaculation and Retrograde Ejaculation*

Disturbances of semen transportation and emission of the ejaculate i.e., **anejaculation or aspermia** have to be differentiated from transport disturbances within the urethra or **retrograde ejaculation**. Of great clinical importance are functional disturbances such as **premature ejaculation**. Apart from intact innervation with sequential contraction of the involved organs, quantitative and adequate production of seminal fluid is important for normal ejaculation. The primary absence of an ejaculation during normal orgasm points to an obstructive problem of emission and insufficient production of seminal plasma or to insufficient closure of the bladder neck with retrograde ejaculation.

In secondary loss of ejaculation a possible cause in the patient's history has to be searched for. Prostate and bladder neck surgery are typical reasons for retrograde ejaculation. Retroperitoneal lymphadenectomy for testicular cancer, pelvic surgery, an aortofemoral bypass or sympathectomies can lead to disturbances of the autonomic innervation of the bladder neck and the ductus deferens, and mainly to loss of ejaculation. Pharmacological causes (alpha blockers) and neurological diseases also have to be excluded. A spontaneous loss of ejaculation is sometimes a symptom of diabetic polyneuropathy or can be observed in secondary post-infectious obstructions of the ejaculatory duct. Any process interfering with innervation of the bladder neck and ductus deferens or the seminal vesicles can cause a loss of emission or ejaculation disturbances. Differential diagnosis can rule out androgen deficiency which would lead to insufficient production of seminal plasma and possibly to a loss of emission.

In all patients lacking ejaculation or with a very low ejaculate volume the primary question is whether there appears to be a **loss of emission** or **retrograde ejaculation**. Diagnostically **transrectal sonography** and **microscopic investigations of the postcoital or**

postmasturbatory urine are most important. Transrectal sonography will show anatomic variations in the seminal vesicles such as aplasias or ectasias with dilatations of the ductus deferens. Obstructions are possible on all levels from the vas deferens to the ejaculatory duct. The most common causes are congenital, cystic or secondary postinflammatory obstructions of the ejaculatory duct which will typically lead to dilatation of the seminal vesicle and the ductus deferens. Sonographically detectable cysts of the ejaculatory duct can be opened by transurethral resection. Patency may be determined in ambiguous cases. This should be performed with inert dyes since radiological visualization, which in the past was often carried out using contrast media, always bears the risk of secondary obstruction. The demonstration of more than 15 sperm per field in postcoital urine sediment has to be regarded as a proof of retrograde ejaculation.

Therapeutically, pharmacological treatment can be tried. This applies to patients with **retrograde ejaculation** as well as to those with **anejaculation** who may in rare cases progress to retrograde ejaculation. The therapy of choice is direct or indirect sympathomimetic substances (**Gutron**[®] 3–4 × 25–50 mg/day or the tricyclic antidepressive **imipramin** 2 × 25 g/day). The aim of this therapy is to increase adrenergic tone and to achieve a better contraction of the vas deferens and the bladder neck. The effects of this therapy can be increased if drugs are taken over a number of consecutive days (Kamischke and Nieschlag 1999). In retrograde ejaculation it is possible to retrieve sperm from postmasturbatory urine to be used for **assisted fertilization** after preparation (see Chap. 23).

In complete loss of emission, there is the possibility of **transrectal electrostimulation**. This will induce antrograde or retrograde ejaculation in the vast majority of patients. Success rates of 90% in patients with lymphadenectomy and 75% with paraplegic symptoms have been reported in the literature (Denil et al. 1992; Kamischke and Nieschlag 1999). Electro vibrator stimulation is less invasive and without the need for anesthesia, and the patient can learn to apply it himself.

16.3.2 *Premature Ejaculation*

Premature ejaculation (ejaculatio praecox) is the most frequent sexual disturbance in the male and is

characterized by the inability of the patient to control the time of ejaculation in a way that allows his partner to reach orgasm. Very often this problem is initially articulated by the female partner. There is no uniform concept concerning the pathogenesis of this disturbance and in many cases an underlying functional problem exists; other factors under discussion include decreased level of stimulation of the ejaculatory reflex, reduced sensoric genital feedback as well as potentially organic causes of prostatitis or hyperthyroidism.

In addition to the definition of premature ejaculation as expressed by Masters and Johnson (1970), is the lack of ability to control the ejaculation as well as an intravaginal ejaculatory latency time (IELT) (admittedly difficult to objectify) of ≤ 2 min, as documented in over 75% of results within a 2-week interval in most current studies (Stanley and Rowland 2008).

Today the standard therapy is still the “**squeeze technique**”, which was originally introduced by Masters and Johnson. Just prior to the onset of ejaculation, a firm squeeze in the region of the frenulum for 3–4 s will slightly reduce the erection and depress the urge for ejaculation. With increasing practice the patient will learn to control his erection and the time of ejaculation much better (Masters and Johnson 1970). The success rate of this method is reported to be approximately 95% (Lawrence and Madakasira 1992).

The use of a **local anesthesia**, in gel or aerosol form applied to the glans is widely practiced. Its disadvantages are feelings of numbness up to anorgasm, which may also occur in the partner if a condom is not used.

Better results can be reached with the use of **selective serotonin re-uptake inhibitors**. Along with **fluoxetine** (20 mg) or **chlomipramine** and **sertaline** (25–50 mg) especially **paroxetine** and **escitalopram** are effective substances (20–40 mg daily or on demand 4–6 h before intercourse) with significantly prolonged IELT compared to placebo (Colpi et al. 1991; Kim and Seo 1998; McMahon et al. 2004; Safarinejad 2007). These medications are perhaps effective due to an increase of the sensoric threshold in the genital region and this may allow better control of ejaculation. The main problem of current substances is slow perfusion so that although on-demand therapy is less effective, daily application is associated with considerable side effects. All these substances fall under the heading of “off-label” use, about which the patient must be informed

A new rapidly resorbed serotonin re-uptake inhibitor, **dapoxetine**, may be approved in the near future.

According to trial studies it shows good effectiveness with significant extension of intravaginal latency and relatively few side effects (Pryor et al. 2006). Since February 2009 the medication has been available in Sweden, Finland and Austria (trade name: Priligy) and is licensed as on-demand medication for men between 18 and 64 years at a dose of 30 or 60 mg to be taken 1 to 3 h before intercourse.

Recently (2007) grave misgivings about all serotonin re-uptake inhibitors were voiced in a warning by the FDA that the use of antidepressive medication by young men could be associated with increased suicidal tendencies (FDA 2007) Although there is no evidence in this respect for dapoxetine, no medication of this substance group should be excluded from this cautionary notice, so that particularly during the initial phase of therapy patients should be carefully monitored.

Initial results from studies also indicate effectiveness of oral opioids such as **tramadolol** given in low doses (25–50 mg) (Salem et al. 2008) (see Chap. 33).

References

- Altinkilic B, Hauck EW, Weidner W (2004) Evaluation of penile perfusion by color-coded duplex sonography in the management of erectile dysfunction. *World J Urol* 22:361–364
- American Urological Association (AUA) (2005) Management of erectile dysfunction. Website <http://www.auanet.org/guidelines>
- Bannowsky A, Schulze H, van der Horst C, Hautmann S, Juenemann KP (2008) Recovery of erectile function after nerve-sparing radical prostatectomy: improvement with nightly low-dose sildenafil. *BJU* 101:1279–1283
- Behre HM (2004) Testosterone and erection. In: Nieschlag E, Behre HM (eds) *Testosterone – action, deficiency and substitution*, 3rd edn. Cambridge University Press, Cambridge, pp 333–346
- Bella AJ, Perelman MA, Brant WO, Lue TF (2007) Peyronie’s disease (CME). *J Sex Med* 4:1527–1538
- Biagiotti G, Cavallini G (2001) Acetyl-L-carnitine vs tamoxifen in the oral therapy of Peyronie’s disease: a preliminary report. *BJU Int* 88:63–67
- Blount MA, Beasley A, Zoraghi R, Sekhar KR, Bessay EP, Francis SH, Corbin JD (2004) Binding of tritiated sildenafil, tadalafil or vardenafil to the phosphodiesterase-5 catalytic site displays potency, specificity, heterogeneity, and cGMP stimulation. *Mol Pharmacol* 66:144–152
- Braun M, Wassmer G, Klotz T, Reifenrath B, Mathers M, Engelmann U (2000) Epidemiology of erectile dysfunction: results of the ‘Cologne Male Survey’. *Int J Impot Res* 12: 305–311
- Briganti A, Salonia A, Gallina A, Chun FKH, Karakiewicz PI, Graefen M, Huland H, Rigatti P, Montorsi F (2007)

- Management of erectile dysfunction after radical prostatectomy in 2007. *World J Urol* 25:143–148
- Brock G, Tu LM, Linet OI (2001) Return of spontaneous erections during long term intracavernosal alprostadil (Caverject) treatment. *Urology* 57:536–541
- Burnett AL (2004) Novel nitric oxide signaling mechanisms regulate the erectile response. *Int J Impot Res* 16(1): S15–S19
- Carson CC, Rajfer J, Eardley I, Carrier S, Denne JS, Walker DJ, Shen W, Cordell WH (2004) The efficacy and safety of tadalafil: an update. *BJU Int* 93:1276–1281
- Colpi GM, Fanciullacci F, Aydos K, Grugnetti C (1991) Effectiveness mechanism of clomipramine by neurophysiological tests in subjects with true premature ejaculation. *Andrologia* 23:45–47
- Cookson MS, Nadig PW (1993) Long-term results with vacuum constriction device. *J Urol* 149:290–294
- Davis-Joseph B, Tiefer L, Melman A (1995) Accuracy of the initial history and physical examination to establish the etiology of erectile dysfunction. *Urology* 45:498–502
- Del Popolo G, Li Marzi V, Mondaini N (2002) Time/duration effectiveness of sildenafil versus tadalafil in the treatment of erectile dysfunction in male spinal-cord injured patients. *Spinal Cord* 42:643–648
- Denil J, Ohl DA, McGuire EJ, Jonas U (1992) Treatment of anejaculation with electroejaculation. *Acta Urol Belg* 60:15–25
- Derouet H, Zehl U (1990) Die Behandlung der erektilen Dysfunktion mittels Vakuumsaugpumpen (EHS). *Urologe A* 32:312–315
- Detmiers C, Ahlen H van, Faust H, Fatepour D, Tackmann W (1994) Evaluation of erectile dysfunction with the sympathetic skin response in comparison to bulbocavernosus reflex and somatosensory evoked potentials of the pudendal nerve. *Electromyogr Clin Neurophysiol* 34:437–444
- Droggin D, Shabsigh R, Anastasiadis G (2005) Antibiotic coating reduces penile prosthesis infection. *J Sex Med* 2: 565–568
- Ernst E, Pittler MH (1998) Yohimbine for erectile dysfunction: a systematic review and meta-analysis of randomized clinical trials. *J Urol* 159:433–436
- Fabbri A, Jannini EA, Gnassi L, Moretti C, Ulisse S, Franzese A, Lazzari R, Fraioli F, Frajese G, Isidori A (1989) Endorphins in male impotence: evidence for naltrexone stimulation of erectile activity in patient therapy. *Psychoneuroendocrinology* 14:103–111
- FDA (2007) FDA proposes new warnings about suicidal thinking, behavior in young adults who take antidepressant medications. FDA news: <http://69.20.19.211/bbs/topics/NEWS/2007>
- Feldmann HA, Goldstein I, Hatzichristou DG, Krane RJ, McKinlay JB (1994) Impotence and its medical and psychosocial correlates: results of the Massachusetts Male Aging Study. *J Urol* 151:54–61
- Goldstein I, Lue TF, Padma-Nathan H for the Sildenafil Study Group (1998) Oral sildenafil in the treatment of erectile dysfunction. *N Engl J Med* 338:1397–1404
- Golijanin D, Singer E, Davis R, Bhatt S, Seftel A, Dogra V (2007) Doppler evaluation of erectile dysfunction. *Int J Impot Res* 19:37–48
- Gorkin L, Hvidsten K, Sobel RE, Siegel R (2006) Sildenafil citrate use and the incidence of nonarteritic anterior ischemic optic neuropathy. *Int J Clin Pract* 60:500–503
- Greenstein A, Plymate SR, Katz PG (1995) Visually stimulated erection in castrated men. *J Urol* 153:650–652
- Grein U, Noll F, Schreiter F (1989) Behandlung der erektilen Dysfunktion mit Penisprothesen. *Urologe A* 28:266–270
- Hartmann U, Langer D (1993) Combination of psychosexual therapy and intrapenile injections in the treatment of erectile dysfunctions: rationale and predictors of outcome. *J Sex Educ Ther* 19:1–12
- Hatzichristou DG, Suenz de Tejada I, Kupferman S, Namburi S, Pescatore ES, Udelson D, Goldstein I (1995) In vivo assessment of trabecular smooth muscle tone, its application in pharmacocavernosometry and analysis of intracavernous pressure determinants. *J Urol* 153:1126–1135
- Hauck EW, Diemer T, Weidner W (2006) Induratio penis plastica. *Urologe* 45:243–259
- Hauri D (1984) Therapiemöglichkeiten bei der vaskulär bedingten erektilen Impotenz. *Akt Urol* 15:350–354
- Heaton JPW, Morales A, Adams MA, Johnston B, El-Radhi R (1995) Recovery of erectile function by the oral administration of apomorphine. *Urology* 45:200–206
- Hellstrom WJG (2007) Current safety and tolerability issues in men with erectile dysfunction receiving PDE-5 inhibitors. *Int J Clin Pract* 61:1547–1554
- Jackson G, Montorsi P, Cheitlin M (2006a) Cardiovascular safety of sildenafil citrate (Viagra): an updated perspective. *Urology* 68:47–60
- Jackson G, Rosen RC, Kloner RA, Kostis JB (2006b) The second Princeton consensus on sexual dysfunction and cardiac risk: new guidelines for sexual medicine. *J Sex Med* 3: 28–36
- Jardin A, Wagner G, Khoury S, Giuliano F, Padma-Nathan H, Rosen R (eds) (2000) *Erectile dysfunction*. Health Publication Ltd., Plymouth, UK, pp 711–726
- Kamischke A, Nieschlag E (1999) Treatment of retrograde ejaculation and anejaculation. *Hum Reprod Update* 5:448–474
- Kaneko S, Bradley WA (1987) Penile electrodiagnosis: penile peripheral innervation. *Urology* 30:210–213
- Kelami A (1985) Congenital penile deviation and straightening of the penis using the Nesbit-Kelami technique. *Urol Int* 40:267–268
- Kim ED, McVary KT (1995a) Long-term follow up of treatment of Peyronie's disease with plaque incision, carbon dioxide laser plaque ablation and placement of a deep dorsal vein patch graft. *J Urol* 153:1843–1846
- Kim ED, McVary KT (1995b) Long-term results with penile vein ligation for venogenic impotence. *J Urol* 153:655–658
- Kim SC, Seo KK (1998) Efficacy and safety of fluoxetine, sertraline and clomipramine in patients with premature ejaculation: a double blind, placebo controlled study. *J Urol* 159:425–427
- Kloner R (1999) Safety of sildenafil citrate in men with erectile dysfunction taking multiple antihypertensive agents. *Am J Hypertens* 12:37
- Kloner R, Jackson G, Hutter AM, Mittleman MA, Chan M, Warner M, Costigan TM, Vail GM (2006) Cardiovascular safety update of tadalafil: retrospective analysis of data from placebo-controlled and open-label clinical trials of tadalafil with as needed, three times-per-week or once-a-day dosing. *Am J Cardiol* 97:1778–1784
- Kloner RA, Speakman M (2002) Erectile dysfunction and atherosclerosis. *Curr Atheroscler Rep* 5:397–401
- Klotz T, Bauer RJ, Rohde G (2002) Effect of renal impairment on the single-dose pharmacokinetics of vardenafil 20 mg, a

- selective PDE-5 inhibitor, for the treatment of erectile dysfunction. *Pharmacotherapy* 22:418
- Kostis JB, Jackson G, Rosen R, Barrett-Connor E, Billups K, Burnett AL, Carson III C, Cheitlin M, Debusk R, Fonseca V, Ganz P, Goldstein I, Guay A, Hatzichristou D, Hollander JE, Hutter A, Katz S, Kloner RA, Mittleman M, Montorsi F, Montorsi P, Nehra A, Sadovsky R, Shabsigh R (2005) Sexual dysfunction and cardiac risk (the Second Princeton Consensus Conference). *Am J Cardiol* 96:313–321
- Lavoisier P, Proulx J, Courtois F, De CF (1989) Bulbocavernosus reflex: its validity as a diagnostic test of neurogenic impotence. *J Urol* 141:311–314
- Lawrence S, Madakasira S (1992) Evaluation and treatment of premature ejaculation: a critical review. *Int J Psychiatry Med* 22:77–97
- Lemourt OM, Filgueiras LE, Rodriguez BA, Gonzalez OE, Bordonado R (1998) Clinical evaluation of the use of propoleum in Peyronie's disease. *Arch Esp Urol* 51:171–176
- Lue TF, Tanagho EA (1987) Physiology of erection and pharmacological management of impotence. *J Urol* 137:829–836
- Masters WH, Johnson VE (1970) *Human sexual inadequacy*. Little, Brown, Boston, MA
- McMahon CG, Abdo C, Incrocci L, Perelman M, Rowland D, Waldinger M, Xin ZC (2004) Disorders of orgasm and ejaculation in men. *J Sex Med* 1:58–65
- Mittleman MA, Maclure M, Glasser DB (2005) Evaluation of acute risk for myocardial infarction in men treated with sildenafil citrate. *Am J Cardiol* 96:443–446
- Moldings GJ, van Ahlen H, Göthert M (1992) Modulation of noradrenaline release in human corpus cavernosum by presynaptic prostanoid receptors. *Int J Impotence Res* 4: 19–25
- Montorsi F, Guazzoni G, Strambi LF (1997) Recovery of spontaneous erectile function after nerve-sparing retropubic radical prostatectomy with and without early intracavernous injections of alprostadil: results of a prospective, randomised trial. *J Urol* 158:1408–1410
- Montorsi F, Brock G, Lee J, Shapiro J, van Poppel H, Graefen M, Stief C (2008) Effect of nightly versus on-demand vardenafil on recovery of erectile function in men following bilateral nerve-sparing radical prostatectomy. *Eur Urol* 54:924–931
- Montorsi P, Ravagnani PM, Galli S, Rotatori F, Briganti A, Salonia A, Rigatti P, Montorsi F (2005) The artery size hypothesis: a macrovascular link between erectile dysfunction and coronary artery disease. *Am J Cardiol* 96: 19M–23M.
- Morales A, Condra M, Reid K (1990) The role of nocturnal penile tumescence monitoring in the diagnosis of impotence: a review. *J Urol* 143:441–446
- Mulhull J, Montorsi F (2006) Evaluating preference trials of oral phosphodiesterase 5 inhibitors for erectile dysfunction. *Eur Urol* 49:30–37
- Mulhull J, Land S, Parker M, Waters WB, Flanigan RC (2005) The use of an erectogenic pharmacotherapy regimen following radical prostatectomy improves recovery of spontaneous erectile function. *J Sex Med* 2:532–545
- Mulhull JP, Simmons J (2007) Assessment of comparative treatment satisfaction with sildenafil citrate and penile injection therapy in patients responding to both. *BJU Int* 100: 1313–1316
- Nathalie A, Ollanas R, Fisch M (2008) Penile implantation in Europe: successes and complications with 253 implants in Italy and Germany. *J Sex Med* 5:1503–1512
- Nesbit RM (1954) The surgical treatment of of congenital chordee without hypospadias. *J Urol* 72:1178–1180
- Oates CP, Pickard RS, Powell PH, Murthy LNS, Whittingham TAW (1995) The use of duplex ultrasound in the assessment of arterial supply to the penis in vasculogenic impotence. *J Urol* 153:354–357
- Padma-Nathan H (2006) Sildenafil Citrate (Viagra) treatment for erectile dysfunction: an updated profile of response and effectiveness. *Int J Impot Res* 18:423–431
- Padma-Nathan H, Hellstrom WJ, Kaiser FE, Labasky RF, Lue TF, Nolten WE, Norwood PC, Peterson CA, Shabsigh R, Tam PY (1997) Treatment of men with erectile dysfunction with transurethral alprostadil. Medicated Urethral System for Erection (MUSE) Study Group. *N Engl J Med* 336:1–7
- Patterson B, Bedding A, Hayley J, Payne C, Mitchell M (2002) Dose-normalised pharmacokinetics of tadalafil administered as a single dose to healthy volunteers. *Eur Urol Suppl.* 1:152, Abstract 600
- Pickering TG, Shepherd AM, Puddey I (2004) Sildenafil citrate for erectile dysfunction in men receiving multiple antihypertensive agents: a randomized controlled trial. *Am J Hypertens* 14:70–73
- Porst H (1990) Diagnostic use and side effects of vasoactive drugs – a report on over 2,100 patients with erectile failure. *Int J Impotence Res* 2(2):222–223
- Porst H, van Ahlen H (1989) Drug-induced priapism – a report of experiences in 101 cases. *Urologe* 28:84–87
- Porst H, Weller S (1989) Vasoaktive Substanzen bei erektiler Dysfunktion (ED) – Ergebnisse einer Umfrage und Literaturübersicht. *Urologe B* 29:10–14
- Porst H, Ahlen H van, Köster O, Schlolaut KH (1988a) Vergleich von Papaverin-induzierter Doppler-Sonographie und Angiographie in der Diagnostik der erektilen Dysfunktion. *Urologe A* 27:8–13
- Porst H, Tackmann W, Ahlen H van (1988b) Neurophysiological investigations in potent and impotent men. Assessment of bulbocavernosus reflex latencies and somatosensory evoked potentials. *Br J Urol* 61:445–450
- Porst H, Rajfer J, Casabé A, Feldman R, Ralph D, Vieiralves LF, Esler A, Wolka AM, Klise SR (2008) Long-term safety and efficacy of tadalafil 5 mg dosed once daily in men with erectile dysfunction. *J Sex Med* 5:2160–2169
- Pryor JL, Althof SE, Steidle C, Rosen RC, Hellstrom WJ, Shabsigh R, Miloslavsky M, Kell S (2006) Efficacy and tolerability of dapoxetine in treatment of premature ejaculation: an integrated analysis of two double blind, randomised controlled trials. *Lancet* 368:929–937
- Rajfer J, Aliotta PJ, Steidle CP, Fitch III WP, Zhao Y, Yu A (2007) Tadalafil dosed once a day in men with erectile dysfunction: a randomized, double-blind, placebo-controlled study in the US. *Int J Impot Res* 19:95–103
- Ralph D, Eardley I, Kell P, Dean J, Hackett G, Collins O, Edwards D (2007) Improvement in erectile function on vardenafil treatment correlates with treatment satisfaction in both patients and their partners. *BJU Int* 100:130–136
- Rhee E, Osborn A, Witt M (1995) The correlation of cavernous systolic occlusion pressure with peak velocity flow using color duplex doppler ultrasound. *J Urol* 153:358–360

- Robert A, Kloner RA, Mohan P, Norenberg C (2002) Cardiovascular safety of vardenafil, a potent, highly selective PDE-5 inhibitor in patients with erectile dysfunction: an analysis of five placebo-controlled clinical trials. *Pharmacol Ther* 22:1371–1375
- Rosen RC, Fisher WA, Eardley I, Niederberger C, Nadel A, Sand M (2004) Men's Attitudes to Life Events and Sexuality (MALES) Study. I. Prevalence of erectile dysfunction and related health concerns in the general population. *Curr Med Res Opin* 20:607–617
- Rosen RC, Fisher WA, Beneke M, Homering M, Evers T (2007) The COUPLES-project: a pooled analysis of patient and partner treatment satisfaction scale (TSS) outcomes following vardenafil treatment. *BJU Int* 99:849–859
- Rosenberg MT (2007) Diagnosis and management of erectile dysfunction in the primary care setting. *Int J Clin Pract* 61: 1198–1208
- Rubio-Aurioles E, Porst H, Eardley I, Goldstein I (2006) Comparing vardenafil and sildenafil in the treatment of men with erectile dysfunction and risk factors for cardiovascular disease: a randomised, double-blind, pooled crossover study. *J Sex Med* 3:1037–1049
- Safarinejad MR (2004) Therapeutic effects of colchicines in the management of Peyronie's disease: a randomized double-blind, placebo-controlled study. *Int J Impot Res* 16: 238–243
- Safarinejad MR (2007) Safety and efficacy of escitalopram in the treatment of premature ejaculation: a double-blind, placebo controlled, fixed dose, randomised study. *J Clin Psychopharmacol* 27:444–450
- Safarinejad MR, Hosseini SY, Kolahi AA (2007) Comparison of vitamin E and propionyl-L-carnitine, separately or in combination, in patients with early chronic Peyronie's disease: a double-blind, placebo controlled, randomized study. *J Urol* 178:1398–1403
- Sairam K, Kulinskaya E, Boustead GB, Hanbury DC, McNicholas TA (2001) Prevalence of undiagnosed diabetes mellitus in male erectile dysfunction. *BJU Int* 88:68–71
- Salem EA, Wilson SK, Bissada NK, Delk JR, Hellstrom WJ, Cleves MA (2008) Tramadol HCL has promise in on-demand use to treat premature ejaculation. *J Sex Med* 5: 188–193
- Scott FB, Bradley WE, Timm GW (1973) Management of erectile impotence: use of implantable inflatable prosthesis. *Urology* 2:80–82
- Seftel A (2004) Phosphodiesterase type 5 inhibitor differentiation based on selectivity, pharmacokinetic and efficacy profiles. *Clin Cardiol* 27:14–19
- Small MP, Carrion HH (1975) A new penile prosthesis for treating impotence. *Contemp Surg* 7:29–33
- Sohn M, Sikora RR, Bohndorf KK, Wein B, Zabelberg U, Jakse G (1992) Objective follow-up after penile revascularisation. *Int J Impot Res* 4:73–84
- Stanley EA, Rowland DL (2008) Identifying constructs and criteria for the diagnosis of premature ejaculation: implication for making errors of classification. *BJU Int* 102:708–712
- Stief CG (1993) Diagnostik und Therapie der erektilen Dysfunktion. *Internist* 34:767–774
- Teloken C, Rhoden EL, Grazziotin TM, Ros CT, Sogari PR, Souto CA (1999) Tamoxifen versus placebo in the treatment of Peyronie's disease. *J Urol* 162:2003–2005
- Valiquette L, Montorsi F, Auerbach S (2008) Vardenafil demonstrates first-dose success and reliability of penetration and maintenance of erection in men with erectile dysfunction – RELY-II. *Can Urol Assoc J* 2:187–195
- van Ahlen H, Peskar BA, Sticht G, Hertfelder HJ (1994) Pharmacokinetics of vasoactive substances administered into the human corpus cavernosum. *J Urol* 151: 1227–1230
- van Ahlen H, Piechota HJ, Kias HJ, Brennemann W, Klingmüller D (1995) Opiate antagonists in erectile dysfunction: a possible new treatment option. *Eur Urol* 28:246–250
- van Ahlen H, Wahle K, Kupper W, Yassin A, Reblin T, Neureither M (2005) Safety and efficacy of vardenafil, a selective phosphodiesterase 5 inhibitor in patients with erectile dysfunction and arterial hypertension treated with multiple antihypertensives. *J Sex Med* 2:856–864
- Virag R, Zwang G, Dermange H, Legman M (1981) Vasculogenic impotence: a review of 92 cases with 54 surgical operations. *Vasc Surg* 15:9–15
- Vogt HJ, Brandl P, Kockott G, Schmitz JR, Wiegand MH, Schadrack J (1997) Double-blind, placebo-controlled safety and efficacy trial with yohimbine hydrochloride in the treatment of nonorganic erectile dysfunction. *Int J Impot Res* 9: 155–161
- Wegner HEH, Andresen R, Knispel HH, Banzer D, Miller K (1995) Evaluation of penile arteries with color-coded duplex sonography: prevalence and possible therapeutic implications of connections between dorsal and cavernous arteries in impotent men. *J Urol* 153:1469–1471
- Weidner W, Hauck EW, Schnitker J (2005) Peyronie's disease study group of andrological group of German urologists. *Eur Urol* 47:530–535
- Wilson SK, Delk J, Neeb A, Cleves M (2006) Long term survival of inflatable penile prostheses: single surgical group experience with 2,384 first time implants spanning two decades. *J Urol* 174:1304
- Zumbé J, Porst H, Sommer F, Grohmann W, Beneke M, Ulbrich E (2008) Comparable efficacy of once-daily versus on-demand vardenafil in men with mild-to-moderate erectile dysfunction: findings of the RESTORE Study. *Eur Urol* 54: 204–212

Contents

17.1	Introduction.....	323
17.2	Androgen Insensitivity	323
17.2.1	Complete Androgen Insensitivity	325
17.2.2	Partial Androgen Insensitivity	327
17.2.3	Minimal Androgen Insensitivity	328
17.2.4	X-linked Spinal and Bulbar Muscular Atrophy (SBMA).....	328
17.3	Perineoscrotal Hypospadias with Pseudovagina (5 α -Reductase 2-Deficiency)	328
17.4	Estrogen Resistance and Estrogen Deficiency	329
17.5	Gynecomastia	329
17.5.1	Clinical Examination	329
17.5.2	Laboratory Investigation.....	331
17.5.3	Pathophysiology	331
17.5.4	Male Breast Cancer	334
17.5.5	Therapy	334
17.6	Androgenetic Alopecia	335
17.6.1	Epidemiology and Pathophysiology	335
17.6.2	Diagnosis	335
17.6.3	Therapy	335
	References.....	336

17.1 Introduction

In this chapter, as throughout this volume, we classify diseases according to where they originate, i.e., in which organ or physiological system. (see Chap. 4). All disease entities dealt with under Sects. 17.2–17.3 have in common, to variable degrees, impaired action of androgens or estrogens in their target organs. Gynecomastia represents an exception; this disorder will be discussed here more for reasons of clinical convenience rather than according to strictly nosological criteria.

Some of the diseases described below were formerly summarized under the category of “intersexuality.” Because of the vague and discriminating character of this term we prefer not to use it and speak instead of “disorders of sexual development” (DSD) (Hughes et al. 2006). Since DSD have no single, uniform pathogenesis, some of the diseases are treated here, while others appear in Chap. 13. Chapter 2 deals with the physiological basis of DSD.

17.2 Androgen Insensitivity

Male sexual differentiation is the result of a cascade which encompasses the interaction of regulatory genes, cellular and hormone signals. During the first phase of sexual development the anlagen of the gonads are bipotent and both Wolffian as well as Mullerian ducts are present. In the presence of a Y chromosome the gonads differentiate under the influence of the SRY gene and other genes into testes. The Sertoli cells produce anti-Mullerian hormone, which induces the regression of the Mullerian ducts, which would otherwise develop into a uterus, tubes and upper vagina.

P. F. Wieacker (✉)
Institute of Human Genetics of the University,
Vesaliusweg 12–14, 48149 Münster
e-mail: Wieacker@uni-muenster.de

The Leydig cells secrete testosterone, which stimulates differentiation of the Wolffian ducts to produce the ductus epididymis, vasa deferentia, seminal vesicles and a part of the prostate. In the periphery testosterone is converted to dihydrotestosterone which causes differentiation of the external genitalia and stimulates development of the prostate. As androgens can only become effective if they can bind to a functional receptor, mutations of the androgen receptor gene (AR) cause different forms of **androgen insensitivity (AI)** in chromosomal and gonadal male persons.

The spectrum of **androgen insensitivity (AI)** ranges from a female phenotype in the case of **complete androgen insensitivity (CAI)**, to ambivalent forms of the genitalia in **partial androgen insensitivity (PAI)**, up to a male phenotype with infertility, as seen in **minimal androgen insensitivity (MAI)**.

According to Quigley (1998), seven degrees of androgen insensitivity can be distinguished. Grade 1 is characterized by unambiguous male development of

the external genitalia and grades 6 and 7 show definite female development of the outer sex organs, with grade 7 showing entirely absent and grade 6 merely sparse axillary and pubic hair (resulting from weakly remaining functions of the AR). Grades 2–5 describe varying virilization disturbances of the external genitalia.

Today gene tests are used to identify mutations to establish the diagnosis of androgen insensitivity (Fig. 17.1) (Gottlieb et al. 2004).

These mutations can be divided into four groups (Wieacker et al. 1998):

- Complete and larger partial deletions
- Deletions and insertions of few nucleotides
- Point mutations acting as missense, nonsense or splice mutations
- Expansion of the CAG repeats in exon 1 in X-linked spinal bulbar muscular atrophy

Complete and more extensive partial deletions of the AR gene are detected in about 6% of cases. Deletions

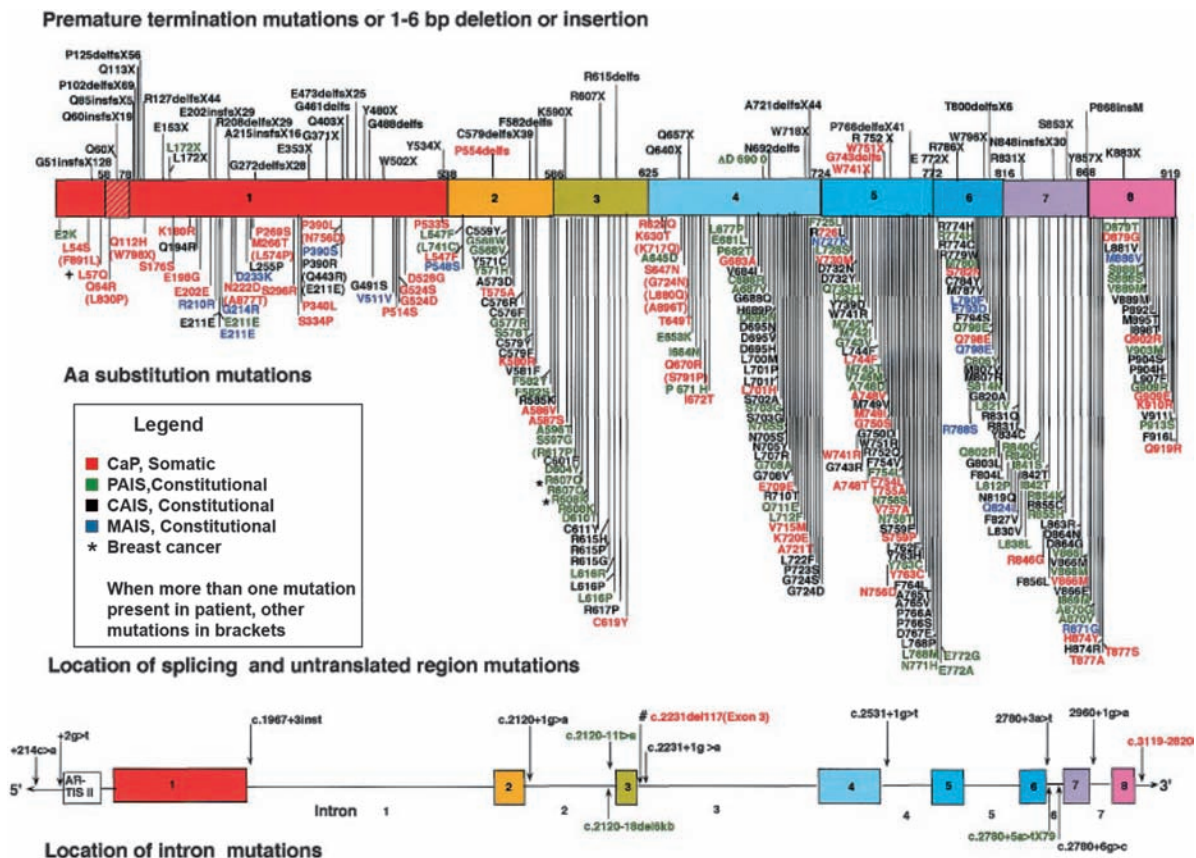

Fig. 17.1 Mutations of the androgen receptor gene (Gottlieb et al. 2004)

and insertions of a few nucleotides occur in about 5% of cases. Point mutations occur most frequently. About 85% of the missense mutations are localized in the steroid binding domain. The remaining mutations occur especially in the DNA binding domain. Mutations in exon 1 seem to be rare. Most of the mutations are family-specific and in general only few recurrent mutations have been described to date, so that complete sequencing is required for diagnosis.

Complete deletions of the AR cause **CAI**; **partial deletions** typically lead to **CAI** or **PAI**. Deletions and insertions of several nucleotides cause CAI when the reading frame is shifted. Missense mutations can cause complete, partial or minimal AI. The identical missense point mutations can cause interfamilial or, more rarely, intrafamilial CAI or PAI (Rodien et al. 1996).

Androgen-binding studies, which had to be performed using genital fibroblasts recovered from a skin biopsy, no longer play any major role in diagnosis. Three classes of pathological findings are distinguished: (a) complete lack of androgen binding to the receptor, (b) quantitative discrepancies in androgen binding, and (c) qualitatively abnormal androgen binding (e.g., increased thermolability). The form of AI (androgen insensitivity) previously designated as “receptor positive” has been explained by mutations in the DNA binding domain, whereby, not unexpectedly, steroid binding is not affected. At present androgen-binding studies are only useful when clinical and endocrinological findings support the diagnosis of AR and when a gene test fails to demonstrate a mutation.

Similarly the SHBG test (Krause et al. 2004) has become less important. In this test 0.2 mg/kg stanozolol are applied for 3 days. SHBG is measured before and on days 5, 6, 7 and 8. Normally the steroid stanozolol causes SHBG to decrease. If the SHBG concentration fails to decline to less than 63% of basal, this can be taken as a sign of an androgen receptor defect.

AI is inherited in an X chromosomal recessive fashion. The female carrier of an AR mutation passes on the mutated allele to half of her children with an XY karyotype, who are then affected, and to half of the children with an XX karyotype, who then become carriers.

Meticulous anamnesis will yield a positive previous family history in about two thirds of cases. Further affected relatives are to be sought in the maternal line. A typical family pedigree is shown in Fig. 17.2, where two affected women related through the maternal line are shown; they remained involuntarily childless and never menstruated.

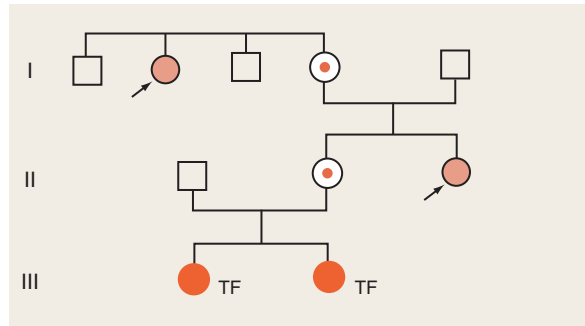

Fig. 17.2 Pedigree of a family with complete androgen insensitivity. The diagnosis was first established in the two index patients (dark red circles). Anamnesis revealed that an aunt and great-aunt (arrows) each suffered from primary amenorrhea and remained childless. These very likely also had CAI. The maternal mother and grandmother are obligatory carriers. (indicated by dot in the pedigree symbol) of the gene defect. Phenotypically male family members are symbolized by squares

17.2.1 Complete Androgen Insensitivity

The prevalence of CAI (formerly known as testicular feminization) is about 1:20,000 persons with an XY karyotype. During normal differentiation of the testis the Sertoli cells produce AMH so that tubes and uterus fail to develop and a residual vagina results. However, in about one third of cases rudimentary Mullerian structures are found (Rutgers and Scully 1991). The Leydig cells produce androgens with concentrations in the male range. Because of the AR defect these androgens are ineffective, so that Wolffian structures regress and the testes fail to descend.

The testes may be intraabdominal, inguinal or localized in the labia majora. The probability of AI is about 1–2% in phenotypically female children with inguinal hernias (Grumbach and Conte 1991). Often surgical repair of hernia leads to diagnosis during childhood. In fact CAI is one of the primary differential diagnoses in female children with bilateral **inguinal hernias**.

Because of the lack of effectiveness of DHT the external genitalia are unmistakably female.

Primary amenorrhea is noted during puberty; lacking (grade 7) or sparse (grade 6) axillary or pubic hair occur alongside normal breast development (Fig. 17.3). Breast development can be explained by adequate estrogen concentrations following the aromatization of testosterone by aromatase and by lack of androgen action. The patients are usually taller than their sisters,



Fig. 17.3 23-year-old patient with complete androgen insensitivity: Female phenotype with normal breast development and absence of axillary and pubic hair

probably due to delayed closure of the epiphyseal fissures (Han et al. 2008). The lack of androgen action causes an increase of LH, which in turn stimulates the Leydig cells. The resulting hyperplasia of the Leydig cells may become visible as Pick adenoma. Sexual identity is unmistakably female, which is to be expected due to complete lack of androgen action.

Postpubertal female patients have testosterone concentrations in the normal range for males and estrogen levels are higher than in men. LH is clearly elevated, FSH is only mildly increased or within the normal range. Prepubertal female patients generally have normal LH and testosterone levels.

In CAI a ca. 2% risk for malignant germ cell tumors is assumed (Hughes et al. 2006). Among tumors not deriving from germ cells Sertoli cell adenomas are more frequent than Leydig cell adenomas. The possibility of gonadectomy should be discussed with the patients. It seems justified to delay gonadectomy until puberty as the earliest malignancy reported was found at the age of 14 (Hurt et al. 1989).

Just how the diagnosis is to be communicated to the patient is subject to controversy. Disclosure of the diagnosis, including the fact that the gonads contain testicular cells and that the karyotype is male, can have disastrous consequences for the woman's self-image. For this reason many physicians until recently felt that full disclosure should not be made. In the meantime an individualized course of action seems more appropriate, one which takes into consideration the patient's age, psychic constitution and the degree to which the patient is already aware of her condition. Considering all these points complete disclosure can be justified. In such cases it is important that the patient understands that in her case androgens cannot achieve their biologic effects and that therefore the pivotal step in sexual differentiation proceeded not in a male but in a female direction.

In the event that the gonads are removed, **exogenous estrogen substitution** treatment must be initiated. Treatment is oriented to that customary in gynecology. Further special therapeutic measures are not indicated. The patients are fully adapted to the female role and can lead a normal married life. Psychotherapeutic support may be valuable for patients who were confronted with the diagnosis or who have problems coping with their intractable infertility (cf. Chap. 25).

17.2.2 Partial Androgen Insensitivity

Partial **androgen insensitivity** (PAI) encompasses a broad spectrum corresponding to the Quigley classification of degrees 2–5. Grade 5 is characterized by a female phenotype with mild clitoromegaly and partial synechia between the labia. Masculinization of the external genitalia can increase when puberty occurs. Axillary and pubic hair are present. This grade corresponds to the former designation “incomplete testicular feminization”.

Grade 4 is characterized by **clitoromegaly**, a **urogenital sinus** and a fusion of the **labioscrotal folds**.

The Reifenstein syndrome corresponds to **grade 3** (Fig. 17.4). It is marked by more masculine external genitalia with perineoscrotal hypospadias, small phallus, cryptorchidism or inguinal testes and scrotum bifidum. Typically gynecomastia develops during puberty.

Grade 2 is characterized by manifest male phenotype with only mild disorders of androgenization such as isolated **hypospadias**. Patients with severe isolated hypospadias show mutations of the AR gene in 7% of cases (Allera et al. 1995).

Hormone parameters in PAI are comparable to those in CAI. LH is elevated, while FSH is generally normal. Testosterone lies within the male range.

In PAI the risk of testicular tumors depends on the localization of the testes. According to a consensus paper (Hughes et al. 2006), a malignancy risk of 50% exists for PAI with intraabdominal gonads, although this is based on only a small number of patients. Gonadectomy at the time of diagnosis is recommended. A lower risk is assumed for PAI patients with scrotal gonads, although reliable quantification does not seem possible at the present time.

Furthermore the risk of **breast cancer** is increased in PAIS. In three patients with PAIS and breast cancer a missense mutation in the binding domain was verified in each case (Wooster et al. 1992; Lobaccaro et al. 1993).

Therapy of PAI should be carried out in an interdisciplinary fashion, especially in grades 3 and 4. It should be directed towards the needs of the patient and consider the risk of malignancy and surgical options. Because of the clinical variability of PAI, therapy must be tailored to the individual patient, more than in the case of CAI. If the patient shows a male psychosexual orientation, therapy should aim to enhance the male attributes of the phenotype.



Fig. 17.4 Patient with Reifenstein syndrome. The scars from mastectomy and removal of the inguinal testes are visible. A malignant tumor was present in the right testis. Note the small phallus (the perineoscrotal hypospadias is not visible on this photograph)

Hypospadias, cryptorchidism, gynecomastia and other anatomical anomalies are amenable to surgical correction. After orchiectomy exogenous androgen substitution must follow in accordance with principles discussed in Chap. 21. In single cases high-dose testosterone therapy may achieve a certain degree of additional virilization.

17.2.3 Minimal Androgen Insensitivity

Minimal androgen insensitivity (MAI) corresponds to **grade 1** according to Quigley. With the possible exception of a micropenis, the external genitalia is masculine. During puberty gynecomastia typically develops. Patients are infertile because of azoospermia or severe oligospermia. As a characteristic of MAI, male infertility is caused by a mutation in the AR gene. To date, however, only few AR mutations have been found among infertile men. Of therapeutic interest are observations by Yong et al. (1994), who reported restoration of fertility in an infertile man with a missense mutation in the AR gene after androgen therapy. Normal or elevated testosterone concentrations with elevated LH give endocrinological indications of MAI.

17.2.4 X-linked Spinal and Bulbar Muscular Atrophy (SBMA)

X-linked spinal and bulbar muscular atrophy or Kennedy disease is a motoneuron affliction affecting men late in life. The typical age of manifestation is the third or fourth decade. Characteristic symptoms are muscle weakness (especially in the shoulder girdle and legs), muscle cramps, dysarthria and dysphagia. Additionally there are signs of androgen resistance such as gynecomastia and azoospermia or oligospermia.

This disease is caused by pathological expansion of the CAG repeats in exon 1 of the AR gene (LaSpada et al. 1992). The number of CAG repeats is polymorphic and normally numbers between 9 and 36. In SBMA at least 38 repetitions are found (typically between 38 and 62). The expanded CAG repeat leads to an extended glutamine domain in the AR. The mild androgen resistance observed in this disease can be

explained by the fact that the transactivation potential of the AR decreases with the size of the repeat. Thus expression of the target genes of the AR is inhibited.

Depending on the localization of the AR gene, the mode of inheritance of Kennedy disease is X-linked recessive. Thus all daughters of an affected man are obligatory carriers. Statistically half of the sons of a female carrier are diseased. More than 70% of affected males already have children by the time the disease breaks out. The CAG repeat seems to expand during male meiosis.

17.3 Perineoscrotal Hypospadias with Pseudovagina (5 α -Reductase 2-Deficiency)

Perineoscrotal hypospadias with pseudovagina (PHP) is another disorder caused by an impairment of the physiologic action of androgens. However, the basic abnormality is located in androgen metabolism and not in androgen receptor interaction. The principles of androgen physiology and metabolism have been laid out in Chap. 3. The reader is reminded that a major part of the biologic effects of testosterone is mediated indirectly via its metabolite **dihydrotestosterone** (DHT). All clinical manifestations of PHP result from a deficiency of DHT in the target cells of the genital tract. The basic biochemical defect lies in disturbed conversion of testosterone to DHT by the enzyme (steroid) 5 α -reductase which exists in two isoforms. In PHP the disturbance lies in a defect of 5 α -reductase type 2 (Imperato-McGinley et al. 1982; Imperato-McGinley and Zhu 2002; Griffin et al. 1995).

As DHT is responsible for virilization of the external genitalia, karyotypical male newborns show female external genitalia or – depending on remaining activity of 5 α -reductase 2 – virilization with clitoral hypertrophy, hypospadias and labioscrotal fusion. Because of the anti-Mullerian influence of the testes, Mullerian ducts are not present so that the sinus urogenitalis remains and a pseudovagina results. In contrast, the Wolffian structures develop because of the effects exerted by testosterone. The prostate, whose development depends on DHT, is localized as a rudiment dorsal to the urethra and remains small. The testes are extra-abdominal, mostly in the inguinal canal or in the area of the labia majora.

During puberty testosterone-dependent development is activated. Voice mutation and typically male musculature develop, while DHT-dependent alterations such as beard growth and acne fail to occur. Scalp hair remains dense, the frontal hairline straight. Patients with PHP are mostly reared as girls, but they are **genetic males** (karyotype 46, XY). At the time of expected puberty there is no menarche or breast development, and marked **virilization** develops. The patients often convert spontaneously to the male gender role (Hughes et al. 2006). There are no reports so far about men with PHP having fathered children. In all cases that have been studied spermatogenesis was severely compromised.

Family history is positive in about 40% of cases and may be helpful for diagnosis. PHP is an autosomal recessive disorder, additional cases most likely occur among the sibs of the index patient. The disease occurs more frequently in consanguineous partnerships. The parents, who are heterozygotes, are clinically healthy. Interestingly, the same is true for genetically female individuals (e.g., sisters of affected men) homozygous for the enzyme defect who are completely healthy. Obviously the lack of 5 α -reductase 2 does not adversely affect female sex differentiation.

Endocrinological diagnosis requires an hCG test, in which testosterone shows the expected rise, while DHT remains low. The most specific indicator is an abnormally high testosterone/DHT ratio, which is above 50 in the classical phenotype; the upper normal level is 16. Serum estrogen levels are normal, LH and FSH concentrations are either normal or elevated. Genetic diagnosis follows from evidence of mutations in the corresponding gene, SRD5A2 (Wilson et al. 1993; Sinnecker et al. 1996).

17.4 Estrogen Resistance and Estrogen Deficiency

In connection with the discussion of target organ resistance to androgens, a recently characterized condition caused by estrogen resistance should be mentioned (Smith et al. 1994). The male patient described in this report had eunuchoid body proportions and was 204 cm tall, with longitudinal growth still not completed at the age of 28. Bone age was 15 years, and bone density was extremely subnormal. However, the degree of

virilization was fully appropriate, and a testicular volume of 20–25 ml was measured. Molecular studies revealed a homozygous mutation in the estrogen receptor gene, explaining the state of estrogen resistance.

This case illustrates the physiologic importance of estrogens in males. Quite surprisingly, only the bone is adversely affected by the state of estrogen resistance, and the role of estrogens in the functional maturation of this tissue is obviously prominent (Faustini-Fustini et al. 1999). The report contained no information as to the fertility status of the patient.

While in the above mentioned case estrogen effects were blocked by a defect of the hormone receptor, in two other patients with very similar clinical symptoms estrogen synthesis was compromised by a **deficiency of the enzyme cytochrome 450 aromatase**. Substitution therapy with estrogens led to rapid skeletal maturation (Carani et al. 1997; Maffei et al. 2004; Lanfranco et al. 2008) (Fig. 17.5).

17.5 Gynecomastia

In gynecomastia breast tissue is enlarged in the male. Androgen action is impeded only in some cases and often no other endocrine basis for the abnormality can be detected (Fig. 17.6). Therefore, the discussion of gynecomastia in this chapter is justified more for reasons of clinical convenience than from a strictly nosological point of view.

17.5.1 Clinical Examination

The most immediate point to be clarified by physical examination is whether or not there is true gynecomastia or pseudo-gynecomastia, i.e., lipomastia. With careful palpation some glandular tissue can be made out in many men. In particular lipomastia is often to be expected in obese men who may have substantial deposits of adipose tissue in the pectoral region. In cases of doubt, ultrasound may be helpful. Not rarely, gynecomastia is either strictly unilateral or more pronounced on one than on the other side. A tumor must be excluded. The extent of the condition can be estimated on a semi-quantitative basis using the Tanner grading system for breast development (see Sect. 5.2.5 and Fig. 5.3).



Fig. 17.5 Patient with aromatase deficiency (With permission from Prof. C. Carani, Modena)

Furthermore the extent of virilization should be established. Secondary hair growth and testis size should be registered as well as testicular alterations possibly pointing to a tumor. Ultrasound of the testicles to exclude a tumor are an obligatory part of the diagnosis of gynecomastia. The patient should be questioned about symptoms possibly indicating androgen deficiency such as reduction of libido, potency problems



Fig. 17.6 Marked "idiopathic" gynecomastia. Apart from obesity no other causal factors contributing to breast development could be ascertained. In addition to the firm glandular tissue, bilateral fat deposits were palpable

and changes in beard growth. Finally hints of systemic illnesses such as liver or kidney disease should be searched for. A mammography is indicated when malignancy is suspected.

17.5.2 Laboratory Investigation

The scope of laboratory investigations (endocrine, clinical chemistry) should be tailored to the specific clinical situation of the individual patient. If gynecomastia is non-progressive during puberty there is no need for extensive endocrine investigations. Usually determination of LH, FSH, prolactin estradiol and testosterone levels will suffice. Along with ultrasound of the testes the basic laboratory workup should include β -hCG and alpha-fetoprotein when investigating gynecomastia in the adult male, or only upon suspicion of a tumor in pubertal boys. In unclear cases extended investigations with additional hormonal testing of SHBG, TSH as well as kidney and liver function tests, as well as karyotyping, or DNA-analysis may be useful, depending on the individual case.

17.5.3 Pathophysiology

The following basic mechanisms can be distinguished as causes of gynecomastia (see also [Table 17.1](#))

- (a) Reduced production of androgens
- (b) Reduced availability of androgens (despite normal production)
- (c) Disturbances of the androgen receptor in the presence of normal androgen production
- (d) Increased estrogen production
- (e) Increased availability of estrogens

17.5.3.1 Physiologic Gynecomastia

Mammary tissue may be easily palpable in male newborns, a sequel of stimulation by placentally transferred maternal estrogens. This is a finding that regresses spontaneously after some time. **Adolescent gynecomastia** is another condition which usually does not require treatment (Mahoney 1990) ([Fig. 17.7](#)). Often it can be considered as a normal variant. Careful

palpation reveals some glandular tissue in up to 40% of male adolescents which, by itself, is not a pathologic finding. In about 4% of boys the degree of glandular proliferation may be more pronounced, with tissue ≥ 1 cm diameter (Kumanov et al. 2007). Beyond this extent it may become a cosmetic and psychological problem for the affected individual and require intervention. In order not to overlook any endocrine or other systemic disease basic diagnostics should be carried out (see Sect. 17.5.2 above) depending on the extent of the finding. As pubertal gynecomastia develops after inception of puberty, the degree of virilization should be registered. If no signs of puberty are present, suspicion of an endocrine cause arises, e.g., a hormone-producing tumor. There is no explanation for the fact that pubertal gynecomastia is often (significantly) accompanied by varicocele (Kumanov et al. 2007). In most cases pubertal gynecomastia regresses spontaneously, persisting in less than 5% of cases.

Persistent adolescent gynecomastia is one of the most frequent causes of gynecomastia in the adult male. Men of advanced age often display mild gynecomastia (senescent gynecomastia). This may be explained by a shift in the ratio of androgens to estrogens due to reduced androgen production or to an increase in estrogens, as aromatase activity increases with age and amount of fat tissue. This mechanism is increased by the fact that estradiol and estron are bound less strongly to SHBG than testosterone, causing the bioavailability of estrogens to increase. Side effects from medications and systemic diseases may also be involved.

17.5.3.2 Gynecomastia Caused by Reduced Androgen Production or Availability

Almost all conditions associated with **androgen deficiency** or **impaired androgen action** can present with gynecomastia. Pathological breast development is a frequent, albeit not an obligatory finding in men with **Klinefelter syndrome**. Similarly gynecomastia may be observed as part of the **XX-man syndrome**. In contrast, outright gynecomastia is fairly untypical of **Kallmann syndrome** and **idiopathic hypogonadotropic hypogonadism**. Enzyme defects of steroid biosynthesis which are associated with decreased androgen production typically go along with gynecomastia. This is the case in the 17β -hydroxydehydrogenase defect, 3β -dehydrogenase deficiency or $17, 20$ -lyase deficiency.

Table 17.1 Differential diagnosis of gynecomastia

Pseudo-gynecomastia	Lipomastia Mammary tumor
Physiological gynecomastia	Gynecomastia of the newborn Adolescent gynecomastia Gynecomastia in senescence
Pathological gynecomastia	Idiopathic gynecomastia Persistent gynecomastia of adolescence Familial gynecomastia
Disorders with a primary endocrine basis	Klinefelter syndrome XX male Ovotesticular disorder of sexual development Kallmann syndrome Idiopathic hypogonadotropic hypogonadism Hyperprolactinemia Hyperthyroidism Congenital adrenal hyperplasia Adrenomyeloneuropathy Reifenstein syndrome X linked spinal and bulbar muscular atrophy (Kennedy disease) Myotonic dystrophy Perineoscrotal hypospadias with pseudovagina Increased aromatase activity in peripheral tissue 17-Ketosteroid reductase deficiency 3 β -Hydroxysteroid dehydrogenase deficiency
Endocrine active tumors	Malignant testicular tumor Leydig/Sertoli cell tumor of the testis Aromatase-producing testicular tumor in Peutz-Jeghers syndrome Tumor of the adrenal cortex Ectopic hCG production by a malignant tumor (especially lung, liver, kidney)
Androgen deficiency due to disorders of testicular Parenchyma	Infectious orchitis Granulomatous orchitis Congenital anorchia Orchidectomy
Systemic disorders	Hepatic disease Renal disease Malnutrition Weight gain after period of malnutrition
Pharmaceutical and addictive drugs	Amphetamines Antineoplastic agents Calcium channel blockers Cimetidine Diazepam Digitalis Estrogens Flutamide Human chorionic gonadotropin Inhibitors of angiotensin-converting enzyme Isoniazid Ketokonazole Marihuana Metronidazole Opiates and opioids Penicillamins Reserpine Spironolactone Tricyclic antidepressants

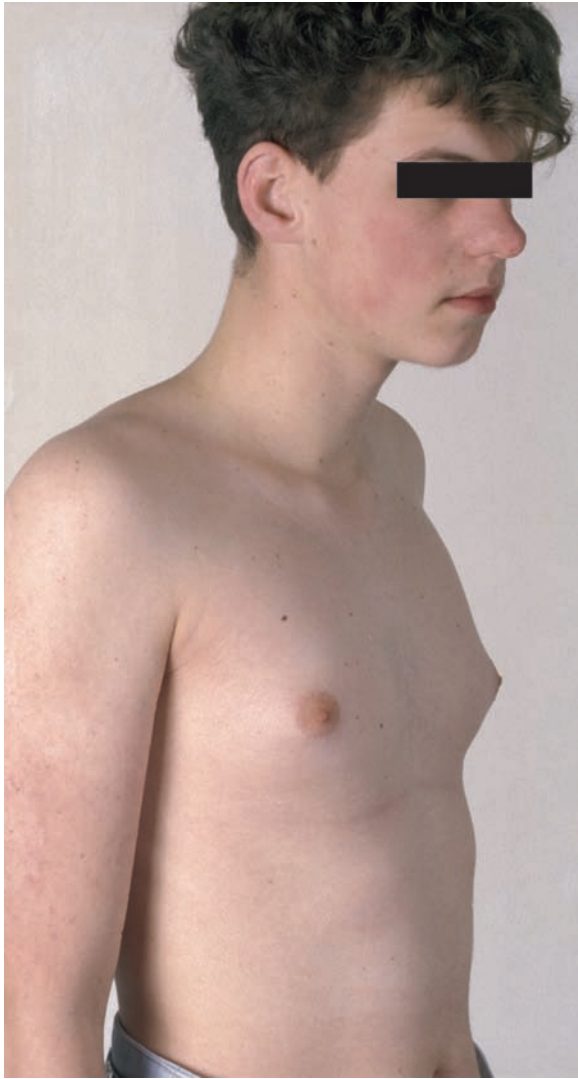

Fig. 17.7 Adolescent gynecomastia in a 16-year-old boy

Systemic diseases such as **myotonic dystrophy** or **hematochromatosis**, in the course of which testicular androgen production decreases, can be associated with gynecomastia.

17.5.3.3 Gynecomastia Caused by Androgen Insensitivity

Gynecomastia accompanying the various forms of androgen insensitivity may be explained by the lack of androgen influence (despite normal androgen production), which in turn causes a dominant effect of

estrogens (see Sect. 17.2). This also applies to **X-linked spinal and bulbar muscular atrophy** in which the transactivating capability of target genes for androgens is disturbed by expansion of the CAG repeats in exon 11 (see Sect. 17.2.4).

17.5.3.4 Gynecomastia Caused by Increased Estrogen Production

Predominance of estrogens may be caused by increased aromatase activity as well as by heightened gonadal or adrenal estrogen production.

The **aromatase gene (CYP19A1)** in 15q21.2 is under the control of various promoters which are activated by specific hormones. To date different rearrangements such as **inversions in the area of the CYP19A1 gene** have been described in only a few families with autosomal-dominant inheritance of gynecomastia and precocious puberty; these alterations are accompanied by increased aromatase activity (Shozu et al. 2003).

Increased estrogen production may be caused by tumors, especially **Leydig or Sertoli cell tumors**, as well as **adrenal tumors** whose production of androgen precursors leads to the aromatization of estrogens (Fig. 17.8). Furthermore, increased estrogen production may be the result of stimulation by hCG, caused by **teratomas** or **chorion carcinoma of the testis** as well as by **extra-gonadal tumors**, especially from the lung or liver. Differential diagnosis must also consider paraneoplastic tumors of the testis, liver, adrenals and gastrointestinal tract (Braunstein 2007).

17.5.3.5 Gynecomastia Caused by Shift in Estrogen/Androgen Availability

As the binding affinity of estradiol and estrone to SHBG is lower than that of testosterone, an increase of SHBG tends to lead to a decrease of free testosterone and to an increase of free estrogens. **Hyperthyroidism** is accompanied by increased production of SHBG, which may explain the appearance of gynecomastia in this condition (Meikle 2004).

A series of **medications** (Table 17.1) may cause gynecomastia as a side effect. For example, spironolactone tends to displace estrogens rather than androgens from SHBG, thereby causing a shift in the ratio of free



Fig. 17.8 Significant gynecomastia in a 22-year-old man that had developed over a couple of weeks and caused pain and tension. The gynecomastia was caused by a Leydig cell tumor and regressed completely after removal of the neoplasm

testosterone to free estrogens in favor of estrogens. So too can cosmetics containing estrogen-like substances such as lavender or tea tree oil lead to gynecomastia (Henley et al. 2007). Vaginal estrogen therapy of the

postmenopausal partner can cause contamination during intercourse and can cause gynecomastia.

17.5.4 Male Breast Cancer

The most important clinical **differential diagnosis** of gynecomastia is male breast cancer with an incidence of 0.5–1 per 100,000 per year (Backe 2002; Fentiman et al. 2006). Even if gynecomastia may initially be unilateral, it must raise suspicion of a tumor. A breast tumor is usually firm and located extra-areolar. Bleeding from the nipple occurs in about 10% of cases. In ambiguous cases a mammography is indicated.

Breast cancer may occur during the course of PAI. Contrary to earlier assumptions, there is no greater incidence of breast cancer in Klinefelter patients. In BRCA-2 mutations the risk of cancer in men is about 7% so that in these cases, especially if there is female breast cancer in the family anamnesis, mutation analysis of the BRCA-2 gene is indicated. Similarly in the case of BRCA-1 mutation carriers there is an increased risk which is at present not exactly quantifiable. Particular attention is demanded by breast cancers that arise during use of medications frequently leading to breast cancers. Thus the data bank of the German Drug Commission reported 32 cases of gynecomastia and six cases of breast cancer under application of finasteride (Arzneimittelkommission der Deutschen Ärzteschaft 2008).

17.5.5 Therapy

The therapy of gynecomastia depends on several factors: the underlying cause, the objective degree of gynecomastia, the patient's subjective embarrassment by the abnormality, and the spontaneous course that the lesion is expected to take without treatment. Quite frequently, no treatment at all is warranted, e.g., in cases with a very discrete degree of gynecomastia, if the patient does not feel handicapped by the abnormality, or if spontaneous remission is likely. The latter is true for most patients with adolescent gynecomastia. But even if the condition is harmless from a medical point of view, it may be onerous for the patient. Feminized appearance can lead to limited self-esteem and isolation, for example when certain activities such as sports and swimming or sexual contact are avoided.

It is wise not to be overzealous in arranging an immediate gynecomastectomy. Every patient must have undergone a complete diagnostic workup, and it is recommendable to observe the spontaneous clinical course for some time before surgical correction is undertaken. Otherwise, the operation may ablate an abnormality which is only a symptom of an underlying disorder.

If the condition can be ascribed to an underlying disorder, treatment will be directed to the basic problem. Treatment of hyperestrogenism or androgen deficiency may lead to regression of gynecomastia. However, this approach is not always successful, especially if proliferation of the glandular tissue has reached more than a minor degree and persisted for a certain time (more than a year.) and developed fibrosis which may persist. Various hormone preparations and endocrine active medications (e.g., testosterone, dihydrotestosterone, danazol, clomiphene, tamoxifen) have been tried in patients without documented hormone disturbances (Braunstein 2007). In a retrospective study on patients with idiopathic gynecomastia who were treated with the antiestrogen tamoxifen (20 mg daily for 3 months) 78% of the patients showed complete remission. Patients treated with danazol showed a remission rate of 40%. If after 3 months no improvement is seen, a gynecomastectomy can be considered. This operation should be carried out by an experienced surgeon to achieve the best possible cosmetic results. It goes without saying that prior to such therapy side effects of medications or a hormone-producing tumor (e.g., Leydig cell tumor) must be excluded.

17.6 Androgenetic Alopecia

17.6.1 Epidemiology and Pathophysiology

Androgenetic alopecia is the most frequent form of alopecia and can affect both men and women. Among Caucasians every second male develops alopecia. It is less prevalent among other ethnic populations (e.g., Asians). Even if androgenetic alopecia can be considered as a “physiological” event without real pathological implications, it can induce suffering among young men.

Hair growth follows a periodic cycle; its dynamics depend on the localization of the hair follicle. Following the active growth phase (anagen phase) there is a brief phase of regression (catagen phase) which gives way to a resting phase (telogen phase). Thereafter the hair falls out. Daily hair loss amounts up to 100 hairs. Normally the anagen phase lasts 3 years and the telogen phase only 100 days so that the ratio of anagen to telogen hair is 9:1. In androgenetic alopecia the anagen phase is shortened (Randall 2004).

Genetic association studies indicate that a certain variant (SNPrs6152) of the androgen receptor gene represents a disposing factor for androgenetic alopecia (Ellis et al. 2007). The importance of the androgen receptor polymorphism for the development of alopecia is borne out by the fact that men with Kennedy disease, i.e., men with a high number of CAG repeats are protected from alopecia (Sinclair et al. 2007). In the meantime further genomic regions have been identified which obviously contain susceptibility genes for androgenetic alopecia (Hillmer et al. 2008).

17.6.2 Diagnosis

Androgenetic alopecia typically begins with bitemporal hair loss during early adult age. Its further progression is variable with respect to extent and localization and can be classified according to the Hamilton nomenclature (Norwood 1975) (Fig. 5.2).

Family anamnesis is particularly important as familial occurrence is typical. An autosomal-dominant inheritance with variable expressivity is assumed. Diseases which may be associated with hair loss, such as hyperthyroidism, malignomas, hepatopathies, iron-deficiency anemia and diabetes mellitus should be excluded. However, in these diseases alopecia tends to be diffuse. High doses of vitamin A, cholesterol-lowering medication as well as toxicants such as thallium and mercury can lead to rapid hair loss. Special hormonal investigations are of little diagnostic help.

17.6.3 Therapy

Patients with congenital androgen deficiency will generally not develop androgenetic alopecia. Systemically effective antiandrogens can also prevent androgenetic

alopecia but are not acceptable as therapy because of the accompanying effects of hypogonadism. By specific inhibition of the 5 α -reductase type, 2 e.g., by finasteride, which is also used for treating prostate hypertrophy and which is available for treating alopecia as Propecia[®], progression of the disease can be prevented (Kaufman et al. 2004). Earlier controlled studies confirmed that topical application of Minoxidil[®], originally used as an antihypertensive drug, led to increased hair growth within 4–6 months.

References

- Allera A, Herbst MA, Griffin JE, Wilson JD, Schweikert HU, McPhaul MJ (1995) Mutations of the androgen receptor coding sequence are infrequent in patients with isolated hypospadias. *J Clin Endocrinol Metab* 80:2697–2699
- Arzneimittelkommission der Deutschen Ärzteschaft (2008) Eine Gynäkomastie durch Finasterid kann die Diagnose eines Mammakarzinoms beim Mann verzögern. *Dtsch Arztebl* 105:C2038
- Backe J (2002) Brustkrebs beim Mann. *Dtsch Arztebl* 99: A1168–1172
- Braunstein GD (2007) Gynecomastia. *New Engl J Med* 357: 1229–1237
- Carani C, Qin K, Simoni M, Faustini-Fustini M, Serpente S, Boyd J, Korach KS, Simpson ER (1997) Effect of testosterone and estradiol in a man with aromatase deficiency. *N Engl J Med* 337:91–95
- Ellis JA, Scurrah KJ, Cobb JE, Zaloumis SG, Duncan AE, Harrap SB (2007) Baldness and the androgen receptor: The AR polyglycine repeat polymorphism does not confer susceptibility to androgenetic alopecia. *Hum Genet* 121: 451–457
- Faustini-Fustini M, Rochira V, Carani C (1999) Oestrogen deficiency in men: Where are we today? *Eur J Endocrinol* 140: 111–129
- Fentiman IS, Fourquet A, Hortobagyi GN (2006) Male breast cancer. *Lancet* 367:595–604
- Gottlieb B, Beitel LK, Wu JH, Trifiro M (2004) The androgen receptor gene mutations database (ARDB): 2004 update. *Hum Mutat* 23:527–533
- Griffin JE, McPhaul M, Russell DW, Wilson JD (1995) The androgen resistance syndromes: Steroid 5 α -reductase 2 deficiency, testicular feminization, and related disorders. In: Scriver CE, Beaudet al, Sly WS, Valle D (eds) *The metabolic and molecular bases of inherited disease*, vol II, 7th edn. McGraw-Hill, New York, pp 2967–2998
- Grumbach MM, Conte FA (1991) Disorders of sex differentiation. In: Wilson JD, Foster DW (eds) *Textbook of endocrinology*. W.B. Saunders, Philadelphia, PA, pp 853–951
- Han TS, Goswami D, Trikudanathan S, Creighton SM, Conway GS (2008) Comparison of bone mineral density and body proportions between women with complete androgen insensitivity syndrome and women with gonadal dysgenesis. *Eur J Endocrinol* 159:179–185
- Henley DV, Lipson N, Korach KS, Bloch C (2007) Prepubertal gynecomastia linked to lavender and tea tree oil. *N Engl J Med* 356:479–485
- Hillmer AM, Flaquer A, Hanneken S, Eigelshoven S, Kortüm AK, Brockschmidt FF, Golla A, Metzen C, Thiele H, Kolberg S, Reinartz R, Betz RC, Ruzicka T, Hennies HC, Kruse R, Nöthen MM (2008) Genome-wide scan and fine-mapping linkage study of androgenetic alopecia reveals a locus on chromosome 3q26. *Am J Hum Genet* 82:737–743
- Hughes IA, Houk C, Ahmed SF, Lee PA (2006) Consensus statement on management of intersex disorders. *J Ped Urol* 2:148–162
- Hurt WG, Bodurtha JN, McCall JB, Ali MM (1989) Seminoma in pubertal patient with androgen insensitivity syndrome. *Am J Obstet Gynecol* 161:530–531
- Imperato-McGinley J, Zhu YS (2002) Androgens and male physiology the syndrome of 5-alpha-reductase-2 deficiency. *Mol Cell Endocrinol* 198:51–59
- Imperato-McGinley J, Peterson RE, Gautier T, Cooper G, Danner R, Arthur A, Morris PL, Sweeney WJ, Shackleton C (1982) Hormonal evaluation of a large kindred with complete androgen insensitivity: evidence for secondary 5 α -reductase deficiency. *J Clin Endocrinol Metab* 54: 931–941
- Kaufman KD (2004) Clinical use of 5 α -reductase inhibitors. In: Nieschlag E, Behre HM (eds) *Testosterone: action, deficiency, substitution*, 3rd edn. Springer, Heidelberg, pp 571–596
- Krause A, Sinnecker GH, Hiort O, Thamm B, Hoepffner W (2004) Applicability of the SHBG androgen sensitivity test in the differential diagnosis of 46,XY gonadal dysgenesis, true hermaphroditism, and androgen insensitivity syndrome. *Exp Clin Endocrinol Diabetes* 112:236–240
- Kumanov P, Deepinder F, Robeva R, Tomova A, Li J, Agarwal A (2007) Relationship of adolescent gynecomastia with varicocele and somatometric parameters: a cross-sectional study in 6,200 healthy boys. *J Adolesc Health* 41:126–131
- LaSpada AR, Roling DB, Harding AE, Warner CL, Spiegel R, Hausmanova-Petrusewicz I, Woon-Chee Y, Fischbeck KH (1992) Androgen receptor gene mutations in X-linked spinal and bulbar muscular atrophy. *Nature Genetics* 2:301–304
- Lanfranco F, Zirilli L, Baldi M, Pignati E, Corneli G, Ghigo E, Aimaretti G, Carani C, Rochira V (2008) A novel mutation in the human aromatase gene: Insights on the relationship among serum estradiol, longitudinal growth and bone mineral density in an adult man under estrogen replacement treatment. *Bone* 43:628–635
- Lobaccaro JM, Lumbroso S, Belon C, Galtier-Dereure F, Bringer J, Lesimple T, Namer M, Cutuli BF, Pujol H, Sultan C (1993) Androgen receptor gene mutation in male breast cancer. *Hum Mol Genet* 2:1799–1802
- Maffei B, Murata Y, Rochira V, Tubert G, Aranda C, Vazquez M, Clyne CD, Davis S, Simpson ER, Carani C (2004) Dysmetabolic syndrome in a man with a novel mutation of the aromatase gene: Effects of testosterone, alendronate, and estradiol treatment. *J Clin Endocrinol Metab* 89:61–70
- Mahoney CP (1990) Adolescent gynecomastia. Differential diagnosis and management. *Ped Clin North Am* 6: 1389–1404
- Meikle AW (2004) The interrelationships between thyroid dysfunction and hypogonadism in men and boys. *Thyroid* 14(Suppl 1):S17–S25

- Norwood OT (1975) Male pattern baldness: Classification and incidence. *South Med J* 68:1359–1365
- Quigley CA (1998) The androgen receptor: Physiology and pathophysiology. In: Nieschlag E, Behre HM (eds) *Testosterone: action, deficiency, substitution*, 2nd edn. Springer, Heidelberg, pp 33–106
- Randall VA (2004) Androgens and hair: The biological paradox. In: Nieschlag E, Behre HM (eds) *Testosterone: action, deficiency, substitution*, 3rd edn. Springer, Heidelberg, pp 207–231
- Rodien P, Mebarki F, Mowszowicz I, Chaussain JL, Young J, Morel Y, Schaison G (1996) Different phenotypes in a family with androgen insensitivity caused by the same M780I point mutation in the androgen receptor gene. *J Clin Endocrinol Metab* 81:2994–2998
- Rutgers JL, Scully RE (1991) The androgen insensitivity syndrome (testicular feminization): a clinicopathological study of 43 cases. *Int J Gynecol Pathol* 10:126–144
- Shozu M, Sebastian S, Takayama K, Hsu WT, Schultz R, Neely K, Bryant M, Bulun SE (2003) Estrogen excess associated with novel gain-of-function mutations affecting the aromatase gene. *New Engl J Med* 348:1855–1865
- Sinclair R, Greenland KJ, Egmond S, Hoedemaker C, Chapman A, Zajac JD (2007) Men with Kennedy disease have a reduced risk of androgenetic alopecia. *Br J Dermatol* 157: 290–294
- Sinnecker GHG, Hiort O, Dibbelt L, Albers N, Dörr HG, Hauß H, Heinrich U, Hemminghaus M, Hoepffner W, Holder M, Schnabel D, Kruse K (1996) Phenotypic classification of male pseudohermaphroditism due to steroid 5 α -reductase 2 deficiency. *Am J Med Genet* 63:223–230
- Smith EP, Boyd J, Frank GR, Takahashi H, Cohen RM, Specker B, Williams TC, Lubahn DB, Korach KS (1994) Estrogen resistance caused by a mutation in the estrogen-receptor gene in a man. *New Engl J Med* 331:1056–1061
- Wieacker P, Knoke I, Jakubiczka S (1998) Clinical and molecular aspects of androgen receptor defects. *Exp Clin Endocrinol Diabetes* 106:446–452
- Wilson JD, Griffin JE, Russell DW (1993) Steroid 5 α -reductase 2 deficiency. *Endocr Rev* 14:577–593
- Wooster R, Mangion J, Eccles R, Smith S, Dowsett M, Averill D, Barrett-Lee P, Easton DF, Ponder BAJ, Stratton MR (1992) A germ-line mutation in the androgen receptor gene in two brothers with breast cancer and Reifenstein syndrome. *Nat Genet* 2:132–134
- Yong EL, Ng SC, Roy AC, Yun G, Ratman SS (1994) Pregnancy after hormonal correction of severe spermatogenic defect due to a mutation in androgen receptor gene. *Lancet* 344:826–827

Contents

18.1	Background	339
18.2	Mechanisms of Reproductive Disruption by Systemic Diseases	339
18.2.1	Onset of Hypogonadism	340
18.2.2	Level of Disruption in the Male Reproductive Axis	340
18.3	Specific Diseases and Disorders	341
18.3.1	Renal Disease	341
18.3.2	Liver Disease	342
18.3.3	Respiratory Diseases	344
18.3.4	Malignant Disease	345
18.3.5	Neurological Diseases	346
18.3.6	Gastrointestinal Diseases	349
18.3.7	Hematological Diseases	349
18.3.8	Endocrine and Metabolic Diseases	350
18.3.9	Immune Diseases	351
18.3.10	Infectious Diseases	352
18.3.11	Cardiovascular Diseases	353
18.3.12	Dermatological Diseases	354
18.3.13	Other Chronic Diseases	354
18.4	Therapeutic Implications	355
	References	356

18.1 Background

Systemic non-testicular illness has major effects on the testis although these have not always been sufficiently recognized. The clinical management of any medical disorder should include careful consideration of the effects of illness and its treatment on male reproductive health (including fertility, androgenic status and sexual function).

Men value highly their **reproductive health** as part of a full life. Consequently its preservation is an essential consideration in medical care and dissatisfaction can be anticipated should the focus on the presenting disease and its treatment neglect the often unstated, but nevertheless deeply felt, men's expectations that they retain full reproductive functions.

This chapter will highlight the impact of systemic, non-testicular disease on testicular function. In a first part, pathophysiological mechanisms for testicular dysfunction are considered, while the second part highlights specific diseases and their treatment by organ system. Sexual dysfunction and testosterone deficiency or its treatment are covered in other chapters (Chaps. 16, 21, 26) while drug effects on testicular function, a field still remarkably understudied, is covered only in connection with specific diseases for which they are prescribed.

18.2 Mechanisms of Reproductive Disruption by Systemic Diseases

The clinical reproductive effects of non-testicular illnesses depend on the epoch of life as well as the severity and chronicity of the underlying disease. Male

G. A. Sartorius (✉)
University Women's Hospital Basel, Spitalstrasse 21
Ch-4031 Basel, Switzerland
e-mail: gsartorius@uhbs.ch

reproductive dysfunction can result from selective impact on a specific level of the hypothalamic-pituitary-gonadal axis, but often in chronic non-testicular disease, multiple levels are affected concurrently. The duration and reversibility of testicular axis disruption depends on severity and the pathophysiological mechanisms involved in the underlying disease and its treatment. Disruptions of spermatogenesis can be transient, lasting from less than one spermatogenic cycle, typically associated with non-specific features such as fever, weight loss or cytokine effects of non-testicular illness. They may persist for prolonged periods or even being irreversible following cytotoxic drug treatment for cancer or other serious diseases.

18.2.1 Onset of Hypogonadism

The expression of **androgen deficiency** is distinctive at different epochs of life. Prenatal androgen deficiency produces various degrees of incomplete development of male internal and external genitalia, varying from complete absence of masculine sexual development to various degrees of hypospadias, gynecomastia and/or cryptorchidism. Pubertal androgen deficiency manifests as delayed puberty, eunuchoidal skeletal proportions and impaired virilization, whereas postpubertal androgen deficiency may present with the well-known classical features of androgen deficiency in adults (see Chap. 5).

As it is not life threatening, androgen deficiency occurring in association with chronic disease is readily overlooked and may remain underdiagnosed. Such underrecognition is particularly likely when the relatively subtle effects of androgen deficiency are overshadowed by a major systemic illness with more dramatic clinical features.

Most classical features of androgen deficiency, apart from hot flushes in castrate men, are manifestations of prolonged, moderate to severe androgen deficiency.

Defects in spermatogenesis are only manifest after puberty and, having no symptoms other than **infertility**, are only detected during the diagnostic evaluation for infertility or incidentally (e.g., cryostorage prior to gonadotoxic treatments) (see Chap. 24).

18.2.2 Level of Disruption in the Male Reproductive Axis

Non-testicular diseases can disrupt different levels of the hypothalamic-pituitary-testicular axis. GnRH, and consequently gonadotropin, secretion can be suppressed by acute or chronic diseases via disruption of hypothalamic regulatory mechanisms, while additionally or alternatively underlying chronic diseases may impact directly on Leydig cell steroidogenesis or spermatogenesis.

Severe or chronic systemic illnesses often produce characteristically defective hypothalamo-pituitary axis regulation, which is similar in mechanism to the physiological mechanism operative in puberty as well as in the annual gonadal cycles of seasonal breeding animals. The mechanism characteristically involves a triad of features: inhibition of GnRH secretion, hypersensitivity to negative testicular feedback and resistance to naloxone which has been termed **ontogenic regression** (Handelsman and Dong 1992, 1993). Ontogenic regression involves a reversible variation in sensitivity to negative testicular feedback which causes coordinate changes in gonadotropin and testosterone secretion during periods of stress unfavorable to reproductive activity. By facilitating an orderly withdrawal of reproductive function, ontogenic regression facilitates its orderly recrudescence when more favorable environmental circumstances once again prevail.

Ontogenic regression is a common underlying mechanism in a variety of systemic diseases, including chronic renal, respiratory, liver, inflammatory, nutritional diseases as well as acute critical illness and severe burns. It is presumably an archaic adaptive physiological mechanism invoked by adverse environmental circumstances ensuring that no overall reproductive fitness is lost in times unfavorable for successful reproduction, while retaining the capacity for successful recovery when more favorable circumstances return. In the context of chronic disease, the impact of chronic organ failure and transplantation is a particularly clear exemplar of ontogenic regression, both in its negative and positive human applications.

Ontogenic regression refers to the orderly regression of reproductive function in a fashion that permits facile recrudescence when more favorable environment prevails. This mechanism may have evolved for species propagation to defer reproductive activity until more favorable circumstances return.

Most severe systemic non-gonadal illness or trauma such as **burns, myocardial infarction, traumatic or surgical injury, and acute critical illness** (Woolf et al. 1985; Dong et al. 1992) depress testicular function as evidenced by low blood testosterone levels, unchanged immunoreactive inhibin levels, decreased or mildly increased immunoreactive gonadotropin levels with low bioactive LH levels and abolition of pulsatile LH secretion (Woolf et al. 1985; Semple et al. 1987; Dong et al. 1992). Such **transient biochemical androgen deficiency (secondary hypogonadism)** is so common that it should be considered a regular accompaniment of severe acute or chronic illness. Secondary hypogonadism is even more frequent than hypothyroidism (historically once misnamed the “sick thyroid” syndrome) as different facets of reversible, functional hypopituitarism due to systemic non-gonadal illness. In theory, severe and sustained androgen deficiency caused by a chronic disease may contribute to morbidity of the underlying disease. Nevertheless to determine whether biochemical androgen deficiency is deleterious, incidental or even protective requires well-designed RCTs evaluating short and long-term effects of physiological androgen replacement. However, the primary focus of this chapter is a review of observational studies outlining the impact of systemic non-gonadal disease on the testicular axis. Therapeutic studies of physiological androgen replacement or pharmacological androgen therapy in systemic non-gonadal diseases are reviewed in detail elsewhere (Liu and Handelsman 2004).

Testicular function is depressed by common features of systemic illness such as **cytokines, fever** (Kandeel and Swerdloff 1988; Carlsen et al. 2003), **weight loss** and **chronic illness or catabolism** (Handelsman and Staraj 1985) and distinguishing between these effects is difficult. Extremes of nutrition influence testicular function but **male reproductive function is more robust than the female reproductive system** during catabolic states such as undernutrition, trauma and extreme physical exertion. **Strenuous physical exercise** has minimal effects on testicular function and spermatogenesis among elite athletes (Bagatell and Bremner 1990) but extreme physical exertion causes profound inhibition of testicular androgen secretion (e.g., Schürmeyer et al. 1984; Stroud et al. 1997) which may be modified by long-term anaerobic training (Slowinska-Lisowska and Majda 2002).

Disruption of spermatogenesis can lead to infertility primarily through reduction in the number of ejaculated sperm and possibly also in sperm function. The

intense cellular and DNA replication of the germinal epithelium makes it singularly susceptible to cytotoxins such as ionising irradiation, cytotoxic drugs (notably alkylating agents), other therapeutic agents (e.g., some antibiotics) and occupational or environmental exposures (see Chap. 19). Such agents cause all degrees of hypospermatogenesis from reversible depression to permanent ablation from germinal stem cell depletion. As spermiogenesis forms the morphological basis for sperm function, interruption at this stage of spermatogenesis can produce hypofunctional (infertile) sperm.

Age is a crucial modifier of testicular response to systemic illness (see Chap. 14). The maturing hypothalamic-pituitary-testicular axis has heightened susceptibility, making adolescents particularly vulnerable to delayed puberty during chronic illness. Aging men exhibit decreased testosterone levels while SHBG and gonadotropin levels increase, changes which are markedly accentuated by the coexistence of chronic illness and/or its treatment. These changes reflect common alterations in hypothalamic function as features of ontogenic regression including decrease in testosterone, alterations in pulsatile LH secretion and sensitivity to both negative steroidal feedback and opioids as well as the corresponding testicular manifestation such as progressive decreases in testis size, cell content and spermatogenesis.

Drugs may impair androgen action through numerous distinct and sometime multiple mechanisms including (i) decreasing LH secretion (e.g., opiates), (ii) inhibiting steroidogenic enzymes (e.g., aminoglutethimide, ketoconazole, finasteride, dutasteride), (iii) increased testosterone metabolism (e.g., barbiturates, anticonvulsants and other hepatic enzyme inducers), (iv) androgen receptor antagonists blocking testosterone action (e.g., cimetidine, spironolactone, cyproterone acetate), or (v) acting as physiological antagonists of androgen action (estrogenic effects of digoxin, drug-induced hyperprolactinemia). Very few therapeutic drugs, however, have had their potential effects on the human male reproductive system studied in detail (see Chap. 19).

18.3 Specific Diseases and Disorders

18.3.1 Renal Disease

Reduced renal function may lead to androgen deficiency and abnormal spermatogenesis. Depending on

the time of onset, gonadal dysfunction manifests as delayed puberty in adolescents and/or as testicular atrophy, impaired spermatogenesis, infertility, sexual dysfunction or gynecomastia in adult men.

Renal failure leads to alterations at different levels of the hypothalamo-pituitary axis with alterations in the hypothalamic regulation of pituitary gonadal function being predominant, rather than peripheral defects intrinsic to the testis. Inhibition of both spermatogenesis and steroidogenesis accompanied by modest to minimal reflex increases in gonadotropins, together with testicular histological features are indicative of a functional hypogonadotropic state (Handelsman and Dong 1993). However, the markedly reduced gonadotropin clearance rates in uremia mask the effects of gonadotropin secretion which is inappropriately low for the reduced testosterone production rates. Consequently, despite low blood testosterone levels, the failure of appropriate rises in blood LH levels, together with defects in pulsatile LH secretion and aberrant hypothalamic opiateergic regulation of gonadotropin secretion, reflect the predominance of aberrant hypothalamic regulation in the pathogenesis of human uremic hypogonadism, as a characteristic manifestation of ontogenic regression. GnRH pulse frequency is preserved, while the pulse strength is decreased, which leads to a decrease in LH per burst, but unchanged frequency of plasma LH pulses (Veldhuis et al. 1993). Additional secondary consequences of the underlying uremia and its treatment include relative LH insensitivity of Leydig cells (Dunkel et al. 1997), increased whole body metabolic clearance of testosterone (Handelsman and Dong 1993) and impaired spermatogenesis (Prem et al. 1996).

Acute **renal failure** is accompanied by decreased testosterone levels with minimal changes in gonadotropin or SHBG levels and preserved responses to GnRH stimulation, also consistent with hypothalamic (secondary) hypogonadism that is reversed following recovery of renal function. Experimental studies in rodents confirm the predominance of aberrant hypothalamic regulation of pituitary gonadal function in the pathogenesis of uremic hypogonadism.

Reproductive dysfunction becomes evident at an early stage of acute or chronic renal failure; deterioration during **maintenance peritoneal or hemodialysis** is fully reversed only by successful **renal transplantation**.

Most men with pre-dialysis uremia have low or low-normal testosterone levels and the prevalence and severity of biochemical androgen deficiency increase in patients requiring dialysis (Handelsman 1985;

Albaaj et al. 2006). Renal transplantation is the only effective treatment to restore testicular function and reverses most of the disturbances in testosterone secretion and spermatogenesis (Prem et al. 1996; Akbari et al. 2003; Yadav et al. 2008). Nevertheless, a minority of men with successful renal transplants have mild persistent biochemical androgen deficiency (Albaaj et al. 2006) and impaired spermatogenesis (Inci et al. 2006), probably attributable to the incomplete normalization of renal function. Despite the consistent findings of androgen deficiency in chronic uremia, controlled studies of androgen replacement therapy are scarce but promising (Ballal et al. 1991; Johansen et al. 1999).

Pharmacokinetics of transdermal testosterone in men with end-stage renal failure are comparable to healthy hypogonadal men (Singh et al. 2001), so that it can be used for androgen-deficient men with renal failure. Even if testosterone replacement therapy is not warranted, pharmacological testosterone treatment may have benefits for men with chronic renal insufficiency. For example, pharmacological androgen therapy with testosterone or synthetic androgens as adjuvant therapy for renal anemia (Ballal et al. 1991; Teruel et al. 1996), undernutrition (Johansen et al. 1999; Eiam-Ong et al. 2007) and osteodystrophy (Doumouchtsis et al. 2008) during pre-dialysis and dialysis phases are well established and often considered as reasonably effective but low-cost alternatives to modern expensive treatments such as erythropoietin or bisphosphonates, respectively.

Claims that other treatments, including suppression of hyperprolactinemia, zinc supplementation or erythropoietin, improve testicular function are not confirmed in well-controlled studies. Conventional immunosuppressive regimens involving prednisone, azathioprine, cyclosporin A, mycophenolate mofetil or rapamycin inhibitors (sirolimus, tacrolimus, everolimus) appear to have little or no consistent clinically significant effects on human testicular function. However, the limitation of retrospective studies makes it hard to evaluate observational reports of potential adverse effects (Tondolo et al. 2005; Zuber et al. 2008).

18.3.2 Liver Disease

Acute liver disease including *hepatitis* causes marked increases in circulating SHBG levels, resulting in reflex increases in gonadotropin and sex steroid secretion to

maintain testicular testosterone output and tissue androgen supply. The pathophysiological significance of such transient biochemical disturbance during acute illness remains unclear.

Chronic liver failure is associated with prominent features of hypogonadism, including infertility, impaired spermatogenesis, testicular atrophy, gynecomastia, reduced body hair and sexual dysfunction.

Testosterone production rate is decreased, leading to lower circulating testosterone levels, although the concomitant increases in circulating SHBG levels (Luppa et al. 2006) with a consequential fall in testosterone clearance rate masks the severity of the androgen deficiency. Despite subnormal testosterone levels, gonadotropin levels remain in the low to normal eugonadal range with diminished pulsatile LH secretion, emphasizing the importance of hypothalamic dysregulation in the pathogenesis of hypogonadism in chronic liver disease (van Thiel et al. 1981). In chronic liver disease, increased circulating testosterone may represent a risk factor for hepatocellular carcinoma, explaining the male preponderance of that cancer (Tanaka et al. 2004).

Experimental data suggests that porto-caval shunting, aromatase over-expression or insulin-like growth factor I deficiency have all been attributed possible roles in gonadal dysfunction due to cirrhosis, although none are yet confirmed in humans (Castilla-Cortazar et al. 2000, 2004).

As **alcohol** is the most common cause of chronic liver failure in affluent societies, the usual clinical features of chronic liver disease are an amalgam of clinical manifestations due to chronic liver disease per se and chronic alcoholic toxicity (see also Sect 18.3.13). Men with alcoholic liver disease exhibit distinctly higher gonadotropin levels suggestive of additional direct testicular damage from alcohol, in addition to the predominantly hypothalamic effects of chronic liver failure; men with liver failure tend to have inappropriately low gonadotropin levels, especially with severe hepatic failure and coma where gonadotropin levels are markedly reduced.

Apart from direct alcohol toxicity on the testis (Villalta et al. 1997), the major pathogenic factors for reproductive effects of liver disease are the loss of hepatic parenchyma and portacaval shunting (leading to possible cerebral dopamine excess), but their relative roles remain to be clarified. In general, the amount of residual functional liver tissue correlates with the degree of biochemical androgen deficiency. Similarly the testicular endocrine dysfunction (Handelsman

et al. 1995) and consequences of partial androgen deficiency to the prostate (Jin et al. 1999) are proportional to the severity of the underlying liver function (van Thiel et al. 1981; Kaymakoglu et al. 1995) and are reversed by successful **liver transplantation** (van Thiel et al. 1990; Handelsman et al. 1995).

Testosterone administration improves sense of well-being, increases serum proteins and reduces edema without serious adverse effects (Puliyel et al. 1977; Kley et al. 1979; Gluud et al. 1981), but comprehensive meta-analysis of the best available evidence indicates no significant or sustained clinical or biochemical benefits. The current standard treatment of chronic hepatitis C with interferon alpha2b and ribavirin causes reduced blood testosterone levels, without consistent change in LH, FSH or SHBG levels, an effect that is reversible after cessation of treatment (Kraus et al. 2005), consistent with a direct drug effect and/or an effect mediated via improvement of the underlying illness and amelioration of the ontogenic regression mechanisms.

Men with **chronic active hepatitis** requiring immunosuppression have essentially normal spermatogenesis despite *azathioprine* doses of up to 150 mg daily (Lange et al. 1978). Little information is available about semen parameters in other chronic liver diseases.

Systemic **iron overload** due to either genetic or acquired posttransfusional **hemochromatosis** often causes hypogonadotropic hypogonadism due to pituitary iron deposition, causing relatively selective damage to gonadotropes. **In more advanced disease**, the additional effects of **cirrhosis and diabetes** further highlight the clinical presentation of androgen deficiency. This disorder once frequently presented with progressive androgen deficiency in middle-aged men that was readily amenable to androgen replacement therapy or, if fertility is required, gonadotropin therapy. Iron overload-induced hypogonadism is rarely reversed by iron desaturation from venesection and/or iron chelation except in younger (<40 years) men (Cundy et al. 1993). **Testosterone replacement therapy** is often necessary and effective both symptomatically (Kley et al. 1992) and in restoring bone density loss due to androgen deficiency (Diamond et al. 1991). Gonadotropin induction of spermatogenesis is particularly effective in genetic **hemochromatosis**, as the onset of gonadotropin deficiency follows a normal puberty while pulsatile GnRH therapy is ineffective since gonadotropin secretion cannot be induced (Wang et al. 1989).

The discovery of the genetic defect in hemochromatosis and development of effective pre-symptomatic family and community screening has dramatically reduced, but not eliminated, the late presentations of genetic hemochromatosis with overt clinical manifestations of androgen deficiency. For post-transfusional iron overload see Sect. 18.3.7.

18.3.3 Respiratory Diseases

Chronic sinopulmonary infections (recurrent bronchitis, bronchiectasis, chronic sinusitis and/or otitis media) are associated with infertility due to **Young syndrome, cystic fibrosis (CF)** and **dyskinetic cilia syndromes** (including **immotile cilia** and **Kartagener syndrome**).

Both Young syndrome and CF have obstructive azoospermia which is due to congenital absence of the vas deferens in CF, whereas in Young syndrome the epididymis and vas deferens are anatomically intact but the epididymis becomes obstructed intraluminally by inspissated secretion (Handelsman et al. 1984). In contrast, the excurrent ductular system and sperm output are normal in dyskinetic cilia syndromes but sperm are immotile due to defects in axonemal function (Neugebauer et al. 1990), although rare variants of the dyskinetic cilia syndromes lacking respiratory disease, with ciliary defects restricted to lungs or sperm or with ductular obstruction, have been described.

Classical CF, due to mutations in the CFTR gene, is also associated with **delayed puberty** attributable to both chronic illness and suboptimal nutrition from exocrine pancreatic dysfunction. Nearly all (95%) men with CF have congenital bilateral absence of vas deferens (CBAVD), but CBAVD alone is recognized as a primarily genital variant of CF, with most affected men carrying compound heterozygotes for two different CFTR mutations. The most frequent mutations associated with CBAVD are the $\Delta F508$ deletion of the CFTR gene and an intron 8 variant (IVS8–5T) (Chillon et al. 1995), but approximately 1,500 other mutations of this gene have been identified so far, most of them being single nucleotide changes, often “private” to a particular family. This profusion of genotypes makes screening for sporadic cases difficult as it is impossible to screen comprehensively for all mutations, many of which probably remain undiscovered. However, as ART can regularly achieve paternity from testicular

sperm aspiration (Hubert et al. 2006) every child is an obligate CF carrier and well-informed genetic counselling is essential. What determines the clinical pattern of disease (CF vs CABVD) remains an intriguing biological puzzle (Southern 2007) (see Chap. 15).

About half of the male patients with **sarcoidosis** show hypogonadotropic hypogonadism independent of glucocorticoid usage. Neural involvement in 5% can produce hypogonadotropic hypogonadism by pituitary infiltration (Bullmann et al. 2000). The lack of specific morphologic findings in the reproductive tract is consistent with an effect of chronic disease ontogenetic regression mechanism. Whether the low circulating testosterone levels contribute to the fatigue, muscle weakness and depressed mood remains to be established (Spruit et al. 2007).

Obstructive **sleep apnea** is associated with sexual dysfunction and lowered testosterone levels without reflex rise in gonadotropin levels indicative of a central hypogonadotropic mechanism (Grunstein et al. 1989). These effects, which can be reversed by mechanical maintenance of upper airways patency without weight loss (Grunstein et al. 1989) occur commonly together with obesity and symptoms of the metabolic syndrome (Liu et al. 2007). The relative contributions of hypoxia and sleep fragmentation to this central hypogonadism remain to be clarified. Testosterone administration can precipitate obstructive sleep apnea in some predisposed obese men (Sandblom et al. 1983) and adverse short-term effects on sleep and breathing at higher doses in older men (Liu et al. 2003b) by blunting ventilatory drive and/or chemoreceptor sensitivity (Matsumoto et al. 1985; Schneider et al. 1986). Results of RCTs suggest that high-dose administration of testosterone may have adverse short-term effects on sleep and breathing (Liu et al. 2003b), but the effects of lower doses remain to be evaluated.

Chronic Obstructive Pulmonary Disease (COPD) is associated with pubertal delay due to chronic illness and systemic corticosteroid therapy but the reported effects on postpubertal male reproductive function remain inconclusive. Biochemical androgen deficiency in COPD (Kamischke et al. 1998) has been related to hypoxemia, systemic inflammation and use of corticosteroids impacting upon hypothalamic-pituitary axis regulation consistent with an underlying ontogenetic regression mechanism. For example, among 138 men with COPD, an exacerbation led to decreased circulating testosterone levels (positively correlated with

PaO₂) and a reflex increase in gonadotropins which were normalized in parallel with improvement in arterial blood gases during recovery (Makarevich 2003; Laghi et al. 2005; Karadag et al. 2007). Some evidence suggests adverse effects of long-term glucocorticoid treatment such as muscle or bone loss can be overcome by androgen therapy (Reid et al. 1996; Crawford et al. 2003). Emphysema due to genetic α_1 -antitrypsin deficiency is associated with normal testicular function and fertility. The late onset of severe symptoms may explain the unusually high prevalence of this deleterious genetic disease which presumably fails to impair genetic “fitness” until after reproductive age.

18.3.4 Malignant Disease

Cancer and its treatment with cytotoxic drugs or irradiation has dramatic effects on male reproductive function and regularly produces transient or permanent spermatogenic damage, infertility and, less often, androgen deficiency (Howell and Shalet 2005). This particularly concerns the common malignancies of male reproductive life that are medically treated with curative intent during reproductive life comprising testicular (teratoma, seminoma) and hematological (Hodgkin and non-Hodgkin lymphoma) tumors and sarcomas. Although family planning is often an important issue for men of reproductive age with cancer, some men are still not well informed about infertility as a common side effect of cancer treatments. A survey of US male cancer patients aged 14–40 years revealed that 51% wanted children in the future, but only 60% recalled being informed about infertility as a side effect of the treatment (Schover et al. 2002).

Virtually all men presenting with cancer demonstrate moderate testicular dysfunction including particularly depression of spermatogenesis even prior to cytotoxic treatment. The pathogenetic mechanisms remain unclear, but contributions from fever, weight loss, diagnostic procedures or cytokines as well as ontogenetic regression effects of chronic disease are likely to contribute and are hard to differentiate. Cancer patients often develop a decrease in muscle mass, anorexia, weakness, fatigue, depression and sexual dysfunction. Such non-specific symptoms are difficult to distinguish from symptoms of androgen deficiency. While serum FSH is consistently increased in proportion to the

degree of germinal damage from cytotoxic cancer treatments, changes in the circulating levels of LH, T and SHBG are inconsistent (Garcia et al. 2006; Strasser et al. 2006; Greenfield et al. 2007). It is likely that a variety of individual factors such as cytokines (IL 6, IGF-1 and others), variations in cytotoxic treatments and opiate-based pain treatment (see Sect. 18.3.13) and other factors influence the net androgen status in male cancer survivors. Among the very few well-controlled studies of androgen therapy in various male cancers (Darnton et al. 1999; Loprinzi et al. 1999; Howell et al. 2001) the findings do not establish any consistent benefits of androgen therapy and further clinical trials would be required before such treatment is justified.

18.3.4.1 Surgery

Unilateral orchidectomy for testis cancer has little consistent effect on sperm output or fertility, if the contralateral testis is normal. However, the testis cancer and surgery have transient and reversible effects on sperm production and output. Post-orchidectomy blood FSH and LH are increased moderately, but testosterone is unaffected by unilateral orchidectomy (Petersen et al. 1999). Radical prostatectomy or rectal cancer surgery can produce high rates of post-surgical erectile dysfunction. Improved surgical techniques, such as nerve-sparing surgery or unilateral instead of bilateral radical retroperitoneal lymph-node dissection, can improve post-surgical erectile and ejaculatory functions to reduce the prevalence of dry ejaculation and erectile dysfunction.

18.3.4.2 Chemo-/Radiotherapy

Treatment with combination chemotherapy and/or therapeutic irradiation virtually always causes azoospermia and infertility. However, the duration of azoospermia and the degree and rate of spermatogenic recovery varies according to the regimen used from full (e.g., cisplatin/vinblastine/bleomycin for teratoma), partial (e.g., combination chemotherapy for sarcoma) and dose-dependent (e.g., pelvic irradiation with testicular shielding for seminoma) reversibility over several years after treatment to essentially irreversible sterilization (e.g., MOPP for Hodgkin disease

[Whitehead et al. 1982]). In men with Hodgkin disease the otherwise inevitable sterilization from a standard course of MVPP or MOPP may be avoided by using fewer cycles of MOPP (daCunha et al. 1984), MOPP alternating with the ABVD regimen (doxorubicin, bleomycin, vinblastine, dacarbazine) (Viviani et al. 1991) or ABVD alone which has equal therapeutic efficacy but less spermatogenic toxicity than MOPP (Viviani et al. 1985) probably due to the absence of potent alkylating agents, which are particularly gonadotoxic.

Therapeutic regimens used to treat Non-Hodgkin lymphoma such as VAPEC-B (Radford et al. 1994), or VEEP (Hill et al. 1995) are less gonadotoxic than regimens commonly used for Hodgkin disease, possibly due to the absence of the potent alkylating agents procarbazine and dacarbazine (Bokemeyer et al. 1994).

The testis is exceptionally sensitive to ionizing irradiation, with single doses of 20 rads (cGy) causing azoospermia and time-to-recovery being proportional to dose (Rowley et al. 1974). Effective testicular shielding can greatly reduce testicular dosage during pelvic irradiation but the scatter doses (typically ~2% of dose) still well exceed the threshold for spermatogenic damage (<0.5% of dose). In contrast to other tissues, dose fractionation enhances spermatogonial killing (Meistrich and Beek 1990).

Total body irradiation (TBI) given for conditioning prior to allogeneic hematopoietic stem cell transplantation (HSCT) causes severe spermatogenic damage. Spermatogenic recovery is more likely with younger men (<25 years of age) and when they remain free of chronic Graft-versus-Host disease (Rovo et al. 2006). A study evaluating long-term survivors after HSCT reported that 19% of male patients show hypogonadotropic hypogonadism 1.5 years after HSCT, but testosterone levels normalized after 3 years (Somali et al. 2005).

Thyroid cancer patients who receive a single or few standard doses of radioiodine¹³¹I, experience usually only a transient impairment of spermatogenesis (Hyer et al. 2002).

Besides pretreatment sperm cryostorage (Kelleher et al. 2001), measures to protect reproductive health during the treatment include minimizing gonadotoxic chemotherapy, maximal testicular shielding during radiotherapy, nerve-sparing operative techniques and in the future, possibly autologous germ cell transplantation (Schlatt 1999). More speculative options for the future, especially for prepubertal boys, include ectopic

xenografting or autografting of testicular tissue, in vitro maturation of testicular tissue or the use of pluripotent embryonic stem cells. Experimental hormonal cytoprotection treatments using either steroids and/or GnRH analogs to inhibit testicular function during chemotherapy have shown only limited promise in experimental models (Crawford et al. 1998) or preliminary human or non-human primate studies (Meistrich and Shetty 2008).

Pretreatment testicular dysfunction is one constraint on sperm cryopreservation, although most men are able to cryostore sperm if they wish. Sperm cryopreservation for men without completed families represents a cost-effective, psychologically reassuring preparation for recovery from treatment. As a form of fertility insurance, only limited use of cryostored material in artificial insemination or male factor IVF/ICSI may be expected and ongoing appropriate follow-up, including appropriate advice on contraception, prognosis for cure and semen analysis, is required to determine whether to discard or continue sperm cryostorage (see Chap. 24).

A frequent concern among cancer survivors is the risk of birth defects in their post-treatment offspring. The most comprehensive data available indicates that there is no increased teratogenic or genetic risk to such offspring (Arnon et al. 2001). In this context, elective cryopreservation of sperm prior to cancer therapy avoids exposure of sperm to potential genetic effects of cytotoxic therapy although such sperm continue to be exposed to ambient environmental irradiation during cryostorage. Nevertheless, increased aneuploidy (Robbins et al. 1997; Genesca et al. 1990) and/or in vitro DNA damage (O'Flaherty et al. 2008) in human sperm have been reported in men with cancers. The disparity between these in vitro apparently adverse findings on sperm DNA integrity with the negative clinical observations suggests that natural embryo (and possibly sperm) selection and surveillance mechanisms culminating in possibly increased miscarriage rates may protect couples against teratogenic and/or genetic risks from paternally-mediated cancer treatments.

18.3.5 Neurological Diseases

The mechanism by which neurologic diseases produce testicular dysfunction remains only partially known. In

addition to the dominant effects of hypothalamic regulation of pituitary-testicular function via GnRH secretion, there is also evidence for direct neural regulation of testicular function (Selvage et al. 2006) and direct sex steroid effects on diverse brain functions such as shaping brain development, neural plasticity and higher brain functions such as mood and cognitive abilities (Parducz et al. 2006).

18.3.5.1 Genetic Disorders

Myotonic dystrophy, an autosomal dominant multi-system disorder is the most frequent inherited muscle disease of adults, and is associated with reduced fertility, testicular atrophy, hypospermatogenesis, elevated gonadotropin and low or normal testosterone levels. The testicular defect has no relationship with severity, duration or treatment of the muscular disease nor does pharmacological testosterone therapy improve muscular strength despite increasing muscle mass (Griggs et al. 1989; Vazquez et al. 1990).

The genetic mutation is a polymorphic expansion of tandem CTG triplet codon repeats (>35) in the 3' untranslated region of the myotonin protein kinase gene on 19q13, which causes transcriptional silencing of the flanking SIX5 allele. Loss of SIX5 results in male sterility and age-dependent decrease in testicular mass (Mastrogiacomo et al. 1996; Sarkar et al. 2004). However, use of ART offers good reproductive outcome, but a well informed genetic counselling, possibly including the option of preimplantation genetic diagnosis, is essential (Verpoest et al. 2008).

The genetic basis of **Kennedy disease** (late onset, X linked recessive bulbospinal muscular atrophy) has been identified as a variable increase in numbers of CAG triplet repeats beyond the physiological range (<38) in the first exon of the androgen receptor in a region coding for its non-binding, N terminal domain (La Spada et al. 1991). The progressive neuromuscular atrophy begins in the hips and shoulders, progressing to brainstem-innervated bulbar muscles, which results in difficulties in walking, speaking and swallowing and eventually often in death due to respiratory difficulties (Atsuta et al. 2006). In addition there is subtle evidence of acquired mild androgen resistance including gynecomastia, androgen deficiency symptoms, testicular atrophy and oligo-/azoospermia. The disease severity and age of onset is correlated with the number of tandem CAG

triplet repeats (Atsuta et al. 2006). The pathogenesis is still not clearly understood with the major factors being either toxic gain-of-function effects like other neurodegenerative diseases or defects in androgen receptor function (Warner et al. 1992). Despite specific histopathological findings in neural and muscular tissues (Adachi et al. 2005; Katsuno et al. 2006) and several established mouse models (Monks et al. 2008), the pathogenesis of the neurotoxicity and its relationship to the androgen receptor mutations remains to be fully elucidated.

The **fragile-X syndrome**, the most common cause of mental retardation with approximately one in 4,000 men affected and which explains the male excess in mental institutions, is an X-linked disorder caused by hypermethylated expansions to more than 200 copies of CGG triplets in the 5'UTR of the FMR1 gene (Garber et al. 2008). It is associated with different degrees of mental retardation, subtle dysmorphic features and macroorchidism, which often becomes manifest just prior to puberty (Lachiewicz and Dawson 1994), but shows normal gonadal function (Cantu et al. 1976; Berkovitz et al. 1986). A subgroup of older men carrying the relatively common premutation (FMR1 allele (defined by approximately 55–200 CGG-repeats), may develop the fragile X-associated tremor/ataxia syndrome which can readily be misdiagnosed as Parkinsons syndrome (Jacquemont et al. 2004).

Huntington disease (HD) is an adult-onset neurodegenerative disorder, which is characterized by motor, neuropsychiatric and cognitive abnormalities. It is caused by an expansion of a CAG trinucleotide in the HD gene on chromosome 4p16.3, which codes for huntingtin (htt) (MacDonald et al. 1993). Individuals affected by Huntington disease have been shown to have decreased levels of total testosterone and LH (Markianos et al. 2005), but normal fertility (Mastromauro et al. 1989; Pridmore and Adams 1991), while a recent histopathological postmortem evaluation of testes from four HD patients showed a decreased number of germ cells, and an abnormal seminiferous tubule morphology and concordant finding of late onset testicular dysfunction in mouse models of the disease (Van Raamsdonk et al. 2007).

The reason that these diseases with heritable unstable DNA replication all manifest testicular and neurologic dysfunction remains unclear.

A variety of other rare genetic neurological disorders involving multiple congenital defects are associated

with hypogonadotropic hypogonadism, presumably due to defective neural circuitry involving the hypothalamic GnRH neurons and/or their pulse generator (see Chap. 12). These syndromes include the **Prader-Labhart-Willi syndrome** of mental retardation, hypotonia, short stature and obesity caused by deletions or uniparental disomy of chromosome 15 (Crino et al. 2003; Eiholzer et al. 2006), the **Laurence-Moon-Biedl syndrome** of retinitis pigmentosa, obesity, mental retardation and polydactyly or other dysmorphic features, **Friedreich and other cerebellar ataxia syndromes**, **multiple lentiginos syndrome**, **steroid sulphatase deficiency** (X-linked congenital ichthyosis) and other rare congenital neurological syndromes like Woodhouse-Sakati syndrome (Schneider and Bhatia 2008), **Moebius, RUD, CHARGE, Lowe, Martsof, Rothmund-Thompson, Borjeson-Forsman-Lehman** syndromes (Rimoin and Schimke 1971). Such patients may require androgen replacement although social factors usually dictate that fertility requiring gonadotropin induction of spermatogenesis is rarely requested.

18.3.5.2 Acquired Disorders

Some recent studies observed a negative correlation between Alzheimer disease and blood testosterone levels, which is – if at all – most probably attributable to non-specific ontogenic regression effects of the chronic dementia on hypothalamo-pituitary regulation of testicular function, in common with many chronic diseases. A small pilot study of testosterone replacement therapy in men with early Alzheimer disease who had lowered circulating testosterone levels produced marginal improvement in spatial abilities (Tan and Pu 2003). Further evaluation by well-controlled and suitably powered RCTs of testosterone replacement, controlling for non-specific mood effects on cognition, would be required before clinical application of such therapy was justified.

The age-related decline of testosterone levels in aging men with **Parkinson disease** was reported to be similar to control groups without dementia or neurodegenerative diseases (Okun et al. 2004) and a recent RCT showed no beneficial effect of testosterone replacement therapy in affected men with borderline testosterone levels (Okun et al. 2006).

Similarly, about 25% of men with **multiple sclerosis** (MS) have decreased circulating testosterone levels

with variable LH levels probably attributable to the non-specific effects of the underlying chronic inflammatory process. In addition, spinal demyelination leads to impaired erectile and ejaculatory function but spermatogenesis is not impaired by the disease or its treatment with beta interferon. Promising neuroprotective effects claimed for testosterone treatment in a small cross-over study of men with relapsing-remitting MS need confirmation (Sicotte et al. 2007).

Temporal lobe epilepsy is associated with hypogonadism and sexual dysfunction, whereas other forms of epilepsy have little known systematic impact on testicular function (Bauer et al. 2004). Clinical and experimental animal data suggest that epileptiform discharges in the temporolimbic system alter the hypothalamo-pituitary regulation of GnRH and gonadotropin secretion. Temporal lobe surgery normalizes blood testosterone values (Bauer et al. 2000). Low testosterone levels and hyposexuality are common in anticonvulsant-treated epileptics (Fenwick et al. 1985; Isojarvi 2008). Anticonvulsants increase hepatic SHBG secretion leading to decreased metabolic clearance rate for testosterone together with increases in total testosterone and gonadotropins, while free testosterone levels are decreased. Semen parameters seem little affected in untreated and phenytoin-treated epileptic men, although data is scarce (Taneja et al. 1994). Sperm output remains normal but morphology and motility are impaired during long-term treatment with phenytoin (Schramm and Seyfeddinpur 1980). Testosterone has antiseizure effects in experimental animal models but the effects on experimental seizures in humans are mixed. The role of aromatization of testosterone to estradiol, which has proconvulsant effects, remains to be clarified (Herzog et al. 1998). However, larger controlled clinical studies of the effects of androgen administration on seizure control or androgenic status would be of interest.

Spinal cord damage from trauma or neurological disease causes testicular dysfunction depending in severity on the level and extent of spinal cord interruption. Testicular function is disrupted by aberrant thermoregulation, recurrent ascending urinary tract infections from bladder catheterization and neurogenic dysfunction and iatrogenic factors (diagnostic irradiation, drugs). Hypospermatogenesis and testicular atrophy is usually observed in men with long-term spinal injuries, but fertility may be preserved by timely sperm cryopreservation using electroejaculation coupled with

assisted fertilization (Brown et al. 2006). Impotence is predominantly due to interruption of neural pathways controlling erection and emission while libido remains appropriate for age. Conservation of sexual function depends upon the level and extent of the spinal injury.

Head injuries may cause gonadotropin deficiency due to disruption of the pituitary portal bloodstream and/or pituitary infarction following basal skull fractures.

Lowered blood testosterone levels are associated with various psychiatric disorders, such as **schizophrenia** where the major effects are associated with negative symptoms (Kaneda and Fujii 2000; Akhondzadeh et al. 2006).

Dysthymic disorders in elderly men are associated with low blood testosterone levels when compared with men with no depression or major **depression** (Seidman et al. 2002). **Cluster headache** has also been associated with low blood testosterone and some modest therapeutic benefit of testosterone treatment (Stillman 2006). Without further systematic evaluation, it is most probable that these represent the non-specific effects of chronic non-testicular disease on testicular function.

18.3.6 Gastrointestinal Diseases

Celiac disease is associated with delayed puberty, subfertility, impaired sperm output, morphology and motility together with elevated blood testosterone, SHBG and gonadotropin levels, whereas with decreased dihydrotestosterone levels (Bona et al. 2002). These changes are reversible upon dietary improvement of the gluten enteropathy. This distinctive endocrine pattern is suggestive of acquired androgen resistance (e.g., high testosterone levels which fail to suppress LH secretion) and/or inhibition of 5- α reduction; however, detailed studies of androgen receptor function or action (Farthing and Dawson 1983) are lacking. Opioidergic hypothalamic activation by gluten peptides has been suggested as a mechanism that deranges the gonadal axis.

Inflammatory bowel disease (IBD) is often associated with a delayed puberty, which is more common in Crohn's disease than in ulcerative colitis. Serum gonadotropin levels are inconsistently reported to be both increased or decreased. The underlying mechanism may involve a combined effect of undernutrition and

cytokines as TNF α . Postpubertal testicular endocrine function is often unaffected (Farthing and Dawson 1983), but spermatogenesis frequently impaired. Hypospermatogenesis in **Crohn's disease** is possibly related to fever, chronic illness, inflammatory mediators and/or nutritional status (Farthing and Dawson 1983). Similarly men with **ulcerative colitis** taking salazopyrine exhibit impaired spermatogenesis, sperm function and male fertility (Cosentino et al. 1984). Routine use of salazopyrine for both acute and preventative maintenance therapy early in the course of **ulcerative colitis** in some countries has precluded studies of testicular function in untreated men to determine the extent of effects of ulcerative colitis per se. Semen parameters improve in patients switching from salazopyrine to 5-aminosalicylic acid (Zelissen et al. 1988); patients who have not completed their families should be treated with the latter drug. Patients with IBD have higher frequency of anti-sperm antibodies (ASA), possibly due to increased intestinal permeability and immunization against antigens of the intestinal flora (Dimitrova et al. 2005). ASA show cross-reactivity to antigens of spermatozoa and some microorganisms, as physiological and pathological genital and gastrointestinal flora. ASA are also increased after **diarrhoeal diseases** in shigellosis and salmonellosis (Kalaydjiev et al. 2007).

No controlled studies have evaluated the effect of testosterone replacement in IBD in adult males. The use of short-term testosterone therapy to induce puberty is not evaluated either, but as in other chronic diseases associated with delayed puberty, a carefully monitored testosterone therapy seems reasonable.

Peptic ulceration has no reported effects on testicular function, although treatment with the H₂-receptor blocker cimetidine impairs testicular function by androgen receptor antagonism unrelated to its H₂-receptor blocking activity (Knigge et al. 1983). These effects are not observed with ranitidine and other H₂ receptor blockers or other anti-acid drugs.

18.3.7 Hematological Diseases

Hemoglobinopathies are associated with delayed puberty. In regularly transfused children with **β -thalassemia** transfusion-induced iron overload leads to acquired gonadotropin deficiency functionally similar to that of genetic hemochromatosis (see Sect. 18.3.2).

Prepubertal onset of iron chelation therapy enhances pubertal maturation, presumably by preventing **pituitary siderosis** (Bronspiegel-Weintrob et al. 1990).

A large proportion of adult men with β -thalassemia major suffer from hypogonadotropic hypogonadism and impaired semen parameters (Kidson-Gerber et al. 2008; Safarinejad 2008). Iron overload may predispose sperm to oxidative injury and to increased DNA damage (Perera et al. 2002). Data about **sickle cell anemia** are conflicting with the majority of studies, suggesting a primary testicular problem with high gonadotropin levels and a normal gonadotropin-response upon GnRH stimulation (Abbasi et al. 1976), but sickle cell patients can, however, develop a secondary hypogonadism and have reportedly poor spermatogenesis (Agbaraji et al. 1988). The variation may depend on the predominant location of the ischemic microinfarcts due to episodes of sickling. The impact of hydroxyurea therapy, used to treat or prevent sickling crisis, on human male reproductive function has not been studied and is therefore virtually unknown (http://cerhr.niehs.nih.gov/chemicals/hydroxyurea/Hydroxyurea_final.pdf).

Iron deficiency anemia has no recognized effects on testicular function but **megaloblastic anemia** from folate or vitamin B₁₂ deficiencies inhibits DNA replication in the marrow and might cause arrest of the germinal epithelium; however, no reports of spermatogenesis among men with megaloblastosis are available to examine this hypothesis, presumably reflecting the paucity of vitamin B₁₂ or folate deficiency in young nonalcoholic men in developed countries. **Hemophilia** is associated with a striking reduction in male fertility (Francis and Kasper 1983) although whether this is explained fully by voluntary restraint of fertility is unclear, as no studies of testicular function in hemophiliacs are available.

18.3.8 Endocrine and Metabolic Diseases

Thyroid disease influences male reproductive function with the most striking effects manifest through changes in circulating SHBG levels (Krassas and Pontikides 2004) and transient spermatogenic damage from radioactive iodine treatment of thyroid cancer (Handelsman and Turtle 1983; Pacini et al. 1994; Esfahani et al. 2004). Thyroid hormones stimulate hepatic SHBG

synthesis so **hyperthyroidism** increases circulating SHBG levels and **hypothyroidism** causes low SHBG levels, changes which are reversed by normalization of thyroid hormone levels (Kumar et al. 1990). The rise in SHBG decreases the testosterone clearance rate, resulting in increased total testosterone, estradiol and gonadotropin levels. The net effect on overall tissue androgen action remains unclear. Clinical features include gynecomastia, erectile dysfunction and ejaculatory disorders in a substantial number of cases (Carani et al. 2005). These symptoms resolve when a euthyroid state is regained. Spermatogenesis is depressed in thyrotoxicosis (O'Brien et al. 1982) and long-standing hypothyroidism of prepubertal onset but is little affected by postpubertal hypothyroidism (de la Balze et al. 1962). Sperm motility is the major fertility parameter affected by hyperthyroidism and improves upon treatment (Krassas et al. 2008).

Congenital adrenal hyperplasia, most commonly caused by **21-hydroxylase-deficiency** can lead to secondary testicular failure, impaired spermatogenesis and infertility (Jaaskelainen et al. 2000; Tiitinen and Valimaki 2002), although the majority of treated and untreated men are fertile (Urban et al. 1978). Gonadal dysfunction can be due to inhibition of gonadotropin secretion by high blood concentrations of adrenal androgens, but aberrant adrenal cells in the testes, so called testicular adrenal rest tumors, can lead to azoospermia and eventually severe testicular damage by obstruction and congestion of seminiferous tubules after stimulation by the chronically elevated adrenocorticotropic hormone (ACTH) (Stikkelbroeck et al. 2001; Claahsen-van der Grinten et al. 2008).

Hypercortisolism from any cause can inhibit testicular function at multiple levels of the HPT axis, leading to a reduction in circulating testosterone and gonadotropin levels which is reversed by interruption of the exposure to excessive glucocorticoids (Luton et al. 1977). The degree to which androgen deficiency contributes to the catabolic state and symptoms of sexual dysfunction and weakness during hypercortisolism is unclear. The mechanisms involve multiple levels of the HPT axis including inhibition of hypothalamic GnRH secretion, of GnRH stimulated pituitary LH secretion and of LH stimulation of Leydig cell testosterone biosynthesis.

The effects of **diabetes mellitus (DM)** on male reproductive function are primarily due to neuropathic and vascular complications of diabetes causing erectile

and/or ejaculatory dysfunction (Dunsmuir and Holmes 1996), whereas direct effects of hyperglycemia on testicular function are not well established. Several cross-sectional studies report mildly decreased testosterone levels in men with type 2 DM (Barrett-Connor 1992; Dhindsa et al. 2004; Grossmann et al. 2008), which most likely reflect multiple factors mediating effects of chronic disease (via hypothalamic ontogenic regression mechanism), obesity (via lowered SHBG) and impaired Leydig cell steroidogenesis (Pitteloud et al. 2005). Subjects with type 1 DM by contrast are reported to have normal TT and gonadotropin levels (Tomar et al. 2006).

While some preliminary evidence suggests that testosterone replacement therapy improves insulin sensitivity in healthy men with low testosterone levels (Simon et al. 2001) and has beneficial effects on insulin resistance, decreased hyperglycemia and visceral fat in obese middle-aged men (Marin et al. 1992a, b) and patients with type 2 DM (Kapoor et al. 2006), more powerful studies appear warranted to evaluate critically the benefits and risks of testosterone adjuvant therapy in diabetic men to reduce vascular complications.

Spermatogenesis and fertility are little affected in men with diabetes whose sexual function is intact. Apart from reduced semen volume attributable to defective neurally-mediated ejaculatory function, men with diabetes have normal conventional sperm parameters, although some increase in sperm nuclear and mitochondrial DNA damage of uncertain clinical significance has been reported (Agbaje et al. 2007).

Recent studies have reported a relationship between the **metabolic syndrome** and biochemical androgen deficiency. This has been defined as a positive relationship between low blood testosterone levels and insulin insensitivity manifested clinically as an overlap between hyperglycemia, hyperinsulinemia and obesity. The causality of this association remain inconclusive but it is likely that testosterone deficiency is the consequence rather than the cause of impaired metabolic status (Liu et al. 2003a; Chen et al. 2006).

Anorexia nervosa is rare in males but then causes profound inhibition of testicular endocrine function (Buvat et al. 1983). Anorectic males show low testosterone levels with low gonadotropin and poor responses to GnRH stimulation. Weight gain is associated with increasing testosterone and LH levels, consistent with the positive correlation with leptin levels (Wabitsch

et al. 2001). The effects of moderate undernutrition or selective dietary micronutrient deficiencies (e.g., vitamins, cofactors) on human testicular function are less clear.

Obesity inhibits testicular endocrine function and has negative effects on spermatogenesis and fertility. Obese boys show delayed pubertal development with decreased testosterone levels for chronological age, but ultimately normal growth and normal testicular development (Denzer et al. 2007). The decreases in blood testosterone and SHBG levels are proportionate to the degree of overweight, whereas blood estradiol levels are increased, probably due to increased aromatase-dependent peripheral conversion of testosterone to estradiol. The latter explains the observation that decreased blood testosterone levels may be partly reversed by an aromatase inhibitor (Loves et al. 2008). The principal pathogenic mechanism of obesity-induced lowering of blood testosterone levels may involve functional hyposomatotropism and/or insulin resistance causing a decline in hepatic SHBG secretion. These hormonal changes are not accompanied by overt clinical features of androgen deficiency and are reversed by weight reduction. Moderate obesity has little overt effect on male reproductive function but may contribute to the decline of hypothalamus and pituitary testicular function in aging men (Gray et al. 1991; Travison et al. 2007).

Sperm concentration and output are related to the body mass index (BMI) in a U-shaped manner with the highest sperm production in the group with a BMI between 20 and 25 kg/m² (Jensen et al. 2004; Magnúsdóttir et al. 2005; Kort et al. 2006). The pathophysiologic mechanisms of reduced spermatogenesis at high or low BMI are not clear, including whether they are direct effects of body weight or indirectly due to associated nutritional and/or lifestyle metabolic factors. Nevertheless there is little consistent evidence for obesity as a cause of male infertility.

18.3.9 Immune Diseases

Autoantibodies to spermatozoa develop in about 70% of men after vasectomy but have no apparent deleterious effects on general health (Petitti 1986) although they may inhibit sperm function and fertility after vasectomy reversal (Linnet et al. 1981). Sperm

autoantibodies are observed in 5% of nonvasectomized infertile men who also have an increased prevalence of other organ-specific autoantibodies (see Chap. 15). Immune complexes of unknown significance have been observed in seminiferous tubular basement membranes of infertile men.

Most **autoimmune diseases** have a marked (>5:1) female predominance (e.g., systemic lupus erythematosus, chronic active hepatitis, chronic biliary cirrhosis) which remains unexplained and testicular involvement in immune disease is unusual apart from **polyarteritis nodosa** where testicular biopsy may be diagnostic. **Rheumatoid arthritis** causes prolonged depression of testosterone levels during flares of disease activity with spontaneous recovery during remission (Cutolo et al. 1991). Among men with longstanding rheumatoid arthritis with and without glucocorticoid treatment, there is a high prevalence of impaired testicular endocrine function (Martens et al. 1994; Silva et al. 2002). However, a randomized clinical trial of testosterone substitution showed no benefit on disease activity in men with rheumatoid arthritis (Hall et al. 1996). Testicular endocrine function is normal in men with **ankylosing spondylitis** (Stahl and Decker 1978; Gordon et al. 1986), **systemic lupus erythematosus** (Stahl and Decker 1978) or **osteoarthritis** (Spector et al. 1988). Treatment of immunological diseases with cytotoxic drugs may lead to severe, dose-dependent and sometimes irreversible spermatogenic damage typical of alkylating agents.

Autoimmune orchitis (see Chap. 13) is a rare component of the organ-specific autoimmune cluster and **autoimmune hypophysitis** causing isolated gonadotropin deficiency or panhypopituitarism is also uncommon (Obermayer-Straub and Manns 1998).

18.3.10 Infectious Diseases

Systemic infections often influence testicular function even without causing orchitis (see Chap. 13). Many mechanisms are involved, including the effects of fever, inflammatory mediators such as tumor necrosis factor- α and cytokines, weight loss and chronic catabolism. The net effects depend on the severity and duration, as well as the site of infection.

Epididymo-orchitis is rare in prepubertal boys, but occurs in 15–30% of **mumps**-affected pubertal or

postpubertal males with 15–30% of cases being bilateral (Philip et al. 2006; Hviid et al. 2008), so that, despite the well-known association, overall, mumps only rarely leads to infertility which can then be managed as for other forms of male infertility (Lin et al. 1999). The pathophysiological mechanisms include direct viral infection of the tubules, pressure-induced necrosis of seminiferous tubules due to parenchymal edema within the tight testicular capsule as well as strong associated inflammatory reaction. Direct testicular damage is evident in the acute phase with prominent decrease in blood testosterone and reflex increase in blood gonadotropins prior to the testicular atrophy which occurs in up to half of the infected men. Reports that treatment of mumps-orchitis with interferon Alpha 2B prevents testicular atrophy and might protect fertility require further verification (Ku et al. 1999). However, vaccination remains the best protection against mumps associated infertility.

The prevalence of symptomatic androgen deficiency among **HIV-positive men** with advanced disease before highly active antiretroviral therapy (HAART) was recently reported to be 6% (Dube et al. 2007). Before HAART was available, androgen deficiency was reported in ~50% of men with **AIDS**, whereas now ~20% of AIDS patients have low blood testosterone levels (Rietschel et al. 2000). The majority of HIV-infected men show hypogonadotropic or normogonadotropic hypogonadism, indicative of a hypothalamo-pituitary dysregulation, whereas after progression to AIDS LH and FSH levels rise and postmortem evaluation shows testicular atrophy (Salehian et al. 1999). How many of these effects are due to drug treatments remains unclear (Dube et al. 2007).

Spermatogenic damage in men with AIDS is almost universal at postmortem (de Paepe and Waxman 1989), whereas spermatogenesis (Crittenden et al. 1992) is unaffected in asymptomatic, HIV seropositive men (van Leeuwen et al. 2007) but deteriorates with clinical status and treatment (van Leeuwen et al. 2008).

Androgen deficiency in AIDS is associated with weight loss, including loss of muscle mass, consistent with the non-specific effects of other chronic non-testicular diseases (Grinspoon et al. 1996).

HIV-associated malignancies such as lymphomas or opportunistic infections such as toxoplasmosis can cause mass lesions disrupting the hypothalamo-pituitary-testicular axis on all levels. Additional factors contributing to hypogonadism in HIV patients include

medications commonly used in this group (such as ketoconazole, megestrol-acetate, ganciclovir, spironolactone) or the prevalent use of drugs like opiates, alcohol and marijuana.

Testosterone replacement therapy in symptomatic HIV-positive men has beneficial effects on the body composition (Bhasin et al. 1998, 2007) and improves the quality of life in androgen-deficient men with AIDS wasting syndrome (Grinspoon et al. 1998).

Sexually transmitted diseases may influence fertility by impairing spermatogenesis (e.g., *ureaplasma urealyticum* can cause asthenozoospermia and disruption of DNA condensation) or by causing urethral strictures and epididymo-orchitis (e.g., gonorrhoea). The negative impact of male chlamydia infection on a couple's fertility (due to transmission to the female) is well known, but direct influence on male fertility is uncertain, although increased sperm DNA damage and a direct interaction between sperm and chlamydia has been reported (Cunningham and Beagley 2008).

The genital manifestation of **lepromatous leprosy** leads in up to 50% of affected subjects to testicular atrophy and hypergonadotropic hypogonadism (Martin et al. 1968), whereas tuberculoid leprosy rarely leads to hypogonadism, which is mainly secondary to granulomatous disease of the hypothalamus.

Congenital **toxoplasmosis** (Massa et al. 1989) and other congenital infections with cerebral involvement are reported to present as hypogonadotropic hypogonadism. Acute toxoplasmosis in men can precipitate hypogonadotropic hypogonadism either via the rare toxoplasma encephalitis or via mechanisms of severe acute illness. In addition in oligosymptomatic infections, cytokine-induced inflammatory reaction of the hypothalamus may lead to disrupted GnRH release leading to hypogonadotropic hypogonadism with normal response to exogenous GnRH (Oktenli et al. 2004).

Tuberculosis can lead to hypogonadotropic hypogonadism by disruption of the gonadal axis (Post et al. 1994) and may infiltrate the genito-urinary tract, causing epididymitis and consequently infertility. Although cases are mostly found in developing countries and countries in transition, the diagnostic work-up should consider this possibility especially in migrant populations (Al-Ghazo et al. 2005; Tzvetkov and Tzvetkova 2006).

Sleeping sickness caused by parasitic infections with *Trypanosoma brucei* causes an only partially reversible hypogonadotropic hypogonadism, probably

due to a combination of direct parasitic infiltration and secondary central effects of a severe systemic inflammatory reaction (Petzke et al. 1996).

18.3.11 Cardiovascular Diseases

Hypertension is associated with lowered circulating testosterone levels (Hughes et al. 1989) and antihypertensive medications are associated with even lower testosterone levels (Suzuki et al. 1988). This or confounding by obesity may explain the inverse epidemiological association (independent of age and obesity) between blood pressure and testosterone levels (Svartberg et al. 2004). Such small decreases in blood testosterone levels are insufficient to account for the disproportionately high prevalence of erectile dysfunction in treated hypertensive men. This presumably reflects both more advanced atherogenesis and hemodynamic factors rather than hormonal effects of antihypertensive medication (Jaffe et al. 1996).

Observational epidemiological studies show consistently that low testosterone levels are associated with increased rates of cardiovascular disease, but the direction of causality remains unknown. Whether there are any additional factors beyond the non-specific chronic disease (ontogenic regression) effects of moderate lowering of blood testosterone levels due to the presence of acute or chronic cardiovascular disease remains to be established. Some (Khaw et al. 2007; Laughlin et al. 2008), but not all (Smith et al. 2005; Araujo et al. 2007), recent prospective studies show that low serum testosterone levels can predict cardiovascular death. In conjunction with low testosterone levels being associated with some other cardiovascular risk factors, it remains to be elucidated whether low testosterone levels are more than just a universal epiphenomenon reflecting various aspects of chronic cardiovascular disease. At pharmacological concentrations, testosterone has dose-dependent vasodilator properties *ex vivo* on human and experimental animal resistance arteries (Jones et al. 2004; Malkin et al. 2006a).

Clinical trials of testosterone replacement therapy have been conducted among men with coronary heart disease (Jaffe 1977; English et al. 2000; Webb et al. 2008) and in congestive cardiac failure (Malkin et al. 2004, 2006b). However, the benefits remain marginal

and inconsistent but warrant larger and longer studies, which are necessary before such testosterone adjuvant therapy is justified.

There is a strong association between **atherosclerotic cardiovascular disease** and erectile dysfunction. In addition to the classical **Leriche syndrome** (an aortoiliac occlusive disease leading to erectile dysfunction, intermittent claudication and absent or diminished femoral pulses), there is a high prevalence of known and undiagnosed cardiovascular disease (angina, ischemia, infarction, thrombotic stroke, peripheral vascular insufficiency) among men with organic erectile dysfunction (see Chap. 16). It is now increasingly understood that onset of erectile dysfunction is an early sentinel warning event for incipient, but usually still undiagnosed, cardiovascular disease. This forms an important pathological basis for vasculogenic, the most frequent form of organic erectile dysfunction. In addition, the interaction with nitrate therapy for cardiovascular disease creates the most serious adverse effect of **phosphodiesterase-5-inhibitors** in treatment of erectile dysfunction. There is also evidence that atherosclerosis is an important determinant of the testicular degeneration in aging men.

18.3.12 Dermatological Diseases

Psoriasis is associated with impaired spermatogenesis which correlates with the extent and severity of the disease rather than with methotrexate or corticosteroid treatment (Grunnert et al. 1977).

18.3.13 Other Chronic Diseases

Hereditary angioedema (HAE) is an autosomal dominantly inherited disorder of the complement system caused by mutations of the C1-INH gene on chromosome 11q12, which may lead to deficiency (type 1 HAE) or impaired function (type 2 HAE) of C1-esterase inhibitor. The disease is characterized by episodic edematous attacks mostly of hands and feet, but sometimes also involving genitalia, trunk, face, tongue, the wall of the bowel and the respiratory system, which can be fatal, if not treated adequately (Frank 2008). Although this is a condition where

synthetic 17- α alkylated androgens have proven beneficial effects on the clinical course of the disease (Banerji et al. 2008) by increasing circulating C1 inhibitor levels in vivo and in vitro (Falus et al. 1990), underlying testicular function has been little studied and is probably normal (Thon et al. 2007). This illustrates that the existence of underlying testicular dysfunction from a disorder is not a prerequisite for effective pharmacological androgen therapy for that condition.

Amyloidosis of the testis is rare, occurring mostly as secondary systemic AA-amyloidosis. However, massive primary testicular infiltration causing macro-orchidism is reported (Handelsman et al. 1983). Hypogonadism due to testicular amyloid deposition and abnormal semen parameters and infertility are described (Ozdemir et al. 2002; Scalvini et al. 2008).

Familial Mediterranean fever (FMF) is a disease characterized by recurrent episodes of fever, peritonitis, pleuritis and arthritis with amyloidosis as one of the main complications. It is associated with testicular germ-cell arrest and oligo or azoospermia (Ben-Chetrit and Levy 2003). Similarly adverse effects on spermatogenesis are also reported in **Behçet disease**, a multisystemic inflammatory disease involving the urogenital system featuring genital aphthous ulcers as well as cystitis, urethritis and epididymitis and with an onset after puberty and strong male preponderance suggestive of a role for androgens in its pathogenesis (Sakane et al. 1999). These effects are most likely attributable to the deleterious effects of recurrent fever on spermatogenesis (Mieusset et al. 1991). Potential additional effects of colchicine, an alkaloid commonly used for prevention and treatment of arthritic episodes in gouty arthritis, FMF and Behçets disease, on the testis remains speculative (Haimov-Kochman and Ben-Chetrit 1998).

Chronic opioid consumption leads to opioid-induced androgen deficiency with decreased testosterone and gonadotropin levels proportionate to net opiate dose but independent of the route of administration (oral, transdermal, intrathecal) or source (prescribed, illicit). For example, intrathecal delivery for chronic pain produces near castrate testosterone levels in ~90% of cases. The modifying effects of confounding factors such as chronic illness, pain, nutrition, additional substance use remains difficult to separate or quantify but remain quantitatively small compared with opiate dosage. The pathophysiological

mechanisms are predominantly due to μ -opiatergic receptor effects which have a strong influence on physiological patterns of hypothalamic GnRH secretion (Abs et al. 2000; Rajagopal et al. 2004). Data about sperm production and fertility among chronic opiate users are scarce, but asthenozoospermia is reported among drug addicts and experimental data provide a basis for pharmacological opioid effects on sperm function (Agirregoitia et al. 2006). Transdermal testosterone replacement in opiate-dependent men treated for nonmalignant pain is reported to improve quality of life but placebo-controlled studies are lacking (Daniell et al. 2006).

The effects of **recreational drugs** such as marijuana, cocaine or ecstasy on testicular function are not well understood; few studies have been reported and none are well controlled for confounding effects of undernutrition, multiple drug usage, psychological and socioeconomic factors.

Chronic heavy **alcohol** intake has multiple, cumulative effects on the male reproductive system due to direct, irreversible testicular toxicity (Villalta et al. 1997) as well as indirect toxic effects (e.g., nutritional, hepatotoxicity; see Sect. 18.3.2). Ethanol decreases testicular testosterone production through different modifications in the pituitary-gonadal axis (Emanuele and Emanuele 2001), including an alcohol-induced decrease of LH secretion in adult men (Frias et al. 2002). Effects of alcohol intake on semen parameters and fertility remain poorly defined, but even regular consumption of moderate amounts of alcohol (>40 g/day) may be associated with disorders of spermatogenesis in a dose-dependent manner (Pajarinen et al. 1996) and moderate chronic alcohol exposure decreases fertility (Jensen et al. 1998).

Smoking has detrimental effects on spermatogenesis, sperm function (Zavos et al. 1998; Wallock et al. 2001) and male fertility in otherwise healthy men (Bolumar et al. 1996; Chia et al. 2000), which leads to decreased success rates in ART including IVF and ICSI (Zitzmann et al. 2003). Reversal of any male subfertility after smoking cessation is not well established.

Anabolic steroids, which are frequently abused by elite and recreational athletes to enhance physical performance and body image, inhibit gonadotropin secretion by negative feedback mechanisms and act as hormonal contraceptives, which is usually reversible upon withdrawal of the steroids.

18.4 Therapeutic Implications

Teleologically, the evolutionary significance of reversible inhibition of reproductive functions during acute or chronic illness is not clearly understood. Many common features observed in the underlying physiological mechanisms employed by mammals during puberty, seasonality, undernutrition, catabolic states and systemic illness have led to the term “ontogenic regression” to describe the common underlying mechanism (see Sect. 18.2.2), which may also be considered a functionally adaptive form of physiological regulation as apoptosis is for orderly cellular turnover.

In this setting, the long spermatogenic cycle time requires prolonged periods to regress to infertile levels. This may have necessitated a speedier inhibition of fertility which is brought about by the inhibition of sexual function through withdrawal of androgen secretion. This latter adaptive mechanism, ideal for short periods, may, however, become deleterious during prolonged, nonfatal illness. In these circumstances prolongation of ontogenic regression may lead to tissue effects of androgen deficiency superimposed on the effects of the underlying disease. This is analogous to the damaging effects of autoimmunity which, in a corruption of necessary immune function, leads to damage to body systems. Although from an evolutionary point of view, transiently reduced fertility during severe illness can be considered as usefully adaptive, the general issue of whether androgen deficiency caused by chronic disease is protective, harmful or neutral cannot be readily answered and may depend on more specific circumstances of modern life.

The therapeutic implications of gonadal dysfunction during non-gonadal systemic diseases vary from minimal to potentially major. They depend on the exact manifestations of the gonadal dysfunction, its chronicity and severity. At minimum, systemic illness may alter routine tests of testicular function which may interfere with evaluation for infertility or other andrological disorders. The value of androgen supplementation in rectifying the partial androgen deficiency associated with chronic medical illness is not well established. Certain specific instances of chronic disease-related androgen deficiency, such as bilateral orchidectomy or acquired hypogonadism due to iron overload warrant androgen replacement as causes of classical androgen deficiency. In many transient illnesses such as febrile infectious episodes, acute accidental or surgical trauma, the

hypothalamic response to systemic illness with its attendant acute androgen deficiency has no known lasting effect on general health and well being.

Despite the transient reductions in androgen secretion in such settings, the presently available evidence does not justify testosterone therapy but would allow for appropriate studies. In more prolonged chronic medical illness leading to persistent and sustained lowering of androgen levels or during severe prolonged catabolic states, such as critical illness, there may be a plausible rationale for testosterone replacement therapy.

This would aim to reduce long-term morbidity from sustained androgen deficiency causing loss of bone and muscle mass. Convincing evidence from properly placebo-controlled randomized clinical trials to justify such treatment is, however, lacking. Uncontrolled and short-term studies during the 1960s did suggest that androgen supplementation initially augmented anabolic status; however, this response was not sustained during prolonged treatment. Although testosterone supplementation cannot be recommended at present, well designed clinical trials to evaluate such interventions are feasible and desirable.

Infertility is an increasingly common problem presenting among men with chronic medical illnesses.

These include men with kidney transplants who can now expect prolonged survival with good quality of life and, increasingly, among men with heart, liver or marrow transplants in whom prolonged survival is increasingly possible. Following many successful organ transplants, impaired reproductive function due to organ failure is often improved or normalized. In addition, most men now survive cancer treatment of testicular tumors, hematological malignancies or sarcomata but are effectively cured of their malignancy at the cost of sustained, severe and often irreversible testicular damage. In these men, counselling about the likelihood of spermatogenic recovery, contraceptive advice as well as appropriate application of assisted reproductive techniques such as pretreatment sperm cryostorage, insemination or male factor IVF/ICSI may be required and should be provided sympathetically. Men with

chronic viral infections such as HIV and hepatitis B and C facing prolonged life expectancy with a life-threatening infectious disease warrant careful and expert counselling for their reproductive health. Difficult psycho-social and ethical decisions may be faced regarding the responsibilities of parenthood with limited life expectancy, risks of paternally mediated malformations and post-mortem insemination. The advent of autologous germ cell transplantation may add further options for fertility insurance to the medical care of men facing impaired reproductive function as a predictable side-effect of life-saving medical therapies.

Sexual dysfunction including impotence is a common feature of aging and most chronic diseases which accumulate in older men. Androgen deficiency is an easily defined and rewardingly treated cause of sexual dysfunction but is relatively rare (see Chap. 14).

References

- Abbasi AA, Prasad AS, Ortega J, Congco E, Oberleas D (1976) Gonadal function abnormalities in sickle cell anemia. Studies in adult male patients. *Ann Intern Med* 85:601–605
- Abs R, Verhelst J, Maeyaert J, Van Buyten JP, Opsomer F, Adriaensen H, Verlooy J, Van Havenbergh T, Smet M, Van Acker K (2000) Endocrine consequences of long-term intrathecal administration of opioids. *J Clin Endocrinol Metab* 85:2215–2222
- Adachi H, Katsuno M, Minamiyama M, Waza M, Sang C, Nakagomi Y, Kobayashi Y, Tanaka F, Doyu M, Inukai A, Yoshida M, Hashizume Y, Sobue G (2005) Widespread nuclear and cytoplasmic accumulation of mutant androgen receptor in SBMA patients. *Brain* 128:659–670
- Agbaje IM, Rogers DA, McVicar CM, McClure N, Atkinson AB, Mallidis C, Lewis SE (2007) Insulin dependant diabetes mellitus: implications for male reproductive function. *Hum Reprod* 22:1871–1877
- Agbaraji VO, Scott RB, Leto S, Kingslow LW (1988) Fertility studies in sickle cell disease: semen analysis in adult male patients. *Int J Fertil* 33:347–352
- Agirregoitia E, Valdivia A, Carracedo A, Casis L, Gil J, Subiran N, Ochoa C, Irazusta J (2006) Expression and localization of delta-, kappa-, and mu-opioid receptors in human spermatozoa and implications for sperm motility. *J Clin Endocrinol Metab* 91:4969–4975
- Akbari F, Alavi M, Esteghamati A, Mehraei A, Djaladat H, Zohrevand R, Pourmand G (2003) Effect of renal transplantation on sperm quality and sex hormone levels. *BJU Int* 92:281–283
- Akhondzadeh S, Rezaei F, Larijani B, Nejatifa AA, Kashani L, Abbasi SH (2006) Correlation between testosterone, gonadotropins and prolactin and severity of negative symptoms in

- male patients with chronic schizophrenia. *Schizophr Res* 84:405–410
- Al-Ghazo MA, Bani-Hani KE, Amarin ZO (2005) Tuberculous epididymitis and fertility in North Jordan. *Saudi Med J* 26:1212–1215
- Albaaj F, Sivalingham M, Haynes P, McKinnon G, Foley RN, Waldek S, O'Donoghue DJ, Kalra PA (2006) Prevalence of hypogonadism in male patients with renal failure. *Postgrad Med J* 82:693–696
- Araujo AB, Kupelian V, Page ST, Handelsman DJ, Bremner WJ, McKinlay JB (2007) Sex steroids and all-cause and cause-specific mortality in men. *Arch Intern Med* 167:1252–1260
- Arnon J, Meirou D, Lewis-Roness H, Ornoy A (2001) Genetic and teratogenic effects of cancer treatments on gametes and embryos. *Hum Reprod Update* 7:394–403
- Atsuta N, Watanabe H, Ito M, Banno H, Suzuki K, Katsuno M, Tanaka F, Tamakoshi A, Sobue G (2006) Natural history of spinal and bulbar muscular atrophy (SBMA): a study of 223 Japanese patients. *Brain* 129:1446–1455
- Bagatell CJ, Bremner WJ (1990) Sperm counts and reproductive hormones in male marathoners and lean controls. *Fertil Steril* 53:688–692
- Ballal SH, Domoto DT, Polack DC, Marciulonis P, Martin KJ (1991) Androgens potentiate the effects of erythropoietin in the treatment of anemia of end-stage renal disease. *Am J Kid Dis* 17:29–33
- Banerji A, Sloane DE, Sheffer AL (2008) Hereditary angioedema: a current state-of-the-art review, V: attenuated androgens for the treatment of hereditary angioedema. *Ann Allergy Asthma Immunol* 100:S19–22
- Barrett-Connor E (1992) Lower endogenous androgen levels and dyslipidemia in men with non-insulin-dependent diabetes mellitus. *Ann Intern Med* 117:807–811
- Bauer J, Stoffel-Wagner B, Flugel D, Kluge M, Schramm J, Bidlingmaier F, Elger CE (2000) Serum androgens return to normal after temporal lobe epilepsy surgery in men. *Neurology* 55:820–824
- Bauer J, Blumenthal S, Reuber M, Stoffel-Wagner B (2004) Epilepsy syndrome, focus location, and treatment choice affect testicular function in men with epilepsy. *Neurology* 62:243–246
- Ben-Chetrit E, Levy M (2003) Reproductive system in familial Mediterranean fever: an overview. *Ann Rheum Dis* 62:916–919
- Berkovitz GD, Wilson DP, Carpenter NJ, Brown TR, Migeon CJ (1986) Gonadal function in men with the Martin-Bell (fragile-X) syndrome. *Am J Med Genet* 23:227–239
- Bhasin S, Storer TW, Asbel-Sethi N, Kilbourne A, Hays R, Sinha-Hikim I, Shen R, Arver S, Beall G (1998) Effects of testosterone replacement with a nongenital, transdermal system, Androderm, in human immunodeficiency virus-infected men with low testosterone levels. *J Clin Endocrinol Metab* 83:3155–3162
- Bhasin S, Parker RA, Sattler F, Haubrich R, Alston B, Umbleja T, Shikuma CM (2007) Effects of testosterone supplementation on whole body and regional fat mass and distribution in human immunodeficiency virus-infected men with abdominal obesity. *J Clin Endocrinol Metab* 92:1049–1057
- Bokemeyer C, Schmoll HJ, van Rhee J, Kuczyk M, Schuppert F, Poliwoda H (1994) Long-term gonadal toxicity after therapy for Hodgkin's and non-Hodgkin's lymphoma. *Ann Hematol* 68:105–110
- Bolumar F, Olsen J, Boldsen J (1996) Smoking reduces fecundity: a European multicenter study on infertility and subfecundity. The European Study Group on Infertility and Subfecundity. *Am J Epidemiol* 143:578–587
- Bona G, Marinello D, Oderda G (2002) Mechanisms of abnormal puberty in coeliac disease. *Horm Res* 57(2):63–65
- Bronspiegel-Weintrob N, Oliver NF, Tyler B, Andrews DF, Freedman MH, Holland FJ (1990) Effect of age at the start of iron chelation therapy on gonadal function in beta-thalassemia major. *N Engl J Med* 323:713–719
- Brown DJ, Hill ST, Baker HW (2006) Male fertility and sexual function after spinal cord injury. *Prog Brain Res* 152:427–439
- Bullmann C, Faust M, Hoffmann A, Heppner C, Jockenhovel F, Muller-Wieland D, Krone W (2000) Five cases with central diabetes insipidus and hypogonadism as first presentation of neurosarcoidosis. *Eur J Endocrinol* 142:365–372
- Buvat J, Lemaire A, Ardaens K, Buvat-Herbaut M, Racadot A (1983) Profile of gonadal hormones in 8 cases of male anorexia nervosa studied before and during weight gain. *Ann Endocrinol* 44:229–234
- Cantu JM, Scaglia HE, Medina M, Gonzalez-Diddi M, Moranto T, Moreno ME, Perez-Palacios G (1976) Inherited congenital normofunctional testicular hyperplasia and mental deficiency. *Hum Genet* 33:23–33
- Carani C, Isidori AM, Granata A, Carosa E, Maggi M, Lenzi A, Jannini EA (2005) Multicenter study on the prevalence of sexual symptoms in male hypo- and hyperthyroid patients. *J Clin Endocrinol Metab* 90:6472–6479
- Carlsen E, Andersson AM, Petersen JH, Skakkebaek NE (2003) History of febrile illness and variation in semen quality. *Hum Reprod* 18:2089–2092
- Castilla-Cortazar I, Garcia M, Quiroga J, Diez N, Diez-Caballero F, Calvo A, Diaz M, Prieto J (2000) Insulin-like growth factor-I reverts testicular atrophy in rats with advanced cirrhosis. *Hepatology* 31:592–600
- Castilla-Cortazar I, Diez N, Garcia-Fernandez M, Puche JE, Diez-Caballero F, Quiroga J, Diaz-Sanchez M, Castilla A, Casares AD, Varela-Nieto I, Prieto J, Gonzalez-Baron S (2004) Hematotesticular barrier is altered from early stages of liver cirrhosis: effect of insulin-like growth factor I. *World J Gastroenterol* 10:2529–2534
- Chen RY, Wittert GA, Andrews GR (2006) Relative androgen deficiency in relation to obesity and metabolic status in older men. *Diabetes Obes Metab* 8:429–435
- Chia SE, Lim ST, Tay SK, Lim ST (2000) Factors associated with male infertility: a case-control study of 218 infertile and 240 fertile men. *Bjog* 107:55–61
- Chillon M, Casals T, Mercier B, Bassas L, Lissens W, Silber S, Romey MC, Ruiz-Romero J, Verlingue C, Claustres M, et al. (1995) Mutations in the cystic fibrosis gene in patients with congenital absence of the vas deferens. *N Engl J Med* 332:1475–1480
- Claahsen-van der Grinten HL, Otten BJ, Hermus AR, Sweep FC, Hulsbergen-van de Kaa CA (2008) Testicular adrenal rest tumors in patients with congenital adrenal hyperplasia can cause severe testicular damage. *Fertil Steril* 89:597–601
- Cosentino MJ, Chey WY, Takihara H, Cockett ATK (1984) The effects of sulphsalazine on human male fertility potential and seminal prostaticlandins. *J Urol* 132:682–686

- Crawford BA, Spaliviero JA, Simpson JM, Handelsman DJ (1998) Testing the gonadal regression-cytoprotection hypothesis. *Cancer Res* 58:5105–5109
- Crawford BA, Liu PY, Kean MT, Bleasel JF, Handelsman DJ (2003) Randomized placebo-controlled trial of androgen effects on muscle and bone in men requiring long-term systemic glucocorticoid treatment. *J Clin Endocrinol Metab* 88:3167–3176
- Crino A, Schiaffini R, Ciampalini P, Spera S, Beccaria L, Benzi F, Bosio L, Corrias A, Gargantini L, Salvatoni A, Tonini G, Trifiro G, Livieri C (2003) Hypogonadism and pubertal development in Prader-Willi syndrome. *Eur J Pediatr* 162:327–333
- Crittenden JA, Handelsman DJ, Stewart GJ (1992) Semen analysis in human immunodeficiency virus infection. *Fertil Steril* 57:1294–1299
- Cundy T, Butler J, Bomford A, Williams R (1993) Reversibility of hypogonadotropic hypogonadism associated with genetic hemochromatosis. *Clin Endocrinol* 38:617–620
- Cunningham KA, Beagley KW (2008) Male genital tract chlamydial infection: implications for pathology and infertility. *Biol Reprod* 79:180–189
- Cutolo M, Balleari E, Giusti M, Intra E, Accardo S (1991) Androgen replacement therapy in male patients with rheumatoid arthritis. *Arthr Rheum* 34:1–5
- daCunha MF, Meistrich ML, Fuller LM, Cundiff JH, Hagemester FB, Velasquez WS, McLaughlin P, Riggs SA, Cabanillas FF, Salvador PG (1984) Recovery of spermatogenesis after treatment for Hodgkins disease: limiting dose of MOPP chemotherapy. *J Clin Oncol* 2:571–577
- Daniell HW, Lentz R, Mazer NA (2006) Open-label pilot study of testosterone patch therapy in men with opioid-induced androgen deficiency. *J Pain* 7:200–210
- Darnton SJ, Zgainski B, Grenier I, Allister K, Hiller L, McManus KG, Steyn RS (1999) The use of an anabolic steroid (nandrolone decanoate) to improve nutritional status after esophageal resection for carcinoma. *Dis Esophagus* 12:283–288
- de la Balze FA, Arrillaga F, Mancini RE, Janches M, Davidson OW, Gurtman AI (1962) Male hypogonadism in hypothyroidism: a study of six cases. *J Clin Endocrinol Metab* 22:212–222
- de Paepe ME, Waxman M (1989) Testicular atrophy in AIDS: a study of 57 autopsy cases. *Hum Pathol* 20:210–214
- Denzer C, Weibel A, Mucic R, Karges B, Sorgo W, Wabitsch M (2007) Pubertal development in obese children and adolescents. *Int J Obes* 31:1509–1519
- Dhindsa S, Prabhakar S, Sethi M, Bandyopadhyay A, Chaudhuri A, Dandona P (2004) Frequent occurrence of hypogonadotropic hypogonadism in type 2 diabetes. *J Clin Endocrinol Metab* 89:5462–5468
- Diamond T, Stiehl D, Posen S (1991) Effects of testosterone and venesection on spinal and peripheral bone mineral in six hypogonadal men with hemochromatosis. *J Bone Min Res* 6:39–43
- Dimitrova D, Kalaydjiev S, Mendizova A, Piryova E, Nakov L (2005) Circulating antibodies to human spermatozoa in patients with ulcerative colitis. *Fertil Steril* 84:1533–1535
- Dong Q, Hawker F, McWilliam D, Bangah M, Burger H, Handelsman DJ (1992) Circulating inhibin and testosterone levels in men with critical illness. *Clin Endocrinol* 36:399–404
- Doumouchtsis KK, Kostakis AI, Doumouchtsis SK, Grapsa EI, Passalidou IA, Tziomalis MP, Poulakou MV, Vlachos IS, Perrea DN (2008) The effect of sexual hormone abnormalities on proximal femur bone mineral density in hemodialysis patients and the possible role of RANKL. *Hemodial Int* 12:100–107
- Dube MP, Parker RA, Mulligan K, Tebas P, Robbins GK, Roubenoff R, Grinspoon SK (2007) Effects of potent antiretroviral therapy on free testosterone levels and fat-free mass in men in a prospective, randomized trial: A5005s, a sub-study of AIDS Clinical Trials Group Study 384. *Clin Infect Dis* 45:120–126
- Dunkel L, Raivio T, Laine J, Holmberg C (1997) Circulating luteinizing hormone receptor inhibitor(s) in boys with chronic renal failure. *Kid Int* 51:777–784
- Dunsmuir WD, Holmes SA (1996) The aetiology and management of erectile, ejaculatory, and fertility problems in men with diabetes mellitus. *Diabet Med* 13:700–708
- Eiam-Ong S, Buranaosot S, Eiam-Ong S, Wathanavaha A, Pansin P (2007) Nutritional effect of nandrolone decanoate in predialysis patients with chronic kidney disease. *J Ren Nutr* 17:173–178
- Eiholzer U, l'Allemand D, Rousson V, Schlumpf M, Gasser T, Girard J, Gruters A, Simoni M (2006) Hypothalamic and gonadal components of hypogonadism in boys with Prader-Labhart-Willi syndrome. *J Clin Endocrinol Metab* 91:892–898
- Emanuele MA, Emanuele N (2001) Alcohol and the male reproductive system. *Alcohol Res Health* 25:282–287
- English KM, Steeds RP, Jones TH, Diver MJ, Channer KS (2000) Low-dose transdermal testosterone therapy improves angina threshold in men with chronic stable angina: a randomized, double-blind, placebo-controlled study. *Circulation* 102:1906–1911
- Esfahani AF, Eftekhari M, Zenooz N, Saghari M (2004) Gonadal function in patients with differentiated thyroid cancer treated with (131)I. *Hell J Nucl Med* 7:52–55
- Falus A, Feher KG, Walcz E, Brozik M, Fust G, Hidvegi T, Feher T, Meretey K (1990) Hormonal regulation of complement biosynthesis in human cell lines – I. Androgens and gamma-interferon stimulate the biosynthesis and gene expression of C1 inhibitor in human cell lines U937 and HepG2. *Mol Immunol* 27:191–195
- Farthing MJR, Dawson AM (1983) Impaired semen quality in Crohn's disease – drugs, ill health, or undernutrition? *Scand J Gastroenterol* 18:57–60
- Fenwick PB, Toone BK, Wheeler MJ, Nanjee MN, Grant R, Brown D (1985) Sexual behaviour in a centre for epilepsy. *Acta Neurol Scand* 71:428–435
- Francis RB, Kasper CK (1983) Reproduction in hemophilia. *JAMA* 250:3192–3195
- Frank MM (2008) 8. Hereditary angioedema. *J Allergy Clin Immunol* 121:S398–401; quiz S419
- Frias J, Torres JM, Miranda MT, Ruiz E, Ortega E (2002) Effects of acute alcohol intoxication on pituitary-gonadal axis hormones, pituitary-adrenal axis hormones, beta-endorphin and prolactin in human adults of both sexes. *Alcohol* 37:169–173
- Garber KB, Visootsak J, Warren ST (2008) Fragile X syndrome. *Eur J Hum Genet* 16:666–672
- Garcia JM, Li H, Mann D, Epner D, Hayes TG, Marcelli M, Cunningham GR (2006) Hypogonadism in male patients with cancer. *Cancer* 106:2583–2591

- Genesca A, Miro R, Caballin MR, Benet J, Germa JR, Egozcue J (1990) Sperm chromosome studies in individuals treated for testicular cancer. *Hum Reprod* 5:286–290
- Gluud C, Bennett P, Dietrichson O, Johnsen SG, Ranek L, Svendsen LB, Juhl E (1981) Short-term parenteral and peroral testosterone administration in men with alcoholic cirrhosis. *Scand J Gastroenterol* 16:749–755
- Gordon D, Beastall GH, Thomson JA, Sturrock RD (1986) Androgenic status and sexual function in males with rheumatoid arthritis and ankylosing spondylitis. *Quart J Med* 231:671–679
- Gray A, Feldman HA, McKinlay JB, Longcope C (1991) Age, disease, and changing sex hormone levels in middle-aged men: results of the Massachusetts Male Aging Study. *J Clin Endocrinol Metab* 73:1016–1025
- Greenfield DM, Walters SJ, Coleman RE, Hancock BW, Eastell R, Davies HA, Snowden JA, Derogatis L, Shalet SM, Ross RJ (2007) Prevalence and consequences of androgen deficiency in young male cancer survivors in a controlled cross-sectional study. *J Clin Endocrinol Metab* 92:3476–3482
- Griggs RC, Pandya S, Florence JM, Brooke MH, Kingston W, Miller JP, Chutkow J, Herr BE, Moxley RT (1989) Randomized controlled trial of testosterone in myotonic dystrophy. *Neurology* 39:219–222
- Grinspoon S, Corcoran C, Lee K, Burrows B, Hubbard J, Katznelson L, Walsh M, Guccione A, Cannan J, Heller H, Basgoz N, Klibanski A (1996) Loss of lean body and muscle mass correlates with androgen levels in hypogonadal men with acquired immunodeficiency syndrome and wasting. *J Clin Endocrinol Metab* 81:4051–4058
- Grinspoon S, Corcoran C, Askari H, Schoenfeld D, Wolf L, Burrows B, Walsh M, Hayden D, Parlman K, Anderson E, Basgoz N, Klibanski A (1998) Effects of androgen administration in men with the AIDS wasting syndrome. A randomized, double-blind, placebo-controlled trial. *Ann Intern Med* 129:18–26
- Grossmann M, Thomas MC, Panagiotopoulos S, Sharpe K, Macisaac RJ, Clarke S, Zajac JD, Jerums G (2008) Low testosterone levels are common and associated with insulin resistance in men with diabetes. *J Clin Endocrinol Metab* 93:1834–1840
- Grunert E, Nyfors A, Hansen KB (1977) Studies on human semen in topical corticosteroid-treated and in methotrexate-treated psoriatics. *Dermatologica* 154:78–84
- Grunstein RR, Handelsman DJ, Lawrence SJ, Blackwell C, Catterson ID, Sullivan CE (1989) Neuroendocrine dysfunction in sleep apnea: reversal by continuous positive airways pressure therapy. *J Clin Endocrinol Metab* 68:352–358
- Haimov-Kochman R, Ben-Chetrit E (1998) The effect of colchicine treatment on sperm production and function: a review. *Hum Reprod* 13:360–362
- Hall GM, Larbre JP, Spector TD, Perry LA, Da Silva JA (1996) A randomized trial of testosterone therapy in males with rheumatoid arthritis. *Br J Rheumatol* 35:568–573
- Handelsman DJ (1985) Hypothalamic-pituitary gonadal dysfunction in chronic renal failure, dialysis, and renal transplantation. *Endocr Rev* 6:151–182
- Handelsman DJ, Dong Q (1992) Ontogenic regression: a model of stress and reproduction. In: Sheppard K, Boublik JH, Funder JW (eds) *Stress and reproduction*, vol 86. Raven Press, New York, pp 333–345
- Handelsman DJ, Dong Q (1993) Hypothalamo-pituitary gonadal axis in chronic renal failure. *Endocrinol Metab Clin North Am* 22:145–161
- Handelsman DJ, Staraj S (1985) Testicular size: the effects of aging, malnutrition, and illness. *J Androl* 6:144–151
- Handelsman DJ, Turtle JR (1983) Testicular damage after radioactive iodine (I-131) therapy for thyroid cancer. *Clin Endocrinol* 18:465–472
- Handelsman DJ, Yue DK, Turtle JR (1983) Hypogonadism and massive testicular infiltration due to amyloidosis. *J Urol* 129:610–612
- Handelsman DJ, Conway AJ, Boylan LM, Turtle JR (1984) Young's syndrome. Obstructive azoospermia and chronic sinopulmonary infections. *N Engl J Med* 310:3–9
- Handelsman DJ, Strasser S, McDonald JA, Conway AJ, McCaughan GW (1995) Hypothalamic-pituitary testicular function in end-stage non-alcoholic liver disease before and after liver transplantation. *Clin Endocrinol* 43:331–337
- Herzog AG, Klein P, Jacobs AR (1998) Testosterone versus testosterone and testolactone in treating reproductive and sexual dysfunction in men with epilepsy and hypogonadism. *Neurology* 50:782–784
- Hill M, Milan S, Cunningham D, Mansi J, Smith I, Catovsky D, Gore M, Zulian G, Selby P, Horwich A, et al. (1995) Evaluation of the efficacy of the VEEP regimen in adult Hodgkin's disease with assessment of gonadal and cardiac toxicity. *J Clin Oncol* 13:387–395
- Howell SJ, Shalet SM (2005) Spermatogenesis after cancer treatment: damage and recovery. *J Natl Cancer Inst Monogr* 34:12–17
- Howell SJ, Radford JA, Adams JE, Smets EM, Warburton R, Shalet SM (2001) Randomized placebo-controlled trial of testosterone replacement in men with mild Leydig cell insufficiency following cytotoxic chemotherapy. *Clin Endocrinol* 55:315–324
- Hubert D, Patrat C, Guibert J, Thiounn N, Bienvenu T, Viot G, Jouannet P, Epelboin S (2006) Results of assisted reproductive technique in men with cystic fibrosis. *Hum Reprod* 21:1232–1236
- Hughes GS, Mathur RS, Margolius HS (1989) Sex steroid hormones are altered in essential hypertension. *J Hypertens* 7:181–187
- Hviid A, Rubin S, Muhlemann K (2008) Mumps. *Lancet* 371:932–944
- Hyer S, Vini L, O'Connell M, Pratt B, Harmer C (2002) Testicular dose and fertility in men following I(131) therapy for thyroid cancer. *Clin Endocrinol* 56:755–758
- Inci K, Duzova A, Aki FT, Bilginer Y, Erkan I, Tasar C, Bakkaloglu A, Bakkaloglu M (2006) Semen variables and hormone profiles after kidney transplantation during adolescence. *Transplant Proc* 38:541–542
- Isojarvi J (2008) Disorders of reproduction in patients with epilepsy: antiepileptic drug related mechanisms. *Seizure* 17:111–119
- Jaaskelainen J, Kiekara O, Hippelainen M, Voutilainen R (2000) Pituitary gonadal axis and child rate in males with classical 21-hydroxylase deficiency. *J Endocrinol Invest* 23:23–27
- Jacquemont S, Hagerman RJ, Leehey MA, Hall DA, Levine RA, Brunberg JA, Zhang L, Jardini T, Gane LW, Harris SW, Herman K, Grigsby J, Greco CM, Berry-Kravis E, Tassone F, Hagerman PJ (2004) Penetrance of the fragile X-associated

- tremor/ataxia syndrome in a premutation carrier population. *JAMA* 291:460–469
- Jaffe A, Chen Y, Kisch ES, Fischel B, Alon M, Stern N (1996) Erectile dysfunction in hypertensive subjects. Assessment of potential determinants. *Hypertension* 28:859–862
- Jaffe MD (1977) Effect of testosterone cypionate on postexercise ST segment depression. *Br Heart J* 39:1217–1222
- Jensen TK, Hjollund NH, Henriksen TB, Scheike T, Kolstad H, Giwercman A, Ernst E, Bonde JP, Skakkebaek NE, Olsen J (1998) Does moderate alcohol consumption affect fertility? Follow up study among couples planning first pregnancy. *BMJ* 317:505–510
- Jensen TK, Andersson AM, Jorgensen N, Andersen AG, Carlsen E, Petersen JH, Skakkebaek NE (2004) Body mass index in relation to semen quality and reproductive hormones among 1,558 Danish men. *Fertil Steril* 82:863–870
- Jin B, McCaughan GW, Handelsman DJ (1999) Effects of liver disease and transplantation on the human prostate. *J Androl* 20:559–565
- Johansen KL, Mulligan K, Schambelan M (1999) Anabolic effects of nandrolone decanoate in patients receiving dialysis: a randomized controlled trial. *JAMA* 281:1275–1281
- Jones RD, Hugh Jones T, Channer KS (2004) The influence of testosterone upon vascular reactivity. *Eur J Endocrinol* 151:29–37
- Kalaydjiev S, Dimitrova D, Mitov I, Dikov I, Nakov L (2007) Serum sperm antibodies after diarrhoeal diseases. *Andrologia* 39:101–108
- Kamischke A, Kemper DE, Castel MA, Luthke M, Rolf C, Behre HM, Magnussen H, Nieschlag E (1998) Testosterone levels in men with chronic obstructive pulmonary disease with or without glucocorticoid therapy. *Eur Respir J* 11:41–45
- Kandeel FR, Swerdloff RS (1988) Role of temperature in regulation of spermatogenesis and the use of heating as a method for contraception. *Fertil Steril* 49:1–23
- Kaneda Y, Fujii A (2000) Effects of chronic neuroleptic administration on the hypothalamo-pituitary-gonadal axis of male schizophrenics. *Prog Neuropsychopharmacol Biol Psychiatry* 24:251–258
- Kapoor D, Goodwin E, Channer KS, Jones TH (2006) Testosterone replacement therapy improves insulin resistance, glycaemic control, visceral adiposity and hypercholesterolaemia in hypogonadal men with type 2 diabetes. *Eur J Endocrinol* 154:899–906
- Karadag F, Ozcan H, Karul AB, Yilmaz M, Cildag O (2007) Sex hormone alterations and systemic inflammation in chronic obstructive pulmonary disease. *Int J Clin Pract* [Epub]
- Katsuno M, Adachi H, Waza M, Banno H, Suzuki K, Tanaka F, Doyu M, Sobue G (2006) Pathogenesis, animal models and therapeutics in spinal and bulbar muscular atrophy (SBMA). *Exp Neurol* 200:8–18
- Kaymakoglu S, Okten A, Cakaloglu Y, Boztas G, Besisik F, Tascioglu C, Yalcin S (1995) Hypogonadism is not related to the etiology of liver cirrhosis. *J Gastroenterol* 30:745–750
- Kelleher S, Wishart SM, Liu PY, Turner L, Di Pierro I, Conway AJ, Handelsman DJ (2001) Long-term outcomes of elective human sperm cryostorage. *Hum Reprod* 16:2632–2639
- Khaw KT, Dowsett M, Folkard E, Bingham S, Wareham N, Luben R, Welch A, Day N (2007) Endogenous testosterone and mortality due to all causes, cardiovascular disease, and cancer in men: European prospective investigation into cancer in Norfolk (EPIC-Norfolk) Prospective Population Study. *Circulation* 116:2694–2701
- Kidson-Gerber GL, Francis S, Lindeman R (2008) Management and clinical outcomes of transfusion-dependent thalassaemia major in an Australian tertiary referral clinic. *Med J Aust* 188:72–75
- Kley HK, Strohmeier G, Kruskemper HL (1979) Effect of testosterone application on hormone concentrations of androgens and estrogens in male patients with cirrhosis of the liver. *Gastroenterology* 76:235–241
- Kley HK, Stremmel W, Kley JB, Schlaghecke R (1992) Testosterone treatment of men with idiopathic hemochromatosis. *Clin Invest* 70:566–572
- Knigge U, Dejgaard A, Wollesen F, Ingerslev O, Bennett P, Christiansen PM (1983) The acute and long term effect of the H2-receptor antagonists cimetidine and ranitidine on the pituitary-gonadal axis in men. *Clin Endocrinol* 18:307–318
- Kort HI, Massey JB, Elsner CW, Mitchell-Leef D, Shapiro DB, Witt MA, Roudebush WE (2006) Impact of body mass index values on sperm quantity and quality. *J Androl* 27:450–452
- Krassas GE, Pontikides N (2004) Male reproductive function in relation with thyroid alterations. *Best Pract Res Clin Endocrinol Metab* 18:183–195
- Krassas GE, Tziomalos K, Papadopoulou F, Pontikides N, Perros P (2008) Erectile dysfunction in patients with hyper- and hypothyroidism: how common and should we treat? *J Clin Endocrinol Metab* 93:1815–1819
- Kraus MR, Schafer A, Bentink T, Scheurlen M, Weissbrich B, Al-Taie O, Seufert J (2005) Sexual dysfunction in males with chronic hepatitis C and antiviral therapy: interferon-induced functional androgen deficiency or depression? *J Endocrinol* 185:345–352
- Ku JH, Kim YH, Jeon YS, Lee NK (1999) The preventive effect of systemic treatment with interferon-alpha2B for infertility from mumps orchitis. *BJU Int* 84:839–842
- Kumar BJ, Kurana ML, Ammini AC, Karmarkar MG, Ahuja MM (1990) Reproductive endocrine functions in men with primary hypothyroidism: effect of thyroxine replacement. *Horm Res* 34:215–218
- La Spada AR, Wilson EM, Lubahn DB, Harding AE, Fischbeck KH (1991) Androgen receptor gene mutation in X-linked spinal and bulbar muscular atrophy. *Nature* 352:77–79
- Lachiewicz AM, Dawson DV (1994) Do young boys with fragile X syndrome have macroorchidism? *Pediatrics* 93:992–995
- Laghi F, Antonescu-Turcu A, Collins E, Segal J, Tobin DE, Jubran A, Tobin MJ (2005) Hypogonadism in men with chronic obstructive pulmonary disease: prevalence and quality of life. *Am J Respir Crit Care Med* 171:728–733
- Lange D, Henning H, Schirren C (1978) Andrologische Untersuchungen bei der Immun-suppressiv-Therapie der chronisch-aggressiven Hepatitis. *Andrologia* 10:373–379
- Laughlin GA, Barrett-Connor E, Bergstrom J (2008) Low serum testosterone and mortality in older men. *J Clin Endocrinol Metab* 93:68–75
- Lin YM, Hsu CC, Lin JS (1999) Successful testicular sperm extraction and fertilization in an azoospermic man with postpubertal mumps orchitis. *BJU Int* 83:526–527
- Linnet L, Hjort T, Fogh-Andersen P (1981) Association between failure to impregnate after vasovasostomy and sperm agglutinins in semen. *Lancet* 1:117–119

- Liu PY, Handelsman DJ (2004) Androgen therapy in non-gonadal disease. In: Nieschlag E, Behre HM (eds) *Testosterone: action, deficiency and substitution*. Cambridge University Press, Cambridge, pp 445–495
- Liu PY, Wishart SM, Celemajer DS, Jimenez M, Pierro ID, Conway AJ, Handelsman DJ (2003a) Do reproductive hormones modify insulin sensitivity and metabolism in older men? A randomized, placebo-controlled trial of recombinant human chorionic gonadotropin. *Eur J Endocrinol* 148:55–66
- Liu PY, Yee BJ, Wishart SM, Jimenez M, Jung DG, Grunstein RR, Handelsman DJ (2003b) The short-term effects of high dose testosterone on sleep, breathing and function in older men. *J Clin Endocrinol Metab* 88:3605–3613
- Liu PY, Caterson ID, Grunstein RR, Handelsman DJ (2007) Androgens, obesity, and sleep-disordered breathing in men. *Endocrinol Metab Clin North Am* 36:349–363
- Loprinzi CL, Kugler JW, Sloan JA, Mailliard JA, Krook JE, Wilwerding MB, Rowland KM, Jr., Camoriano JK, Novotny PJ, Christensen BJ (1999) Randomized comparison of megestrol acetate versus dexamethasone versus fluoxymesterone for the treatment of cancer anorexia/cachexia. *J Clin Oncol* 17:3299–3306
- Loves S, Ruinemans-Koerts J, de Boer H (2008) Letrozole once a week normalizes serum testosterone in obesity-related male hypogonadism. *Eur J Endocrinol* 158:741–747
- Luppa PB, Thaler M, Schulte-Frohlinde E, Schreiwegg A, Huber U, Metzger J (2006) Unchanged androgen-binding properties of sex hormone-binding globulin in male patients with liver cirrhosis. *Clin Chem Lab Med* 44:967–973
- Luton JP, Thieblot P, Valcke JC, Mahoudeau JA, Bricaire H (1977) Reversible gonadotropin deficiency in male Cushing's disease. *J Clin Endocrinol Metab* 45:488–495
- MacDonald ME, Ambrose CM, Duyao MP (1993) A novel gene containing a trinucleotide repeat that is expanded and unstable on Huntington's disease chromosomes. The Huntington's Disease Collaborative Research Group. *Cell* 72:971–983
- Magnusdottir EV, Thorsteinsson T, Thorsteinsdottir S, Heimisdottir M, Olafsdottir K (2005) Persistent organochlorines, sedentary occupation, obesity and human male subfertility. *Hum Reprod* 20:208–215
- Makarevich AE (2003) Disorders of sex hormone status in patients with chronic obstructive pulmonary disease. *Wiad Lek* 56:140–146
- Malkin CJ, Pugh PJ, Morris PD, Kerry KE, Jones RD, Jones TH, Channer KS (2004) Testosterone replacement in hypogonadal men with angina improves ischaemic threshold and quality of life. *Heart* 90:871–876
- Malkin CJ, Jones RD, Jones TH, Channer KS (2006a) Effect of testosterone on ex vivo vascular reactivity in man. *Clin Sci* 111:265–274
- Malkin CJ, Pugh PJ, West JN, van Beek EJ, Jones TH, Channer KS (2006b) Testosterone therapy in men with moderate severity heart failure: a double-blind randomized placebo controlled trial. *Eur Heart J* 27:57–64
- Marin P, Holmang S, Jonsson L, Sjostrom L, Kvist H, Holm G, Lindstedt G, Bjorntorp P (1992a) The effects of testosterone treatment on body composition and metabolism in middle-aged obese men. *Int J Obes Relat Metab Disord* 16:991–997
- Marin P, Krotkiewski M, Bjorntorp P (1992b) Androgen treatment of middle-aged, obese men: effects on metabolism, muscle and adipose tissues. *Eur J Med* 1:329–336
- Markianos M, Panas M, Kalfakis N, Vassilopoulos D (2005) Plasma testosterone in male patients with Huntington's disease: relations to severity of illness and dementia. *Ann Neurol* 57:520–525
- Martens HF, Sheets PK, Tenover JS, Dugowson CE, Bremner WJ, Starkebaum G (1994) Decreased testosterone levels in men with rheumatoid arthritis: effect of low dose prednisone therapy. *J Rheumatol* 21:1427–1431
- Martin FI, Maddocks I, Brown JB, Hudson B (1968) Leprous endocrinopathy. *Lancet* 2:1320–1321
- Massa G, Vanderschueren-Lodeweyckx M, Van Vliet G, Craen M, de Zegher F, Eggermont E (1989) Hypothalamo-pituitary dysfunction in congenital toxoplasmosis. *Eur J Pediatr* 148:742–744
- Mastrogiacomo I, Bonanni G, Menegazzo E, Santarossa C, Pagani E, Gennarelli M, Angelini C (1996) Clinical and hormonal aspects of male hypogonadism in myotonic dystrophy. *Ital J Neurol Sci* 17:59–65
- Mastroianni CA, Meissen GJ, Cupples LA, Kiely DK, Berkman B, Myers RH (1989) Estimation of fertility and fitness in Huntington disease in New England. *Am J Med Genet* 33:248–254
- Matsumoto A, Sandblom RE, Schoene RB, Lee KA, Giblin EC, Pierson DJ, Bremner WJ (1985) Testosterone replacement in hypogonadal men: effects on obstructive sleep apnea, respiratory drives and sleep. *Clin Endocrinol* 22:713–721
- Meistrich ML, Beek MEAB van (1990) Radiation sensitivity of the human testis. *Adv Radiation Biol* 14:227–268
- Meistrich M, Shetty G (2008) Hormonal suppression for fertility preservation in males and females. *Reproduction* [E-pub]
- Mieusset R, Bujan L, Mansat A, Grandjean H, Pontonnier F (1991) Heat induced inhibition of spermatogenesis in man. *Adv Exp Med Biol* 286:233–237
- Monks DA, Rao P, Mo K, Johansen JA, Lewis G, Kemp MQ (2008) Androgen receptor and Kennedy disease/spinal bulbar muscular atrophy. *Horm Behav* 53:729–740
- Neugebauer D, Neuwinger J, Jockenhovel F, Nieschlag E (1990) '9 + 0' axoneme in spermatozoa and some nasal cilia of a patient with totally immotile spermatozoa associated with thickened sheath and short midpiece. *Hum Reprod* 5:981–986
- O'Brien IAD, Lewin IG, O'Hare JP, Corral RJM (1982) Reversible male subfertility due to hyperthyroidism. *BMJ* 285:691
- O'Flaherty C, Vaisheva F, Hales BF, Chan P, Robaire B (2008) Characterization of sperm chromatin quality in testicular cancer and Hodgkin's lymphoma patients prior to chemotherapy. *Hum Reprod* 23:1044–1052
- Obermayer-Straub P, Manns MP (1998) Autoimmune polyglandular syndromes. *Baillieres Clin Gastroenterol* 12:293–315
- Oktenli C, Doganci L, Ozgurtas T, Araz RE, Tanyuksel M, Musabak U, Sanisoglu SY, Yesilova Z, Erbil MK, Inal A (2004) Transient hypogonadotrophic hypogonadism in males with acute toxoplasmosis: suppressive effect of interleukin-1 beta on the secretion of GnRH. *Hum Reprod* 19:859–866
- Okun MS, DeLong MR, Hanfelt J, Gearing M, Levey A (2004) Plasma testosterone levels in Alzheimer and Parkinson diseases. *Neurology* 62:411–413
- Okun MS, Fernandez HH, Rodriguez RL, Romrell J, Suelter M, Munson S, Louis ED, Mulligan T, Foster PS, Shenal BV,

- Armaghani SJ, Jacobson C, Wu S, Crucian G (2006) Testosterone therapy in men with Parkinson disease: results of the TEST-PD Study. *Arch Neurol* 63:729–735
- Ozdemir BH, Ozdemir OG, Ozdemir FN, Ozdemir AI (2002) Value of testis biopsy in the diagnosis of systemic amyloidosis. *Urology* 59:201–205
- Pacini F, Gasperi M, Fugazzola L, Ceccarelli C, Lippi F, Centoni R, Martino E, Pinchera A (1994) Testicular function in patients with differentiated thyroid carcinoma treated with radioiodine. *J Nucl Med* 35:1418–1422
- Pajarinen J, Karhunen PJ, Savolainen V, Lalu K, Penttila A, Laippala P (1996) Moderate alcohol consumption and disorders of human spermatogenesis. *Alcohol Clin Exp Res* 20:332–337
- Parducz A, Hajszan T, Maclusky NJ, Hoyk Z, Csakvari E, Kurunczi A, Prange-Kiel J, Leranthe C (2006) Synaptic remodeling induced by gonadal hormones: neuronal plasticity as a mediator of neuroendocrine and behavioral responses to steroids. *Neuroscience* 138:977–985
- Perera D, Pizzey A, Campbell A, Katz M, Porter J, Petrou M, Irvine DS, Chatterjee R (2002) Sperm DNA damage in potentially fertile homozygous beta-thalassaemia patients with iron overload. *Hum Reprod* 17:1820–1825
- Petersen PM, Skakkebaek NE, Rorth M, Giwercman A (1999) Semen quality and reproductive hormones before and after orchiectomy in men with testicular cancer. *J Urol* 161:822–826
- Petitti DB (1986) Epidemiologic studies of vasectomy. In: Zatzuchni GI, Goldsmith A, Spieler JM, Sciarra JJ (eds) *Male contraception: advances and future prospects*. Harper & Row, Philadelphia, PA, pp 24–33
- Petzke F, Heppner C, Mbulamberi D, Winkelmann W, Chrousos GP, Allolio B, Reincke M (1996) Hypogonadism in Rhodesian sleeping sickness: evidence for acute and chronic dysfunction of the hypothalamic-pituitary-gonadal axis. *Fertil Steril* 65:68–75
- Philip J, Selvan D, Desmond AD (2006) Mumps orchitis in the non-immune postpubertal male: a resurgent threat to male fertility? *BJU Int* 97:138–141
- Pitteloud N, Hardin M, Dwyer AA, Valassi E, Yialamas M, Elahi D, Hayes FJ (2005) Increasing insulin resistance is associated with a decrease in Leydig cell testosterone secretion in men. *J Clin Endocrinol Metab* 90:2636–2641
- Post FA, Soule SG, Willcox PA, Levitt NS (1994) The spectrum of endocrine dysfunction in active pulmonary tuberculosis. *Clin Endocrinol* 40:367–371
- Prem AR, Puneekar SV, Kalpana M, Kelkar AR, Acharya VN (1996) Male reproductive function in uraemia: efficacy of haemodialysis and renal transplantation. *Br J Urol* 78:635–638
- Pridmore SA, Adams GC (1991) The fertility of HD-affected individuals in Tasmania. *Aust N Z J Psychiatry* 25:262–264
- Puliyel MM, Vyas GP, Mehta GS (1977) Testosterone in the management of cirrhosis of the liver – a controlled study. *Austr N Z J Med* 7:17–30
- Radford JA, Clark S, Crowther D, Shalet SM (1994) Male fertility after VAPEC-B chemotherapy for Hodgkin's disease and non-Hodgkin's lymphoma. *Br J Cancer* 69:379–381
- Rajagopal A, Vassilopoulou-Sellin R, Palmer JL, Kaur G, Bruera E (2004) Symptomatic hypogonadism in male survivors of cancer with chronic exposure to opioids. *Cancer* 100:851–858
- Reid IR, Wattie DJ, Evans MC, Stapleton JP (1996) Testosterone therapy in glucocorticoid-treated men. *Arch Int Med* 156:1173–1177
- Rietschel P, Corcoran C, Stanley T, Basgoz N, Klubanski A, Grinspoon S (2000) Prevalence of hypogonadism among men with weight loss related to human immunodeficiency virus infection who were receiving highly active antiretroviral therapy. *Clin Infect Dis* 31:1240–1244
- Rimoin DL, Schimke RN (eds) (1971) *The gonads*. In: *Genetic disorders of the endocrine glands*. C V Mosby, St. Louis, MO
- Robbins WA, Meistrich ML, Moore D, Hagemester FB, Weier HU, Cassel MJ, Wilson G, Eskenazi B, Wyrobek AJ (1997) Chemotherapy induces transient sex chromosomal and autosomal aneuploidy in human sperm. *Nat Genet* 16:74–78
- Rovo A, Tichelli A, Passweg JR, Heim D, Meyer-Monard S, Holzgreve W, Gratwohl A, De Geyter C (2006) Spermatogenesis in long-term survivors after allogeneic hematopoietic stem cell transplantation is associated with age, time interval since transplantation, and apparently absence of chronic GvHD. *Blood* 108:1100–1105
- Rowley MJ, Leach DR, Warner GA, Heller CG (1974) Effect of graded doses of ionizing radiation on the human testis. *Rad Res* 59:665–678
- Safarinejad MR (2008) Evaluation of semen quality, endocrine profile and hypothalamus-pituitary-testis axis in male patients with homozygous beta-thalassemia major. *J Urol* 179:2327–2332
- Sakane T, Takeno M, Suzuki N, Inaba G (1999) Behcet's disease. *N Engl J Med* 341:1284–1291
- Salehian B, Jacobson D, Swerdloff RS, Grafe MR, Sinha-Hikim I, McCutchan JA (1999) Testicular pathologic changes and the pituitary-testicular axis during human immunodeficiency virus infection. *Endocr Pract* 5:1–9
- Sandblom RE, Matsumoto AM, Scoene RB, Lee KA, Giblin EC, Bremner WJ, Pierson DJ (1983) Obstructive sleep apnea induced by testosterone administration. *N Engl J Med* 308:508–510
- Sarkar PS, Paul S, Han J, Reddy S (2004) Six5 is required for spermatogenic cell survival and spermiogenesis. *Hum Mol Genet* 13:1421–1431
- Scalvini T, Martini PR, Gambera A, Tardanico R, Biasi L, Scolari F, Gregorini G, Agabiti Rosei E (2008) Spermatogenic and steroidogenic impairment of the testicle characterizes the hereditary leucine-75-proline apolipoprotein a-I amyloidosis. *J Clin Endocrinol Metab* 93:1850–1853
- Schlatt S (1999) Prospects and problems for germ cell transplantation in the male. *Int J Androl* 22:13–18
- Schneider BK, Pickett CK, Zwillich CW, Weil JV, McDermott MT, Santen RJ, Varano LA, White DP (1986) Influence of testosterone on breathing during sleep. *J Appl Physiol* 61:618–623
- Schneider SA, Bhatia KP (2008) Dystonia in the Woodhouse Sakati syndrome: a new family and literature review. *Mov Disord* 23:592–596
- Schover LR, Brey K, Lichtin A, Lipshultz LI, Jeha S (2002) Knowledge and experience regarding cancer, infertility, and sperm banking in younger male survivors. *J Clin Oncol* 20:1880–1889
- Schramm P, Seyfeddinpur N (1980) Sperm analysis of patients after long term use of hydantoin. *Andrologia* 12:97–101

- Schürmeyer T, Jung K, Nieschlag E (1984) The effect of an 1100 km run on testicular, adrenal and thyroid hormones. *Int J Androl* 7:276–282
- Seidman SN, Araujo AB, Roose SP, Devanand DP, Xie S, Cooper TB, McKinlay JB (2002) Low testosterone levels in elderly men with dysthymic disorder. *Am J Psychiatry* 159: 456–459
- Selvae DJ, Parsons L, Rivier C (2006) Role played by brainstem neurons in regulating testosterone secretion via a direct neural pathway between the hypothalamus and the testes. *Endocrinology* 147:3070–3075
- Semple CG, Robertson WR, Mitchell R, Gordon D, Gray CE, Beastall GH, Reid WH (1987) Mechanisms leading to hypogonadism in men with burns injuries. *BMJ* 295: 403–407
- Sicotte NL, Giesser BS, Tandon V, Klutch R, Steiner B, Drain AE, Shattuck DW, Hull L, Wang HJ, Elashoff RM, Swerdloff RS, Voskuhl RR (2007) Testosterone treatment in multiple sclerosis: a pilot study. *Arch Neurol* 64:683–688
- Silva CA, Hallak J, Pasqualotto FF, Barba MF, Saito MI, Kiss MH (2002) Gonadal function in male adolescents and young males with juvenile onset systemic lupus erythematosus. *J Rheumatol* 29:2000–2005
- Simon D, Charles MA, Lahlou N, Nahoul K, Oppert JM, Gouault-Heilmann M, Lemort N, Thibault N, Joubert E, Balkau B, Eschwege E (2001) Androgen therapy improves insulin sensitivity and decreases leptin level in healthy adult men with low plasma total testosterone: a 3-month randomized placebo-controlled trial. *Diabetes Care* 24:2149–2151
- Singh AB, Norris K, Modi N, Sinha-Hikim I, Shen R, Davidson T, Bhasin S (2001) Pharmacokinetics of a transdermal testosterone system in men with end stage renal disease receiving maintenance hemodialysis and healthy hypogonadal men. *J Clin Endocrinol Metab* 86:2437–2445
- Slowinska-Lisowska M, Majda J (2002) Hormone plasma levels from pituitary-gonadal axis in performance athletes after the 400 m run. *J Sports Med Phys Fitness* 42:243–249
- Smith GD, Ben-Shlomo Y, Beswick A, Yarnell J, Lightman S, Elwood P (2005) Cortisol, testosterone, and coronary heart disease: prospective evidence from the Caerphilly study. *Circulation* 112:332–340
- Somali M, Mpatakoias V, Avramides A, Sakellari I, Kaloyannidis P, Smias C, Anagnostopoulos A, Kourtis A, Rousso D, Panidis D, Vagenakis A (2005) Function of the hypothalamic-pituitary-gonadal axis in long-term survivors of hematopoietic stem cell transplantation for hematological diseases. *Gynecol Endocrinol* 21:18–26
- Southern KW (2007) Cystic fibrosis and formes frustes of CFTR-related disease. *Respiration* 74:241–251
- Spector TD, Perry LA, Tubb G, Silman AJ, Huskisson EC (1988) Low free testosterone levels in rheumatoid arthritis. *Ann Rheum Dis* 47:65–68
- Spruit MA, Thomeer MJ, Gosselink R, Wuyts WA, Van Herck E, Bouillon R, Demedts MG, Decramer M (2007) Hypogonadism in male outpatients with sarcoidosis. *Respir Med* 101:2502–2510
- Stahl NI, Decker JL (1978) Androgenic status of males with systemic lupus erythematosus. *Arthr Rheum* 21:665–668
- Stikkelbroeck NM, Otten BJ, Pasic A, Jager GJ, Sweep CG, Noordam K, Hermus AR (2001) High prevalence of testicular adrenal rest tumors, impaired spermatogenesis, and Leydig cell failure in adolescent and adult males with congenital adrenal hyperplasia. *J Clin Endocrinol Metab* 86:5721–5728
- Stillman MJ (2006) Testosterone replacement therapy for treatment refractory cluster headache. *Headache* 46:925–933
- Strasser F, Palmer JL, Schover LR, Yusuf SW, Pisters K, Vassilopoulou-Sellin R, DeGracia B, Willey JS, Bruera E (2006) The impact of hypogonadism and autonomic dysfunction on fatigue, emotional function, and sexual desire in male patients with advanced cancer: a pilot study. *Cancer* 107:2949–2957
- Stroud MA, Ritz P, Coward WA, Sawyer MB, Constantino-Teodosiu D, Greenhaff PL, Macdonald IA (1997) Energy expenditure using isotope-labelled water (2H218O), exercise performance, skeletal muscle enzyme activities and plasma biochemical parameters in humans during 95 days of endurance exercise with inadequate energy intake. *Eur J Appl Physiol Occup Physiol* 76:243–252
- Suzuki H, Tominaga T, Kumagai H, Saruta T (1988) Effects of first-line antihypertensive agents on sexual function and sex hormones. *J Hypertens Suppl* 6:S649–651
- Svartberg J, von Muhlen D, Schirmer H, Barrett-Connor E, Sundfjord J, Jorde R (2004) Association of endogenous testosterone with blood pressure and left ventricular mass in men. The Tromso Study. *Eur J Endocrinol* 150:65–71
- Tan RS, Pu SJ (2003) A pilot study on the effects of testosterone in hypogonadal aging male patients with Alzheimer's disease. *Aging Male* 6:13–17
- Tanaka S, Togashi K, Rankinen T, Perusse L, Leon AS, Rao DC, Skinner JS, Wilmore JH, Despres JP, Bouchard C (2004) Sex differences in the relationships of abdominal fat to cardiovascular disease risk among normal-weight white subjects. *Int J Obes Relat Metab Disord* 28:320–323
- Taneja N, Kucheria K, Jain S, Maheshwari MC (1994) Effect of phenytoin on semen. *Epilepsia* 35:136–140
- Teruel JL, Marcen R, Navarro-Antolin J, Aguilera A, Fernandez-Juarez G, Ortuno J (1996) Androgen versus erythropoietin for the treatment of anemia in hemodialyzed patients: a prospective study. *J Am Soc Nephrol* 7:140–144
- Thon V, Harle P, Scholmerich J, Kuklinek P, Lokaj J, Straub RH (2007) Lack of dehydroepiandrosterone in type I and II hereditary angioedema and role of danazol in steroid hormone conversion. *Allergy* 62:1320–1325
- Tiitinen A, Valimaki M (2002) Primary infertility in 45-year-old man with untreated 21-hydroxylase deficiency: successful outcome with glucocorticoid therapy. *J Clin Endocrinol Metab* 87:2442–2445
- Tomar R, Dhindsa S, Chaudhuri A, Mohanty P, Garg R, Dandona P (2006) Contrasting testosterone concentrations in type 1 and type 2 diabetes. *Diabetes Care* 29:1120–1122
- Tondolo V, Citterio F, Panocchia N, Nanni G, Favi E, Brescia A, Castagneto M (2005) Gonadal function and immunosuppressive therapy after renal transplantation. *Transplant Proc* 37:1915–1917
- Travison TG, Araujo AB, Kupelian V, O'Donnell AB, McKinlay JB (2007) The relative contributions of aging, health, and lifestyle factors to serum testosterone decline in men. *J Clin Endocrinol Metab* 92:549–555
- Tzvetkov D, Tzvetkova P (2006) Tuberculosis of male genital system – myth or reality in 21st century. *Arch Androl* 52:375–381

- Urban MD, Lee PA, Migeon CJ (1978) Adult height and fertility in men with congenital virilizing adrenal hyperplasia. *N Engl J Med* 299:1392–1396
- van Leeuwen E, Wit FW, Prins JM, Reiss P, van der Veen F, Repping S (2007) Semen quality remains stable during 96 weeks of untreated human immunodeficiency virus-1 infection. *Fertil Steril* [Epub]
- van Leeuwen E, Wit FW, Repping S, Eeftink Schattenkerk JK, Reiss P, van der Veen F, Prins JM (2008) Effects of antiretroviral therapy on semen quality. *Aids* 22:637–642
- Van Raamsdonk JM, Murphy Z, Selva DM, Hamidizadeh R, Pearson J, Petersen A, Bjorkqvist M, Muir C, Mackenzie IR, Hammond GL, Vogl AW, Hayden MR, Leavitt BR (2007) Testicular degeneration in Huntington disease. *Neurobiol Dis* 26:512–520
- van Thiel DH, Gavalier JS, Spero JA, Egler KM, Wight C, Sanghvi AT, Hasiba U, Lewis JH (1981) Patterns of hypothalamic-pituitary-gonadal dysfunction in men with liver disease due to differing etiologies. *Hepatology* 1:39–46
- van Thiel DH, Kumar S, Gavalier JS, Tarter RE (1990) Effect of liver transplantation on the hypothalamic-pituitary gonadal axis of chronic alcoholic men with advanced liver disease. *Alcohol Clin Exp Res* 14:478–481
- Vazquez JA, Pines JA, Martul P, de los Rios A, Gatzambide S, Busturia MA (1990) Hypothalamo-pituitary-testicular function in 70 patients with myotonic dystrophy. *J Endocrinol Invest* 13:375–379
- Veldhuis JD, Wilkowski MJ, Zwart AD, Urban RJ, Lizarralde G, Iranmanesh A, Bolton WK (1993) Evidence for attenuation of hypothalamic gonadotropin-releasing hormone (GnRH) impulse strength with preservation of GnRH pulse frequency in men with chronic renal failure. *J Clin Endocrinol Metab* 76:648–654
- Verpoest W, De Rademaeker M, Sermon K, De Rycke M, Seneca S, Papanikolaou E, Spits C, Van Landuyt L, Van der Elst J, Haentjens P, Devroey P, Liebaers I (2008) Real and expected delivery rates of patients with myotonic dystrophy undergoing intracytoplasmic sperm injection and preimplantation genetic diagnosis. *Hum Reprod* 23:1654–1660
- Villalta J, Balleca JL, Nicolas JM, Martinez de Osaba MJ, Antunez E, Pimentel C (1997) Testicular function in asymptomatic chronic alcoholics: relation to ethanol intake. *Alcohol Clin Exp Res* 21:128–133
- Viviani S, Santoro A, Ragni G, Bonfante V, Bestetti O, Bonadonna G (1985) Gonadal toxicity after combination chemotherapy for Hodgkin's disease. Comparative results of MOPP vs ABVD. *Eur J Cancer Clin Oncol* 21:601–605
- Viviani S, Ragni G, Santoro A, Perotti L, Caccamo E, Negretti E, Valagussa P, Bonadonna G (1991) Testicular dysfunction in Hodgkin's disease before and after treatment. *Eur J Cancer* 27:1389–1392
- Wabitsch M, Ballauff A, Holl R, Blum WF, Heinze E, Remschmidt H, Hebebrand J (2001) Serum leptin, gonadotropin, and testosterone concentrations in male patients with anorexia nervosa during weight gain. *J Clin Endocrinol Metab* 86:2982–2988
- Wallock LM, Tamura T, Mayr CA, Johnston KE, Ames BN, Jacob RA (2001) Low seminal plasma folate concentrations are associated with low sperm density and count in male smokers and nonsmokers. *Fertil Steril* 75:252–259
- Wang C, Tso SC, Todd D (1989) Hypogonadotropic hypogonadism in severe beta-thalassemia: effect of chelation and pulsatile gonadotropin-releasing hormone therapy. *J Clin Endocrinol Metab* 68:511–516
- Warner CL, Griffin JE, Wilson JD, Jacobs LD, Murray KR, Fischbeck KH, Dickoff D, Griggs RC (1992) X-linked spinomuscular atrophy: a kindred with associated abnormal androgen receptor binding. *Neurology* 42:2181–2184
- Webb CM, Elkington AG, Kraidly MM, Keenan N, Pennell DJ, Collins P (2008) Effects of oral testosterone treatment on myocardial perfusion and vascular function in men with low plasma testosterone and coronary heart disease. *Am J Cardiol* 101:618–624
- Whitehead E, Shalet SM, Blackledge G, Todd I, Crowther D, Beardwell CG (1982) The effects of Hodgkin's disease and combination chemotherapy on gonadal function in the adult male. *Cancer* 49:418–422
- Woolf PD, Hamill RW, McDonald JV, Lee LA, Kelly M (1985) Transient hypogonadotropic hypogonadism caused by critical illness. *J Clin Endocrinol Metab* 60:444–450
- Yadav R, Mehta SN, Kumar A, Guleria S, Seenu V, Tiwari SC (2008) A prospective analysis of testicular androgenic function in recipients of a renal allograft. *Int Urol Nephrol* 40(2):397–403
- Zavos PM, Correa JR, Antypas S, Zarmakoupis-Zavos PN, Zarmakoupis CN (1998) Effects of seminal plasma from cigarette smokers on sperm viability and longevity. *Fertil Steril* 69:425–429
- Zelissen PM, van Hattum J, Poen H, Scholten P, Gerritse R, te Velde ER (1988) Influence of salazosulphapyridine and 5-aminosalicylic acid on seminal qualities and male sex hormones. *Scand J Gastroenterol* 23:1100–1104
- Zitzmann M, Rolf C, Nordhoff V, Schrader G, Rickert-Fohring M, Gassner P, Behre HM, Greb RR, Kiesel L, Nieschlag E (2003) Male smokers have a decreased success rate for in vitro fertilization and intracytoplasmic sperm injection. *Fertil Steril* 79(3):1550–1554
- Zuber J, Anglicheau D, Elie C, Bererhi L, Timsit MO, Mamzer-Brunel MF, Ciroldi M, Martinez F, Snanoudj R, Hiesse C, Kreis H, Eustache F, Laborde K, Thervet E, Legendre C (2008) Sirolimus may reduce fertility in male renal transplant recipients. *Am J Transplant* 8(7):1471–1479

Contents

19.1	Potential Adverse Effects on Spermatogenesis	366
19.2	Targets for Toxicity	368
19.2.1	Pre-testicular Targets for Toxicity	368
19.2.2	Testicular Targets for Toxicity	369
19.2.3	Post-testicular Targets for Toxicity	370
19.3	Instances of Environmental or Occupational Toxicity of Possible Relevance to Humans	371
19.3.1	General.....	371
19.3.2	Ionizing Radiation	372
19.3.3	Anti-cancer Therapies.....	372
19.3.4	Dibromochloropropane.....	373
19.3.5	Metals	373
19.3.6	Complex Organochlorine Compounds ...	374
19.3.7	Smoking.....	375
19.3.8	Diet, Alcohol and Social Drugs	376
19.3.9	Electromagnetic Radiation.....	376
19.3.10	Heat	377
19.3.11	Unknown Factors	377
19.3.11.1	Testicular Dysgenesis Syndrome.....	379
19.4	Design and Interpretation of Toxicological Studies	379
19.4.1	Design of Non-human Studies.....	379
19.4.2	Design of Human Studies	379
19.4.3	Regulatory Testing for Reproductive Toxicity	380
19.4.4	Criteria for the Evaluation of Human Toxicology Data.....	381
19.5	Future Perspectives	381
19.5.1	Experimental Studies.....	381
19.5.2	Clinical Implications.....	382
References		383

Humans are exposed to a vast array of chemicals through a wide range of portals. Innumerable environmental, toxic hazards arising from nature have always existed but the additional exposures to man-made chemicals have increased progressively since the Industrial Revolution. Regulatory agencies, themselves the product of public demand for drug regulation following thalidomide and other catastrophes, have developed licensing guidelines for new chemicals in order to protect human populations from damaging environmental exposures, while permitting the production and use of important new chemicals, which are an integral part of our built environment. Over the last 3 decades the scope and sophistication of testing requirements has increased greatly as the quantity and diversity of chemical entities to which humans may be exposed continues to increase. The earliest safety screening mainly concerned **acute toxicity, carcinogenesis and teratogenesis**, however, **reproductive and genetic toxicity** are now being evaluated to an ever increasing extent. Although historically, reproductive effects have been most studied in females, it has been recognized for some years that adverse effects on **male reproductive function** are also important. Indeed, a recent, comprehensive review has listed published data on over 600 chemicals to which humans can be exposed that affect the male reproductive system (Krause 2008).

The need to regulate human exposure to chemicals is widely accepted and regulations intended to govern acceptable exposure apply, in descending order of stringency, to medical drugs, foods and food supplements, cosmetics, veterinary drugs, agricultural products (including herbicides and pesticides), domestic and industrial chemicals. The latter group is currently under the spotlight in Europe at least, as a result of the **Registration, Evaluation, Authorisation and Restriction of Chemical Substances (REACH)**

M. H. Brinkworth (✉)
Biomedical Sciences, University of Bradford,
Bradford, West Yorkshire, BD7 1DP, UK
e-mail: M.H.Brinkworth@bradford.ac.uk

regulation passed by the European Union in 2007 (EC 1907/2006). This directive requires the safety testing of hundreds of chemicals that have not been extensively tested before. Ironically, equally hazardous medical procedures like surgery and *in vitro* fertilization are not as rigorously regulated for safety and efficacy, unlike the drugs they require. Complex regulatory standards exist for all these categories of chemicals with the rigor of the testing and safety margin required varying pragmatically according to likely human exposure and risk. Unfortunately, scientific methodologies to evaluate human health risks, including those to reproduction, remain in their infancy while the task grows in scope and complexity. In principle, **human toxicology** is based on an amalgam of

- Limited **observational human data**, usually retrospective epidemiological studies, and
- More abundant **experimental studies in animals and cells**

The former lacks the rigorous control of randomized or controlled prospective studies, while the latter has uncertain applicability to humans. These approaches are not entirely satisfactory or even complementary, as species-specific variability can lead to contradictory findings. Nevertheless, they are the only tools currently available to bridge rationally the gulf between, on the one hand, the essential task of providing some assurances of safety for current and future exposures to chemicals, while on the other, allowing for the timely introduction of new agents into medicine, industry and, inevitably, into the shared environment.

In such indeterminate settings, the appeal to a so-called “precautionary principle” and banning a substance without adequate scientific evidence, often risks a reversion to decision making by pre-scientific subjective prejudice, easily swayed by news media with an interest in stoking controversy.

The contrast between observational data in humans and data from experimental studies exemplifies **an important distinction in toxicology, that between hazard and risk.**

Experiments aimed purely at determining whether an agent has **the potential to damage a biological system** are concerned with **hazard**. The concept of **risk combines hazard and biological context**. It incorporates

not only the level of exposure but levels reaching the target tissue, the effects of toxifying/detoxifying metabolic systems, repair processes and any other factors modulating the final response. The ultimate objective of toxicological investigations is thus not just to identify particular compounds as theoretically hazardous but to provide the best possible assessment of the actual risks they pose to humans.

19.1 Potential Adverse Effects on Spermatogenesis

Spermatogenesis involves the continuous replication and complex metamorphosis of relatively undifferentiated, diploid, stem cells into highly specialized, motile, haploid cells (see Chap. 3). These haploid gametes must, furthermore, be capable of traveling through the female reproductive tract and fertilizing an ovum (see Chap. 4). This highly complex process occurring in the reproductive tract is closely governed by hypothalamic-pituitary and testicular hormones, thereby making it also susceptible to influences on endocrine organs, notably the brain. It is, therefore, not surprising that environmental agents can adversely affect germ cell development at many different stages and by different means. Indeed, this may explain why huge numbers of sperm are produced (around 2×10^8 per day [see Chap. 2] and 2×10^{12} in a lifetime), while only one is required for fertilizing an ovum, an event usually occurring less than ten times per lifetime.

Chemicals can potentially damage spermatogenesis at any stage from proliferating spermatogonia to mature spermatozoa. Broadly, three different and not mutually exclusive toxic effects are possible: **cell death, sub-lethal cell damage or genetic change.**

Lethally damaged cells either die within the epithelium or are shed into the lumen of the seminiferous tubule. Those dying *in situ* may do so by

- **Necrosis**, an uncontrolled lysis and non-specific spilling of cellular contents, which may cause a local inflammatory reaction, or by
- **Apoptosis**, a physiological process of programmed cell death whereby a doomed cell breaks down into smaller, apoptotic bodies that are then phagocytosed by Sertoli cells without bystander damage (Kerr et al. 1972).

Apoptosis is the orderly mechanism by which spermatogenic cells die within the germinal epithelium without collateral damage to adjacent Sertoli or germ cells. It is well established that apoptosis is a major mechanism of action of testicular toxins such as, for example, the paint-industry compound ethylene glycol monomethyl ether (see Bagchi and Waxman 2008 for a review) and its active metabolite, methoxyacetic acid (MAA) (Brinkworth et al. 1995), for which the mechanism of action is still being determined (Tirado et al. 2003; Barone et al. 2005). Likewise, apoptosis is an important response to adverse physiological conditions in the testis such as gonadotropin deprivation (Tapanainen et al. 1993; Brinkworth et al. 1995) and heat exposure (Hikim et al. 2003).

There are, broadly speaking, two pathways by which apoptosis may be induced in male germ cells: extrinsic and intrinsic. However, there are different routes within these categories as well as cross-talk between them. For a useful general review, see Elmore (2007). The best-known extrinsic pathway in the testis is the **Fas – Fas-ligand system** (Lee et al. 1997). According to this model, constitutive expression of Fas ligand in Sertoli cells leads to apoptosis in germ cells that are stimulated to express Fas as a result of an apoptotic signal, and is a p53-independent mechanism. The intrinsic pathway involves cell death occurring as part of a developmental program or as a result of physiological signals. However, some toxins and radiation also activate this pathway. These generally act via p53 but it is also likely that there are p53-independent intrinsic mechanisms as well. Furthermore, it has also been shown that Fas can be expressed in p53-dependent pathways and bring about cell death without the involvement of FasL (Embree-Ku et al. 2002).

The net result of activation of either the extrinsic or intrinsic pathways in testicular germ cells is the activation of members of a family of proteases called caspases. Different family members have different roles, but ultimately the cell enters the so-called ‘executioner phase’ in which certain caspases, nucleases and other enzymes degrade the cellular components and cause the transformation of the cell into apoptotic bodies that can be phagocytosed by neighboring Sertoli cells.

Since apoptosis is an important mechanism for deleting damaged cells from the germline, there has been interest in the consequences of an impairment of apoptosis on the persistence of genetic damage in the germline, and its implications for the transmission of

mutation to the next generation. For example, it has been found that administration of a cyclophosphamide treatment regimen to male rats that leads to the induction of fetal abnormalities among a proportion of their offspring (low-dose, chronic administration) (Trasler et al. 1985) also reduces the level of apoptosis among their germ cells (Brinkworth and Nieschlag 2000). Thus, not only may apoptosis be a response to male reproductive toxicity but disturbances of apoptosis could also influence the vertical transmission of mutation (Brinkworth 2000). It is possible but unproven that this mechanism could be involved in the age-related increase in human germline mutation rate.

An increase in mutation rate in the sperm of older men has been known for many years (Crow 1997, 2000). The sperm of elderly men are known to contain elevated levels of genetic damage (Sloter et al. 2007) and there is a close association between paternal age and the incidence in their children of certain genetic diseases such as achondroplasia, Apert syndrome and others (reviewed in Crow 1997, 2000; Kühnert and Nieschlag 2004). However, the mechanisms by which these phenomena arise remain elusive as the increased mutation rates leading to achondroplasia (Tiemann-Boege et al. 2002) and Apert syndrome (Choi et al. 2008) are insufficient alone to account for the increased incidence of disease. They may be better explained by a survival advantage conferred by the mutations on testicular germ cells. This mechanism could lead, over a man’s lifetime, to a significant enrichment of the proportion of sperm bearing the respective mutation without the need to invoke an increase in the *de novo* mutation rate. However, the evidence of increased genetic damage and the multiplicity of diseases associated with advanced paternal age may suggest that several mechanisms could be in operation (Kühnert and Nieschlag 2004).

Influences on embryonic gene expression via germline epigenetic mechanisms (DNA methylation, histone modification, vertical transmission of RNA, etc.) is an area of rapidly developing interest although little is known about their importance in reproductive toxicology (Miller et al. 2007). Recent studies claiming epigenetic transgenerational toxicological effects in rodents (Anway et al. 2005; Anway and Skinner 2008) still await verification (Schneider et al. 2008) and clarification of relevant mechanisms.

Non-lethal germ cell damage will either be **repaired** or leave permanent effects on the structure or

function of the mature spermatozoa, including the possibility of **transgenerational genetic effects**. It has been suggested that **chronic, low-dose exposures** can be more effective at inducing **paternally-mediated effects in the offspring** (Anderson et al. 1996) than the high, acute exposures. Effects observed are most commonly gross morphological abnormalities in the fetuses (Trasler et al. 1985) but there is evidence that certain, specific, dosing regimens can induce cancer in the offspring (Lord et al. 1998). It has been suggested that these could be the result either of a suppression of apoptosis or the induction of genomic instability (Brinkworth 2000). Clinical implications are far from clear due to the lack of evidence for similar effects in human populations.

Almost nothing is known about the **repair of non-genetic damage** in germ cells. DNA repair on the other hand is the subject of enormous research effort, including a considerable amount in the testis (see Baarends et al. 2001 for a review). DNA repair enzymes are extremely important throughout spermatogenesis and participate in a multitude of functions, serving not just as a defence against exogenously induced damage. Different enzymes are expressed in different germ cells but many types also overlap throughout germ cell development. It is therefore difficult to generalize about the status of any one type of repair system in particular cell types. However, it is broadly true to say that **base excision repair** and **mismatch repair** systems are present throughout the mitotic and meiotic stages while *nucleotide excision repair* and **transcription coupled repair** systems are most important in spermatogonia. These systems are likely to be especially important in the repair of damage caused not only by exogenous but also endogenous agents, which include free radicals arising as a result of cellular processes such as respiratory oxidation. During meiosis, a host of other systems can be found, in particular **homologous repair** and **non-homologous** end-joining enzymes. These are likely to aid in the recombination events characteristic of meiosis. DNA repair capacity is known to diminish during spermatid elongation and to be virtually non-existent in spermatozoa. This can make them more susceptible to the effects of hazards such as radiation and alkylating drugs, although some protection may be afforded by the progressive chromatin condensation that accompanies spermatid elongation.

19.2 Targets for Toxicity

Testicular function, including androgen secretion and the production of fertile spermatozoa, can be adversely affected by pre-testicular, testicular and post-testicular mechanisms.

The following mechanisms need not necessarily apply to the whole population but also to vulnerable subgroups who may have genetic polymorphisms that enhance or reduce individual or group susceptibility to toxicological processes, as observed in pharmacogenetic studies. Such systematic variation in susceptibility may result in apparent enhancement of effects in small, but vulnerable, subpopulations. Further toxicological studies of genetic polymorphisms in susceptibility to environmental agents are needed.

19.2.1 Pre-testicular Targets for Toxicity

Testicular function is regulated by the pituitary hormones FSH and LH (see Chap. 3) and toxicity that disturbs this level of control is considered to be pre-testicular. This includes **occupational exposure to sex steroids** such as estrogens, which, if absorbed sufficiently, can inhibit pituitary gonadotropin secretion resulting in semen abnormalities, sexual dysfunction, gynecomastia and hypogonadotropic hypogonadism (see Sheiner et al. 2003). Examples reported include sentinel populations such as men working in the industrial manufacture of synthetic contraceptive estrogens (Harrington et al. 1978) or handling large quantities of a non-steroidal estrogenic chemical (Finkelstein et al. 1988). More recently it has been claimed that community-wide prenatal exposure to estrogen-mimicking compounds could potentially act through such a mechanism, by inhibition of fetal gonadotropin secretion and a consequent **reduction in Sertoli cell proliferation** (Sharpe and Skakkebaek 1993; Toppari et al. 1996). However epidemiological evidence has largely refuted this estrogen pollution hypothesis (Storgaard et al. 2006; Wilcox et al. 1995). The opposite effect can be produced experimentally by neonatal exposure of rats to **polychlorinated biphenyls** that have the ability to reduce serum thyroxine levels. This leads to hypothyroidism and a consequent increase

in **Sertoli cell numbers, testis weight and daily sperm production** (Cooke et al. 1996).

19.2.2 Testicular Targets for Toxicity

Direct testicular toxicity may affect any of the various cell types within the testis including Leydig, Sertoli and germ cells. In practice, the primary effects of toxic chemicals appear to act relatively specifically on individual cell types, although the complex interdependence of spermatogenesis and steroidogenesis dictates that following the initial impact, more universal, pan-testicular effects are often observed.

Selective Leydig cell damage is well known experimentally in animals given the compound ethane dithane sulphonate (EDS). This is an alkylating agent that selectively destroys Leydig cells by an unexplained mechanism, leading subsequently to degeneration of the most androgen-dependent germ cells, pachytene spermatocytes in rat stages VII–VIII (Bartlett et al. 1986). However, no human counterpart of this model exhibiting selective Leydig cell toxicity is known and non-human primates are insensitive to EDS.

Leydig cell adenoma is a relatively rare clinical condition that, along with Leydig cell hyperplasia, nonetheless occurs quite commonly in chronic toxicity studies undertaken in rodents for safety evaluation purposes. The discrepancy between the frequency of occurrence in test species and humans suggests that such a finding does not necessarily have relevance for humans (Prentice and Meikle 1995; Clegg et al. 1997). However, if the mode of action of, and potential exposure to, a toxin is considered relevant, this should be taken into account in the risk assessment procedure (Clegg et al. 1997).

Sertoli cells fulfill an enormous array of functions, playing a cardinal role in regulating and supporting spermatogenesis as well as forming the scaffolding of the seminiferous tubule and creating its unique internal milieu. Consequently, **direct toxicity to Sertoli cells** should have marked effects on sperm production and function (Boekelheide 1993). Identification of selective Sertoli cell toxicity in experimental animals is difficult and relies on observation of early vacuolation and loss of seminiferous tubular fluid production followed by loss of germ cells and reflex increases in

gonadotropin secretion (Boekelheide 1993). More recent identification of Sertoli cell-specific genes useful for quantifying changes in gene expression patterns may also prove advantageous in the future. Three classes of industrial chemical have been implicated as Sertoli cell-specific toxicants:

- **Phthalates**, used as plasticizers,
- **Nitroaromatic compounds**, intermediates in production of dyes and explosives, and
- **γ -Diketones**, used as solvents

Dibromoacetic acid is a further example of a Sertoli cell toxin (Linder et al. 1997). The molecular mechanisms of Sertoli cell toxicity from all these agents, however, remain unclear. The germ-cell loss that is always consequent upon Sertoli cell damage may be mediated by an up-regulation of FasL expression in order to facilitate the elimination of germ cells that can no longer be supported (Lee et al. 1999). While experimental models of chemicals with relatively selective toxicity on Sertoli cells have been established, at present no specific, human Sertoli cell toxins are well described.

Germ cells are mostly located within the diffusion-tight blood-testis-barrier, thereby achieving some protection from extrinsic chemicals. The best established evidence for **direct toxicity to human germ cells** is the exquisite sensitivity of spermatogonia to ionizing irradiation and alkylating agents. The most sensitive cells are the spermatogonia, which are the only germ cell type to develop at the base of the Sertoli cells, outside the blood-testis-barrier.

Spermatogonial sub-types differ in sensitivity to cytotoxins, leading to important implications for recovery from toxicity. For example the A_0 , or **non-proliferating, spermatogonia** constitute the germinal stem-cell population, **destruction of which leads to irreversible spermatogenic damage**. Examples of stem-cell toxins include adriamycin in the mouse (but not humans) and **MOPP** combination chemotherapy (**nitrogen mustard, vincristine, procarbazine, prednisone**) in men treated for Hodgkin disease, both of which exhibit essentially irreversible spermatogenic damage presumably due to A_0 spermatogonia ablation. In contrast, proliferating spermatogonia, though even more sensitive to such cytotoxic effects, can be replaced from stem cell reserves that are activated by the depletion of these dividing cell populations. Thus, spermatogenic damage from

selective toxicity to proliferating spermatogonia (e.g., as with lower doses of ionizing radiation and many cytotoxic drugs) can lead to complete, but temporary, loss of spermatogenesis, although its reversal through stem-cell replenishment may take years. Furthermore, non-lethal germ cell damage may induce genetic mutations in stem-cell DNA, which can lead to persistent genetic changes in sperm formed subsequently. Although such chromosome defects have been detected up to 20 years after cancer therapy in humans (Brandriff et al. 1994), present evidence indicates no excess of congenital malformations or carcinogenesis among progeny of male cancer treatment survivors (Byrne et al. 1998).

Spermatocytes and spermatogonia are the germ cell types involved in meiosis, a unique genetic process involving one round of DNA replication (spermatogonia) and two of cellular division (spermatocytes), making these cells vulnerable to certain toxins as well as to genetic mutations. 2-Methoxyethanol (ME), a constituent of varnishes and paints, is the best characterized spermatocyte toxin (Creasy et al. 1985; Anderson et al. 1987), an effect manifested through its metabolite, methoxyacetic acid (MAA). At high doses, MAA causes almost complete and selective elimination of pachytene spermatocytes in rats by an apoptotic rather than necrotic process (Brinkworth et al. 1995). It has been reported that rabbits are tenfold more sensitive than rodents (Berndtson and Foote 1997) but it is not known which is the more relevant model for the human in this respect. Occupational exposure to ME has, however, been suggested to have adverse effects on spermatogenesis in humans (Welch et al. 1988).

Diploid germ cells may be more vulnerable than their haploid equivalents to spontaneous cell death (Kerr 1992) and possibly also to apoptosis induced by testicular toxicants. Spontaneous germ cell death is believed to be a mechanism to eliminate surplus germ cells and maintain an optimal number for adequate Sertoli cell support (see Chap. 2). The same process induced in response to toxins is, in contrast, often a mechanism for protecting the germline by eliminating genetically compromised cells that could pass on deleterious characteristics to the next generation. In addition to outright death, round spermatids can also be lost by germinal exfoliation, a process whereby large numbers are released prematurely, although their subsequent fate is unclear. The reasons for this are unclear but presumably reflect some pathological state in the testis. Sertoli cell toxicity from chemical exposure can

also sometimes have the same effect as the stricken Sertoli cell becomes unable to maintain its attachment to the spermatids. Conversely, persistence of effete germ cells that escape apoptosis may be a possible mechanism for the origins of the carcinoma-in-situ (CIS) premalignant cells from which some testicular tumors originate (Sonne et al. 2008).

Meiotic recombination involves a variety of different processes, which may result in the duplication, deletion or rearrangement of stretches of DNA along a chromosome and the exchange of genetic material between chromosomes. Whilst this is a normal process that contributes to genetic diversity among gametes, it is potentially a target for genotoxins. **Minisatellites** are stretches of DNA containing tandemly repeated sequence motifs, distributed apparently randomly throughout the genome in humans. They are believed to be particularly prone to **rearrangement** during meiosis (Dubrova et al. 1998) and have spontaneous mutation rates up to 1,000-fold greater than protein-coding sequences. Therefore, they may be suitable sentinel sequences for the determination of exposure to germ cell mutagens and of alterations in mutation rates. The children of men exposed to radiation at Chernobyl have been found to have elevated levels of minisatellite mutations in their sperm (Dubrova et al. 1996, 2002) and similar findings exist for rodents (Fan et al. 1995). Intriguingly, however, data from the sperm of men before and after chemotherapy or radiotherapy show no sign of a treatment-induced increase in the germ line minisatellite mutation rate (Armour et al. 1999; Zheng et al. 2000). These data accord with the lack of effect on offspring following cancer treatment referred to above and may highlight a difference between environmental and therapeutic exposures or more effective human DNA repair mechanisms.

19.2.3 Post-testicular Targets for Toxicity

In contrast to testicular toxicity, post-testicular toxic effects on sperm after leaving the rete testis appear relatively uncommon. In experimental animals for example, mature spermatozoa are more resistant to DNA strand-breaking by high-dose ionizing radiation (Rousseaux et al. 1993) than are testicular germ cells.

Nonetheless, the radiomimetic drug cyclophosphamide can induce mutagenic lesions in maturing sperm that result in **pre-implantation losses** following fertilization (Hales and Robaire 1993). Most post-testicular toxicity has been discovered during the search for novel non-hormonal chemical contraceptives for men (see Chap. 30). The neuromusculature of the epididymis can be affected by adrenolytic drugs such as guanethidine or methoxamine that lead to **stasis of sperm in the epididymis**, which may even swell and rupture as a result. Conversely, **sperm transport** through the epididymis may also be **accelerated**, resulting in ejaculates containing fewer or immature sperm. Toxins acting on the epididymal epithelium, such as gossypol, interfere with **epididymal fluid secretion**. Sperm undergoing epididymal transport represent another target for post-testicular toxicity. Compounds such as α -chlorhydrin and the 6-chloro-6-deoxysugars or ornidazole have highly specific effects on rat epididymal sperm, resulting in complete **loss of motility** and hence sterility. These mechanisms may be illustrated by the clinical syndrome of epididymal necrospermia described in infertile men in which normally developed sperm appear to undergo lethal damage during epididymal transit although the toxicological basis remains unknown (for details see Chap. 30).

19.3 Instances of Environmental or Occupational Toxicity of Possible Relevance to Humans

19.3.1 General

The contamination of the environment by pollutants comes from a variety of sources, including the burning of fuels and waste, widespread use of pesticides, release of products from industrial processes, leaching of chemicals from manufactured products and food, excretion of pharmaceuticals and metabolites into the water supply etc. Most health concerns about environmental chemicals have generally focused on potential carcinogenicity rather than adverse reproductive effects. As a result, efforts to reduce the risks of exposure have been an on-going exercise for several decades (Table 19.1).

Table 19.1 Examples of occupational exposures and their potential adverse effects on male reproductive function (Data from sources as cited in the text and Giwercman and Bonde 1998 and Jensen et al. 2006)

Exposure	Effects on:
Heat	Sperm morphology, motility, fertility
<i>Radiation</i>	
X-rays	Sperm count, minisatellite mutations, fertility?
<i>Heavy metals</i>	
Lead	Sperm morphology, count, motility, semen volume, fertility?
<i>Synthetic estrogens</i>	
Diethylstilboestrol	Hormone levels, genital malformations
Oral contraceptives	Gynecomastia, libido, impotence
<i>Glycol ethers</i>	
2-Methoxyethanol	Sperm morphology, count
2-Ethoxyethanol	Sperm morphology, count
<i>Pesticides</i>	
Dibromochloropropane	Sperm count, motility, fertility
Ethylenedibromide	Sperm morphology, count, motility
<i>Solvents</i>	
Carbon disulfide	Sperm morphology, count, impotence

These include not only stringent safety testing, and tight regulation and monitoring of exposure levels during manufacturing, but also refinements in use e.g., spraying techniques for pesticides. A recent analysis of the association between environmental contaminants and trends in fertility/infertility revealed no more than a weak association between exposure and fertility (Foster et al. 2008). Even more tellingly, a survey of data on the most common environmental contaminants for which there is experimental evidence of effects on semen parameters showed that they are relatively minor and in some cases contradictory (Phillips and Tanphaichitr 2008).

Such low-level, inconsistent effects do not support claims of a major risk to human reproduction from environmental pollutants. It is of course important to identify specific exposures that do adversely impact some populations (Hauser and Sokol 2008; and see Sect. 19.5.1.2 “Human Studies”) and continued vigilance and population monitoring are essential. The likelihood is that any effects are confined to particular combinations of chemical hazard, exposure level and susceptibility of the local population. Identifying these remains problematic for a number of reasons, not least because the numbers affected in such isolated cases are usually too low for powerful studies.

Details of the commonest hazards thought to provide a potential risk to men's reproductive health are described below. However, it is clear that the vast majority of agents investigated do not significantly affect male reproductive health. This is important because concerns about environmental exposure always provide profitable material for sensationalist media scare stories.

19.3.2 Ionizing Radiation

Ionizing radiation is the best studied and among the first agents to be known to have anti-spermatogenic effects in humans. Detailed studies, including serial sperm counts and testicular biopsies following single measured doses of ionizing radiation administered to the testes of US prisoner volunteers, were conducted during the 1950s and 1960s and demonstrated clear dose-dependent and reversible damage to spermatogenesis (Rowley et al. 1974). These findings (Table 19.2) were most consistent with the interpretation that direct damage to **proliferating spermatogonia** was the **most sensitive element**, leading to depression in sperm output from as little as 20cGy and azoospermia above 75cGy doses. Higher doses caused delay in recovery of sperm output, which was proportional to dose and beyond 400cGy the spermatogenic damage persisted for up to 5 years and may have been irreversible, consistent with stem cell killing. Subsequently, studies of men exposed to accidental, atomic bomb-related, occupational or therapeutic irradiation confirmed these findings (Neel 1998). In contrast to somatic cells, dose fractionation enhances germinal cell killing (Meistrich and van Beek 1990).

Among germ cells that survive irradiation, minisatellite mutations (Fan et al. 1995) and chromosomal

damage (Ryabokon and Goncharova 2006) can be observed and have been tracked through multiple generations of bank vole (*Clethrionomys glareolus*) living on land heavily contaminated by the explosion at Chernobyl (Ryabokon and Goncharova 2006). These can lead to cell death, repair or to transmission of cytogenetic alterations. Effects on the quality of the sperm may also occur. Workers involved in the clean-up operation following the accident at Chernobyl were reported to show reduced sperm motility and elevated levels of ultrastructural defects (Bartoov et al. 1997). Increases in minisatellite mutation rates transmitted via the paternal germline occur (Dubrova et al. 1996, 2002) but as yet there is no evidence of any dramatic effect on germline chromosome damage in humans, as is seen in the Chernobyl rodents.

More controversially, a number of years ago environmental irradiation was also suggested as contributing, via paternal radiation exposure, to childhood leukemia clusters around nuclear plants such as at Sellafield (UK) (Gardner et al. 1990). These claims were criticized (Doll et al. 1994) as lacking a specific mechanism, being inconsistent with the lack of similar effects from atom bomb survivors (Kodama et al. 1996) as well as not being replicated at other nuclear plants (Kinlen et al. 1993). A major study, which gathered data from 35,949 children with cancer in Great Britain over 38 years, indicated no causal link with paternal radiation exposure (Draper et al. 1997). The original observation thus remains unexplained though it may have been a chance event or due to infection caused by the mixing of viral infected and noninfected populations, as has been proposed as the explanation for higher rates of leukemia among infants in rural British 'new towns' (Kinlen et al. 1990). Nonetheless, concerns about the hazards of chronic exposure to low doses of radiation persist and a significant association between stillbirths and total radiation dose before conception among male workers at Sellafield has been reported (Parker et al. 1999).

Table 19.2 Summary of the effects of ionizing radiation on the human testis by dose (Data from Rowley et al. 1974 and Jockenhövel 1993)

Dose (cGy)	Effect	Reversibility
<10	Little effect	–
10–50	Moderate oligozoospermia	6 months
50–75	Severe oligozoospermia	6 months
75–100	Azoospermia	6 months
200–300	Azoospermia	1–2.5 years
>300	Azoospermia	~5 years or none

19.3.3 Anti-cancer Therapies

Exposures to X-radiation and cytotoxic mutagens are central to the treatment of malignancy. Collateral to their cell-killing therapeutic effects, surviving cells theoretically accumulate genetic damage, especially in germinal stem cells, which could lead to **transmission**

Table 19.3 Incidence of genetic disease in the offspring of parents surviving cancer and in sibling controls (Data from Byrne 1999)

	Birth defects in the offspring of:	
	Survivors	Sibling controls
Offspring with birth defects	74	142
Total number of offspring	2,198	4,544
Percentage	3.4%	3.1%

of mutations and/or malformations. A persistently elevated level of DNA strand breakage in the sperm of a treated patient has been reported (Morris 2002) although two separate studies of several patients did not find any increase in minisatellite mutations (Armour et al. 1999; Zheng et al. 2000). As a form of fertility insurance in the event that fertility is not recovered in a timely fashion, patients undergoing potentially sterilizing treatments should now be routinely offered **sperm cryopreservation** before commencing therapy (see Chap. 24). It remains controversial whether semen samples obtained after the start of treatment should also be cryostored and what delay in fathering a child after treatment (if any) should be advised on genotoxicity grounds. At the heart of this dilemma is the **relevance of animal data to humans**, a problem common in human toxicology.

Whereas experimental studies in laboratory rodents suggest that irradiation and chemotherapeutic agents consistently increase the risk of genetic alterations in post-spermatogonial germ cells, no such risks have been observed among children born to men surviving oncological treatment (Byrne et al. 1998; Sankila et al. 1998; Meirow and Schiff 2005) (Table 19.3).

Whether this represents a lack of power to detect heritable effects in the epidemiology studies (Byrne 1999), **species-variability**, an undetected increase in early human **abortions** of abnormal fetuses, or a **difference in susceptibility** between **stem cells and proliferating spermatogonia**, remains to be clarified.

19.3.4 Dibromochloropropane

The nematocide dibromochloropropane (DBCP) was widely used for pest control in banana and other

plantations during the 1970s until production workers and crop sprayers in the USA and Israel were discovered to be infertile (Whorton et al. 1977; and e.g., Sheiner et al. 2003). DBCP caused testicular damage manifested by oligozoospermia and azoospermia with increased blood FSH and LH levels, the degree of damage being proportional to duration of exposure (Whorton et al. 1977). Subsequent follow-up demonstrated recovery only in some of the heavily exposed men with the remainder believed to have **irreversible damage** (Eaton et al. 1986). Although this was not the first agent identified to cause human male infertility, the effects of DBCP were so dramatic and clearly related to the industrial exposure that the incident became the classic example of occupational male reproductive toxicity. Furthermore, despite bans on its use in many countries, DBCP is still in use elsewhere, particularly in the developing world.

19.3.5 Metals

Numerous published reports have linked exposure to heavy metals such as lead, cadmium and mercury with male infertility; however, this data is mostly unconvincing due to technical inadequacies of the studies, especially the lack of standardized protocols, small sample sizes and inadequate control groups. The best available evidence concerns occupational exposure to **lead**, which at **high body burdens** is associated with **testicular dysfunction** (Lancranjan et al. 1975). A Chinese study of occupational lead exposure found a positive association between blood levels of $>400 \mu\text{g/L}$ lead and adverse effects on total sperm count, semen volume etc. (Xuezhi et al. 1992) and similar results were found in a study of workers at a lead smelter (Alexander et al. 1996). However, the lower lead levels achieved through industrial hygiene measures as well as community measures such as elimination of lead-based paints, pipes and petrol, means that exposures to ambient levels under normal community conditions no longer appear to be sufficient to cause adverse effects on human male reproduction, as is borne out by a lack of effect on time-to-pregnancy (Joffe et al. 1999). Limited studies of men with low lead exposure suggest a correlation between blood lead levels ($<150 \mu\text{g/ml}$) and abnormal semen and sex steroid parameters (e.g., Telisman et al. 2007) but this awaits confirmation. It is

possible that synergy between smoking and lead exposure could make adverse effects on sperm parameters more likely (Hsu et al. 2008, see Sect. 19.3.7).

Less convincing is evidence linking elevated seminal plasma **cadmium** levels (Chia et al. 1992) or **mercury** intoxication among battery workers, with defects in spermatogenesis. A detailed study of two individuals with high levels of intra-testicular cadmium found no clear correlation between the heavy metal residues in seminal plasma and fertility (Keck et al. 1995).

Welding is an occupation that has been investigated in a number of studies for adverse effects on male reproduction. It is, however, an occupation with a variety of potential risk factors, including exposure to fumes containing the metals used in the welding, to the heat generated and to electromagnetic fields. The early studies produced contradictory results but the most recent data suggest no significant influence on semen parameters, gonadotropins or testosterone (Hjollund et al. 1998a), or on time-to-pregnancy (Hjollund et al. 1998b). In the latter study, however, there was evidence of a possible effect on welders who also smoked.

19.3.6 Complex Organochlorine Compounds

Complex organochlorine compounds include diverse chemicals such as dioxins, **polychlorinated biphenyls** and **bifurans**. Many are widely distributed throughout the environment of all populated parts of the world and have been suspected of causing reproductive toxicity. Many are **teratogens** and can have very weak hormonal properties as **estrogens, anti-estrogens or anti-androgens**. Those with estrogenic activity have been termed **xenoestrogens** but there is also concern over the role of anti-androgens, which may have analogous effects (Kelce and Wilson 1997). There is often overlap in the activity of these chemicals with some xenoestrogens showing anti-androgenic activity (Sohoni and Sumpter 1998). The non-specific, journalistic term “**endocrine disruptors**” has been widely used to describe chemicals with any of these activities.

Prenatal exposure to xenoestrogens has been **proposed to inhibit fetal testicular development**, thereby leading to **reduced sperm production** and impaired male fertility (Sharpe and Skakkebaek 1993). Such

hormonally active compounds could, according to the hypothesis, inhibit Sertoli cell proliferation either indirectly via inhibition of pituitary FSH secretion or directly at a testicular level. They would thus reduce final Sertoli cell numbers populating the testis and, since the germ cell carrying capacity of Sertoli cells is limited, could ultimately lower the numbers of germ cells eventually supported by the seminiferous epithelium (Sharpe 1993). In addition, it has been suggested that endocrine disruptors could be responsible for an increase in the incidences of reproductive system malformations and testicular cancer (Skakkebaek et al. 1998).

Xenoestrogens have only very weak steroidal activity, however, and are unlikely to be present at **biologically effective levels** in the male fetus, which resides within the pregnant uterus, the most estrogen-rich environment at any time of human life. The hypothesis therefore has a questionable biological basis and little direct evidence has been adduced to support it. Nevertheless, it has received extensive public attention, which unfortunately can appear to transmute science speculation into public fact. A follow-up of a controlled study of men born to women who received high doses of diethylstilbestrol or placebo during pregnancy shows that *in utero* exposure to this estrogen had no effect on their fertility. Only inconsistent effects on their reproductive organs were observed, amongst which was a small increase in genital malformations (Wilcox et al. 1995).

A comprehensive review of epidemiological studies concluded there was no evidence that prenatal estrogen exposure had deleterious effects on the human male reproductive tract (Storgaard et al. 2006).

Since diethylstilbestrol is a very potent estrogen, the low incidence of adverse effects casts doubt on the ability of non-steroidal estrogens, anti-estrogens or anti-androgenic chemicals, that are orders of magnitude less potent than estradiol, to have any effect on the male fetus (Golden et al. 1998).

Nonetheless, it has been shown that high doses of diethylstilbestrol administered neonatally to **rats** can affect subsequent Sertoli cell function in the adult (Sharpe et al. 1998). It is not yet known whether this is a species-specific effect.

Enormous scientific research efforts are underway in Europe, America and Asia designed to test the

hypothesis that xenoestrogens can have adverse effects on the male reproductive system. Exposure of adult male rats to 4-*tert*-octylphenol disturbed gonadotropin levels and spermatogenesis, though food consumption and bodyweight were also affected (Boockfor and Blake 1997). *p*-Nonylphenol was also associated with disturbed spermatogenesis but only at doses close to the LD₅₀ and above (de Jager et al. 1999), which questions the relevance of the findings to endocrine disruption. Effects at lower doses and with more environmentally-relevant routes of exposure are much more difficult to demonstrate experimentally, mainly because of problems with reproducibility. Thus: the finding that rats exposed to butyl benzyl phthalate during gestation through to weaning had impaired sperm production (Sharpe et al. 1995) could not be repeated (Ashby et al. 1997); an initial report of estrogenic synergism between various xenoestrogens (Arnold et al. 1996) was subsequently retracted because the data could not be replicated by others or by the authors (McLachlan 1997); increases in adult mouse prostate weight following bisphenol A exposure *in utero* (Nagel et al. 1997) could not be replicated in an experiment that was designed to mimic the original study as closely as possible (Ashby et al. 1999). The reasons for these contradictory findings are not clear but they may relate to the very small magnitude of the changes being observed (Ashby and Odum 1998) and to the high degree of species- individual- and tissue-specificity of endocrine-disruptor effects (Walker et al. 1999). These and other refutations (Wilcox et al. 1995; Storgaard et al. 2006) of the estrogen hypothesis have led to migration of the underlying hypothesis to wider claims of a “**testicular dysgenesis syndrome**” (see Sect. 19.3.11.1) without any specific etiology, as well as narrowing of susceptibility to a brief developmental programming window (Welsh et al. 2008).

Added impetus was given to the area of xenoestrogen effects on the male reproductive system by the discovery of estrogen receptors in the male reproductive tract and that estrogen is necessary for its development (Eddy et al. 1996; Hess et al. 1997; see also Chaps. 2 and 3). This suggested that these receptors could be targets for xenoestrogens. A series of experiments has shown that xenoestrogens administered neonatally have effects via estrogen receptors in the male reproductive tract of the rat (Fisher et al. 1999). The magnitude of these effects is proportional to the estrogenicity of each compound, which reinforces the conclusion

that the rat model suggests ambient environmental exposures are unlikely to have any impact on the male human reproductive system.

More recently, it has been proposed that the balance between estrogenic and androgenic factors in the uterine environment may be more important than estrogenicity alone. Greater emphasis is now being placed on investigations of compounds that antagonize the action of androgens. An example of this is the plasticizer **di(n-butyl) phthalate**, which does not interact with either the estrogen or the androgen receptors but does interfere with androgen-dependent development of the male reproductive system in rats (Mylchreest et al. 1999).

19.3.7 Smoking

Inhaled cigarette smoke contains many hazardous compounds, some of which (such as acrolein) are reproductive toxins. Furthermore, it can induce oxidative damage to macromolecules that is detectable in the testis.

Most of the few scientifically valid studies have demonstrated some reduction in sperm output and motility (e.g., Richthoff et al. 2008) or genetic damage (see below), which may be due to biological effects of smoking but could even result from **psychological self-selection**, i.e.: smokers are likely to be the type of people more heavily exposed to other hazards that could cause the adverse effects seen (Vogt et al. 1984). Smoking in men trying to conceive is not associated with decreased fecundity as measured by time-to-pregnancy (Bolumar et al. 1996) and is more likely to be important if there is a danger that fertility could be compromised by other factors, as has been indicated, for example, by investigations of sub-fertility among welders (Hjollund et al. 1998b) and workers exposed to lead in a battery factory (Hsu et al. 2008). In the latter study, blood lead-levels correlated both with smoking as well as with sperm chromatin damage.

Of growing concern is the recognition that smoking can cause DNA damage in sperm detected in human and animal studies as chromatin disturbances (Potts et al. 1999), sperm DNA adducts (Fraga et al. 1996), DNA adducts in the embryo (Zenzes et al. 1999), disomy (e.g., Robbins et al. 2005) and minisatellite mutations (Yauk et al. 2007). The ultimate fate of this damage, whether it is repaired in the embryo or fixed as

mutations, is not known but clearly there is a potential risk that such genetic damage could not only compromise the sperm function but also cause transmissible abnormalities in the offspring. Substantial studies have shown a positive association between paternal smoking and the incidence of cancer, especially leukemia among their offspring (Ji et al. 1997; Sorahan et al. 1997a, b). This has since been questioned by a further study (Brondum et al. 1999) but since these contradictory data were obtained by telephone interviews with bereaved parents and self-reported cigarette consumption, they may not be reliable.

Genetic damage in sperm is widely considered to be a contributory factor to failure of assisted conception techniques. Therefore, it is perhaps unsurprising that smoking has been found to affect adversely, success rates achieved with IVF and ICSI (e.g., Zitzmann et al. 2003). However, parental smoking may also be able to induce effects by other mechanisms because decreases in semen quality and testis size (Jensen et al. 2004) as well as increases in cryptorchidism (Jensen et al. 2007) have been reported in men whose mothers smoked during pregnancy. Such effects could be particularly important in men susceptible to other pathologies or experiencing additional toxic exposures.

19.3.8 Diet, Alcohol and Social Drugs

Many specific dietary factors have been found to have a direct influence on the male reproductive system in domestic and experimental animals (Brinkworth et al. 1992), possibly partly as a result of an inhibition of LH secretion (Dong et al. 1994). However, there is little convincing evidence that similar effects can be induced in humans. This probably reflects a resilience of human spermatogenesis to fluctuations in dietary intake except in extreme cases (Keys 1950; Baker 1998). Furthermore, in such cases numerous other physiological disorders are likely also to be present, making it difficult to ascribe the impairment of spermatogenesis solely to the dietary restriction. Of probably greater, but as yet undefined importance is possible **synergism between dietary deficiencies and environmental reproductive toxins**.

As with many life-style exposures, the influence of recreational drug use on human male reproductive function remains unclear and difficult to study in a scientifically convincing fashion. Most studies are retrospective

and therefore lack stringent controls for bias among confounding variables.

Excessive alcohol intake is associated with direct testicular toxicity (Pajarinen and Karhunen 1994) in addition to indirect effects due to chronic liver disease and undernutrition among alcoholics. Whether there is a testicular equivalent of the so-called 'French Paradox', whereby moderate alcohol consumption has a beneficial effect on the incidence of coronary heart disease, is not known. One report indicates a possible association between alcohol intake and XY-bearing sperm (Robbins et al. 2005).

Abusers of **marijuana, cocaine** and **opiates** are harder to study due to the illicit nature of their drug usage, and the available studies often do not adequately control for socio-economic status, nutritional intake and concomitant drug use (e.g., alcohol, smoking). Nevertheless, these agents appear to have only minimal effects on spermatogenesis even though opiates including heroin, morphine and methadone all markedly suppress LH and testosterone secretion due to their central activation of **opiate mechanisms**, causing **inhibition of hypothalamic GnRH secretion** (Cicero et al. 1974).

19.3.9 Electromagnetic Radiation

Magnetic fields are generated by domestic as well as industrial electrical equipment and vary in frequency, intensity and waveform. The frequency of electricity transmission is 50 Hz in Europe and 60 Hz in North America, both of which fall into the Extremely Low Frequency (ELF) range. The intensity of the magnetic component of these fields is measured in Teslas (T) and is a function of distance from, and strength of, the electric current. It is known that high intensity, low-frequency magnetic fields (>10 mT at 50–60 Hz) can be damaging but normal environmental exposure to ELFs does not usually exceed 0.3 mT. Of particular concern, however, are portable (mobile) telephones, which can generate magnetic fields of moderate intensity but high frequency in the GHz range. Also of interest is the interaction of electromagnetic radiation exposures with other risk factors such as welding (Skotte and Hjollund 1997). Given the uncertainty remaining over proving a negative, bouts of public concern about ELFs, readily fomented in the media, are likely to continue periodically.

Work to assess the risk to humans of magnetic fields has largely focused on carcinogenicity but reproductive effects are also well studied. Principally, however, the emphasis has been on risks during pregnancy, which are very minor in the rat (Jensh 1997) and there are very few papers relating to effects on the male. Many of those studies that have been undertaken are reviewed in Lundsberg et al. (1995). The consensus of opinion is that **ELF magnetic fields have no effect on spermatogenesis** in rodents or on the offspring sired from treated males. Furthermore, a limited study of time-to-pregnancy failed to reveal convincing evidence of an effect of ELF fields (Hjollund et al. 1999).

High frequency, moderate intensity fields of the type generated by mobile telephones have been found to *affect* the proportions of **spermatogenic cells in hamsters** (Niehaus et al. 1997) but the majority of studies in animal models show no dramatic effects of these fields on sperm development or function (e.g., Dasdag et al. 2003, 2008; Aitken et al. 2005; Ribeiro et al. 2007), although occasional effects, such as genetic damage in the mitochondrial genome and at the β -globin locus (Aitken et al. 2005) have been reported. Interestingly, several studies in humans have shown positive effects on semen quality (Wdowiak et al. 2007; Agarwal et al. 2008). Since this does not seem to occur under experimental conditions, in which exposures are not only standardised but likely to exceed the levels seen in most men who have been studied, there must either be a profound species difference in susceptibility between humans and rodents or the electromagnetic radiation correlates with some other factor capable of affecting sperm. Given that high mobile phone usage in men is likely to be associated with particular lifestyle factors such as a sedentary, possibly high-stress, occupation, these are perhaps more likely to be responsible for the observed effects than the radiation. The possibility that these high frequency fields could be associated with an increase in testicular cancer (amongst other disorders) has been discussed (Goldsmith 1997).

19.3.10 Heat

Heat is among the best established testis-damaging agents (Setchell 1998). Brief periods of elevated temperature in experimental animals can markedly **reduce sperm production and fertility** and adverse effects

have also been noted in men occupationally or experimentally exposed to heat (reviewed in: Kandeel and Swerdloff 1988; Bonde and Giwercman 1995). Mild heating can also lead to **embryonic death** among the offspring of heat-treated rams (Mieusset et al. 1992) and cause transient growth retardation of fetuses of male mice in which the testes have been heated (Setchell et al. 1998). This type of exposure is of current interest as modern lifestyles increasingly involve activities such as long-distance driving (Thonneau et al. 1998) and laptop usage (Sheynkin et al. 2005) that have the potential to raise scrotal, and hence testicular, temperatures.

Impairment of sperm output in humans has also been demonstrated in the course of work designed to explore the possibility of using local scrotal heating as a form of contraception in men (Mieusset and Bujan 1994). However, the utility of this method has been questioned by a year-long study in which scrotal temperature was elevated by about 1°C without any apparent effect on sperm production or function (Wang et al. 1997). Occupational exposure to heat such as in the ceramics industry (Figa-Talamanca et al. 1992) and among welders (Hjollund et al. 1998a, b) has also been suggested to affect the male reproductive system adversely. Varicoceles can be associated with suboptimal spermatogenesis and elevated day-night scrotal temperatures (Lerchl et al. 1993). It remains unclear whether there is a causal relationship between scrotal temperature and reduced semen parameters (Jung and Schuppe 2007). An effect on men who drive for more than 3 h per day has also been claimed (Thonneau et al. 1998) and it has been suggested that testicular heating, mainly as a result of the amount of time spent seated, will affect sperm production in an increasing number of men in the future (Sharpe 2000). However, it is not clear whether, if confirmed, such effects are related to heat, posture or other causes.

19.3.11 Unknown Factors

The possibility that sperm output has been changing systematically in the **general male population** has long attracted interest. In the 1970s a debate about **falling sperm counts** based on data from thousands of infertile men studied at single laboratories was resolved in the negative (Nelson and Bunge 1974; MacLeod and Wang 1979). The studies were then criticized,

without public furor, for reliance on populations of infertile men as representative of the general male population when the operation of various distorting factors such as selection and referral bias would have overshadowed any real effects in question (Sloan 1982).

The issue was re-ignited by a **meta-analysis** of mean sperm counts from 61 studies from various centers over the preceding 50 years (Carlsen et al. 1992; Swan et al. 2000). This meta-analysis of semen samples from non-infertile men produced the startling finding of an apparent 50% decrease in the mean sperm counts over that time, a claim that has generated enormous public attention and scientific scrutiny. In order to explain the data, it was proposed that increased prenatal exposure to environmental estrogens (see Sect. 19.3.6) may have resulted in a global decline in sperm counts (Sharpe and Skakkebaek 1993), a claim now refuted (Wilcox et al. 1995; Storgaard et al. 2006; Fisch 2008). However, this suggestion was supported by a **retrospective study** of the sperm counts of sperm donors at a single Parisian center over a 20-year period also showing a similar decrease (Auger et al. 1995).

Subsequent reports from Scotland (Irvine et al. 1996) and Belgium (Van Waeleghem et al. 1996) also supported the claim but studies from Finland (Vierula et al. 1996), the USA (Fisch et al. 1996), Toulouse in France (Bujan et al. 1996) and Australia (Handelsman 1997), failed to find supporting evidence. In consequence it was proposed that there is **geographical variation** in sperm count between different populations (Fisch and Goluboff 1996). Interestingly, a study of sperm counts among **domesticated animals** also showed no evidence of a secular decline in sperm counts over more than the last 60 years (Setchell 1997). Furthermore, human infertility overall is declining (Akre et al. 1999), making any claimed increase in male infertility unlikely.

No **prospective** and little conclusive **experimental evidence** yet supports these provocative suggestions, which are highly controversial (e.g., Lerchl and Nieschlag 1996). The original meta-analysis has been largely refuted on methodological grounds including failure to adjust adequately for the skewed distribution of sperm concentrations, reliance on sub-optimal linear models and inappropriate application of meta-analysis (Brake and Krause 1992; Olsen et al. 1995). Meta-analysis, a controversial statistical technique, treats summary data from published studies as equally valid data points in a retrospective observational study. It was originally designed to aggregate quantitatively the

overall effect sizes from many small controlled studies by using the same method to measure the same variable in equally well-defined populations. Where these criteria are not met, meta-analysis may be seriously flawed by biases that are impossible to predict or correct (Egger et al. 1998). By these standards the Carlsen meta-analysis is clearly invalid. The component studies had little in common apart from control groups of non-infertile men such as sperm donors, and men who were recently fertile, once fertile, or of undefined fertility. The comparability of selection/rejection criteria between studies could not be evaluated. Furthermore, during the period from which the studies were drawn, the accepted standards for what constituted the minimum “normal” or “fertile” sperm concentration had fallen progressively from 60 to 40 then 20×10^6 sperm/ml. This progressive fall alone could have produced the apparent secular trend in sperm concentrations by more liberal selection/rejection criteria for the control groups (Brake and Krause 1992). In addition, the **decrease in semen volume** in the Carlsen study suggests that the mean **sexual abstinence intervals** of participants – the most important known determinant of sperm output – also decreased during the period under observation. Alleged geographical differences in sperm counts (see above), if real and not representing simple non-reproducibility, may also contribute a confounding factor in the meta-analysis (Fisch and Goluboff 1996; Paulsen et al. 1996). Discrepancies between studies conducted in different cities can be considered genuine geographical differences only if the participants in each study are representative of that city. Since participation bias makes that highly unlikely in any single center due to self-selection of volunteers (Handelsman 1997; Muller et al. 2004), such discrepancies between studies can only lead to discussion of differences in recruitment between studies and not to valid inferences based on geography. Finally, more appropriate statistical models of the same data actually indicate an increase in sperm counts over the last 20 years (Brake and Krause 1992; Olsen et al. 1995). For these reasons, no sound conclusions can be drawn from the Carlsen meta-analysis; indeed it constitutes an excellent example of the misuse of meta-analysis. The Parisian study (Auger et al. 1995) also does not overcome the defects of its retrospective uncontrolled design. The *self-selected* source population of married, fertile men volunteering to become sperm donors is not representative of the general male population and this selection bias is likely to have changed during the study

period. The results of Auger et al. (1995) are therefore more likely to reflect changes in selection of the population rather than changes in the underlying population.

19.3.11.1 Testicular Dysgenesis Syndrome

Despite the controversial nature of the evidence surrounding alleged decreased sperm counts and morphological abnormalities of the male reproductive tract, a parallel, secular increase in the incidence of testicular cancer is more convincing (see Chap. 13). Evidence from many countries with comprehensive, well-run national cancer registries to allow study of temporal trends in testis cancer incidence, show a gradual increase over the last few decades similar to temporal trends in other cancers such as lymphomas. Differences in the rates between countries has prompted a shift in the **estrogen pollution hypothesis**, which groups all three types of disorder together as a so-called “**testicular dysgenesis syndrome**” (Skakkebaek et al. 2001; Sharpe and Skakkebaek 2008). It is suggested that hypospadias and cryptorchidism together with lowered sperm counts and testicular cancer all have their common origins from exposure to an unknown environmental toxin, which also leads to the formation of pre-malignant **carcinoma in situ (CIS)** cells in the fetal testis. Although there is evidence for the derivation of testicular cancers from CIS cells, it is currently unclear whether there is any commonality with reduced sperm production or reproductive tract abnormalities. Hypospadias and cryptorchidism are relatively minor birth malformations that are not usually recorded accurately in infancy and their apparent prevalence depends on the reliability and consistency of infant examinations. The lack of birth defect registers covering these reproductive abnormalities, and comparable in reliability with cancer registers, means there are no reliable estimates of temporal trends in the incidence of hypospadias or cryptorchidism over past decades.

Hence, claimed increases in these birth defects over recent decades are as unsubstantiated as alleged falls in sperm counts. Whether the term “**testicular dysgenesis syndrome**” has any meaning beyond the early life origins of CIS as a premalignant form of testis cancer remains to be established.

19.4 Design and Interpretation of Toxicological Studies

19.4.1 Design of Non-human Studies

The ultimate value of non-human studies is judged by their contribution to the understanding of human toxicology. This rests on the balance between the strengths of experimental toxicology – such as the ability to make carefully controlled, reproducible observations on any relevant physiological variables, and its deficiencies – including the uncertain validity of extrapolation from a test system to humans. **Randomization** is essential to ensure **balance** between **known** as well as **unknown covariables in the control and treatment groups**. Precision, reproducibility and replication are all additional key features of the optimal experimental design expected in such studies. **Interpretation must consider** carefully the possibility of **species differences** in relevant factors such as **route of administration, distribution, metabolism, excretion and mode of action** of the chemical under consideration.

19.4.2 Design of Human Studies

Human toxicological studies usually yield retrospective epidemiological or clinical data relating to uncontrolled exposures so that controlling for covariables may be difficult or impossible. A major **source of bias** in human studies, particularly those requiring collection of semen samples, is the **participation rate**. Although the social acceptability of providing semen samples may have increased in recent years, most men are unwilling to participate unless they are concurrently concerned about their fertility so the participation rates remain very low. This inevitably means that **participants** in such studies **are self-selected** and introduce a systematic bias that is difficult to overcome and cannot be adjusted for. As sperm counts are only a surrogate variable for male fertility, other surrogate measures of male fertility that avoid the need for semen analysis (e.g., time-to-pregnancy, testis size, hormone levels) may prove more useful in practice for population studies. Typical end-points measured in human studies are derived from a medical history, a physical examination and samples of blood and semen. These will yield information on testicular

volume, semen variables (sperm count, motility, morphology, seminal volume, other special tests of sperm function) and blood FSH concentration. Serial observations are particularly useful in adjusting for the between-subject variability in many of these parameters. Normal-range values can provide some indication of whether an individual may have been intoxicated, especially if serial observations are not available.

19.4.3 Regulatory Testing for Reproductive Toxicity

19.4.3.1 Regulatory Reproductive Research Strategies

In regulatory terms, chemicals are regarded as **food chemicals, pharmaceuticals** or **compounds for environmental use**. The first category contains food additives and packaging components that come into contact with foodstuffs. The second covers drugs and compounds used in human and veterinary medicine, while the third includes any chemical whose use causes it to be released into the environment. This enormous range of chemicals and uses handled by independent regulatory agencies has further diversified testing requirements according to the proposed use of the compound and the country in which the application is made. The need to unify the safety-testing demands for chemical entities intended for international usage has resulted in agreement on **common strategies for drug toxicity testing** between the European Community, the United States and Japan. Through the mutual establishment of the International Committee on Harmonization of Technical Requirements for Registration of Pharmaceuticals for Human Use, recommendations for assessment of reproductive toxicity have now been presented and adopted by the regulatory authorities in each domain. Based on the '3 segment' design first introduced by the US Food and Drug Administration (FDA) in 1966 (see Sullivan 1988), they involve a **fertility study in male and female rats, a pre- and post-natal study in pregnant female rats and a teratology study** in the rat and one other mammalian species. Only the first can identify direct effects on male reproduction, although any preliminary studies performed to set dose levels should obtain data on testicular histology, sperm motility and viability. If good data are available from such studies, seminology data are not

required from the fertility study. Remarkably, these requirements represent the first time that specific testing of male reproductive effects of new chemical entities has been requested.

Food chemical and environmental chemical regulation is overseen by the FDA and the Environmental Protection Agency respectively, in the USA, by the Organization for Economic Cooperation and Development in Europe and by the Japanese Ministry for Agriculture, Fisheries and Food in Japan. All these agencies require essentially the same testing for these chemicals, which involves

- **Teratology study in two species**
- **One-generation toxicity study and**
- **Two-generation toxicity study**

Current discussions are exploring the possibility of replacing the latter two with an extended one-generation toxicity study. This would reduce the numbers of animals used but is not yet part of the regulatory framework. **Testicular pathology** and **seminology data** are required now from all generations.

Directive 93/21/EEC of the European Union (in addition to the Council Directive on Classification, Packaging and Labelling of Dangerous Substances, 67/548/EEC) divides reproductive toxins into three categories. These indicate a risk (labelled "R60" or "R61") or possible risk (R62, R63) to fertility or to the unborn child respectively, or a risk to breast-fed babies (R64). This labelling is designed to reflect the existing state of scientific knowledge regarding the reproductive safety of any compound to which humans may be exposed in Europe.

19.4.3.2 Experimental Methods in Male Reproductive Research

Regulatory male reproductive toxicology is increasingly adopting techniques used in basic research (discuss in Chapin and Heindel 1993). In addition to the basic techniques already in wide use, these include

- Detailed **histological evaluation of the germinal epithelium**
- Recognizing the characteristic associations and stages (Hess 1990)
- **Flow cytometry**, which quantitates both total sperm numbers as well as the proportions of haploid, diploid and tetraploid cells in the testis

- **Vital dye staining** to determine the numbers of cells with intact membranes as an estimate of viability
- **Computerized techniques for objective assessment of sperm motion** (Seed et al. 1996)
- **Transgenic animals**
- Novel **in vitro** assays and
- **Toxicogenomics**

A variety of *in vivo* genotoxicity assays have also been developed to detect potentially transmissible genetic mutations in germ cell DNA. These include tests for **dominant lethal mutations, specific-locus mutations, dominant skeletal mutations, heritable translocations and aneuploidy**. Other research techniques such as stereological quantitation of germ cell numbers and genetic evaluation of germinal epithelium are yet to be widely adopted. In part, this is due to the expense and time required to undertake animal studies. In the light of the increasing need for toxicity testing (of which the REACH legislation is one example, see the Introduction to this chapter), increasing emphasis is being placed on the development of *in vitro* tests (Gura 2008).

Critically, however, no single test provides an overall prediction of toxicity to the male reproductive system.

19.4.4 Criteria for the Evaluation of Human Toxicology Data

Regulatory decisions concerning human safety involve difficult evaluations of human risk. This inevitably involves an amalgam of human data, which is usually retrospective, observational and uncontrolled, with designed and controlled laboratory experimentation on animals, cells and *in vitro* systems. The former lacks scientific rigor in that confounding variables may remain unidentified and unaccounted for, while the latter lacks reliable extrapolation to humans. With many new chemical entities, relevant human data may be totally lacking, making complete reliance on laboratory evaluation necessary. In other situations human sentinel populations such as those receiving medicinal drugs or those occupationally exposed to non-medicinal chemicals (e.g., manufacturers, applicators) may provide crucial, albeit limited, information.

Controlled experimentation of chemical effects in healthy humans is severely limited, largely being

restricted to medically-used drugs with minimized toxicity. Otherwise, the best opportunity for scientifically valid studies of chemical effects on human reproduction is in occupational health where exposure to various specified chemicals can be measured and unexposed control groups can be studied concurrently. Interpretation of such studies is, however, fraught with difficulties due to **systematic biases** arising from **non-randomization, entry bias** (the reproductive analogy of the 'healthy worker effect') and **low and selective participation rates**, especially among control groups. The requirement for semen analysis is a major and almost insurmountable stumbling block for the validity of such human population studies (Handelsman 1997; Cohn et al. 2002; Muller et al. 2004). At present it remains highly characteristic of male employees to participate in studies requiring semen analyses only if they have prior concerns about their own fertility and/or toxic exposures. Participation rates in control groups in industrial settings is typically as low as 10–20%, leaving great scope for intractable biases. Other, more acceptable, surrogate measures for male fertility not requiring semen analysis (e.g., time-to-pregnancy, testis volume, reproductive hormones) may prove more applicable and useful.

19.5 Future Perspectives

19.5.1 Experimental Studies

19.5.1.1 Non-human Studies

The suggestion that intra-uterine exposure to hormonally active chemicals can affect future reproductive potential is a hypothesis that can only be tested in experimental animals. A variety of studies have reported that both potent and relatively weak xenoestrogens can affect the reproductive system in male rodents following pre-/neo-natal exposure just as a number have reported negative effects. Of critical importance for future work will be the reproducibility of effects that can be induced and whether the dose levels at which they occur are in any way comparable to likely human exposure. At the same time, it will be essential to establish the relevance to humans of the animal model used. This latter point is of great general significance because of the inevitable reliance on

cross-species comparisons in experimental toxicology. The wider search for better predictors of human reproductive toxicity is acquiring greater urgency as public attention is increasingly focused on real or alleged instances of adverse environmental influences on reproduction. In this respect, studies using chronic, low-dose regimens that mimic actual human exposures more closely than conventional acute dosing need to be developed and validated further, together with more usable surrogate measures of male fertility.

Recent progress towards the understanding of how heritable mutations can be induced in the male germline means that progress can now be made towards establishing with greater certainty whether specific agents can have such effects. When likely mechanisms have been demonstrated experimentally, appropriate testing strategies can be developed for the evaluation of suspect or novel chemicals.

19.5.1.2 Human Studies

An increasing awareness that many chemicals can adversely affect male reproductive function is an important starting point for future development in human reproductive toxicology. In future, more **systematic collections of reproductive information** from **exposed and unexposed workers** as well as more public availability of **pre-registration testing of new drugs** would greatly facilitate early and sensitive detection of previously unrecognized hazards to male reproduction. This might contribute to reducing the high proportion of infertile men in whom the diagnosis of male infertility remains unexplained but environmental causes are suspected. The last two decades, dominated by an excessive focus on hypothetical global disorders in male reproductive health instead of identifying specific reproductive toxins, has left progress on identifying environmental causes of male infertility far behind the tremendous advances in understanding the genetic basis of spermatogenesis and its defects causing male infertility.

Analysis of semen samples for both clinical and research purposes is standardized by universal adoption of the WHO *Laboratory Handbook for the Examination and Processing of Human Semen* (5th edition; 2009). Inter- and intra-laboratory variability in semen evaluation is increasingly being reduced by **quality control programs for semen analysis**. The establishment of **normal ranges**, however, remains a

difficult task. Data collected from any population, whether on numbers of children or sperm counts, may be difficult to interpret unless an appropriate control group can be identified.

The collection of sperm data from ‘at risk’ populations is fraught with practical difficulties including low and biased participation rates according to perceived risk, as well as deterministic interpretations of sporadic clusters of cases. The limited acceptability of semen collection makes it desirable that different monitoring systems less reliant on sexual function should be available. An effective alternative is the **Time-To-Pregnancy (TTP) questionnaire-based data collection system** developed by Joffe et al. (1993), which supersedes the previous **standardized fertility ratio** described by Levine et al. (1980). The TTP methodology allows quantitative estimation of fertility performance of groups of men as a means of monitoring fertility in occupational or other settings. Thus, the routine collection of reproductive data in the workplace, whether from questionnaire or semen samples, would greatly improve the possibility for early warning of potential fertility problems.

19.5.2 Clinical Implications

19.5.2.1 Historical Perspective

It is a curious paradox of modern life that at a time when life expectancy is longer than ever in human history, public clamor about the damaging effects of environmental chemicals and radiation on human health is ever increasing. Ironically, these preoccupations originate within affluent Western economies rather than among developing countries where life expectancy has yet to catch up with Western standards; such concerns were unheard of in post-industrial European countries while life expectancy was much shorter than it is now. Together with the flourishing fad diet and artificial exercise industries, these constitute the remarkably popular modern hobby of health consciousness in wealthy countries. This narcissistic luxury reflects the modern version of the “conspicuous consumption” that Thorstein Veblen (1857–1929) identified as emblematic of the growing affluence of the emergent mercantile middle class a century ago in the USA (“Theory of the Leisure Classes” 1899). Like other fashions, health

consciousness has only a casual relationship with rationality, consisting at its most extreme, of largely irrational phobias and passions superficially disguised by a layer of scientific patois and eagerly captured by endlessly inventive and avaricious marketers. Often ignited by crusading journalists or ecologists with a commercial interest in sensation, such histrionic ‘revelations’ are fuelled among the public by ignorance, superstition and fear of technological progress.

Coinciding with the rise of the health consciousness fashion during the prosperity of the latter half of the twentieth century, several public health crises, notably Thalidomide®-induced teratogenesis, created political pressure that propelled the inception of increasingly stringent regulations regarding medical, occupational, environmental, domestic and recreational exposures to chemicals, radiation and devices. Unfortunately, precipitate political action that outstrips genuine scientific knowledge often results in poor science policy as, in an unfortunate analogy to Gresham’s law of monetary flows, bad science drives out the good (Thomas Gresham, 1519–1579). One consequence of this has been the conducting of regulatory testing with little consideration of what actually constitutes a ‘safe’ compound. As proving a negative is impossible, defining safety is an unachievable goal unless carefully qualified and delineated. If not, like the drunk’s use of a lamppost, science becomes relegated to being used for support rather than illumination. Another problem is that the long-term predictions of newer tests developed from fundamental research cannot be based on empirical data but rest largely on plausible supposition.

At present, licensing authorities require a negative data set from a limited battery of assays for registration of a new compound for human use. This necessarily ignores the possibility that a **potentially hazardous compound may present no risk at likely human exposure levels** and that certain **ostensibly benign compounds** could have **unpredicted effects**, for example, by acting in concert with other chemicals. Currently, there is a need for consensus on evidence-based and logical approaches to ascertaining the appropriate level of concern over potential reproductive toxins.

19.5.2.2 Clinical Practice

In routine clinical practice **the possibility of environmental and toxic factors causing infertility and**

other andrological disorders should always be considered carefully. The accurate identification of such influences is largely dependent upon an **index of suspicion** together with confirmation by a careful **history of occupational**, domestic, recreational and other potential *environmental exposures*. Laboratory confirmation of specific forms of intoxication may occasionally be helpful but is rarely possible. Although measurement of suspected toxins in body fluids (e.g., blood, seminal plasma) may be possible, its significance needs to be established by properly controlled clinical studies. Without these, interpretation can be impossible. A careful and thorough occupational history remains an essential part of proper evaluation of men for infertility or other andrological disorders. Specific attention should be paid to the type of work routinely performed, and compliance with and results of health monitoring, if applicable. In addition, domestic exposures from gardening (pesticide exposure), holidays (visiting farms or zoos) and hobbies should be considered. In addition to its value for counselling patients, such categorization of life-styles of patients may become useful for retrospective studies. In the case of patients who believe they have been intoxicated by various environmental agents, a full evaluation of reproductive function is usually necessary to dispel any concerns or identify the extent of damage.

References

- Agarwal A, Deepinder F, Sharma RK, Ranga G, Li J (2008) Effect of cell phone usage on semen analysis in men attending infertility clinic: an observational study. *Fertil Steril* 89:124–128
- Aitken RJ, Bennetts LE, Sawyer D, Wiklendt AM, King BV (2005) Impact of radio frequency electromagnetic radiation on DNA integrity in the male germline. *Int J Androl* 28:171–179
- Akre O, Cnattingius S, Bergstrom R, Kvist U (1999) Human fertility does not decline: evidence from Sweden. *Fertil Steril* 71:1066–1069
- Alexander BH, Checkoway H, van Netten C, Muller CH, Ewers TG, Kaufman JD, Mueller BA, Vaughan TL, Faustman EM (1996) Semen quality of men employed at a lead smelter. *Occup Environ Med* 53:411–416
- Anderson D, Brinkworth MH, Jenkinson PC, Clode SA, Creasy DM, Gangolli SD (1987) Effect of ethylene glycol monomethyl ether on spermatogenesis, dominant lethality, and F1 abnormalities in the rat and the mouse after treatment of F0 males. *Teratog Carcinog Mutagen* 7:141–158

- Anderson D, Edwards AJ, Brinkworth MH, Hughes JA (1996) Male-mediated F1 effects in mice exposed to 1,3-butadiene. *Toxicology* 113:120–127
- Anway MD, Skinner MK (2008) Epigenetic programming of the germ line: effects of endocrine disruptors on the development of transgenerational disease. *Reprod Biomed Online* 16:23–25
- Anway MD, Cupp AS, Uzumcu M, Skinner MK (2005) Epigenetic transgenerational actions of endocrine disruptors and male fertility. *Science* 308(5727):1466–1469
- Armour JAL, Brinkworth MH, Kamischke A (1999) A direct analysis by small-pool PCR of MS205 minisatellite mutation rates in sperm after mutagenic therapies. *Mutat Res* 15:73–80
- Arnold SF, Klotz DM, Collins BM, Vonier PM, Guillette LJ Jr., McLachlan JA (1996) Synergistic activation of estrogen receptor with combinations of environmental chemicals. *Science* 272:1489–1492
- Ashby J, Odum J (1998) The importance of protocol design and data reporting to research on endocrine disruption. *Environ Health Perspect* 106:A315–316; discussion A316–317
- Ashby J, Tinwell H, Lefevre PA, Odum J, Paton D, Millward SW, Tittensor S, Brooks AN (1997) Normal sexual development of rats exposed to butyl benzyl phthalate from conception to weaning. *Regul Toxicol Pharmacol* 26:102–118
- Ashby J, Tinwell H, Haseman J (1999) Lack of effects for low dose levels of bisphenol A (BPA) and diethylstilbestrol (DES) on the prostate gland of CF1 mice exposed *in utero*. *Regul Toxicol Pharmacol* 30:156–166
- Auger J, Kunstmann JM, Czyglik F, Jouannet P (1995) Decline in semen quality among fertile men in Paris during the past 20 years. *N Engl J Med* 332:281–285
- Baarends WM, van der Laan R, Grootegoed JA (2001) DNA repair mechanisms and gametogenesis. *Reproduction* 121:31–39
- Bagchi G, Waxman DJ (2008) Toxicity of ethylene glycol monomethyl ether: impact on testicular gene expression. *Int J Androl* 31:269–274
- Baker HW (1998) Reproductive effects of nontesticular illness. *Endocrinol Metab Clin North Am* 27:831–850
- Barone F, Aguanno S, D'Agostino A (2005) Modulation of MAA-induced apoptosis in male germ cells: role of Sertoli cell P/Q-type calcium channels. *Reprod Biol Endocrinol* 19:13
- Bartlett JM, Kerr JB, Sharpe RM (1986) The effect of selective destruction and regeneration of rat Leydig cells on the intratesticular distribution of testosterone and morphology of the seminiferous epithelium. *J Androl* 7:240–253
- Bartoov B, Zabludovsky N, Eltes F, Smirnov VV, Grischenko VI, Fischbein A (1997) Semen quality of workers exposed to ionizing radiation in decontamination work after the Chernobyl nuclear reactor accident. *Int J Occup Environ Health* 3:198–203
- Berndtson WE, Foote RH (1997) Disruption of spermatogenesis in rabbits consuming ethylene glycol monomethyl ether. *Reprod Toxicol* 11:29–36
- Boekelheide K (1993) Sertoli cell toxicants. In: Russell LD, Griswold MD (eds) *The Sertoli cell*. Cache River Press, Clearwater, FL, pp 551–575
- Bolumar F, Olsen J, Boldsen J (1996) Smoking reduces fecundity: a European multicenter study on infertility and subfecundity. *The European Study Group on Infertility and Subfecundity. Am J Epidemiol* 143:578–587
- Bonde JP, Giwercman A (1995) Occupational hazards to male fecundity. *Reprod Med Rev* 4:59–73
- Boockfor FR, Blake CA (1997) Chronic administration of 4-tert-octylphenol to adult male rats causes shrinkage of the testes and male accessory sex organs, disrupts spermatogenesis, and increases the incidence of sperm deformities. *Biol Reprod* 57:267–277
- Brake A, Krause W (1992) Decreasing quality of semen. *Br Med J* 305:1498
- Brandriff BF, Meistrich ML, Gordon LA, Carrano AV, Liang JC (1994) Chromosomal damage in sperm of patients surviving Hodgkin's disease following MOPP (nitrogen mustard, vincristine, procarbazine, and prednisone) therapy with and without radiotherapy. *Hum Genet* 93:295–299
- Brinkworth MH (2000) Paternal transmission of genetic damage: findings in animals and humans. *Int J Androl* 23:123–135
- Brinkworth MH, Nieschlag E (2000) Association of cyclophosphamide-induced male-mediated, foetal abnormalities with reduced paternal germ-cell apoptosis. *Mutat Res* 447:149–154
- Brinkworth MH, Anderson D, McLean AM (1992) Effects of dietary imbalances on spermatogenesis in CD-1 mice and CD rats. *Food Chem Toxicol* 30:29–35
- Brinkworth MH, Weinbauer GF, Schlatt S, Nieschlag E (1995) Identification of male germ cells undergoing apoptosis in adult rats. *J Reprod Fertil* 105:25–33
- Bronnum J, Shu XO, Steinbuch M, Severson RK, Potter JD, Robison LL (1999) Parental cigarette smoking and the risk of acute leukemia in children. *Cancer* 85:1380–1388
- Bujan L, Mansat A, Pontonnier F, Mieusset R (1996) Time series analysis of sperm concentration in fertile men in Toulouse, France between 1977 and 1992. *Br Med J* 312:471–472
- Byrne J (1999) Long-term genetic and reproductive effects of ionizing radiation and chemotherapeutic agents on cancer patients and their offspring. *Teratology* 59:210–215
- Byrne J, Rasmussen SA, Steinhorn SC, Connelly RR, Myers MH, Lynch CF, Flannery J, Austin DF, Holmes FF, Holmes GE, Strong LC, Mulvihill JJ (1998) Genetic disease in offspring of long-term survivors of childhood and adolescent cancer. *Am J Hum Genet* 62:45–52
- Carlsen E, Giwercman A, Keiding N, Skakkebaek NE (1992) Evidence for decreasing quality of semen during past 50 years. *Br Med J* 305:609–613
- Chapin RE, Heindel JJ (eds) (1993) *Male reproductive toxicology*. In: *Methods in toxicology*, volume 3, part A: male reproductive toxicology. Academic, San Diego, CA
- Chia SE, Ong CN, Lee ST, Tsakok FH (1992) Blood concentrations of lead, cadmium, mercury, zinc, and copper and human semen parameters. *Arch Androl* 29:177–183
- Choi SK, Yoon SR, Calabrese P, Arnheim N (2008) A germ-line-selective advantage rather than an increased mutation rate can explain some unexpectedly common human disease mutations. *Proc Natl Acad Sci USA* 105:10143–10148
- Cicero TJ, Meyer ER, Bell RD, Wiest WG (1974) Effects of morphine on the secondary sex organs and plasma testosterone levels of rats. *Res Commun Chem Pathol Pharmacol* 7:17–24
- Clegg ED, Cook JC, Chapin RE, Foster PM, Daston GP (1997) Leydig cell hyperplasia and adenoma formation: mechanisms and relevance to humans. *Reprod Toxicol* 11:107–121

- Cohn BA, Overstreet JW, Fogel RJ, Brazil CK, Baird DD, Cirillo PM (2002) Epidemiologic studies of human semen quality: considerations for study design. *Am J Epidemiol* 155:664–671
- Cooke PS, Zhao YD, Hansen LG (1996) Neonatal polychlorinated biphenyl treatment increases adult testis size and sperm production in the rat. *Toxicol Appl Pharmacol* 136:112–117
- Creasy DM, Flynn JC, Gray TJ, Butler WH (1985) A quantitative study of stage-specific spermatocyte damage following administration of ethylene glycol monomethyl ether in the rat. *Exp Mol Pathol* 43:321–336
- Crow JF (1997) The high spontaneous mutation rate: is it a health risk? *Proc Natl Acad Sci USA* 94:8380–8386
- Crow JF (2000) The origins, patterns and implications of human spontaneous mutation. *Nat Rev Genet* 1:40–47
- Dasdag S, Akdag MZ, Aksen F, Yilmaz F, Basham M, Dasdag AA, Celik MS (2003) Whole body exposure of rats to microwaves emitted from a cell phone does not affect testes. *Bioelectromagnetics* 24:182–183
- Dasdag S, Akdag MZ, Ulukaya E, Uzunlar AK, Yegin D (2008) Mobile phone exposure does not induce apoptosis on spermatogenesis in rats. *Arch Med Res* 39:40–44
- de Jager C, Bornman MS, van der Horst G (1999) The effect of p-nonylphenol, an environmental toxicant with oestrogenic properties, on fertility potential in adult male rats. *Andrologia* 31:99–106
- Doll R, Evans HJ, Darby SC (1994) Paternal exposure not to blame. *Nature* 367:678–680
- Dong Q, Rintala H, Handelsman DJ (1994) Androgen receptor function during undernutrition. *J Neuroendocrinol* 6:397–402
- Draper GJ, Little MP, Sorahan T, Kinlen LJ, Bunch KJ, Conquest AJ, Kendall GM, Kneale GW, Lancashire RJ, Muirhead CR, O'Connor CM, Vincent TJ (1997) Cancer in the offspring of radiation workers: a record linkage study. *Br Med J* 315:1181–1188
- Dubrova YE, Nesterov VN, Krouchinsky NG, Ostapenko VA, Neumann R, Neil DL, Jeffreys AJ (1996) Human minisatellite mutation rate after the Chernobyl accident. *Nature* 380:683–686
- Dubrova YE, Plumb M, Brown J, Jeffreys AJ (1998) Radiation-induced germline instability at minisatellite loci. *Int J Radiat Biol* 74:689–696
- Dubrova YE, Grant G, Chumak AA, Stezhka VA, Karakasian AN (2002) Elevated minisatellite mutation rate in the post-Chernobyl families from Ukraine. *Am J Hum Genet* 71:801–809
- Eaton M, Schenker M, Whorton MD, Samuels S, Perkins C, Overstreet J (1986) Seven-year follow-up of workers exposed to 1,2-dibromo-3-chloropropane. *J Occup Med* 28:1145–1150
- EC 1907/2006 <http://eur-lex.europa.eu/LexUriServ/LexUriServ.do?uri=CELEX:32006R1907:EN:NOT>
- Eddy EM, Washburn TF, Bunch DO, Goulding EH, Gladen BC, Lubahn DB, Korach KS (1996) Targeted disruption of the estrogen receptor gene in male mice causes alteration of spermatogenesis and infertility. *Endocrinology* 137:4796–4805
- Egger M, Schneider M, Davey Smith G (1998) Spurious precision? Meta-analysis of observational studies. *Br Med J* 316:140–144
- Elmore S (2007) Apoptosis: a review of programmed cell death. *Toxicol Pathol* 35:495–516
- Embree-Ku M, Venturini D, Boekelheide K (2002) Fas is involved in the p53-dependent apoptotic response to ionizing radiation in mouse testis. *Biol Reprod* 66:1456–1461
- Fan YJ, Wang Z, Sadamoto S, Ninomiya Y, Kotomura N, Kamiya K, Dohi K, Kominami R, Niwa O (1995) Dose-response of a radiation induction of a germline mutation at a hypervariable mouse minisatellite locus. *Int J Radiat Biol* 68:177–183
- Figa-Talamanca I, Dell'Orco V, Pupi A, Dondero F, Gandini L, Lenzi A, Lombardo F, Scavalli P, Mancini G (1992) Fertility and semen quality of workers exposed to high temperatures in the ceramics industry. *Reprod Toxicol* 6:517–523
- Finkelstein JS, McCully WF, MacLaughlin DT, Godine JE, Crowley WF Jr (1988) The mortician's mystery. Gynecomastia and reversible hypogonadotropic hypogonadism in an embalmer. *N Engl J Med* 318:961–965
- Fisch H (2008) Declining worldwide sperm counts: disproving a myth. *Urol Clin North Am* 35:137–146
- Fisch H, Goluboff ET (1996) Geographic variations in sperm counts: a potential cause of bias in studies of semen quality. *Fertil Steril* 65:1044–1046
- Fisch H, Goluboff ET, Olson JH, Feldshuh J, Broder SJ, Barad DH (1996) Semen analyses in 1,283 men from the United States over a 25-year period: no decline in quality. *Fertil Steril* 65:1009–1014
- Fisher JS, Turner KJ, Brown D, Sharpe RM (1999) Effect of neonatal exposure to estrogenic compounds on development of the excurrent ducts of the rat testis through puberty to adulthood. *Environ Health Perspect* 107:397–405
- Foster WG, Neal MS, Han MS, Dominguez MM (2008) Environmental contaminants and human infertility: hypothesis or cause for concern? *J Toxicol Environ Health B Crit Rev* 11:162–176
- Fraga CG, Motchnik PA, Wyrobek AJ, Rempel DM, Ames BN (1996) Smoking and low antioxidant levels increase oxidative damage to sperm DNA. *Mutat Res* 351:199–203
- Gardner MJ, Snee MP, Hall AJ, Powell CA, Downes S, Terrell JD (1990) Results of case-control study of leukaemia and lymphoma among young people near Sellafield nuclear plant in West Cumbria. *Br Med J* 300:423–429
- Giwerzman A, Bonde JP (1998) Declining male fertility and environmental factors. *Endocrinol Metab Clin North Am* 27:807–830, viii
- Golden RJ, Noller KL, Titus-Ernstoff L, Kaufman RH, Mittendorf R, Stillman R, Reese EA (1998) Environmental endocrine modulators and human health: an assessment of the biological evidence. *Crit Rev Toxicol* 28:109–227
- Goldsmith JR (1997) Epidemiologic evidence relevant to radar (microwave) effects. *Environ Health Perspect* 105(6):1579–1587
- Gura T (2008) Toxicity testing moves from the legislature to the petri dish – and back. *Cell* 134:557–559
- Hales BF, Robaire B (1993) Paternally mediated effects on progeny outcome. In: Whitcomb RW, Zirkin BR (eds) *Understanding male fertility: basic and clinical approaches*. Raven Press, New York, pp 307–320
- Handelsman DJ (1997) Sperm output of healthy men in Australia: magnitude of bias due to self-selected volunteers. *Hum Reprod* 12:2701–2705

- Harrington JM, Stein GF, Rivera RO, de Morales AV (1978) The occupational hazards of formulating oral contraceptives—a survey of plant employees. *Arch Environ Health* 33:12–15
- Hauser R, Sokol R (2008) Science linking environmental contaminant exposures with fertility and reproductive health impacts in the adult male. *Fertil Steril* 89(2):e59–65
- Hess RA (1990) Quantitative and qualitative characteristics of the stages and transitions in the cycle of the rat seminiferous epithelium: light microscopic observations of perfusion-fixed and plastic-embedded testes. *Biol Reprod* 43:525–542
- Hess RA, Bunick D, Lee KH, Bahr J, Taylor JA, Korach KS, Lubahn DB (1997) A role for oestrogens in the male reproductive system. *Nature* 390:509–512
- Hikim AP, Lue Y, Yamamoto CM, Vera Y, Rodriguez S, Yen PH, Soeng K, Wang C, Swerdloff RS (2003) Key apoptotic pathways for heat-induced programmed germ cell death in the testis. *Endocrinology* 144:3167–3175
- Hjollund NH, Bonde JP, Jensen TK, Ernst E, Henriksen TB, Kolstad HA, Giwercman A, Skakkebaek NE, Olsen J (1998a) Semen quality and sex hormones with reference to metal welding. *Reprod Toxicol* 12:91–95
- Hjollund NH, Bonde JP, Jensen TK, Henriksen TB, Kolstad HA, Ernst E, Giwercman A, Pritzl G, Skakkebaek NE, Olsen J (1998b) A follow-up study of male exposure to welding and time to pregnancy. *Reprod Toxicol* 12:29–37
- Hjollund NH, Skotte JH, Kolstad HA, Bonde JP (1999) Extremely low frequency magnetic fields and fertility: a follow up study of couples planning first pregnancies. The Danish First Pregnancy Planner Study Team. *Occup Environ Med* 56:253–255
- Hsu PC, Chang HY, Guo YL, Liu YC, Shih TS (2008) Effect of smoking on blood lead levels in workers and role of reactive oxygen species in lead-induced sperm chromatin DNA damage. *Fertil Steril* [Epub ahead of print 14 March]
- Irvine S, Cawood E, Richardson D, MacDonald E, Aitken J (1996) Evidence of deteriorating semen quality in the United Kingdom: birth cohort study in 577 men in Scotland over 11 years. *Br Med J* 312:467–471
- Jensen MS, Toft G, Thulstrup AM, Bonde JP, Olsen J (2007) Cryptorchidism according to maternal gestational smoking. *Epidemiology* 18:220–225
- Jensen TK, Jørgensen N, Punab M, Haugen TB, Suominen J, Zilaitiene B, Horte A, Andersen AG, Carlsen E, Magnus Ø, Matulevicius V, Nermoen I, Vierula M, Keiding N, Toppari J, Skakkebaek NE (2004) Association of in utero exposure to maternal smoking with reduced semen quality and testis size in adulthood: a cross-sectional study of 1,770 young men from the general population in five European countries. *Am J Epidemiol* 159:49–58
- Jensen TK, Bonde JP, Joffe M (2006) The influence of occupational exposure on male reproductive function. *Occup Med* 56:544–553
- Jensh RP (1997) Behavioral teratologic studies using microwave radiation: is there an increased risk from exposure to cellular phones and microwave ovens? *Reprod Toxicol* 11:601–611
- Ji BT, Shu XO, Linet MS, Zheng W, Wacholder S, Gao YT, Ying DM, Jin F (1997) Paternal cigarette smoking and the risk of childhood cancer among offspring of nonsmoking mothers. *J Natl Cancer Inst* 89:238–244
- Jockenhövel F (1993) Hypogonadism and infertility as sequelae of general diseases and toxins. *Internist* 34:741–755
- Joffe M, Villard L, Li Z, Plowman R, Vessey M (1993) Long-term recall of time-to-pregnancy. *Fertil Steril* 60:99–104
- Joffe M, Bisanti L, Apostoli P, Shah N, Kiss P, Dale A, Roeleveld N, Lindbohm ML, Sallmen M, Bonde JP (1999) Time to pregnancy and occupational lead exposure. *Asclepius. Scand J Work Environ Health* 25:64–65
- Jung A, Schuppe HC (2007) Influence of genital heat stress on semen quality in humans. *Andrologia* 39:203–215
- Kandeel FR, Swerdloff RS (1988) Role of temperature in regulation of spermatogenesis and the use of heating as a method for contraception. *Fertil Steril* 49:1–23
- Keck C, Bramkamp G, Behre HM, Müller C, Jockenhövel F, Nieschlag E (1995) Lack of correlation between cadmium in seminal plasma and fertility status of nonexposed individuals and two cadmium-exposed patients. *Reprod Toxicol* 9:35–40
- Kelce WR, Wilson EM (1997) Environmental antiandrogens: developmental effects, molecular mechanisms, and clinical implications. *J Mol Med* 75:198–207
- Kerr JB (1992) Spontaneous degeneration of germ cells in normal rat testis: assessment of cell types and frequency during the spermatogenic cycle. *J Reprod Fertil* 95:825–830
- Kerr JF, Wyllie AH, Currie AR (1972) Apoptosis: a basic biological phenomenon with wide-ranging implications in tissue kinetics. *Br J Cancer* 26:239–257
- Keys A (ed) (1950) *The biology of human starvation*. University of Minnesota Press, Minneapolis
- Kinlen LJ, Clarke K, Hudson C (1990) Evidence from population mixing in British New Towns 1946–85 of an infective basis for childhood leukaemia. *Lancet* 336:577–582
- Kinlen LJ, Clarke K, Balkwill A (1993) Paternal preconceptional radiation exposure in the nuclear industry and leukaemia and non-Hodgkin's lymphoma in young people in Scotland. *Br Med J* 306:1153–1158
- Kodama K, Mabuchi K, Shigematsu I (1996) A long-term cohort study of the atomic-bomb survivors. *J Epidemiol* 6:S95–105
- Krause W (2008) *Drugs compromising male sexual health*. Springer, Berlin/Heidelberg/New York
- Kühnert B, Nieschlag E (2004) Reproductive functions of the ageing male. *Hum Reprod Update* 10:327–339
- Lancranjan I, Popescu HI, Gravenescu O, Klepsch I, Serbanescu M (1975) Reproductive ability of workmen occupationally exposed to lead. *Arch Environ Health* 30:396–401
- Lee J, Richburg JH, Younkin SC, Boekelheide K (1997) The Fas system is a key regulator of germ cell apoptosis in the testis. *Endocrinology* 138:2081–2088
- Lee J, Richburg JH, Shipp EB, Meistrich ML, Boekelheide K (1999) The Fas system, a regulator of testicular germ cell apoptosis, is differentially up-regulated in Sertoli cell versus germ cell injury of the testis. *Endocrinology* 140:852–858
- Lerchl A, Nieschlag E (1996) Decreasing sperm counts? A critical (re)view. *Exp Clin Endocrinol Diabetes* 104:301–307
- Lerchl A, Keck C, Spiteri-Grech J, Nieschlag E (1993) Diurnal variations in scrotal temperature of normal men and patients with varicocele before and after treatment. *Int J Androl* 16:195–200
- Levine RJ, Symons MJ, Balogh SA, Arndt DM, Kaswandik NT, Gentile JW (1980) A method for monitoring the fertility of workers. 1. Method and pilot studies. *J Occup Med* 22:781–791

- Linder RE, Klinefelter GR, Strader LF, Veeramachaneni DN, Roberts NL, Suarez JD (1997) Histopathologic changes in the testes of rats exposed to dibromoacetic acid. *Reprod Toxicol* 11:47–56
- Lord BI, Woolford LB, Wang L, Stones VA, McDonald D, Lorimore SA, Papworth D, Wright EG, Scott D (1998) Tumour induction by methyl-nitroso-urea following pre-conceptual paternal contamination with plutonium-239. *Br J Cancer* 78:301–311
- Lundberg LS, Bracken MB, Belanger K (1995) Occupationally related magnetic field exposure and male subfertility. *Fertil Steril* 63:384–391
- MacLeod J, Wang Y (1979) Male fertility potential in terms of semen quality: a review of the past, a study of the present. *Fertil Steril* 31:103–116
- McLachlan JA (1997) Synergistic effect of environmental estrogens: report withdrawn. *Science* 277:462–463
- Meirow D, Schiff E (2005) Appraisal of chemotherapy effects on reproductive outcome according to animal studies and clinical data. *J Natl Cancer Inst Monogr* 34:21–25
- Meistrich ML, van Beek MEAB (1990) Radiation sensitivity of the human testis. *Adv Radiat Biol* 14:227–268
- Mieusset R, Bujan L (1994) The potential of mild testicular heating as a safe, effective and reversible contraceptive method for men. *Int J Androl* 17:186–191
- Mieusset R, Quintana Casares P, Sanchez Partida LG, Sowerbutts SF, Zupp JL, Setchell BP (1992) Effects of heating the testes and epididymides of rams by scrotal insulation on fertility and embryonic mortality in ewes inseminated with frozen semen. *J Reprod Fertil* 94:337–343
- Miller D, Brinkworth M, Iles D (2007) The testis as a conduit for genomic plasticity: an advanced interdisciplinary workshop. *Biochem Soc Trans* 35:605–608
- Morris ID (2002) Sperm DNA damage and cancer treatment. *Int J Androl* 25:255–261
- Muller A, De La Rochebrochard E, Labbé-Declèves C, Jouannet P, Bujan L, Mieusset R, Le Lannou D, Guerin JF, Benchaib M, Slama R, Spira A (2004) Selection bias in semen studies due to self-selection of volunteers. *Hum Reprod* 19:2838–2844
- Mylchreest E, Sar M, Cattley RC, Foster PM (1999) Disruption of androgen-regulated male reproductive development by di(n-butyl) phthalate during late gestation in rats is different from flutamide. *Toxicol Appl Pharmacol* 156:81–95
- Nagel SC, vom Saal FS, Thayer KA, Dhar MG, Boechler M, Welshons WV (1997) Relative binding affinity-serum modified access (RBA-SMA) assay predicts the relative in vivo bioactivity of the xenoestrogens bisphenol A and octylphenol. *Environ Health Perspect* 105:70–76
- Neel JV (1998) Reappraisal of studies concerning the genetic effects of the radiation of humans, mice, and *Drosophila*. *Environ Mol Mutagen* 31:4–10
- Nelson CM, Bunge RG (1974) Semen analysis: evidence for changing parameters of male fertility potential. *Fertil Steril* 25:503–507
- Niehaus M, Bruggemeyer H, Behre HM, Lerchl A (1997) Growth retardation, testicular stimulation, and increased melatonin synthesis by weak magnetic fields (50Hz) in Djungarian hamsters, *Phodopus sungorus*. *Biochem Biophys Res Commun* 234:707–711
- Olsen GW, Bodner KM, Ramlow JM, Ross CE, Lipshultz LI (1995) Have sperm counts been reduced 50 percent in 50 years? A statistical model revisited. *Fertil Steril* 63:887–893
- Pajarinen JT, Karhunen PJ (1994) Spermatogenic arrest and ‘Sertoli cell-only’ syndrome – common alcohol-induced disorders of the human testis. *Int J Androl* 17:292–299
- Parker L, Pearce MS, Dickinson HO, Aitkin M, Craft AW (1999) Stillbirths among offspring of male radiation workers at Sellafield nuclear reprocessing plant. *Lancet* 354:1407–1414
- Paulsen CA, Berman NG, Wang C (1996) Data from men in greater Seattle area reveals no downward trend in semen quality: further evidence that deterioration of semen quality is not geographically uniform. *Fertil Steril* 65:1015–1020
- Phillips KP, Tanphaichitr N (2008) Human exposure to endocrine disruptors and semen quality. *J Toxicol Environ Health B Crit Rev* 11:188–220
- Potts RJ, Newbury CJ, Smith G, Notarianni LJ, Jefferies TM (1999) Sperm chromatin damage associated with male smoking. *Mutat Res* 423:103–111
- Prentice DE, Meikle AW (1995) A review of drug-induced Leydig cell hyperplasia and neoplasia in the rat and some comparisons with man. *Hum Exp Toxicol* 14:562–572
- Ribeiro EP, Rhoden EL, Horn MM, Rhoden C, Lima LP, Toniolo L (2007) Effects of subchronic exposure to radio frequency from a conventional cellular telephone on testicular function in adult rats. *J Urol* 177:395–399
- Richthoff J, Elzanaty S, Rylander L, Hagmar L, Giwercman A (2008) Association between tobacco exposure and reproductive parameters in adolescent males. *Int J Androl* 31:31–39
- Robbins WA, Elashoff DA, Xun L, Jia J, Li N, Wu G, Wei F (2005) Effect of lifestyle exposures on sperm aneuploidy. *Cytogenet Genome Res* 111:371–377
- Rousseaux S, Sele B, Cozzi J, Chevret E (1993) Immediate rearrangements of human sperm chromosomes following in-vivo irradiation. *Hum Reprod* 8:903–907
- Rowley MJ, Leach DR, Warner GA, Heller CG (1974) Effect of graded doses of ionizing radiation on the human testis. *Radiat Res* 59:665–678
- Ryabokon NI, Goncharova RI (2006) Transgenerational accumulation of radiation damage in small mammals chronically exposed to Chernobyl fallout. *Radiat Environ Biophys* 45:167–177
- Sankila R, Olsen JH, Anderson H, Garwicz S, Glatte E, Hertz H, Langmark F, Lanning M, Moller T, Tulinius H (1998) Risk of cancer among offspring of childhood-cancer survivors. Association of the Nordic Cancer Registries and the Nordic Society of Paediatric Haematology and Oncology. *N Engl J Med* 338:1339–1344
- Schneider S, Kaufmann W, Buesen R, van Ravenzwaay B (2008) Vinclozolin – the lack of a transgenerational effect after oral maternal exposure during organogenesis. *Reprod Toxicol* 25:352–360
- Seed J, Chapin RE, Clegg ED, Dostal LA, Foote RH, Hurtt ME, Klinefelter GR, Makris SL, Perreault SD, Schrader S, Seyler D, Sprando R, Treinen KA, Veeramachaneni DN, Wise LD (1996) Methods for assessing sperm motility, morphology, and counts in the rat, rabbit, and dog: a consensus report. ILSI Risk Science Institute Expert Working Group on Sperm Evaluation. *Reprod Toxicol* 10:237–244
- Setchell BP (1997) Sperm counts in semen of farm animals 1932–1995. *Int J Androl* 20:209–214

- Setchell BP (1998) The Parkes Lecture. Heat and the testis. *J Reprod Fertil* 114:179–194
- Setchell BP, Ekpe G, Zupp JL, Surani MA (1998) Transient retardation in embryo growth in normal female mice made pregnant by males whose testes had been heated. *Hum Reprod* 13:342–347
- Sharpe RM (1993) Declining sperm counts in men – is there an endocrine cause? *J Endocrinol* 136:357–360
- Sharpe RM (2000) Environment, lifestyle and male infertility. *Baillieres Best Pract Res Clin Endocrinol Metab* 14:489–503
- Sharpe RM, Skakkebaek NE (1993) Are oestrogens involved in falling sperm counts and disorders of the male reproductive tract? *Lancet* 341:1392–1395
- Sharpe RM, Skakkebaek NE (2008) Testicular dysgenesis syndrome: mechanistic insights and potential new downstream effects. *Fertil Steril* 89:e33–38
- Sharpe RM, Fisher JS, Millar MM, Jobling S, Sumpter JP (1995) Gestational and lactational exposure of rats to xenoestrogens results in reduced testicular size and sperm production. *Environ Health Perspect* 103:1136–1143
- Sharpe RM, Atanassova N, McKinnell C, Parte P, Turner KJ, Fisher JS, Kerr JB, Groome NP, Macpherson S, Millar MR, Saunders PT (1998) Abnormalities in functional development of the Sertoli cells in rats treated neonatally with diethylstilbestrol: a possible role for estrogens in Sertoli cell development. *Biol Reprod* 59:1084–1094
- Sheiner EK, Sheiner E, Hammel RD, Potashnik G, Carel R (2003) Effect of occupational exposures on male fertility: literature review. *Ind Health* 41:55–62
- Sheynkin Y, Jung M, Yoo P, Schulsinger D, Komaroff E (2005) Increase in scrotal temperature in laptop computer users. *Hum Reprod* 20(2):452–455
- Skakkebaek NE, Rajpert-De Meyts E, Jorgensen N, Carlsen E, Petersen PM, Giwercman A, Andersen AG, Jensen TK, Andersson AM, Muller J (1998) Germ cell cancer and disorders of spermatogenesis: an environmental connection? *Apmis* 106:3–11
- Skakkebaek NE, Rajpert-De Meyts E, Main KM (2001) Testicular dysgenesis syndrome: an increasingly common developmental disorder with environmental aspects. *Hum Reprod* 16:972–978
- Skotte JH, Hjollund HI (1997) Exposure of welders and other metal workers to ELF magnetic fields. *Bioelectromagnetics* 18:470–477
- Sloan DG (1982) Male fertility potential. *Fertil Steril* 37:126
- Sloter ED, Marchetti F, Eskenazi B, Weldon RH, Nath J, Cabrerós D, Wyrobek AJ (2007) Frequency of human sperm carrying structural aberrations of chromosome 1 increases with advancing age. *Fertil Steril* 87:1077–1086
- Sohoni P, Sumpter JP (1998) Several environmental oestrogens are also anti-androgens. *J Endocrinol* 158:327–339
- Sonne SB, Kristensen DM, Novotny GW, Olesen IA, Nielsen JE, Skakkebaek NE, Rajpert-De Meyts E, Leffers H (2008) Testicular dysgenesis syndrome and the origin of carcinoma in situ testis. *Int J Androl* 31:275–287
- Sorahan T, Lancashire RJ, Hultén MA, Peck I, Stewart AM (1997a) Childhood cancer and parental use of tobacco: deaths from 1953 to 1955. *Br J Cancer* 75:134–138
- Sorahan T, Prior P, Lancashire RJ, Faux SP, Hultén MA, Peck IM, Stewart AM (1997b) Childhood cancer and parental use of tobacco: deaths from 1971 to 1976. *Br J Cancer* 76:1525–1531
- Storgaard L, Bonde JP, Olsen J (2006) Male reproductive disorders in humans and prenatal indicators of estrogen exposure. A review of published epidemiological studies. *Reprod Toxicol* 21:4–15
- Sullivan FM (1988) Reproductive toxicity tests: retrospect and prospect. *Hum Toxicol* 7:423–427
- Swan SH, Elkin EP, Fenster L (2000) The question of declining sperm density revisited: an analysis of 101 studies published 1934–1996. *Environ Health Perspect* 108:961–966
- Tapanainen JS, Tilly JL, Vihko KK, Hsueh AJ (1993) Hormonal control of apoptotic cell death in the testis: gonadotropins and androgens as testicular cell survival factors. *Mol Endocrinol* 7:643–650
- Telisman S, Colak B, Pizent A, Jurasović J, Cvitković P (2007) Reproductive toxicity of low-level lead exposure in men. *Environ Res* 105:256–266
- Thonneau P, Bujan L, Multigner L, Mieusset R (1998) Occupational heat exposure and male fertility: a review. *Hum Reprod* 13:2122–2125
- Tiemann-Boege I, Navidi W, Grewal R, Cohn D, Eskenazi B, Wyrobek AJ, Arnheim N (2002) The observed human sperm mutation frequency cannot explain the achondroplasia paternal age effect. *Proc Natl Acad Sci USA* 99:14952–14957
- Tirado OM, Martinez ED, Rodriguez OC, Danielsen M, Selva DM, Reventós J, Munell F, Suárez-Quian CA (2003) Methoxyacetic acid dysregulation of androgen receptor and androgen-binding protein expression in adult rat testis. *Biol Reprod* 68:1437–1446
- Toppiari J, Larsen JC, Christiansen P, Giwercman A, Grandjean P, Guillette LJ Jr., Jegou B, Jensen TK, Jouannet P, Keiding N, Leffers H, McLachlan JA, Meyer O, Muller J, Rajpert-De Meyts E, Scheike T, Sharpe R, Sumpter J, Skakkebaek NE (1996) Male reproductive health and environmental xenoestrogens. *Environ Health Perspect* 104(4):741–803
- Trasler JM, Hales BF, Robaire B (1985) Paternal cyclophosphamide treatment of rats causes fetal loss and malformations without affecting male fertility. *Nature* 316:144–146
- Van Waelegheem K, De Clercq N, Vermeulen L, Schoonjans F, Comhaire F (1996) Deterioration of sperm quality in young healthy Belgian men. *Hum Reprod* 11:325–329
- Vierula M, Niemi M, Keiski A, Saaranen M, Saarikoski S, Suominen J (1996) High and unchanged sperm counts of Finnish men. *Int J Androl* 19:11–17
- Vogt HJ, Heller WD, Obe G (1984) Spermatogenesis in smokers and non-smokers: an andrological and genetic study. In: Obe G (ed) *Mutation in man*. Springer, Berlin/Heidelberg/New York, pp 247–291
- Walker C, Ahmed SA, Brown T, Ho SM, Hodges L, Lucier G, Russo J, Weigel N, Weise T, Vandenberg J (1999) Species, interindividual, and tissue specificity in endocrine signaling. *Environ Health Perspect* 107:619–624
- Wang C, McDonald V, Leung A, Superlano L, Berman N, Hull L, Swerdloff RS (1997) Effect of increased scrotal temperature on sperm production in normal men. *Fertil Steril* 68:334–339
- Wdowiak A, Wdowiak L, Wiktor H (2007) Evaluation of the effect of using mobile phones on male fertility. *Ann Agric Environ Med* 14:169–172

- Welch LS, Schrader SM, Turner TW, Cullen MR (1988) Effects of exposure to ethylene glycol ethers on shipyard painters: II. Male reproduction. *Am J Ind Med* 14:509–526
- Welsh M, Saunders PT, Finken M, Scott HM, Hutchison GR, Smith LB, Sharpe RM (2008) Identification in rats of a programming window for reproductive tract masculinization, disruption of which leads to hypospadias and cryptorchidism. *J Clin Invest* 118:1479–1490
- Whorton D, Krauss RM, Marshall S, Milby TH (1977) Infertility in male pesticide workers. *Lancet* 2:1259–1261
- Wilcox AJ, Baird DD, Weinberg CR, Hornsby PP, Herbst AL (1995) Fertility in men exposed prenatally to diethylstilbestrol. *N Engl J Med* 332:1411–1416
- World Health Organization (2009) 5th edn. WHO Laboratory Handbook for the Examination and Processing of Human Semen. Geneva (in press)
- Xuezhong J, Youxin L, Yilan W (1992) Studies of lead exposure on reproductive system: a review of work in China. *Biomed Environ Sci* 5:266–275
- Yauk CL, Berndt ML, Williams A, Rowan-Carroll A, Douglas GR, Stämpfli MR (2007) Mainstream tobacco smoke causes paternal germ-line DNA mutation. *Cancer Res* 67:5103–5106
- Zenzen MT, Puy LA, Bielecki R, Reed TE (1999) Detection of benzo[a]pyrene diol epoxide-DNA adducts in embryos from smoking couples: evidence for transmission by spermatozoa. *Mol Hum Reprod* 5:125–131
- Zheng N, Monckton DG, Wilson G, Hagemeyer F, Chakraborty R, Connor TH, Siciliano MJ, Meistrich ML (2000) Frequency of minisatellite repeat number changes at the MS205 locus in human sperm before and after cancer chemotherapy. *Environ Mol Mutagen* 36:134–145
- Zitzmann M, Rolf C, Nordhoff V, Schröder G, Rickert-Föhning M, Gassner P, Behre HM, Greb RR, Kiesel L, Nieschlag E (2003) Male smokers have a decreased success rate for in vitro fertilization and intracytoplasmic sperm injection. *Fertil Steril* 79(3):1550–1554

Contents

20.1 Medical History and Somatic Factors	392	20.5 Sperm Antibodies	428
20.1.1 Age.....	392	20.5.1 Pathophysiology.....	428
20.1.2 Coital Frequency.....	393	20.5.2 Antibody Testing.....	428
20.1.3 Length of Childlessness.....	393	20.5.3 Treatment.....	428
20.1.4 Risk of Infection.....	393	20.6 Early Pregnancy Abnormalities	429
20.1.5 Psychological Factors.....	394	20.6.1 Implantation.....	429
20.1.6 Hormones and Female Sexuality.....	394	20.6.2 Pregnancy Loss.....	429
20.1.7 Stress.....	394	20.6.3 Epidemiology.....	429
20.1.8 Environmental Factors.....	395	20.6.4 Etiologic Factors.....	430
20.1.9 Pertinent Medical History.....	396	20.7 Idiopathic Infertility	431
20.2 Ovarian Cycle and Ovulation	398	20.8 Prospects and Conclusion	431
20.2.1 Follicles.....	398	References	431
20.2.2 Menstrual Cycle.....	402		
20.2.3 Diagnostic Evaluation of the Cycle.....	405		
20.2.4 Impairment of Follicle Maturation.....	408		
20.3 Infertility Due to Disturbances of Gamete Migration	419		
20.3.1 Vagina and Cervix.....	420		
20.3.2 Anomalies of the Female Genital Tract.....	421		
20.3.3 Physiology of Tubal Function.....	421		
20.3.4 Diseases of the Fallopian Tubes.....	422		
20.3.5 Diagnostic Tests for Uterine and Tubal Patency.....	423		
20.3.6 Treatment.....	424		
20.4 Endometriosis	425		
20.4.1 Pathogenesis and Epidemiology.....	425		
20.4.2 Symptoms.....	425		
20.4.3 Pathophysiology.....	425		
20.4.4 Staging of Endometriosis.....	426		
20.4.5 Treatment.....	426		

U. A. Knuth
 Endokrinologikum Hamburg, Lornsenstraße 4–6,
 D-22767 Hamburg, Germany
 e-mail: Ulrich.Knuth@endokrinologikum.com

The care and the successful treatment of the infertile couple requires a multidisciplinary approach which supports and counsels the couple as an entity. The flow-chart in Fig. 20.1 enables the non-gynecologist to appreciate the main diagnostic and therapeutic steps necessary for the evaluation and treatment of female factors of a couple's infertility.

20.1 Medical History and Somatic Factors

20.1.1 Age

The decline in female fecundity with advancing age is well known; donor insemination studies which allow for a constant male factor show a decrease in female fertility with increasing female age. Figure 20.2 shows exemplary studies (Schwartz and Mayaux 1982; Yeh and Seibel 1987). IVF/ICSI reported in the German IVF Register (2005) and evaluated prospectively showed a clinical pregnancy rate per transfer of 39.7% for women under 31 years old ($n = 1859$), 33.5% for the 31–34 year-old group ($n = 3366$); this dropped to 27.94% in the following group of up to 40 year-olds ($n = 3923$) and fell even further to 12.3% in patients ($n = 778$) older than that. Declining female fertility is ascribed to an age-dependent decrease in ovarian function. An increase in FSH levels parallel to female age begins at the age of 25 (Ebbiary et al. 1994).

The FSH level, in addition to inhibin B in the early follicular phase as well as AMH (anti-Muller hormone), combined with estradiol and progesterone, is the most important parameter for diagnosing declining ovarian function (Gülekli et al. 1999; Corson et al. 1999). Conversely, assisted reproduction studies of couples in

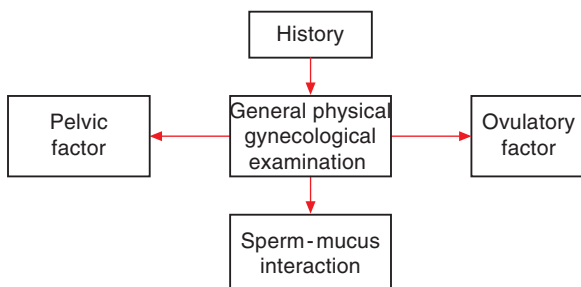

Fig. 20.1 Main diagnostic areas of female infertility work-up

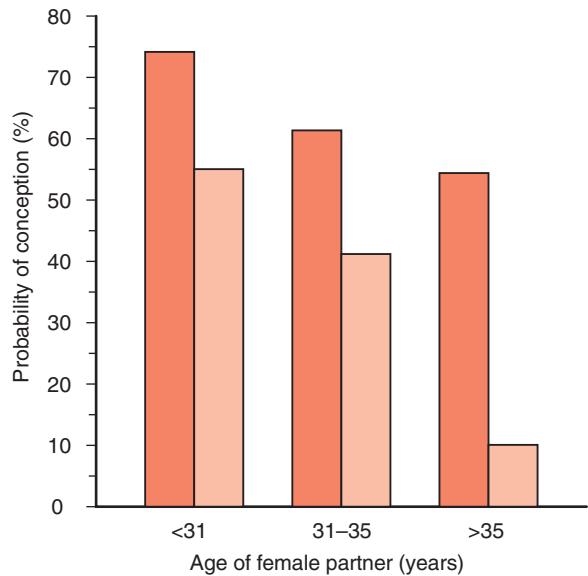

Fig. 20.2 Relationship between probability of conception and female age according to two independent studies (Black columns: redrawn from Federation CECOS, Schwartz and Mayaux (1982). Reprinted with permission. Hatched columns: redrawn from Yeh and Seibel (1987). Reprinted with permission from the American College of Obstetricians and Gynecologists)

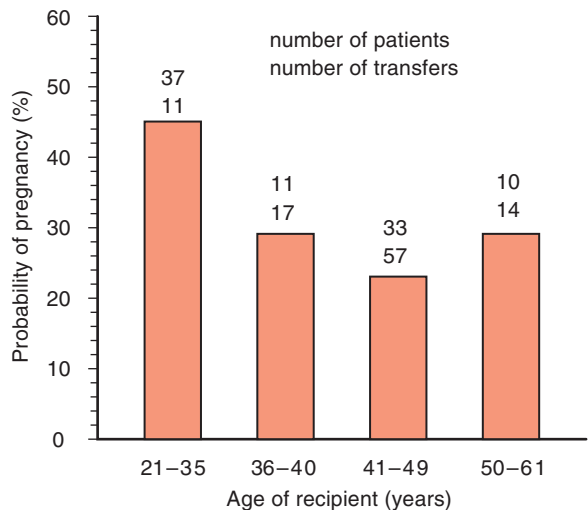

Fig. 20.3 Pregnancy rates after transfer of donated oocytes depending on recipient's age (Adapted from Flamigni et al. (1993). With permission of the publisher)

which older women receive oocytes from younger donors show normal fertility rates (Fig. 20.3). However, even here fertility rates decline after the age of 35 years.

The older woman undeniably bears an increased risk of pathological alterations of her reproductive

organs. Moreover, a subgroup of patients with decreased fertility evolves among those who do not conceive despite years of unprotected intercourse. In these cases age is only an apparent factor for the decline in fertility. A retrospective study by structured interview after delivery showed that no change occurs in the latency rates until conception in normal fertile women between the ages of 26 and 35 years (Knuth and Mühlenstedt 1991).

20.1.2 Coital Frequency

The decline in fecundity with advancing age is seen by some authors to result solely from a decrease in coital frequency per cycle (James 1979). Other studies have shown that this factor must be assessed before forming a prognosis in the treatment of the infertile couple (Fig. 20.4).

Increased coital frequency augments the probability of fertile sperm reaching the Fallopian tubes at the optimal time. One could thus deduce that low coital frequency, perhaps only at the time of ovulation, could result in acceptable rate of conception. Such a recommendation is, however, often counterproductive. Recommendations to have intercourse on certain days or even at a certain time of day cause considerable

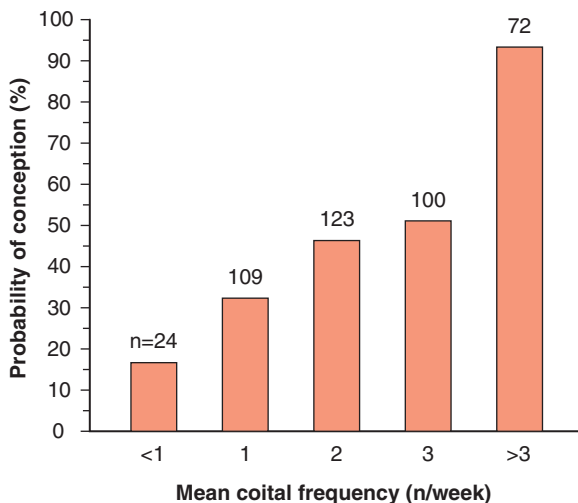

Fig. 20.4 Rate of conception depending on coital frequency per week in couples who achieved a pregnancy within 6 months of unprotected intercourse (Adapted from MacLeod and Gold (1953). Reproduced with permission of the publisher, the American Society for Reproductive Medicine [formerly The American Fertility Society])

stress, often preventing couples from having normal intercourse with intravaginal ejaculation because of erectile dysfunction (Agarwal and Haney 1994). The experienced physician will only suggest unprotected intercourse before and during the “fertile days”. Recommendations as to the frequency or time of day for intercourse should be withheld. Natural conception studies have shown that a single act of intercourse timed between 6 days before and 3 days after ovulation results in pregnancy (France et al. 1992). Reevaluation of earlier publications shows that the highest rates of spontaneous conceptions occur when coitus takes place on the day prior to ovulation (Dunson et al. 1999).

20.1.3 Length of Childlessness

The duration of barrenness is directly related to the probability of conceiving and represents an important prognostic parameter. A clinical study of 969 Dutch couples (Eimers et al. 1994) showed an 11% decline in the fertility rates with the numbers of years of unprotected intercourse. A woman who has spent 7 years unintentionally childless thus has only a 50% chance of becoming pregnant compared to a woman with 1 year of infertility. If, however, she had an earlier pregnancy, the factor increases chances for probable conception by 74% compared with a population with primary infertility.

The original models for predicting the spontaneous fertility rate in subfertile patients have been refined further (Hunault et al. 2005) and can provide valuable help in planning the intensity of further therapy in cases of idiopathic infertility. A standardized estimate can easily be calculated using the following parameters: length of involuntary childlessness, female age, primary or secondary infertility, percentage of motile sperm and previous care (referral by gynecologist or general practitioner). Including results of a postcoital test greatly increases the quality of prediction. The exponential function is found in the appendix of the original publication.

20.1.4 Risk of Infection

The probability that the couple’s infertility is due to a tubal factor rises with the number of sexual partners in the past and is also correlated with age at first intercourse.

20.1.5 Psychological Factors

Female sexual interest seems to be correlated with the menstrual phase. Increased libido in the follicular phase results in a natural rise in coital frequency during the fertile phase (Dennerstein et al. 1994). Infertility therapy can, however, deeply disturb the couple's sexuality, interrupting physiological events and resulting in functional infertility. During infertility therapy inherent sexual dysfunction is often magnified. It can be symptomatically divided into three groups: loss of libido, orgasmic dysfunction, and inability for intravaginal intercourse (Herms 1989).

20.1.5.1 Libido Dysfunction and Orgasmic Disturbances

The primary absence of sexual desire (**alibidinia**) is extremely rare. The decrease or loss of libido is usually a secondary change. Psychological causes, such as deep-rooted fear or depression, can result in aversion reactions, in a loss of sexual interest, or even in sexual deviations. The group of organic causes includes chronic dyspareunia, endocrinological imbalance and debilitating disease. Psychotropic drugs such as anti-hypertensives, tranquilizers or sedatives can alter the patient's libido. Even the constant availability of a sexual partner can result in apathy, a loss of sexual interest and even in sexual aversion. This, of course, results in reduced coital frequency and thus reduced fertility. Factors which cause a change in libido can also influence orgasmic capability.

20.1.5.2 Dyspareunia

In contrast to inhibited sexual desire and orgasmic dysfunction, which are usually psychological disturbances, the main factor for dyspareunia is physical discomfort. Painful intercourse, called **algopareunia**, can have organic as well as psychological origins, which may occur sequentially. Timed intercourse recommended during an infertility treatment program can itself be a major factor in initiating this symptom.

In some patients, **vaginismus**, an involuntary painful spasm of the pelvic floor, inhibits intercourse. This is often combined with a defensive reaction of the

entire body in the form of lordosis and adduction of the lower extremities. This reaction is always psychological in nature, and is often combined with sexual fear or a traumatic sexual experience in the past. The care of the patient must be in the form of psychotherapy, and never of surgical nature.

20.1.6 Hormones and Female Sexuality

The influence of hormonal factors on female sexuality is not as clear as it is for male sexuality. **Estrogens** are necessary for normal vaginal reaction during sexual arousal, but their influence on sexual desire and female orgasm is not as distinct. An important role in female libido is ascribed to testosterone. In women with androgen deficiency loss of libido is the dominant clinical symptom (Davis 1999a). This loss can be effectively compensated by appropriate substitution of androgens (testosterone patches) or androgen precursors such as dehydroepiandrosterone (Arlt et al. 1999; Davis 1999b). However, the role of hormones in female sexuality is either strongly modified by **psychosocial factors** or results in a much more individualized reaction when compared to that of males (Bancroft 1993).

A critical review of androgen therapy in women (Clinical Guidelines of the Endocrine Society) recommends refraining from a diagnosis of female androgen deficiency at the present time, as the criteria for diagnosis and methods for its determination are inadequate (Wierman et al. 2006). From the clinical point of view this position is questionable (Traish et al. 2007).

20.1.7 Stress

During the treatment of infertility stress is often mentioned as one of the possible causes of failed conception. However, there is no clear definition of this entity which could be used for a reproducible experimental study. Stress implies a pooling of many negative factors which influence well-being, such as exhaustion stemming from rest or sleep deficiency, tension and inability to find relief from real or imagined pressure. An investigation of 420 Danish couples seeking infertility treatment for the first time showed a reduction in the probability of conception from 16.5–12.8% in couples with a high

stress score, i.e., >80th percentile on the General Health Questionnaire (Hjollund et al. 1999). Over and beyond such systematic studies, often anecdotal and casuistic evidence is offered to support the thesis that stress factors decrease female fertility. One example often cited is the supposedly increased pregnancy rate after adoption. A systematic study, however, shows that the conception rate of 4.3% post adoption is equal to that of couples who do not adopt (Banks 1961). A systematic overview of the prevalence of psychogenic infertility considers 5% a realistic estimate (Wischmann 2006). That acutely stressful situations need not be an obstacle to pregnancy can be inferred from high pregnancy rates (5%) following rape (Holmes et al. 1996). Menstrual cycle changes which are caused by stress are, however, well documented and are discussed in Sect. 20.2.4.

20.1.7.1 Immunological Modulation and Stress

Recently reciprocal relationships between stress and immunological events have been increasingly noted. Especially in the female there seem to be powerful mechanisms in which immunological factors stimulate stress factors and result in decreased fertility.

An increased secretion of corticotropin-releasing hormone (CRH), with the resulting stimulation of ACTH, causes a rise of glucocorticoid secretion. This modulates precursors of prostaglandin synthesis, platelet activating factor, serotonin, cytokinins, interleukin-1 and -6 and tumor necrosis factor (TNF). CRH is a part of the pro-opiomelanocortin system, and thus regulates the secretion of α -MSH and β -endorphin, which, in combination with met-enkephalin, directly influences the function and activity of the immunocytes. It can be concluded that a stress situation can negatively influence implantation via autoimmune factors. This complex interaction promises to become a major area of female infertility research in the future (Negro-Vilar 1993; Chrousos 1995).

20.1.8 Environmental Factors

So-called “environmental factors” are often cited while searching for a cause for infertility. It is, however, almost never possible to make a clear statement pertaining to particular environmental factors on female infertility and their influence on an individual couple’s infertility.

20.1.8.1 Definitions

Several years ago the WHO initiated a study of environmental factors relevant to fertility (Baranski 1993). To measure the influence of potentially harmful substances, a measurable parameter is required. An often cited parameter is the infertility rate. Using this parameter, the rate of infertility in a group of normal patients is compared to the infertility rate in a group of patients who are under the influence of a certain external environmental factor. Methodical problems arise whenever infertility is to be defined, as the condition may be subject to varying preconditions:

1. Failure to conceive after 1 year of unprotected intercourse
2. Failure to achieve a clinically discernable pregnancy after 1 year of unprotected intercourse
3. Failure to deliver a viable baby after 1 year of unprotected intercourse

These three different definitions already demonstrate that methods of confirming a pregnancy alone may influence the parameter “infertility rate” as well as results.

Since the organism is never exposed exclusively to one potentially noxious environmental factor, the influence of possible cofactors such as nicotine, alcohol, caffeine and other substance abuse must be considered in first instance. Certain behavioral patterns are also correlated with other socio-economic factors, which again influence the fertility rate.

20.1.8.2 Epidemiology

Although extensive lists exist of environmental factors possibly influencing female fertility (Baranski 1993), they are usually of little use for practical counselling of the individual infertile couple, since even the best epidemiological studies only show a slightly elevated risk for a population exposed to a potential environmental hazard as a whole. Infertility rates in women rise when they are continually exposed to toxins such as anesthetics, asbestos, textile dyes and dry cleaning agents. The risk for infertility is increased by a factor of 2.4 in women exposed to a high level of noise (Rachootin and Olsen 1983). Even specialized databases fail to provide useful data on toxic influences on human reproductive functions (Scialli 1994). The fact that less

than 1% of over 60,000 chemical substances included in lists of toxic materials has been investigated, illustrates the magnitude of the problem.

Even well-controlled studies fail to give a precise picture of the influence of certain factors on fertility. A study of dental assistants who were exposed to mercury vapor showed, for example, that the fertility of women who assisted in more than 30 fillings per week only reached 63% of the fertility of those women not exposed to mercury vapor. However, the fertility rate of those women with a low exposure to mercury vapor was better than that of the non-exposed controls (Rowland et al. 1994).

20.1.8.3 Nicotine

Compared to poorly definable environmental factors, the exposure to nicotine plays a practical role which can be usually eliminated. Although the effect of nicotine on fertility is not consistently described in the literature, a large British study clearly demonstrates a negative effect of nicotine on fertility. Female nicotine consumption resulted in a 12% rise in the conceptive latency in 11,407 persons born in 1958 and followed in Great Britain. Male smoking did not cause a negative effect on fertility after data was corrected for socio-economical factors (Joffe and Li 1994). A prospective Danish study of 430 couples showed a reduced rate of fecundity to 0.53 in women who smoked, compared with non-smokers (95% confidence interval 0.31–0.91). An important factor was whether the mothers of the women investigated had smoked during pregnancy (Jensen et al. 1998). It is also known the IVF results are poorer in women who smoke (Zitzmann et al. 2003), and that ovarian function also declines earlier in this population. One of the first steps in patient education and counselling during infertility treatment should thus be to abandon nicotine consumption.

20.1.8.4 X Rays and Radioactivity

Although the negative effects of smoking on female fertility have been proven, most of the affected women do not find it necessary to change their behavior. In contrast to this, the influence of X rays and radioactivity on fertility is usually overestimated by the general population.

Epidemiological studies and detailed analysis of radioactive exposure of females before conception show no clear effects (Committee on the Biological Effect of Ionizing Radiation 1990). A study of 627

women with thyroid carcinoma who were treated with radioactive iodine (^{131}I) showed no significant difference in the fertility rate when compared to controls (Dottorini et al. 1995). The ovarian radioactive dose in such a therapy was determined to be $1.14 \pm 0.34 \text{ Gy}$ (mean \pm SEM) (Izembart 1992). In this study 12 of 50 patients developed amenorrhoea and 38 showed no change in ovarian function. The effect of age on onset of menopause was, however, not clearly delineated in the study. Total body radiation because of neoplastic disease during childhood results in definitively higher total body doses. These cover a range between 20 and 30 Gy. Women who have survived this form of treatment and have continuing ovarian function often deliver low birth weight infants. This is explained by hypoplasia of uterine tissue and impaired vascularization (Critchley et al. 1992). Research data show a variable influence of radiation on female fertility. It cannot be deduced that a pregnancy will not be achievable in these patients. An ovarian dose of 4 Gy can cause sterility in about 30% of young women and in 100% of women over the age of 40 years (Ogilvy-Stuart and Shalet 1993). These results are underlined by data obtained from patients treated with chemotherapy and radiation in Hodgkin's disease (Bokemeyer et al. 1994).

20.1.8.5 Electromagnetic Fields

In contrast to the low number of patients who have been exposed to radioactive materials or X rays, almost every patient seen for infertility counselling has been or is exposed to weak electromagnetic fields. Some consider so-called "electro-smog" as the causal factor for infertility. This has not been proven for the average patient. Even in extreme situations, such as the personnel of nuclear magnetic resonance imaging departments, no change in fertility rates was apparent (Kanal et al. 1993). The harmlessness of **ultrasonography** for the fetus will be discussed later.

20.1.9 Pertinent Medical History

20.1.9.1 Physiology of Pregnancy

An assessment of the medical history for female and male factors affecting infertility is important in infertility counselling since often causal therapeutical options become possible. Notwithstanding, consideration of

diseases which may worsen during pregnancy is also necessary, so that the couple may be counselled to forego further therapy.

Such changes in pregnancy may be caused by adaptations in the cardiovascular system as well as by immunological events. Renal circulation increases 50% in early pregnancy. The circulating blood volume expands during pregnancy by between 27% and 64%. Cardiac output grows from 4.5 to 5.5 l/min and the pulse rate also rises from 70 to about 85 beat/min at the end of pregnancy. There are no major changes in the respiratory system.

The ureters dilate during pregnancy and may also become compressed. This results in a higher infection rate and/or hydronephrosis. The motility of the gastrointestinal tract decreases. Liver function is usually not altered. Thyroidal activity is stimulated with a rise in protein-bound iodine levels. Carbohydrate metabolism usually remains constant, although a slight glucosuria is common as a result of a lower renal threshold for glucose.

20.1.9.2 Pertinent Medical Disorders

Pulmonary disease. Pulmonary tuberculosis will not worsen during pregnancy. Pregnancy has a favorable influence on the course of uncomplicated **sarcoidosis** with a possible decrease of pulmonary hilus lymphomas. The course of **asthma** is also usually not altered during pregnancy.

Cardiovascular system. Manifest cardiovascular disease may deteriorate owing to the physiological changes that occur in the cardiovascular system during pregnancy. A patient with cardiac disease should thus consult a cardiologist before beginning infertility therapy. Today pregnancy is even possible following heart transplant (Morini et al. 1998).

Gastrointestinal disease. Inflammatory bowel disease usually has no effect on fertility. In severe Crohn's disease or ulcerative colitis one should, however, wait for a less active or inactive phase to plan pregnancy, if possible.

Viral hepatitis is a much more significant factor in infertility therapy. A review is found in the bulletin: The Practice Committee of the ASRM (2006b). In areas endemic to hepatitis A, women usually become immune to hepatitis A before reaching reproductive age. Children of mothers who develop acute **hepatitis A** during pregnancy show no effects of the disease and fetal

transfer of the HA virus is extremely rare, hepatitis A is not a true problem in infertility therapy. As the best protective measure, a vaccination can be carried out during pregnancy.

The situation with **hepatitis B** infection is more serious. Prenatal care studies in Germany show a positive hepatitis B antigen in 0.73–1.73% of all women examined (Joosten and Stürmer 1980). Between 20% and 30% of all HBsAg positive mothers communicate the virus to their offspring if immunoprophylaxis is not performed. In women seropositive for HbsAg and HbeAg the rate increases to 90%. Intrauterine transmission of this infection to the fetus is, however, rare. More than 90% of infected children probably result from direct contact of the newborn with infectious maternal blood during vaginal delivery (review article by Heckers and Lasch 1986).

The relatively low risk of an intrauterine hepatitis B infection was demonstrated during an unfortunate situation in which 22 women were contaminated with hepatitis B in an IVF programme. All women suffered from acute hepatitis B during the first trimester. Hepatitis B-DNA could not, however, be isolated in the serum or in the lymphocytes of the 22 exposed children (Quint et al. 1994).

The importance of **hepatitis C** is more imminent than that of hepatitis B, since passive immunization does not seem to be a possibility in this infection. In northern Europe investigations in blood donors revealed a rate of disease between 0.01% and 0.05%.

The infection persists in about 80% of all cases and leads to chronic persistent or chronic active hepatitis, with 20–30% developing into cirrhosis. Passive immunization is not currently available. Standard therapy with IFN- α and Ribavirin is contraindicated during pregnancy. Intrauterine transmission of acute hepatitis C has been clearly demonstrated. Follow-up of 403 women post-delivery with hepatitis C virus antibodies and their offspring revealed infection in 13 of 403 neonates (3.2%). This applied only to infants whose mothers were virus-RNA positive. As six infants were virus RNA-positive immediately after birth, an intrauterine infection must be assumed (Resti et al. 1998). If patient history reports hepatitis C, or if a finding of such arises during a routine diagnostic step in infertility therapy, counselling must include the risk for the fetus. The potential of interferon therapy has yet to be clarified in these particular cases.

The risk of hepatitis C transmission to spouses of carriers is not clear (Van der Poel et al. 1994). Hepatitis B, E, F and G are of lesser importance (see details in review cited above).

A patient with a **chronic hepatitis** need not expect a progression of the disease during pregnancy. In patients with chronic aggressive hepatitis, however, only the autoimmune form is not influenced by pregnancy. The prognosis in chronic aggressive hepatitis B is reduced. Experts are not, however, able to make general recommendations for this situation. In the case of esophageal varicosis due to liver cirrhosis, experts recommend prophylactic sclerosis prior to planned pregnancy.

In contrast to the various forms of hepatitis, **ulcerative disease** is not a problem either before or during pregnancy. An initial attack rarely occurs during pregnancy. **Cholecystitis** is described more frequently than peptic ulcer disease. One of 1,300 cholecystectomies are performed during pregnancy. There is, however, no special need for counselling concerning this subject during infertility therapy.

HIV. In contrast to hepatitis, HIV-positive women seeking pregnancy represent only a small group in Germany. When the mother is seropositive, the probability of an intrauterine infection is about 20% if a caesarean section is done and when the mother does not nurse. If the mother is treated (e.g., with azidothymidine) during pregnancy, the risk of infant infection can be reduced to approximately 3%. Independent of possible infant infection, HIV represents a fourfold higher risk of abortion and stillborn offspring (Brocklehurst and French 1998). The same authors documented an additional albeit weak effect of pregnancy on the further development of HIV disease (French and Brocklehurst 1998). Recent investigations no longer confirm this (Tai et al. 2007). In view of this development, therapeutic possibilities must be discussed individually with the affected couple who are dependent on intensive counselling (The Practice Committee of the ASRM 2006a). A review of the recommendations of the German AIDS Society and the German Society for Gynecology and Obstetrics recently appeared (Tandler-Schneider et al. 2008).

Urinary tract. Pre-existing diseases of the urinary tract can cause severe complications in pregnancy. In particular cases patients should be counselled against further infertility therapy. During acute renal disease such as **pyelonephritis** or **glomerulonephritis**, pregnancy should be avoided. Treated tuberculosis of the urinary tract with negative controls is no argument against a pregnancy. A patient history of **kidney stones** or a surgically corrected congenital hydronephrosis do not present a contraindication for pregnancy. Progressive **polycystic degeneration of the kidneys** with restricted

glomerular and tubular function have a poor prognosis in pregnancy, and thus also in infertility therapy. **Chronic glomerulonephritis** and **diabetic glomerulonephritis** are a high risk for the development of eclampsia and intrauterine fetal demise. During counselling of patients with a nephrotic syndrome one should more or less advise against further infertility therapy. After **renal transplantation**, however, patients may consider a pregnancy in consultation with a specialist 2–3 years after surgery (Kremling 1986).

Neoplasias. Malignant gynecological diseases such as **breast cancer**, **cervical cancer** and **ovarian cancer** differ as to the effects of a pregnancy on the course of the disease (Börner 1986). In summary, a pregnancy following breast cancer will not stimulate further disease or worsen the prognosis. Patients with a history of **carcinoma in situ of the uterine cervix** should allow a period of 6–12 months to pass during which cytological controls are negative before attempting therapy for infertility. Patients with **malignant ovarian tumors**, who were treated with a conservative unilateral salpingo-oophorectomy should be counselled to undertake contraceptive methods for a period of 2 years, since most recurrences appear during this period.

It is not possible to cover all of the diseases which may be influenced by pregnancy in this chapter. Most of the other diseases are quite rare, so that even gynecological obstetrical textbooks do not suffice in counselling an individual patient. A literature search will provide helpful and up-to-date information.

20.2 Ovarian Cycle and Ovulation

20.2.1 Follicles

The mainstay of female reproductive physiology is the maturation of the oocyte in conjunction with the menstrual cycle. The evaluation of the maturing ovarian follicle, of ovulation and of the luteal phase is therefore a central point in the workup of infertility patients.

20.2.1.1 Early Oocyte Development

The maturation of oocytes is a long process which begins during fetal development. Oocyte maturation is

completed, however, only during fertilization, which often takes place up to more than 30 years after the beginning of oocyte development. During fetal life 6–7 million germ cells develop in the second trimester. By the time of birth, many of the germ cells have undergone atresia, and the newborn female has about 2 million ova. At this time, the **primary oocytes** have undergone the first part of the first meiotic division and have reached the first stage of arrest. This phase of arrest lasts until puberty, when ovulation of the oocytes begins.

20.2.1.2 Meiosis

Meiosis only continues when ovulation has taken place. One half of the paired chromosomes are expelled in the **first polar body**. The oocyte is now haploid. This phase is called the **metaphase II** and the oocyte is a **secondary oocyte**. This is the situation at the time of ovulation. If the oocyte is not fertilized, it remains in this stage. If fertilization occurs, one half of the chromatin is again expelled in form of the **second polar body**. Female meiosis, thus, in contrast to spermatogenesis, begins in the early fetal period and ends at the point of fertilization in the adult female.

20.2.1.3 Follicle Development

The development of the surrounding follicle occurs in parallel with ovarian oocyte development. During the 8th week of pregnancy the primary oocytes are surrounded by a single layer of spindle-shaped cells. These are **precursors of the later granulosa and theca cells**. The oocyte and the granulosa cells are surrounded by a basal membrane which separates the **primordial follicle** from the stroma. The follicle with layered granulosa cells is called a **secondary follicle**. In the 7th month of pregnancy an **antrum** can develop in the granulosa cell layer; the follicle is then called a **tertiary or a Graafian follicle**.

20.2.1.4 Regulatory Mechanisms

The granulosa cells begin to express **FSH receptors** during the 5th–6th month of pregnancy. The number of receptors per cell remains constant; the absolute number of FSH receptors per follicle, however, rises with the increasing number of granulosa cells. During further development, receptors for estradiol, progesterone,

testosterone and glucocorticoids can be detected. For the further development of the follicle FSH is required. This is supported by the influence of the estrogens. Thus a **positive feedback** exists in which even minimal FSH concentrations in the follicular liquid are answered by a positive feedback. It is of note that FSH is only detectable in the follicular fluid if the ratio of estrogens to androgens is dominated by estrogens and the quotient is above 1. If androgens increase, FSH is not detectable.

In addition to estradiol and FSH, other factors influence the mitotic division of the granulosa cells. Aromatase and LH receptors are induced depending on the FSH concentration and the time phase. The aromatases convert androgens into estrogens. The development of LH receptors in the **dominating follicle** prepares it for the midcyclic LH surge and thus for ovulation. Additionally, the LH receptors are necessary for the production of progesterone which occurs later in the corpus luteum. During follicle development, estradiol seems to act synergistically with FSH to facilitate the development of FSH receptors. Later in the cycle estradiol stimulates LH receptor density and the activity of the LH receptors. When estrogen synthesis is blocked, none of the Graafian follicles will grow in diameter over 2.2 mm. If FSH stimulation is blocked during follicle development, FSH and LH receptor numbers decline, and granulosa cells die.

Follicle selection. Knowledge of follicular development is important for understanding impaired follicular maturation. The preovulatory rise in estradiol initiates a negative feedback, and thus a suppression of pituitary FSH secretion. Since the pre-ovulatory follicle has a higher receptor density than the other smaller follicles, further maturation is possible, whereas the smaller follicles must degenerate to **atretic** follicles. The effect of FSH can be modulated by prolactin and sexual steroids. Estrogen, insulin and other somatotrophic factors can influence the aromatase activity and the development of LH receptors. The stimulation of aromatase, LH receptors and prolactin receptors by FSH seems to be restricted to the membranes of the granulosa cells. Thus a very complicated system of endocrine and paracrine regulatory mechanisms exist in which there are a multitude of steps during which the maturation of follicles can be disturbed.

Two-cell-theory. Further LH receptors develop in the cells of the **theca interna** of the Graafian follicle. The theca interna consists of mesenchymal cells surrounding the entire follicle. Under the influence of LH, the

theca interna cells change into epithelial cells which are able to produce androgens, of which the most important is **androstenedione**. This androgen is the main precursor for follicular estradiol production and a significant factor for further follicle development. An excessive production of androgens, which exceeds the capacity of the aromatase to synthesize estrogens, causes a decline in the estrogen/androgen quotient and thus follicular atresia as already described. In an androgen-rich environment, the direction of conversion of androstenedione is changed even further from estrogen formation into additional androgen production. An optimal follicle can only develop if androgen production in the theca cells is followed by estrogen production from these androgens in the granulosa cells. This mechanism is called the **two-cell-theory** of follicular estrogen production. Like granulosa cells, the theca cells can also be influenced by other hormones. The regulation of the hypothalamic pituitary ovarian axis and the target organs is simplified in [Fig. 20.5](#).

Paracrine regulation of ovarian function. In the light of recent investigations, the classic model of ovarian regulation appears inadequate. Follicle selection, growth, maturation and ovulation seem to be regulated by complex intraovarian mechanisms in conjunction with gonadotropins and sex steroids. These local factors presumably have both paracrine and autocrine effects. In the paracrine system, locally secreted messenger substances influence neighboring target cells of the same organ, whereas autocrine regulation influences secretory cells within the organ via surface receptors.

The list of autocrine/paracrine factors is growing rapidly. Current research is concentrated on the **IGF (insulin-like growth factor) system**. Beside the liver, the ovary is the main source of insulin-like growth factor 1 (IGF 1). **IGF 1** and **IGF 2** are produced by the granulosa cell. IGF 1 increases the effect of LH and FSH and seems to be important in the coordination between theca and granulosa cell functions. FSH and LH increase the number of receptors on the granulosa cell and this reaction is additionally intensified by estrogens. In the theca cell, IGF 1 stimulates and increases steroid formation. On the whole, IGF 1 is important for the formation and increase of FSH and LH receptors, for steroidogenesis, for secretion of inhibin and oocyte maturation.

Along with IGF 1 receptors, the granulosa cell has receptors for **insulin**, which binds directly to IGF receptors. This cross-reactivity is important for many pathophysiological events in the ovary, as insulin causes

a modulation of ovarian function. The regulatory cascade is complicated by the fact that IGF molecules are bound and neutralized by IGF-binding proteins. Thus the concentration of IGF-binding proteins directly affects cell regulation. In addition, the **TGF (transforming growth factor) β gene** family is important. This term comprises substances such as **activin**, **inhibin** and **“growth and differentiation factor 9”** which modulates both stimulatory and inhibiting effects of gonadotropins. “Growth and differentiation factor 9” seems to be an oocyte-specific growth factor which is important for development beyond the primordial follicle. Additionally, an intraovarian **interleukin-1 system** seems to regulate periovulatory events reciprocally with LH (Udoff and Adashi 1999).

Beside growth processes which are connected with an increase of cell numbers in follicle maturation and ovulation, the elimination of supernumerary cells in the ovary is a decisive factor in normal ovarian function. This programmed cell death (apoptosis) is becoming a major research interest (Chun and Hsueh 1999). Clinically, most of the paracrine parameters which have been discussed cannot be quantified. To evaluate normal or pathological development of follicle maturation, one still has to rely on classical measurement of sexual steroids and gonadotropins. [Figure 20.6](#) shows the course of the serum hormone concentrations used in routine clinical diagnosis.

Anti-Muller hormone. In recent years anti-Muller hormone, also known as MIS (Muller-inhibiting substance) has been identified as an important marker of ovarian function (van Rooij et al. 2002; Al-Qahtani and Groome 2006). Originally this homodimeric glycoprotein, discovered in 1940 by Alfred Jost, was believed to be a secretory product of Sertoli cells whose function was to initiate the regression of the Mullerian ducts in the male fetus (Josso et al. 2006).

In the female organism AMH is produced by the granulosa cells and seems to be a marker for quality and quantity of follicle reserves (Visser et al. 2006). In smaller follicles AMH inhibits the effects of FSH until follicles reach a size of 6 mm. Thereafter intra-follicular AMH concentrations decrease, leading to selection of the dominant follicle, which then contains no AMH. This represents one part of the autocrine factors operative in the selection of the dominant follicle. Numerous investigations show that the basal AMH levels are the best single marker reflecting the ovarian reaction to gonadotropin treatment within the framework of IVF measures.

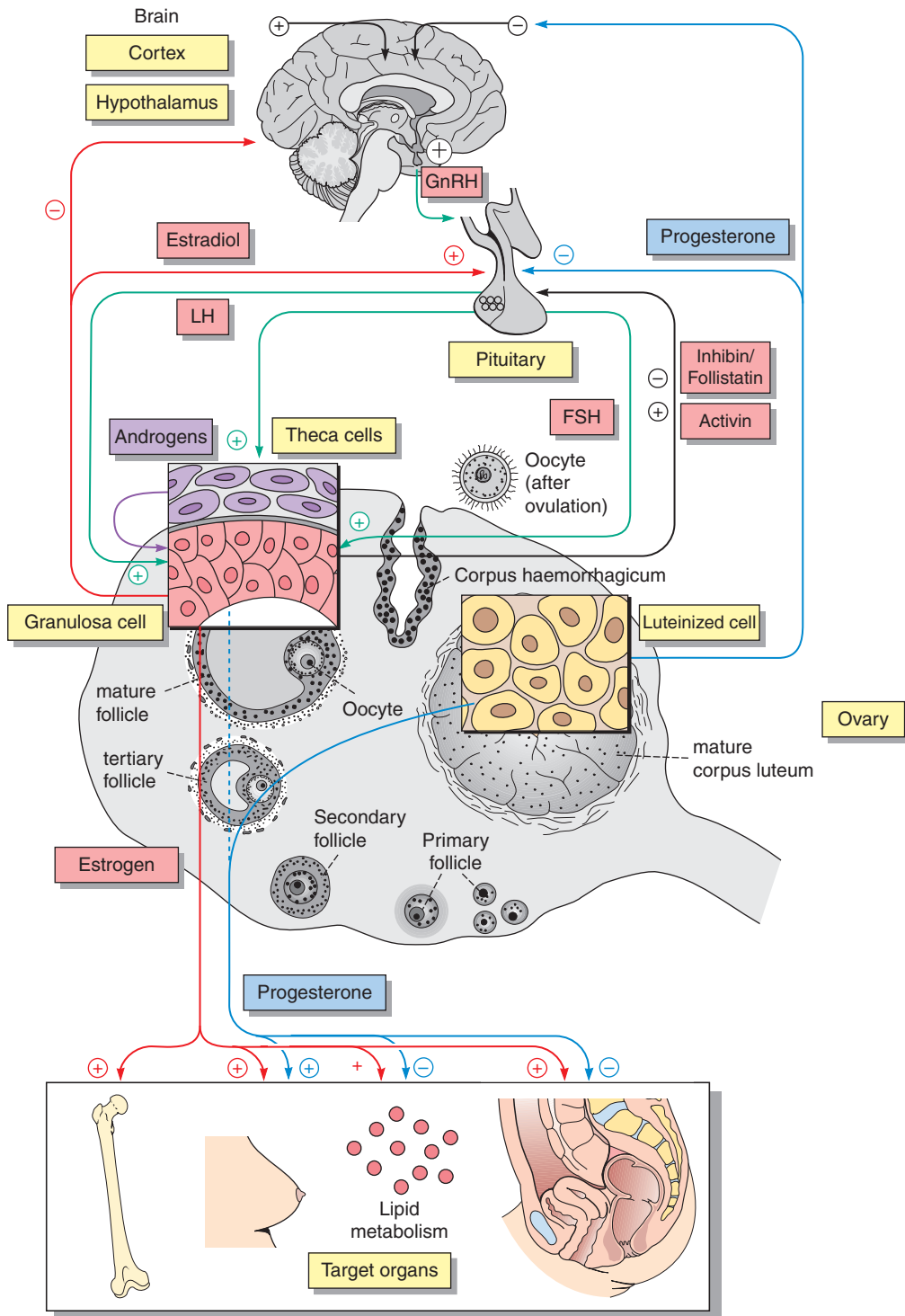

Fig. 20.5 Feed-back mechanism of hypothalamo-pituitary-gonadal axis and interdependence of hormone production in the structures of theca and granulosa cell layers. The schematic

drawing of the ovary shows the cyclic changes of the growing follicle (From Nieschlag et al. 1999)

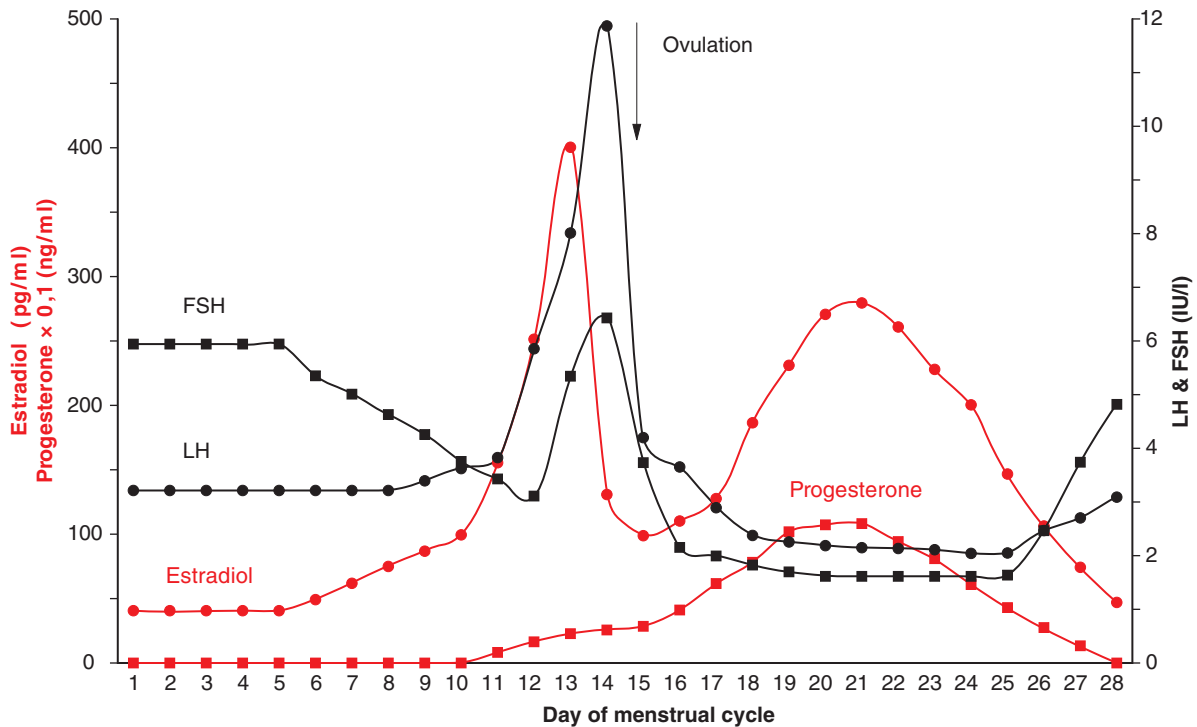

Fig. 20.6 Serum hormone concentrations during the menstrual cycle

During the investigation of 132 single follicle retrievals a limit of ≤ 1.26 ng/ml AMH (DSL-10-14400, Diagnostic System Laboratories Inc./Beckman-Coulter) was defined to distinguish between reduced (less than four ova retrieved) and normal reaction to IVF treatment. If the AMH level was below 0.5 ng/ml only fewer egg cells were retrieved despite maximal stimulation. However, no correlation between initiation of pregnancy and low AMH levels was found (Gnoth et al. 2008).

Routine application of sex steroids, in contrast to FSH or inhibin, is facilitated by the fact that AMH serum concentrations are largely independent of the cycle (Hehenkamp et al. 2006; Streuli et al. 2008).

The risk of overstimulation is signalled by elevated AMH concentrations (Nakhuda et al. 2006), presumably by the close connections between PCOS and elevated AMH secretion in the presence of increased numbers of follicles. Its determination can be applied both for judging the beginning of follicle maturity or prepubertal development as well as perimenopausal declining ovarian function. Since at present there is no uniform standard for assay systems, the method used must be known when judging results, as these may vary by a factor of 2.

20.2.2 Menstrual Cycle

20.2.2.1 Hormone Variations

The normal menstrual cycle can be divided into two phases: the follicular phase and the luteal phase. The first day of menstruation represents the first day of the cycle. The **follicular phase** lasts from the first day of menstruation until the pre-ovulatory LH surge. **Ovulation** occurs about 36–38 h after the LH surge. As discussed above, estradiol concentrations rise during follicular development and cause a reduction in FSH during the second half of the follicular phase. Conversely, the rise of estradiol has a positive feedback effect on the production of LH, and thus causes the mid-cyclic LH surge. In clinical practice, one can expect normal peri-ovulatory mono-follicular development with an estradiol concentration of 250 pg/ml in the serum. If during **ovulation** the ovum is extruded from the Graafian follicle, the remaining follicle develops into the **corpus luteum**, which produces progesterone, estradiol, and 17α -hydroxyprogesterone. The production of these hormones is stimulated by LH and choriogonadotropin. Progesterone secretion, combined with estradiol release, causes a negative feedback on

gonadotropin secretion, so that serum levels gradually decrease at the end of the luteal phase.

LH is secreted in **pulses**; the interval between peaks during the follicular phase ranges from 60 to 90 min. The amplitude and the frequency rise continually as mid cycle is reached. After ovulation, a lower frequency of 100–300 min is attained. The amplitude, however, rises in the luteal phase. The pulsatile secretion of LH is caused by the pulsatile secretion of GnRH. This discontinual release is very important for infertility therapy (see below).

Luteal phase. Progesterone secretion after ovulation has a central thermogenic effect on the hypothalamus. Therefore, graphic representation of measurement of basal temperature (basal body temperature chart) can provide a first impression of cycle quality. A rise in morning temperature usually occurs when progesterone levels exceed 3 ng/ml. This level is, however, not representative for normal luteal function, so that even a basal temperature curve with a normal hyperthermic phase must not necessarily have an underlying normal follicular development with a normal luteal phase. On the other hand, some women do not show a rise in basal temperature after producing the thermogenic pregnen-3 α -ol-20-one so that the absence of a hyperthermic phase must not necessarily imply anovulation. The basal body temperature chart (BBT chart) is thus no longer such a central diagnostic tool as it was when **follicular development and ovulation** could not be followed **sonographically**.

One must be especially careful not to use the BBT chart to set the time for insemination or timed intercourse, since the progesterone level described occurs 1–2 days after ovulation. The basal temperature curve should be used only in order to show variations of cycle quality and/or to time diagnostic procedures.

The second cyclic phase, the luteal phase, is relatively constant, and lasts 13–14 days in most women. The first half of the menstrual cycle can, however, vary greatly so that a menstrual cycle length between 21 and 35 days can be seen as normal, if the luteal phase remains constant.

Ovulation. The midpoint of the menstrual cycle is, naturally, ovulation, which must be recorded during

the evaluation of the menstrual cycle (see Fig. 20.7). Next to ovulation, cyclic changes in the uterine cervix and the endometrium occur. The changes in cervical mucus are of eminent importance in the evaluation of the sperm-mucus-interaction (see Fig. 20.8).

20.2.2.2 Changes in the Uterine Cervix and in Cervical Mucus Production

The cervical os is the entrance to the uterine cavity and consists of a system of folds and gaps called cervical crypts or endocervical glands. These endocervical glands have a secretory epithelium combined with ciliated epithelium in a ratio of 10:1. The secretory cells produce the cervical mucus and lie mainly in the upper part of the cervix, close to the uterus. The secretory activity of the cervical epithelium undergoes cyclic changes, and thus can give easily obtainable information on the stage of the menstrual cycle. Important information is yielded by the **amount of mucus**, the **width of the external cervical os**, the **Spinnbarkeit** of the mucus, and the **fern-like pattern** which develops when drying. A markedly improved prognosis for further therapy is seen when, under optimal circumstances, at least one spermatozoon per field is found postcoital at a magnification of 400x in at least six fields (Hunault et al. 2005). The amount of estrogen necessary to stimulate cervical mucus secretion varies in individual patients, and can vary from cycle to cycle. Cervical secretion is influenced by cervical infection, or after surgical procedures on the cervix. In some patients, cervical mucus production can be seen several days prior to ovulation; in other cases optimal cervix secretion occurs only a few hours before the LH surge. This must be taken into account when examining sperm-mucus-interaction. The development of the cervical factor can be judged using the **cervical index of Insler**. The technique of cervical mucus diagnosis is described in WHO 1999.

The uterine cervix and the cervical mucus are important for the ascent of the sperm, since they protect the sperm from the acidic vaginal environment. The uterine cervix provides an energy-rich substrate for the spermatozoa, facilitates the transport of the sperm from the vagina into the uterine cavity, provides a reservoir for the sperm in the cervical crypts, and also acts as a filter which separates normally formed sperm from those that are malformed. (For a review on the cervix see Joseph et al. 2006.)

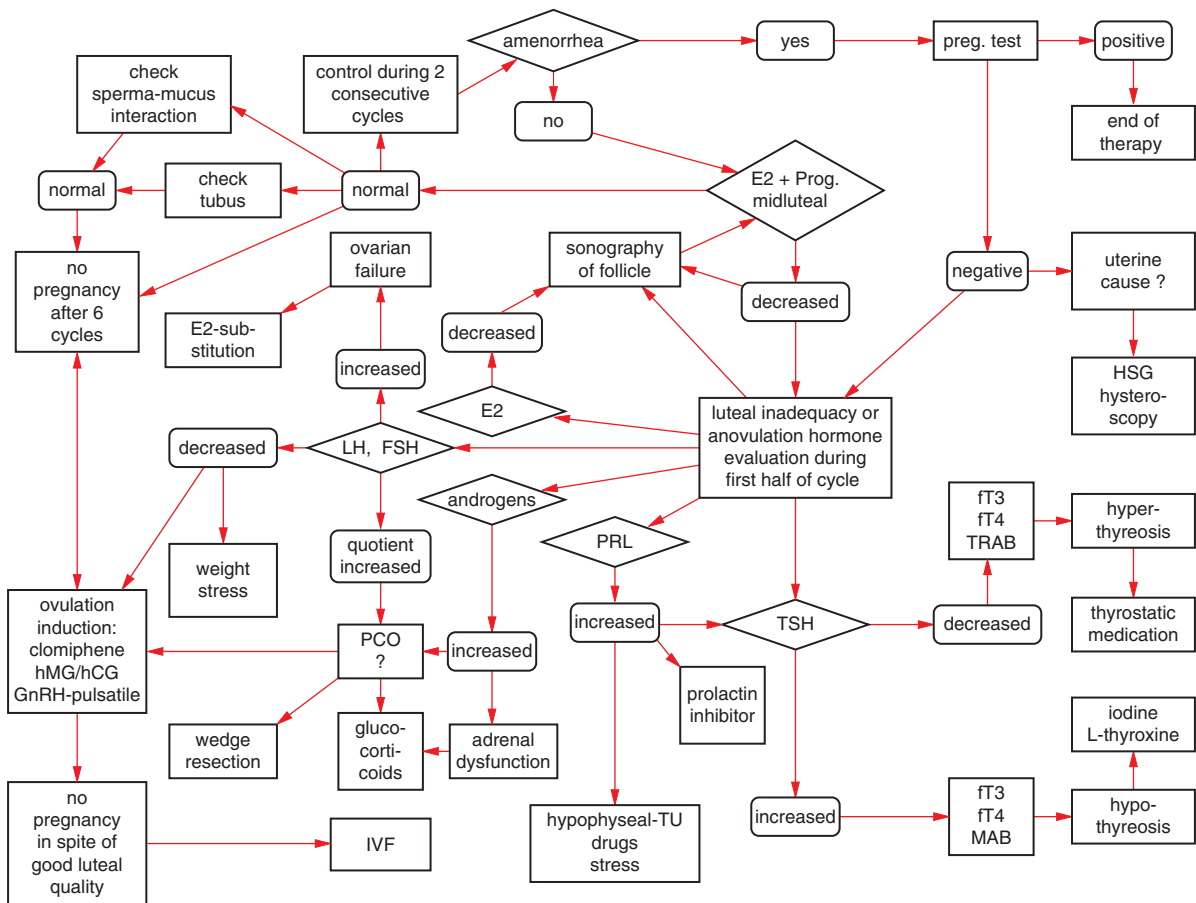

Fig. 20.7 Flow chart for the systematic *diagnosis of impaired follicular growth*. Only main areas are shown to facilitate readability. For more details see text

20.2.2.3 Endometrium

The cyclic changes of the endometrium, like the changes of the cervical factor, reflect cyclic ovarian function and are of eminent importance for the nidation of the fertilized oocyte. The endometrium becomes thicker during the follicular phase. Uterine glands are drawn out so that they become lengthened. This proliferation has given the first half of the menstrual cycle its name. After ovulation is complete, vascularization of the endometrium is increased. Edema develops, the glands of the endometrium become convoluted and begin to secrete a clear fluid. Consequently, this phase of the cycle is the so-called secretory or luteal phase.

If pregnancy does not occur, the corpus luteum regresses; hormonal stimulation of the endometrium

decreases and it becomes thinner. This adds to the curling of the arteries and focal necrosis occurs with local hemorrhage, which finally confluates and causes the menstrual flow. The cause of vascular necrosis is not known. Since the endometrium and the menstrual blood contain high concentrations of prostaglandins, and the infusion of prostaglandin $\text{PGF } 2\alpha$ causes necrosis of the endometrium, it seems possible that the prostaglandin release causes contraction of the blood vessels.

Seventy-five percent of menstrual blood is of arterial origin. It contains necrotic endometrial cells, prostaglandins, and a relatively high proportion of fibrinolysin. This is why usually no coagulation of the menstrual blood occurs. **Menstrual blood flow** usually lasts 3–5 days. A flow of 1–8 days can still be considered normal, unless a sudden change in the

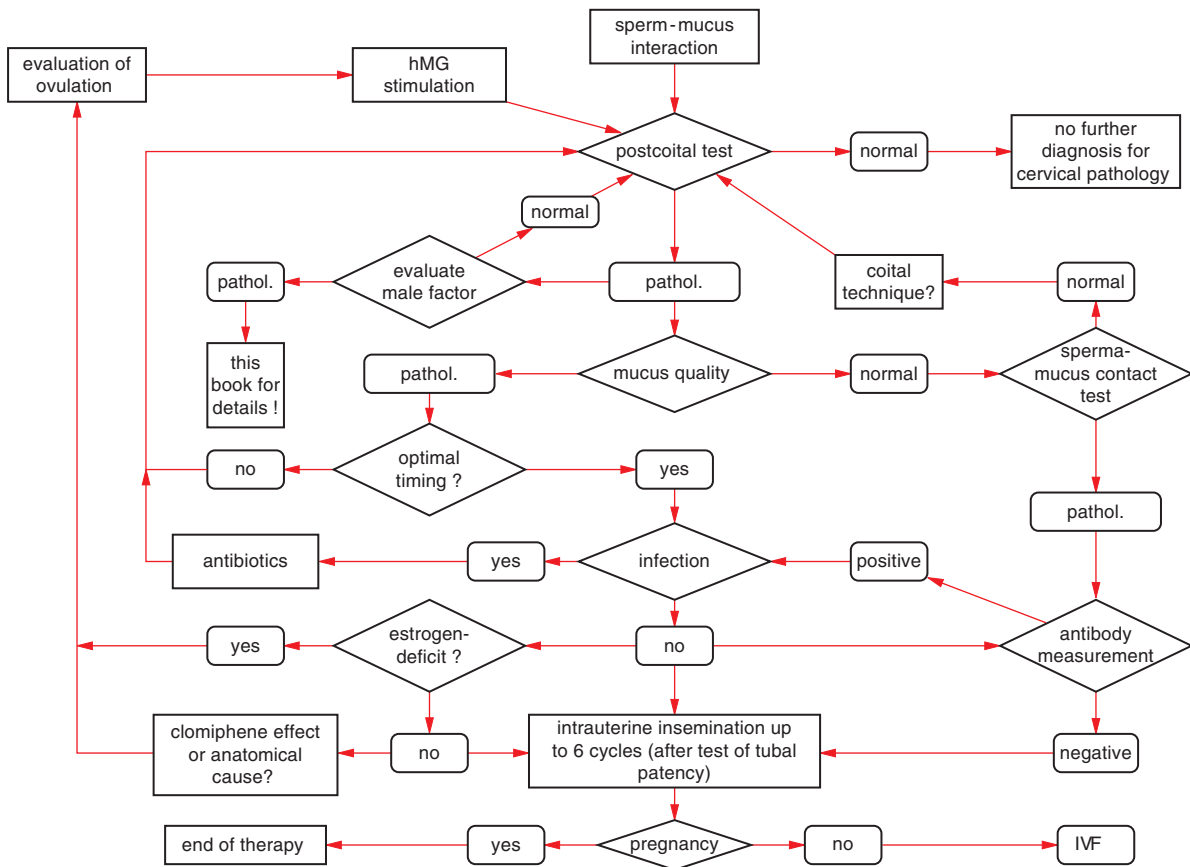

Fig. 20.8 Flow chart for the systematic *evaluation of sperm-mucus-interaction*. Only main areas are shown to facilitate readability. For more details see text

regular blood flow of a patient occurs. The average woman loses around 30ml blood per cycle. This varies between slight smearing and up to a blood loss of 80ml. If more than 80ml is lost, a pathological cause must be considered. After menstruation the endometrium once again develops from the remaining cells of the basal layer.

20.2.2.4 Vaginal Epithelium

The vaginal epithelium undergoes cyclic changes under the influence of estrogen secretion as does the endometrium (for a review see Schnell 1973). Although alterations in the vaginal epithelium can indicate cycle phases, these are subject to great variation, so that no clearcut cyclic diagnosis can be obtained through cytological analysis of the vaginal epithelium.

20.2.3 Diagnostic Evaluation of the Cycle

Essentially, evaluation of the female cycle requires the identification of optimal follicle maturation with ovulation, the development of a corpus luteum of good quality, as well as the physiological cyclic development of the endometrium which is necessary for nidation of a fertilized oocyte. It is important to remember that all the tests used in the evaluation of the cycle are indirect tests which have their limits.

20.2.3.1 Ultrasound

Although the basal body temperature chart, and the measurement of hormone concentrations in serum,

urine, and saliva give indirect information about ovulation and follicle maturation, ultrasound provides the possibility of following the **maturation of the follicle** and of ascertaining **ovulation**. Sonography thus constitutes a major component in the evaluation of the female factor in infertility, and is an indispensable tool.

Transabdominal sonography formerly used has been replaced by vaginal investigation. One major advantage is that the patient does not need to have a full bladder in order to provide an “acoustic window” through which the uterus and ovaries can be visualized. The vaginal probe lies in close approximation to pelvic structures so that a higher frequency can be used, leading to better resolution. In addition to classic sonography, measuring blood flow by Doppler sonography provides further information. Tissue damage due to energy produced by the ultrasound waves has never been shown during clinical use of this diagnostic tool. The negative effects which have been described in animal experiments require a higher output level than is used in clinical sonography.

The sonographic picture of an ovary is a rotational ellipsoid with a volume below 6 ml. Pathological changes can be seen quite readily. An important pathological picture is that of the **polycystic ovary (PCO)**, the pathophysiology of which will be discussed later. Typically, small follicles under 1 cm arranged like a string of pearls along with an ovary larger than normal with increased stroma are seen (Fig. 20.9). In addition to PCO syndrome, **endometriosis** and other **cystic changes** of the ovary can at times also be identified by ultrasound. Changes in the Fallopian tube such as a **sactosalpinx**, in which peripheral closure of the tube causes tubal dilation by intratubal fluids, can often be

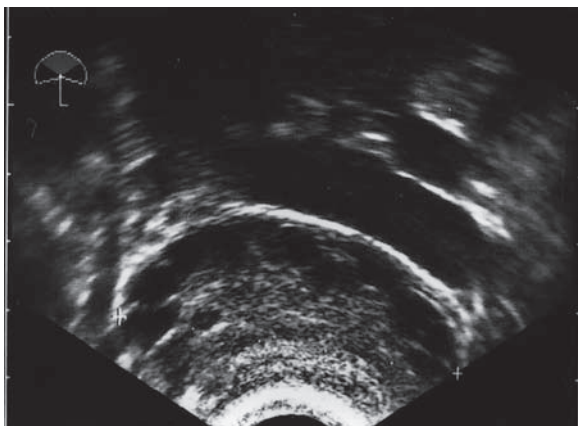

Fig. 20.9 Sonographic picture of polycystic ovary

diagnosed sonographically. If a sactosalpinx can be identified sonographically, women seeking pregnancy can benefit from salpinxectomy prior to IVF therapy (Strandell et al. 1999). The most important aspect of sonography in infertility therapy is, however, the evaluation of follicle growth in the normal and the stimulated cycle. Additionally, the endometrium can be evaluated and invasive procedures can be avoided.

Endometrial evaluation. Ultrasonographically, the endometrium presents as a relatively thin and homogeneous echo during the proliferative phase. During the late proliferative phase the thickness increases and measures about 5 mm in the anterior – posterior diameter. Edema of the stroma often causes an echo-dense edge of the uterine cavity, so that prior to ovulation often a multi-layered picture of the endometrium is seen. In the luteal phase the thickness of the endometrium lies between 7 and 9 mm.

Evaluation of the ovaries. In optimal cases, ultrasound resolution identifies ovarian structures up to 2 mm. As early as day 5 of the cycle, the dominant follicle is selected from the other primordial follicles. Between the 8th and the 12th day it has reached a diameter of 14 mm. During the last 4–5 days prior to ovulation, the diameter of the dominant follicle increases between 2 and 3 mm per day. The follicle thus reaches a diameter of 16–28 mm. The variable size does not allow the prediction of the time of ovulation on the basis of ultrasound alone, so that ultrasound diagnosis should always be combined with determination of estradiol and LH levels during the pre-ovulatory phase (Queenan et al. 1980). The prediction of the LH surge on the basis of ultrasound is quite inaccurate, is equal to that of predicting the surge on the basis of the day of the cycle (Buttery et al. 1983). Transvaginal ultrasonography in combination with the endocrinological methods can, however, double the fertility rate during insemination procedures.

After the LH surge, theca tissue becomes increasingly vascularized and the granulosa layer separates from the theca cells. This process can be visualized sonographically approximately 24 h prior to begin of ovulation and is usually accompanied by a discrete rise of plasma progesterone levels. Additionally, the cumulus oophorus can be seen sonographically in about one fifth of all follicles larger than 18 mm. If the vascular supply of the follicle, which can be ascertained by color Doppler sonography, is also taken into consideration, the quality of the egg cell can be evaluated even

better and conception rates can be improved (Bhal et al. 1999).

About 25% of patients show ultrasonographically demonstrable fluid in the culdesac after ovulation. The transition from follicle to corpus luteum is seen by an indentation of the capsule and an increase of intrafollicular echo-density. Sometimes, however, the corpus luteum is a rather solid structure which cannot readily be identified by ultrasound.

LUF syndrome. Impaired ovulation, which is usually caused by problems of follicular maturation, is often a cause of infertility. This is frequently diagnosed by ultrasound examination, since other objective tests are often normal. A typical clinical picture is that of the syndrome of **luteinization of the unruptured follicle** (LUF syndrome) which was first discussed in 1967 (Kase et al. 1967). In this clinical entity, the hormone profiles are in a normal range and yet a rupture of the follicle does not occur. About 5% of all normal cycles are said to occur in this form. However, the significance for infertility is not yet proven since this syndrome is not one of continuous anovulation. Ultrasound examination can lead to diagnosis when 36h after the LH surge the cystic follicle remains unchanged and no shrinkage can be shown. Under clomiphene stimulation the LUF rate may increase by more than 25% (Qublan et al. 2006).

A menstrual cycle can be anovulatory even if menstruation occurs at the proper time. In anovulatory cycles, however, usually low progesterone levels are found in the luteal phase. The rise in estradiol levels in the luteal cycle is also reduced, so that the measurement of progesterone and estradiol in the second half of the menstrual cycle gives important information pertaining to ovulation. An exception is, of course, the above-mentioned LUF syndrome.

In addition to the diagnostic evaluation of follicle growth and corpus luteum development, ultrasound can be used in the luteal phase to determine the quality of the endometrium. Deichert et al. (1986) compared the endometrial thickness with hormonal parameters, and concluded that endometrial thickness below 10 mm is an indication for hormonal stimulation or substitution in order to optimize implantation of the blastocyst. In a prospective cohort study comprising 1,186 women seeking treatment for infertility, no correlation between thickness of the endometrium and pregnancy rate following IVF or ICSI could be found. Conversely, the pregnancy rate was found to be significantly lower

in women with a thin endometrium undergoing intrauterine insemination (DeGeyter et al. 2000).

20.2.3.2 Endometrial Biopsy

Most gynecologists consider the histological examination of an endometrial biopsy the primary method for judging luteal quality. Classically, the examination is carried out just before onset of the menstrual flow. Ideally an endometrial strip is obtained through outpatient curettage on day 27 or 28, or, in a longer menstrual cycle, 1–2 days before the beginning of menstrual flow. The endometrial strip should enclose all layers of the endometrium up to the myometrium, so that the functional and basal layer may be examined. For evaluation of the endometrial biopsy, the date of the next menstrual period must be known. This date is set equal to day 28. If the biopsy is obtained 2 days earlier, then the endometrium should show the histological picture of the 26th cyclic day. If the histological picture deviates by more than 2 days, luteal insufficiency is diagnosed. Although this is a standard method, in some patients serial endometrial biopsies at different times in the menstrual cycle show a pathological development in the early luteal phase which becomes normal shortly before the beginning of menstrual flow. This indicates that an endometrial biopsy obtained at an earlier time during the luteal cycle may be of diagnostic importance, since the structure of the endometrium on day 20–24 of the cycle is important for the blastocyst. Of major importance is the synchronous development of the endometrial glands and stroma. (see Blasco 1994).

20.2.3.3 Progesterone Levels and Evaluation of Luteal Quality

The endometrial biopsy is the standard method for evaluation of luteal quality in clinical research. This diagnostic test is, however, not usually used in the clinical setting because of its invasive character. Instead, the **measurement of progesterone and estradiol** in the luteal phase is usually applied. Since progesterone secretion is pulsatile, this method is often criticized as having a high discrepancy rate. However, a single mid-luteal progesterone serum level below 10 ng/ml (31.8 nmol/l) or the sum of three progesterone levels

below 30 ng/ml (95.4 nmol/l) are better correlated with the integrated progesterone concentration in the luteal phase than the basal body temperature chart, the length of luteal phase, or the pre-ovulatory diameter of the follicle. According to some data, **serum progesterone levels predict the quality of the luteal phase better than the endometrial biopsy** (Jordan et al. 1994).

Progesterone is the primary hormone of the corpus luteum and of eminent importance for nidation and the maintenance of early pregnancy. A lutectomy in the 7th week of pregnancy causes miscarriage (Csapo et al. 1973). The removal of the corpus luteum during the 9th week of pregnancy, however, causes only a transitory drop in progesterone serum levels and pregnancy continues to develop. If an early decrease of progesterone concentration in the 7th week of pregnancy is compensated by substitution of this hormone, pregnancy continues to develop.

Pregnancies in women with ovarian insufficiency who become pregnant after oocyte donation can be supported by progesterone substitution during the 1st weeks of pregnancy. Serum levels of 20 ng/ml are sufficient. This serum level is obtained by giving 50 mg progesterone daily. Physiologically, the daily production of progesterone in the luteal phase is about 25 mg. A midluteal progesterone concentration under 3.1 ng/ml in a natural cycle signals anovulation. The median progesterone levels in conceptive cycles are around 17.8 ng/ml, although in extreme cases single conceptions also occur at lower levels around 3.8 ng/ml. In clinical practice, a midluteal progesterone level 8 days post-ovulation greater than 10 ng/ml demonstrates sufficient luteal function (review in Wathen et al. 1984).

The daily fluctuations of progesterone serum levels (shown in Fig. 20.10), lead one to expect that statistically about a third of all progesterone measurements will lie below 10 ng/ml, even though a normal luteal phase is present. The measurement of progesterone in combination with estradiol is, however, a clinically relevant diagnostic tool which gives a first impression of follicular maturation when estradiol and progesterone are determined on the eighth post-ovulatory day. Within the above-mentioned limits, it is then possible to establish whether ovulation has occurred. Several menstrual cycles must be monitored to show whether the patient has a continual restriction of her luteal quality or not. In such a case, the cause of impaired follicle maturation must be obtained before deciding on further therapy.

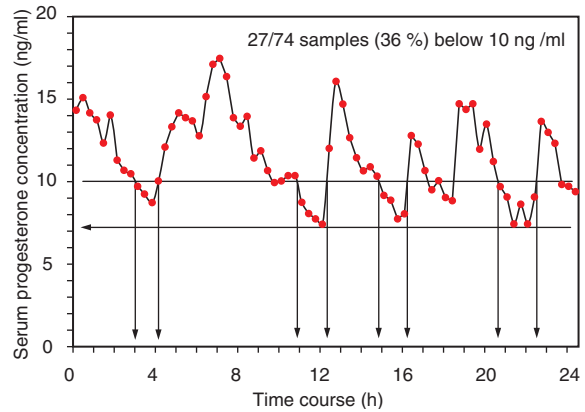

Fig. 20.10 Fluctuations in serum progesterone concentrations during a 24-h period (Adapted from McNeely and Soules MR (1988). Reproduced with permission of the publisher, the American Society for Reproductive Medicine [formerly The American Fertility Society])

20.2.4 Impairment of Follicle Maturation

The extreme form of impaired follicle maturation is that of anovulation with amenorrhea, although these cases are far less common than those in which the menstrual cycle remains unimpaired (Fig. 20.11).

20.2.4.1 Amenorrhea

Amenorrhea is a symptom that occurs in a large group of disorders, resulting in the absence of menstruation. Amenorrhea can be a result of dysfunctional

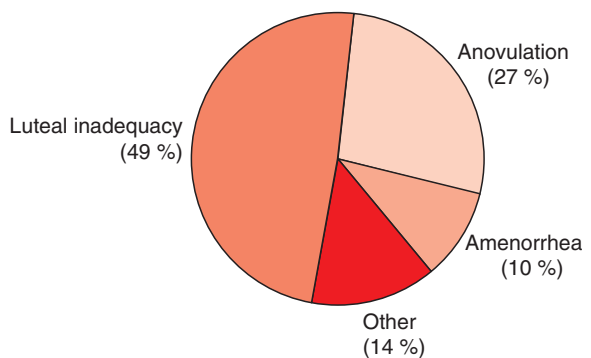

Fig. 20.11 Relative proportion of impaired follicular growth among patients of an infertility clinic according to severity of disturbance (Adapted from Bohnet 1985)

endometrium with normal hormone levels or it can be due to disturbance of the hypothalamo–pituitary–gonadal axis with a normal endometrial reaction following exogenous hormone substitution. For scientific purposes, amenorrhea can be classified according to WHO criteria (Fig. 20.12).

Amenorrhea can be either primary or secondary. This classification says nothing about the cause of amenorrhea, since the same disorder can result in either primary or secondary amenorrhea. **Primary amenorrhea** is defined as the absence of menses by age 16. This is clinically important, since in 35–40% of the patients

primary amenorrhea is a result of **primary ovarian insufficiency** or urogenital dysgenesis. **Secondary amenorrhea** is the absence of menstruation for at least 4 months in a woman who had had at least one spontaneous menstrual cycle in her history.

Primary amenorrhea. Patients with primary amenorrhea do not often present in infertility practice, since most of the causes are of genetic origin and have been diagnosed in puberty or in early adulthood. The primary cause of primary amenorrhea is **Turner syndrome** with the classical karyotype XO. In extremely rare cases, patients with Turner syndrome do have a

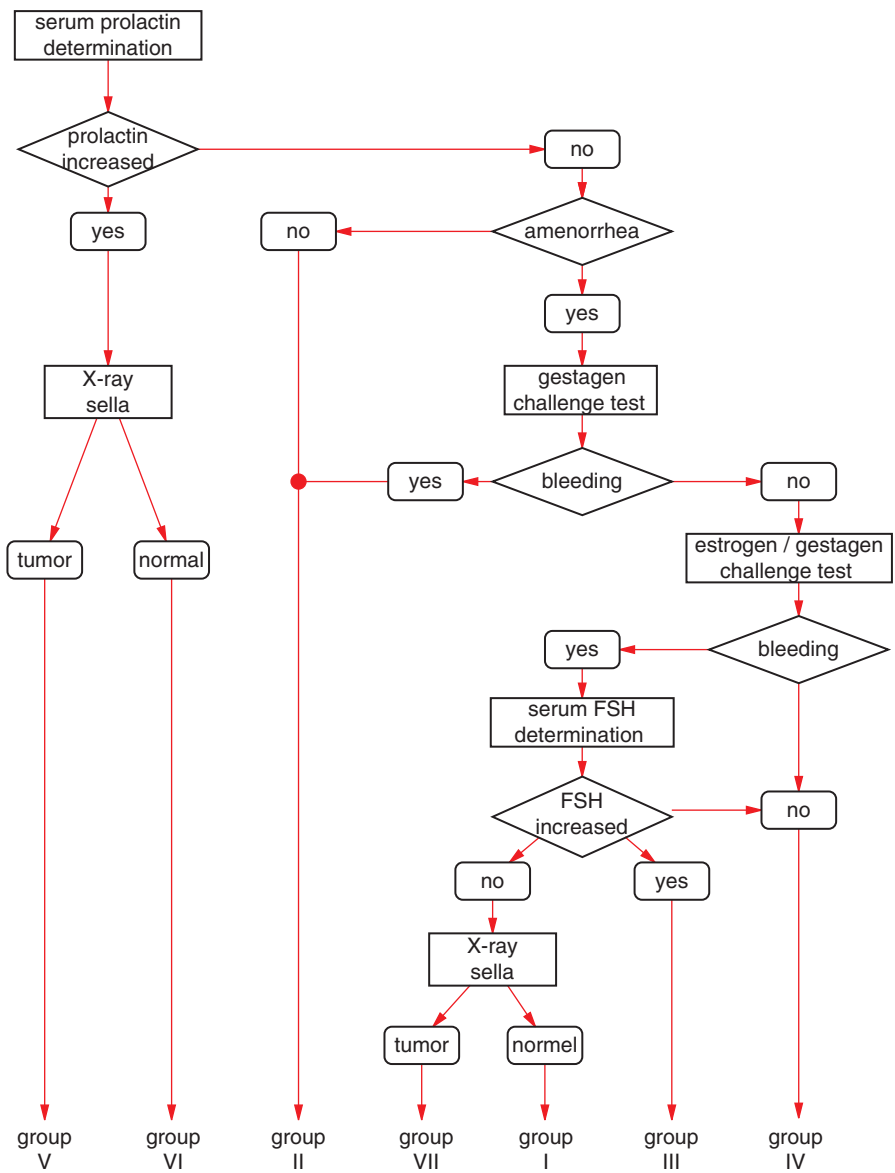

Fig. 20.12 Classification of impaired ovarian function according to WHO guidelines

menstrual period and develop secondary amenorrhea as a result of ovarian insufficiency.

The second most common cause of primary amenorrhea is Mullerian dysgenesis, which is characterized by the congenital failure of the Fallopian tubes, the uterus and/or the vagina to develop. An example is **Rokitansky-Küster-Hauser syndrome**, which is a clinical entity with vaginal aplasia, a rudimentary uterus and normal fallopian tubes. In Mullerian dysgenesis, ovarian function is intact, so that the gonadotropins and sexual steroids show normal levels. Diagnosis is obtained after clarification of the anatomy through a gynecological examination, imaging diagnostics, hysteroscopy, and possibly diagnostic laparoscopy.

Patients who are underweight in relation to height can present with primary amenorrhea. The importance of body weight for normal development of the hypothalamic pituitary ovarian axis is seen in the hypothesis of critical body weight, which postulates that a particular body weight must be obtained in relation to height before menstruation can begin (for review see Knuth et al. 1977). In addition to these common causes of primary amenorrhea, a number of congenital and exogenous defects can disrupt the hypothalamic pituitary axis, which results in a defect in hormonal regulation analogous to that which has been described in men.

Secondary amenorrhea. Secondary amenorrhea plays a much more important role in infertility practice than primary amenorrhea described above.

A major cause of secondary amenorrhea is pregnancy. This fact has to be considered in every patient presenting with this symptom.

Even if a patient has been diagnosed with another cause of amenorrhea, it must be remembered that pregnancy can develop out of an amenorrheic phase, and that menstruation need not have occurred. This is often seen in the effective therapy of hyperprolactinemic amenorrhea.

A rare cause of amenorrhea are **intrauterine synechia** which can cause **Asherman's Syndrome**, in which a destruction of the endometrium has occurred with a resulting internal adhesion of the uterine cavity. This is usually caused by a complicated dilatation and curettage such as in infected abortion, or extremely vigorous curettage, but the syndrome can also occur after unspecific

or tuberculous endometriosis. Patient history is important for diagnosis. A suspicion of Asherman's syndrome can be strengthened by normal estradiol and progesterone levels in the luteal phase, or through continuing amenorrhea after hormonal stimulation. Diagnosis is obtained through hysteroscopy or, with limitations, by hysterosalpingography. Therapeutically, adhesiolysis of the uterine cavity must be followed by sequential estrogen and progesterone substitution in the form of a pseudo-pregnancy. Simultaneously, an IUD can be used in order to deter the development of new adhesions while the endometrium regenerates.

If Asherman syndrome and a hysterectomy can be ruled out, the cause of secondary amenorrhea in the remaining cases which present in infertility practice can be divided into those with hypothalamic and pituitary defects, and those with ovarian failure.

Hypothalamic amenorrhea is a diagnosis of exclusion and represents a functional defect of the secretion of gonadotropins caused by rapid weight loss, rapid weight gain, systemic diseases, extreme physical activity and/or extreme stress situations (see Sect. 20.1.7). Hypothalamic amenorrhea is the extreme case of impaired follicle maturation, in which luteal insufficiency or anovulation with normal menstruation occur because of the above-named causes prior to the development of secondary amenorrhea.

Hyperprolactinemia is often a cause of amenorrhea. Here again amenorrhea is the extreme result of hyperprolactinemia; luteal insufficiencies and anovulation with normal menstruation are seen much more commonly. In hyperprolactinemia one must think of a **pituitary adenoma** or **hypothyroidism** as causative factors.

An important cause of impaired follicular maturation, and thus of amenorrhea, is the **polycystic ovarian syndrome** (PCO syndrome). Primarily one thinks of an obese patient with hyperandrogenic symptoms and the typical picture in ultrasound diagnosis described above. The so-called PCO-syndrome or Stein-Leventhal-syndrome is, however, only an endpoint of a group of various different pathological disturbances and represents a disruption of the cyclic ovarian function with elevated androgen/ estradiol levels and an unbalanced LH/FSH ratio.

In addition to these three common causes of secondary amenorrhea and impaired follicle maturation, rare causes of hypothalamic tumors and cysts, and infiltrative diseases of the hypothalamus or the pituitary gland such as tuberculosis, sarcoidosis or

histiocytosis X exist. These are, however, rarities even in specialized centers.

In contrast to dysfunction of the hypothalamo-pituitary axis, which can be readily treated, the common diagnosis of primary ovarian failure is usually the endpoint of infertility workup in countries where oocyte donation is prohibited by law, since atresia of the primordial follicles results in an absolute loss of oocytes. Premature ovarian failure is characterized by the loss of ovarian function before the age of 35 years. This can be a result of chemotherapy or radiation therapy or also may have an immunological cause.

20.2.4.2 Hyperprolactinemia

The existing relationship between disturbed reproductive function and lactation has long been known. Designation names are found in the older literature such as the Chiari-Frommel syndrome (postpartal amenorrhea with persisting lactation); Argonz-Ahumada-Castillo syndrome (galactorrhea and reduced urinary estrogen concentrations) and Albright-Forbes syndrome (amenorrhea, reduced urinary FSH concentrations and galactorrhea). After 1972, when it first became possible to measure human prolactin, all of these syndromes were found to have a common denominator, namely that of hyperprolactinemia.

In contrast to the other hormones of the pituitary gland, prolactin is mainly regulated through a hypothalamic inhibitory factor. The main inhibitor is dopamine. In rat experiments 70% of prolactin secretion can be inhibited through a dopamine infusion, if the androgenic dopamine synthesis has been blocked beforehand. γ -aminobutyric acid (GABA) is another inhibitory factor which, however, is weaker in its effect than dopamine.

A number of stimulating substances have also been found which are important for the short-term secretion of prolactin. These substances include thyrotropin-releasing hormone (TRH), vasoactive intestinal peptide (VIP) and angiotensin. Serotonin precursors cause a significant rise in prolactin concentrations. In contrast, the blockade of serotonin inhibits prolactin secretion. Endogenous opioids increase prolactin secretion by inhibiting dopamine synthesis and reducing dopamine secretion. Histamine and substance P both stimulate prolactin secretion, although the exact regulatory mechanisms are not yet known.

The differentiated regulation of prolactin secretion explains the various causes of hyperprolactinemia. A slight rise in serum prolactin concentration can be a symptom of central neurogenic dysregulation, such as the stress reaction, in the form of a functional dysregulation. Hyperprolactinemia can be due to the ingestion of a variety of drugs. **Primary hypothyroidism** can also be the cause of hyperprolactinemia. Even hormonally inactive tumors close to the pituitary gland can cause hyperprolactinemia through changes in portal circulation. Very high prolactin concentrations are usually, however, caused by prolactin secreting tumors (**prolactinoma**) (for review see Schlechte 2003).

About one third of all patients with secondary amenorrhea have a **pituitary adenoma**. In patients with simultaneously occurring galactorrhea, 50% of those women exhibit an abnormal cone view of the sella turcica. The infertility in these patients is related more closely to hyperprolactinemia than to tumor size except, of course, in extreme cases.

A prolactinoma causes a rise in hypothalamic dopamine concentration, which in turn causes a negative feedback on GnRH secretion. This causes a decrease of gonadotropin secretion, which then results in anovulation. Therapeutically, one must thus either remove the adenoma or lower the prolactin concentration by giving a specific inhibitor.

Since not all cases of hyperprolactinemia develop the typical symptoms, a check of the prolactin serum concentration belongs to the routine diagnostic workup of female factor infertility.

A blood sample is best taken during basal conditions in the early morning hours. Since this is usually not obtainable in clinical routine, one must consider the circadian rhythm and subjective situation during which the blood sample was drawn when evaluating the serum level obtained. If hyperprolactinemia is diagnosed, then the level needs to be checked in a second sample. Prolactin serum levels show great fluctuations which can be caused by a variety of physiological stimuli such as nutrition and sleep behavior, stress, and physical activity. The intake of prolactin-stimulating drugs must also be considered.

Before beginning treatment of a slight to medium hyperprolactinemia (lower than 15 ng/ml) with a

prolactin inhibiting drug the TSH level (less than $3\mu\text{U/l}$) should be obtained from the same blood sample in order to rule out thyroid dysfunction. In this case, treatment of the thyroid may be pertinent. If the prolactin concentrations exceed 50ng/ml without known physiological stimuli, one should perform an MRI scan of the hypothalamic-pituitary area.

The probability of a pituitary adenoma is about 1:5 when prolactin serum concentrations are above 50ng/ml . The probability rises to 1:2 if serum concentrations exceed 100ng/ml . In cases with even higher prolactin concentrations, almost all patients have a microadenoma. When levels rise above $1,000\text{ng/ml}$ a macroprolactinoma is very probable.

Pituitary adenoma. Prolactin-secreting adenomas are the most frequent tumor of the pituitary gland. About 50% of all pituitary adenomas which are found in male and female autopsies fall into this group. Nine to 72% of autopsied humans have a prolactinoma, with the highest incidence occurring in the 6th decade of life. There is no difference in incidence between male and female patients, although clinical symptoms are seen much more commonly in women. Hyperprolactinemia can be diagnosed five times more commonly in women than in men.

When other causes for hyperprolactinemia have been ruled out, suspicion of a prolactinoma can be confirmed by an MRI scan. Microadenoma ($<10\text{mm}$ diameter) are distinguished from macroadenoma.

The **MRI scan** is superior to a CT scan for identifying microadenomas, and is the best diagnostic test to rule out an adenoma. An ophthalmological checkup is only necessary when the adenoma is greater than 10mm in diameter.

Empty-sella syndrome. A radiologically abnormal sella can be seen in the **empty-sella syndrome**. In this case, the diaphragma sellae is congenitally malformed. This defect causes an expansion of the subarachnoidal space into the pituitary fossa, which results in a bilateral displacement of the pituitary gland causing the sella to appear empty. This syndrome is not rare. It is seen in 5% of all autopsies, 85% of which are female. The empty sella syndrome is usually a benign syndrome, whereas radiologically sometimes the misdiagnosis of a tumor occurs. In these cases surgical intervention must be prohibited. After the diagnosis has been made, an annual check of prolactin concentrations should be performed. If a hyperprolactinemia is found, treatment with a prolactin inhibitor may be started (for review see Speroff et al. 1994).

In the recent past, a direct inhibitory effect of elevated prolactin levels on follicular maturation has been suspected. Follicular atresia, anovulation, insufficient development of the corpus luteum, and a premature luteolysis were presumably caused solely by the pathologically elevated prolactin concentrations. These mechanisms have been established in the rat model, but it is not yet clear if the same apply in humans.

Lately an increasing number of experts are believing that the findings described above are caused by hypothalamic changes. Peripherally measured hyperprolactinemia appears to be secondary to a central nervous dysregulation caused primarily by an alteration in the pulsatile GnRH pattern. The changes in the GnRH pattern deter normal gonadotropin secretion, and thus follicular maturation. Richardson et al. (1985) showed that rhesus monkeys with hypothalamic lesions treated with exogenic pulsatile GnRH showed normal postovulatory plasma progesterone concentrations independent of the prolactin serum level. A correlation between progesterone and prolactin levels in a group of women with luteal insufficiency could not be shown when compared with normal control groups (for review see Soules 1993).

Even if it is not entirely clear whether there is a direct effect of elevated serum prolactin concentrations on follicular maturation, or if the origin lies in an alteration of gonadotropin secretion, hyperprolactinemia is undoubtedly a cause for female infertility and should thus be treated.

Surgical and radiological treatment of hyperprolactinemia. In the past, before dopamine agonists were available for the treatment of hyperprolactinemia, patients with pituitary adenomas and other similar tumors were operated or received radiation therapy. Data on these patients show that transphenoidal neurosurgery resulted in ovulatory menstrual cycles in 80% of patients with microadenomas, but only in 40% of those with macroadenomas. In 30% of the patients with microadenomas, however, a tumor reappeared. The recurrence rate of macroadenomas was around 90%. Severe side-effects such as panhypopituitarism and liquorfistula occur and restrict the indication for neurosurgical treatment.

The results of radiation are inferior to those of surgery, so that this form of therapy should only be used for postoperative treatment of larger tumors which show new growth, and do not respond to pharmacological treatment.

In the past, it was feared that a treated pituitary adenoma could expand during pregnancy. This is extremely uncommon in microadenomas (<1%) where even breast feeding may be allowed without having to fear the stimulation of a pituitary adenoma. The risk of pituitary adenoma growth during pregnancy rises, of course, with the size of the adenoma. In the case of a macroadenoma with supracellar infiltration a 15–35% increase in tumor size is likely during pregnancy, so that if motherhood is desired, reduction of the tumor is recommended. In these cases ophthalmological checkups during pregnancy at least every 3 months, combined with measurements of serum prolactin should be performed. When the prolactinoma increases during the course of pregnancy bromocriptine should be considered.

Since neurosurgery during pregnancy is, as in the past, only performed when acute symptoms occur, these new lenient recommendations seem consistent. Traditional monitoring can, however, be reassuring both to the patient and the physician.

Pharmacological treatment. The development of synthetic prolactin inhibitors represented an important step in the treatment of hyperprolactinemia. The introduction of bromocriptine in the 1970s allowed the direct treatment of hyperprolactinemic amenorrhea and infertility for the first time.

- **Bromocriptine** is a lysergic acid derivative with dopamine agonistic activity, which inhibits prolactin secretion by binding at the dopamine receptor. When pregnancy is desired it is the medication of choice. Depending on the prolactin concentrations, a dose of 0.625–2.5 mg in the evening may be enough to normalize the prolactin level. In patients with pituitary adenomas, 10 mg or more daily may be needed.
- Although this form of treatment is very effective, adverse reactions may cause poor compliance. Headaches and nausea often occur during the beginning of treatment. Dizziness is caused by orthostatic hypotension, since noradrenergic neural transmitters are interfered with. These effects can be minimized by slowly increasing the dosage. Treatment should always begin with 0.625 mg taken in the evening. The dosage may be increased every 3 days by 1.25 mg in the morning until the final dosage is reached. Vaginal application of uncoated tablets of bromocriptine can markedly reduce side-effects of the drug (Ginsburg et al. 1992). Since this form of application results in a higher rate of

resorption and eliminates the first-pass effect of the liver, a lower daily dosage can achieve the same effects. This is often clinically employed.

Research data show that about 80% of patients with hyperprolactinemic amenorrhea regularly menstruate as a result of treatment with bromocriptine.

In 50–75% of patients with pituitary adenoma, treatment with dopamine agonists has significant influence on tumor size. Neoplasias were no longer detectable in 25–30% of these cases receiving long-term treatment. In view of this aspect, pharmacological treatment of a pituitary adenoma should be the method of choice. Transphenoidal neurosurgery should only be considered if bromocriptine therapy does not reduce tumor size. This is also relevant in cases where prolactin levels return to normal. In this case, evidence points to a non-functional tumor which causes hyperprolactinemia merely by disrupting the dopamine supply in the pituitary stalk.

- If pregnancy occurs, bromocriptine treatment is usually discontinued. Three large-scale studies have shown that even with continuation of therapy, no negative consequences for the fetus have to be feared (Holmgren et al. 1986).
- A number of new prolactin inhibitors are now available. **Lisuride** has a higher activity, a longer half-life and is better tolerated by some patients, so patients unable to continue bromocriptine therapy can switch to lisuride.
- **Metagoline** is an antiserotonergic substance which acts via a non-dopaminergic mechanism, and can be tried as an alternative product (Bohnet et al. 1986).
- A new substance is **Cabergoline**, a prolactin inhibitor, which only needs to be taken one to two times per week, and which seemed to be better tolerated than bromocriptine in first clinical trials.

Hyperprolactinemia which is caused by thyroidal dysfunction should be treated through adequate treatment of the thyroid gland.

20.2.4.3 Polycystic Ovarian Disease

The different entities which are combined under the term polycystic ovarian disease are, next to hyperprolactinemia, the most important cause of anovulatory

infertility. A good review of the complex disease recently appeared (Norman et al. 2007). The clinical picture varies from the physiologically normal patient with an anovulatory menstrual cycle to the adipose, hirsute and oligoamenorrhic patient who was first described by Stein and Leventhal.

Depending on the investigator's point of view, three different diagnostic key elements are emphasized: hyperandrogenemia, chronic anovulation and polycystic ovaries verified by ultrasound. Originally the typical alterations of the ovaries, which however, are not obligatory, led to the description of the disease. At present two diagnostic systems define PCOS: the 1990 definition of the National Institutes of Health (NIH) requires chronic anovulation plus clinical or laboratory symptoms of hyperandrogenemia. In contrast, the criteria agreed upon in 2003 in Rotterdam specify two or more symptoms: chronic anovulation, clinical or biochemical signs of hyperandrogenemia and/or polycystic ovaries (Rotterdam ESHRE/ASRM-Sponsored PCOS Consensus Workshop Group 2004).

In the past these typical ovarian alterations were assumed to cause PCOS; the underlying pathophysiological mechanism was misunderstood. In fact, the anatomical situation results from a hormonal dysregulation perpetuated and aggravated in a vicious circle. These changes can be caused by hypothalamic, hypophysal, ovarian and/or adrenal dysfunction which are all often combined with oligo- or amenorrhea, hirsutism, and infertility. The characteristic polycystic ovary is seen when no ovulation occurs during a longer period of time. "Polycystic ovarian disease" thus is not a diagnosis, but a prototypical form of chronic hyperandrogenic anovulation.

Recent studies show that little-known disturbances of androgen secretion and dysfunctional regulation of steroid biosynthesis are at fault which, according to analysis by the Androgen Excess Society, is primarily caused by excessive androgen biosynthesis, increased androgen intake or increased androgen metabolism (Azziz et al. 2006).

The typical ovarian morphology with multiple small subcapsular follicles is frequent, but in no way adequate for diagnosis. Many women with no hormonal dysfunction have more than eight subcapsular follicular cysts of

less than 10 mm. Epidemiological studies show that about 25% of all premenopausal women demonstrate typical signs for polycystic ovarian disease in ultrasound examination. Even women who take oral contraceptives can show the typical ultrasound picture in 14% of all cases (Clayton et al. 1992). The prevalence of disturbances associated with anovulation is only between 5% and 10%.

Three essential characteristics are required to arrive at a correct diagnosis.

Hyperandrogenemia. Hyperandrogenemia is the predominant characteristic of a PCO syndrome and occurs in most cases. Increased androgen can be diagnosed via clinical signs, biochemical parameters or a combination of these. **Hirsutism** is found in over 60% of all women with PCOS. Differences due to ethnicity must be taken into consideration.

Laboratory parameters are usually derived from total serum testosterone and SHBG levels, in order to objectify an increased androgen fraction. About 20–40% of all PCOS patients show no clear signs of hyperandrogenemia (Chang et al. 2005). Many testosterone assays in the routine lab are not able to deal with the relatively low values for women and cannot discriminate between patients with apparently normal values and those with hyperandrogenemic symptoms.

Chronic anovulation. A diagnosis of anovulation is less arbitrary than evidence of hyperandrogenemia. When the cycle exceeds 35 days or menstruation fails to take place for more than 3 months, oligoamenorrhea or amenorrhea is present. Regular cycles, however, do not exclude anovulation so that determination of progesterone in the second half of the cycle is mandatory for diagnosis. If chronic anovulation is given, prolactin, LH or FSH must be measured additionally.

Polycystic ovaries confirmed by ultrasound. In recent years technological progress, especially in resolution of image technology, has considerably improved the measurability of ovarian alterations. Earlier standards based on abdominal measurements were adapted to the gynecological situation. Currently more than 12 follicles between 2 and 9 mm diameter during the follicular phase or ovarian size exceeding 10 ml are signs of a polycystic ovary. Measuring AMH (anti-Müller hormone) could provide a potential marker, as its concentration closely correlates with the number of antral follicles (Pigny et al. 2006).

Increased androgen production plays an important role in the pathogenesis of PCOS. Steroid biosynthesis

in the ovary and in the female adrenal cortex follows the same mechanisms as described for the male in Chap. 2. Ovarian androstenedione is the basis for both testosterone and estrogens. Unlike in the male, LH and ACTH do not control androgen production by a specific inhibitory feedback mechanism, as androgens are only byproducts of estrogens and cortisone synthesis. Rather, intraovarian control of androgen production plays a critical role. In the ovary androgens represent a “necessary evil” (Rosenfield 1999). On the one hand, they are necessary for estrogen production and accelerate growth of smaller follicles; on the other hand, when overabundant they prevent selection of the leading follicle and cause atresia. Steroidal secretory patterns of PCOS patients suggest a generalized dysregulation of androgen production, particularly affecting the level of 17-hydroxylase and 17, 20 lyase activity. This dysregulation can manifest itself solely as ovarian hyperandrogenemia, but may also lead to functional hyperandrogenemia of the adrenal cortex. A combination of the two is not rare. Inherently a PCOS can derive from pathological androgen production of the adrenal cortex.

Absence of the correct rhythmic pattern of gonadotropin and sexual steroid secretion causes persistent anovulation. Serum levels of testosterone, androstenedione, dihydroepiandrosterone sulphate, 17-hydroxyprogesterone and estrone are thus elevated. The elevated production of estrogens is not due to direct ovarian secretion. The daily production of estradiol in women with polycystic ovarian disease is equal to that of normal women in the early follicular phase. The elevated serum estrogen concentration is rather due to peripheral aromatization of androstenedione to estrone in adipose tissue.

Typically, the **LH to FSH ratio** is greater than 3 in polycystic ovarian disease. Twenty to 40% of all patients with polycystic ovaries, however, do not have this typical change in the LH to FSH ratio. Analysis of the LH pulse pattern in PCO-patients shows a frequency identical to that of normal controls. The individual pulse amplitude, however, is elevated (12.2 ± 2.7 mU/ml) when compared to normal controls in early or midfollicular phase (6.2 ± 0.8 mU/ml) (Kazer et al. 1987). This seems to be a result of a change in GnRH pulse frequency.

An increase in the GnRH pulse amplitude with constant pulse frequency reduces peripheral FSH concentrations in the presence of normal LH patterns. This causes the typical reversal in the LH to FSH ratio.

Research data thus demonstrate that the change in gonadotropin secretion often associated with polycystic ovarian disease is due to a malfunction in the frequency and amplitude modulation of GnRH production. A primary disturbance of LH secretion does not, however, seem to be the origin of PCOS.

Endogenous opiates influence hypothalamic GnRH secretion. It has been shown that endorphin metabolism can be modulated in polycystic ovarian disease when compared to controls. β -endorphin and adrenocorticotrope hormone (ACTH) stem from the same precursor called proopiomelanocortin (POMC). It is known that β -endorphin levels are elevated in situations in which ACTH production is increased. The concentrations of ACTH and cortisol are normal in PCO patients, but this does not rule out a higher rate of metabolism of these substances. Since β -endorphin levels are elevated in stress situations, and patients with PCO show a higher rate of psychological stress reactions, it is possible that this may be one central factor in the impairment of normal regulatory mechanisms.

The influence of hyperprolactinemia in central hormone regulation was discussed above, and explains the high association of hyperprolactinemia with polycystic ovarian disease.

Elevated testosterone concentrations reduce the measurable free sex hormone binding globulin (SHBG), so that anovulatory women with polycystic ovaries usually have a 50% reduced level of SHBG due to secondary hyperandrogenemia. Reduced SHBG concentration elevates the concentration of free estrogen, which again is positively correlated with a rise in the LH to FSH ratio. The elevated free estradiol concentration, and the peripheral metabolism of androstenedione to estrogen reduce the FSH level. A residual activity of FSH, however, remains so that continued stimulation of the ovaries with ensuing follicle production occurs. The hypothalamic pituitary axis is fully intact, and is even the basis for further development of polycystic ovarian disease.

Follicular maturation in PCOS does not, however, end in ovulation. The maturation of the smaller follicles extends over several months so that typically 2–6 mm large follicle cysts are produced, which in turn give this disease its name. Since the follicles are enclosed in a hyperplastic theca layer, the follicular stroma is enlarged and constantly produces steroids under continued gonadotropin stimulation. This closes the vicious circle so that the disease is perpetuated. After the follicles die off and the layer of granulosa cells disintegrates, the

thecal portion remains so that the production of androstenedione and testosterone increases, according to the two-cell theory outlined above. The increased testosterone levels further reduce SHBG with a consequent rise of free estrogens. Simultaneously the free testosterone fraction increases, with the resulting effect on androgen-dependent tissue.

Insulin resistance. About 40% of patients with polycystic ovarian disease show increased **insulin resistance**. Although obesity and age increase the probability of insulin resistance, even non-obese women and young women with PCOS may show glucose intolerance. The infusion of glucose causes an excess secretion of insulin. It is estimated that about 10% of all cases of glucose intolerance are caused by PCOS-induced insulin resistance. Fifteen percent of all later diabetes type II cases show a PCOS in their history.

Although androgens can induce a slight insulin resistance, the concentrations found in PCOS are not sufficient to explain disturbances of insulin metabolism. If androgen production is inhibited, insulin sensitivity fails to normalize. Conversely, insulin resistance increases only negligibly when androgens are given, as in female-to-male transsexuals. Independent of the mechanism of elevated circulating insulin levels, binding of insulin to the **IGF-I receptors** in the theca cells occurs. This increases thecal androgen production by LH stimulation. The elevated circulating insulin levels thus increase androgen production in insulin resistance. Simultaneously, elevated insulin levels inhibit hepatic SHBG production and the production of IGF binding protein-I. Although there are indications that hyperandrogenemia can cause hyperinsulinemia, most experimental data suggest that disturbed insulin metabolism precedes irregular androgen metabolism (Dunaif 1999).

Obesity. Since increased body weight and abdominal adipose tissue causes hyperinsulinemia and reduced glucose tolerance, one may deduce that obesity is the major factor in polycystic ovarian disease. The typical distribution of female adipose tissue distribution in the hip area does not play such a major role. An objective method to determine the distribution of adipose tissue is the measurement of the ratio of waist-to-hip circumference. If the ratio is larger than 0.85, an android distribution of adipose tissue is probable, and hyperinsulinism should be suspected. If the ratio is below 0.75, a gynoid distribution is probable, which in turn is only rarely combined with changes in insulin metabolism.

20.2.4.4 Causes and Risk Factors

The origins of PCOS remain obscure. A combination of environmental conditions and predisposing genetic factors is presumed. According to new insights, triggering factors seem to lie less within the ovary than on the hypothalamic-hypophyseal level and in disturbed effects of insulin. Familial inheritance has been known for years and was recently confirmed by twinning studies in 79% of patients interviewed (Vink et al. 2006). A genetic association with a microsatellite marker (D19S884) on chromosome 19p13.2 is controversial.

Environmental factors in the sense of “endocrine disruptors” are difficult to prove in the human. In animal experiments increased exposure to androgen during pregnancy led to a PCOS-similar picture in female offspring (Abbott et al. 2005).

Diagnosis. Endocrinological investigation plays the major role in excluding the possibility of a PCOS and is mandatory even if the patient shows no physiological stigmata but is anovulatory. The typical ultrasound picture is not sufficient for diagnosis, as was formerly believed (see Fig. 20.9). Determining testosterone, androstenedione, DHEAS, estradiol, LH, FSH and prolactin levels in the first half of the cycle may be helpful in deciding on a form of individual treatment. Cortisol and 17-OH-progesterone levels supplement the basic work-up when adrenal involvement is suspected.

Treatment. Since polycystic ovarian disease usually encompasses elevated androgen levels, a chronic elevation of estrogen levels, and an inverse LH to FSH ratio, treatment must intervene in this vicious circle in order to allow ovulation to occur. Methods of treatment are as follows:

1. Anti-estrogens (e.g., clomiphene, tamoxifen, aromatase inhibitors)
2. Glucocorticoids (dexamethasone 0.25–0.5)
3. Pulsatile GnRH treatment via a cyclic pump
4. HMG/FSH-stimulation
5. Surgical reduction of ovarian stroma
6. Oral anti-diabetic medication

Treatment forms 1–3 still allow feedback and regulatory mechanisms of follicular maturation to occur. In contrast, the treatment with hMG or hCG/FSH directly acts at the ovarian level and thus carries a higher risk of hyperstimulation. But even clomiphene therapy is associated with a 5% rate of multiple pregnancy.

Surgical reduction of androgen producing ovarian stroma should only be tried when other forms of treatment have failed.

Research data show that 63–95% of the infertile women with polycystic ovarian disease ovulate after clomiphene treatment. Clomiphene is a weak anti-estrogen and causes a rise in gonadotropin levels. The compound is orally effective and is easily resorbed. Medication consists of enclomiphene and zuclophene, whereby the latter leads to strong accumulation following consecutive treatment cycles (Young et al. 1999). Treatment usually begins with 50 mg daily for 5 days, beginning between the 3rd and 7th day of the menstrual cycle. Twenty seven to 50% of the women ovulate with this low dosage. In some cases, an increase up to 150 mg daily should be considered, in which a further 26–29% ovulate. If this dosage does not result in ovulation, one may additionally prescribe dexamethasone (0.25–0.5 mg daily), depending on the DHEA-sulphate serum concentration. If follicular maturation is seen in ultrasound and is shown by serum hormone concentrations and no ovulation occurs, ovulation can be induced by 5,000–10,000 IU hCG i.m. If one considers that normally only 50% of all couples achieve pregnancy within 3 months, and that 80% require 1 year for conception to occur, treatment should be continued for at least 6 months or cycles if ultrasound and hormone levels show an adequate luteal phase. This therapy allows for an up to 90% success rate for clomiphene treatment, if other cofactors for infertility have been ruled out.

Tamoxifen acts similarly to clomiphene (Steiner et al. 2005). The substance, which is used as an anti-estrogen as adjuvant therapy for breast cancer, is not licensed for infertility but is clearly less expensive (costs of therapy per cycle ca. 1 and is preferable to clomiphene for pharmacological considerations.

Aromatase inhibitors, e.g., letrozol have been tried for stimulation treatment because of their similar mode of action (Badawy et al. 2008). Despite high costs there is no superior therapeutic effect. An embryotoxic effect was discussed, could, however, be excluded in a comparative study with clomiphene (Tulandi et al. 2006).

hMG and FSH. If treatment with clomiphene does not result in ovulation or conception, the next step is treatment with gonadotropins. Patients with hyperandrogenemia have a poorer success rate than those with pure hypothalamic amenorrhea. Since patients with

polycystic ovarian disease are very sensitive to hMG stimulation, this treatment form walks a fine line between the induction of ovulation and hyperstimulation with the risk of multiple pregnancy. After the introduction of purified FSH it was hoped that the LH/FSH ratio could be corrected in order to achieve a better form of treatment. The clinical results to date do not, however, clearly show better results in the treatment with purified FSH (Bairdt and Howles 1994). One advantage of the new FSH products is that of possible subcutaneous injection. Uncontrolled studies show a higher conception rate and a lower rate of hyperstimulation.

GnRH down-regulation. Treatment with pure hMG and hCG stimulation often results in a **premature LH peak** with luteinization of the follicle. Some authors believe that this premature LH peak is the major cause for later miscarriage, which is often found in polycystic ovarian disease. Clinical data, however, are not clear, so that down-regulation is not necessarily recommended in a treatment of polycystic ovarian disease with hMG and hCG.

Pulsatile GnRH treatment. Large-scale studies in the 1980s showed that this form of treatment resulted in a relatively high pregnancy rate without the high risk of hyperstimulation. In patients resistant to clomiphene citrate, treatment with pulsatile GnRH resulted in a conception rate of 26% per cycle. The conception rate could be elevated to 38% with simultaneous down-regulation followed by pulsatile GnRH treatment. The miscarriage rate of 38% was, however, also elevated (for review see Filicori 1994).

Ovarian wedge resection. If the above-mentioned forms of treatment do not result in pregnancy, ovarian wedge resection may be considered in order to reduce androgen production in the ovarian stroma. Up to 90% of such patients show normal ovulatory cycles after surgery. About one third of the successfully operated women, however, develop oligoamenorrhoea within the following year (Buttram and Vaquero 1975). The conception rate is reduced to 1.8% per cycle, which may be due to adnexial adhesions after such an operation (Adashi et al. 1981). Microsurgical and endoscopic techniques seem to avoid adhesion formation by replacing wedge resection by thermocauterization, laser vaporisation and electrocoagulation. These treatments are very effective and presumably longlasting. An advantage is that there is no multiple pregnancy rate (Farquhar et al. 2007).

Oral antidiabetic medication. Studies were carried out with metformine and troglitazone to reduce insulin resistance. Androgen levels did indeed improve and ovulatory cycles were achieved. Systematic studies have been made especially with metformin. In Germany this medication is not licensed for ovulation induction in PCOS. It is, however, inexpensive and seems not to be associated with fetal toxic effects so that “off-label use” is not problematic. An ovulation rate of 46% was achieved compared with placebo (24%). This corresponds approximately to the effectiveness of clomiphene (Lord et al. 2003). A direct 6-month comparative treatment with the mono-substances clomiphene vs. Metformin showed a significantly better pregnancy rate (22.5 vs. 7.2% n = 208, p < 0.001) in the clomiphene group (Legro et al. 2007). A combination of both substances did not increase the pregnancy rate (Moll et al. 2006; Legro et al. 2007).

Reduced body weight and follicular maturation. Independent of the treatment modalities mentioned above, treatment of obese patients should be based on weight reduction. Even a relatively small weight reduction of 2–5% can achieve clear improvement of hyperandrogenemia, insulin resistance and fertility (Moran et al. 2006) and is superior to oral antidiabetic medication.

Whereas the elevated body weight in many patients with polycystic ovarian disease propagates or even induces hormonal dysregulation, underweight patients also have a major risk factor for impaired follicular maturation and amenorrhea. A major proportion of the patients with hypothalamic amenorrhea fall into this group. This clinical entity is characterized by an inadequate pulsatile GnRH secretion. Diagnosis is one of exclusion in which other pituitarian disorders must be ruled out. In addition to evident low body weight, a particularly stressful situation such as refugee amenorrhea can induce hypothalamic dysregulation. Such patients show extremely low or non-measurable gonadotropin levels. Prolactin levels lie in the normal range, and the cone view of the sella shows no pathological changes. A progesterone challenge test with a transformation dose (such as *MPA gyn* 5 mg b.i.d. for 10 days) does not result in bleeding, and thus demonstrates the absence of estrogen stimulus on the endometrium.

The most extreme form of low body weight amenorrhea is that of **anorexia nervosa**. The pure form of anorexia is extremely rare in the infertility clinic, but

minor forms may be seen more often in infertility patients.

In contrast to anorexia nervosa, which may have concurring central nervous dysregulation, **simple weight loss** may be a cause of impaired follicular maturation, and may be readily overlooked. The endocrine imbalance, however, is comparable to that of anorexia. Hormone studies show low FSH and LH concentrations, elevated cortisol levels, normal prolactin, TSH and L-thyroxine levels with low normal fT_3 and elevated reverse- T_3 levels. Extreme weight loss causes the loss of sleep-associated episodic LH secretion, showing a pattern usually found in early puberty. Weight gain within 15% of ideal body weight may result in an improvement of the symptoms.

In addition to low body weight, **physical activity** may cause cyclic dysregulation. Many studies have shown menstrual dysregulation in athletes, especially in long-distance runners and ballet dancers. The percentage of amenorrhea is proportional to the weekly distance run, and inversely proportional to body weight. Decreasing body weight results in a higher incidence of anovulatory cycles and a reduction in the quality of the luteal phase. The theoretic mechanism for impaired GnRH secretion is a change in estrogen metabolism, in which estradiol is converted to catechol estrogens which seem to have anti-estrogenic properties.

Increased physical activity such as in running often results in a “**runners’ high**”, which is thought to be the result of an increase in endogenous opiates. These endogenous opiates may cause an elevation of corticotropin releasing hormone concentrations, which in turn reduce gonadotropin production. Hypothalamic GnRH production seems to be suppressed. In 49 of 66 patients with hypothalamic dysregulation of follicular maturation, treatment with 25–125 mg **Naltrexon** daily resulted in a normal menstrual cycle. The pregnancy rate was almost equal to that of normal controls (Wildt et al. 1993). Alternatively, pulsatile GnRH treatment or hMG and hCG stimulation may be considered, but here again there is a risk of multiple pregnancy. First, however, body weight should be normalized.

20.2.4.5 Primary Ovarian Failure

In patients with secondary amenorrhea primary ovarian failure must be ruled out. This can be done during

the initial examination in which FSH and estradiol levels are measured. If a patient with a history of oligo-amenorrhea has elevated FSH levels and reduced estradiol concentrations, the diagnosis of primary ovarian failure can be formed. The FSH levels should lie at least two standard deviations above the mean in the follicular phase, and should be confirmed by a second sample.

One percent of all women have **precocious menopause** with ovarian failure beginning before the age of 35 years. The causes are usually unknown. Sometimes a chromosomal origin may be identified; other causes include autoimmune diseases, viral infections, previous chemotherapy and/or radiation therapy.

Turner syndrome with the loss of one X chromosome is one of the most common human chromosome defects, and is seen in one of 2,500 live births. Typically, these patients show short stature and streak gonads. Ovarian dysfunction, however, shows extreme variations. An ultrasound study of 104 young Turner patients showed visually demonstrable ovaries in one third of the patients (Massarano et al. 1989).

Many of these women had an incomplete deletion of the X chromosome. This explains case reports of pregnancy and live births before premature ovarian failure begins in women with XO syndrome and partial X deletions.

Various other genetic abnormalities are associated with hypergonadotropic hypogonadism. They are, however, so rare in a normal infertility clinic that a routine genetic diagnostic check does not seem warranted.

In addition to chromosomal diseases some genetic diseases, such as galactosemia, may cause premature ovarian failure.

Chemotherapy with antimetabolites and radiation therapy may impair ovarian function, and should be identifiable in the patient's history.

It is not clear if other exogenous toxins may play a role in premature ovarian failure. Analogous to orchitis in men, it is assumed that oophoritis may occur after mumps. There are, however, only a few case reports which do not allow a clear statement on this issue.

Autoimmune diseases. There is some evidence that autoimmune antibodies may cause premature ovarian failure. Typical autoimmune diseases such as Hashimoto thyroiditis, Basedow's disease, Addison's disease,

hyperthyroidism, juvenile diabetes, pernicious anemia, alopecia areata, vitiligo, and myasthenia gravis are associated with ovarian failure. Patients often have several autoimmune diseases simultaneously, which is known as the "polyglandular failure syndrome". The most common association is that of thyroidal disease and Addison's disease.

Circulating autoantibodies against ovarian stroma can be found in the serum of patients with primary ovarian failure. It is, however, not clear whether the antibodies are primary or secondary in nature. This is also true for cellular autoimmune disease in which lymphocyte infiltration of the ovaries can be found.

The fourth argument for an immunological cause for premature ovarian failure is the statistically significant correlation between human leucocyte antigens (HLA) with some autoimmune diseases (for review see Bakimer et al. 1994).

In addition to the above-mentioned causes for hypergonadotropic hypogonadism, there are rare cases with defective FSH hormone receptors, and others with biologically inactive gonadotropins. These are, however, not relevant in clinical routine (see review by Themmen 2005).

Treatment. After diagnosing premature ovarian failure, substitution with an estrogen and progesterone combination should be recommended. In rare cases, patients show remission and possibly may conceive (Shangold et al. 1977). A causal therapy is, however, not possible in infertility patients with hypergonadotropic hypogonadism. Oocyte and embryo donation are legally prohibited in Germany. In the USA success rates between 22% and 50% are achieved with these procedures.

20.3 Infertility Due to Disturbances of Gamete Migration

After checking ovulatory function in female infertility, one must consider a disturbance in the passage of the oocyte and the sperm (see Fig. 20.13 for an overview) Possible alterations exist in the vagina, the cervix, the uterus and the Fallopian tubes, as well as the pelviperitoneum.

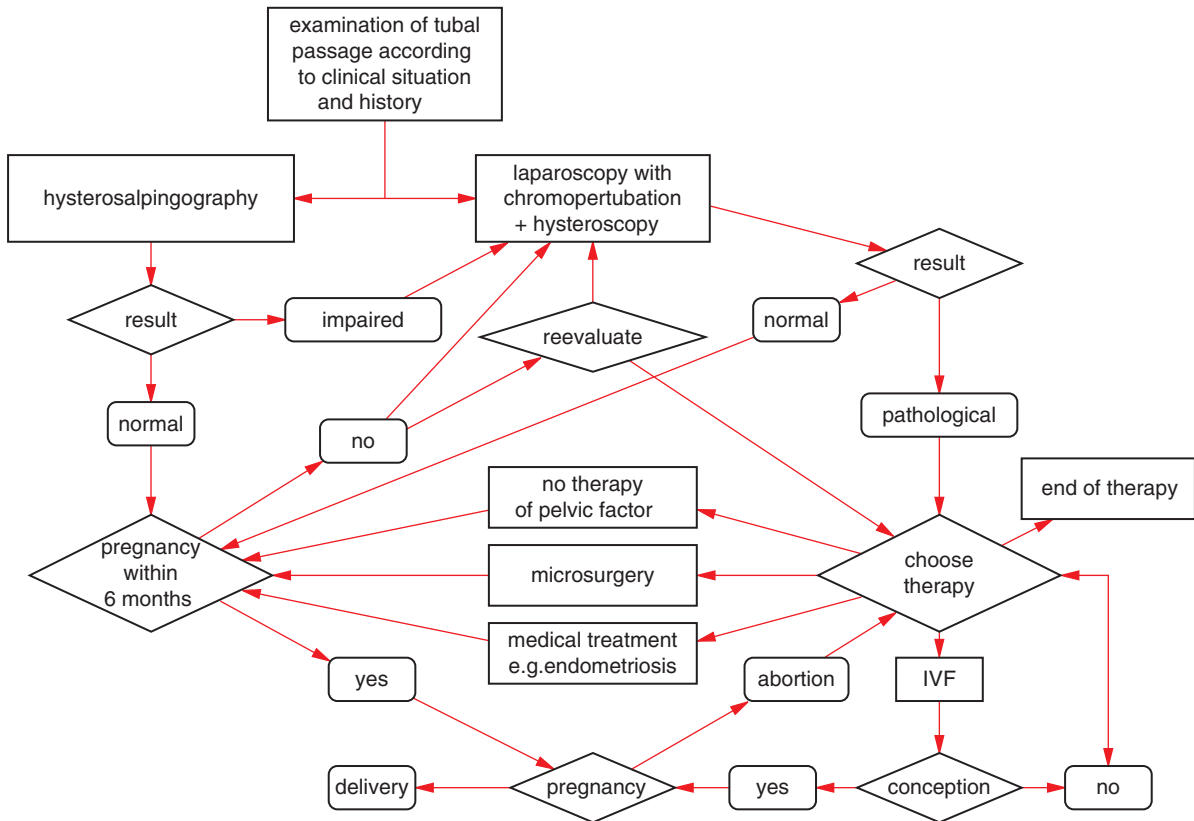

Fig. 20.13 Flow chart for the systematic evaluation of the uterine-tubal passage. Only main areas are shown to facilitate readability. For more details see text

20.3.1 Vagina and Cervix

Anatomical variations of the vagina, such as transverse and longitudinal septae, or even vaginal aplasia, are obvious. Changes in the vaginal environment may be another cause for infertility. The production of lactic acid through glycogenolysis gives the vagina a pH of 4–4.5, and thus represents a hostile environment for sperm. Physiological cervical mucus production at the time of ovulation creates the first prerequisite for passage of sperm into the genital tract.

Vaginal infections with increased discharge, a change in pH, and leukocyte transudation are detrimental to the motility and the ascent of sperm. The first clinical examination of the patient should thus include a wet mount of a vaginal smear in order to exclude the presence of pathogenic bacteria and leukocytes. A vaginal infection must also be ruled out if a pathological postcoital test has been diagnosed due to poor mucus despite good estrogenization. Bacterial, viral, and

yeast infections, as well as trichomadiasis should be considered. The most common pathogens are gardnerella vaginalis, neisseria gonorrhoea, chlamydia, mycoplasma and ureaplasma. Viral infections may be due to herpes and cytomegaly infections. Candida albicans is the most common yeast infection.

All forms of vaginitis may include cervicitis, causing a change in cervical mucus pH, and may represent a cause of infertility. Treatment can be local or systemic depending on the pathogen isolated. Post-infectious changes in the cervix can result in a stenosis or in damage to the cervical crypts with poor mucus production. Cervical smears in infertile couples have shown a mycoplasma infection in 12%, and pathogenic aerobic bacteria in 31% of the patients examined (Eggert-Kruse et al. 1992). Cervical operations such as electrocoagulation, cryotherapy, laser vaporization, or conization may be an indication for intra-uterine insemination, if cervical passage of sperm is not possible.

20.3.2 Anomalies of the Female Genital Tract

The embryonic origin of the urogenital system is complex and explains many of the congenital anomalies found. A disruption in one of the many fusion steps can result in either a partial or complete agenesis of particular ducts. Congenital anomalies often include the urinary system.

20.3.2.1 Uterus

The unilateral agenesis or aplasia of the Mullerian duct results in a uterus unicornis. 0.1–3% of all women have varying uterine anomalies due to disturbed Mullerian fusion. These vary from a uterus subseptus unicollis up to the double uterus, cervix and vagina. Surgical treatment should only be recommended after considering all other possible causes for infertility, since the coexistence of infertility and, for example, a septate uterus, must not be causal.

Acquired uterine anomalies include fibroids and adhesions. Uterine leiomyomata are found in 20–25% of all women of reproductive age. They are usually asymptomatic. These fibroids may be subserous or, more importantly, intramural, submucosal, and/or pedunculated, which may be causal for infertility. A review of 27 studies from 1982 to 1996 reported on pregnancy rates after myectomy. Nine studies were prospective (Vercellini et al. 1998); their combined pregnancy rates were 57% (95% confidence interval 48–65%). The median interval from surgery to pregnancy varied between 8 and 20 months. Unfortunately no study compared results from surgery with non-intervention (simple waiting), so that any improvement in probability of conception following myectomy cannot be definitely ascertained.

20.3.2.2 Fallopian Tubes

Congenital defects of the Fallopian tubes are very rare, especially if the remaining organs are normal. In rare cases, one-sided aplasia of the ovary and uterine anomaly may be combined with a one-sided aplasia of the Fallopian tube. The cause for the rare case of missing parts of the Fallopian tube is not known.

The Fallopian tube can be morphologically divided into four segments:

1. The **interstitial segment** is the part of the Fallopian tube which passes through the uterine wall and is surrounded by myometrium. The endosalpinx consists of secretory and ciliated cells which form longitudinal folds in the form of a star. The diameter is about 400 μm .
2. The **isthmic portion** of the tube consists of the proximal third of the Fallopian tube. The endosalpinx here has more secretory cells than ciliated cells.
3. The **ampulla** consists of the other two thirds of the lateral Fallopian tube. The cilia beat towards the uterus and are important for the transport of the oocyte and embryo. Surgical procedures on the isthmic portion of the Fallopian tubes still allow for pregnancy rates of about 80%. A resection of the ampulla, however, results in a clearly lower pregnancy rate. The major portion of ectopic pregnancies are found in the ampulla, since fertilization and early embryogenic development occur in this segment of the tube.
4. The **infundibulum** is fringed by the fimbriae, which have close contact with the ovary. The ostium accepts the oocyte during ovulation by means of a mechanism yet unknown. Pathological changes due to infectious diseases, adhesions or operations result in a high infertility rate, and are difficult to treat by surgery.

20.3.3 Physiology of Tubal Function

Tubal motility, secretion, and ciliary activity are the prerequisites for the complex process of sperm transport, capacitation, oocyte retrieval, fertilization, zygote development, and the transport of the oocytes and of the zygote (also see Chap. 3). The Fallopian tube shows a continuous and complex pattern of spontaneous contractions. The relationship between the contractions and gamete transport is yet unclear. In contrast to the gastrointestinal tract, no regular peristaltic movements occur over a greater distance. Individual segments simultaneously contract in opposing directions and short distances. Oocyte transport is thus discontinuous with movement towards and away from the uterus. Since the movement is primarily towards the uterus,

the oocyte finally ends up at the endometrium of the uterine cavity.

The significance of tubal contractility for sperm transport is not yet clear. One would assume that tubal passage is the result of sperm motility. After insemination, however, sperm can be found 5 min. later in the peritoneal cavity, so that tubal contraction must play a major role in the primary transport of the sperm. A further assumption is that contractions of the uterus and the tubes during sexual intercourse play a role in rapid sperm transport. Sperm reaching the Fallopian tube in this manner, however, do not seem to be important for fertilization.

Tubal ciliary movement is directed towards the uterus, so that the transport of sperm in the other direction must be due to other mechanisms. The secretory activity of the Fallopian tube may play a role in spermal transport. Tubal secretion is greatest at time of ovulation, and these viscous glycoproteins seem to attenuate ciliary movement in such a manner so that the sperm are able to pass the Fallopian tube on their own, as they do in the mid-cyclic cervical mucus. After mucus secretion decreases, ciliary movement towards the uterus is reactivated so that the fertilized oocytes can be transported in the correct direction.

Tubal mucus production is estrogen-stimulated and inhibited by progestins. A number of proteins found in the tubal secretion, which cannot be found in serum, seem to be of importance for reproductive function.

In contrast to the testis, female gametes are transported through an open system. After leaving the ovarian surface, the oocyte must pass through the peritoneal cavity in order to reach the Fallopian tube. Microscopy studies in humans have shown that at the time of ovulation the fimbriae and the ostium of the tube are directly in contact with the ovary. This is due to contractions of the Fallopian tube, the mesosalpinx, and the fimbriae. Interestingly, pregnancy is possible with only one ovary and a single contralateral Fallopian tube.

Surgical salpingostomy in a case of a fimbrial adhesion results in only a low pregnancy rate, which shows the importance of this pick-up mechanism.

Only a very small portion of the large number of sperm deposited intravaginally during intercourse reach the Fallopian tube (see Fig. 20.14). Only optimally formed and motile sperm are able to pass the filtration and selection mechanisms of the female tract in order to reach the ampulla and thus the location of fertilization.

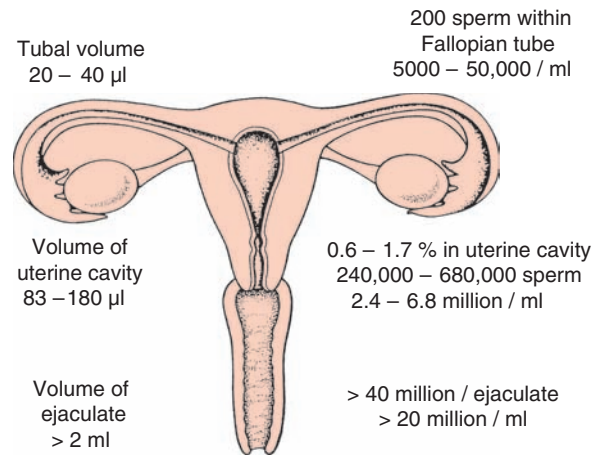

Fig. 20.14 Volume of different compartments of the female genital tract and resulting concentrations of sperm after vaginal ejaculation

Fertilization probably occurs in the distal ampulla. The sperm seem to survive 24–48 h in the female genital tract, with some reports of survival up to 96 h. The oocyte can however, only be fertilized for 24 h. The fertilized oocyte begins division in the Fallopian tube. The human zygote has no nourishment reservoir nor constant cell contact during transport. The developing zygote must thus be maintained by the tubal secretions until it is implanted in the uterine cavity after about 1 week.

20.3.4 Diseases of the Fallopian Tubes

The complex processes of tubal passage show that disturbances in this area can cause infertility. Congenital anomalies are not as important as those that are acquired, such as adhesions caused by endometriosis or infections. *Chlamydia* infection is of primary importance.

20.3.4.1 Salpingitis

Nineteen percent of all women with salpingitis demonstrate an infection with chlamydia (Hoyme et al. 1988). Four percent of patients who underwent laparoscopy owing to tubal infertility showed culture-positive

chlamydia. Since many pelvic infections have no or only unspecific symptoms, tubal passage should be checked in all patients who do not achieve pregnancy after 6 months, despite good luteal functions.

Especially in couples with clearly reduced male parameters, one should always consider further invasive diagnostic measures in the female patient.

The probability of tubal infertility in couples with secondary sterility rises by a factor of 7.5 with a history of venereal disease. A patient with appendectomy has a risk of 4.7 for tubal factor infertility when compared to controls. A history of a previous extrauterine pregnancy increases the risk 21-fold, and a history of prior pelvic inflammatory disease increases the risk by a factor of 32 (Thonneau et al. 1993).

A tubal occlusion in the fimbrial part can cause a sausage-like swelling of the tube with reduction of wall structure (sactosalpinx). A bilateral salpingectomy prior to planned IVF doubles the probability of pregnancy. Whether one-sided obstruction should also be corrected cannot be concluded with certainty at the present time (Johnson et al. 2004).

20.3.5 Diagnostic Tests for Uterine and Tubal Patency

The available tests for tubal patency are:

1. Insufflation of Fallopian tube with CO₂
2. Hysterosalpingography
3. Chromoperturbation and diagnostic laparoscopy

20.3.5.1 Tubal Insufflation

This method was first described in the 1920s and is unreliable. No clear information can be obtained whether the tubal obstruction lies on one or on both sides. Direct comparison with laparoscopy shows great discrepancy of the results. This method should not even be used as a screening procedure.

20.3.5.2 Hysterosalpingography

Hysterosalpingography (HSG) is a much more important procedure. It can be performed on an outpatient basis after giving an analgesic such as indomethacin 1–2 h prior. The examination of the tubes is performed via a fluoroscope. In rare cases, tubal spasm may lead to misdiagnosis of a tubal occlusion. Spasmolytic drugs such as 1–2 ml butylscopolaminebromide i.v. should be tried.

The ovarian radiation dose varies between 1.7 mGy for a 100 mm fluoroscopic film and 2.8 mCy for a 24 × 30 cm spot film. This procedure is usually timed 2–5 days after menstrual bleeding in order to minimize the disturbance of a possible early pregnancy.

The risk of this radiographic diagnostic procedure is that of infection which has a probability of 1%. Identification of patients at risk has been tried through blood sampling of leukocytes, c-reactive protein, and sedimentation rates. Our own studies, however, have shown that this has a poor specificity and sensitivity (Knuth et al. 1982).

Some authors recommend prophylactic antibiotics such as 200 mg doxycycline 2 days before the procedure followed by 5 days of 100 mg. There are no uniform recommendations, and we do not use prophylactic antibiotic treatment.

During hysterosalpingography the uterine cavity is easily delineable and septae, polyps and submucosal fibroids are readily seen. In order to evaluate the significance of this diagnostic procedure, consequent pregnancy rates must be correlated to previous results. A normal hysterosalpingography was followed by pregnancy in 46% of cases with donor insemination. A uterine anomaly or defect with bilateral tubal patency resulted in a pregnancy rate of 34%. Normal uterine anatomy with unilateral tubal occlusion resulted in a pregnancy rate of 40% after donor insemination (Stovall et al. 1992).

The relatively high rate of conception despite pathological hysterosalpingography examination is probably due to optimal male factors during donor insemination. This must be considered if the male factor in the infertile couple is also impaired.

When comparing hysterosalpingography with laparoscopy and chromoperturbation a larger discrepancy is found. The predictions from HSG thus do not seem to be optimal. A positive correlation of the data is found in 62% of 104 patients examined (Adelusi et al.

1995). If the results of hysterosalpingography are normal, in 96% of the cases laparoscopy and chromoperturbation are also normal. If the HSG results are unclear and lesions are expected, laparoscopy is only correlated in 63% of cases. Suspicious lesions in the Fallopian tubes are only correlated in 54%, so that Opsahl et al. (1993) deduced that women with a normal HSG who do not conceive must undergo diagnostic laparoscopy. The interpretation of HSG can be optimized through a special catheter system which perfuses each Fallopian tube individually. In this procedure, it is possible to measure the pressure necessary to achieve patency in each individual tube. Normal tubes require a pressure of 429 ± 376 mmHg, pathological tubes require a pressure of 957 ± 445 mmHg (Gleicher et al. 1992). A similar procedure can be performed less invasively by duplex sonography (Allahbadia 1992). Newly developed sonographic contrast substances allow the HSG to be performed entirely by ultrasound (Degenhardt et al. 1995). This new technique may provide a simple screening procedure in the infertility clinic, although one must consider its limits in the evaluation of tubal patency.

If an HSG is performed in the classical manner an oil suspension contrast medium should be used since this results in a higher pregnancy rate compared to cases in which a hydrophilic agent is used (Watson et al. 1994). A small risk of granuloma formation following oily media must, however, be considered.

In conclusion, sono-hysterosalpingography can be recommended as a screening procedure for tubal patency in women with an uneventful prior history, negative chlamydia tests, and period of non-conception less than 1 year. If these requirements are not fulfilled, laparoscopy and chromoperturbation should be performed.

20.3.5.3 Hysteroscopy and Laparoscopy

The standard method for the diagnosis of pelvic conditions and tubal patency is laparoscopy combined with chromoperturbation and hysteroscopy. In contrast to hysterosalpingography, endometriosis adhesions, Fallopian tubal thinning, and ovarian alterations can be optimally diagnosed by an experienced surgeon.

Hysteroscopy. This procedure can be performed without general anesthesia if no consequent laparoscopy is planned. A rigid or flexible endoscope is passed through the cervical os into the uterine cavity which,

since it is usually collapsed, must be distended by a medium. High molecular dextrin, CO₂ or 5% dextrose in water may be used. A separate instrument channel may be used, through which forceps, electrocautery or laser devices can be passed.

Laparoscopy. Laparoscopy is usually performed under general anesthesia with intubation. After sub-umbilical incision and insufflation of the peritoneal cavity with CO₂, the laparoscopic trocar and the laparoscope are introduced. The risks of this procedure are that of gastrointestinal or great vessel perforation. This occurs in about 0.1% of all examinations. After one or two additional incisions are made for the introduction further instruments, dye can be injected through the intrauterine cannula. Direct observation attests to tubal patency if dye spills from the ostium.

Since intraabdominal adhesions can be associated with intratubal pathology without clear disturbance of tubal patency, new diagnostic measures have been implemented. Falloscopy is performed with extremely fine endoscopes through which the internal Fallopian tube can be inspected during hysteroscopy or laparoscopy. These endoscopes have a special optical system in order to prevent damage to the Fallopian mucosa (Venezia et al. 1993).

20.3.6 Treatment

Depending on the pathology of the Fallopian tube either adhesiolysis, fimbrioplasty, salpingostomy or anastomosis may be considered. **Adhesiolysis** includes all microsurgical procedures which are performed to regain the mobility of the Fallopian tube and the ovary. **Fimbriolysis** is performed in order to mobilize fimbriae, peritoneal defects are carefully sutured. **Fimbrioplasty** is the reconstruction of the existing fimbriae in a partially or totally occluded oviduct. In the case of total occlusion, the ostium is opened and the serosa is everted in order to form a fimbriostium. If ampullary occlusion requires the resection of a part of the tube, a **salpingoneostomy** is performed. Anastomosis can be performed at every segment of the Fallopian tube.

Today the results of microsurgical procedures must be compared to those of IVF programmes. One must consider, however, that **microsurgery** may be a curative form of treatment for a patient, whereas **IVF** is only a temporary treatment form. Pregnancy rates after

surgical salpingolysis, fimbriolysis and ovariolysis lie between 39–69%. In a summary statistic, a median pregnancy rate of 40% has been calculated after conventional techniques.

Post-inflammatory tubal diseases, which require fimbrioplasty and salpingostomy, however, have poorer results. A study at the University of Münster showed a pregnancy rate of only 25% in such patients (for overview see Schneider and Karbowski 1989). When deciding on the form of treatment, the availability of an experienced surgeon must be considered. The patient should be referred to a specialized microsurgical department, if an immediate IVF procedure is not to be recommended.

20.4 Endometriosis

Although it can be argued whether hysterosalpingography or laparoscopy is the better diagnostic test to check for tubal patency, laparoscopy is absolutely necessary in order to diagnose peritoneal endometriosis.

20.4.1 Pathogenesis and Epidemiology

Endometriosis is a disorder in which normal endometrium or endometrium-like tissue is found in locations other than the uterine cavity. These ectopic tissues may be involved in pathological as well as normal cyclic changes of the endometrium. The true cause of endometriosis, which can cause infertility, is unknown and many theories have been discussed. To date, the accepted theory is that endometriosis occurs through implantation of individual endometrial cells and endometrium fragments which are passed through the Fallopian tubes into the peritoneal cavity in retrograde fashion during menstruation. It is assumed that these cells then implant on the peritoneal surfaces and grow into endometrial lesions. After further proliferation these tissue particles grow to allow macroscopic visualization. A review of this frequent disease is found in Giudice and Kao (2004).

Endometriosis is found in 5–10% of all women of the reproductive age. Its prevalence, however, is much higher in women with infertility problems.

20.4.2 Symptoms

The cardinal symptoms of endometriosis are pelvic pain, dysfunctional bleeding, and infertility. The pathophysiology by which endometriosis causes infertility is multifactorial. This includes mechanical factors, toxic derivatives in the peritoneal fluid, as well as immunological and hormonal disturbances.

The main cause for infertility, however, lies in the adhesions found in progressive stages of endometriosis. Peritubal and periovarian adhesions inhibit the interaction between the uterine tube and the ovary, which is important at the time of ovulation. Proximal tubal occlusion is often found. Although endometriosis is often present on the ovaries, small lesions probably do not play a role in fertility. Larger endometriosis, or endometriomas can invade stroma of the ovary, destroying normal tissue. These are called “chocolate cysts”.

20.4.3 Pathophysiology

Physiologically, the ovaries and the tubes are surrounded by peritoneal fluid, the volume of which rises to about 20ml at the time of ovulation. The regulation of peritoneal fluid volume is disturbed in women with endometriosis. Embryotoxic substances are also found in the peritoneal fluid of these women. After incubating sperm with the peritoneal fluid of endometriosis patients, one sees a reduction in motility in computerized analysis when compared to controls. Presumably, prostaglandins and macrophages inhibit sperm motility.

An increase in prostaglandin concentrations in the peritoneal fluid probably alters the contractility of the tubes, so that the transport of sperm, the oocyte and the zygote are modified. Non-steroidal antiphlogistics, however, fail to improve infertility. Normally, the peritoneal fluid contains 0.5–2 million leukocytes per ml, the major portion of which are macrophages. If endometriosis is found on the peritoneum, there is a proportional rise in macrophages. One cannot, however, discern whether these changes in the peritoneal fluid are the result or a cause of endometriosis.

Patients with endometriosis have increased levels of IgM, IgG and IgA when compared to normal controls. An inverse correlation of the immunoglobulins with the severeness of endometriosis is, however,

found. Some authors presume that endometriosis is an autoimmune disease, but this has yet to be proven.

Diagnosis of endometriosis is possible by direct visual observation or histological examination during laparoscopy or laparotomy. One must be careful to search the entire pelvic peritoneum systematically in order to find discrete endometriotic lesions. It is not enough to just perform one quick diagnostic view through the endoscope and to let the patient go home with the diagnosis of endometriosis after visualizing a few topical brown-black lesions. Often only histological probes will show the typical endometriotic alterations.

20.4.4 Staging of Endometriosis

Once a diagnosis of endometriosis has been made, a staging classification must be performed. This is usually done with the help of the revised classification of the American Fertility Society (Table 20.1).

In Germany one often uses the endoscopic classification of endometriosis according to Semm, which is divided into four groups.

- Group I: normal patent tubes and endometriotic lesions of the epithelium under 5 mm in diameter
- Group II: endometriotic lesions greater than 5 mm in diameter possibly involving the bladder, periovarian and peritubal adhesions, and/or a stenosis or phimosis of the uterine tubes
- Group III: adenomyomata in the uterus or in the intramural part of the uterine tube, chocolate cysts, lesions in the sacrouterine ligaments or a sactosalpinx
- Group IV: extragenital endometriosis

Since laparoscopy is an invasive test, another screening method for endometriosis has been sought for in the past. The most commonly used parameter is the tumor marker Ca 12–5, which is a membrane antigen of epithelial origin which can be measured in the serum. Ca 12–5 levels are elevated in women with epithelial ovarian cancer and other neoplasias of the pelvis. Slight elevations are also found in women with endometriosis. The sensitivity and specificity of this parameter is, however, so low that women with slight endometriosis may have a normal level.

Table 20.1 Revised classification of endometriosis (American Society for Reproductive Medicine)

Endometriosis		<1 cm	1–3 cm	>3 cm
Peritoneum	Superficial	1	2	4
	Deep	2	4	6
Ovary right	Superficial	1	2	4
	Deep	4	16	20
Ovary left	Superficial	1	2	4
	Deep	4	16	20
Post. Culdesac-Obliteration		Partial		Complete
	Adhesions	<1/3	1/3–2/3	>2/3
Ovary right	Filmy	1	2	4
	Dense	4	8	16
Ovary left	Filmy	1	2	4
	Dense	4	8	16
Tube right	Filmy	1	2	4
	Dense	4 ^a	8 ^a	16
Tube left	Filmy	1	2	4
	Dense	4 ^a	8 ^a	16

Stage I (minimal) = 1–5, Stage II (mild) = 6–15, Stage III (moderate) = 16–40, Stage IV (severe) >40

^aIf the fimbriated end of the Fallopian tube is completely enclosed, change the point assignment to 16

20.4.5 Treatment

Since the pathophysiology of the disease has not been fully clarified, there is **no ideal treatment**. If adhesion formation with impaired tubal function, large endometriomas, or occluded Fallopian tubes can be diagnosed, the mainstay of therapy will be microsurgery, in some cases after prior drug treatment. In other cases it is not clear whether a specific treatment of endometriosis is even necessary. The form of treatment recommended must be tailored to the individual situation of the infertile couple.

Typical pharmacological treatment forms include

- Progestins
- Danazol
- GnRH analogs
- Aromatase inhibitors

The estrogen and progestin combination, which has been used in the past to achieve pseudo-pregnancy, is only be used in rare cases (Schweppe 1995).

20.4.5.1 Danazol

Before GnRH analogs were introduced, danazol was the mainstay of treatment following its introduction in

1971. Along with GnRH agonists the Food and Drug Administration (FDA) formally licensed danazol for treatment of endometriosis. However, double-blind controlled studies never seem to have demonstrated a better effectiveness of danazol treatment compared to pure progestin therapy (e.g., medroxyprogesterone acetate 20–30 mg/die over 6 months. In order to understand the mechanism of action, one must assume that receptors for estrogens and progestins are contained in endometriotic lesions, and that neutralization of these ligands will cause atrophy of the lesions. This is the main principle of the pharmacological treatment of endometriosis.

In premenopausal women, however, an extreme hypogonadotropic situation is not produced, even though the mid-cyclic LH and FSH peaks are suppressed. More importantly, danazol seems to interfere with the binding of the sex hormones to their receptors. Danazol mainly binds to progestin and androgen receptors, and interestingly enough, not to the estrogen receptor. Danazol displaces testosterone and estradiol from SHBG, and progesterone and cortisol from corticosteroid binding globulin. Consequently, an elevation of the free fractions of these hormones with the respective clinical symptoms, such as hyperandrogenemia, occur. Additionally, danazol reduces the hepatic synthesis of SHBG so that the serum concentrations of free androgen rises further. Danazol directly inhibits enzymes that synthesize estrogens.

Danazol is available internationally in 200 mg tablets; the daily dosage is about 800 mg divided into four doses. No pregnancy can occur during this therapy, which is usually performed for 6 months. An attempt to lower the dosage alleviated adverse clinical symptoms, but did not show equivalent effects in control laparoscopy. In every case the goal of treatment should be amenorrhea. Estradiol serum levels should be below 40 µg/ml in minimal endometriosis, and below 20 µg/ml in more severe cases.

The **pregnancy rate** after danazol treatment lies between 28–72%. If endometrioma greater than 1 cm in diameter have been visualized, surgical treatment should be performed. One study showed that patients with minimal endometriosis who were treated for 6 months with danazol achieved a pregnancy rate of 37% after a 12-month control phase. The untreated control group, however, had a pregnancy rate of 57% (Seibel et al. 1982). This casts doubt on the rule that endometriosis necessitates treatment in all cases. Obtaining

the entire clinical picture with optimal laparoscopic description and diagnosis of the disease is essential before deciding on a form of treatment.

Treatment of endometriosis by danazol is not curative, since even atrophic lesions may again proliferate after conclusion of treatment. Recurrence rates lie between 33% and 39%. Most pregnancies occur in the 7 months following treatment. If no conception occurs during this time, one must consider a different form of treatment.

The elevation of androgen concentrations causes virilization in some patients. Side-effects of danazol treatment include weight gain, acne, hirsutism and reduced breast volume. In rare cases, a deepening of the voice occurs, which must be considered in those professions in which this is important. This side-effects seem to be irreversible.

20.4.5.2 GnRH Analogs

GnRH analogs are a good option for inducing reversible pseudo-menopause in which a hypogonadotropic and hypoestrogenic condition equivalent to **temporary castration** is achieved. The principle of this form of treatment has been discussed in another chapter of this book. The mechanism in females is similar to that in males, in which down-regulation results in the desired low estradiol concentration. The success of a treatment is directly proportional to the extent of estrogen reduction.

GnRH agonists probably do not have a direct effect on the ovaries. Successful treatment is due solely to estrogen deficiency. Evaluation of pregnancy rates after GnRH and danazol therapy shows similar results. Because of the hyperandrogenemic side-effects of danazol therapy, it is likely that GnRH treatment will be recommended.

The main **side-effect of GnRH agonist** treatment is that of profound hypoestrogenemia including flushes, vaginal dryness, reduced libido, and at times, depression. There is no influence on plasma lipoproteins. During a 6-month treatment course, a reduction of bone mass can be reversible after conclusion of therapy.

20.4.5.3 Aromatase Inhibitors

Studies by Zeitoun and Bulun (1999) show an abnormal expression of aromatase in endometrial lesions, so that

a systemic reduction of estrogen supply will be of little effect. Here aromatase inhibitors could provide innovative therapeutic possibilities (Shippen and West 2004).

20.4.5.4 Surgical Treatment

Surgical treatment is indicated in infertile patients with extreme adhesion formation, enlarged ovaries, and pain which is not ameliorated after pharmacological treatment, and in older patients for whom lengthy medical treatment seems inappropriate. Individualization of therapy is important, since, as in microsurgical treatment, the experience of the available surgeon has considerable significance for successful treatment.

20.4.5.5 IVF

In vitro fertilization may offer the only possibility for patients with extreme endometriosis, although results are poor in this patient group (Simon et al. 1994). Another study, however, showed pregnancy rates of 29% per transfer in endometriosis patients compared to 25% in controls (Dmowski et al. 1995).

20.5 Sperm Antibodies

If hormonal and clinical factors of female infertility have been ruled out, immunological causes are considered next.

The **mucosal immune system** represents the largest immunocompetent structure of the human body, and includes the majority of endogenous antibody-producing plasma cells. Antibodies which are detected in blood or lymph samples usually belong to the IgG-group, whereas antibodies found in secretions such as the cervical mucus are usually of the IgA group.

20.5.1 Pathophysiology

Although a sexually active female is exposed to a great number of potential antigens in the form of spermatozoa, the female immune system can usually not be activated in this manner. Different factors may play a role in this mechanism (Jones 1994). For example,

non-specific antibodies, which surround the spermatozoa in a protective fashion, deterring an immunological response, have been discussed (for review see Marshburn and Kutteh 1994).

20.5.2 Antibody Testing

Sperm antibody tests usually depend on sperm agglutination and sperm immobilization by serum antibodies. The measurement of serum antibodies against spermatozoa is without clinical significance, however, since the levels are not correlated with those of genital secretions. ELISA measurements give greatly varying results, depending on which antigen is used from the wide range of spermatozoal proteins. This explains why research data are so contradictory.

The best method to determine antibodies in the female seems to be the indirect immunobead test. Donor sperm are incubated with the body fluid to be examined, and then undergo multiple washings with a buffer. Antibodies against IgA, IgG, and, in some cases IgM, which are bound on small latex particles, are added and then the number of donor spermatozoa with attached immunobeads are counted (WHO 2009).

Spermatozoal antibodies are found in about 2–3% of the general population. The possibility of causing an amplified immunological response to intrauterine insemination using a high number of spermatozoa could not be confirmed in any of several studies (Marshburn and Kutteh 1994).

Sperm antibodies in the cervical mucus are inversely correlated with the number of live sperm during the post-coital test. However, a positive correlation between circulating antibodies and pregnancy rates cannot be proven (Eggert-Kruse et al. 1989). In conclusion, the significance of female antibodies has yet to be determined. Serum antibody testing is decidedly not an integral part of routine screening of the infertile couple. If a pathological postcoital test is found despite good cervical factors, the cervical secretion should be tested for antibodies. This is also true for other cases of unexplained infertility.

20.5.3 Treatment

The detection of sperm antibodies in combination with protracted involuntary childlessness only indicates

subfertility, since studies have shown that these antibodies do not absolutely impede spontaneous pregnancy. Different strategies have been recommended to optimize the probability of conception.

- The use of condoms for several months has been recommended in the past in order to inhibit boosting of the immunological response. Higher pregnancy rates, have, however, not been achieved through this method.
- The results of **immune-suppressive treatment with glucocorticoids** vary. Since the significance of female antibodies is not clear, and the side-effects of this treatment can be severe, it should not be recommended.
- Similarly **intrauterine insemination** does not seem to elevate pregnancy rates significantly. Clinical studies showed that after 6 months of intrauterine insemination, pregnancy rates were equal to those of patients without sperm antibodies who also had poor postcoital tests (42.4% vs. 40.5%) (Check et al. 1994). This shows that these antibodies do not play a very large role in infertility.

It is not clear if IVF outcome is influenced by female sperm antibodies. Some studies show poorer fertilization results in these cases. In a study of 2,363 patients, no differences in the pregnancy rates could be found between women with or without sperm antibodies (Check et al. 1995).

20.6 Early Pregnancy Abnormalities

20.6.1 Implantation

After fertilization occurs in the ampulla of the Fallopian tube, rapid cell division begins. Details of this development are described in Sect. 4.7. About 6–8 days after conception, the blastocyte is implanted in the uterine cavity, and hCG production can be measured as a sign of implantation. Once pregnancy has been established, the gynecologist will calculate gestational age, necessary for monitoring pregnancy, and the estimated date of birth. Using Nägele's rule, the birth date can be determined by subtracting 3 months from the date of the last menstrual period while adding 7 days to the first day of the last menstruation. This rule is based on

a normal 28-day cycle, and if ovulation occurs prior to or later than the 14th day, the EDD must be corrected accordingly. Deviation from the accepted conventions of calculating gestational age can cause considerable misunderstandings and incorrect evaluation of early pregnancy.

20.6.2 Pregnancy Loss

Conception and implantation do not suffice to consider infertility treatment as successful since many couples will experience pregnancy loss.

If fetal weight is below 500 g at birth, abortion or miscarriage has occurred. Fetal weight over 500 g of a child born dead is considered a stillbirth. About 15% of all pregnancies end in abortion, with clinically recognizable fetal loss between the 4th and 20th gestational week. The more accurate figure is about 50% of all pregnancies which end in abortion as many patients abort between the 2nd and 4th gestational week before pregnancy becomes clinically evident, during the time in which early β -hCG measurements are not routinely performed.

Eighty percent of spontaneous abortions occur during the first 12 weeks of pregnancy. Seventy percent of these abortions are due to chromosomal defects. Whereas young women at the age of 20 years have an abortion frequency of about 12%, older women at the end of their reproductive life have an abortion frequency of 26%. The probability of an abortion increases significantly when implantation is delayed (Wilcox et al. 1999). If a normal embryo can be detected by ultrasound, the probability of later abortion sinks to about 5%. If, however, there is a past history of several abortions, this rate rises by a factor of 4–5 (van Leeuwen et al. 1993).

20.6.3 Epidemiology

One miscarriage is, as can be seen above, not unusual, in fact one miscarriage is almost a normal experience of female reproductive life. Recurrent pregnancy loss is pathological and is defined as at least three consecutive miscarriages. Based on several clinical studies, the risk of a further miscarriage lies between 30% and 45% and does not, as was once presumed, rise further.

For a review of possible causes and therapy see Rai and Regan (2006).

20.6.4 Etiologic Factors

A study of 500 patients with recurrent pregnancy loss gives indications of the frequency of varying possible factors (Clifford et al. 1994). Seventy-six percent of the examined women had miscarriages before the 13th gestational week. Only 3% had a clinical abortion after this time.

- In 3.6% of all examined couples a **chromosomal defect** could be found, in which a balanced translocation was the most common diagnosis.
- Fifty-six percent of the women had morphologic signs of **polycystic ovarian disease**. Twelve percent of these women had mid-follicle LH levels greater than 10IU/l.
- Further analysis of the LH concentrations using daily early morning urine analysis showed a **hypersecretion of LH** in 57% of the women.
- In the group of 372 women with early miscarriage, 14% had measurable anti-phospholipid antibodies.
- Nine women showed **uterine anomalies** in which six had uterine septae, and three a uterus bicornis. HLA-typing was not done in these patients.

A history of male chemotherapy or radiation therapy increases the potential for **chromosomal defects**, so that in addition to fetal anomalies, elevated miscarriage rates are also possible (Meistrich 1993).

Environmental factors and other **toxins** such as smoking, high caffeine intake, and alcohol have been discussed as etiological agents for miscarriage. Anesthetic gases and cleaning solvents have been discussed as typical hazards of the working environment. Elucidation of the causes is usually not possible in the individual case.

If chromosomal defects can be ruled out, endocrine factors must be considered. Thyroidal dysfunction, autoimmune diseases, and poorly adjusted diabetes mellitus have been associated with miscarriages, but probably do not play a major role in infertility patients.

The importance of an **insufficient luteal phase** and **polycystic ovarian disease** has been discussed. It is not clear whether support of the luteal phase by progesterone or hCG treatment can improve pregnancy

rates. A significant effect of hCG-treatment in IVF cycles with GnRH analogs can be seen on luteal function. These results are, however, controversial in other clinical situations. In one of the latest clinical studies it could be shown that in patients with sufficient down-regulation by GnRH analogs, substitution with hCG or progesterone resulted in similar pregnancy rates (Soliman et al. 1994).

Uterine anomalies. About 12–15% of all women with recurrent pregnancy loss have a uterine anomaly which can be confirmed by vaginal ultrasound examination and/or hysterosalpingography. In 1,200 HSG examinations 188 congenital uterus anomalies were found (Makino et al. 1992). The miscarriage rate did not differ between those with a slight anomaly or those with more extreme variations. After surgical correction through metroplasty, 84% of the resulting pregnancies could be carried to term. In 74 women who had not yet received surgical treatment and were used as controls, 94% of the pregnancies ended in spontaneous abortion before the 12th gestational week. These data show the importance of checking for uterine anomalies in patients with recurrent pregnancy loss.

Infections. The significance of infectious diseases especially in abortions occurring after the 12th gestational week is noteworthy. Microbial samples should be checked for chlamydia, ureaplasma, toxoplasmosis and *Listeria monocytogenes* as well as *Mycoplasma hominis*.

Autoimmunity. Ten to 16% of women with recurrent pregnancy loss have antiphospholipid antibodies (Plouffe et al. 1992). These antibodies block prostacycline synthesis, and result in high thromboxane activity with vasoconstriction and thrombosis. This in turn causes foetal growth retardation or fetal death, often in the form of recurrent miscarriage. Prothrombin time and partial thromboplastin time are elevated by antiphospholipid antibodies, and can be used as screening tests. If antiphospholipid antibodies are presumed to be the cause of recurrent pregnancy loss, treatment in form of low-dose aspirin in combination with heparin can begin as soon as pregnancy has been diagnosed. Treatment with glucocorticoids with dose titration until coagulation tests become normal have also been recommended.

Alloimmunity. A widely accepted theory states that the maternal immune systems develops a certain tolerance against the trophoblast owing to protective antibodies or blocking factors. These hypothetical factors

possibly block the rejection of the autoallogenic embryo. The mechanism is, however, not clear. A rejection of the pregnancy is presumed to occur if the blocking factors fail to be produced. One possible explanation has been suggested by findings in HLA measurements, since couples with recurrent pregnancy loss often have compatible HLA antigens.

Based on this theory, patients with recurrent miscarriages were **immunized with partner lymphocytes**. The first results were very impressive with pregnancy rates of 70–80%. Clinical trials, however, have been very conflicting, and were not able to confirm the results of the early uncontrolled studies. This resulted in a rejection of this form of therapy (Fraser et al. 1993), which in turn was, however, contradicted by other investigators (Cowchock and Smith 1994). If there is an effect of immunization, it is very small and has a causal success in less than 5% of those treated. Since immunization treatment is not without risk, each individual case must be decided by the responsible physician.

As an alternative treatment form to active immunization some have recommended treatment with **unspecific immunoglobulins**. A larger multicenter study, however, came to the conclusion that the diagnostic and prognostic value of HLA-typing has been overestimated (Mueller-Eckhardt 1994). Intravenous treatment with immunoglobulins and albumin was seen equal to that of placebo (Mueller-Eckhardt 1994). An up-to-date meta-analysis of immune therapy in habitual miscarriages with respect to the live-birth rate showed no effect of immunization with paternal cells, donor leucocytes, trophoblast material or immunoglobulins i.v. compared to placebo (Porter et al. 2006).

20.7 Idiopathic Infertility

If all tests described above show normal results, and no causes for infertility can be found, this is called “idiopathic infertility”. This must be differentiated from the so-called idiopathic infertility of the male, which is characterized by an unexplained reduction of the semen quality. In 10–15% of infertile couples no clear cause can be defined (Crosignani et al. 1993). Prognosis of this condition is correlated with the couple’s age and the length of infertility (see above).

In contrast to the normal monthly fecundity rate of 25%, couples with idiopathic infertility have a conception

rate of 1.5–3% per cycle. Patience and time alone will result in pregnancy in about 60% of the couples with idiopathic infertility (Verkauf 1983). As a rule, no treatment should be performed if a diagnosis cannot be made. Empirical studies, however, have shown that methods of assisted reproduction result in higher pregnancy rates in couples with unexplained infertility. If a couple with idiopathic infertility does not achieve pregnancy within 3 years, stimulation with hMG in combination with intrauterine insemination may be considered. If a conception is not achieved within 4–6 months, IVF may be performed. The results of this therapy may also be diagnostic in nature. If fertilization occurs and pregnancy does not follow, another trial of conservative therapy with hMG stimulation may be justified. Following this strategy, a cumulative pregnancy rate of 40% is achieved after six cycles with superovulation or after three cycles of IVF (Simon and Laufer 1993).

20.8 Prospects and Conclusion

If, despite all therapeutic efforts, delivery of a baby cannot be achieved, concluding treatment is a major step. Determining to end treatment signifies a failure for the couple as well as the physician, and represents a psychological burden for everyone involved. In their despair, many couples may look for treatment by another physician and undergo the entire procedure a second time. Couples must be counselled so that they can plan the rest of their lives accordingly. Psychological counselling should be an integral part not only during treatment, but also at its conclusion. Further possibilities such as heterologous insemination or adoption must be discussed carefully and with empathy with the couple.

References

- Abbott DH, Barnett DK, Bruns CM, Dumesic DA (2005) Androgen excess fetal programming of female reproduction: A developmental aetiology for polycystic ovary syndrome? *Hum Reprod Update* 11:357–374
- Adashi EY, Rock JA, Guzick D, Wentz AC, Jones GS, Jones HW Jr (1981) Fertility following bilateral ovarian wedge resection: A critical analysis of 90 consecutive cases of the polycystic ovary syndrome. *Fertil Steril* 36:320–325

- Adelusi B, Alnuaim L, Makanjuola D, Khashoggi T, Chowdhury N, Kangave D (1995) Accuracy of hysterosalpingography and laparoscopic hydrotubation in diagnosis of tubal patency. *Fertil Steril* 63:1016–1020
- Agarwal SK, Haney AF (1994) Does recommending timed intercourse really help the infertile couple? *Obstet Gynecol* 84:307–310
- Al-Qahtani A, Groome NP (2006) Anti-Mullerian hormone: Cinderella finds new admirers. *J Clin Endocrinol Metab* 91:3760–3762
- Allahbadia GN (1992) Fallopian tubes and ultrasonography – the Sion experience. *Fertil Steril* 58:901–907
- Arlt W, Callies F, van Vlijmen JC, Koehler I, Reincke M, Bidlingmaier M, Huebler D, Oettel M, Ernst M, Schulte HM, Allolio B (1999) Dehydroepiandrosterone replacement in women with adrenal insufficiency. *N Engl J Med* 341:1013–1020
- Azziz R, Carmina E, Dewailly D, et al. (2006) Positions statement: Criteria for defining polycystic ovary syndrome as a predominantly hyperandrogenic syndrome: An Androgen Excess Society guideline. *J Clin Endocrinol Metab* 91:4237–4245
- Badawy A, Mosbah A, Shady M (2008) Anastrozole or letrozole for ovulation induction in clomiphene-resistant women with polycystic ovarian syndrome: a prospective randomized trial. *Fertil Steril* 89:1209–1212
- Bairdt DT, Howles CM (1994) Induction of ovulation with gonadotrophins: hMG versus purified FSH. In: Filicori M, Flamigni C (eds) *Ovulation induction: Science and clinical advances*. Elsevier, Amsterdam, pp 135–151
- Bakimer R, Cohen JR, Shoenfeld Y (1994) What really happens to fecundity in autoimmune diseases? *Immunol Allergy Clin North Am* 14:701–723
- Bancroft J (1993) Impact of environment, stress, occupational, and other hazards on sexuality and sexual behavior. *Environ Health Perspect* 101(Suppl 2):101–107
- Banks AL (1961) Does adoption affect infertility? *Int J Fertil* 7:23–28
- Baranski B (1993) Effects of the workplace on fertility and related reproductive outcomes. *Environ Health Perspect* 101(Suppl 2):81–90
- Bhal PS, Pugh ND, Chui DK, Gregory L, Walker SM, Shaw RW (1999) The use of transvaginal power Doppler ultrasonography to evaluate the relationship between perfollicular vascularity and outcome in in-vitro fertilization treatment cycles. *Hum Reprod* 14:939–945
- Blasco L (1994) Dyssynchrony in the maturation of endometrial glands and stromae. *Fertil Steril* 61:596–597
- Börner P (1986) Gynäkologische Erkrankungen. In: Künzel W, Wulf KK (eds) *Die gestörte Schwangerschaft, Klinik der Frauenheilkunde und Geburtshilfe, Band 5. Urban und Schwarzenberg, München Wien Baltimore*, pp 343–363
- Bohnet HG (1985) Prolactin und weibliche Sterilität. Leitfaden für die Praxis. Grosse, Berlin
- Bohnet HG, Kato K, Wolf SA (1986) Treatment of hyperprolactinemic amenorrhea with Metergoline. *Obstet Gynecol* 67:249–251
- Bokemeyer C, Schmoll HJ, Vanrhee J, Kuczyk M, Schuppert F, Poliwoda H (1994) Long-term gonadal toxicity after therapy for Hodgkins and non-Hodgkins lymphoma. *Ann Hematol* 68:105–110
- Brocklehurst P, French R (1998) The association between maternal HIV infection and perinatal outcome: A systematic review of the literature and meta-analysis. *Br J Obstet Gynaecol* 105:836–848
- Buttery B, Trounson A, McMaster R, Wood C (1983) Evaluation of diagnostic ultrasound as a parameter of follicular development in an in vitro fertilization program. *Fertil Steril* 39:458–463
- Buttram VC Jr, Vaquero C (1975) Post ovarian wedge resection adhesive disease. *Fertil Steril* 26:874–876
- Chang WY, Knochenhauer ES, Bartolucci AA, Azziz R (2005) Phenotypic spectrum of polycystic ovary syndrome: Clinical and biochemical characterization of the three major clinical subgroups. *Fertil Steril* 83:1717–1723
- Check JH, Bollendorf A, Katsoff D, Kozak J (1994) The frequency of antisperm antibodies in the cervical mucus of women with poor postcoital tests and their effect on pregnancy rates. *Am J Reprod Immunol* 32:38–42
- Check JH, Katsoff D, Bollendorf A, Callan C (1995) The effect of sera antisperm antibodies in the female partner on in vivo and in vitro pregnancy and spontaneous abortion rates. *Am J Reprod Immunol* 33:131–133
- Chrousos GP (1995) *Seminars in medicine of the Beth Israel Hospital, Boston: The hypothalamic-pituitary-adrenal axis and immune-mediated inflammation*. *N Engl J Med* 332:1351–1362
- Chun SY, Hsueh AJW (1999) Paracrine mechanisms of ovarian follicle apoptosis. *J Reprod Immunol* 39:63–75
- Clayton RN, Ogden V, Hodgkinson J, Worswick L, Rodin DA, Dyer S, Meade TW (1992) How common are polycystic ovaries in normal women and what is their significance for the fertility of the population. *Clin Endocrinol* 37:127–134
- Clifford K, Rai R, Watson H, Regan L (1994) An informative protocol for the investigation of recurrent miscarriage: Preliminary experience of 500 consecutive cases. *Hum Reprod* 9:1328–1332
- Committee on the Biological Effect of Ionizing Radiations (1990) *Health effects of exposure to low levels of ionizing radiation (BEIR V)*. National Academy Press, Washington, DC
- Corson SL, Gutmann J, Batzer FR, Wallace H, Klein N, Soules MR (1999) Inhibin-B as a test of ovarian reserve for infertile women. *Hum Reprod* 14:2818–2821
- Cowchock S, Smith JB (1994) Immunization as therapy for recurrent spontaneous abortion – A review and meta-analysis (letter). *Obstet Gynecol* 83:637–638
- Critchley HOD, Wallace WHB, Shalet SM, Mamtora H, Higginson J, Anderson DC (1992) Abdominal irradiation in childhood – the potential for pregnancy. *Br J Obstet Gynaecol* 99:392–394
- Crosignani PG, Collins J, Cooke ID, Diczfalusy E, Rubin B (1993) Unexplained infertility. *Hum Reprod* 8:977–980
- Csapo AI, Pulkkinen MO, Wiest WG (1973) Effect of lutectomy and early progesterone replacement therapy in early pregnant patients. *Am J Obstet Gynecol* 115:759–765
- Davis SR (1999a) Androgen replacement in women: a commentary. *J Clin Endocrinol Metab* 84:1886–1891
- Davis SR (1999b) The therapeutic use of androgens in women. *J Steroid Biochem Mol Biol* 69:177–184
- Degenhardt F, Jibril S, Gohde M, Eisenhauer B, Schlößer HW (1995) Die ambulante Hystero-Kontrast-Sonographie

- (HKSG) als Möglichkeit zur Kontrolle der Tubendurchgängigkeit. *Geburtsh Frauenheilk* 55:143–149
- De Geyter C, Schmitter M, De Geyter M, Nieschlag E, Holzgreve W, Schneider HPG (2000) Prospective evaluation of the ultrasound appearance of the endometrium in a cohort of 1,186 infertile women. *Fertil Steril* 73:106–113
- Deichert I, Hackeloer B, Daume E (1986) The sonographic and endocrinologic evaluation of the endometrium in the luteal phase. *Human Reprod* 1:219–222
- Dennerstein L, Gotts G, Brown JB, Morse CA, Farley TMM, Pinol A (1994) The relationship between the menstrual cycle and female sexual interest in women with premenstrual symptom complaints and volunteers. *Psychoneuroendocrinol* 19:293–304
- Dmowski WP, Friberg J, Rana N, Papierniak C, Michalowska J, Elroey A (1995) The effect of endometriosis, its stage and activity, and of autoantibodies on in vitro fertilization and embryo transfer success rates. *Fertil Steril* 63:555–562
- Dottorini ME, Lomuscio G, Mazzucchelli L, Vignati A, Colombo L (1995) Assessment of female fertility and carcinogenesis after iodine¹³¹ therapy for differentiated thyroid carcinoma. *J Nuclear Med* 36:21–22
- Dunaif A (1999) Insulin action in the polycystic ovary syndrome. *Endocrinol Metab Clin North Am* 28:341–359
- Dunson DB, Baird DD, Wilcox AJ, Weinberg CR (1999) Day-specific probabilities of clinical pregnancy based on two studies with imperfect measures of ovulation. *Hum Reprod* 14:1835–1839
- Ebbiary NAA, Lenton EA, Cooke ID (1994) Hypothalamic-pituitary ageing: Progressive increase in FSH and LH concentrations throughout the reproductive life in regularly menstruating women. *Clin Endocrinol* 41:199–206.
- Eggert-Kruse W, Leinhos G, Gerhard I, Tilgen W, Runnebaum B (1989) Prognostic value of in vitro sperm penetration into hormonally standardized human cervical mucus. *Fertil Steril* 51:317–323
- Eggert-Kruse W, Pohl S, Naher H, Tilgen W, Runnebaum B (1992) Microbial colonization and sperm mucus interaction – Results in 1,000 infertile couples. *Hum Reprod* 7:612–620
- Eimers JM, Tevelde ER, Gerritse R, Vogelzang ET, Looman CWN, Habbema JDF (1994) The prediction of the chance to conceive in subfertile couples. *Fertil Steril* 61:44–52
- Farquhar C, Lilford RJ, Marjoribanks J, Vandekerckhove P (2007) Laparoscopic “drilling” by diathermy or laser for ovulation induction in anovulatory polycystic ovary syndrome. *Cochrane Database Syst Rev* 3:CD001122
- Filicori M (1994) Use of GnRH and its analogs in the treatment of ovulatory disorders: An overview. In: Filicori M, Flamigni C (eds) *Ovulation induction: Basic science and clinical advances*. Elsevier, Amsterdam/London/New York/Tokyo, pp 239–243
- Flamigni C, Borini A, Violini F, Bianchi L, Serrao L (1993) Oocyte donation – Comparison between recipients from different age groups. *Hum Reprod* 8:2088–2092
- France JT, Graham FM, Gosling L, Hair P, Knox BS (1992) Characteristics of natural conceptual cycles occurring in a prospective study of sex preselection – Fertility awareness symptoms, hormone levels, sperm survival, and pregnancy outcome. *Int J Fertil* 37:244–255
- Fraser EJ, Grimes DA, Schulz KF (1993) Immunization as therapy for recurrent spontaneous abortion – A review and meta-analysis. *Obstet Gynecol* 82:854–859
- French R, Brocklehurst P (1998) The effect of pregnancy on survival in women infected with HIV: A systematic review of the literature and meta-analysis. *Br J Obstet Gynaecol* 105:827–835
- Ginsburg J, Hardiman P, Thomas M (1992) Vaginal bromocriptine – clinical and biochemical effects. *Gynecol Endocrinol* 6:119–126
- Giudice LC, Kao LC (2004) Endometriosis. *Lancet* 364:1789–1799
- Gleicher N, Pratt D, Parrilli M, Karande V, Redding L (1992) Standardization of hysterosalpingography and selective salpingography – A valuable adjunct to simple opacification studies. *Fertil Steril* 58:1136–1141
- Gnoth C, Schüring AN, Friol K, Tigges J, Mallmann P, Godehardt E (2008) Relevance of anti-Müllerian hormone measurement in a routine IVF program. *Hum Reprod* 23:1359–1365
- Gülekli B, Bulbul Y, Onvural A, Yorukoglu K, Posaci C, Demir N, Erten O (1999) Accuracy of ovarian reserve tests. *Hum Reprod* 14:2822–2826
- Heckers H, Lasch H-G (1986) Gastrointestinale Erkrankungen aus internistischer Sicht. In: Künzel W, Wulf K.-K. (eds) *Die gestörte Schwangerschaft. Klinik der Frauenheilkunde und Geburtshilfe*, Band 5. Urban und Schwarzenberg, München Wien Baltimore, pp 133–148
- Hehenkamp WJK, Looman CWN, Themmen APN, de Jong FH, te velde ER, Broekmans FJM (2006) Anti-Müllerian hormone levels in the spontaneous menstrual cycle do not show substantial fluctuation. *J Clin Endocrinol Metab* 91:4057–4063
- Hermes V (1989) Funktionelle Sexualstörungen. In: Schneider HPG (ed) *Sexualmedizin, Infertilität, Familienplanung. Klinik der Frauenheilkunde und Geburtshilfe*. Band 2. Urban und Schwarzenberg, München Wien Baltimore, pp 52–58
- Hjollund NHI, Jensen TK, Bonde JPE, Henriksen TB, Andersson AM, Kolstad HA, Ernst E, Giwercman A, Skakkebaek NE, Olsen J (1999) Distress and reduced fertility: A follow-up study of first-pregnancy planners. *Fertil Steril* 72:47–53
- Holmes MM, Resnick HS, Kilpatrick DG, Best CL (1996) Rape-related pregnancy: Estimates and descriptive characteristics from a national sample of women. *Am J Obstet Gynecol* 175:320–325
- Holmgren U, Bergstrand G, Hagenfeldt K, Werner S (1986) Women with prolactinoma – effect of pregnancy and lactation on serum prolactin and on tumour growth. *Acta Endocrinol* 111:452–459
- Hoyne UB, Baumler C, Kotani T, Seuffer A (1988) Chlamydia trachomatis – Nachweis bei entzündlichen Erkrankungen der Eileiter. *Geburtsh Frauenheilkd* 48:876–880
- Hunault CC, Laven JSE, van Rooij IAJ, Eijkemans MJC, te Velde ER, Habbema JDF (2005) Prospective validation of two models predicting pregnancy leading to live birth among untreated subfertile couples. *Hum Reprod* 19:2019–2026
- Izembart M, Chavaudra J, Aubert B, Vallee G (1992) Retrospective evaluation of the dose received by the ovary after radioactive iodine therapy for thyroid cancer. *European J Nuclear Med* 19:243–247

- James WH (1979) The causes of the decline in fecundability with age. *Soc Biol* 26:330–334
- Jensen TK, Henriksen TB, Hjollund, NHI, Scheike T, Kolstad H, Giwercman A, Ernst E, Bonde JP, Skakkebaek NE, Olsen J (1998) Adult and prenatal exposures to tobacco smoke as risk indicators of fertility among 430 Danish couples. *Am J Epidemiol* 148:992–997
- Joffe M, Li ZM (1994) Male and female factors in fertility. *Am J Epidemiol* 140:921–929
- Johnson NP, Mak W, Sowter MC (2004) Surgical treatment for tubal disease in women due to undergo in vitro fertilisation. *Cochrane Database Syst Rev* CD002125
- Jones WR (1994) Gamete immunology. *Hum Reprod* 9: 828–841
- Joosten R, Stürner KH (1980) Hepatitis B Infektion des Neugeborenen durch seine scheinbar gesunde Mutter. *Med Klin* 75:223–224
- Jordan J, Craig K, Clifton DK, Soules MR (1994) Luteal phase defect: The sensitivity of diagnostic methods in common clinical use. *Fertil Steril* 62:54–62
- Joseph JA, Singer A, Jones H, Shafi MI (2006) The cervix, 2nd edn. Blackwell, Malden
- Josso N, Picard JY, Rey R, Clemente N (2006) Testicular anti-Müllerian hormone: history, genetics, regulation and clinical applications. *Pediatr Endocrinol Rev* 3:347–358
- Kanal E, Gillen J, Evans JA, Savitz DA, Shellock FG (1993) Survey of reproductive health among female MR workers. *Radiology* 187:395–399
- Kase N, Mroueh A, Olson L. (1967) Clomid therapy for anovulatory infertility. *Am J Obstet Gynecol* 98:1037–1042
- Kazer RR, Kessel B, Yen SSC (1987) Circulating luteinizing hormone pulse frequency in women with polycystic ovary syndrome. *J Clin Endocrinol Metab* 65:233–236
- Knuth UA, Mühlenstedt D (1991) Kinderwunschdauer, kontrazeptives Verhalten und Rate vorausgegangener Infertilitätsbehandlungen. *Geburtsh Frauenheilk* 51: 678–684
- Knuth UA, Hull MGR, Jacobs HS (1977) Amenorrhoea and loss of weight. *Brit J Obstet Gynecol* 84:801–807
- Knuth UA, Mühlenstedt D, Schneider HPG (1982) Zur Effektivität von Kurzwellenbelastungstests, Blutkörperchensenkungsgeschwindigkeit und Leukozytenzahl bei der Diagnose der subakuten Adnexitis. *Geburtsh Frauenheilk* 42:52–55
- Kremling H (1986) Harnorgane und ihre Erkrankungen. In: Künzel W, Wulf KK (eds) *Die gestörte Schwangerschaft, Klinik der Frauenheilkunde und Geburtshilfe, Band 5*. Urban und Schwarzenberg, München Wien Baltimore, pp163–184
- Legro RS, Barnhart HX, Schlaff WD, et al (2007) Clomiphene, metformin, or both for infertility in the polycystic ovary syndrome. *N Engl J Med* 356:551–566
- Lord JM, Flight IH, Norman RJ (2003) Metformin in polycystic ovary syndrome: systematic review and meta-analysis. *BMJ* 327:951–953
- MacLeod J, Gold RZ (1953) The male factor in fertility and infertility VI. Semen quality and certain other factors in relation to ease of conception. *Fertil Steril* 4:10–33
- Makino T, Umeuchi M, Nakada K, Nozawa S, Iizuka R (1992) Incidence of congenital uterine anomalies in repeated reproductive wastage and prognosis for pregnancy after metroplasty. *Int J Fertil* 37:167–170
- Marshburn PB, Kutteh WH (1994) The role of antisperm antibodies in infertility. *Fertil Steril* 61:799–811
- Massarano AA, Adams JM, Preece MA, Brook CGD (1989) Ovarian ultrasound appearances in Turner syndrome. *J Pediatr* 114:569–573
- McNeely MJ, Soules MR (1988) The diagnosis of luteal phase deficiency: A critical review. *Fertil Steril* 50:1–15
- Meistrich ML (1993) Potential genetic risks of using semen collected during chemotherapy. *Hum Reprod* 8:8–10
- Moll E, Bossuyt PM, Korevaar JC, Lambalk CB, van der Veen F (2006) Effect of clomifene citrate plus metformin and clomifene citrate plus placebo on induction of ovulation in women with newly diagnosed polycystic ovary syndrome: randomised double blind clinical trial. *Brit Med J* 332: 1485–1490
- Moran LJ, Brinkworth G, Noakes M, Norman RJ (2006). Effects of lifestyle modification in polycystic ovarian syndrome. *Reprod Biomed Online* 12:569–578
- Morini A, Spina V, Aleandri V, Cantonetti G, Lambiasi A, Papalia U (1998) Pregnancy after heart transplant: update and case report. *Hum Reprod* 13:749–757
- Mueller-Eckhardt G (1994) Immunotherapy with intravenous immunoglobulin for prevention of recurrent pregnancy loss: European experience. *Am J Reprod Immunol* 32: 281–285
- Nakhuda GS, Chu MC, Wang JG, Sauer MV, Lobo RA (2006) Elevated serum Müllerian-inhibiting substance may be a marker for ovarian hyperstimulation syndrome in normal women undergoing in vitro fertilisation. *Fertil Steril* 85: 1541–1543
- Negro-Vilar A (1993) Stress and other environmental factors affecting fertility in men and women – Overview. *Environ Health Perspect* 101(Suppl 2):59–64
- Nieschlag E, Weinbauer GF, Cooper TG, Wittkowski W (1999) Reproduktion. In: Deetjen P, Speckmann EF (eds) *Physiologie, 3. Aufl.* Urban u. Fischer, München, p 525
- Norman RJ, Dewailly D, Legro RS, Hickey TE (2007) Polycystic ovary syndrom. *Lancet* 370:685–697
- Ogilvy-Stuart AL, Shalet SM (1993) Effect of radiation on the human reproductive system. *Environ Health Perspect* 101(Suppl 2):109–116
- Opsahl MS, Miller B, Klein TA (1993) The predictive value of hysterosalpingography for tubal and peritoneal infertility factors. *Fertil Steril* 60:444–448
- Pigny P, Jonard S, Robert Y, Dewailly D (2006) Serum anti-Müllerian hormone as a surrogate for antral follicle count for definition of the polycystic ovary syndrome. *J Clin Endocrinol Metab* 91:941–945
- Plouffe L, White EW, Tho SP, Sweet CS, Layman LC, Whitman GF, McDonough PG (1992) Etiologic factors of recurrent abortion and subsequent reproductive performance of couples – Have we made any progress in the past ten years? *Am J Obstet Gynecol* 167:313–321
- Porter TF, LaCoursiere Y, Scott JR (2006) Immunotherapy for recurrent miscarriage. *Cochrane Database Syst Rev*. 19:CD000112
- Qublan H, Amarin Z, Nawasreh M, Diab F, Malkawi S, Al-Ahmad N, Balawneh M (2006) Luteinized unruptured follicle syndrome: incidence and recurrence rate in infertile women with unexplained infertility undergoing intrauterine insemination. *Hum Reprod* 21:2110–2113

- Queenan JT, O'Brian GD, Bains LM, Simpson J, Collins WP, Campbell S (1980) Ultrasound scanning of ovaries to detect ovulation in women. *Fertil Steril* 34:99–105
- Quint WGV, Fetter WPF, Vanos HC, Heijtkink RA (1994) Absence of hepatitis-B virus (HBV) DNA in children born after exposure of their mothers to HBV during in vitro fertilization. *J Clin Microbiol* 32:1099–1100
- Rachootin P, Olsen J (1983) The risk of infertility and delayed conception associated with exposure in the Danish workplace. *J Occup Med* 25:394–402
- Rai R, Regan L (2006) Recurrent miscarriage. *Lancet* 368: 601–611
- Resti M, Azzari C, Manelli AF, Moriondo M, Novembre E, deMartino M, Vierucci A (1998) Mother to child transmission of hepatitis C virus: Prospective study of risk factors and timing of infection in children born to women seronegative for HIV-1. *Br Med J* 317:437–440
- Richardson DW, Goldsmith LT, Pohl CR, Schallenger E, Knobil E (1985) The role of prolactin in the regulation of the primate corpus luteum. *J Clin Endocrinol Metab* 60: 501–504
- Rosenfield RL (1999) Ovarian and adrenal function in polycystic ovary syndrome. *Endocrinol Metab Clin North Am* 28:265–293
- Rotterdam ESHRE/ASRM-Sponsored PCOS Consensus Workshop Group (2004). Revised 2003 consensus on diagnostic criteria and long-term health risks related to polycystic ovary syndrome (PCOS). *Hum Reprod* 19:41–47
- Rowland AS, Baird DD, Weinberg CR, Shore DL, Shy CM, Wilcox AJ (1994) The effect of occupational exposure to mercury vapour on the fertility of female dental assistants. *Occup Environ Med* 51:28–34
- Schlechte JA (2003) Prolactinoma. *N Engl J Med* 349: 2035–2041
- Schneider HPG, Karbowski B (1989) In: Schneider HPG (ed) *Sexualmedizin, Infertilität, Familienplanung, Klinik der Frauenheilkunde und Geburtshilfe, Band 2*. Urban und Schwarzenberg, München Wien Baltimore, pp 373–384
- Schnell JD (1973) *Zytologie und Mikrobiologie der Vagina*. Wissenschaftsverlag, Köln
- Schwartz P, Mayaux MJ (1982) Female fecundity as a function of age. *N Engl J Med* 306:404–406
- Schweppe KH (1995) Therapieprinzipien der Endometriose. *Der Frauenarzt* 36:558–571
- Scialli AR (1994) Data availability in reproductive and developmental toxicology. *Obstet Gynecol* 83:652–656
- Seibel MM, Berger MJ, Weinstein FG, Taymor ML (1982) The effectiveness of danazol on subsequent fertility in minimal endometriosis. *Fertil Steril* 38:534–537
- Shangold MM, Turksoy RN, Bashford RA, Hammond CB (1977) Pregnancy following the “insensitive ovary syndrome”. *Fertil Steril* 28:1179–1181
- Shippen ER, West WJ Jr. (2004) Successful treatment of severe endometriosis in two premenopausal women with an aromatase inhibitor. *Fertil Steril* 81:1395–1398
- Simon A, Laufer N (1993) Unexplained infertility: A reappraisal. *Assist Reprod Rev* 3:26–31
- Simon C, Gutierrez A, Vidal A, Delossantos MJ, Tarin JJ, Remohi J, Pellicer A (1994) Outcome of patients with endometriosis in assisted reproduction: Results from in-vitro fertilization and oocyte donation. *Hum Reprod* 9:725–729
- Soliman S, Daya S, Collins J, Hughes EG (1994) The role of luteal phase support in infertility treatment: A meta-analysis of randomized trials. *Fertil Steril* 61:1068–1076
- Soules MR (1993) Luteal dysfunction. In: Adashi EY, Leung PCK (eds) *The ovary*. Raven, New York, pp 607–627
- Speroff L, Glass RH, Kase NG (1994) *Clinical gynecologic endocrinology and infertility*. Williams and Wilkins, Baltimore/Philadelphia/HongKong/London/Munich/Sydney/Tokyo, pp 426–434
- Steiner AZ, Terplan M, Paulson RI (2005) Comparison of tamoxifen and clomiphene citrate for ovulation induction: a meta-analysis. *Hum Reprod* 20:1511–1515
- Stovall DW, Christman GM, Hammond MG, Talbert LM (1992) Abnormal findings on hysterosalpingography – Effects on fecundity in a donor insemination program using frozen semen. *Obstet Gynecol* 80:249–252
- Strandell A, Lindhard A (2002) Why does hydrosalpinx reduce fertility? The importance of hydrosalpinx fluid. *Hum Reprod* 17:1141–1145
- Streuli I, Fraise T, Pillet C, Ibecheole V, Bischof P, de Ziegler D (2008) Serum antimüller hormone levels remain stable throughout the menstrual cycle and after oral or vaginal administration of synthetic sex steroids. *Fertil Steril* 90: 395–400
- Tai JH, Udoji MA, Barkanic G, Byrne DW, Rebeiro PF, Byram BR, Kheshti A, Carter JD, Graves CR, Raffanti SP, Sterling TR (2007) Pregnancy and HIV Disease Progression during the Era of Highly Active Antiretroviral Therapy. *J Infect Dis* 196:1044–1052
- Tandler-Schneider A, Sonnerberg-Schwan U, Ginkelmaier A, Meurer A, Kremer H, Weigel M, Vernazza P, Schmied B, Klumb S, Schafberger A, Kupka M, Friese K, Brockmeyer NH (2008) Diagnostik und Behandlung HIV-betroffener Paare mit Kinderwunsch. *Frauenarzt* 49:697–703
- Themmen APN (2005) An update of the pathophysiology of human gonadotrophin subunit and receptor gene mutations and polymorphisms. *Reproduction* 130:263–274
- The Practice Committee of the American Society for Reproductive Medicine (2006a) Guidelines for reducing the risk of viral transmission during fertility treatment. *Fertil Steril* 86(Suppl 4):S11–17
- The Practice Committee of the American Society for Reproductive Medicine (2006b) Hepatitis and reproduction. *Fertil Steril* 86(Suppl 4):S131–141
- Thonneau P, Ducot B, Spira A (1993) Risk factors in men and women consulting for infertility. *Int J Fertil* 38:37–43
- Traish A, Guay AT, Spark RF and the Testosterone Therapy in Women Study Group (2007) Are the endocrine society’s clinical practice guidelines on androgen therapy in women misguided? A commentary. *J Sex Med* 4:1223–1235
- Tulandi T, Martin J, Al-Fadhli R, Kabli N, Forman R, Hitkari J, Librach C, Greenblatt E, Casper RF (2006) Congenital malformations among 911 newborns conceived after infertility treatment with letrozole or clomiphene citrate. *Fertil Steril* 85:1761–1765
- Udoff LC, Adashi EY (1999) Autocrine/paracrine regulation of the ovarian follicle. *Endocrinologist* 9:99–106
- Van der Poel CL, Cuyper HT, Reesink HW (1994) Hepatitis C virus six years on. *Lancet* 344:1475–1479
- van Leeuwen I, Branch DW, Scott JR (1993) First trimester ultrasonography findings in women with a history of recurrent pregnancy loss. *Am J Obstet Gynecol* 168:111–114

- van Rooij IA, Broekmans FJ, te Velde ER, Fauser BC, Bansci LF, de Jong FH, Themmen AP (2002) Serum anti-Müllerian hormone levels: a novel measure of ovarian reserve. *Hum Reprod* 17:3065–3071
- Venezia R, Zangara C, Knight C, Cittadini E (1993) Initial experience of a new linear everting falloposcopy system in comparison with hysterosalpingography. *Fertil Steril* 60:771–775
- Vercellini P, Maddalena S, DeGiorgi O, Aimi G, Crosignani PG (1998) Abdominal myomectomy for infertility: A comprehensive review. *Hum Reprod* 13:873–879
- Verkauf BS (1983) The incidence and outcome of single-factor, multifactorial and unexplained infertility. *Am J Obstet Gynecol* 147:175–181
- Vink JM, Sadrzadeh S, Lambalk CB, Boomsma DI (2006) Heritability of polycystic ovary syndrome in a Dutch twin-family study. *J Clin Endocrinol Metab* 91:2100–2104
- Visser JA, de Jong FH, Laven JSE, Themmen AP (2006) Anti-Müllerian hormone: A new marker for ovarian function. *Reproduction* 131:1–9
- Watson A, Vandekerckhove P, Lilford R, Vail A, Brosens I, Hughes E (1994) A meta-analysis of the therapeutic role of oil soluble contrast media at hysterosalpingography – A surprising result. *Fertil Steril* 61:470–477
- Wathen NC, Perry L, Lilford RJ, Chard T (1984) Interpretation of single progesterone measurement in diagnosis of anovulation and defective luteal phase: Observation of the normal range. *Brit Med J* 288:7–9
- WHO Laboratory Manual for the Examination and Processing of Human Sperm (2009) 5th edn. World Health Organization, Geneva (in press)
- Wierman ME, Basson R, Davis SR, Khosla S, Miller KK, Rosner W, Santoro N (2006) Androgen Therapy in Women: An Endocrine Society Clinical Practice Guideline. *J Clin Endocrinol Metab* 91:3697–3716
- Wildt L, Leyendecker G, Sir Petermann T, Weibeltreber S (1993) Treatment with Naltrexone in hypothalamic ovarian failure – Incidence of ovulation and pregnancy. *Hum Reprod* 8:350–358
- Wischmann T (2006) The Psychogenesis of Infertility: An Overview. *Geburtsh Frauenheilk* 66:34–43
- Wilcox AJ, Baird DD, Weinberg CR (1999) Time of implantation of the conceptus and loss of pregnancy. *N Engl J Med* 340:1796–1799
- Yeh J, Seibel MM (1987) Artificial insemination with donor sperm: A review of 108 patients. *Obstet Gynecol* 70:313–316
- Young SL, Opsahl MS, Fritz MA (1999) Serum concentrations of enclomiphene and zuclomiphene across consecutive cycles of clomiphene citrate therapy in anovulatory infertile women. *Fertil Steril* 71:639–644
- Zeitoun KM, Bulun SE (1999) Aromatase: A key molecule in the pathophysiology of endometriosis and a therapeutic target. *Fertil Steril* 72:961–969
- Zitzmann M, Rolf C, Nordhoff V, Schröder G, Rickert-Föhring M, Gassner P, Behre HM, Greb RR, Kiesel L, Nieschlag E (2003) Male smokers have a decreased success rate for in vitro fertilization and intracytoplasmic sperm injection. *Fertil Steril* 79(Suppl 3):1550–1554

Contents

21.1	Indications and Preparations: An Overview	437
21.2	Pharmacology of Testosterone Preparations	439
21.2.1	Oral Testosterone Preparations	439
21.2.2	Buccal Administration	441
21.2.3	Intramuscular Testosterone Preparations	442
21.2.4	Transdermal Testosterone Preparations ..	444
21.2.5	Testosterone Implants	445
21.3	Monitoring Testosterone Therapy in Hypogonadism	446
21.3.1	Psyche and Sexuality	446
21.3.2	Somatic Parameters.....	447
21.3.3	Laboratory Parameters.....	447
21.3.4	Prostate and Seminal Vesicles.....	449
21.3.5	Bone Mass and Muscles	450
21.4	Evaluation of Testosterone Substitution Therapy	451
21.5	Excessive Height	451
21.6	Misuse and Abuse of Anabolic Steroids	452
	References	453

21.1 Indications and Preparations: An Overview

All forms of hypogonadism described in the previous chapters associated with Leydig cell insufficiency require testosterone therapy. In secondary hypogonadism long-term testosterone therapy is also indicated. This is only to be interrupted for GnRH or gonadotropin therapy when offspring are desired.

Male hypogonadism is the main indication for testosterone. [Table 21.1](#) provides an overview of **other possible applications**. Some of these applications are dealt with in other chapters of this volume, for example in constitutionally delayed puberty (Chap. 12), in late-onset hypogonadism (LOH) (Chap. 14), in male hormonal contraception (Chap. 29) and in idiopathic male infertility (Chap. 22). In addition, this chapter deals with its use in excessively tall stature ([Sect. 21.5](#)) and with its abuse in doping and body building ([Sect. 21.6](#)). Because of its erythropoietic effect testosterone is also licensed for the treatment of aplastic and renal anemia, but lost ground to erythropoetin after the

Table 21.1 Use of testosterone in men

Clinical applications	Hypogonadism Primary hypogonadism Secondary hypogonadism LOH Delayed puberty Aplastic and renal anemia
Off-label use	Excessive growth
Application under discussion	Aging male
Experimental use	Male contraception
Obsolete application	Idiopathic infertility
Abuse	High-performance athletics and bodybuilding

E. Nieschlag (✉)
Centre of Reproductive Medicine and Andrology
of the University, Domagkstr. 11, D-48149 Münster/Germany
e-mail: Eberhard.Nieschlag@ukmuenster.de

latter was introduced. For treatment of this condition, the reader is referred to textbooks of internal medicine.

Testosterone therapy is indicated when, in cases with androgen deficiency, serum testosterone concentrations drop below a certain level (see Chap. 5).

In Germany 12 nmol/L is considered the lower level of normal. Surprisingly this level is lower in other countries, e.g., Spain (9.0), Great Britain (7.5–8.0) and France (7.5 nmol/L) (Nieschlag et al. 2004; Gooren et al. 2007). A study designed to verify these differences in aging hypogonadal patients concluded that not one *single* threshold level coincided with the occurrence of symptoms of hypogonadism, but that there are symptom-specific threshold levels ranging between 15 and 8 nmol/L. Loss of vigor and libido are observed even below 15 nmol/L, while erectile dysfunction caused by lack of testosterone occurs only below 8 nmol/L. The other symptoms occur between these two levels (Fig. 21.1) (Zitzmann et al. 2006). A study in younger hypogonadal men came to similar conclusions (Kelleher et al. 2004).

The question at which testosterone levels substitution is initiated has been more determined by the physicians' perception of hypogonadism than by the patients' complaints. The fact that physicians, when questioned, mentioned the loss of libido as the most frequent symptom of testosterone deficiency shows how little importance physicians have attached to the



Fig. 21.1 Threshold levels of serum testosterone for various symptoms of late onset hypogonadism (LOH) in 434 patients (Zitzmann et al. 2006)

sexuality of their patients to date (Gooren et al. 2007). The International Recommendations for LOH also establish 8 nmol/L as the absolute lower threshold for testosterone substitution and the range between 8 and 12 nmol/L as relative indications (Nieschlag et al. 2006; Behre et al. 2004; Wang et al. 2008). In unclear cases calculated free testosterone below 225 pmol/L can be considered as an indication for testosterone substitution. Additionally the pharmacogenetics of testosterone increasingly play a role and must be taken into consideration together with symptom-specific threshold levels when substituting hypogonadal patients (Zitzmann and Nieschlag 2007).

Thus testosterone substitution must become more oriented towards patients' complaints than at present and consider carefully symptom-specific threshold serum levels. 12 nmol/L total serum testosterone continues to be a good indication for low normal levels. The effectiveness of substitution can be measured directly by testosterone concentrations in serum.

Since we are dealing with hormone replacement therapy, its effectiveness can be measured directly by checking serum testosterone concentrations.

According to international consensus which remains valid, the major goal of testosterone therapy is to replace testosterone levels at as close to physiological concentrations as is possible (Nieschlag et al. 1992). Furthermore, the **naturally occurring testosterone molecule** should be used for substitution in order to guarantee the broad spectrum of testosterone effects. Available testosterone preparations should be judged according to these criteria.

Certain target organs are able to use testosterone directly, while for others it must first be converted to 5 α -DHT or estradiol in order for them to become effective (Chap. 2). To achieve a physiological balance between testosterone and its active metabolites, natural testosterone should be used and not synthetic androgens which are metabolized into other forms (e.g., 19-nortestosterone) or are direct derivatives of the metabolites (e.g., mesterolone). In the same vein there is little purpose in applying estrogens either directly or exclusively to the hypogonadal male. Nor has any rational basis for the

use of testosterone precursors such as DHEA or androstenedione been established to date. The use of natural testosterone allows all androgen-dependent functions to be induced or maintained in the safest way possible and side effects to be avoided.

Testosterone was first synthesized in 1935 (Butenandt and Hanisch 1935; Ruzicka and Wettstein 1935) and used clinically shortly thereafter; thus it is one of the oldest hormones in clinical use. First testosterone implants were used, and since the 1950s testosterone enanthate or cypionate were applied as i.m. injections. In the 1970s orally effective testosterone undecanoate followed, and in the 1990s the first transdermal testosterone substitution appeared in the form of a testosterone film applied to the scrotum. Further transdermal applications were membranes for non-scrotal skin and finally testosterone gels were introduced. Injectable testosterone undecanoate represents a real depot preparation. A mucoadhesive buccal testosterone tablet completes the spectrum of currently available preparations (Nieschlag 2006).

The experienced physician must select the form most suitable for the patient, considering both his symptoms and phase of life. Often several preparations will have to be tried before finding an optimal choice for the individual patient.

21.2 Pharmacology of Testosterone Preparations

In chemical terms, testosterone is derived from the basic structure of all androgens, i.e., from androstane. It owes its specific biological activity to the keto-group in position 3, the double-bond in position 4 and the hydroxy-group in position 17 of the basic androstane structure (Fig. 21.2 and Chap. 2).

Principally, three approaches enable testosterone to be used in therapy:

1. Chemical modification of the molecule
2. Esterification in position 17 and
3. Various forms of application

As routes of application are particularly important for clinical purposes, testosterone preparations will be discussed here in these terms. In addition to the modalities

described below, nasal, conjunctival or rectal routes of application can be chosen; however, at present these forms play no role in clinical use.

This chapter deals with aspects relevant to androgen therapy. For further reading reference is made to current monographs (Nieschlag and Behre 2004). Table 21.1 and Fig. 21.3 provide an overview of available preparations and dosages.

21.2.1 Oral Testosterone Preparations

It would seem obvious to use natural testosterone in the form it is secreted by the testes for substitution therapy. In fact, orally applied free testosterone is well absorbed from the intestine, but is completely metabolized by the liver in the first pass effect, so that it does not reach target organs. About 400–600 mg testosterone would have to be given orally, i.e., about 100-fold of the amount normally secreted by the testis daily, in order to exceed the testosterone-metabolizing capacity of the liver and to achieve normal peripheral serum levels. As administering such great amounts of testosterone seems uneconomical and as possible long-term side effects are difficult to evaluate, this form of application never went beyond the experimental stage (Nieschlag and Behre 2004).

21.2.1.1 Testosterone Undecanoate

In order to avoid the first pass effect in the liver after oral application, testosterone was esterified with undecanoic acid in position 17 β . This long aliphatic side chain allows resorption of the molecule into the lymph so that testosterone can enter the circulation through the thoracic ducts and via the subclavian vein, thus reaching target organs prior to hepatic metabolism. Resorption is improved if oral testosterone is taken with a meal containing fats.

Testosterone undecanoate is available in 40 mg capsule form with the testosterone being dissolved in oil (Andriol[®]; Testocaps[®]). As testosterone represents 63% of the molecular weight, one capsule contains about 25 mg testosterone. For good absorption, ingestion with a meal is required (Bagchus et al. 2003). Maximum serum peaks are attained about 2–6 h after ingestion (Schürmeyer et al. 1983; Behre and Nieschlag 1998b).

Fig. 21.2 Molecular structures of testosterone and various testosterone preparations

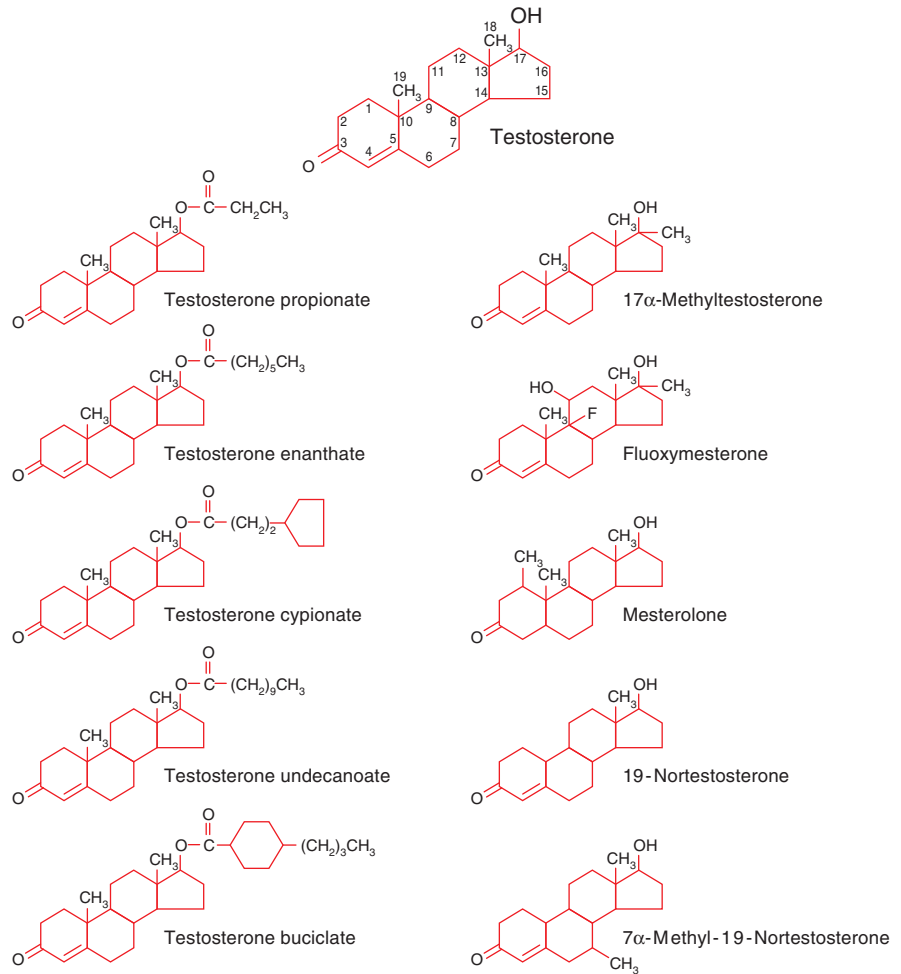

Fig. 21.3 Historical development of testosterone preparations for clinical use

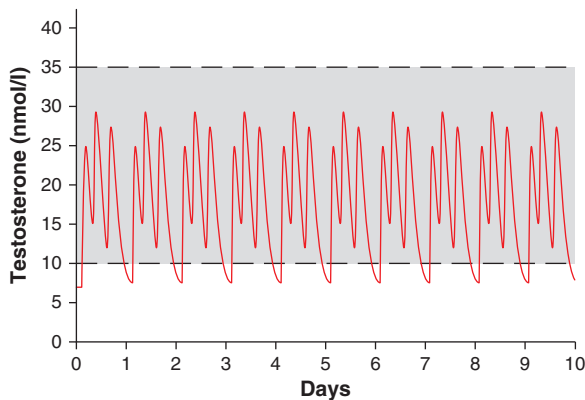

Fig. 21.4 Serum testosterone concentrations following oral application of $3 \times 40\text{mg}$ testosterone undecanoate to hypogonadal men (pharmacokinetic computer simulation assuming basal testosterone levels of 7 nmol/l). The gray area indicates the range of testosterone in normal men

This means that **two to four capsules** spread over the course of a day are required for substitution. Although relatively high testosterone concentrations are given, no long-term side effects or toxic effects have been observed (Gooren 1998).

Testosterone undecanoate is best suited for substitution therapy when the patient has a residual capacity to secrete testosterone (e.g., Klinefelter patients in the early phase of substitution). Another domain of testosterone undecanoate medication are situations when intramuscular injections cannot be given because of clotting disturbances (e.g., patients on marcumar medication) or the patient cannot attend a physician for the injections (e.g., on holidays). The disadvantage of this therapy lies primarily in the short-lived peaks and troughs in serum testosterone which do not mimic physiological conditions and in the poor predictability of individual resorption patterns (Fig. 21.4).

21.2.1.2 Methyl Testosterone and Fluoxymesterone

17α -Methyl testosterone resulted from attempts started shortly after testosterone synthesis in 1935 to modify the molecule chemically. The methyl group in position 17α protects the testosterone molecule from being metabolized in the liver so that it can reach target organs after oral administration. Long-term use,

however, can lead to elevated liver enzymes, as well as to cholestasis and peliosis (for review see Nieschlag 1981).

Fluoxymesterone also contains a methyl group in position 17α in addition to a fluoride atom and hydroxy group. Although this modification makes fluoxymesterone a highly effective oral testosterone preparation, the 17α methyl group makes it liver-toxic as well. For this reason these substances were taken off the market in Germany, first as monosubstances and subsequently their use in combined preparations was prohibited. As they are still available in other countries, it is necessary to warn against their toxic side effects.

In general, 17α -methylation of all androgens (also of anabolic steroids) may cause liver toxicity and therefore these preparations should be generally considered **obsolete**.

21.1.2.3 Mesterolone

Mesterolone (Proviron[®], Vistimon[®]) is derived from the 5α -reduced testosterone metabolite 5α -dihydrotestosterone (DHT) and is likewise not subject to hepatic metabolism following oral administration. As a DHT derivative, however, it can only compensate for DHT-dependent functions and not for the immediate effects of testosterone and those following aromatization to estrogens. Thus, it does not develop the full spectrum of testosterone effects which are necessary for hormone replacement therapy and it is therefore **not suitable for substitution in hypogonadism**.

21.2.2 Buccal Administration

Incorporating testosterone into polyethylene matrices with limited water-solubility represents a new attempt to develop forms for buccal application: Striant[®]. The mucoadhesive tablets adhere to the gingiva above the incisors for many hours and slowly release testosterone into the circulation. Twice daily application results in even serum levels (Fig. 21.5) (Korbonits et al 2004; Nieschlag et al 2004; Wang et al 2004).

21.2.3 Intramuscular Testosterone Preparations

21.2.3.1 Testosterone Enanthate

When natural testosterone is injected intramuscularly, its half-life is very short. In order to prolong its effectiveness, testosterone was esterified in position 17 with aliphatic side chains. The duration of half-life depends upon the length and structure of the side chain.

Intramuscular administration of **testosterone enanthate** is the form most widely used in hormone replacement therapy and was introduced in 1952. Its terminal half-life is 4.5 days (Table 21.2). The standard dose is 200–250 mg testosterone enanthate (e.g., Testoviron® Depot 250 mg, Testosterone Depot). As the pharmacokinetics show, supraphysiological serum testosterone concentrations are rapidly achieved and are maintained for several days (Fig. 21.5) (Behre et al. 2004). Subsequently serum levels gradually decline, passing the lower level of normal on about day 12. Repeated injections, such as are necessary for substitution therapy, produce a “saw-tooth profile” with supraphysiological, physiological and infraphysiological levels following one another depending on the injection interval (Fig. 21.6). While this substitution regimen is adequate to maintain the biological effects of testosterone, the patient finds these extremes disturbing, as general well-being, moods, and sexual activity reflect these patterns. Nonetheless, testosterone

Table 21.2 Pharmacokinetic data of various testosterone preparations

Preparation	Application	Mean residence time (MRT)	Terminal mean time ($t_{1/2}$)
Testosterone undecanoate	p.o.	3.7 h	1.6 h
Testosterone propionate	i.m.	1.5 days	0.8 days
Testosterone enanthate	i.m.	8.5 days	4.5 days
Testosterone undecanoate			
In tea seed oil	i.m.	34.9 days	20.9 days
In castor oil	i.m.	36.0 days	33.9 days
Testosterone buciclate	i.m.	60.0 days	29.5 days

enanthate was the most widely used therapy for many years, as there were no suitable alternatives.

Testosterone cypionate and **testosterone cyclohexanecarboxylate**, available in some countries, have the same pharmacokinetics as testosterone enanthate and, consequently, similar advantages and disadvantages as testosterone enanthate.

21.2.3.2 Testosterone Propionate

Testosterone propionate (Testoviron®) has a short half-life as a consequence of its short side chain (Table 21.2). Initial serum concentrations following i.m. injection

Fig. 21.5 Serum testosterone concentration (mean \pm SD) following 7–8 days therapy with Striant®, one tablet every 12 h; times of application marked by thin arrows compared to transdermal therapeutic systems (Androderm® or Andropatch®) 5 mg/day, time of application marked by large arrows. Serum levels over 24 h are shown (0 = 8 o'clock for buccal testosterone, 22 h for transdermal testosterone). Dotted line indicates normal range (Modified from Korbonits et al. 2004. With permission of the Endocrine Society, USA)

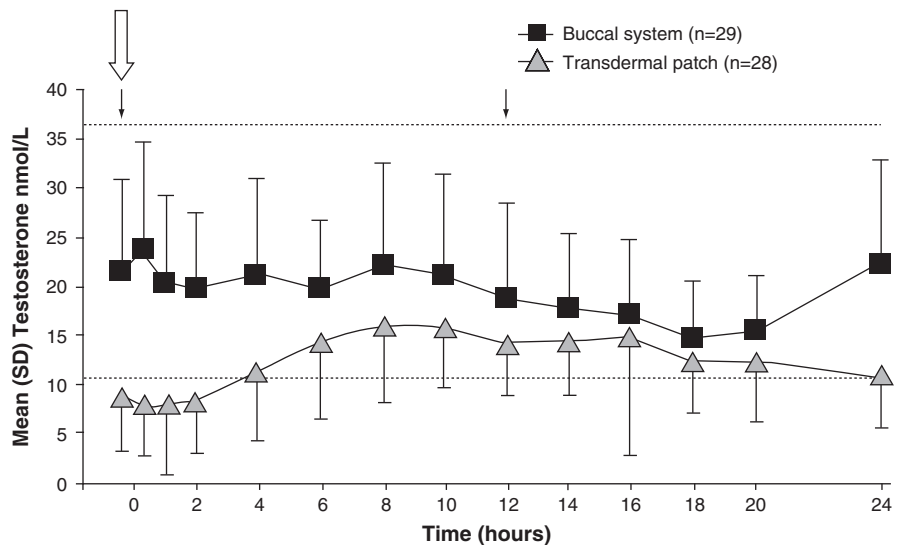

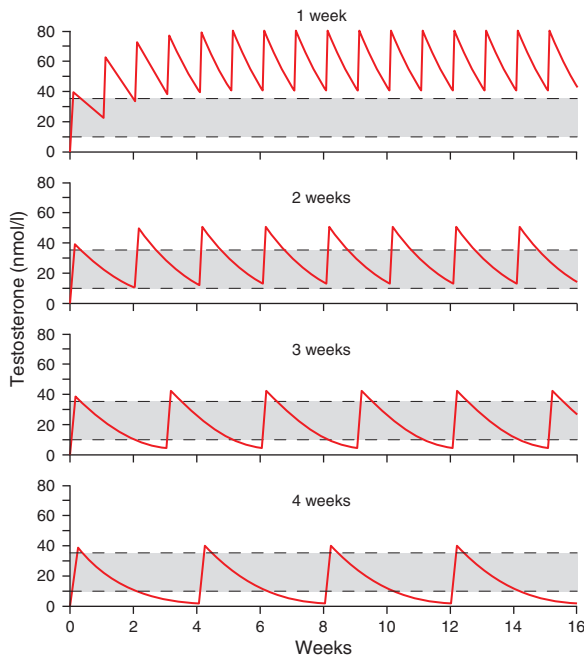

Fig. 21.6 Testosterone serum levels in hypogonadal men following intramuscular injection of 250 mg testosterone enanthate given at intervals of 1, 2, 3, or 4 weeks. The gray area indicates the normal range of testosterone

may be as high as with testosterone enanthate, but the injections must be repeated every 2–3 days because of its short half-life to achieve full substitution. Because of the necessity for frequent injections testosterone propionate is not suitable for chronic therapy, nor does

a combination of testosterone propionate and testosterone enanthate offer any advantage (Behre et al. 2004).

21.2.3.3 Testosterone Undecanoate

Testosterone undecanoate, introduced to Europe in the 1970s as an oral preparation (see Sect. 21.2.1.1), was first developed in China as an injectable form (Wang et al. 1991). Testosterone undecanoate was dissolved in tea seed oil. When castor oil was used as vehicle, the half life could be extended even further (Behre et al. 1999a, Table 21.3). Along with the longer effectiveness, the absence of initial supraphysiological peaks made it superior to testosterone enanthate (Fig. 21.7).

For substitution 1,000 mg testosterone undecanoate (Nebido®) are injected about four times per year. In order to achieve a steady state at the beginning of substitution the second injection is given 6 weeks after the first, further injections follow 10–14 weeks later (Fig. 21.8). Individual intervals are determined according to serum testosterone levels which are measured immediately before the next injection. These determinations are then repeated at yearly intervals. Values that are too high lead to extension of injection intervals, those that are too low to a shortening of injection intervals. Slow intergluteal injections are recommended. No adverse side effects have been observed, even after many years of use (Nieschlag et al 1999; von Eckardstein et al 2002; Schubert et al 2004; Zitzmann and Nieschlag 2007).

Table 21.3 Testosterone preparations used in Germany for substitution of hypogonadism

Application	Preparation	Recommended doses for chronic treatment	Annual consumption (in units)	Single unit cost (€) ^a	Annual cost (€) ^a
Oral	Andriol® Testocaps	1–3 Capsules daily	365–1095	0,85	312–935
Buccal	Striant™	2 Tablets/day	730	1,03	749
Intramuscular	Nebido®	Every 10–14 weeks	4–5	139,56	558–698
	Testoviron®-Depot-250	Every 2–3 weeks	17–26	23,98	408–623
	Testosteron-Depot Jenapharm®	Every 2–3 weeks	17–26	19,54	332–508
Transdermal	Androtop® Gel 50 mg	1 Satchel/day	365	2,07	754
	Testim® Gel	1 Tube/day	365	2,24	817
	Testocur® Gel 2,5 or 5 g	1 Satchel/day	365	2,07	754
	Testogel® 50 mg	1 Satchel/day	365	2,07	754
	Tostran® Gel	2–4 g/day	730–1460	0,99	726–1451
	Testopatch® 2,4 mg/d	2 Patches every 2 days	365	2,06	753

^aCosts calculated according to doses recommended by the manufacturers and prices from the “Rote Liste 2008” (list of all medications on the market in Germany)

Fig. 21.7 Comparative pharmacokinetics following single intramuscular injections of 250mg testosterone enanthate, 1,000mg testosterone undecanoate, and 600mg testosterone buciclate in hypogonadal men. The dotted lines represent the normal range of testosterone

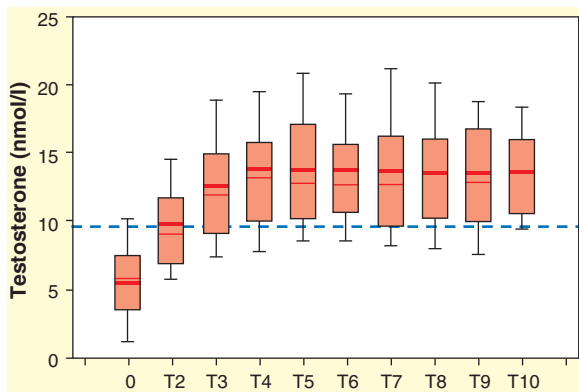
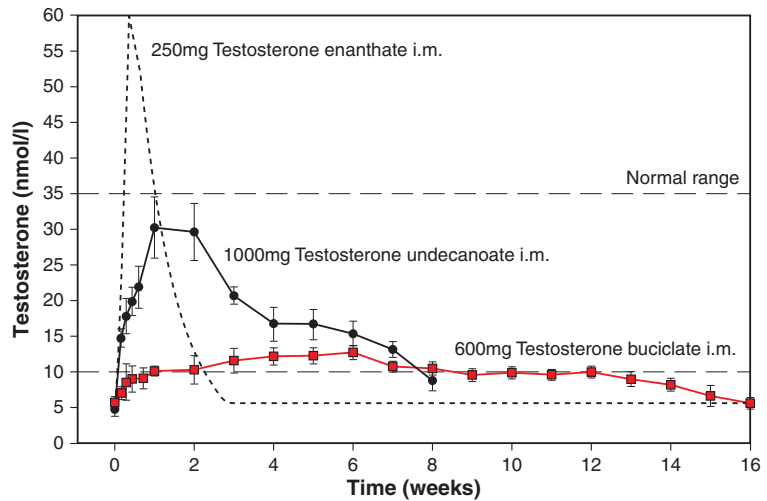

Fig. 21.8 Serum testosterone concentrations before and during long-term therapy with intramuscular testosterone 1,000mg (Nebido®, injection interval between injections 1 and 2, 6–10 weeks, thereafter every 10–14 weeks). Serum levels are shown as box and whiskers plots (red line in box: mean value; black line in box: medium value; 15% of single determinations within box; 10th and 19th percentile shown by whiskers). 0 = basal testosterone concentrations before therapy; T2 = testosterone concentration immediately before 2nd Nebido® injection etc. Dotted line indicates lower level of normal

21.2.4 Transdermal Testosterone Preparations

21.2.4.1 Testosterone Patches

Transdermal application of medication has gained in popularity in recent years because of the many advantages it has over conventional forms. In the endocrinological field the transdermal form has become widely used for treating menopausal deficiency symptoms with estrogens. Development of a transdermal

system for replacement therapy of hypogonadal men met with difficulties as in hypogonadism testosterone doses in the range of normal production i.e., about 6 mg per day are required to be transported through the skin, whereas the corresponding dose of estradiol for women lies in the μg -range. Different skin types have differing resorption capacities. Since scrotal skin has high blood circulation extending into the uppermost layers of the epithelial layers (because of its role in physiological temperature regulation), this skin type has especially high resorption capacity (about 40 times higher than the skin of the lower arm). This particularity was used to advantage in developing a trans-scrotal application system. Although currently no longer used, it deserves mention as the first transdermal preparation.

The **trans-scrotal therapeutic system** (Testoderm®) consists of a 40 or 60cm² polymere membrane loaded with 10 or 15mg pure natural testosterone. When these membranes are applied to the scrotum they release enough testosterone into the system to guarantee physiological serum testosterone levels for one day. When the membrane is applied in the morning, physiological daily rhythms of testosterone can be mimicked (Bals-Pratsch 1986). Daily renewal provides constant serum testosterone levels in the normal range. Patients treated with this form of substitution therapy (for up to 10 years) show very good results (Behre et al. 1999b). Since an “enhancer” need not be used, skin irritations rarely occur. In order to guarantee good skin contact, the scrotum must be freed of hair from time to time (scissors or razor).

Following transscrotal forms, **transdermal testosterone patches** were developed which can be applied to non-scrotal skin (e.g., abdominal or upper arm skin)

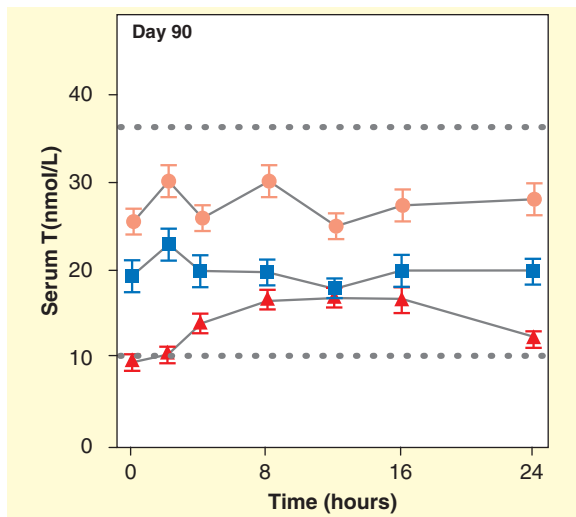

Fig. 21.9 Serum testosterone concentrations (mean \pm SEM) after 90 day therapy with transdermal testosterone gel (Testogel[®] or Androtop[®] Gel) at a dose of 50 mg/d (squares, one package/d) oder 100 mg/d (circles, 2 packages/d) compared to transdermal therapeutic system (Androderm[®], triangle, 5 mg/d). Serum levels are shown over 24 h (0 = 8 a.m.). Dotted line represents the normal range (Modified from Swerdloff et al. 2000. With permission from the Endocrine Society, USA)

(e.g., Androderm[®]). In order to transport the required amount of testosterone through the skin, these systems are equipped with an “enhancer” which may lead to skin irritation. Two systems must be applied in the evening and worn for 24h for hormone replacement therapy. Daily renewal is necessary for chronic substitution (Fig. 21.5 and 21.9) (Meikle 1998). As in the transscrotal systems, testosterone values in the normal range and with a physiological circadian profile can be achieved, with DHT and estradiol remaining in the normal range.

Although the patches mentioned above are hardly used today recently a new testosterone patch was developed causing little skin irritation and which must be changed only every other day; however, two systems with either 1.8 or 2.4 mg resorbed per day must be used (Testopatch[®]).

21.2.4.2 Testosterone Gels

A further application in transdermal form is the use of testosterone gels, which are applied to large skin areas in order to allow sufficient amounts of the hormone to be resorbed (Androtop[®]Gel, Testim[®], Testogel[®]). These gels are applied in the morning to the upper arm, shoulders and abdomen and are left to dry for

five minutes. During this time contact with women or children must be avoided, because of the danger of contamination. Thereafter the danger is negligible, especially if the skin is washed after evaporation of the alcohol (Rolf et al. 2002). Physiological levels result when the gel is applied in the morning (Fig. 21.9). Long-term use over several years showed good results (MacNicholas and Ong 2006; Wang et al 2004).

The latest development are gels with high concentrations of testosterone (Tostran[®] 2% and Testocur[®] 2.5%) and no risk of skin irritation (McGriff-Lee 2002; Kühnert et al. 2005; Behre et al. 2004). As only small areas of skin are required for resorption, scrotal application is in clinical testing which would require less gel as scrotal skin has a much higher resorption capacity than the general skin (Kühnert et al. 2005). This would make the substitution with testosterone gels more economical and ecologically advantageous.

21.2.4.3 Transdermal Dihydrotestosterone

In France a further **transdermal preparation** is on the market containing **5 α -dihydrotestosterone** (Andractim[®]). At a concentration of 2.5% the DHT is incorporated into a hydroalcoholic gel from which the DHT penetrates the skin if it is applied to sufficiently large surfaces, e.g., the chest and abdomen. Supraphysiological DHT values are measured in serum. Hypogonadal patients treated in this matter are rapidly adequately substituted (Schaison and Couzinet 1998). However, the criticism that is applicable to mesterolone is also valid here, namely that the full spectrum of direct testosterone effects and those mediated by estradiol are not able to be exerted. Moreover, applying a gel over such a large skin surface seems impractical; contact with skin and underwear may cause testosterone uptake and virilization in the female partner (Delanoe et al. 1984).

21.2.5 Testosterone Implants

Testosterone implants are among the oldest testosterone preparations. They consist of pure testosterone molded under heat into cylindrical forms of 12 mm length and 4.5 mm diameter. An implant contains 200 mg. They are implanted through a 0.5–1 cm incision under the abdominal skin under sterile conditions using a trocar. The wound is closed with a bandage or stitches. Patients

with a tendency towards infection are given an antibiotic prophylactically. If three to six implants are inserted, slowly declining serum testosterone levels in the normal range are achieved for 4–6 months (Behre et al. 2004). Despite the long-lasting depot effect and the positive serum testosterone levels these products are only available in the UK, in Australia and South Africa. The minor surgery necessary for implantation, an 8.5% extrusion rate ($n = 97.3$ in 221 patients over a period of 13 years) and bleeding (2.3%) and occasionally infection (0.6%) are limiting factors (Kelleher et al. 1999).

21.3 Monitoring Testosterone Therapy in Hypogonadism

All forms of testosterone therapy listed above pursue the same goal, namely to provide optimal substitution with testosterone. From its physiological effects and from those resulting from pharmacokinetics and pharmacodynamics various parameters can be measured to determine the effectiveness of testosterone therapy; these will be discussed in the following sections (overview in Table 21.4).

21.3.1 Psyche and Sexuality

A patient's **general well-being and activity** are good parameters to check the effectiveness of replacement therapy. When testosterone levels are adequate, the patient feels active in body and mind, alert and in good spirits, whereas inadequate testosterone levels are accompanied by inactivity, lethargy and depressive moods which improve with testosterone substitution (Barratt-Connor et al. 1999; Christiansen 2004; Wang et al. 2004).

Elements such as aggressiveness, tension, irritability and anger are also positively influenced by testosterone substitution (O'Connor et al. 2002). This improvement in aggressiveness among hypogonadal men brought about by testosterone substitution must be differentiated from the unresolved question whether supraphysiological testosterone administration to normal men increases aggressivity (Christiansen 2004). Moreover, in hypogonadal men testosterone improves sociability and adjustment. Finally, testosterone supports brain functions such as spatial cognition by activating the relevant brain areas (Cherrier et al. 2001; Zitzmann et al. 2001).

Table 21.4 Criteria for monitoring testosterone substitution

Psychic and sexual parameters	General well-being
	Intellectual and physical activity Mood Libido Erections Sexual activity
Somatic parameters	Body proportions Body weight Muscle mass and strength Fat mass and distribution Hair pattern (beard, pubes, frontal hair line) Sebum production Voice mutation Local side effects at application site
Laboratory parameters	Serum testosterone (SHBG, free testosterone, salivary testosterone) Gonadotropins (LH, FSH) DHT, Estradiol Erythropoiesis (hematocrit, erythrocyte count, hemoglobin) Possibly liver enzymes, lipid levels, HbA1c
Prostate/seminal vesicles	Ejaculate volume Prostate size/ultrasound results (Palpation and TRUS) PSA in serum Uroflow
Bones	Bone density

While loss of **libido and sexual appetite** are signs of reduced testosterone levels, adequate substitution is accompanied by **sexual thoughts and phantasies**. Their frequency correlates with testosterone values. Spontaneous **nightly or morning erections** are signs of good substitution, but even when testosterone values are deficient, erections can still be provoked by visual stimulation. In the normal to slightly subnormal range serum testosterone correlates with the **frequency of ejaculations and sexual intercourse**; however, above the lower limit of normal such a correlation no longer exists so that further increase of testosterone will not lead to a further increase in sexual activity. This indicates that in-depth conversation and a sexual diary – at least from time to time – give useful hints for evaluating testosterone therapy. Sexual questionnaires providing information about sexual thoughts and phantasies, appetite, satisfaction with sexuality, frequency of erections and ejaculations can make results of therapy objective (Beutel et al. 2005; Morales et al. 2007).

When testosterone values were decreased pharmacologically by GnRH antagonists, it appeared that adequate sexual function was still found in the presence of relatively low and slightly subnormal testosterone values (Behre et al. 1994a), whereas other functions required higher testosterone values. Thus, while the patient's sexuality provides an important parameter for monitoring therapy, it cannot be considered the only one.

21.3.2 Somatic Parameters

Muscle mass and strength increase in hypogonadal patients treated with testosterone and they develop a more virile phenotype (Bhasin et al. 2004). The anabolic effect of testosterone causes **body weight** to increase by about 5%. Thus, body weight, easily monitored, is one of the parameters to be checked routinely. The relative increase of muscle mass concomitant with the loss of fat can be measured, but does not yet belong to standard monitoring of testosterone therapy. Similarly, the distribution of fat over lower abdomen, hips and buttocks, characterized by a feminine pattern in the hypogonadal patient, assumes a masculine type under testosterone treatment (Allan et al. 2008; Isidori et al. 2005).

The development and maintenance of a male **hair pattern** is a good parameter for monitoring testosterone therapy (Randall 2004). **Beard growth** and the frequency of shaving are easily checked. Hair growth in the **upper pubic triangle** especially is an important indicator for adequate testosterone replacement. Whereas women, prepubertal boys and untreated hypogonadal patients have a straight hairline, androgenization is accompanied by the formation of **temporal recession** and, depending on genetic disposition, by **balding**. Some patients consider this a negative effect about which they should be informed prior to therapy. The male hair pattern is of greater diagnostic importance than its intensity. A higher testosterone dose may be necessary for patients with long CAG repeats to achieve satisfactory beard growth.

A well-substituted patient will comment on the need for shaving daily or may develop a full beard. Some predisposed patients may not, however, develop beard growth. In these cases the androgen receptor polymorphism may be of importance.

Hypogonadal patients have prepubertal dry **skin**. Testosterone substitution induces **sebum production** and during the early phases some patients complain

about increasing greasiness of skin, especially on the head which makes frequent shampooing necessary. Patients should be informed about these normal symptoms of masculinity. **Acne** may occur with the onset of testosterone substitution in young patients as a sign of triggered puberty, but is also occasionally observed in substituted adults. This applies especially when preparations such as testosterone enanthate are used which could cause supraphysiological serum testosterone levels, but is rarely seen with testosterone undecanoate i.m. or gels. Switching products and/or dose reduction may be necessary to improve acne.

Gynecomastia may occur when doses of testosterone enanthate are too high. This makes dose reduction necessary. Pre-existing gynecomastia in Klinefelter patients will hardly be influenced by testosterone substitution.

Shortly after initiation of testosterone substitution, patients who have not gone through puberty will experience **mutation of the voice** (Akcem et al. 2004). This phenomenon reinforces the patient's self-confidence and social adjustment as the gap between chronological and biological age is closed. Being recognized as a man on the basis of the voice is of enormous importance for the patient's self-confidence; this becomes especially obvious from telephone conversations. Once mutation has taken place, the voice provides no further index of testosterone therapy, as larynx size, vocal cord length and thus vocal register are maintained even without further testosterone substitution.

In the course of time patients with prepubertal hypogonadism develop eunuchoid bodily proportions, as the epiphyseal fissures close more slowly than in normal growth. Testosterone substitution initiates a brief growth spurt prior to rapid closure of the fissures and cessation of growth. In these patients bone age of the left hand must be determined before the onset of puberty and periodic determinations of bone age will show when bone maturity is reached. The ratio of arm-span to height and trunk height to leg length should be followed until definite bodily proportions are established. Further increase of arm span indicates insufficient testosterone therapy.

21.3.3 Laboratory Parameters

When **serum testosterone concentrations** are used to evaluate testosterone substitution therapy, the pharmacokinetic profile of the various preparations must be

considered. Furthermore, for long-term evaluation of testosterone therapy, methods of determining testosterone serum concentrations must be subjected to strict quality control so that reliable values will be available over long periods (see too Chap. 7).

Since for routine evaluation the duration of action of a given preparation is of prime importance, serum testosterone values should be measured immediately before the next application of a testosterone preparation. Especially for oral or transdermal preparations, the exact timepoint of the last application must be noted in order to interpret the results properly.

- For practical purposes, substitution therapy with **testosterone enanthate** should start with 3-week intervals between injections of 250 mg. If values are below normal 3 weeks after injection of testosterone enanthate the injection interval should be reduced. If, however, the values are still in the upper range, the interval may be increased.
- Six weeks after the first i.m. injection of testosterone undecanoate (Nebido®) the second follows and a third follows 12 weeks after the second. After a further 12 weeks and immediately before the 4th injection serum testosterone is determined. If the value is too high the injection interval should be extended to more than 12 weeks, if too low, the interval is shortened to 10 weeks. These determinations and possible adjustments should be made annually thereafter.
- Low serum testosterone measured 2–4 h after ingestion of oral testosterone undecanoate (Andriol®) should first serve as a reminder to the patient that the capsules should be taken with a meal to insure better resorption. Because of the marked intra- and interindividual varying resorption patterns, however, it is difficult to monitor testosterone undecanoate therapy by serum testosterone levels and other parameters must be considered additionally.
- When transdermal testosterone application by patches (Testopatch®) produces unsatisfactory serum values, sufficient contact between patch and skin should be checked (hair growth interfering with the contact between patch and skin?). As these patches are supplied in two sizes (1.8 and 2.4 mg/24 h) dose adjustment is possible by choosing either a larger or smaller patch.

Testosterone may have to be determined repeatedly until the correct form of substitution is found. Once

good substitution is established, the patient should be checked at 6–12-month intervals with blood samples being taken at the end of a therapy interval.

Basically, the determination of **total testosterone** in **serum** suffices and measuring **free testosterone** i.e., that fraction not bound to sex hormone binding globulin (SHBG) is unnecessary, as free and bound testosterone are well correlated in most instances. **Hyperthyroidism** and medication for **epilepsy** may, however, cause SHBG to increase so that total testosterone also rises. Conversely, extreme **adipositas** leads to a drop in total testosterone (see Chap. 7).

In patients developing therapy-induced gynecomastia simultaneous determination of **estradiol** and testosterone is indicated in order to check for increased conversion to estradiol. In this event, the dose should be reduced or medication should be switched to one producing physiological serum values.

Whereas **gonadotropins** are of decisive importance to differentiate between primary and secondary hypogonadism, their role in monitoring testosterone therapy for (primary) hypogonadism is less significant. In some forms of primary hypogonadism e.g., anorchia, serum testosterone concentrations and LH but also FSH are correlated relatively well. In these cases, normalization of gonadotropins may occur. In the most frequent form of hypogonadism, the Klinefelter syndrome, however, under testosterone therapy LH and FSH values do not always correlate with serum testosterone values although all other parameters indicate adequate testosterone substitution. Likewise, oral and transdermal testosterone therapy have little influence on gonadotropins. For these reasons, gonadotropins are not very useful for monitoring testosterone therapy and then only in primary hypogonadism.

The slight anemia characteristic of hypogonadal patients disappears under testosterone therapy. Thus, **hemoglobin, erythrocyte count** and **hematocrit** are good parameters for monitoring therapy (Jockenhövel et al. 1997). If testosterone doses are too high, hemoglobin, erythrocytes and hematocrit may move into the supraphysiological range and polycythemia may develop. This is particularly true for testosterone enanthate (Calof et al. 2005). In this case, the testosterone must be reduced. If hematocrit exceeds 55% bloodletting may be indicated. Especially older and adipose patients and those with short CAG repeats of the androgen receptor tend to develop polycythemia (Hajjar et al. 1997; Zitzmann and Nieschlag 2007) (Fig. 21.10).

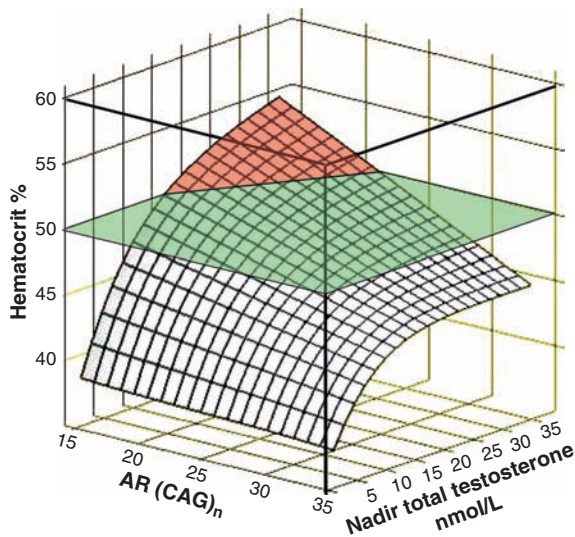

Fig. 21.10 Hematocrit in 66 hypogonadal men in relation to serum testosterone nadir values and androgen receptor CAG repeats. In total, 515 intramuscular injections of testosterone undecanoate (1,000 mg Nebido®) were administered in 10–14 week intervals over several years. The green area signifies the upper limit of normal, the red area the pathologically elevated hematocrit (Zitzmann and Nieschlag 2007).

If despite adequate substitution anemia persists, other reasons, e.g., iron deficiency must be considered and must then be treated accordingly. At the beginning of testosterone therapy, red blood counts should be performed every 3 months, later at yearly intervals.

The testosterone preparations recommended here have no negative influence on **liver function** even when used chronically (Gooren 1998; Hajjar et al. 1997; Meikle 1998; Behre et al. 1999b; Zitzmann and Nieschlag 2007) even though some physicians continue to believe so (e.g., Gooren et al. 2007). This idea developed from the obsolete administration of 17α -alkylated anabolic steroids which are indeed liver toxic. This does not apply to natural testosterone. However, monitoring liver function is particularly important in patients with hepatic disease or with hypogonadism caused by general disease (see Chap. 18). In these cases, additional medication may influence liver function and thus also testosterone metabolism e.g., by increasing SHBG concentrations. This must be considered when evaluating testosterone values. Liver values should be checked at yearly follow-up.

Testosterone influences **lipid metabolism** and the **clotting system**. Although it is difficult to find bioequivalent doses, the effects vary when comparing different

preparations (Jockenhövel et al. 1999). Testosterone therapy of hypogonadal patients should cause these parameters to move into the normal range for males and it remains unclear whether an increase in LDL and a decrease of HDL within the limits of normal has any biological significance for the cardiovascular system. Taken together, the pro- and anti-atherogenic effects of testosterone appear to be balanced (von Eckardstein and Wu 2004). Patients at risk should be given the preparation least likely to cause pathological alterations of these parameters.

21.3.4 Prostate and Seminal Vesicles

Under the influence of testosterone therapy, prostate and seminal vesicles of the hypogonadal patient enlarge and assume normal functions. This can best be documented by the increase of **ejaculate volume** into the normal range. Normal ejaculate volume (>2 ml) is a good parameter for measuring the efficacy of testosterone therapy.

Testosterone treatment does not enlarge **prostate volume** over the normal range. This is also true of testosterone enanthate therapy which intermittently achieves supraphysiological serum testosterone values (Fig. 21.6). **PSA (prostate specific antigen)** values increase slightly but remain in the normal range and uroflow is not influenced negatively.

As **benign prostate hyperplasia (BPH)** and **prostate carcinoma** increase with age and thus also the danger of stimulating an existing prostate carcinoma, before testosterone therapy, every patient should be thoroughly examined and, if over 45, the prostate should be checked at least annually.

Rectal examination of the prostate for size, surface and consistency is part of routine monitoring of testosterone therapy.

If possible, rectal palpation should be supplemented by **transrectal ultrasonography (TRUS)** as it allows non-invasive evaluation of the entire organ. Precisely measured prostate volume is a parameter for testosterone substitution, but does not only depend on serum testosterone levels, but also on androgen receptor polymorphism (Behre et al. 1994b; Zitzmann et al. 2003) (Fig. 21.11). Measurement of PSA (prostate specific

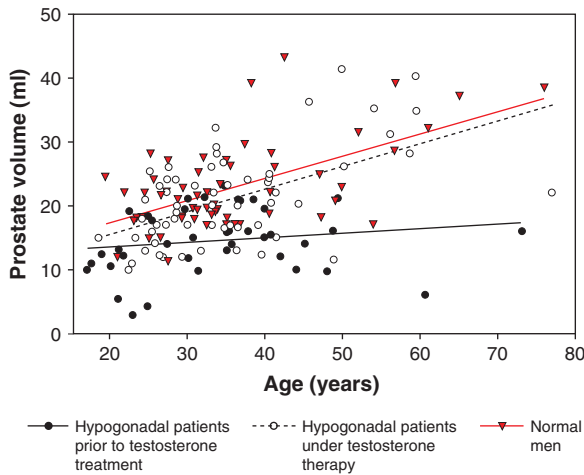
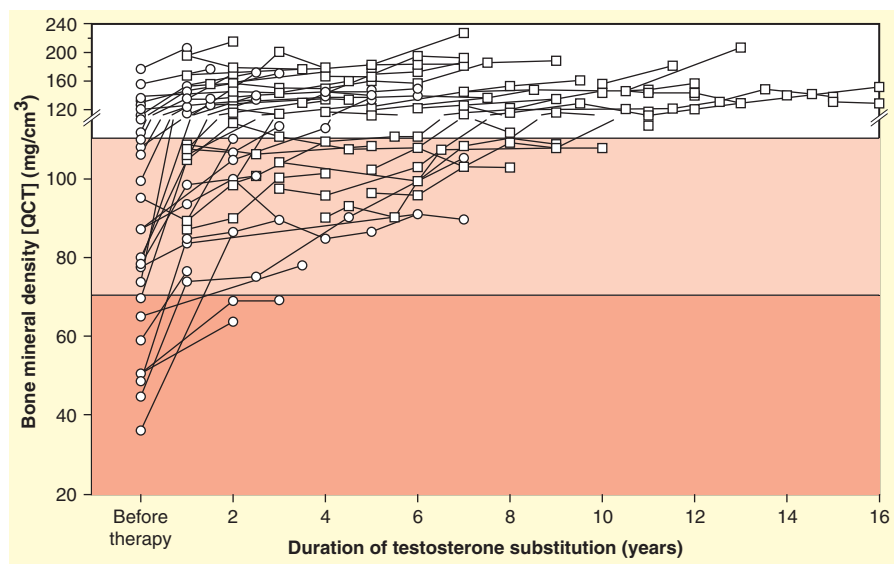

Fig. 21.11 Prostate volume (planimetric determination by transrectal ultrasound) in hypogonadal patients prior to testosterone therapy, in hypogonadal men receiving long-term effective testosterone substitution, and in age-matched normal men

antigen) in serum is part of routine monitoring of the prostate. Increases over 4 ng/ml or an increase during the course of long-term therapy of over 0.4 ng/ml per year are cause for alarm for a possible carcinoma. However, cancer may be present even with low PSA values and may be obscured by testosterone substitution. Therefore checkups 3–6 months after initiation of testosterone substitution and yearly thereafter are necessary (Nieschlag et al. 2006; Wang et al. 2008).

When a carcinoma is suspected, the patient must be referred for urologic consultation, in the course of which prostate biopsy may complete the diagnosis.

Fig. 21.12 Bone mineral density (BMD), measured by QCT of the lumbar vertebrae during long-term testosterone substitution therapy up to 16 years in 72 hypogonadal patients. Circles indicate hypogonadal patients with first QCT measurement before initiation of testosterone substitution therapy, squares show those patients already receiving testosterone therapy at the first QCT. The dark pink area indicates the range of high fracture risk, the white area shows the range without significant fracture risk, and the light red area indicates the intermediate range where fractures may occur



21.3.5 Bone Mass and Muscles

Reduced **bone mass** in hypogonadal man can be normalized by testosterone therapy (Behre et al. 1997; Snyder et al. 1999; Zitzmann and Nieschlag 2004) (Fig. 21.12). In good therapeutic adjustment both cortical as well as trabecular mass increase while vertebral surfaces (in QCT) remain unaltered (Leifke et al. 1998). If, however, testosterone therapy begins very late, predominantly cortical bone mass will increase (Finkelstein et al. 1989); vertebral bone mass can also increase and even normalize in patients in whom testosterone therapy becomes necessary at an advanced age (Behre et al. 1997; Snyder et al. 1999).

As osteoporosis and risk of fracture compromise the quality of patient life, we **measure bone density** before and at 1–2 year intervals in every patient on testosterone therapy. The results are considered when choosing the testosterone dose.

Even if not all patients can be monitored in this manner, at least those with long untreated hypogonadism and older patients should be examined at the time of first diagnosis. If bone density values are pathological, normalization should be documented by further investigations. At the very earliest, increases in bone density can be observed half a year after inception of testosterone therapy. The various diagnostic procedures are discussed in Chap. 6.

Muscle mass also increases during testosterone substitution, while fat mass simultaneously decreases (Bhasin et al. 2004; Rolf et al. 2002). Increased muscle mass is caused by hyperplasia of existing muscle cells accompanied by transformation of mesenchymal cells into new muscle cells.

21.4 Evaluation of Testosterone Substitution Therapy

Testosterone deficiency is not life-threatening, but it does reduce the **quality of life** drastically and may induce various illnesses. The assumption, often expressed, that testosterone is responsible for shorter life expectancy in men can hardly be tested experimentally. The same long life-span of men castrated prepubertally and of intact men (Nieschlag et al. 1993) supports the theory that factors other than testosterone are responsible for the different life expectancies between the sexes (see also Sect. 13.1.2, Acquired Anorchia). Low serum testosterone levels were even described as predictive of shorter life expectancy (Shores et al. 2006). At the very least there is no reason to deny a patient testosterone substitution.

Testosterone is characterized by **high therapeutic safety**, supported by the absence of serious long-term side effects following high dose administration as used for excessively tall stature (see Sect. 21.5) and its illegal use in extremely high doses in athletics and by bodybuilders (see Sect. 21.6). The only real **contraindications** are manifest prostate carcinoma or a very rare **mamma carcinoma**.

It is difficult to quantify the actual advantage of testosterone substitution therapy. The **improved quality of life** of a patient receiving testosterone therapy is undisputed. Increased self-confidence and satisfaction, confirmed by sexual activities, are factors not to be underestimated concerning the patient's social integration. By supporting physical and psychic activity his capacities are increased or maintained; elimination of anemia, strengthening of the skeleton and musculature and reduction of risk of fracture prevent invalidity and infirmity.

Adequate replacement therapy allows the patient to be integrated into society and to enjoy satisfactory quality of life.

Even if one or another patient must be convinced of the usefulness of a suggested therapy because he lacks the imagination to see its advantages, in the long run hardly any patient is willing to forego substitution therapy. Increased public discussion of the effects of testosterone and suggestions from increasing numbers of self-help groups make it easier for patients to formulate their own ideas concerning adequate therapy. It remains the physician's task to guide the patient, to monitor the various parameters and to find optimal therapeutic adjustment for the individual patient.

Concerning comparison of costs of the various licensed modalities for testosterone treatment of hypogonadal men in Germany (Table 21.3) it must be noted that physicians' fees for injection must be added to the costs for the medications, whereas all gels and transdermal modalities are applied by the patient himself. However, the necessary contact between doctor and patient required by the injections should not be underestimated as advantageous for the patient-physician relationship. In any event, renewal of a prescription should be used by patient and physician as an opportunity for exchanging information about the quality of substitution. Over and beyond this, every hypogonadal patient should be monitored yearly in a centre specialized in these diseases. Any cost-effectiveness analysis should also include additional parameters necessary for therapy supervision as shown in Table 21.4.

21.5 Excessive Height

Testosterone deficiency at the time of puberty causes eunuchoid skeletal proportions, whereas normally testosterone induces proportioned body growth by timely induction of epiphyseal maturation. Prior to puberty testosterone can cause closure of the epiphyseal lines and cause small stature, as for example in pubertas praecox. It is possible to take advantage of these facts in order to modify final height in boys predisposed to excessive height (over 2 m). High-dose testosterone administered early can stop growth.

Usually, 250 mg testosterone enanthate every week or 500 mg every 2 weeks are given intramuscularly between the ages of 12–16 years for about 1 year. The dose to be administered is at least twice that used for substitution. Therapeutic phases that are too short coupled with discontinuance before complete epiphyseal

maturity prevents the therapeutic goal from being reached. Before growth ceases, possible therapeutic success can be tested by determining bone age. The sooner therapy is begun, the more effective growth reduction will be. If bone age exceeds 14 years, testosterone is usually without effect (for review see Drop et al. 1998). However, very early therapy should be avoided as precocious puberty with its psychosocial and physical implications would be induced.

Even if testosterone is not licensed for this indication (as in Germany), for many years such treatment was carried out relatively often since the early 1950s. It is remarkable that no controlled studies have been performed to test the actual therapeutic effect. For this reason it is also important to question the results of possible long-term effects.

During treatment with pharmacological doses of testosterone, testicular development is suppressed (see Chap. 29) and the question arises whether this temporary suppression of the testis and the high doses of testosterone may have untoward effects in the (pre) pubertal patient. A similar question can be raised concerning studies on male contraception based on testosterone, but with the difference that here vertical growth is to be suppressed in an immature patient. After cessation of therapy the endocrine pituitary-gonadal axis quickly returns to normal. Long-term follow-up studies in treated boys showed no anomalies attributable to treatment compared to control populations (de Waal 1995; Lemcke et al. 1996). No alterations in the cardiovascular system and in serum lipids or in the prostate (volume, sonographic structure and PSA) were observed. Subnormal semen parameters seen relatively frequently in follow-up examinations were attributable to cryptorchidism and varicocele rather than to testosterone therapy (Lemcke et al. 1996). Concerning therapeutic safety, follow-up investigations to date show that the use of relatively high doses of testosterone in puberty remains without long-term side effects.

Even if long-term follow-up investigations do not argue against such therapy, it should be considered that this testosterone therapy accelerates pubertal development with all its psychic and physical consequences. Since psychological reasons for this therapy outweigh any medical considerations, each individual case should be carefully considered and therapy should only be administered in cases of extreme expected height. As the boys (and their parents!) tend to suffer from extreme height predominantly during the growth period, but are later well integrated, adequate medical or psychologi-

cal counselling towards better adjustment is always indicated. Often such care is sufficient and makes further testosterone therapy superfluous.

21.6 Misuse and Abuse of Anabolic Steroids

As testosterone has a strong anabolic i.e., protein-building component and induces muscle growth when accompanied by relevant physical exercise, in the 1950s and 1960s an attempt was made to dissociate the androgenic and anabolic effects by chemically altering the testosterone molecule. As a result, a multitude of so-called **anabolic steroids** were synthesized and some of them were also applied clinically (Kochakian 1976). They attempt to make clinical use of the positive effects of testosterone on muscle metabolism, blood formation and bone metabolism, while dispensing with androgenic side effects e.g., virilization in women and children. However, separation of anabolic and androgenic components remained impossible in anabolic steroids.

Extreme physical performance carried out over extended periods causes a drop of testosterone in circulation. Until recently, it was believed that use of androgens by eugonadal athletes would, at the very outside, have placebo effects. Recent investigations were able to show that pharmacological doses of androgens accompanied by exercise could indeed induce muscle growth (Bhasin 2004; Choong et al. 2008). This, however, does not apply to all androgenic steroids. For the androgen precursor androstenedione, taken by famous baseball players such as Mark McGwire and freely available in the USA as an over-the-counter food supplement, no anabolic effect could be documented (King et al. 1999). Present studies to date failed to confirm any necessity for substitution therapy in high-performance athletics. Nevertheless, the gain in strength and muscle mass induced by testosterone and anabolics led to their abuse by high-performance athletes and bodybuilders. The doses taken are often 10–100 fold higher than those used in replacement therapy (Wilson 1988; Knuth et al. 1989; Schänzer 2004). Testosterone itself, followed by nandrolone (19-nortestosterone), metandienone, stanozolol, methenolone, mesterolone, 17 α -methyltestosterone and many other substances are used. Often substances are combined and used in increasing and decreasing regimens (“stacking”). Special attention should be given to this abuse. Because of these high

doses androgenic side-effects such as suppression of hypothalamic-pituitary function and spermatogenesis up to azoospermia (Knuth et al. 1989), acne, gynaecomastia and fluid retention (and virilization with irreversible alterations of voice and clitoris in women) are well-known side-effects. Furthermore, if (obsolete) 17α -alkylated steroids (stanozolol, 17α -methyltestosterone) are used, liver toxicity with cholestasis, peliosis and even malignant neoplasm may result. Increased aggressiveness has been repeatedly ascribed to anabolic steroids and single cases are always cited as examples. Whether these cases are coincidental, as to be expected in widespread abuse of anabolics or whether there is a causal connection, cannot be determined to date because convincing studies on long-term effects are lacking (Nieschlag 1992).

However, reports on young men succumbing to sudden death following anabolic abuse are cause for alarm as they show a high incidence of coronary atherosclerosis and acute infarction; it must be noted, however, that testosterone and anabolic dosage exceeded by far those amounts administered clinically and in most cases a series of other drugs were taken, thus making a definite diagnosis and conclusions difficult (Kistler 2006).

Scientific societies and sports organizations have come out clearly against the use of anabolic steroids in athletics so that their use has become prohibited in competition and its discovery leads to disqualification and disbaring of athletes from competition (Schänzer 2004).

As anabolic steroids do not have the full spectrum of effects of testosterone, and as effective replacement therapy with testosterone preparations is available, anabolic steroids are not indicated for the treatment of male hypogonadism. Knowledge of the androgen receptor and intracellular testosterone metabolism provide new impulses for the development of more selective androgens or selected androgen receptor modulators (SARMs) currently being developed for clinical use (Gao and Dalton 2007).

References

Allan CA, Strauss BJ, Burger HG, Forbes EA, McLachlan RI (2008) Testosterone therapy prevents gain in visceral adipose tissue and loss of skeletal muscle in nonobese aging men. *J Clin Endocrinol Metab* 93:139–146

- Akcam T, Bolu E, Merati AL, Durmus C, Gerek M, Ozkaptan Y (2004) Voice changes after androgen therapy for hypogonadotrophic hypogonadism. *Laryngoscope* 114:1587–1591
- Bagchus WM, Hust R, Maris F, Schnabel PG, Houwing NS (2003) Important effect of food on the bioavailability of oral testosterone undecanoate. *Pharmacotherapy* 23:319–325
- Bals-Pratsch M, Knuth UA, Yoon YD, Nieschlag E (1986) Transdermal testosterone substitution therapy for male hypogonadism. *Lancet* ii:943–946
- Barratt-Connor E, von Mühlen DG, Kritiz-Silverstein D (1999) Bioavailable testosterone and depressed mood in older men: the Rancho Bernardo study. *J Clin Endocrinol Metab* 84:573–577
- Behre HM, Böckers A, Schlingheider A, Nieschlag E (1994a) Sustained suppression of serum LH, FSH testosterone and increase of high-density lipoprotein cholesterol by daily injections of the GnRH antagonist cetrorelix over 8 days in normal man. *Clin Endocrinol* 40:241–248
- Behre HM, Bohmeyer J, Nieschlag E (1994b) Prostate volume in testosterone-treated and untreated hypogonadal men in comparison to age-matched normal controls. *Clin Endocrinol* 40:341–349
- Behre HM, Kliesch S, Leifke E, Link TM, Nieschlag E (1997) Long-term effect of testosterone therapy on bone mineral density in hypogonadal men. *J Clin Endocrinol Metab* 82:2386–2390
- Behre HM, Abshagen K, Oettel M, Hübler D, Nieschlag E (1999a) Intramuscular injection of testosterone undecanoate for the treatment of male hypogonadism: phase I-studies. *Eur J Endocrinol* 140:414–419
- Behre HM, von Eckardstein S, Kliesch S, Nieschlag E (1999b) Long-term substitution therapy of hypogonadal men with transscrotal testosterone over seven to ten years. *Clin Endocrinol* 50:629–635
- Behre HM, Wang C, Handelsman DJ, Nieschlag E. (2004) Pharmacology of testosterone preparations. In: Nieschlag E, Behre HM (eds) *Testosterone – Action, deficiency, substitution*, 3rd edn. Cambridge University Press, Cambridge, pp 405–444
- Beutel ME, Wiltink J, Hauck EW, Auch D, Behre HM, Brähler E, Weidner W, The Hypogonadism Investigator Group (2005) Correlations between hormones, physical, and affective parameters in aging urologic outpatients. *Eur Urol* 47: 749–755
- Bhasin S (2004) Testosterone effects on the skeletal muscle. In: Nieschlag E, Behre HM (eds) *Testosterone – action, deficiency, substitution*, 3rd edn. Cambridge University Press, Cambridge, pp 255–282
- Butenandt A, Hanisch G (1931) Umwandlung des Dehydroandrosterons in Androstendiol und Testosteron; ein Weg zur Darstellung des Testosterons aus Cholesterin. *Hoppe-Seyler's Z Physiol Chem* 231:289–98
- Calof OM, Singh AB, Lee ML, Kenny AM, Urban RJ, Tenover JL, Bhasin S (2005) Adverse events associated with testosterone replacement in middle-aged and older men: A metaanalysis of randomized, placebo-controlled trials. *J Gerontol A Biol Sci Med Sci* 69:1451–1457
- Cherrier MM, Asthana S, Plymate S, Baker L, Matsumoto AM, Peskind E, Raskind MA, Brodtkin K, Bremner W, Petrova A, LaTendresse S, Craft S (2001) Testosterone supplementation

- improves spatial and verbal memory in healthy older men. *Neurology* 57:80–88
- Choong K, Lakshman KM, Bhasin S (2008) The physiological and pharmacological basis for the ergogenic effects of androgens on elite sports. *Asian J Androl* 10:351–363
- Christiansen K (2004) Behavioural correlates of testosterone. In: Nieschlag E, Behre HM (eds) *Testosterone – action, deficiency, substitution*, 3rd edn. Cambridge University Press, Cambridge, pp 125–172
- Cunningham GR, Hirshkowitz M, Kroenman SG, Karacan I (1990) Testosterone replacement therapy and sleep-related erections in hypogonadal men. *J Clin Endocrinol Metab* 70:792–797
- de Waal WJ, Vreeburg JTM, Bekkering F, de Jong FH, de Muinck Keizer-Schrama SMPF, Drop SLS, Weber RFA (1995) High-dose testosterone therapy for reduction of final height in constitutionally tall boys: Does it influence testicular function in adulthood? *Clin Endocrinol* 43:87–95
- Delanoe D, Fougevrollas B, Meyer L, Thonneau P (1984) Androgenisation of female partners of men on medroxyprogesterone acetate/percutaneous testosterone contraception. *Lancet* 1:276
- Drop SLS, de Waal J, de Muinck Keizer-Schrama SMPF (1998) Sex steroid treatment of constitutionally tall stature. *Endocr Rev* 19:540–558
- Finkelstein JS, Klibanski A, Neer RM, Doppelt SH, Rosenthal DI, Segre GV, Crowley W jr (1989) Increases in bone density during treatment of men with idiopathic hypogonadotropic hypogonadism. *J Clin Endocrinol Metab* 69:776–783
- Gao W, Dalton JT (2007) Expanding the therapeutic use of androgens via selective androgen receptor modulators (SARMs). *Drug Discov Today* 12:241–248
- Gooren LJG (1998) A ten year safety study on the oral androgen testosterone undecanoate. *J Androl* 15:212–215
- Gooren LJ, Behre HM, Saad F, Frank A, Schwerdt S (2007) Diagnosing and treating testosterone deficiency in different parts of the world. Results from global market research. *Aging Male* 10:173–181
- Hajjar RR, Kaiser FE, Morley JE (1997) Outcomes of long term testosterone replacement in older hypogonadal males: A retrospective analysis. *J Clin Endocrinol Metab* 82: 3793–3796
- Isidori AM, Giannetta E, Greco EA, Gianfrilli D, Bonifacio V, Isidori A, Lenzi A, Fabbri A (2005) Effects of testosterone on body composition, bone metabolism and serum lipid profile in middle-aged men: A meta-analysis. *Clin Endocrinol* 63:280–293
- Jockenhövel F, Vogel E, Reinhardt W, Reinwein D (1997) Effects of various modes of androgen substitution therapy on erythropoiesis. *Eur J Med Res* 2:293–298
- Jockenhövel F, Bullmann C, Schubert M, Vogel E, Reinhardt W, Reinwein D, Müller-Wieland D, Krone W (1999) Influence of various modes of androgen substitution on serum lipids and lipoproteins in hypogonadal men. *Metabolism* 48:590–596
- Kelleher S, Turner L, Howe C, Conway AJ, Handelsman DJ (1999) Extrusion of testosterone pellets: A randomized controlled clinical study. *Clin Endocrinol* 51:469–471
- Kelleher S, Conway AJ, Handelsman DJ (2004) Blood testosterone threshold for androgen deficiency symptoms. *J Clin Endocrinol Metab* 89:3813–3817
- King DS, Sharp RL, Vukovich MD, Brown GA, Reifenrath TA, Uhl NL, Parsons KA (1999) Effect of oral androstenedione on serum testosterone and adaptations to resistance training in young men: A randomized controlled trial. *JAMA* 281: 2020–2028
- Kistler L (2006) *Todesfälle bei Anabolikamissbrauch*. Dissertation, München
- Knuth UA, Maniera H, Nieschlag E (1989) Anabolic steroids and semen parameters in body builders. *Fertil Steril* 52:1041–1047
- Kochakian CD (ed) (1976) *Anabolic androgenic steroids. Handbook of experimental pharmacology*, vol. 43. Springer, Berlin
- Korbonits M, Slawik M, Cullen D, Ross RJ, Stalla G, Schneider H, Reincke M, Bouloux PM, Grossmann AB (2004) A comparison of a novel testosterone bioadhesive buccal system, Striant, with a testosterone adhesive patch in hypogonadal males. *J Clin Endocrinol Metab* 89:2039–2043
- Kühnert B, Byrne M, Simoni M, Köpcke W, Gerss J, Lemnitz G, Nieschlag E (2005) Testosterone substitution with a new transdermal, hydroalcoholic gel applied to scrotal or non-scrotal skin: A multicentre trial. *Eur J Endocrinol* 153: 317–326
- Leifke E, Körner HC, Link TM, Behre HM, Peters PE, Nieschlag E (1998) Effects of testosterone replacement therapy on cortical and trabecular bone mineral density, vertebral body area and paraspinal muscle area in hypogonadal men. *Eur J Endocrinol* 138:51–58
- Lemcke B, Zentgraf J, Behre HM, Kliesch S, Nieschlag E (1996) Long-term effects on testicular function of high-dose testosterone treatment for excessively tall stature. *J Clin Endocrinol Metab* 81:296–301
- McGriff-Lee NJ (2002) Transdermal testosterone gel (Cellegy). *Curr Opin Investig Drugs* 3:1629–1632
- McNicholas T, Ong T (2006) Review of Testim gel. *Expert Opin Pharmacother* 7:477–484
- Meikle AW (1998) A permeation-enhanced non-scrotal testosterone transdermal system for the treatment of male hypogonadism. In: Nieschlag E, Behre HM (eds) *Testosterone – action, deficiency, substitution*, 2nd edn. Springer, Heidelberg, pp 389–422
- Morales A, Johnston B, Heaton JP, Lundie M (2007) Testosterone supplementation for hypogonadal impotence: assessment of biochemical measures and therapeutic outcomes. *J Urol* 157:849–854
- Nieschlag E (1981) Ist die Anwendung von Methyltestosteron obsolet? *Dtsch Med Wschr* 106:1123–1125
- Nieschlag E (1992) Testosteron, Anabolika und aggressives Verhalten bei Männern. *Dtsch Ärztsbl* 89:2967–2972
- Nieschlag E (2006) Testosterone treatment comes of age: New options for hypogonadal men. *Clin Endocrinol* 65:275–281
- Nieschlag E, Behre HM (eds) (2004) *Testosterone – action, deficiency, substitution*, 3rd edn. Cambridge University Press, Cambridge
- Nieschlag E, Behre HM (2004) Clinical use of testosterone in hypogonadism and other conditions. In: Nieschlag E, Behre HM (eds) *Testosterone – action, deficiency, substitution*. 3rd edn. Cambridge University Press, Cambridge, pp 375–404
- Nieschlag E, Wang CH, Handelsman DJ, Swerdloff RS, Wu FCW, Einer-Jensen N, Khanna J, Waites GMH, World Health Organization (eds) (1992) *Guidelines for the use of androgens*. WHO, Geneva

- Nieschlag E, Nieschlag S, Behre HM (1993) Life expectancy and testosterone. *Nature* 366:215
- Nieschlag E, Büchter D, von Eckardstein S, Abshagen K, Behre HM (1999) Repeated intramuscular injections of testosterone undecanoate for substitution therapy of hypogonadal men. *Clin Endocrinol* 51:757–763
- Nieschlag E, Behre HM, Bouchard P, Corrales JJ, Jones TH, Stalla GK, Webb SM, Wu FC (2004) Testosterone replacement therapy: Current trends and future directions. *Hum Reprod Update* 10:409–419
- Nieschlag E, Swerdloff R, Behre HM, Gooren LJ, Kaufman JM, Legros JJ, Lunenfeld B, Morley JE, Schulman C, Wang C, Weidner W, Wu FC (2006) Investigation, treatment, and monitoring of late-onset hypogonadism in males: ISA, ISSAM, and EAU recommendations. *Int J Androl* 27: 135–137
- O'Connor DB, Archer J, Hair WM, Wu FC (2002) Exogenous testosterone, aggression, and mood in eugonadal and hypogonadal men. *Physiol Behav* 75:557–566
- Randall VA (2004) Androgens and hair. In: Nieschlag E, Behre HM (eds) *Testosterone – Action, deficiency, substitution*, 3rd edn. Cambridge University Press, Cambridge, pp 207–231
- Rolf C, von Eckardstein S, Koken U, Nieschlag E (2002) Testosterone substitution of hypogonadal men prevents the age-dependent increases in body mass index, body fat and leptin seen in healthy ageing men: Results of a cross-sectional study. *Eur J Endocrinol* 146:505–511
- Ruzicka L, Wettstein A (1935) Synthetische Darstellung des Testishormons, Testosteron (Androsten 3-on-17-ol). *Helv chim Acta* 18:1264–1275
- Schänzer W (2004) Abuse of androgens and detection of illegal use. In: Nieschlag E, Behre HM (eds) *Testosterone – Action, deficiency, substitution*, 3rd edn. Cambridge University Press, Cambridge, pp 715–735
- Schaison G, Couzinet B. (1998) Percutaneous dihydrotestosterone treatment In: Nieschlag E, Behre HM (eds) *Testosterone – action, deficiency, substitution*, 2nd edn. Springer, Heidelberg, pp 423–436
- Schubert M, Minnemann T, Hübler D, Rouskova D, Christoph A, Oettel M, Ernst M, Mellinger U, Krone W, Jockenhövel F (2004) Intramuscular testosterone undecanoate: Pharmacokinetic aspects of a novel testosterone formulation during long-term treatment of men with hypogonadism. *J Clin Endocrinol Metab* 89:5429–5434
- Schürmeyer T, Wickings EJ, Freischem CW, Nieschlag E (1983) Saliva and serum testosterone following oral testosterone undecanoate administration in normal and hypogonadal men. *Acta Endocrinol* 102:456–462
- Shores MM, Matsumoto AM, Sloan KL, Kivlahan DR (2006) Low serum testosterone and mortality in male veterans. *Arch Intern Med* 166:1660–1665
- Snyder PJ, Peachey H, Hannoush P, Berlin JA, Loh L, Holmes JH, Dlewati A, Staley J, Santanna J, Kapoor SC, Attie MF, Haddad JG Jr, Strom BL (1999) Effect of testosterone treatment on bone mineral density in men over 65 years of age. *J Clin Endocrinol Metab* 84:1966–1972
- Swerdloff RS, Wang C, Cunningham G, Dobs A, Iranmanesh A, Matsumoto AM, Snyder PJ, Weber T, Longstreth J, Berman N (2000) Long-term pharmacokinetics of transdermal testosterone gel in hypogonadal men. *J Clin Endocrinol Metab* 85:4500–4510
- von Eckardstein A, Wu FCW (2004) Testosterone and cardiovascular diseases. In: Nieschlag E, Behre HM (eds) *Testosterone – action, deficiency, substitution*, 3rd edn. Cambridge University Press, Cambridge, pp 297–332
- von Eckardstein S, Nieschlag E (2002) Treatment of male hypogonadism with testosterone undecanoate injected at extended intervals of 12 weeks: a phase II study. *J Androl* 23:419–425
- Wang C, Cunningham G, Dobs A, Iranmanesh A, Matsumoto AM, Snyder PJ, Weber T, Berman N, Hull L, Swerdloff RS (2004) Long-term testosterone gel (AndroGel) treatment maintains beneficial effects on sexual function and mood, lean and fat mass, and bone mineral density in hypogonadal men. *J Clin Endocrinol Metab* 89:2085–2098
- Wang C, Nieschlag E, Swerdloff R, Behre HM, Hellstrom WJ, Gooren LJ, Kaufmann JM, Legros JJ, Lunenfeld B, Morales A, Morley JE, Schulman C, Thompson IM, Weidner W, Wu FC (2008) Investigation, treatment and monitoring of late-onset hypogonadism in males. *Int J Androl* [Epub ahead of print]
- Wang L, Shi DC, Lu SY, Fang RY (1991) The therapeutic effect of domestically produced testosterone undecanoate in Klinefelter syndrome. *New Drugs Mark* 8:28–32
- World Health Organization, Nieschlag E, Wang Ch, Handelsman DJ, Swerdloff RS, Wu FCW, Einer-Jensen N, Khanna J, Waites GMH (eds) (1992) *Guidelines for the use of androgens*. WHO, Geneva
- Wilson JD (1988) Androgen abuse by athletes. *Endocr Rev* 9:181–199
- Zitzmann M, Nieschlag E (2004) Androgens and bone metabolism. In: Nieschlag E, Behre HM (eds) *Testosterone – action, deficiency, substitution*, 3rd edn. Cambridge University Press, Cambridge, pp 233–254
- Zitzmann M, Nieschlag E (2007) Androgen receptor gene CAG repeat length and body mass index modulate the safety of long-term intramuscular testosterone undecanoate therapy in hypogonadal men. *J Clin Endocrinol Metab*. 92: 3844–3853
- Zitzmann M, Weckesser M, Schober O, Nieschlag E (2001) Changes in cerebral glucose metabolism and visuospatial capability in hypogonadal males under testosterone substitution therapy. *Exp Clin Endocrinol Diabetes* 109: 302–304
- Zitzmann M, Depenbusch M, Gromoll J, Nieschlag E (2003) Prostate volume and growth in testosterone-substituted hypogonadal men are dependent on the CAG repeat polymorphism of the androgen receptor gene: a longitudinal pharmacogenetic study. *J Clin Endocrinol Metab* 88:2049–2054
- Zitzmann M, Faber D, Nieschlag E (2006) Association of specific symptoms and metabolic risks with serum testosterone in older men. *J Clin Endocrinol Metab* 91:4335–4343

Contents

22.1	Definition and Incidence of Male Idiopathic Infertility in Men	457
22.2	Empirical Therapy	458
22.2.1	hCG/hMG	458
22.2.2	Pulsatile GnRH	459
22.2.3	Highly Purified and Recombinant FSH	459
22.2.4	Antiandrogens and Aromatase Inhibitory Agents	459
22.2.5	Androgens	460
22.2.6	Kallikrein	463
22.2.7	Pentoxifylline	463
22.2.8	α -Receptor Blocking Agents	463
22.2.9	Antioxidants	463
22.2.10	Further Substances	464
22.2.11	Physical Procedures	464
22.3	Therapeutic Guidelines	464
References	465

22.1 Definition and Incidence of Male Idiopathic Infertility

The term “**idiopathic infertility**” designates diagnosis by exclusion. Only after all other possible causes for infertility have been eliminated can the diagnosis of “idiopathic infertility” be established. Seminal parameters are frequently subnormal and may be associated with elevated serum FSH, indicating spermatogenic failure. Testicular biopsies often show incomplete spermatogenic arrest or focal SCO and fail to provide further information concerning pathogenesis. These patients represent the largest group of men attending fertility clinics.

The collective diagnosis of “idiopathic infertility” most likely comprises a multitude of different pathogenic mechanisms. One of andrology’s most important and exciting tasks is to disclose the workings of these mechanisms and ultimately to eliminate their cause by rational therapy. New points of departure are expected from research on molecular genetics and biological regulation of spermatogenesis; the effects of gonadotropins and sex hormones at the molecular level, and the biology of the gametes. Examples of such accomplishments of research are the microdeletions of the Y chromosome, the CFTR mutations in congenital bilateral aplasia of the vas deferens (CBAVD) and the pathology of the androgen receptor.

It should be pointed out that the term *idiopathic infertility* has different meanings in andrology and gynecology. In gynecology, the term “female idiopathic infertility” refers to a condition in which clinical examination does not reveal any pathological

E. Nieschlag (✉)
Centre of Reproductive Medicine and Andrology of the
University, Domagkstr. 11, D-48149 Münster/Germany
e-mail: Eberhard.Nieschlag@ukmuenster.de

finding which might explain the infertility of the couple. Here it would be more accurate to speak of **unexplained infertility** (see Chap. 20). Although pathological findings may be seen in an idiopathic infertile male, there are (as yet) no causal explanations and, consequently, no rational therapy exists.

Even in the absence of clearcut pathophysiological concepts explaining the suitability of a given medication for treating idiopathic infertility, numerous pharmacological regimes were and continue to be applied, often for considerable periods of time, both in combined and sequential form. These are summarized below as “**empirical therapy**”. The postulate of **evidence-based medicine** following controlled studies is particularly appropriate for the critical evaluation of these therapeutic regimes.

Empiric therapeutic procedures were long practiced in andrology until their lack of effectiveness was tested in randomized controlled studies. As it proves to be continuously tempting to resurrect these therapies, results to date are summarized here to prevent the reader from undertaking unnecessary therapeutic attempts. Thus, older studies are listed here which have disproved previous therapeutic attempts.

22.2 Empirical Therapy

22.2.1 hCG/hMG

For want of a rational therapeutic approach to idiopathic infertility it seemed reasonable to apply previously successful endocrine treatment modalities for appropriate indications, i.e., in secondary hypogonadism. Because of the success rate of hCG/hMG treatment in inducing pregnancies in partners of patients with hypogonadotropic hypogonadism and on the hypothesis that elevation of gonadotropins may lead to stimulation of spermatogenesis, this regimen was also applied to patients with normogonadotropic fertility disturbances. Numerous open studies tried to demonstrate its effectiveness. It was used for almost 25 years for idiopathic infertility without clear proof of its therapeutic efficacy, making a controlled clinical study an urgent necessity.

A **placebo-controlled, prospective and randomized study** then showed that treatment with hCG/hMG could not demonstrate any beneficial effect on sperm parameters or pregnancy rates in partners of patients with normal serum concentrations of LH, FSH and testosterone and sperm concentrations below $10^6/\text{ml}$, compared to the placebo group (Knuth et al. 1987). Each change in the treatment group could be matched with a similar change in the double-blind placebo group (Fig. 22.1),

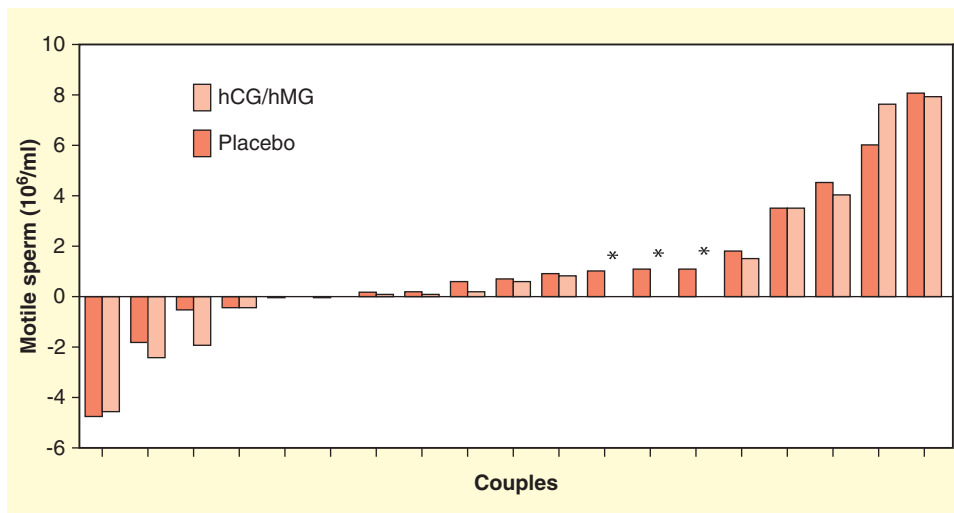

Fig. 22.1 Results of a placebo-controlled, double-blind, randomized study concerning hCG/hMG treatment for male idiopathic infertility. Columns represent differences in sperm motility after a treatment period of 12 weeks compared to pretreatment

values. Patients are grouped according to the extent of the change observed. Stars representing patients with no corresponding “partner” in the verum group. No differences between verum and placebo group can be observed (Knuth et al. 1987)

emphasizing the importance of placebo for the evaluation of therapeutic benefits in clinical studies. In conclusion, there is no evidence for benefits of hCG/hMG treatment in normogonadotropic idiopathic infertility.

22.2.2 Pulsatile GnRH

In preliminary studies it was suggested that oligoasthenoteratozoospermia in men with elevated serum FSH might be caused by too infrequent GnRH pulses. Thus the term “slow pulsing oligospermia” was introduced into andrology (Wagner and Warsch 1984). A further carefully done study reported slower LH-pulsatility but normal FSH-pulsatility in men with oligozoospermia compared to controls (Reyes-Fuentes et al. 1996). In addition, the amplified mass of LH and FSH secreted basally as well as after GnRH-injection was higher in infertile men than in controls in this study. It was claimed that GnRH injections administered at a physiologic pulse frequency would improve sperm parameters in these patients. An **uncontrolled study** was then able to show that such therapy indeed normalized FSH values, but neither improvements in sperm parameters nor in pregnancy rates were proved (Bals-Pratsch et al. 1989). The hypothesis that elevated FSH values are the cause and not the effect of disturbed spermatogenesis could not be confirmed. The lack of a pathophysiological concept and therapeutic success made a controlled study with this design superfluous.

22.2.3 Highly Purified and Recombinant FSH

Once highly purified FSH became available for clinical use it was also applied to male infertility. An increase in fertilization and pregnancy rates was reported in men treated with highly purified FSH who had failed to fertilize an oocyte in vitro prior to treatment (Acosta et al. 1992).

Although the evidence revealed by these studies is weak because of their uncontrolled design, they gave rise to a series of studies, which were, however, again largely uncontrolled. To date a total of eight randomized studies without cross-over design, and with pregnancy rates as end parameter, were carried out in men with idiopathic infertility who received highly purified

FSH or recombinant FSH (Foresta et al. 1998, 2002, 2005; Baccetti et al. 2004; Comodo et al. 1996; Matorras et al. 1997; Kamischke et al. 1998; Paradisi et al. 2006). Two studies lacked analysis of pregnancy (Foresta et al. 1998, 2002) and only three were randomized and placebo-controlled (Comodo et al. 1996; Kamischke et al. 1998; Paradisi et al. 2006). With the exception of a significant increase in sperm motility and concentration in the study by Paradisi et al. (2006), none of the placebo-controlled studies showed any increase in sperm parameters compared to baseline values or to the placebo group. A meta-analysis of all randomized studies with pregnancy rates provided an odds ratio of 1.52 for pregnancy rates (Fig. 22.2) so that 14 patients would have to be treated in order to achieve one additional pregnancy. In view of the high costs and moderate chances of success, in its present form FSH therapy for idiopathic infertility does not seem justified (Kamischke and Nieschlag 1999) and a current Cochran Review (Attia et al. 2007) recommends further studies prior to a general recommendation of FSH in idiopathic infertility.

However, in several studies, unfortunately uncontrolled, improvements of sperm morphology evidenced by electronic imaging (Bartoov et al. 1994) were registered, as were significant increases of testicular volume and DNA condensation of sperm (Kamischke et al. 1998). Just what mechanisms are involved remains unclear. Suggestions from a further uncontrolled study indicate that especially patients with moderate hypospertogenesis as seen in testicular histology, as opposed to those with spermatogenic arrest, may profit from FSH therapy (Foresta et al. 2000). Here too controlled studies should be carried out to confirm these results. However, results provide hints that further investigations into the mechanism of action are worthwhile and would help to identify patients who might react positively.

22.2.4 Antiestrogens and Aromatase Inhibitory Agents

Antiestrogens (e.g., clomiphene, tamoxifen) antagonize estrogenic activity by competitively blocking the estrogen receptor at target sites. Aromatase inhibitors (e.g., testolactone) exert similar effects by inhibiting aromatase enzyme activity which normally converts androgens to estrogens. Since estrogens suppress pituitary

Fig. 22.2 Individual (squares) and combined (COR: diamonds) odds ratio for pregnancies in randomized controlled studies with highly purified or recombinant human FSH (95% confidence interval). The broken line shows the COR

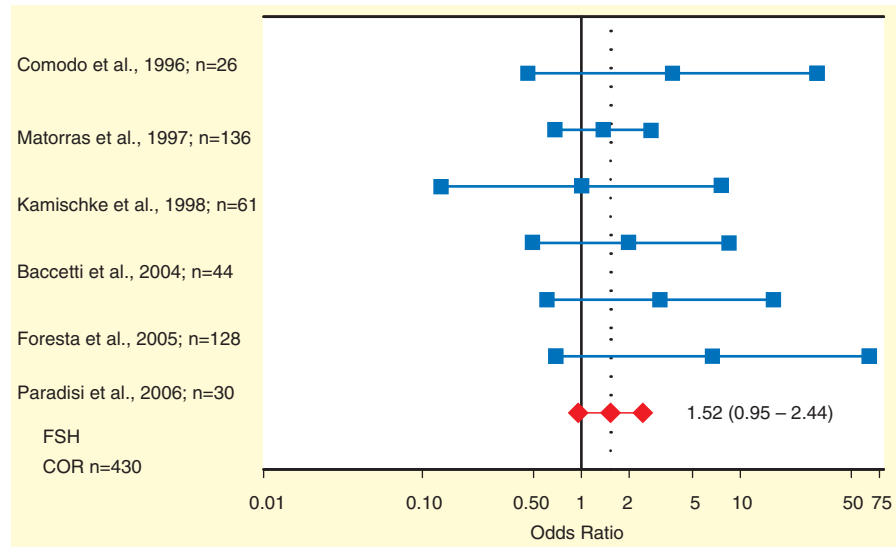

gonadotropin secretion via a negative feedback, both estrogen receptor blockade as well as lowering endogenous estrogen levels will lead to an increase in circulating LH and FSH. On the hypothesis that such an increase would result in an improvement of spermatogenic activity and sperm concentration, antiestrogens and aromatase inhibiting agents were widely used to treat male idiopathic infertility.

The inefficacy of the incomplete **aromatase inhibitor** testolactone in the treatment of male infertility has been shown by a placebo-controlled, double-blind, randomized trial (Clark and Sherins 1989).

Since then a series of studies with the **antiestrogens clomiphene and tamoxifen** for male infertility have been performed. In five double-blind, placebo-controlled studies (Ainmelk et al. 1987; Rönnerberg 1980; Sokol et al. 1988; Torök 1985; WHO 1992) carried out up to 1992 including a large-scale WHO study with clomiphene (WHO 1992), neither a single study nor the combined odds ratio of all studies were able to show any effect on pregnancy rates (Kamischke and Nieschlag 1999). Even when the five placebo-controlled not-blinded studies were also included in the analysis (Fig. 22.4), no significant effect could be shown and 24 patients would have had to be treated in order for one additional pregnancy to be achieved. Also in view of potential side-effects (Rolf et al. 1996), antiestrogens should not be applied outside clinical studies (Vandekerckhove et al. 1998).

A further placebo-controlled double-blind study found an increase of sperm motility under treatment

with testosterone undecanoate plus tamoxifen, although the rationale of such combined therapy seems unclear. In view of the proven ineffectiveness of prescribing androgen alone for male infertility and in view of the low androgen dose, it can be assumed that the effects observed are due to tamoxifen. Whether such increased motility also leads to increased pregnancy rates was not investigated at first (Adamopoulos et al. 1997). Using the same regime, the same group was then able to demonstrate a significant improvement of pregnancy rates, along with a significant improvement of sperm motility, concentration and morphology (Adamopoulos et al. 2003) (Fig. 22.3).

When this study is included in the odds ratio of the double-blind placebo-controlled studies or all placebo-controlled studies, a significant effect of antiestrogens on pregnancy rates in partners of men with idiopathic infertility (Fig. 22.4) becomes apparent. Twelve men must be treated to achieve one additional pregnancy which, considering the low costs of antiestrogens, represents an interesting option. According to the present state of knowledge, a careful recommendation of antiestrogens for men with moderately disturbed fertility can be justified.

22.2.5 Androgens

The requirement of testosterone for normal spermatogenesis under physiological conditions led to the use

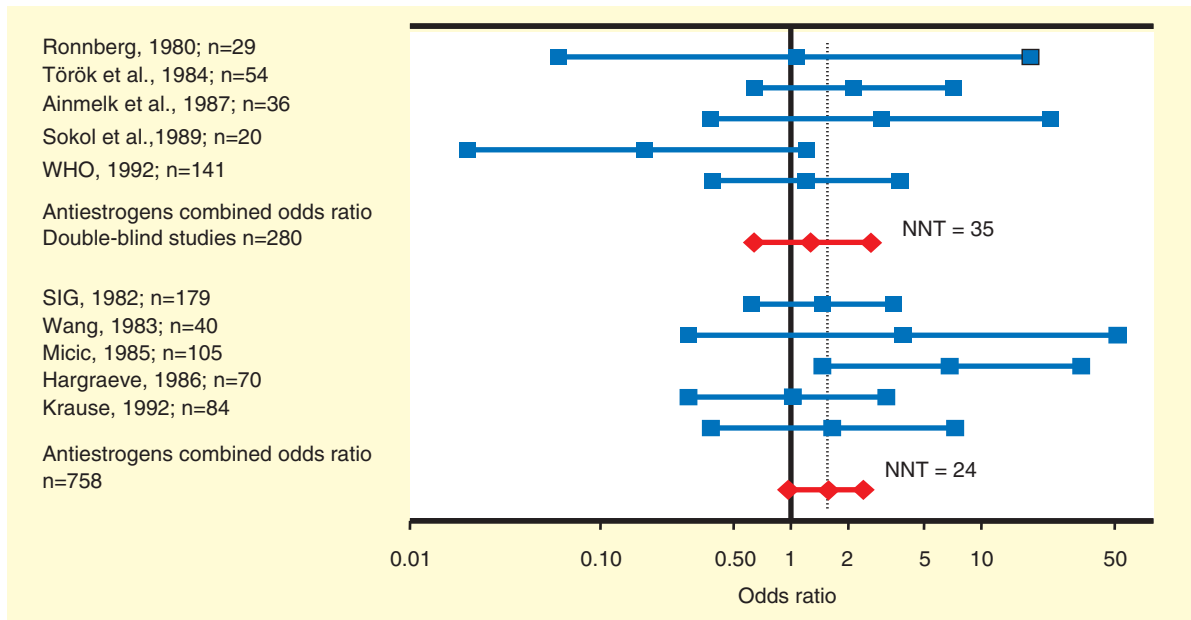

Fig. 22.3 Individual (*squares*) and combined (*diamonds*; COR) odds ratios for pregnancy rates in randomized controlled studies with antiestrogens (95% confidence intervals). The dotted line shows the COR

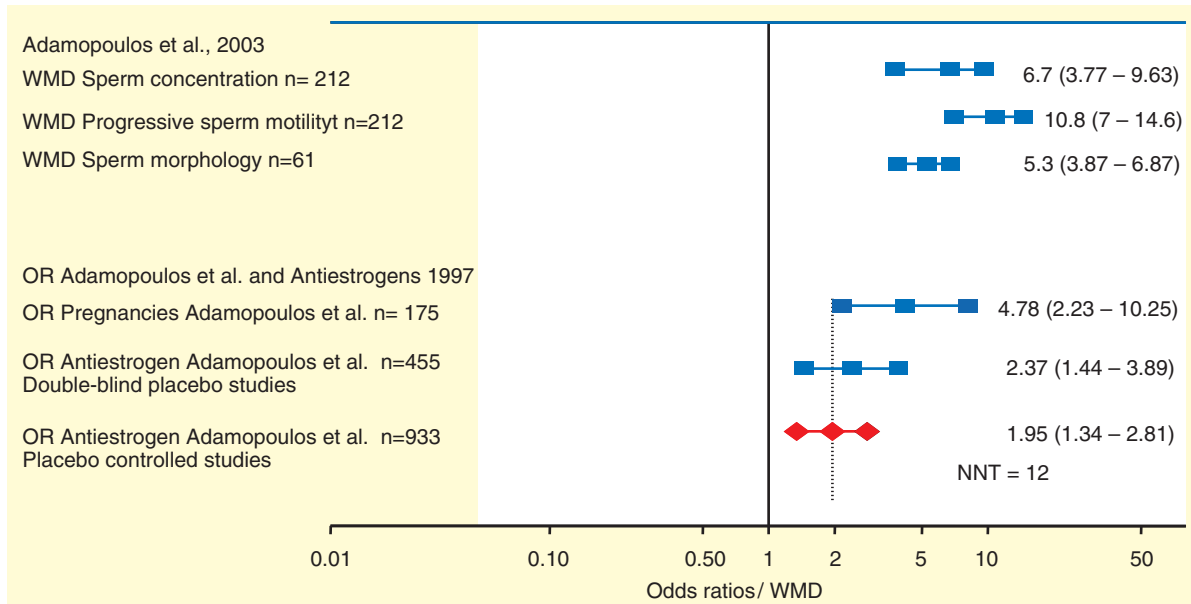

Fig. 22.4 Individual (*squares*) and combined (*diamonds*; COR) weighted mean differences (WMD) for sperm motility, concentration and morphology and odds ratios for pregnancy rates in

randomized controlled studies with antiestrogens and testosterone undecanoate (95% confidence intervals). The dotted line shows the COR

of androgens in the therapy of idiopathic infertility in men, although this cannot be justified rationally, since androgen deficiency could not be demonstrated in these patients. **Mesterolone** especially – a 5 α -reduced

testosterone derivative – was used for almost 2 decades in andrological practice, until a **multi-centered, placebo-controlled, double-blind and randomized WHO study** with 246 couples proved its ineffectiveness, as no

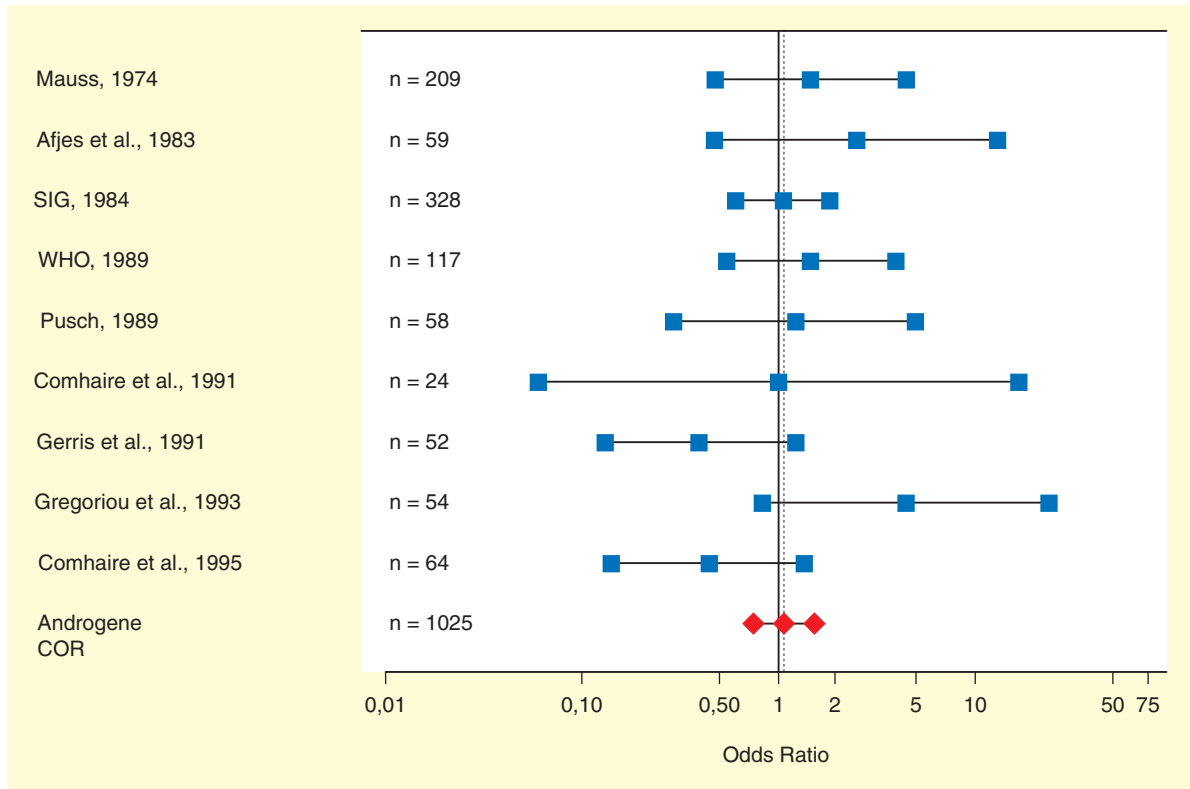

Fig. 22.5 Individual (squares) and combined (COR: diamonds) odds ratio for pregnancies in randomized controlled studies with androgens (95% confidence interval). The dotted line shows the COR (From Kamischke and Nieschlag 1999)

statistically significant increase in pregnancy rates was seen (WHO 1989). Further publications followed, so that nine randomized, placebo-controlled, double-blind studies could be evaluated in a meta-analysis. With respect to pregnancy rates, in 1,025 couples a combined odds ratio of only 1.02 (Fig. 22.5) resulted. In other words, 359 patients would have to be treated for one additional pregnancy to occur (Kamischke and Nieschlag 1999). Hence, administration of androgens is not warranted in cases of idiopathic male infertility. This statement is supported by the fact that despite an almost exponential increase in placebo-controlled andrological studies, no new studies with androgens have been performed.

Testosterone and its synthetic derivatives suppress pituitary gonadotropin secretion, thus leading to inhibition of spermatogenesis. A large proportion of patients treated with androgens become azoospermic. This effect of exogenously administered androgens is used for contraceptive trials in males (see Chap. 29). It was believed that in men with idiopathic infertility, spermatogenic

activity would be increased following treatment with testosterone, resulting in elevated sperm concentrations compared to pretreatment values (so-called **rebound effect**). This initial speculation, however, could not be confirmed by later clinical studies, neither in patients with idiopathic infertility nor in normal volunteers. All studies were uncontrolled and the pregnancy rates reported were widely scattered. For these reasons this therapy cannot be recommended. However, the initial fear that rebound therapy might lead to hyalinization of the seminiferous tubules was not confirmed. Likewise, complete reversibility of suppressed spermatogenesis was observed in volunteers treated with testosterone for contraceptive purposes (see Chap. 29).

To date there is no proof for the effectiveness of oral testosterone undecanoate and thus no rationale for its use. One attempt failed to justify the use of androgens for idiopathic infertility by giving **testosterone undecanoate** prior to in-vitro fertilization (Abdelmassih et al. 1992). Here again, the observational data were uncontrolled and could not be confirmed in a subsequent

controlled study (Comhaire et al. 1995). A placebo-controlled, double-blind study described an increase in sperm motility when men with idiopathic infertility were treated with testosterone undecanoate as a supplementary agent to tamoxifen treatment (Adamopoulos et al. 1997) and a further controlled study was able to report a three-fold increase of pregnancy rates in the verum group (Adamopoulos et al. 2003). This high success rate has not been confirmed by further studies, and since the manufacturer has not applied for licensing for this indication so far, its use in male infertility remains experimental and must be classified as an individual attempt at therapy.

22.2.6 Kallikrein

There is no clear pathophysiological or pharmacological concept for kallikrein as a treatment regimen in idiopathic male infertility. Nevertheless, it was applied in andrological practice since the 1980s. Originally, improvement of sperm motility was claimed after kallikrein application. A controlled, randomized, placebo-controlled, double-blind trial including 91 couples (Keck et al. 1994) was unable to demonstrate that kallikrein effected any significant improvement of seminal parameters and pregnancy rates. Similar negative results were reported in Japan (Yamamoto et al. 1996). The results were in line with a prospective, placebo-controlled, randomized study done in Israel including 114 couples which showed no improvement in seminal parameters (Glezermann et al. 1993). Both properly designed studies lead to the conclusion that kallikrein – given orally at the doses tested – has no beneficial effect on male idiopathic infertility (Vandekerckhove 2000a).

22.2.7 Pentoxyphylline

Pentoxifylline belongs to the family of methylxanthines. One pharmacological effect is the relaxation of vascular smooth muscles. It is therefore prescribed in vasculatory diseases associated with circulatory disturbances (e.g., intermittent claudication). It has been speculated that in men with idiopathic infertility testicular circulation might be disturbed and would be improved by pentoxifylline (Heite 1979) which was

repeatedly tried. However, there is neither evidence for circulatory disturbances in idiopathic infertility nor is there proof for any clear therapeutic effects of pentoxifylline as an infertility regimen (Wang et al. 1983; Shen et al. 1991).

Apart from oral application, pentoxifylline was used as an in-vitro additive in IVF in order to improve fertilization rates. However, an improvement in fertilization rates in asthenozoospermia, after IVF-failure or in the presence of anti-sperm antibodies could not be clearly demonstrated (for review see Tournaye et al. 1995).

22.2.8 α -Receptor Blocking Agents

Although no clear pathophysiological concept exists for the use of α -receptor blocking agents in the treatment of male infertility, placebo-controlled studies have been performed using such substances and reported increases in ejaculate volume, sperm concentration and total number of motile sperm (Yamamoto et al. 1995; Gregoriou et al. 1997). However, efficacy in terms of improved pregnancy rates has not been demonstrated. In addition, most of the studies revealed only weak statistical evidence for the observed effects. Further controlled clinical studies are necessary before the efficacy of such treatment can be appropriately evaluated.

22.2.9 Antioxidants

In almost all fields of medicine oxidative damage of proteins and nucleic acids is being discussed as a major contributing factor in pathology such as aging, degenerative diseases, cancer and arteriosclerosis. The role of oxidative stress and especially the therapeutic use of antioxidative vitamins has been widely considered for fertility disturbances (Tremellen 2008). Although oxidative stress could be damaging to reproduction by affecting spermatogenesis, sperm maturation or storage, reactive oxygen species (ROS) in physiological amounts are required for normal sperm function (Aitken 1995). For instance, an inverse correlation has been shown between fertilization rates in vitro and the ROS scavenging properties of sperm involved (Yeung et al. 1996). In placebo-controlled studies, administration of

200–1,000 mg **ascorbic acid** given to patients with increased sperm agglutination (but without anti-sperm antibodies) or to heavy smokers (Dawson et al. 1992) led to improved sperm quality. In addition, controlled studies have been performed for other antioxidants. After a 2-month course of **glutathione** application, improvement in sperm motility was reported (Lenzi et al. 1993); **carnitin** (Lenzi et al. 2003) or **carnitin combined with L-acetyl carnitin** (Lenzi et al. 2004) led to increased sperm motility and **vitamin E**, when given orally for 3 months, seems to enhance zona pellucida binding of sperm as seen in the hemi-zona-assay (Kessopoulou et al. 1995). A positive effect of carnitin, however, could not be confirmed (Sigman et al. 2006). One study found an increased pregnancy rate after vitamin E administration (Suleiman et al. 1996). However, combined vitamin C and E in a randomized placebo-controlled study failed to show a positive effect on sperm parameters or pregnancy rates (Rolf et al. 1999), while a further study found a positive effect of the combination prior to ICSI treatment with respect to pregnancy rates (Greco et al. 2005). In view of the highly contradictory results and the small numbers of patients in mostly uncontrolled studies to date, a recent overview concludes that attempts with antioxidants continue to be considered experimental and have no place in clinical routine (Patel and Sigman 2008). Still various antioxidants continue to be used for male infertility treatment. A particularly clever firm combines all substances in question such as vitamin C, E, B6 and B12, folic acid, L-carnitin, Coenzyme Q₁₀, selenium, zinc, carotinoids and omega-3 fatty acids and sells them with suggestive names without proof of the effectiveness of the single or combined substances. It is the physician's task to enlighten the patient and shield him from unnecessary expense. Notwithstanding, the field deserves further research to find out which patients may indeed profit from antioxidative therapy.

22.2.10 Further Substances

Several other substances have been used to treat idiopathic male infertility. **Bromocriptine**, successfully used in hyperprolactinemia, was tried without success in infertility (Vandekerckhove et al. 2000b).

Though lacking any clear concept, recombinant **growth hormone** was also tried, but with the exception

of increased ejaculate volume (possibly via increased testosterone) had no effect (Carani et al. 1999). When applying this hormone in men with no pituitary disease, it must be considered that increased growth hormone may lead to prostate hypertrophy, as observed in acromegalic patients (Colao et al. 1999).

On the theory that **oxytocin** increases the contractility of the epididymis and may promote higher sperm numbers by increased emptying of the sperm reserves, oxytocin was given i.v. or intranasally immediately before ejaculation, but failed to improve ejaculate parameters or pregnancy rates (Byrne et al. 2003; Walch et al. 2001).

Despite the lack of any convincing data, substances used empirically also include **interferon- α** , **mast cell blockers** and **antihistamines** (ketotifen), **angiotensin-converting enzyme (ACE) inhibitors** (Captopril), and zinc salts.

22.2.11 Physical Procedures

Overheating the genital organs is considered a means to reduce fertility (see Chap. 19) and **cooling of the scrotal organs** has been variously tried as therapy. No convincing theory for increasing pregnancy rates has yet been developed (Jung and Schuppe 2007).

Acupuncture has also been considered for treatment of male infertility. No positive effects on pregnancy rates have been reported (Ng et al. 2008).

22.3 Therapeutic Guidelines

In summary, pharmacological approaches to the therapy of male idiopathic infertility have been highly disappointing. Although a variety of drug regimens has been offered for clinical practice, no single regimen mentioned above turned out to have any significant effect on pregnancy rates in controlled clinical studies. This overview emphasizes the importance of well-designed, **randomized controlled clinical studies** for the evaluation of therapeutics in andrology (Kamischke and Nieschlag 1999). Until a given therapeutic regimen has proven its benefits in controlled clinical studies, it should not be prescribed for general practice and physicians should be guided by the following principle:

Any therapy in male infertility is to be considered experimental as long as it has not proven its efficacy in randomized controlled clinical studies. Therapeutic regimens without evidence for their efficacy should only be applied in clinical studies.

This principle demands great **discipline** from the physician who may be urged towards therapeutic intervention by the patient's suffering and expectations. In addition, **consensus** among the medical profession is necessary to prevent untimely use of unproven therapies so that **spontaneous** pregnancies are not ascribed to these therapies by grateful patients.

At present attention previously given to empirical forms of therapy is waning in the face of clinical success enjoyed by techniques of **assisted fertilization**. Pharmacological approaches to male idiopathic infertility are becoming less important. In particular, **ICSI** is proving to be beneficial in cases of severe oligoasthenoteratozoospermia and even in azoospermia (see Chap. 23). Especially assisted fertilization is proving anew the adage that intensive therapy of female reproductive functions is the best treatment for male infertility, summarized in the following principle:

Every therapy for male infertility must be accompanied by optimization of female reproductive functions. This is especially valid when no effective treatment is available for disturbed male fertility.

Empirical therapies which have remained without success so far must not prevent the search for effective treatments of male infertility. The success of assisted reproduction notwithstanding, most patients would prefer to conceive their children in privacy and not in the laboratory and would prefer a cause-related therapy for their illness. In addition, especially when the costs for assisted reproduction are not assumed by insurers, there is much demand for medication which is reimbursable or at least less costly than assisted reproduction. This pressure must not give rise to hasty prescribing but should motivate researchers to carry out more intensive research. It is the time-consuming and responsible task of the treating physician to enlighten the patient and the couple and to provide counsel while guiding them through the jungle of medications and procedures offered. In view of the lack of rational therapies, intensive counseling along

with optimization of female reproductive functions are the measures most likely to achieve success.

References

- Abdelmassih R, Dhont M, Comhaire F (1992) Pilot study with 120 mg Andriol treatment for couples with a low fertilization rate during in-vitro fertilization. *Hum Reprod* 7:267–268
- Acosta A, Khalifa E, Oehninger S (1992) Pure human follicle stimulating hormone has a role in the treatment of severe male infertility by assisted reproduction: Norfolk's total experience. *Hum Reprod* 7:1067–1072
- Adamopoulos DA, Nicopoulou S, Kapolla N, Karamertzanis M, Andreou E (1997) The combination of testosterone undecanoate with tamoxifen citrate enhances the effects of each agent given independently on seminal parameters in men with idiopathic oligozoospermia. *Fertil Steril* 67:756–762
- Adamopoulos DA, Pappa A, Billa E, Nicopoulou S, Koukkou E, Michopoulos J (2003) Effectiveness of combined tamoxifen citrate and testosterone undecanoate treatment in men with idiopathic oligozoospermia. *Fertil Steril* 80:914–920
- Afjes JH, van der Vijver JC, Brugman FW, Schenck PE (1983) Double-blind cross over treatment with mesterolone and placebo of subfertile oligozoospermic men value of testicular biopsy. *Andrologia* 15:531–535
- Ainmelk Y, Belisle S, Carmel M, JP Tetrault (1987) Tamoxifen citrate therapy in male infertility. *Fertil Steril* 48:113–127
- Aitken RJ (1995) Free radicals, lipid peroxidation and sperm function. *Reprod Fertil Dev* 7:659–668
- Attia AM, Al-Inany HG, Proctor ML (2007) Gonadotrophins for idiopathic male factor subfertility. *Cochrane Database Syst Rev* 2007 CD00 5071
- Baccetti B, Piomboni P, Bruni E, Capitani S, Gambera L, Moretti E, Sterzik K, Strehler E (2004) Effect of follicle-stimulating hormone on sperm quality and pregnancy rate. *Asian J Androl* 6:133–137
- Bals-Pratsch M, Knuth UA, Hönigl W, Klein HM, Bergmann M, Nieschlag E (1989) Pulsatile GnRH-therapy in oligozoospermic men does not improve seminal parameters despite decreased FSH levels. *Clin Endocrinol* 30:549–560
- Bartoov B, Har-Even D, Eltes F, Lederman H, Lunenfeld E, Lunenfeld B (1994) Sperm quality of subfertile males before and after treatment with human follicle-stimulating hormone. *Fertil Steril* 61:727–734
- Byrne MM, Rolf C, Depenbusch M, Cooper TG, Nieschlag E (2003) Lack of effect of a single i.v. dose of oxytocin on sperm output in severely oligozoospermic men. *Hum Reprod* 18:2098–2102
- Carani C, Granata AR, De Rosa M, Garau C, Zarrilli S, Paesano L, Colao A, Marrama P, Lombardi G (1999) The effect of chronic treatment with GH on gonadal function in men with isolated GH deficiency. *Eur J Endocrinol* 140:224–230
- Clark R, Sherins RJ (1989) Treatment of men with idiopathic oligozoospermic infertility using the aromatase inhibitor testolactone. Results of a double-blinded, randomized, placebo-controlled trial with crossover. *J Androl* 10:240–347
- Colao A, Marzullo P, Piezia S, Ferone D, Giaccio A, Cerbone G, Pivonello R, Di Somma C, Lombardi G (1999) Effect of

- growth hormone (GH) and insulin-like growth factor I on prostate diseases: An ultrasonographic and endocrine study in acromegaly, GH deficiency, and healthy subjects. *J Clin Endocrinol Metab* 84:1986–1991
- Comhaire FH (1990) Treatment of idiopathic testicular failure with high-dose testosterone undecanoate: A double blind pilot study. *Fertil Steril* 54:689–693
- Comhaire F, Schoonjans F, Abdelmassih R, Gordts S, Campo R, Dhont M, Milingos S, Gerris J (1995) Does treatment with testosterone undecanoate improve the in-vitro fertilizing capacity of spermatozoa in patients with idiopathic testicular failure (results of a double-blind study). *Hum Reprod* 10:2600–2602
- Comodo F, Vargiu N, Farina M (1996) Double-blind FSH-HP/Placebo treatment of severe male factor related infertility: Effect on sperm parameters and IVF/ICSI outcome. *ESHRE Abstract Book* S41
- Dawson EB, Harris WA, Teter MC, Powell LC (1992) Effect of ascorbic acid supplementation on the sperm quality of smokers. *Fertil Steril* 58:1034–1039
- Foresta C, Bettella A, Ferlin A, Garolla A, Rossato M (1998) Evidence for a stimulatory role of follicle-stimulating hormone on the spermatogonial population in adult males. *Fertil Steril* 69:636–642
- Foresta C, Bettella A, Merico M, Garolla A, Plebani M, Ferlin A, Rossato M (2000) FSH in the treatment of oligozoospermia. *Mol Cell Endocrinol* 161:89–97
- Foresta C, Bettella A, Merico M, Garolla A, Ferlin A, Rossato M (2002) Use of recombinant human follicle-stimulating hormone in the treatment of male factor infertility. *Fertil Steril* 77:238–244
- Foresta C, Bettella A, Garolla A, Ambrosini G, Ferlin A (2005) Treatment of male idiopathic infertility with recombinant human follicle-stimulating hormone: A prospective, controlled, randomized clinical study. *Fertil Steril* 84:654–661
- Gerris J, Comhaire F, Hellemans P, Peeters K, Schoonjans F (1991) Placebo controlled trial of high dose Mesterolone treatment of male infertility. *Fertil Steril* 55:603–607
- Glezermann M, Huleihel M, Lunenfeld E, Soffer Y, Potashnik G, Segal S (1993) Efficacy of kallikrein in the treatment of oligozoospermia and asthenozoospermia: A double-blind trial. *Fertil Steril* 60:1052–1056
- Greco E, Romano S, Iacobelli M, Ferrero S, Baroni E, Minasi MG, Ubaldi F, Rienzi L, Tesarik J (2005) ICSI in cases of sperm DNA damage: beneficial effect of oral antioxidant treatment. *Hum Reprod* 20:2590–2594
- Gregoriou O, Papadias C, Gargaropoulos A, Konidaris S, Kontogeorgi Z, Kalampokas E (1993) Treatment of idiopathic infertility with testosterone undecanoate. A double blind study. *Clin Exp Obstet Gynecol* 20:9–12
- Gregoriou O, Vitoratos N, Papadias C, Gargaropoulos A, Konidaris S, Giannopoulos V, Chryssicopoulos A (1997) Treatment of idiopathic oligozoospermia with an alpha-blocker: A placebo-controlled double-blind trial. *Int J Fertil Womens Med* 42:301–305
- Heite HG (1979) The effect of Trental on spermographic parameters, a clinical study in patients with reduced fertility. *Fertil Steril* 20(Suppl. 1):38–42
- Jung A, Schuppe HC (2007) Influence of genital heat stress on semen quality in humans. *Andrologia* 39:203–215
- Kamischke A, Nieschlag E (1999) Analysis of medical treatment of male infertility. *Hum Reprod* 14(Suppl 1):1–23
- Kamischke A, Behre HM, Bergmann M, Simoni M, Schäfer T, Nieschlag E (1998) Recombinant human follicle-stimulating hormone for treatment of male idiopathic infertility: A randomized, double-blind, placebo-controlled, clinical trial. *Hum Reprod* 13:596–603
- Keck C, Behre HM, Jockenhövel F, Nieschlag E (1994) Ineffectiveness of kallikrein in treatment of idiopathic male infertility: A double-blind, randomized, placebo-controlled trial. *Hum Reprod* 9:325–329
- Kessopoulou E, Russel JM, Powers HJ, Cooke ID, Sharma KK, Barratt CLR, Pearson MJ (1995) A double-blind randomized placebo cross-over controlled trial using the antioxidant vitamin E to treat reactive oxygen species associated male infertility. *Fertil Steril* 64:825–831
- Knuth UA, Hönlgl W, Bals-Pratsch M, Schleicher G, Nieschlag E (1987) Treatment of severe oligozoospermia with hCG/hMG. A placebo-controlled double-blind trial. *J Clin Endocrinol Metab* 65:1081–1087
- Krause W, Holland-Moritz H, Schramm P (1992) Treatment of idiopathic oligozoospermia with tamoxifen. A randomized controlled study. *Int J Androl* 15:14–18
- Lenzi A, Culasso F, Gandini L, Lombardo F, Dondero F (1993) Placebo-controlled, double-blind, cross-over trial of glutathione therapy in male infertility. *Hum Reprod* 8:1657–1662
- Lenzi A, Lombardo F, Sgrò P, Salacone P, Caponecchia L, Dondero F, Gandini L (2003) Use of carnitine therapy in selected cases of male factor infertility: A double-blind crossover trial. *Fertil Steril* 79:292–300
- Lenzi A, Sgrò P, Salacone P, Paoli D, Gilio B, Lombardo F, Santulli M, Agarwal A, Gandini L (2004) A placebo-controlled double-blind randomized trial of the use of combined L-carnitine and L-acetyl-carnitine treatment in men with asthenozoospermia. *Fertil Steril* 81:1578–1584
- Matorras R, Perez C, Corcostegui B, Pijoan JI, Ramon O, Delgado P, Rodriguez-Escudero FJ (1997) Treatment of the male with follicle-stimulating hormone in intrauterine insemination with husband's spermatozoa: A randomized study. *Hum Reprod* 12:24–28
- Mauss J (1974) Ergebnisse der Behandlung von Fertilitätsstörungen des Mannes mit Mesterolone oder einem Placebo. *Arzneim Forsch* 24:1338–1341
- Micic S, Dotlic R (1985) Evaluation of sperm parameters in clinical trial with clomiphene citrate of oligospermic men. *J Urol* 133:221–222
- Ng EH, So WS, Gao J, Wong YY, Ho PC (2008) The role of acupuncture in the management of subfertility. *Fertil Steril* 90:1–13
- Paradisi R, Busacchi P, Seracchioli R, Porcu E, Venturoli S (2006) Effects of high doses of recombinant human follicle-stimulating hormone in the treatment of male factor infertility: Results of a pilot study. *Fertil Steril* 86:728–731
- Patel SR, Sigman M (2008) Antioxidant therapy in male infertility. *Urol Clin North Am* 35:319–330
- Pusch H (1989) Oral treatment of oligozoospermia with testosterone-undecanoate: Results of a double blind study. *Arch Androl* 2:479–486
- Reyes-Fuentes A, Chavarria ME, Carrera A, Aguilera G, Rosado A, Samojlik E, Iranmanesh A, Veldhuis JD (1996) Alterations in pulsatile luteinizing hormone and follicle-stimulating hormone secretion in idiopathic oligoasthenospermic men:

- Assessment by deconvolution analysis – a clinical research center study. *J Clin Endocrinol Metab* 81:524–529
- Rolf C, Behre HM, Nieschlag E (1996) Tamoxifen bei männlicher Infertilität. Analyse einer fragwürdigen Therapie. *Dtsch med Wschr* 121:33–39
- Rolf C, Cooper TG, Yeung CH, Nieschlag E (1999) Antioxidant treatment of patients with asthenozoospermia or moderate oligoasthenozoospermia with high-dose vitamin C and vitamin E: A randomized, placebo-controlled, double-blind study. *Hum Reprod* 14:1028–1033
- Ronnberg, L (1980) The effect of clomiphene citrate on different sperm parameters and serum hormone levels in preselected infertile men: A controlled double-blind cross-over study. *Int J Androl* 3:479–486
- Shen M-R, Chiang P-H, Yang R-C, Hong C-Y, Chen S-S (1991) Pentoxifylline stimulates human sperm motility both in vitro and after oral therapy. *Br J Clin Pharmacol* 31:711–714
- SIG Scottish Infertility Group (1984) Randomized trial of mesterolone versus vitamin C for male infertility. *Br J Urol* 56:740–744
- Sigman M, Glass S, Campagnone J, Pryor JL (2006) Carnitine for the treatment of idiopathic asthenospermia: A randomized, double-blind, placebo-controlled trial. *Fertil Steril* 85:1409–1414
- Sokol RZ, Steiner BS, Bustillo M, Petersen G, Swerdloff RS (1988) A controlled comparison of the efficacy of clomiphene citrate in male infertility. *Fertil Steril* 49:865–870
- Suleiman SA, Ali M, Zaki ZME, el-Malik EM, Nasir MA (1996) Lipid peroxidation and human sperm motility: Protective role of vitamin E. *J Androl* 17:530–537
- Török L (1985) Treatment of oligozoospermia with tamoxifen (open and controlled studies). *Andrologia* 17:497–501
- Tournaye H, Devroey P, Camus M, Van der Linden M, Janssens R, Van Steirteghem A (1995) Use of pentoxifylline in assisted reproductive technology. *Hum Reprod* 10(Suppl. 1):72–79
- Tremellen K (2008) Oxidative stress and male infertility – a clinical perspective. *Hum Reprod Update* 14:243–258
- Vandekerckhove P, Lilford R, Hughes E (1998) The medical treatment of idiopathic oligo/asthenospermia: anti-oestrogens (clomiphene or tamoxifen) versus placebo or no treatment. In: Lilford R, Hughes E, Vandekerckhove P (eds) *Subfertility Module of the Cochrane Database of Systematic Reviews*. Cochrane Library. The Cochrane Collaboration, Issue 2. Update Software, Oxford
- Vandekerckhove P, Lilford R, Vail A, Hughes E (2000a) Kinin enhancing drugs for unexplained subinfertility. The Cochrane Collaboration, *Database Syst Rev* 2000 CD 153
- Vandekerckhove P, Lilford R, Vail A, Hughes E (2000b) Bromocriptine for idiopathic oligo/asthenospermia. *Cochrane Database Syst Rev* CD 152
- Vandekerckhove P, Lilford R, Vail A, Hughes E (2007) Clomiphene or tamoxifen for idiopathic oligo/asthenospermia. *Cochrane Database Syst Rev* CD 151
- Wagner ROF, Warsch F (1984) Pulsatile LHRH therapy of “slow pulsing oligospermia”: Indirect evidence for a hypothalamic origin of the disorder. *Acta Endocrinol (Copenh)* 105(Suppl 264):142–145
- Walch K, Eder R, Schindler A, Feichtinger W (2001) The effect of single-dose oxytocin application on time to ejaculation and seminal parameters in men. *J Assist Reprod Genet* 18:655–659
- Wang C, Chan CW, Wong KK, Yeung KK (1983) Comparison of the effectiveness of placebo, clomiphene citrate, mesterolone, pentoxifylline and testosterone rebound therapy for the treatment of idiopathic oligospermia. *Fertil Steril* 40:358–365
- WHO Task Force on the Diagnosis and Treatment of Infertility (1989) Mesterolone and idiopathic male infertility: A double-blind study. *Int J Androl* 12:254–264
- WHO Task Force on the Prevention and Management of Infertility (1992) A double-blind trial of clomiphene citrate for the treatment of idiopathic male infertility. *Int J Androl* 15:299–307
- Yamamoto M, Hibi H, Miyake K (1995) Comparison of the effectiveness of placebo and α -blocker therapy for treatment of idiopathic oligozoospermia. *Fertil Steril* 63:396–340
- Yamamoto M, Katsuno S, Hibi H, Miyake K (1996) The lack of effectiveness of kallikrein in the treatment of idiopathic oligozoospermia: A double-blind, randomized, placebo-controlled study. *Jap J Fertil Steril* 41:1–6
- Yeung CH, De Geyter C, De Geyter M, Nieschlag E (1996) Production of reactive oxygen species by and hydrogen peroxide scavenging activity of spermatozoa in an IVF program. *J Assist Reprod Genet* 13:495–500

Christian De Geyter, Maria De Geyter,
and Hermann M. Behre

Contents

23.1	Assisted Reproduction as a Treatment of Infertility	470
23.2	Methods of Assisted reproduction Available for Treatment of Male Infertility	470
23.3	Insemination	471
23.3.1	Spontaneous Conception Rate in the Infertile Couple	471
23.3.2	Intravaginal and Intracervical Insemination (ICI)	471
23.3.3	Intrauterine Insemination (IUI).....	472
23.3.4	Intratubal Insemination (ITI)	473
23.3.5	Direct Intraperitoneal Insemination (DIPI)	473
23.3.6	Intrafollicular Insemination	473
23.4	In vitro Fertilization and Related Techniques	474
23.4.1	In vitro Fertilization (IVF).....	474
23.4.2	Gamete Intra-Fallopian Transfer (GIFT)	476
23.4.3	Intra-Fallopian Transfer of Zygotes (ZIFT) or Pronucleate-Stage Oocyte Transfer (PROST).....	477
23.4.4	Tubal Embryo Transfer (TET)	477
23.5	Micro-assisted Fertilization	477
23.5.1	Previously Used Techniques of Micro-assisted Fertilization	478
23.5.2	Intracytoplasmic Sperm Injection (ICSI).....	478
23.6	Semen Donation	482
23.7	Collection and Preparation of Sperm for Assisted Reproduction	483
23.7.1	Collection of Semen for Assisted Reproduction.....	483
23.7.2	Preparation of Sperm for Assisted Reproduction.....	485
23.7.3	Filtration	485
23.7.4	Swim-up.....	485
23.7.5	Density Gradient Centrifugation.....	486
23.7.6	Sorting of Spermatozoa Based on Defined Characteristics	487
23.7.7	Removal of Contaminant Infectious Particles.....	487
23.7.8	Processing of Sperm for ICSI in Difficult Cases.....	488
23.7.9	Treatment of Spermatozoa In vitro	488
23.8	Ovarian Follicular Development, Ovarian Stimulation, Ovulation Induction and Oocyte Collection	488
23.8.1	Monitoring of Ovarian Follicular Development and Ovarian Stimulation for Insemination	488
23.8.2	Ovarian Stimulation for IVF and ICSI.....	489
23.9	Methods of Oocyte Collection	490
23.10	Assisted Hatching	491
23.11	Embryo Transfer	492
23.12	Cryopreservation of Oocytes in the Pronucleate Stage	492
23.13	Complications of Assisted Reproduction	493
23.13.1	Ovarian Hyperstimulation Syndrome (OHSS)	493
23.13.2	Ovarian Torsion.....	494
23.13.3	The Risk of Multiple Pregnancies	494
23.13.4	Cancer Risk in the Mother After Assisted Reproduction.....	494
23.14	Genetic Counselling in Assisted Reproduction	495
23.15	Health of the Offspring After Assisted Fertilization	496
	References	497

Ch. De Geyter (✉)
Universitätsspital Basel, Spitalstr. 21,
CH-4031 Basel, Switzerland
e-mail: cdegeyter@uhbs.ch

23.1 Assisted Reproduction as a Treatment of Infertility

Ideally, medicine should deal with the childlessness of each infertile couple in two subsequent steps. First, all factors interfering with natural conception should be identified (see Chap. 20). Secondly, the targeted treatment of each factor contributing to the infertility should be identified and initiated. Unfortunately, neither in gynecology nor in andrology can many of the identified causes of infertility be overcome by a targeted treatment, so that instead a number of **therapeutic strategies** have been developed to deal with childlessness exclusively as a **symptom** without removing the cause of infertility itself. Most of these strategies can be summarized by the term “**assisted reproduction**”. The major disadvantage of any form of assisted reproduction is its short-term efficacy, because the therapeutic effect of assisted reproduction is active only during the treatment cycle itself. If this treatment cycle proves to be unsuccessful or if infertility recurs after delivery of a healthy baby, the entire treatment must be repeated.

Notwithstanding this major disadvantage, today the majority of infertile couples can be treated with one of

the many techniques of assisted reproduction currently available. Nowadays, virtually all cases of male infertility can be potentially treated by some method of assisted fertilization. The broad array of treatment options together with an increasing demand due to the present-day demographic trend towards delaying the time of childbirth later in life has caused an impressive uprise in the number of treatments with assisted reproduction in Europe and elsewhere (Fig. 23.1). A significant proportion of newborns – varying between 1.5% and 4.5% in various countries – now originate from assisted reproduction.

23.2 Methods of Assisted Reproduction Available for Treatment of Male Infertility

Assisted reproduction comprises various treatment modalities, which can be differentiated by more or less stringent control over the processes of fertilization and by the degree of invasiveness. For the purpose of this chapter the various forms of assisted reproduction are subdivided into four major groups:

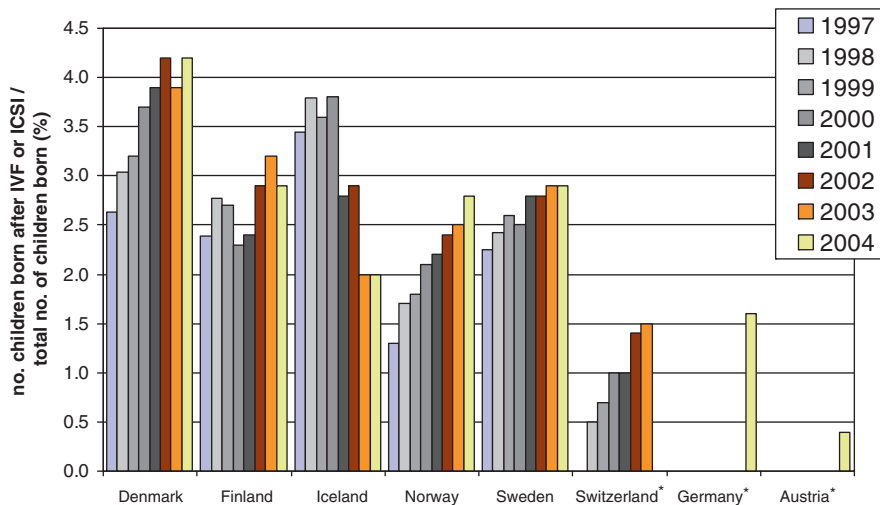

Fig. 23.1 The use of assisted reproduction in various countries in Europe, in which all treatments with IVF and ICSI were registered. The number of births of neonates conceived with assisted reproduction is set in relation to the overall births of neonates (in %). Over the years a steady increase in the relative number of

newborns conceived with IVF or ICSI is noted in most countries (Nygren et al. 2001a and b; Andersen et al. 2005, 2006). *Whereas in Switzerland in 2004 only incomplete delivery data were available, Germany and Austria were able to provide complete delivery data only in 2004 (Andersen et al. 2008)

- **Insemination** denotes a group of techniques in which the sperm are transferred into the female partner by various methods. Insemination aims at increasing the concentration of fertile spermatozoa in the vicinity of the oocyte within the Fallopian tube around the time of ovulation.
- In **in vitro fertilization (IVF)** fertilization does not take place in the Fallopian tube of the female partner. Before ovulation the oocyte is removed from the mature follicle and cultured in an artificial environment in which fertilization and early embryonic development can take place. With this technology variable numbers of motile spermatozoa can be added to selected oocytes, observation of the result of fertilization, selection of fertilized oocytes and transfer of a defined number of embryos into the uterine cavity.
- In **intracytoplasmic sperm injection (ICSI)** a single vital spermatozoon is placed into the oocyte by penetrating it, through all its investments, with a micropipette. ICSI enables successful fertilizations not only despite severe abnormalities in motility, morphology and capacitation process of the injected spermatozoa, but also despite functional and anatomical anomalies of the testes, the epididymis and the efferent ducts.
- In **semen donation** spermatozoa from a fertile donor are used in order to substitute the absence of functional gametes in the partner. In theory, all available techniques of assisted fertilization can be used in semen donation. However, the practice of semen donation is usually regulated by country-specific legislation, requiring maximal safety of both the recipient and the offspring through optimal diagnostic screening of the donor and through cryostorage of donated semen before use. Semen donation can be either anonymous or non-anonymous.

23.3 Insemination

23.3.1 Spontaneous Conception Rate in the Infertile Couple

Any treatment of infertility is effective only if its pregnancy rate exceeds the conception rate in the untreated infertile couple. The **spontaneous conception** rate is

determined by various factors, the most important being the duration of infertility (Léridon and Spira 1984). It is during the first three ovulatory cycles after inception of unprotected sexual intercourse that the highest conception rates per cycle are observed: 20–25% (Spira 1986; Hull 1992). In subsequent cycles the rate of naturally occurring pregnancies steadily decreases, so that after 12 months the pregnancy rate may vary between 0.75% and 3.97% per cycle (Crosignani et al. 1991).

Prognostically favorable findings in the patient's history are previous intact pregnancies with the same partner, the age of the female partner and the duration of infertility (Collins et al. 1983). Conversely, endometriosis, tubal factors and male infertility all are prognostically unfavorable for future childbearing (Collins et al. 1995). Although the parameters of **conventional semen analysis** bear hardly any relationship to the physiology of sperm capacitation and fertilization and despite the limited number of studies, they are correlated with the likelihood of natural conception and can therefore be used to delineate male infertility to some extent. The probability of natural conception is severely reduced in the presence of reduced ejaculate volume (Bostofte et al. 1982), a low percentage of normal sperm morphology (Ombelet et al. 1997; Bonde et al. 1998), reduced concentration of sperm in the seminal plasma (Bostofte et al. 1982; Ombelet et al. 1997; Bonde et al. 1998) and in the presence of high numbers of immotile spermatozoa (Bostofte et al. 1983). Another factor determining the degree of infertility and the efficacy of assisted reproduction is the combination of multiple infertility factors in both partners. For example, the therapeutic efficacy of heterologous insemination in male infertility is higher in male patients suffering from azoospermia than in patients with only abnormal semen quality (Emperaire et al. 1982). This difference can only be explained by differences in the **fertility status of the female partner**.

Natural conceptions in previously infertile couples are commonly observed, particularly when the diagnostic and therapeutic interventions are of prolonged duration.

23.3.2 Intravaginal and Intracervical Insemination (ICI)

This form of assisted fertilization represents the earliest method of insemination. With these techniques

some anatomical barriers in the vagina and in the cervix of the female partner (cervical infertility) and disturbances of sperm deposition in the male partner (hypospadias, retrograde ejaculation, impotentia coeundi) can be overcome.

During intravaginal or **intracervical insemination** 1–2 ml of freshly collected or cryopreserved and thawed semen is deposited in the vagina or in the cervical canal by the use of a catheter connected to a syringe. Besides the liquefaction of the semen, which occurs spontaneously after 30 min of incubation at room temperature, no particular manipulation or preparation of the semen is necessary, so that this treatment does not require any laboratory equipment. Special care should be taken not to introduce any semen into the uterine cavity, because the prostaglandins contained in the seminal plasma may cause painful contractions of the myometrium. To prevent contact of the semen with the vaginal milieu, which owing to its acidity is hostile to sperm, the semen sample can be separated from the vagina with a cap fitted on the portio of the cervix immediately after the cervical insemination. After about 6 h this cap can be removed by the patient herself.

In recent times intravaginal and intracervical inseminations have been replaced largely by intrauterine insemination (IUI) because of the higher efficacy of the latter. In several controlled studies, the therapeutic efficacy of IUI was compared with intracervical and intravaginal insemination and the former was found to be significantly superior in prospective studies using frozen/thawed donor semen. The latter was used to reduce the number of variables possibly influencing the results of the comparison (Cruz et al. 1986; Byrd et al. 1990; Patton et al. 1992; Hurd et al. 1993; Williams et al. 1995; Fig. 23.2). With intrauterine insemination higher sperm numbers can be brought into the uterine cavity and into the Fallopian tubes (Ripps et al. 1994).

23.3.3 Intrauterine Insemination (IUI)

In intrauterine insemination 0.2–0.5 ml of a washed sperm sample is introduced with a fine catheter connected to a syringe into the uterine cavity of a periovulatory patient. The aim of this technique is to achieve a higher concentration of motile spermatozoa within the lumen of the Fallopian tube in order to increase the

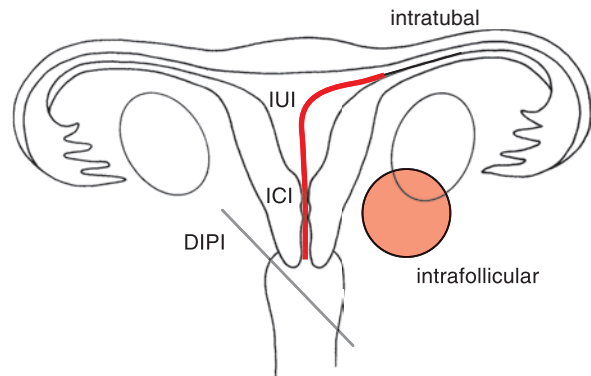

Fig. 23.2 Graphic presentation of the different techniques of insemination: intracervical (ICI), intrauterine (IUI), intratubal, direct intraperitoneal (DIPI), intrafollicular

probability of fertilization. One particular modification of intrauterine insemination involves the **perfusion** of a larger volume of a prepared sperm sample (4 ml) over a period of 4 min into the uterine cavity, to ensure the attachment of a larger number of spermatozoa to the mucosa of the Fallopian tube (Kahn et al. 1993). Later prospective studies and a single meta-analysis showed higher pregnancy rates in couples with unexplained infertility only (Trout and Kemmann 1999). As Fallopian tube perfusion combines both closure of the cervix either with a clamp or with an inflated balloon and the flushing of the Fallopian tubes with a significant volume, the initial higher pregnancy rates achieved with the perfusion method in some studies may also be explained by the flushing of debris out of the tubal lumen.

Apart from being less invasive and costly than IVF or ICSI, the therapeutic efficacy of IUI as an isolated procedure has been questioned recently (Fig. 23.3). Although IUI is frequently used as a first-line therapy in male infertility, insufficient data have been collected to substantiate the efficacy of IUI as an isolated method as compared with timed intercourse (Bensdorp et al. 2007). On the other hand, when comparing with IVF, the cost effectiveness of IUI may be considered beneficial, particularly if the cumulative pregnancy rate of up to six treatment trials are taken in account (Goverde et al. 2000). Therefore, it is important to explain to the patients that IUI must not be considered as one single treatment, but rather as a series of successive trials. Although in cases with male immunological infertility IUI has been officially approved in many countries, the pregnancy rates have been found to be low (Francavilla et al. 1992).

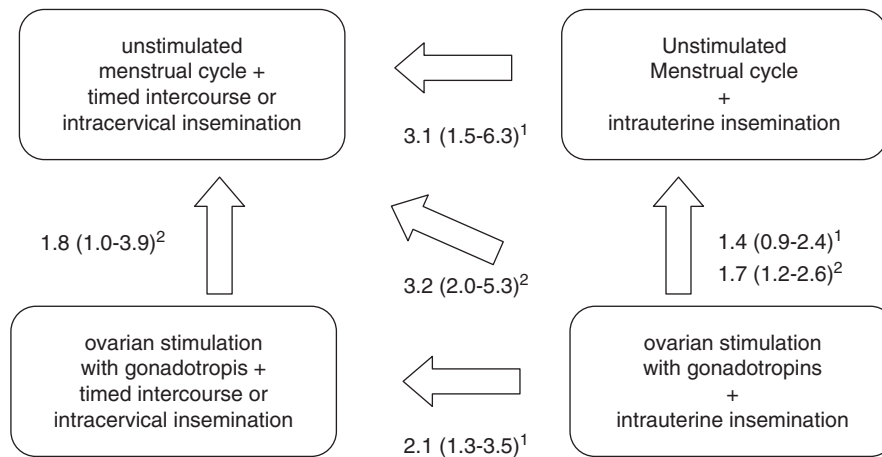

Fig. 23.3 Odds ratio and the corresponding 95% confidence intervals of the pregnancy rates after IUI as compared to natural conception at the predicted moment of ovulation (metaanalysis by Cohlen et al. 2004 [1]) or compared with intracervical insemination (Guzick et al. 1999 [2]). In most studies IUI

leads to a better outcome (odds ratio > 1). The best results were consistently achieved after ovarian stimulation with gonadotropins followed by ovulation induction. For the construction of this figure only data dealing with male infertility were included

IUI is performed easily, requires minimal equipment and remains practically **without complications**. Infections after IUI, such as endometritis or pelvic inflammatory disease, are observed extremely rarely.

23.3.4 Intratubal Insemination (ITI)

In several animal species it was shown that, in addition to the cervix, a second sperm reservoir exists in the isthmic part of the Fallopian tube (see also Chap. 3). Based on these findings, the technique of **intratubal insemination** was invented to transfer washed spermatozoa beyond the isthmic portion of the Fallopian tube in order to achieve a higher sperm concentration within the ampulla, where fertilization normally occurs (Jansen and Anderson 1987). However, controlled studies demonstrated that with intratubal insemination the pregnancy rate is no better than with IUI (Oei et al. 1992; Hurd et al. 1993).

23.3.5 Direct Intrauterine Insemination (DIPI)

In **direct intrauterine insemination** the posterior vaginal pouch is punctured with a needle connected to a syringe containing the prepared sperm suspension,

and 0.2–2 ml of this is injected into the peritoneal cavity (Forrler et al. 1986). The spermatozoa can be transported into the lumen of the Fallopian tube by the ciliary movement of the mucosal cells covering the abdominal infundibulum of the oviduct. With DIPI, not only the cervix but also the isthmic part of the Fallopian tube is circumvented, as both are considered to be obstacles for defective spermatozoa.

This method can be applied only to patients with intact Fallopian tubes and was first used predominantly in couples suffering from unexplained and cervical infertility, later also in male infertility. Using controlled randomized settings, the pregnancy rate of direct intrauterine insemination was not better than the pregnancy rate of timed natural intercourse (Campos-Liete et al. 1992) or of IUI (Hovatta et al. 1990). This technique may still be used in women with a severe cervical stenosis which cannot be passed without damage to the endometrium. No induction of antisperm antibodies could be demonstrated as a consequence of this method of insemination.

23.3.6 Intrafollicular Insemination

In **intrafollicular insemination** several mature cumulus-oocyte complexes are recovered by transvaginal ultrasound-guided puncture of all but one preovulatory

ovarian follicle. After selection of the most mature cumulus-oocyte complexes, these are mixed with 0.03–0.5 ml of the previously prepared sperm suspension and are then inserted during the same transvaginal ultrasound-guided puncture into one mature ovarian follicle. The rationale of **intrafollicular insemination** is based on the finding of some factors present in follicular fluid (e.g. progesterone) which may physiologically stimulate both capacitation and the acrosome reaction of spermatozoa. In a prospective cohort study involving 50 couples only one pregnancy could be achieved (Nuojua-Huttonen et al. 1995), so this technique does not seem to be of any benefit compared to other forms of insemination.

23.4 In vitro Fertilization and Related Techniques

23.4.1 In vitro Fertilization (IVF)

The basic hallmark of IVF, distinguishing it from other procedures of assisted fertilization, is that the physiological process of fertilization takes place **outside the body** of the patient in an artificially constructed environment. For this purpose, one or more oocytes are recovered from preovulatory ovarian follicles and subsequently co-incubated in a complex culture medium, designed to mimic the tubal fluidic milieu. Motile spermatozoa are then separated from immotile spermatozoa, non-spermatozoal cells and seminal plasma. Subsequently, a defined number of motile spermatozoa are then co-incubated with an oocyte. After identification of successful fertilization, either at the pronuclear stage, at an earlier cleavage stage or at the later blastocyst stage, the embryos are placed in the uterine cavity for nidation in the endometrium and pregnancy.

IVF was originally introduced for the treatment of tubal infertility caused either by occlusion of the Fallopian tubes or by impairment of their function (Edwards 1981). However, soon after its successful introduction, its potential value for the treatment of male infertility became an issue of intensive debate. In contrast to all existing forms of artificial insemination, IVF offers the possibility of **inseminating the oocytes with a predetermined number of motile sperm**. In addition, as a result of the hormonal stimulation of the

ovaries, more oocytes can be inseminated and possibly fertilized within the frame of one treatment cycle, thereby offering the opportunity to select fertilized oocytes for further embryo culture.

Unfortunately, the early high expectations of conventional IVF for the treatment of severe male infertility were not fulfilled for several reasons. First, the prolonged co-incubation of sperm and oocytes is associated with a significantly reduced pregnancy rate compared with a co-incubation time of 4–5 h (Dirnfeld et al. 1999) and the presence of an excessive concentration of spermatozoa around the oocyte may in some cases compromise the pregnancy rates (Kastrop et al. 1999; Benoff et al. 1999). In observational cohort studies involving couples treated because of male infertility only the success rates of IVF were the lowest of all (Tournaye et al. 1992; Tan et al. 1992) and were not better than the **spontaneous conception rate** during a 6-month waiting period (Soliman et al. 1993).

The advent of ICSI has now replaced conventional IVF in the treatment of severe male infertility. IVF is still used for the treatment of female infertility, such as tubal infertility or unexplained infertility.

Although IVF can be performed with some success in the unstimulated menstrual cycle, it has become widespread practice to carry out this treatment in combination with **hormonal stimulation of the ovaries**, so that **multiple oocytes** become available for IVF. The improved pregnancy rate of IVF after hormonal stimulation of ovarian follicular development results mainly from the selection of several fertilized oocytes and their in vitro culture up to the embryonic stage. Ovarian stimulation also provides a better assessment of the events controlling follicular maturation, in turn leading to the collection of more mature oocytes with high developmental capacity. Furthermore, ovarian stimulation compensates for clinical and subclinical defects in the follicular development of some patients. On the other hand, ovarian hyperstimulation and the transfer of more than one embryo at the time entail a high incidence of multiple pregnancies. Multiple pregnancies, particularly in previously infertile women, are associated with considerable obstetric and neonatal risks, which in turn entail high additional financial costs (Callahan et al. 1994; Schieve 2006). The rapidly increasing number of treatments with assisted reproduction leading to more deliveries of multiples has caused an upsurge in the numbers of prematurely born neonates.

Consequently, there is a multinational trend to replace only one single embryo per cycle selected from a cohort of growing embryos based on morphological assessment. It has been demonstrated that the selection and transfer of a single embryo (often denominated elective SET) can be performed successfully without lowering the overall pregnancy rates (Vilksa et al. 1999; Gerris et al. 1999, 2002; Papanikolaou et al. 2006), even in women older than 35 years (Veleva et al. 2006). In addition, in some countries, such as Sweden, where elective SET was introduced nationwide, the incidence of multiple deliveries was reduced (Karlström and Bergh 2007). Finally, as neonatal birth weight is significantly lower after IVF (De Geyter et al. 2006), for reasons that are still unknown, this difference seems not to be present in neonates originating from single embryo transfer (De Sutter et al. 2006). However, in some countries – among them Germany and Switzerland – the selection of single embryos out of a cohort of several available embryos as a strategy to improve pregnancy rates while preventing multiple

deliveries is prohibited. The legal and ethical discussions about the possibility of surplus embryos have not been solved yet.

ICSI has now replaced conventional IVF for the treatment of couples suffering from idiopathic male infertility.

Whereas the decision to perform ICSI rather than IVF is obvious in severe male infertility, the choice may become difficult in many borderline cases. Although today many treatment units perform ICSI indifferently in all cases (Jain and Gupta 2007), the fertilization rates obtained with IVF have been shown to be similar to those observed after ICSI in couples with normal seminal parameters (Table 23.1). On the other hand, some studies have demonstrated that the frequency of complete failure of fertilization of all oocytes is higher after IVF than after ICSI (Table 23.1). The dilemma of

Table 23.1 Results of various prospective studies performed on couples or on sibling oocytes randomized to either conventional IVF or ICSI. In IVF the fertilization rate (%) refers to all inseminated oocytes, whereas in ICSI to all oocytes retrieved. The failed fertilization (%) denotes those cycles with complete failure of fertilization

Authors	IVF		ICSI		Study design
	Fertilization rate	Failed fertilization	Fertilization rate	Failed fertilization	
Aboulghar et al. (1996)	18	49	60	0	Sibling oocytes, male infertility
Ruiz et al. (1997)	48.1	11.4	52.5	0	Sibling oocytes, unexplained inf.
Moreno et al. (1998)	77.7	33.3	70.2	18.9	Couples, low ovarian response
Pisarska et al. (1999)	52.8	7.9	63.5	2.6	Sibling oocytes, male infertility
Staessen et al. (1999)	60.3	12.5	63.8	3.6	Sibling oocytes, tubal & unexplained inf.
Verheyen et al. (1999)	22.9	50	63.4	0	Sibling oocytes, male infertility
Bukulmez et al. (2000)	64.8	10.5	53.5	2.6	Couples, tubal infertility
Bhattacharya et al. (2001)	58	5	47	2	Couples, non-male infertility
Hershlag et al. (2002)	52	10.9	61.8	0.9	Sibling oocytes, male and unexplained inf.
Van der Westerlaken et al. (2006)	51.3	24.5	50.8	0.9	Sibling oocytes, male infertility

performing conventional IVF or, alternatively, ICSI, still largely relies on **conventional semen analysis**. The **predictive accuracy** of conventional semen analysis for the results of IVF was determined prospectively and reached 77% for the prediction of an inadequate fertilization rate and 95% for the prediction of a sufficient fertilization rate (Duncan et al. 1993). Confronted with the inability to predict the fertilizing capacity of semen with borderline characteristics, some authors advise treating sibling oocytes with IVF and ICSI separately (Van der Westerlaken et al. 2006). However, for this strategy a sufficient number of oocytes is required.

The use of sperm function tests, based on the physiology of capacitation, such as hyperactivated motility using **computer-assisted sperm motion analysis** (De Geyter et al. 1998), and binding of capacitated sperm to the zona pellucida (Mahutte and Arici 2003) have also been evaluated to predict the lack of fertilization. However, none of the available sperm function tests can reliably predict the absence of fertilization ability in IVF.

23.4.2 Gamete Intra-Fallopian Transfer (GIFT)

The culture media used for IVF were originally based on buffered salt solutions conceived for the growth of mouse embryos. Although with time the composition of the culture media became more elaborate, it was originally thought that the tubal environment was better suited for supporting the processes of sperm capacitation, fertilization and early embryonic development. Therefore, the technique of **intra-Fallopian transfer of gametes** (GIFT) was developed as an alternative to both IVF and IUI (Fig. 23.4).

In GIFT, ovarian stimulation is performed using protocols similar to IVF, but mature oocytes are collected by laparoscopy only. Based on the morphological assessment of the cumulus oophorus and the corona radiata or, if possible, by the visualization of the first polar body, two to four mature oocytes are selected and mixed with prepared semen. During the same laparoscopy, these selected cumulus-oocyte complexes are then inserted by a catheter through the abdominal **infundibulum** into the ampulla of one intact Fallopian tube, where fertilization can take place.

Originally, GIFT was developed for the treatment of couples suffering from **unexplained infertility**, but soon it was used in **male infertility** as well. However, in prospective-controlled studies, GIFT did not prove to be more successful than conventional IVF in the treatment of unexplained and male infertility (Leeton et al. 1987; Fig. 23.5). Nowadays, this technique has been largely abandoned and replaced by IVF and ICSI.

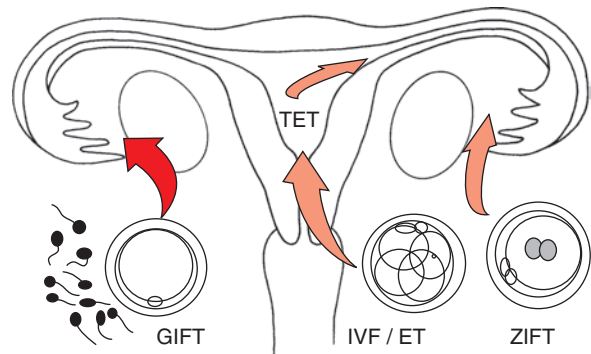

Fig. 23.4 Graphic presentation of the different methods of replacement of gametes or embryos: in vitro fertilization (IVF) and replacement of the embryos into the uterine cavity, gamete intra-Fallopian transfer (GIFT), zygote intra-Fallopian transfer (ZIFT), tubal embryo transfer (TET)

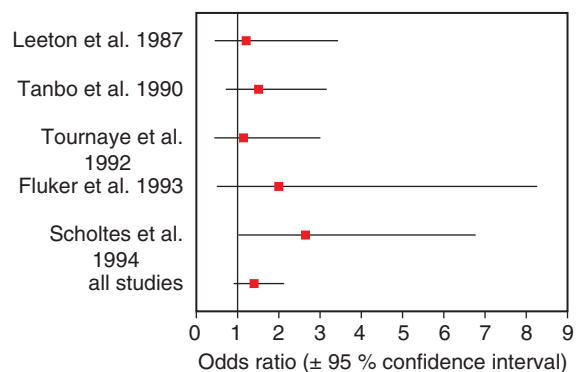

Fig. 23.5 The odds ratio (and the 95% confidence interval, based on the chi-squared test according to Pearson, Mantel and Haenszel) of IVF compared with GIFT, ZIFT and TET was calculated using the data from several prospective studies. In most studies the pregnancy rate of IVF was superior to those of other treatment modalities (odds ratio > 1), especially when the data of all studies are compiled

23.4.3 Intra-Fallopian Transfer of Zygotes (ZIFT) or Pronucleate-Stage Oocyte Transfer (PROST)

In order to combine the advantage of GIFT, permitting early embryonic development within the physiological environment of the Fallopian tube, with the advantage of IVF, in which information about the fertilization process is acquired, **intra-Fallopian transfer of zygotes (ZIFT)** was developed. Simultaneously, and based on the same reasoning as for ZIFT, an analogous method, the transfer of **pronucleate-stage oocytes** into the Fallopian tube (PROST), was introduced into assisted reproduction. In both methods two operations had to be performed on the same patient on two consecutive days. Oocytes are collected by ultrasound-guided vaginal puncture of the preovulatory follicles after ovarian stimulation and are then coincubated overnight with motile spermatozoa. The next morning pronuclei are identified as a sign of successful sperm penetration. Two to three oocytes in the pronucleate stage or zygotes may then be replaced during laparoscopy through the abdominal infundibulum into the lumen of the Fallopian tube.

Although very high pregnancy rates were achieved, the therapeutic advantage of these complex treatments, compared with conventional IVF, could not be proven in prospective settings. Both techniques have now been abandoned.

23.4.4 Tubal Embryo Transfer (TET)

Transvaginal/transuterine transfer of embryos into the Fallopian tube was introduced to reduce the physical burden on the patient caused by ZIFT. Using specially designed flexible catheters, the isthmo-ampullar lumen of the oviduct can be reached via the vagina and the uterine cavity (Jansen and Anderson 1987), avoiding both laparoscopy and general anesthesia. This type of catheterization can be performed as an outpatient procedure in most patients without any need of narcotics or analgesia. However, in a prospective randomized study, this treatment did not result in significantly better pregnancy rates than conventional IVF (Scholtes et al. 1994). The pregnancy rate may be occasionally compromised by damage

of the endometrium caused by difficult catheterization in some patients. This technique has now been abandoned.

23.5 Micro-assisted Fertilization

Among the various methods of micro-assisted fertilization, intracytoplasmic sperm injection was the last to be developed. Its introduction has rapidly revolutionized the treatment of **male infertility**.

Historically, the development of the various methods of micro-assisted fertilization was characterized by the stepwise circumvention of all processes involving sperm capacitation and fertilization (Fig. 23.6). The results achieved by the different methods of micro-assisted fertilization clearly demonstrated that only those techniques in which the physiological sequences of fertilization were most effectively bypassed achieved the highest pregnancy rates.

Micro-assisted fertilization developed out of conventional IVF. Therefore, the various techniques jointly denominated micro-assisted fertilization require hormonal stimulation of the ovaries, the collection of mature oocytes from preovulatory follicles and the replacement of fertilized oocytes into the uterine cavity of the patient. All techniques of micro-assisted fertilization differ from conventional IVF by the necessity of preparing the oocytes from the surrounding cells of the **cumulus oophorus** and of the **corona radiata**

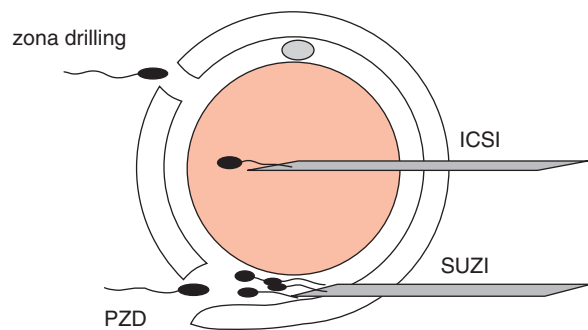

Fig. 23.6 Graphic presentation of the different methods of micro-assisted fertilization: zona drilling, partial zona dissection (PZD), subzonal sperm injection (SUZI), intracytoplasmic sperm injection (ICSI)

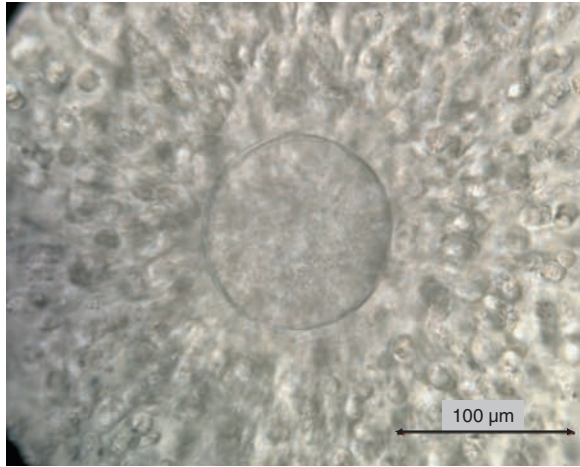

Fig. 23.7 Mature oocyte surrounded by the cells of the corona radiata and of the cumulus oophorus

(Fig. 23.7). This is achieved in part enzymatically with **hyaluronidase**, in part mechanically using a fine bore micropipette. Preparation of the freshly collected oocytes prior to insemination allows better identification of the maturity stage of the oocyte (by visualization of the polar body, metaphase II) and improves the selection of high quality oocytes. The likelihood of successful fertilization and pregnancy are impaired by the following dysmorphic characteristics of the oocyte: broad perivitelline space, inhomogeneous texture of the egg's cytoplasm and abnormal structures in the perivitelline space.

23.5.1 Previously Used Techniques of Micro-assisted Fertilization

The earliest technique of micro-assisted fertilization, **zona drilling**, was originally developed because the **zona pellucida** was at that time considered the most difficult obstacle to successful fertilization in patients with abnormal sperm quality. Fertilization was facilitated by boring a small hole into the zona pellucida. After insemination of these pretreated oocytes with high concentrations of motile spermatozoa, individual spermatozoa were able to slip through the hole, to complete the acrosome reaction in the perivitelline space and to fuse with the membrane of the oocyte.

Various techniques of boring a hole in the zona pellucida of human oocytes were developed, such as

the application of an acid solution to the zona pellucida with a micropipette or the use of a laser beam. Although higher fertilization rates were achieved than with conventional IVF, the pregnancy rate with zona drilling remained extremely low. The technique used was later adopted for improvement of the implantation rate by opening the zona pellucida prior to embryo replacement: “**assisted hatching**” (see Sect. 23.10).

In order to enhance further the penetration of motile spermatozoa into the perivitelline area, larger openings in the zona pellucida than those made in zona drilling were produced by the **partial dissection of the zona pellucida** (PZD) from the vitelline membrane. This is achieved by first slightly aspirating the oocyte onto a holding pipette. Then the zona is punctured tangentially with a microneedle. By removing the microneedle at a right angle to the oocyte, the zona is torn and dissected from the membrane of the oocyte.

In **subzonal sperm injection** (SUZI) one or more motile spermatozoa are inserted with a micropipette into the perivitelline space between the zona pellucida and the membrane of the oocyte. Until the development of ICSI the subzonal injection of multiple spermatozoa was regarded as the most effective method of micro-assisted sperm injection in severe male infertility. In patients suffering from abnormal sperm quality not only the binding of capacitated sperm to the zona pellucida is hampered, but also the acrosome reaction and fusion with the vitelline membrane of the oocyte are disturbed. Thus, subzonal sperm injection was more successful when several motile spermatozoa were injected into the perivitelline space. Experience with the subzonal injection of several motile spermatozoa demonstrated that in the human system not only the zona pellucida, but also the vitelline membrane utilizes a protective mechanism against the penetration of excess spermatozoa, so that the rate of polyspermy remains low. Nowadays, this technique has been completely replaced by ICSI.

23.5.2 Intracytoplasmic Sperm Injection (ICSI)

The first report of a pregnancy with ICSI (Palermo et al. 1992) was soon followed by the application of

Fig. 23.8 Injection of one motile spermatozoon into the cytoplasm of an oocyte (ICSI). **a:** The spermatozoon is captured by the injection micropipette, which is then directed to the oocyte fixed on a holding pipette. **b:** Penetration of the zona pellucida. **c:** Penetration of the vitelline membrane of the oocyte. **d:** Aspiration of some cytoplasm into the injection pipette before the spermatozoon is transmitted into the oocyte

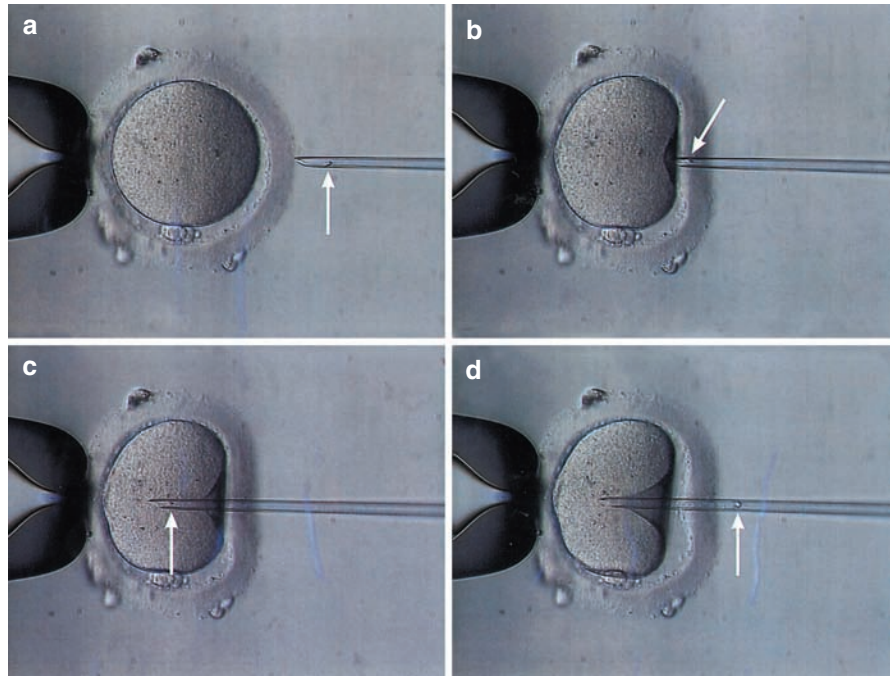

this technique in routine assisted reproduction worldwide, clearly demonstrating the high therapeutic efficacy of ICSI in the treatment of couples suffering from **severe male infertility**.

In this procedure a single vital spermatozoon is inserted with a micropipette both through the zona pellucida and the vitelline membrane into the cytoplasm of a mature oocyte.

For ICSI the spermatozoon is first immobilized mechanically and then aspirated with its head towards the tip of the micropipette. The vitality of sperm is usually identified by observation of its movement. Some selection of the better spermatozoon can be performed based on morphology and progressive motility, but not on genotypic properties.

The oocyte is aspirated onto the tip of a holding pipette and will be held fixed in a position, in which the polar body is visible at its upper or lower pole. As such, damage of the meiotic spindle is thought to be avoided during the microinjection, because the latter usually resides close to the polar body (Fig. 23.8). During the injection process first the zona pellucida and then the vitelline membrane are penetrated subsequently with a beveled micropipette holding a single spermatozoon. To

ascertain the rupture of the oocyte's membrane prior to placement of the spermatozoon into the cytoplasm and to activate the oocyte, the vitelline membrane together with some cytoplasm is aspirated into the micropipette. After withdrawal of the micropipette the vitelline membrane closes rapidly and no trace of the process is seen within minutes after the procedure.

To facilitate drawing of the sometimes highly motile spermatozoa into the micropipette, the prepared spermatozoa may be incubated in culture medium supplemented with the macromolecule **polyvinylpyrrolidone (PVP)**. Owing to the viscosity of the medium, the velocity of the capacitating sperm becomes lower. Individual spermatozoa are immobilized by touching them with the micropipette, thereby opening their membrane. The oocyte can only be activated if one or more cytoplasmic factors are liberated from the spermatozoon's equatorial segment into the injected oocyte. Indeed, whereas in older forms of micro-assisted fertilization non-fertilization mainly resulted from non-penetration of spermatozoa, failure of fertilization in ICSI seems to be caused chiefly by lack of activation of the oocyte despite successful injection of a spermatozoon into the cytoplasm (Flaherty et al. 1998).

One of the most important requirements for successful fertilization in ICSI is the meiotic status of the oocyte, e.g. metaphase II. Before ICSI the oocytes

have to be freed of the surrounding cells of the corona radiata and the cumulus oophorus using enzymatic digestion with hyaluronidase and mechanical means. This denudation of the oocytes allows assessment of the maturity status of the oocyte. Maturity is defined as the metaphase II stage of meiosis. At the metaphase II stage of meiosis the oocyte's chromosomes have become arranged at the metaphase plate at the equatorial plane of the oocyte. The chromosomes are firmly attached to the meiotic spindle. In light microscopy this stage is identified by the observation of the first extruded polar body, which then resides between the vitelline membrane and the zona pellucida (Fig. 23.9). The timing between denudation of the freshly collected oocytes and their injection does not affect their developmental potential (Van de Velde et al. 1998). Under normal conditions approximately 85% of all oocytes collected after ovarian hyperstimulation and ovulation induction are at the metaphase II stage and can be used for ICSI.

Metaphase I oocytes are identified by light microscopy by the absence of an extruded polar body (Fig. 23.9). A significant number of oocytes, approximately 12%, are still in the metaphase I stage at the moment of

collection (De Vos et al. 1999; Balakier et al. 2004). In many of the metaphase I oocytes the first polar body will become extruded during incubation in-vitro and can be used subsequently for ICSI. However, the fertilization of those oocytes matured in-vitro is significantly lower and both the quality of embryo development and their implantation rates have been demonstrated to be lower (De Vos et al. 1999). Increasing the delay between polar body extrusion and ICSI to at least 4 h allows completion of nuclear maturation and improves the outcome (Balakier et al. 2004; Hyun et al. 2007). In many cases extending interval between the administration of hCG and the collection of the oocytes from the conventional 35 h to 39 to 40 h may be beneficial to reduce the number of immature oocytes (Raziel et al. 2006).

After intracytoplasmic sperm injection the exact timing of the various steps of fertilization has been determined (Payne et al. 1997):

- Extrusion of the second polar body after approximately 2.5 h
- Appearance of the female pronucleus after approximately 5 h

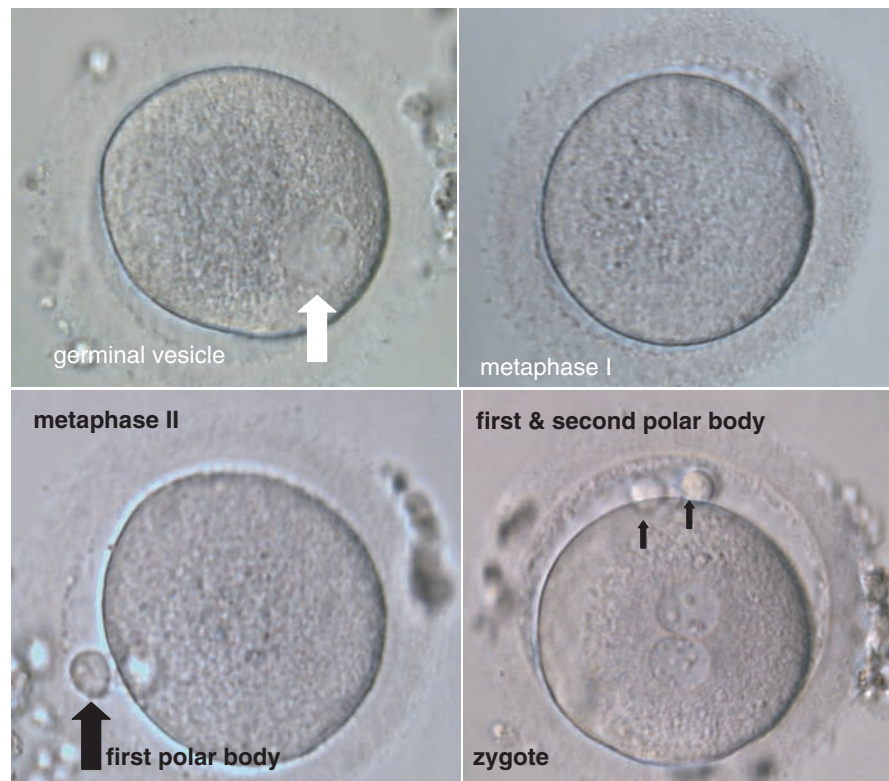

Fig. 23.9 Using an inverted microscope the maturity of oocytes can be identified together with their activation during fertilization

- Appearance of the male pronucleus a few minutes later
- Collateral approximation of both pronuclei after approximately 7h

The probability of activation and further development of the injected oocyte depends on its quality, which can be partially estimated by assessing its morphology. Other important factors in the success rate of ICSI are the experience of the embryologist involved. Approximately 10% of all injected oocytes become atretic after the procedure (Nagy et al. 1995). It must be assumed that the meiotic spindle is not located in the vicinity of the polar body in approximately 20% of all oocytes (Konc et al. 2004) and that in some oocytes it may be damaged during the intracytoplasmic injection (Hewitson et al. 1999). Although the meiotic spindle can potentially be visualized using computerized imaging analysis, this technique has not yet been shown to be beneficial.

In 2.5–6.5% of all injections the oocyte fails to become activated, thereby not extruding the second polar body, leading to digynic triploidy (Sultan et al. 1995; Grossmann et al. 1997; Flaherty et al. 1998). A triploidic embryo cannot lead to a healthy pregnancy and should not be transferred to the recipient's uterus.

Intracytoplasmic sperm injection by far exceeds all other forms of micro-assisted fertilization in the limited number of motile sperm needed for successful fertilization and in the apparent absence of any correlation between sperm (dys)function and the fertilization rate.

The high efficacy of ICSI has widely extended the spectrum of treatable abnormalities in male fertility. The success rate of ICSI in male infertile couples is not limited by conventional semen characteristics such as concentration, progressive motility or percentage normal morphology, nor by the degree of physiological maturation in the testis and the epididymis, nor by the exhibition of capacitation by the spermatozoa. Even the presence of motion in spermatozoa as a sign of vitality is not required for the success of ICSI, as in patients with complete absence of sperm motility, vitality can be demonstrated either by the swelling of sperm in a hypotonic solution or by treating previously immobile spermatozoa with pentoxifyllin.

ICSI has been applied successfully in a high diversity of conditions with abnormal sperm function:

- Severe forms of idiopathic male infertility in which capacitation and fertilization are highly unlikely to occur: such as severe **hypergonadotropic oligoasthenoteratozoospermia**, in which only few motile spermatozoa can be recovered from the ejaculate.
- Organic causes of male infertility in which the absence or loss of function of various anatomic parts of the male genital tract causes infertility: **obstructive azoospermia** with sperm recovered from the epididymis or from a testicular biopsy.
- In men suffering from severe infertility and hypergonadotropic azoospermia, spermatozoa can be recovered from testicular tissue. Usually more than one biopsy is needed in order to retrieve a sufficient number of spermatozoa.
- The presence of anti-sperm antibodies in male immunological infertility is an indication for ICSI, particularly if those antibodies are bound to the surface of the spermatozoa's head (Lombardi et al. 2001).
- Rare and sporadic forms of male infertility which are probably caused by mutations, such as **globozoospermia** (Lundin et al. 1994; Bourne et al. 1995; Liu et al. 1995; Catt et al. 1996; Battaglia et al. 1997; Rybouchkin et al. 1997; Tejera et al. 2008, Fig. 23.10) and total sperm immotility (Nijs et al. 1996; Casper et al. 1996; Liu et al. 1997; Kahraman et al. 1997; Peeraer 2004). In these rare occasions the fertilization rate after ICSI seemed to be lower than the usual, which varies between 60–70%. In men with complete immobile spermatozoa, such as

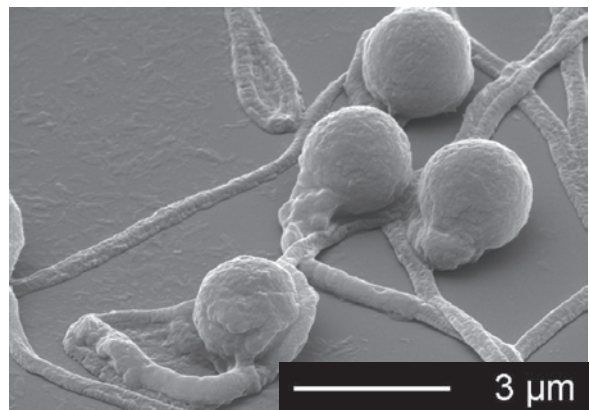

Fig. 23.10 Electron microscopic image of globozoospermia

in the Karthagener syndrome the vitality of the spermatozoa can be identified by using the swelling test (Casper et al. 1995; Liu et al. 1995; Peeraer 2004). With this method the intactness of the membrane of a spermatozoon is used to determine its vitality.

ICSI can be performed successfully with **frozen-thawed** spermatozoa from tumor patients in whom sperm quality was often already impaired in the original ejaculate and who could not be treated successfully with earlier treatment modalities. It must however be noted that spermatogenesis may recur, as spermatozoa could be recovered from the semen of as many as 28% of men who previously underwent high-dose chemotherapy followed by bone marrow transplantation (Rovó et al. 2006).

Because in contrast to conventional IVF, no spermatozoa are bound to the zona pellucida in oocytes treated with ICSI, the latter method is commonly used in preimplantation genetic diagnosis (PGD) or in polar body biopsy in order to avoid any interference of the DNA of residual spermatozoa with the diagnostic process.

Intracytoplasmic sperm injection as a treatment for male infertility reaches its limitation in at least four different clinical entities:

- Significantly lower fertilization and implantation rates were reported in couples treated because of hypergonadotropic azoospermia and in whom sperm has to be retrieved from testicular tissue (Tournaye 1999). Although the role of the maternal genome is by far more important for subsequent embryonic development, the paternal genome also plays a role, particularly after some cleavage stages of embryonic development. Particularly in cases of severely reduced semen quality, embryonic development appears to be disturbed (Sakkas et al. 2004), possibly because of apoptosis in the spermatozoa with DNA damage (Irvine et al. 2000).
- In some cases of globozoospermia surprisingly low fertilization rates were reported (Liu et al. 1995; Battaglia et al. 1997). The low fertilization rates in globozoospermia are caused by failure of oocyte activation (Rybouchkin et al. 1997) and can be overcome by artificial activation of the oocyte (Rybouchkin et al. 1997; Tejera et al. 2008).
- In necrozoospermia, in which all seminal spermatozoa have lost their vitality because of some degenerative

process or in semen samples displaying much apoptosis leading to DNA damage, ICSI is not successful with ejaculated spermatozoa (Tournaye et al. 1996; Greco et al. 2005). However, the collection of spermatozoa from the testicular tissue (TESE) may be helpful under these circumstances.

- Successful pregnancies after ICSI with round spermatids collected from testicular tissue biopsies have been reported by few authors (Tesarik and Mendosa 1996; Antinori et al. 1997), but not by others (Levrán et al. 2000; Urman et al. 2002). Because of the risk of incomplete or abnormal genomic imprinting of the male gamete, the risk of this method to the offspring can at present not be predicted (Urman et al. 2002).

Whereas in most spermatological situations ICSI presents as a highly effective method to induce successful fertilizations, the probability of pregnancy largely depends on factors determined by the female partner.

The overall results of ICSI are mainly influenced by the age of the female partner (Abdelmassih et al. 1996), by the ovarian response to the hormonal stimulation and by the quality of the oocytes. Although the oocytes can indeed be successfully penetrated with ICSI, many oocytes do not become activated (Flaherty et al. 1998). The probability of pregnancy remains dependent on the quality of the replaced embryos and on the hormonal environment in the recipient. Therefore, if the desired pregnancy does not occur despite successful fertilization induced by ICSI, the female partner, already carrying most of the therapeutic burden, might easily be placed in the position of being blamed for the failure of treatment.

23.6 Semen Donation

In semen donation spermatozoa from a fertile donor instead of spermatozoa collected from the infertile partner are used in order to achieve a pregnancy. Although the widespread use of semen donation in earlier decades has been largely supplanted by ICSI

(Katzorke 2008), semen donation may still be used in various clinical conditions:

- The male partner has no spermatozoa in his ejaculate nor in the biopsies taken from his testicles.
- Because of a malignant disease, which was treated successfully with chemotherapeutics and/or irradiation or bilateral orchidectomy. Semen donation is used in those cases only when no spermatozoa had been stored frozen for fertility preservation.
- The male partner suffers from a genetic condition which carries a high risk of transmission to his offspring, thereby jeopardizing the health of his potential children.

In many countries the selection of fertile semen donors is regulated by law and often the prerequisites of this selection is similar to those used for organ donation in transplantation surgery (Katzorke 2008). Apart from fertility, the absence of transmittable viruses, such as hepatitis B, hepatitis C and HIV must be assured, but also the absence of genetic disease, such as structural chromosomal abnormalities, mutations of the CFTR gene and others. In order to fulfil these criteria, semen samples of selected donors are now stored frozen, which has contributed to a significant reduction of present-day efficacy of semen donation for IUI (Botchan et al. 2001). The success rates per cycle are much lower than ICSI and vary between 7% and 16%. Therefore, in many institutions, instead of IUI with donated semen, assisted reproduction is being performed using donated frozen/thawed spermatozoa in order to achieve higher pregnancy rates. However, in some countries only IUI, but not IVF or ICSI is permitted with donated semen.

Furthermore, in many countries, the number of children to be produced by one single semen donor is restricted. The number of children after semen donation from one donor is limited to 5 in France, to 8 in Switzerland, Belgium and in the U.S., to 10 in the UK and in Austria and to 25 in the Netherlands (Sawyer and McDonald 2008).

Although most semen donations worldwide remain anonymous, there is a trend towards non-anonymous semen donations, because the children's right to know their biological roots has been acknowledged in various countries, such as Sweden, Norway, Austria, the United Kingdom, The Netherlands, Switzerland, Australia and New Zealand (Daniels 2007). In countries with non-anonymous semen donation young

adults arising from semen donation can enquire about the identity of the donor through official instances. The introduction of non-anonymity has led to fewer men willing to donate their semen, although local legislation protects both the donors and the offspring from financial litigation.

23.7 Collection and Preparation of Sperm for Assisted Reproduction

23.7.1 Collection of Semen for Assisted Reproduction

Usually, semen can be collected for assisted fertilization by masturbation after a **period of abstinence** of 2–7 days, as recommended by the World Health Organization (WHO 1999, see also Chap. 9). In patients with few spermatozoa the number of spermatozoa collected can be increased by prolonging the period of abstinence and/or by the production of more than one ejaculate prior to semen preparation (Tur-Kaspa et al. 1990; Cooper et al. 1993; De Jonge et al. 2004).

Sometimes, owing to a **pathological or psychological blockade**, semen cannot be collected by masturbation. In those cases, semen may be stored frozen prior to the treatment and be thawed. In patients suffering from **impotence** caused by paralysis in the segments ThXI-LII, ejaculation can also be induced by **vibration** or by **electroejaculation**. Although these procedures are effective in 90% of the patients, in some patients viable spermatozoa may also be collected through aspiration from the epididymis (MESA) or through a testicular biopsy (TESE).

In some cases with severe agglutinating **male immunological infertility** or in patients with viscous semen, special care must be taken for appropriate collection of the semen sample. Sperm preparation can be facilitated by collecting the semen into 2 ml of equilibrated culture medium in order to reduce not only the **agglutination** of sperm, but also to limit the binding of antibodies to the sperm surface during liquefaction. In some cases, dissociation of agglutinated sperm can also be achieved by the addition of **proteolytic enzymes**, e.g. trypsin. These enzymes can be added to the sperm suspension in an albumin-free culture

medium for up to 20 min without damage (Pattinson et al. 1990). The medium containing the enzyme should be washed away before insemination to prevent any interference of the proteolytic enzyme with the interaction between the gametes.

In patients suffering from **retrograde ejaculation**, three different methods can be used for sperm collection for assisted fertilization.

- First, **antegrade ejaculation** may be achieved by the administration of specific drugs, such as **alpha-adrenergic** substances (phenylpropanolamine, oxedrine) or **anticholinergics** (brompheniramine) (Kamischke and Nieschlag 1999, see also Chap. 23).
- An alternative consists of collecting the freshly ejaculated sperm from the bladder through a catheter. Because of the acidity and the high osmolarity of the urine, adequate preparation of the patient is necessary to protect the sperm before and after ejaculation. Before ejaculation the bladder should be emptied and rinsed with 10 ml of the culture medium. Before ejaculation the urine may be alkalized by oral intake of a high-dose sodium bicarbonate (1–4 g).
- A third method consists of the extraction of spermatozoa from the testicular tissue (TESE).
- In some forms of **azoospermia** spermatozoa can be collected from the epididymis through the micro-surgically incised tubule and by aspiration into a capillary ("**microsurgical epididymal sperm aspiration**", **MESA**). Usually motile spermatozoa are not found immediately and several incisions into the epididymis have to be made, first in the distal portion of the cauda epididymidis, and then more proximally, until motile spermatozoa can be recovered. In most patients suffering from long-standing obstructive azoospermia motile spermatozoa are not recovered from the cauda epididymidis, but rather from the more proximal portion of the epididymis. The concentration of the spermatozoa recovered from an obstructed epididymis may vary, but motility is usually below 20%. This time-consuming procedure can also be performed 1 day before oocyte collection. Alternatively, sperm can be recovered for ICSI not only from the vas deferens and the epididymis, but also from the testis itself. For this purpose one (in **obstructive azoospermia**) or up to nine tissue samples (in **hypergonadotropic azoospermia**, Devroey et al. 1994) can be removed from the testis, in which viable spermatozoa can be

sought for ICSI ("**testicular sperm extraction**", **TESE**). Even in severe testicular atrophy with highly elevated serum FSH levels some of the seminal tubules may contain localized spermatogenesis, from which viable spermatozoa can be collected for ICSI in approximately 50% of all cases (Tournaye et al. 1999). Viable spermatozoa can be identified by slight or more intensive motility at 200- to 400-fold magnification with an inverted microscope and isolated from the tissue with a micropipette. For better planning, the testicular biopsy may be performed some time before oocyte collection and stored frozen until thawing (Fisher et al. 1996). The thawing of the tissue and its culture overnight in medium supplemented with recombinant FSH (25 IU/L) significantly improves the fertilization rate, the implantation rate and even the pregnancy rate (Balaban et al. 1999). Preincubation of the testicular tissue up to 48 h has been shown to be beneficial in some cases (Morris et al. 2007). Pentoxifylline has been used to activate immotile spermatozoa collected from testicular biopsies for ICSI (Terriou et al. 2000; Kovačič et al. 2006).

At present, there is a trend towards collecting the spermatozoa from the testis rather than from the epididymis, because the former is much less time-consuming and costly than the latter.

The prediction of finding spermatozoa in frozen-thawed biopsies based on the histological proof of foci with active spermatogenesis in single testicular tubules was incorrect in only 2.9% of all cases. In 0.7% of all biopsies **testicular cancer or carcinoma in situ** was detected (Schulze et al. 1999). The fertilization rate, the implantation rate and the pregnancy rate did not differ after ICSI performed with sperm retrieved from freshly collected testis biopsies or from previously cryopreserved biopsies (Ben-Yosef et al. 1999; Verheyen et al. 2004), although there is an ongoing controversy on the benefits of cryopreserving testicular tissue in men with severely impaired spermatogenesis (Nicopoullos et al. 2004).

Alternative methods for the collection of spermatozoa from testicular or epididymal tissue have been described. Viable spermatozoa can be retrieved by simple percutaneous puncture of the epididymal tubule ("**percutaneous epididymal sperm aspiration**", **PESA**, Craft et al. 1995) or from the testis ("**testicular fine needle sperm aspiration**", **TEFNA**, Lewin et al.

1999) and subsequent aspiration with a syringe has also been described. The advantage of these techniques is that sperm collection for ICSI can be performed not only faster but also without the costly equipment needed for MESA or TESE. The number of aspirated spermatozoa seems to be lower with PESA and with TEFNA than with alternative, more invasive techniques (Tournaye et al. 1999). At the moment, no prospective randomized study has been performed to compare the clinical benefits of the available methods.

23.7.2 Preparation of Sperm for Assisted Reproduction

Before the actual processing of the semen sample can be started, the semen must be liquefied by simple incubation at room temperature for 30 min.

A subsequent washing procedure of the semen is required, because **seminal plasma** – even at low concentration (10%) – can exert toxic effects both on the sperm itself, as well as on the oocytes. Furthermore, bacteria may be present in the semen, which, after insemination into the genital tract of the female partner or after insemination in vitro, may proliferate and cause damage. Seminal plasma also contains high concentrations of prostaglandins, which, after their introduction into the uterine cavity, may induce paroxysmal and painful contractions of the myometrium. The preparation of the semen not only separates the spermatozoa from the surrounding seminal plasma, but the proportion of highly motile and normally formed spermatozoa is increased and the process of capacitation is also induced through the removal of blocking factors from the surface of the ejaculated spermatozoa. Recently, new aspects of semen preparation, other than just removing the seminal plasma, have received attention, such as selecting those spermatozoa bearing an X- or Y-chromosome or removing apoptotic spermatozoa from the sample.

Based on the different physical principles the various methods of sperm preparation are divided into five groups:

- **Filtration**
- **Swim-up**
- **Density grade centrifugation**
- **Sorting**
- **Removal of contaminant infectious particles**

23.7.3 Filtration

Filtration of spermatozoa on a column preloaded with **glasswool** (Paulson and Polakoski 1977) or with **glass beads** (Daya et al. 1987) has found some acceptance. The suspension containing the spermatozoa freed from the seminal plasma is loaded onto a vertically positioned column, which is prefilled with either 15 mg of glass wool (microfibercode 112) or with 1 g of glass beads (each of 75 to 150 µm diameter). Before adding the sperm suspension the column is rinsed with culture medium to remove potential toxic substances and to equilibrate the content of the column. The sperm suspension is then added on top of the column, flows downward and a highly motile fraction of spermatozoa can be gathered dropwise from the column and used for assisted fertilization. Immobile spermatozoa, leucocytes and round cells tend to adhere to the glass or remain trapped in the mesh, in contrast to the motile spermatozoa, which readily pass through the column.

The filtration of sperm has the advantage of rapidly achieving a high yield of progressively motile spermatozoa. In this regard sperm filtration with columns loaded with glass wool seems to be as effective as the swim-up-method (Van der Ven et al. 1988; Katayama et al. 1989) or as density gradient centrifugation (Van den Bergh et al. 1997). The loss of spermatozoa during the filtration process seems to be low and the duration of the processing is particularly short (10 min). The results of IVF with filtered sperm are comparable to those achieved with swim-up sperm (Van der Ven et al. 1988; Katayama et al. 1989). Recently, there has been renewed interest in filtration of spermatozoa, because the glass wool loaded in the filtration columns can be covered with binding proteins, so that spermatozoa can be retained in the column based on specific properties. Columns loaded with glass wool and coated with Annexin V have been used for the filtration of samples of spermatozoa free of apoptotic cells (Grunewald et al. 2007).

23.7.4 Swim-up

Swim-up is a widely used method for sperm preparation in assisted fertilization (originally described by Lopata et al. 1976). It is based on the principle that

the most motile and capable spermatozoa can swim vigorously upwards against gravity into a layer of culture medium positioned on top of the sperm pellet. A fraction of highly motile sperm free of seminal plasma and leucocytes can be collected after 60–90 min of incubation. The significance of swim-up for sperm preparation is further enhanced by the finding that those properties needed for the penetration of motile sperm into the supernatant are the same required for the **penetration into cervical mucus** and for the **actual fertilization of oocytes** (De Geyter et al. 1988). Thus the concentration of sperm after swim-up is also correlated with the results of assisted fertilization. In contrast to earlier reports, no selection of Y-chromosome bearing spermatozoa can be achieved with the swim-up-procedure (Han et al. 1993).

The main disadvantage of the swim-up-method is the low recovery rate of motile spermatozoa, especially in cases with severe abnormalities of the original semen sample, and by the lengthy time interval needed for sperm preparation. Furthermore, the centrifugation of the semen diluted with culture medium and the subsequent concentration of capacitating spermatozoa and oxygen radical-secreting leukocytes into a densely packaged pellet, are potentially damaging both to the membrane and the DNA of the spermatozoa.

Nevertheless, in comparison to other methods of sperm preparation such as density gradient centrifugation and filtration, swim-up is characterized by better motility and relatively higher numbers of normally formed spermatozoa (Englert et al. 1992). The swim-up method is highly reproducible when performed by different technicians.

23.7.5 Density Gradient Centrifugation

With density gradient centrifugation, motile and normally formed spermatozoa are separated not only by centrifugal force, but also by differences in the density of individual cells. The density of living spermatozoa is known to differ from that of degenerated or dead spermatozoa. To achieve a separation with density gradient centrifugation, the washed sperm suspension is layered onto a column comprising several layers of a colloid suspension of different density and subsequently

centrifuged. For this purpose **Percoll®** can be used, which contains **colloidal particles made of silicone** with diameters between 15 and 30 nm. These particles are coated with the biologically inert **polyvinylpyrrolidone**.

In the column containing various layers of different density colloidal particles not only vital and dead spermatozoa but also leucocytes and spermatozoa can be separated during centrifugation. Various modifications and compositions of the solutions containing the colloidal particles have been designed: continuous density gradients (Berger et al. 1985), discontinuous density gradients (Guérin et al. 1989) and discontinuous density gradients in small volume (mini-Percoll®, Ord et al. 1990). For the establishment of continuous density gradients ultracentrifugation must be performed (>100,000 g) which is more suitable for the separation of small-sized particles such as viruses and mitochondria. Therefore, for the separation of the relatively larger sized spermatozoa, discontinuous density gradients are predominantly used. The enriched fraction containing motile spermatozoa can be recognized easily as a discrete turbid band in the area between 85% and 100% of the Percoll® suspension. Density gradient centrifugation based on Percoll® has been shown to be detrimental in many cases due to contamination with endotoxins and has been forbidden for clinical use (Henkel and Schill 2003). Since then, various alternative solutions have been made available for use in reproductive medicine (such as PureSperm®, Ixaprep®, Isolate® and SilSelect®), all leading to acceptable results during clinical application.

Although density gradient centrifugation yields more motile spermatozoa than the swim-up-method, the impact of both methods on the results of conventional IVF remains controversial. A recent meta-analysis has not been able to detect differences in the pregnancy rates after IUI with respect to various techniques of semen preparation (Boomsma et al. 2007).

Compared with the swim-up method (at least 60 min), sperm preparation with density gradient centrifugation (20 min) is less time-consuming. Density gradient centrifugation is not associated with any enrichment of Y-chromosome-carrying spermatozoa (Vidal et al. 1993). Furthermore, the risk of inflammation caused by colloidal silicone particles in the genital tract of the patients after insemination was ruled out experimentally (Pickering et al. 1989).

23.7.6 Sorting of Spermatozoa Based on Defined Characteristics

Recently, more experimental work has been carried out to promote the sorting of fertilizing spermatozoa based on defined biological properties considered to be beneficial for the process of assisted fertilization. The earliest example was the sorting of spermatozoa based on the higher DNA content of spermatozoa carrying the X chromosome to separate those from Y-chromosome bearing spermatozoa using flow cytometry (FACS). Viable spermatozoa with predefined properties were sorted using either flow cytometry or sorting was based on minute differences in DNA content or magnetic beads covered with antibodies against certain surface markers. Flow cytometry is used for the separation of spermatozoa containing the Y chromosome from those carrying the X chromosome in order to achieve a higher yield of embryos with female genotype. For this purpose spermatozoa have to be marked with a fluorescent dye, which allows the distinction of spermatozoa based on the quantity of DNA in their genome. Spermatozoa with an X chromosome contain approximately 3% more DNA than spermatozoa carrying a Y chromosome.

With flow cytometry a sufficient number of motile spermatozoa can be selected rapidly enough to be used in assisted fertilization (Johnson et al. 1993). Several pregnancies were achieved using this method in IUI, in conventional IVF and in ICSI, mainly for the prevention of X chromosome-linked genetic diseases (Fugger et al. 1998). Although this method of sperm selection can be abused to manipulate the sex of the newborn, it has achieved some importance for the prevention of X-bound genetic illnesses. The risk of alterations in the DNA structure induced by the fluorescent dyes has been excluded in extensive animal research.

Sorting of fertilizing spermatozoa can also be achieved by using magnetic bead sorting (MACS). Semen contains a sizeable subpopulation of damaged spermatozoa undergoing apoptosis. Apoptosis or programmed cell death entails damage both to the cell's integrity and to its DNA. Using magnetic beads loaded with annexin V, a phospholipid-binding protein with high affinity for transmembrane surface markers which become externalized during apoptosis, damaged spermatozoa destined to undergo cell death can be sorted and removed from the sample to be used for assisted

fertilization (Said et al. 2006; Grunewald et al. 2007). Removal of apoptotic spermatozoa by utilizing their binding affinity to annexin V resulted in higher fertilization rates in the surrogate hamster zona-free penetration test and in an experimental ICSI model (Said et al. 2006).

A third example for the successful selection of functional spermatozoa is given by the electrophoresis of spermatozoa based on the negative electric charge of the surface of the membrane in intact spermatozoa. This property is used to separate high quality spermatozoa in a magnetic field (Ainsworth et al. 2005). At present, only one successful pregnancy has been achieved with ICSI after having selected spermatozoa using this novel method (Ainsworth et al. 2007). All centrifugation of spermatozoa is avoided. The major disadvantage of this method is its failure to improve the number of motile spermatozoa in the prepared sample to be used for assisted fertilization.

23.7.7 Removal of Contaminant Infectious Particles

In recent years an increasing number of infertile men present with concomitant infections, such as hepatitis B, hepatitis C and HIV. Those infections present a serious risk for contamination of the partner, the personnel and the laboratory environment. Except for hepatitis B, which has the potential to become integrated into the spermatozoon's genome, all those contaminants reside in the seminal plasma at variable concentrations and can be separated from the capacitating spermatozoa using conventional washing methods.

The first infectious agent, demonstrated to be removable from the capacitating spermatozoa, was HIV (Semprini et al. 1992). For this purpose various modifications of the density gradient centrifugation method have been used and the safety of the method has been established in a large multicentric trial (Bujan et al. 2007) and can be used in all existing methods of assisted reproduction (Savasi et al. 2007). In HIV infected infertile men it is still recommended to determine the viral load in the sample used for assisted reproduction. In addition, the swim-up method has also been used in a smaller cohort of men infected with HIV and shown to be effective (Tschudin et al. 2008).

23.7.8 Processing of Sperm for ICSI in Difficult Cases

In some patients treated with ICSI, often only isolated motile spermatozoa are available and no adequate separation can be performed. In these cases one simple washing of the sample consisting of centrifugation and discharge of the supernatant fluid and resuspension of the pellet of spermatozoa, can sufficiently clean the sample of debris.

To facilitate catching single motile spermatozoa with the micropipette, the viscosity of the culture medium may be increased by the addition of a high concentration of the biologically inert **polyvinylpyrrolidone** (8 g/100 ml culture medium), a macromolecule with a molecular weight of 360,000 kDa. Any alleged mutagenic action of polyvinylpyrrolidone possibly entering the oocyte during the intracytoplasmic injection has been ruled out experimentally (Ray et al. 1995). Nowadays, the accumulated manual expertise in many centres has led to complete avoidance of those substances. **Pentoxifylline** has also been used to enhance the motility of spermatozoa and thereby their visibility for catching, particularly in testicular biopsies.

ICSI can also be performed successfully with immotile but vital spermatozoa (Nijs et al. 1996; Casper et al. 1996; Liu et al. 1997). Because vitality of the sperm cannot be recognized by cellular movements, the integrity of the spermatozoon's membrane is used to prove its vitality. This can be achieved with the hypoosmotic swelling test. For this purpose the sperm are incubated in culture medium previously diluted 1:1 (v/v) with distilled water. A typical swelling of the tail of the sperm indicates its vitality. The sperm will recover when transferred with the micropipette into the native culture medium before ICSI.

23.7.9 Treatment of Spermatozoa In vitro

As well as the selection of fertile spermatozoa by different methods of sperm preparation, changing the composition of the culture medium surrounding the spermatozoa has been used to improve the results of assisted fertilization.

For this purpose various chemical substances are added to the culture in order to stimulate sperm motility:

2-deoxyadenosine (Aitken et al. 1986), **pentoxifylline** (Yovich et al. 1990) and **caffeine** (Imoedemhe et al. 1992). These substances act as inhibitors of phosphodiesterase, which is associated with an increase of the intracellular concentration of cAMP. It has been demonstrated that after addition of each of these substances to the seminal plasma or to the culture medium, the motility, velocity and extent of hyperactivation can be increased significantly (Imoedemhe et al. 1992; Kay et al. 1993). **Pentoxifylline** is widely used in cases with complete immobility of the spermatozoa and in TESE (Terriou et al. 2000; Kovačič et al. 2006).

23.8 Ovarian Follicular Development, Ovarian Stimulation, Ovulation Induction and Oocyte Collection

23.8.1 Monitoring of Ovarian Follicular Development and Ovarian Stimulation for Insemination

The therapeutic efficacy of insemination may not only result from an increased number of motile spermatozoa in the lumen of the Fallopian tube, but also from the exact timing of ovulation, with which insemination is usually synchronized. Watchful management consisting of the close observation of the endogenous changes occurring during a natural menstrual cycle leading to ovulation can be chosen for optimal timing of insemination and has been demonstrated to be beneficial in cases with severe reduction of semen quality (Cohlen et al. 1998).

Insemination in the natural cycle stands in contrast to a active management of all events during the follicular phase of the menstrual cycle, such as stimulation of ovarian follicular development and by induction of ovulation. Originally, the adoption of this strategy in supporting IUI was motivated by the early successes of ovarian hyperstimulation used in IVF and ICSI. Ovarian function can be stimulated with clomiphene citrate, with gonadotropins and, more recently, with aromatase inhibitors. Although some studies have demonstrated higher pregnancy rates with ovarian stimulation and ovulation induction with gonadotropins (Guzick et al. 1999, Fig. 23.3), there is still insufficient evidence concerning the efficacy of an expectant,

watchful versus active management followed by IUI (Cantineau et al. 2007), and particularly in couples suffering from male infertility (Bensdorp et al. 2007).

The efficacy of the concomitant management of the menstrual cycle may also depend on the characteristics of semen quality. Whereas in the presence of a moderate reduction of semen parameters a beneficial effect of an active management of follicular development was observed, this was not the case in cases with more severe reduction of seminal parameters (Cohlen et al. 1998). This seemingly paradoxical finding illustrates the relative contribution of female infecundity in couples primarily diagnosed with mild male infertility and explains how an exogenous management of the menstrual cycle may contribute to the outcome of IUI.

However, the most important disadvantage of gonadotropin stimulation is the higher rate of **multiple pregnancies**. Any insemination should be cancelled in the presence of more than three follicles with a diameter of at least 14 mm. The risk of multiple pregnancies can be reduced significantly by low-dosed gonadotropin administration. Cancellation of cycles can be avoided by the aspiration of supernumerary follicles immediately before IUI (De Geyter et al. 1996). Gonadotropin stimulation of the ovaries may also be complicated by the **ovarian hyperstimulation syndrome**, which is a potentially life-threatening complication. The severe form of the ovarian hyperstimulation syndrome is rare in patients treated with insemination, compared with treatment cycles for IVF or ICSI, because of the generally lower doses of gonadotropins used in the former group.

23.8.2 Ovarian Stimulation for IVF and ICSI

Although IVF and ICSI can be performed with some degree of success in the untreated, natural menstrual cycle or with minimal ovarian stimulation (Pellinck et al. 2006), the reported pregnancy rates are generally low, approximately 8–9% per treatment cycle. Despite the low intensity of the method, the dropout rate exceeded the pregnancy rate even after three unsuccessful treatment trials (Pellinck et al. 2007). It has been long-standing experience that the pregnancy rates in IVF and ICSI can be raised significantly by the presence of higher numbers of available oocytes. A multitude of

different treatment protocols for the stimulation of ovarian follicular development were developed over time and were correlated with the results of assisted fertilization.

Initially, follicular development was stimulated with **clomiphene citrate** with or without **human urinary gonadotropins**, but 25–30% of the treatment cycles had to be abandoned because of premature luteinization and/or premature ovulation.

Premature ovulation is now effectively avoided either by the combination of ovarian hyperstimulation with long-acting GnRH-agonists, which are used to inhibit the preovulatory rise of LH and thereby premature ovulation, or with GnRH-antagonists, which are given during the later stages of follicular development. Although various combinatory protocols with gonadotropins and GnRH-agonists have been described over time, it was demonstrated in several large cohort studies that a preceding down-regulation with **long-acting GnRH-agonists** consistently leads to significantly higher pregnancy rates in IVF and ICSI. The following protocols for the combination of gonadotropins with GnRH-agonists have been described:

- Long protocol: before ovarian hyperstimulation is initiated, the endogenous secretion of gonadotropins is down-regulated with long-acting GnRH-agonists, applied during the preceding menstrual cycle, either during the luteal phase or at the very early beginning of the menstrual cycle or during intake of a birth control pill.
- Short protocol: treatment with the GnRH-agonist is initiated together with ovarian hyperstimulation with gonadotropins, thereby using the flare-up effect of the GnRH-agonist on the endogenous gonadotropin secretion for ovarian hyperstimulation. In the short protocol the GnRH-agonist is given until the end of the follicular phase.
- Ultrashort protocol: similar as in the short protocol, but the GnRH-agonist is given for only a few days.

However, the major **disadvantage** of using long-acting GnRH-agonists, as compared to GnRH-antagonists, resides in the higher consumption of gonadotropins, thereby considerably increasing treatment costs, and the higher risk of the **ovarian hyperstimulation syndrome** due to the unopposed recruitment of growing ovarian follicles (Al-Inany et al. 2007).

The recent trend to milder stimulation regimens in younger women treated with IVF and ICSI, the need to

reduce consumption of the more costly recombinant gonadotropins and the widespread desire to limit the complexity of the treatment protocols has led to the development of protocols involving the use of GnRH-antagonists to prevent premature ovulation.

Two protocols based on the use of GnRH-antagonists have been developed:

- Single or dual administration of a high dose of a GnRH-antagonist, initially given at approximately 14 mm follicular diameter (Olivennes et al. 1994).
- Multiple-dose GnRH-antagonist: starting at approximately 12 mm follicular diameter the GnRH-antagonist is given daily until ovulation induction (Diedrich et al. 1994).

Whereas population-based, observational studies have initially suggested a lower efficacy of ovarian hyperstimulation using GnRH-antagonists (Pouly et al. 2004), probably due to selective use of this protocol in women with low response to gonadotropin treatment (Griesinger et al. 2005), comparable pregnancy and delivery rates were achieved with GnRH-antagonist-supported protocols as compared to those using GnRH-agonists (Al-Inany et al. 2007). The use of GnRH-antagonists during ovarian hyperstimulation with gonadotropins entails three advantages: (1) consumption of less gonadotropin preparations as the result of a slightly shorter duration of the stimulation; (2) reduced complexity of the stimulation protocol; (3) reduced risk of the ovarian hyperstimulation syndrome.

Ovarian hyperstimulation, particularly if either GnRH-agonists or GnRH-antagonists are used, leads to a significant shortening of secretion of progesterone of the luteal body and inevitably requires a hormonal support of the luteal phase (Hutchinson-Williams et al. 1989). Support of the luteal phase has been performed with human chorionic gonadotropin (hCG) or with some gestagenic preparation, mainly progesterone. Although support of the luteal phase with hCG is more effective, the risk of the ovarian hyperstimulation syndrome is much higher than with a gestagenic preparation (Daya and Gunby 2004). Therefore, support of the luteal phase with progesterone, either given transvaginally or parenterally, has become the method of choice. The vaginal administration of progesterone results in an accumulation of progesterone in the uterus, thereby enhancing the endometrial secretory function in the presence of low circulating levels of progesterone and thus avoiding side effects (Cicinelli et al. 2000).

In cases not leading to successful pregnancy, support of the luteal phase with progesterone only often leads to early menstruation. The addition of a single midluteal administration of hCG (for example a single dose of 2,500 international units) is helpful to prevent early bleeding, but does not lead to higher pregnancy rates (Herman et al. 1996). Premature menstruation can also be prevented by additional administration of estrogens. However, the current tendency to use various estrogenic preparations in addition to progesterone remains without any confirmed scientific basis (Gelbaya et al. 2008).

The widespread support of the luteal phase with progesterone or analogues beyond the initial confirmation of pregnancy has been demonstrated to have no beneficial effect on the prevention of miscarriages (Schmidt et al. 2001; Nyboe Andersen et al. 2002).

23.9 Methods of Oocyte Collection

Originally, laparoscopy was the only technique available for low-invasive oocyte collection, originally contributing to the first successful introduction of IVF during the 1970s (Steptoe 1970), because it gave the physician easier and less traumatic access to the ovaries to collect oocytes than laparotomy. Instead of the earlier laparoscopic method, oocytes are now most almost universally collected by **ultrasound-guided transvaginal puncture of the follicles**, which can be performed without general anaesthetics. Ultrasound-guided transvaginal puncture of preovulatory follicles with a hollow needle has become an outpatient procedure, thereby contributing to the widespread availability of assisted reproduction. Three main properties of the ovary enabled development of this procedure: first, the ovaries are usually located directly behind the vagina. Secondly, the ovaries are hardly sensitive to pain. Thirdly, owing to the plasticity of the organ, the follicles can be emptied one by one by slight movement of the needle, thereby avoiding repeated transvaginal punctures (Fig. 23.11). Most follicles must not be flushed with a rinsing fluid in order to collect the oocytes.

The complication rate of this procedure is very low. Vaginal or intra-abdominal bleedings may rarely occur. Infections may occur after incidental puncture of endometrial cysts or other intestinal structures, such as the appendix.

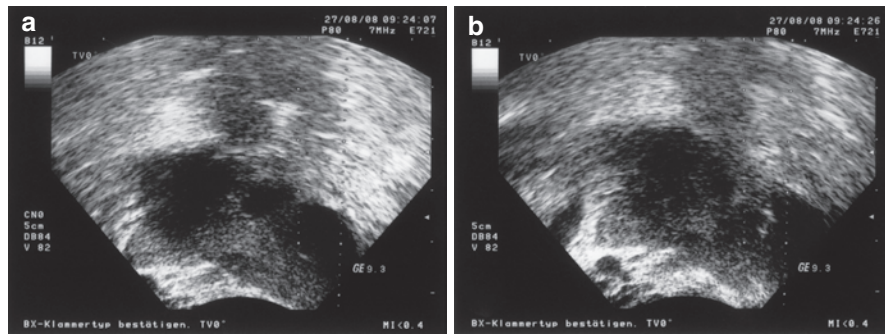

Fig. 23.11 For ultrasound-guided collection of oocytes a hollow needle is first inserted transvaginally towards the antrum of a mature ovarian follicle (a). Then the needle is inserted into the follicle (b) and its content is aspirated into a culture tube. The tip

of the aspiration needle is visualized with a white arrow. In the aspirated follicular fluid the cumulus oophorus-oocyte complex can be identified rapidly under a stereomicroscope

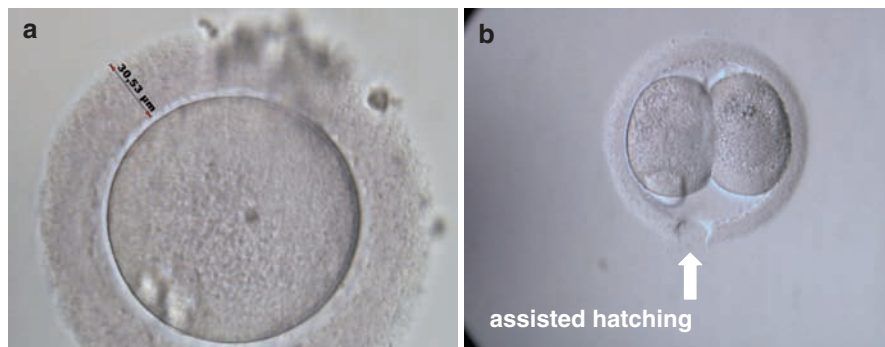

Fig. 23.12 Assisted hatching may be effective in improving the implantation rate in embryos surrounded by an abnormally thick zona pellucida (a). For “assisted hatching”, performed immediately before embryo replacement into the uterine cavity, the zona pellucida is opened (arrow) with a laser beam or with locally

applied acid solution. This technique was modified from two micro-assisted fertilization methods, “zona drilling” and “partial zona dissection” and aims at improving the implantation rate of the embryos (b)

23.10 Assisted Hatching

The capacity of non-selected embryos to implant after IVF or ICSI is generally as low as 20%. This low embryonic implantation rate is caused by genetic abnormalities in more than half of the replaced embryos. Implantation may also be impaired by mechanical obstacles such as the zona pellucida, which is known to become hardened during in vitro culture and may interfere with the hatching process, in which the blastocyst escapes from the zona pellucida. Additionally, the development of some embryos generated with IVF or ICSI may lag behind normal embryo development in the Fallopian tube, also causing difficulties during the hatching process. Finally, some embryos possess a

remarkably thickened zona pellucida (Fig. 23.12), which is thought to be a barrier during the hatching of blastocyst embryos.

The techniques developed for “zona drilling” and “partial zona dissection”, originally conceived to improve fertilization rates in couples suffering from male infertility, were modified to improve the implantation rate. The method essentially consists of making a hole in the zona pellucida of approximately the same diameter as the thickness of the zona pellucida itself. Assisted hatching was first performed with a locally applied acid solution, later also with a laser beam.

Assisted hatching was considered helpful in women with an abnormally thick zona pellucida (>13 µm) and in embryos with fragmented blastomeres (Cohen et al.

1992). However, randomized prospective studies have not been able to demonstrate any beneficial effect of assisted hatching, neither in patients with unfavorable prognosis (Primi et al. 2004) not in those with a favorable prognosis (Sagoskin et al. 2007). A significantly higher prevalence of **monozygotic twinning** was observed after assisted hatching (Hershlag et al. 1999). However, this technique has been shown to accelerate the hatching process in blastocysts.

23.11 Embryo Transfer

The embryos resulting from successful IVF are placed in the genital tract of the patient for later implantation, usually in the uterine cavity. **Uterine placement of embryos** is a procedure causing no or little pain and is nowadays performed within a few minutes as part of a routine gynecological investigation.

After visualization of the cervix with a speculum, the anterior portion of the cervix is clamped with a forceps. Under slight traction a catheter is introduced into the cervical canal. Then the embryos are aspirated, along with a small drop of cultured medium (approximately 10 µl), into a fine catheter (Fig. 23.13). This fine catheter is then inserted carefully through the previously positioned broader catheter into the uterine cavity (about 6 cm depth). Not only the low volume of fluid introduced along with the embryos is important, but also carrying out the procedure in an absolutely atraumatic fashion. After the transfer, the presence of embryos adhering to the catheter should be checked under the microscope. Although embryo transfers are still being performed blindly in many institutions, the ultrasound-guided insertion of the catheter into the

uterine cavity may lead to higher pregnancy rates (Abou-Setta et al. 2007). After a few minutes the patient is allowed to stand up and to leave the unit.

The complication rate of intrauterine embryo transfer is

The optimal technique of embryo transfer is one of the most important factors contributing to consistently high pregnancy rates in IVF and ICSI.

very low. In rare cases endometritis may occur. The replaced embryos may slip into the Fallopian tube, causing **ectopic** pregnancies especially in patients with widened tubal diameters (sactosalpinx). The surgical removal of unilateral or bilateral hydrosalpinges visible in ultrasound, prior to assisted reproduction (Strandell et al. 1999) has considerably contributed to reduce the risk of ectopic pregnancies after IVF or ICSI.

Occasionally, stenosis of the cervical canal may constitute an insurmountable obstacle to the replacing of embryos. However, earlier reports describing successful transmyometrial injection of embryos through the anterior wall of the uterus into the endometrium (Kato et al. 1993) have not been confirmed by others.

23.12 Cryopreservation of Oocytes in the Pronucleate Stage

The German Embryo Protection Act but also legislation in some other countries, among them Switzerland, all stipulate that in each treatment cycle with IVF or ICSI not more than three oocytes may be fertilized and replaced after development into the embryo stage. If more than three oocytes are fertilized with IVF or ICSI, they can be cryopreserved in the pronucleate

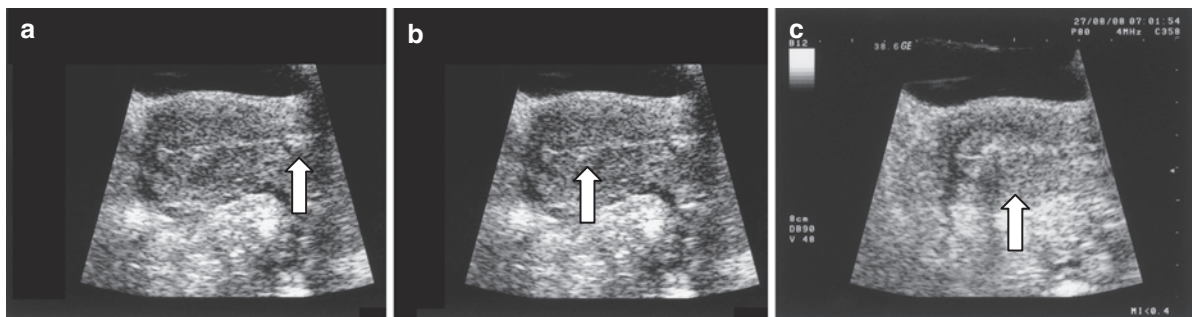

Fig. 23.13 Sonographic presentation of the transfer of an embryo into the uterine cavity. (a) Tip of the replacement catheter guided through the cervical canal into the uterine cavity. (b) The tip of the catheter is situated in the upper part of the uterine

cavity. The embryos are situated in a droplet of culture medium surrounded by two air bubbles and by two additional droplets of culture medium (c)

stage prior to completion of the fertilization process. When pregnancy does not occur in the treatment cycle with fresh oocytes, the cryopreserved oocytes may be thawed and replaced, thereby avoiding repeated ovarian stimulation and oocyte collection.

Cryopreservation of oocytes in the pronucleate stage must be carried out prior to the approximation of both pronuclei, about 20h after *in vitro* insemination in IVF or after the ICSI procedure. The pronucleate oocytes are first dehydrated at room temperature in a series of solutions in order to prevent crystallization of water within the oocyte during the freezing process, which may cause extensive damage. Before starting the freezing protocol of the pronucleate oocytes, they have to be treated with stepwise increasing concentrations of one of more cryoprotectants. Then, surrounded by the highest concentration of the cryoprotectant solution, the zygotes are inserted into plastic tubes, often called straws. After sealing and coding of the straws, cryopreservation is performed in liquid nitrogen, usually in an automated system, which controls the freezing process at a predetermined pace. At -6°C to -7°C seeding is induced, after which crystallization occurs, avoiding possible damage to the oocytes. Long-term cryopreservation follows by transferring the straws into tanks filled with liquid nitrogen (below -140°C).

Replacement of the thawed pronucleate oocytes takes place after their development into the early embryonic stage. This is usually performed in the natural menstrual cycle, after treatment with clomiphene citrate or after preparation of the endometrium with exogenous estrogen preparations followed by micronized progesterone or other gestagenic preparations. With conventional slow-freezing protocols, the survival rate of the thawed oocytes varies between 75–90%. With unselected oocytes the results of embryo transfer with frozen/thawed oocytes at the pronucleate stage seems to be comparable to freezing and thawing of cleavage stage embryos (Senn et al. 2000). Neither increased prevalence of malformations nor of developmental abnormalities have been observed among children conceived after replacement of frozen-thawed pronucleate oocytes (Ludwig et al. 1999).

Recently, alternative protocols for the cryopreservation of oocytes at the pronucleate stage, other than the conventional slow freezing protocols, have been proposed. Vitrification has the promise of achieving much higher success rates. Vitrification defines an ultra-rapid freezing method (less 1/10,000s), in which

no crystallization takes place, thereby reducing the risk of damage to the biological material. In order to achieve maximal rapidity, only single oocytes can be stored frozen. Higher success rates can be achieved with open systems, which allow greater speed in the freezing process. However, at present the safety of vitrification remains to be documented scientifically.

23.13 Complications of Assisted Reproduction

The widespread use of assisted reproduction for the alleviation of infertility, the rising age of the infertile partners and the broadening of conditions that can be treated with assisted reproduction have all raised concerns about the possible short-term and long-term health risks, not only to the women treated but also to their offspring. Dissecting the risks of the various therapeutic components of assisted reproduction from those resulting from infertility has been difficult and is still ongoing. As infertility itself leads to a higher incidence of complications during pregnancy and delivery (De Geyter 1994) appropriate conclusions can only be drawn from pregnancies achieved in previously infertile couples conceiving naturally. Uterine bleeding during early pregnancy, pre-eclampsia, abnormal placentation including placenta praevia and premature rupture of the membranes have all been demonstrated to occur more frequently after assisted fertilization (Källén et al. 2005). However, much of our present knowledge has been compiled from nationwide registries, in which data of both fertile and infertile couples were gathered jointly. In addition, data about the potential long-term consequences of assisted reproduction, such as the incidence of cancer in previously infertile women or metabolic and/or fertility hazards in their offspring, will only be available in future decades.

Nevertheless, the occurrence of some of the notable complications is known and will be discussed here.

23.13.1 Ovarian Hyperstimulation Syndrome (OHSS)

OHSS is a common complication of all forms of medical stimulation of ovarian function, affecting up

to 2% of all treatments with assisted reproduction, particularly IVF and ICSI (Delvigne and Rosenberg 2002). The presence of hCG in the patient's blood circulation is essential for the development of OHSS, which usually develops about 12 days after ovulation induction, occasionally earlier. It is associated with a massive swelling of the abdomen due to an enlargement of the ovaries accompanied by ascites (Delvigne and Rosenberg 2003). The latter often leads to hemoconcentration (as measured by hematocrit) thereby causing physical distress (with high leukocyte numbers in the peripheral blood count), and an increased risk of intravascular blood clotting. The hypovolemia may lead to anuria. OHSS is characterized by low sodium, high potassium and low albumin levels in the serum. If not managed properly, OHSS is a potentially life-threatening condition. Women with an otherwise subclinical diaphragmatic hernia may also develop unilateral or bilateral pleural effusions, which are characterized by dyspnoea and frequent coughing.

The treatment of OHSS consists of correction of the composition of circulating blood through infusion therapy and aspiration of ascites and/or pleural effusion. Nowadays, OHSS can be prevented in many patients by using milder stimulation regimens, through prolonged coasting (Sher et al. 1995) and by avoiding the administration of hCG during the luteal phase (Delvigne and Rosenberg 2003).

23.13.2 Ovarian Torsion

Ovarian hyperstimulation leads to an enlargement of the ovaries, particularly during the luteal phase and during early pregnancy. After the 9th week of gestation, the placenta resumes its function and the size of the ovaries will gradually become normal again. Particularly in slender women treated with ICSI because of male infertility and in whom intraperitoneal adhesions are not prevalent, these enlarged ovaries may undergo torsion. In ovarian torsion blood circulation from and to the organs may become compromised leading to the organ's infarction. It occurs in 0.1–0.3% of all cases and is observed more often in women with multiple pregnancies (Kallén et al. 2005).

23.13.3 The Risk of Multiple Pregnancies

Although the first pregnancies arising after IVF were achieved in the unstimulated, natural menstrual cycle, various forms of ovarian stimulation were soon introduced to raise the pregnancy rates of IVF. This strategy envisages the transfer of more than one embryo per cycle, which was beneficial for improving the pregnancy rates. The drawback of this strategy consists of high numbers of multiple pregnancies, not only twins, but also high order multiple pregnancies, such as triplets and quadruplets. In many countries multiple pregnancy rates were as high as 40%, so that more children were born from multiple pregnancies than from singletons. The high numbers of multiple pregnancies induced by assisted reproduction have installed a heavy burden on obstetric and neonatal institutions, but also on the long-term physical and social wellbeing of the previously infertile couples and their children. In order to reduce the number of multiple pregnancies induced by assisted fertilization, many countries have issued a restrictive legislation with regard to the number of embryos to be replaced per cycle (often limited to three). Currently, there is a widespread trend to replace only one single embryo per treatment. Unfortunately, the restrictive legislation in various countries, such as Germany and Switzerland, is counterproductive for the adoption of this policy, as this necessitates the selection of one embryo out of a cohort of several embryos, thereby producing surplus embryos (Van den Bergh et al. 2005).

Whereas by far most multiple pregnancies arising from assisted reproduction are multizygotic, the rate of monozygotic multiple pregnancies is also higher. Although the mechanism of monozygotic twinning is not known, it seems to be related to the hardening of zona pellucida during prolonged culture in vitro. Transfer of embryos at the blastocyst stage is not considered to lead to a higher incidence of monozygotic twinning by some authors (Papanikolaou et al. 2006), but not by others (Jain et al. 2004).

23.13.4 Cancer Risk in the Mother After Assisted Reproduction

There is some uncertainty whether there is any association between hormonal stimulation of ovarian function

for assisted fertilization and a higher incidence of various malignant diseases, such as breast cancer, ovarian cancer and others. The possibility of such an association must be differentiated from known correlations between the failure to conceive and the occurrence of malignant disease (such as ovarian cancer) and delayed conception and the occurrence of malignant disease (such as breast cancer). In addition, various conditions causing infertility have also been associated with a higher risk of malignancy, such as the association of endometriosis with ovarian cancer and the association of polycystic ovary disease and endometrial cancer. Furthermore, the time interval between the widespread use of ovarian hyperstimulation and the occurrence of various forms of cancer, such as ovarian cancer, which is a disease afflicting women at a very advanced age, is still insufficient to detect a meaningful association. Various large-scale studies have been performed, but at present there is no evidence delineating a consistent association between assisted reproduction and a higher incidence of breast cancer, ovarian cancer, endometrial cancer and cervical cancer (Venn et al. 1999; Dor et al. 2002; Lerner-Geva et al. 2003; Gauthier et al. 2004; Kristiansson et al. 2007).

23.14 Genetic Counselling in Assisted Reproduction

Concern with the genetic causes of male infertility followed the first introduction of ICSI (Palermo et al. 1992) and has resulted in the detection of an array of different genotypes associated with male infertility. The condition of infertility by itself has been demonstrated to entail a higher risk of malformations in the offspring, but ICSI by itself seems to add to the inherent risk of malformations in infertile couples (Katalinic et al. 2004; Gjerris et al. 2008). The risk of neonatal malformations seems not to be directly related to the source of the spermatozoa (ejaculated, epididymal or testicular) nor to the concentration of spermatozoa in the seminal plasma (Ludwig et al. 2003). Although a defined genetic syndrome causing infertility cannot be identified in most couples, a few cases are clearly the sequel of a genetic problem. Particularly male infertility has been associated with genetic abnormalities, such as structural chromosomal abnormalities, mutations

in the cystic-fibrosis transductance regulator-gene (CFTR) and microdeletions of the Y-chromosome.

All patients who consider assisted reproduction and whose fertility problem has a genetic basis should undergo formal genetic counselling. The same recommendation is made when the patients' medical history or the family history suggest specific genetic risk factors.

Particularly those couples whose infertility requires treatment with ICSI are at risk of some genetic abnormality:

- Four to 5% of men and 6–7% of women enrolled in ICSI programs have an abnormal karyotype, either numerical or structural.
- Severe oligozoospermia (less than 1 million/ml) and non-obstructive azoospermia represent the most clearcut indications for ICSI. Whereas a deletion in the AZFc-region of the Y-chromosome may be associated with the presence of few spermatozoa in the ejaculate, deletions of the AZFa- and of the AZFb-regions lead to complete azoospermia (Simoni et al. 2008).
- MESA/TESE with consecutive ICSI are the treatment modality of choice for congenital bilateral absence of the vas deferens (CBAVD) and bilateral ejaculatory duct obstruction. Approximately 85% of men presenting with either of these variants of obstructive azoospermia carry mutations in the cystic fibrosis (CFTR) gene.
- In about 1% of men treated with ICSI, the fertility problem is one facet of a syndrome type of disorder.
- Two percent of patients enrolled for ICSI are affected with non-reproductive, potentially heritable disorders, such as congenital heart disease, cleft lip and palate and others. This rate slightly exceeds the baseline prevalence (1%) of such disorders among fertile controls.

In general, careful documentation of the personal, medical and family history (if necessary including the construction of a pedigree) should be performed. In cases of recurrent miscarriage (including those in close relatives), of unexplained azoospermia or severe oligozoospermia, both partners should be karyotyped and testing the male partner for Y chromosomal microdeletions is

Table 23.2 List of information to be taken from the history of the infertile couple and special indications chromosomal analysis prior to assisted reproduction

Important questions with regard to genetic risks in the presence of male infertility:
Recurrent intrauterine fetal demise in consanguineous couples
History of neonatal malformation or hereditary diseases among relatives
Infertility among close relatives
Consanguinity among both partners
Indication for chromosomal analysis, in addition to routine indications:
Recurrent miscarriage in the female partner (three or more)
Intrauterine fetal demise, particularly when the fetus presented with malformation
Malformations in the female partner or in her kinship
Infertility among close relatives

advisable (see Chap. 8). Other tests, such as mutation screening in the CFTR gene in patients with CBAVD are performed when suggested by the clinical situation.

The physician in charge of therapy should at least check the points listed in [Table 23.2](#) and organize the appropriate genetic laboratory tests.

23.15 Health of the Offspring After Assisted Fertilization

From its early beginnings the introduction of ICSI for the treatment of male infertility has raised much concern with regard to safety of the technique as to the risk of malformations in the offspring (Niemitz and Feinberg 2004). However, since then, the large-scale experience has demonstrated that, apart from those cases in which male infertility has a definite genetic background as depicted above, this treatment is not associated with a major risk of malformation in the offspring. The incidence of neonatal malformations must be seen with respect to the condition of infertility, which by itself pertains to a higher health risk to the offspring, and the current trend to delaying childbearing to later in life.

Despite these comforting findings, close observation of the outcome of assisted reproduction, of ICSI in particular, have revealed some risks, which must be communicated:

- In couples, treated with ICSI because of severe male infertility, a higher risk of de novo chromosomal abnormalities in the offspring, particularly of the sex chromosomes, has been observed (Meschede and Horst 1997; Meschede et al. 2000).
- The neonatal birth weight of children, conceived after assisted reproduction, particularly IVF and ICSI, but lesser so after IUI and after the replacement of frozen/thawed oocytes or embryos, has been demonstrated to be significantly lower (De Geyter et al. 2006) and this difference becomes more pronounced in singleton deliveries, which were characterized by the presence of a vanishing multiple during early pregnancy (De Geyter et al. 2006; Pinborg et al. 2007). Although the cause of this phenomenon is unknown, it may be related to the current policy of replacing more than one embryo per cycle (De Sutter et al. 2006).
- The occurrence of rare imprinting disorders causing the Angelman syndrome, Prader-Labhard-Willi syndrome, Beckwith-Wiedemann syndrome and the Silver-Russell syndrome (Sutcliffe et al. 2006; Kagami et al. 2007) in children conceived with assisted reproduction (both IVF and ICSI) has raised some concern, although the conclusions remain controversially discussed (Doornbos et al. 2007; Bowdin et al. 2007). The utterly low incidence of these syndromes requires very large cohort studies to verify such a relationship. Retrospective cohort studies in patients suffering from the Beckwith-Wiedemann syndrome indicated a high prevalence of previous treatments with assisted reproduction (Gosden et al. 2003). In contrast, an Australian study estimated the incidence risk at one diseased child out of 4,000 newborns after assisted reproduction (Halliday et al. 2004). Although animal research has established a link between culture of embryos in vitro with imprinting disorders in the offspring (Maher 2005), more long-term follow-up studies are necessary to quantify such an association in clinical assisted reproduction.

Various studies have examined the intellectual and psychomotoric development of children conceived with assisted reproduction and compared their performances with those of children conceived naturally. Although single studies have reported significant differences (Bowen et al. 1998), most other studies have not been able to confirm these, particularly those

focussing on children at various ages of development (**at 2 years:** Bonduelle et al. 1998; **at 5 years:** Ponjaert-Kristoffersen et al. 2005; **at 8 years:** Leunens et al. 2006; Belva et al. 2007). Most studies have come to the conclusions that most of the observed differences among the study groups were caused by prematurity of children arising from multiple pregnancy achieved with assisted reproduction and by the higher educational level of many of the parents with children born after assisted fertilization.

References

- Abdelmassih R, Sollia S, Moretto M, Acosta AA (1996) Female age is an important parameter to predict treatment outcome in intracytoplasmic sperm injection. *Fertil Steril* 65: 573–577
- Aboulghar MA, Mansour RT, Serour GI, Amin YM, Kamal A (1996) Prospective controlled randomized study of in vitro fertilization versus intracytoplasmic sperm injection in the treatment of tubal factor infertility with normal semen parameters. *Fertil Steril* 66:753–756
- Abou-Setta AM, Mansour RT, Al-Inany HG, Aboulghar MM, Aboulghar MA, Serour GI (2007) Among women undergoing embryo transfer, is the probability of pregnancy and live birth improved with ultrasound guidance over clinical touch alone? A systematic review and meta-analysis of prospective studies. *Fertil Steril* 88:333–341
- Ainsworth C, Nixon B, Aitken RJ (2005) Development of a novel electrophoretic system for the isolation of human spermatozoa. *Hum Reprod* 20:2261–2270
- Ainsworth C, Nixon B, Jansen RPS, Aitken RJ (2007) First recorded pregnancy and normal birth after ICSI using electrophoretically isolated spermatozoa. *Hum Reprod* 22: 197–200
- Aitken RJ, Mattei A, Irvine S (1986) Paradoxical stimulation of human motility by 2-deoxyadenosine. *J Reprod Fertil* 78: 515–527
- Al-Inany HG, Abou-Setta AM, Aboulghar M (2007) Gonadotrophin-releasing hormone antagonists for assisted conception: a Cochrane review. *Reprod Biomed Online* 14: 640–649
- Andersen AN, Gianaroli L, Felberbaum R, de Mouzon J, Nygren KG, The European IVF-monitoring programme (EIM), European Society of Human Reproduction and Embryology (ESHRE) (2005) Assisted reproductive technology in Europe, 2001. Results generated from European registers by ESHRE. *Hum Reprod* 20:1158–1176
- Andersen AN, Gianaroli L, Felberbaum R, de Mouzon J, Nygren KG, The European IVF-monitoring programme (EIM) for the European Society of Human Reproduction and Embryology (ESHRE) (2006) Assisted reproductive technology in Europe, 2002. Results generated from European registers by ESHRE. *Hum Reprod* 21:1680–1697
- Andersen AN, Goossens V, Ferraretti AP, Bhattacharya S, Felberbaum R, de Mouzon J, Nygren KG, European IVF-monitoring (EIM) Consortium, European Society of Human Reproduction and Embryology (ESHRE) (2008) Assisted reproductive technology in Europe, 2004: results generated from European registers by ESHRE. *Hum Reprod* 23: 756–771
- Antinori S, Versaci C, Antinori M, Selman HA (1997) Successful fertilization and pregnancy after injection of frozen-thawed round spermatids into human oocytes. *Hum Reprod* 12: 554–556
- Balaban B, Urman B, Sertac A, Alatas C, Aksoy S, Mercan R, Nuhoglu A (1999) In-vitro culture of spermatozoa induces motility and increases implantation and pregnancy rates after testicular sperm extraction and intracytoplasmic sperm injection. *Hum Reprod* 14:2808–2811
- Balakier H, Sojecki A, Motamedi G, Librach C (2004) Time-dependent capability of human oocytes for activation and pronuclear formation during metaphase II arrest. *Hum Reprod* 19:982–987
- Battaglia DE, Koehler JK, Klein NA, Tucker MJ (1997) Failure of oocyte activation after intracytoplasmic sperm injection using round-headed sperm. *Fertil Steril* 68:118–122
- Belva F, Henriët S, Liebaers I, Van Steirteghem A, Celestin-Westreich S, Bonduelle M (2007) Medical outcome of 8-year-old singleton ICSI children (born ≥ 32 weeks' gestation) and a spontaneously conceived comparison group. *Hum Reprod* 22:506–515
- Benoff S, Cooper GW, Paine T, Hurley IR, Napolitano B, Jacob A, Scholl GM, Hershlag A (1999) Numerical dose-compensated in vitro fertilization inseminations yield high fertilization and pregnancy rates. *Fertil Steril* 71:1019–1028
- Bensdorp AJ, Cohlen BJ, Heinman MJ, Vandekerckhove P (2007) Intra-uterine insemination for male subfertility. *Cochrane Database Syst Rev* 4:CD000360
- Ben-Yosef D, Yogev L, Hauser R, Yavetz H, Azem F, Yovel I, Lessing JB, Amit A (1999) Testicular sperm retrieval and cryopreservation prior to initiating ovarian stimulation as the first line approach in patients with non-obstructive azoospermia. *Hum Reprod* 14:1794–1801
- Berger T, Marrs RP, Moyer DL (1985) Comparison of techniques for selection of motile spermatozoa. *Fertil Steril* 43: 268–273
- Bhattacharya S, Hamilton MPR, Shaaban M, Khalaf Y, Seddler M, Ghobara T, Braude P, Kennedy R, Rutherford A, Hartshorne G, Templeton A (2001) Conventional in-vitro fertilisation versus intracytoplasmic sperm injection for the treatment of non-male-factor infertility: a randomised controlled trial. *Lancet* 357:2075–2079
- Bonde JPE, Ernst E, Jensen TK, Hjollund NH, Kolstad H, Henriksen TB, Schelke T, Giwercman A, Olsen J, Skakkebaek NE (1998) Relation between semen quality and fertility: a population-based study of 430 first-pregnancy planners. *Lancet* 352:1172–1177
- Bonduelle M, Joris H, Hofmans K, Liebaers I, Van Steirteghem AC (1998) Mental development of 201 ICSI children at 2 years of age. *Lancet* 351:1553
- Boomsma CM, Heineman MJ, Cohlen BJ, Farquhar C (2007) Semen preparation techniques for intrauterine insemination. *Cochrane Database Syst Rev* 4:CD004507
- Bostofte E, Serup J, Rebbe H (1982) Relation between sperm count and semen volume and pregnancies obtained during a twenty year follow up period. *Int J Androl* 5:167–175

- Bostofte E, Serup J, Rebbe H (1983) Relation between spermatozoa motility and pregnancies obtained during a twenty-year follow-up period spermatozoa motility and fertility. *Andrologia* 15:682–686
- Botchan A, Hauser R, Gamzu R, Yogev L, Paz G, Yavetz H (2001) Results of 6139 artificial insemination cycles with donor spermatozoa. *Hum Reprod* 16:2298–2304
- Bourne H, Liu DY, Clarke GN, Baker GHW (1995) Normal fertilization and embryo development by intracytoplasmic sperm injection of round-headed acrosomeless sperm. *Fertil Steril* 63:1329–1332
- Bowdin S, Allen C, Kirby G, Brueton L, Afnan M, Barratt C, Kirkman-Brown J, Harrison R, Maher ER, Reardon W (2007) A survey of assisted reproductive technology births and imprinting disorders. *Hum Reprod* 22:3237–3240
- Bowen JR, Gibson FL, Leslie GI, Saunders DM (1998) Medical and developmental outcome at 1 year for children conceived by intracytoplasmic sperm injection. *Lancet* 351:1529–1534
- Bujan L, Hollander L, Coudert M, Gilling-Smith C, Vucetich A, Guibert J, Vernazza P, Ohl J, Weigel M, Englert Y, Semprini AE (2007) Safety and efficacy of sperm washing in HIV-1-serodiscordant couples where the male is infected: results from the European CREAThE network. *AIDS* 21:1909–1914
- Bukulmez O, Yarali H, Yucel A, Sari T, Gurgan T (2000) Intracytoplasmic sperm injection versus in vitro fertilization for patients with a tubal factor as their sole cause of infertility: a prospective, randomized trial. *Fertil Steril* 73:38–42
- Byrd W, Bradshaw K, Carr B, Edman C, Odum J, Ackerman G (1990) A prospective randomized study of pregnancy rates following intrauterine and intracervical insemination using frozen donor sperm. *Fertil Steril* 53:521–527
- Callahan TL, Hall JE, Ettner SL, Christiansen CL, Greene MF, Crowley Jr WF (1994) The economic impact of multiple-gestation pregnancies and the contribution of assisted-reproduction techniques to their incidence. *N Engl J Med* 331:244–249
- Campos-Liete E, Insull M, Kennedy SH, Ellis JD, Sargent I, Barlow DH (1992) A controlled assessment of direct intraputoneal insemination. *Fertil Steril* 57:168–173
- Cantineau AEP, Cohlen BJ, Heineman MJ (2007) Ovarian stimulation protocols (anti-oestrogens, gonadotrophins with and without GnRH agonists/antagonists) for intrauterine insemination (IUI) in women with subfertility (Review). *Cochrane Database Syst Rev* CD005356
- Casper RF, Meriano JS, Jarvi KA, Cowan L, Lucato ML (1996) The hypo-osmotic swelling test for selection of viable sperm for intracytoplasmic sperm injection in men with complete asthenozoospermia. *Fertil Steril* 65:972–976
- Catt JW, Ryan JP, Pike IL, Porter R, Saunders DM (1996) Successful pregnancy after fertilization using intracytoplasmic sperm injection of sperm lacking acrosomes. *Aust NZ J Obstet Gynecol* 36:61–62
- Cicinelli E, De Ziegler D, Bulletti C, Matteo MG, Schonauer LM, Galantino P (2000) Direct transport of progesterone from vagina to uterus. *Obstet Gynecol* 95:403–406
- Cohen J, Alikani M, Trowbridge J, Rosenwaks Z (1992) Implantation enhancement by selective assisted hatching using zona drilling of human embryos with poor prognosis. *Hum Reprod* 7:685–691
- Cohlen BJ (2004) Should we continue performing intrauterine inseminations in the year 2004? *Gynecol Obstet Invest* 59:3–13
- Cohlen BJ, te Velde ER, van Kooij RJ, Looman CWN, Habbema JD (1998) Controlled ovarian hyperstimulation and intrauterine insemination for treating male subfertility: a controlled study. *Hum Reprod* 13:1553–1558
- Collins JA, Wrixon W, Janes LB, Wilson EH (1983) Treatment-independent pregnancy among infertile couples. *N Engl J Med* 309:1201–1206
- Collins JA, Burrows EA, Willan AR (1995) The prognosis for live birth among untreated infertile couples. *Fertil Steril* 64:22–28
- Cooper TG, Keck C, Oberdieck U, Nieschlag E (1993) Effects of multiple ejaculations after extended periods of sexual abstinence on total, motile and normal sperm numbers, as well as accessory gland secretions, from healthy normal and oligozoospermic men. *Hum Reprod* 8:1251–1258
- Craft I, Tsirigotis M, Bennett V, Taranissi M, Khalifa Y, Hogewind G, Nicholson N (1995) Percutaneous epididymal sperm aspiration and intracytoplasmic sperm injection in the management of infertility due to obstructive azoospermia. *Fertil Steril* 63:1038–1042
- Crosignani PG, Walters PE, Soliani A (1991) The ESHRE multicentre trial on the treatment of unexplained infertility: a preliminary report. *Hum Reprod* 6:953–958
- Daniels K (2007) Anonymity and openness and the recruitment of gamete donors. Part I: semen donors. *Hum Fertil* 10:151–158
- Daya S, Gunby J (2004) Luteal phase support in assisted reproduction cycles. *Cochrane Database Syst Rev* CD004830
- Daya S, Gwatkin RBL, Bissessar H (1987) Separation of motile human spermatozoa by means of a glass bead column. *Gamete Res* 17:375–380
- De Geyter Ch (1994) Sterilitätstherapie in der Prämenopause. *Therapeutische Umschau: Prä- und Postmenopause*. 51:773–777
- De Geyter Ch, Bals-Pratsch M, Dören M, Yeung CH, Grunert JH, Bordt J, Schneider HPG, Nieschlag E (1988) Human and bovine cervical mucus penetration as a test of sperm function for in-vitro fertilization. *Hum Reprod* 3:948–954
- De Geyter Ch, De Geyter M, Castro E, Bals-Pratsch M, Nieschlag E, Schneider HPG (1996) Experience with transvaginal ultrasound-guided aspiration of supernumerary follicles for the prevention of multiple pregnancies after ovulation induction and intrauterine insemination. *Fertil Steril* 65:1163–1168
- De Geyter Ch, De Geyter M, Koppers B, Nieschlag E (1998) Diagnostic accuracy of computer-assisted sperm motion analysis. *Hum Reprod* 13:2512–2520
- De Geyter Ch, De Geyter M, Steimann S, Zhang H, Holzgreve W (2006) Comparative birth weights of singletons born after assisted reproduction and natural conception in previously infertile women. *Hum Reprod* 21:705–712
- De Jonge C, LaFromboise M, Bosmans E, Ombelet W, Cox A, Nijs M (2004) Influence of abstinence period on human sperm quality. *Fertil Steril* 82:57–65
- De Sutter P, Delbaere I, Gerris J, Verstraelen H, Goetgeluk S, Van der Elst J, Temmerman M, Dhont M (2006) Birthweight of singletons after assisted reproduction is higher after single- than after double-embryo transfer. *Hum Reprod* 21:2633–2637
- De Vos A, Van de Velde H, Joris H, Van Steirteghem A (1999) In-vitro matured metaphase-I oocytes have a lower fertilization rate but similar embryo quality as mature metaphase-II oocytes after intracytoplasmic sperm injection. *Hum Reprod* 14:1859–1863

- Delvigne A, Rosenberg S (2002) Epidemiology and prevention of ovarian hyperstimulation syndrome (OHSS): a review. *Hum Reprod Update* 8:559–577
- Delvigne A, Rosenberg S (2003) Review of clinical course and treatment of ovarian hyperstimulation syndrome (OHSS) *Hum Reprod Update* 9:77–96
- Devroey P, Liu J, Nagy Z, Tournaye H, Silber SJ, Van Steirteghem AC (1994) Normal fertilization of human oocytes after testicular sperm extraction and intracytoplasmic sperm injection. *Fertil Steril* 62:639–641
- Diedrich K, Diedrich C, Santos E, Zoll C, Al-Hasani S, Reissmann T, Krebs D, Klingmüller D (1994) Suppression of the endogenous luteinizing hormone surge by the gonadotrophin-releasing hormone antagonist Cetrorelix during ovarian stimulation. *Hum Reprod* 9:788–791
- D.I.R (2007) Das Deutsche IVF-Register (D.I.R.). *J Reproduktionsmed Endokrinol* 5:45–48
- Dirnfeld M, Bider D, Koifman M, Calderon I, Abramovici H (1999) Shortened exposure of oocytes to spermatozoa improves in-vitro fertilization outcome: a prospective, randomized, controlled study. *Hum Reprod* 14:2562–2564
- Doornbos ME, Maas SM, McDonnell J, Vermeiden JPW, Hennekam RCM (2007) Infertility, assisted reproduction technologies and imprinting disturbances: a Dutch study. *Hum Reprod* 22:2476–2480
- Dor J, Lerner-Geva L, Rabinovici J, Chetrit A, Levran D, Lunenfeld B, Mashiah S, Modan B (2002) Cancer incidence in a cohort of infertile women who underwent in vitro fertilization. *Fertil Steril* 77:324–327
- Duncan WW, Glew MJ, Wang XJ, Flaherty SP, Matthews CD (1993) Prediction of in vitro fertilization rates from semen variables. *Fertil Steril* 59:1233–1238
- Edwards RG (1981) Test-tube babies, 1981. *Nature* 293:253–256
- Empereire JC, Gauzère-Soumireu E, Audebert AJM (1982) Female fertility and donor insemination. *Fertil Steril* 37:90–93
- Englert Y, Van den Bergh M, Rodesch C, Bertrand E, Biramane J, Legreve A (1992) Comparative auto-controlled study between swim-up and Percoll preparation of fresh semen samples for in-vitro fertilization. *Hum Reprod* 7:399–402
- Fischer R, Baukloh V, Naether OGJ, Schulze W, Salzbrunn A, Benson DM (1996) Pregnancy after intracytoplasmic sperm injection of spermatozoa extracted from frozen-thawed testicular biopsy. *Hum Reprod* 11:2197–2199
- Flaherty SP, Payne D, Matthews CD (1998) Fertilization failures and abnormal fertilization after intracytoplasmic sperm injection. *Hum Reprod* 13(Suppl 1):155–164
- Forrler A, Dellenbach P, Nisand I, Moreau L, Cranz C, Clavert A, Rumpler Y (1986) Direct intraperitoneal insemination in unexplained and cervical infertility. *Lancet* 2:916
- Francavilla F, Romano R, Santucci R, Marrone V, Corrao G (1992) Failure of intrauterine insemination in male immunological infertility in cases in which all spermatozoa are antibody-coated. *Fertil Steril* 58:587–591
- Fugger EF, Black SH, Keyvanfar K, Schulman JD (1998) Births of normal daughters after MicroSort sperm separation and intrauterine insemination, in-vitro fertilization, or intracytoplasmic sperm injection. *Hum Reprod* 13:2367–2370
- Gauthier E, Paoletti X, Clavel-Chapelon F, E3N Group (2004) Breast cancer risk associated with being treated for infertility: results from the French E3N cohort study. *Hum Reprod* 19:2216–2221
- Gelbaya TA, Kyrgiou M, Tsoumpou I, Nardo L (2008) The use of estradiol for luteal phase support in in vitro fertilization/intracytoplasmic sperm injection cycles: a systematic review and meta-analysis. *Fertil Steril* (Epub ahead of print)
- Gerris J, De Neubourg D, Mangelschots K, Van Royen E, Van de Meerssche M, Valenburg M (1999) Prevention of twin pregnancy after in-vitro fertilization or intracytoplasmic sperm injection based on strict embryo criteria: a prospective randomized clinical trial. *Hum Reprod* 14:2581–2587
- Gerris J, De Neubourg D, Mangelschots K, Van Royen E, Vercruyssen M, Barudy-Vasquez J, Valkenburg M, Ryckaert G (2002) Elective single day 3 embryo transfer halves the twinning rate without decrease in the ongoing pregnancy rate of an IVF/ICSI programme. *Hum Reprod* 17:2626–2631
- Gjerris AC, Loft A, Pinborg A, Christiansen M, Tabor A (2008) Prenatal testing among women pregnant after assisted reproductive techniques in Denmark 1995–2000: a national cohort study. *Hum Reprod* 23(7):1545–1552
- Gosden R, Trasler J, Lucifero D, Faddy (2003) Rare congenital disorders, imprinted genes, and assisted reproductive technology. *Lancet* 361:1975–1977
- Goverde AJ, McDonnell J, Vermeiden JP, Schats R, Rutten FF, Schoemaker J (2000) Intrauterine insemination or in-vitro fertilisation in idiopathic subfertility and male subfertility: a randomised trial and cost-effectiveness analysis. *Lancet* 355:13–18
- Greco E, Scarselli F, Iacobelli M, Rienzi L, Ubaldi F, Ferrero S, Franco G, Anniballo N, Mendoza C, Tesarik J (2005) Efficient treatment of infertility due to sperm DNA damage by ICSI with testicular spermatozoa. *Hum Reprod* 20:226–230
- Griesinger G, Felberbaum R, Diedrich K (2005) GnRH antagonists in ovarian stimulation: a treatment regimen of clinicians' second choice? Data from the German national IVF registry. *Hum Reprod* 20:2373–2375
- Grossmann M, Calafell JM, Brandy N, Vanrell JA, Rubio C, Pellicer A, Egozcue J, Vidal F, Santaló J (1997) Origin of triplo-nucleate zygotes after intracytoplasmic sperm injection. *Hum Reprod* 12:2762–2765
- Grünwald S, Miska W, Miska G, Rasch M, Reinhardt M, Glander H-J, Paasch U (2007) Molecular glass wool filtration as a new tool for sperm preparation. *Hum Reprod* 22:1405–1412
- Guérin JF, Mathieu C, Lornage J, Pinatel MC, Bouliou D (1989) Improvement of survival and fertilizing capacity of human spermatozoa in an IVF programme by selection on discontinuous Percoll gradients. *Hum Reprod* 4:798–804
- Guzik DS, Carson SA, Coutifaris C, Overstreet JW, Factor-Litvak P, Steinkampf MP, Hill JA, Mastroianni L, Buster JE, Nakajima ST, Vogel DL, Canfield RE (1999) Efficacy of superovulation and intrauterine insemination in the treatment of infertility. National Cooperative Reproductive Medicine Network. *N Engl J Med* 340:177–183
- Hallyday J, Oke K, Breneny S, Algar E, Amor D (2004) Beckwith-Wiedemann syndrome and IVF: a case-control study. *Am J Hum Genet* 75:526–528
- Han TL, Flaherty SP, Ford JH, Matthews CD (1993) Detection of X- and Y-bearing human spermatozoa after motile sperm isolation by swim-up. *Fertil Steril* 60:1046–1050
- Henkel RR, Schill W-B (2003) Sperm preparation for ART. *Reprod Biol Endocrinol* 1:108–120
- Herman A, Raziel A, Strassburger D, Soffer Y, Bukovsky I, Ron-El R (1996) The benefits of mid-luteal addition of

- human chorionic gonadotrophin in in-vitro fertilization using a down-regulation protocol and luteal support with progesterone. *Hum Reprod* 11:1552–1557
- Hershlag A, Paine T, Cooper GW, Scholl GM, Rawlinson K, Kvapil G (1999) Monozygotic twinning associated with mechanical assisted hatching. *Fertil Steril* 71:145–146
- Hershlag A, Paine T, Kvapil G, Feng H, Napolitano (2002) In vitro fertilization-intracytoplasmic sperm injection split: an insemination method to prevent fertilization failure. *Fertil Steril* 77:229–232
- Hewitson L, Dominko T, Takahashi D, Martinovich C, Ramalho-Santos J, Sutovsky P, Fanton J, Jacob D, Monteith D, Neuringer M, Battaglia D, Simerly C, Schatten G (1999) Unique checkpoints during the first cell cycle of fertilization after intracytoplasmic sperm injection in rhesus monkeys. *Nat Med* 5:431–433
- Hovatta O, Kurunmäki H, Tiitinen A, Lähteenmäki P, Koskimies AI (1990) Direct intraperitoneal or intrauterine insemination and superovulation in infertility treatment: a randomized study. *Fertil Steril* 54:339–341
- Hull MGR (1992) Infertility treatment: relative effectiveness of conventional and assisted conception methods. *Hum Reprod* 7:785–796
- Hurd WW, Randolph Jr. JF, Ansbacher R, Menge AC, Ohl DA, Brown AN (1993) Comparison of intracervical, intrauterine, and intratubal techniques for donor insemination. *Fertil Steril* 59:339–342
- Hutchinson-Williams KA, Lunenfeld B, Diamond MP, Lavy G, Boyers SP, DeCherney AH (1989) Human chorionic gonadotropin, estradiol, and progesterone profiles in conception and nonconception cycles in an in vitro fertilization program. *Fertil Steril* 52:441–445
- Hyun C-S, Cha J-H, Son W-Y, Yoon S-H, Kim K-A, Lim J-H (2007) Optimal ICSI timing after the first polar body extrusion in in vitro matured human oocytes. *Hum Reprod* 22:1991–1995
- Imoedemhe DAG, Sique AB, Pacpaco ELA, Olazo AB (1992) The effect of caffeine on the ability of spermatozoa to fertilize mature human oocytes. *J Assist Reprod Genet* 9:155–160
- Irvine DS, Twigg JP, Gordon EL, Fulton N, Milne PA, Aitken RJ (2000) DNA integrity in human spermatozoa: relationships with semen quality. *J Androl* 21:33–44
- Jain JK, Boostanfar R, Slater CC, Francis MM, Paulson RJ (2004) Monozygotic twins and triplets in association with blastocyst transfer. *J Assist Reprod Genet* 21:103–107
- Jain T, Gupta RS (2007) Trends in the use of intracytoplasmic sperm injection in the United States. *N Engl J Med* 357:251–257
- Jansen RPS, Anderson JC (1987) Catheterisation of the fallopian tubes from the vagina. *Lancet* 2:309–310
- Johnson LA, Welch GR, Keyvanfar K, Dorfmann A, Fugger EF, Schulman JD (1993) Gender preselection in humans? Flow cytometric separation of X and Y spermatozoa for the prevention of X-linked diseases. *Hum Reprod* 8:1733–1739
- Kagami M, Nagai T, Fukami M, Yamazawa K, Ogata T (2007) Silver-Russell syndrome in a girl born after in vitro fertilization: partial hypermethylation at the differentially methylated region of *PEG1/MEST*. *J Assist Reprod Genet* 24:131–136
- Kahn JA, Sunde A, Koskemies A, von Düring V, Sordal T, Christensen F, Molne K (1993) Fallopian tube sperm perfusion (FSP) versus intra-uterine insemination (IUI) in the treatment of unexplained infertility: a prospective randomized study. *Hum Reprod* 8:890–894
- Kahraman S, Isik AZ, Vicdan K, Özgür S, Özgün OD (1997) A healthy birth after intracytoplasmic sperm injection by using immotile testicular spermatozoa in a case with totally immotile ejaculated spermatozoa before and after Percoll gradients. *Hum Reprod* 12:292–293
- Kallén B, Finnström O, Nygren KG, Otterblad Olausson P, Wennerholm U-B (2005) In vitro fertilisation in Sweden: obstetric characteristics, maternal morbidity and mortality. *BJOG* 112:1529–1535
- Kamischke A, Nieschlag E (1999) Treatment of retrograde ejaculation and anejaculation. *Hum Reprod Update* 5:448–474
- Karlström PO, Bergh C (2007) Reducing the number of embryos transferred in Sweden – impact on delivery and multiple birth rates. *Hum Reprod* 22:2202–2207
- Kastrop PMM, Weima SM, Van Kooij RJ, Te Velde ER (1999) Comparison between intracytoplasmic sperm injection and in-vitro fertilization (IVF) with high insemination concentration after total fertilization failure in a previous IVF attempt. *Hum Reprod* 14:65–69
- Katalinic A, Rösch C, Ludwig M for the German ICSI follow-up study group (2004) Pregnancy course and outcome after intracytoplasmic sperm injection: a controlled, prospective cohort study. *Fertil Steril* 81:1604–1616
- Katayama KP, Stehlik E, Jeyendran RS (1989) In vitro fertilization outcome: glass wool-filtered sperm versus swim-up. *Fertil Steril* 52:670–672
- Kato O, Takatsuka R, Asch RH (1993) Transvaginal-transmyometrial embryo transfer: the Towako method; experiences of 104 cases. *Fertil Steril* 59:51–53
- Katzorke Th (2008) Entstehung und Entwicklung der Spendersamenbehandlung in Deutschland. *J Reproduktionsmed Endokrinol* 5:14–20
- Kaushal M, Baxi A (2007) Birth after intracytoplasmic sperm injection with use of testicular sperm from men with Karthagener or immotile cilia syndrome. *Fertil Steril* 88:497.e9–497.e11
- Kay VJ, Coutts JRT, Robertson L (1993) Pentoxifylline stimulates hyperactivation in human spermatozoa. *Hum Reprod* 8:727–731
- Konc J, Kanyó K, Cseh S (2004) Visualization and examination of the meiotic spindle in human oocytes with Polscope. *J Assist Reprod Genet* 21:349–353
- Kovačić B, Vlasisavljevic V, Reljic M (2006) Clinical use of pentoxifylline for activation of immotile testicular sperm before ICSI in patients with azoospermia. *J Androl* 27:45–52
- Kristiansson P, Björ O, Wramsby H (2007) Tumour incidence in Swedish women who gave birth following IVF treatment. *Hum Reprod* 22:421–426
- Leeton J, Roger P, Caro C, Healy D, Yates C (1987) A controlled study between the use of gamete intrafallopian transfer (GIFT) and in vitro fertilization and embryo transfer in the management of idiopathic and male infertility. *Fertil Steril* 48:605–607
- Léridon H, Spira A (1984) Problems in measuring the effectiveness of infertility therapy. *Fertil Steril* 41:580–586
- Lerner-Geva L, Geva E, Lessing JB, Chetrit A, Modan B, Amit A (2003) The possible association between in vitro fertilization treatments and cancer development. *Int J Gynecol Cancer* 13:23–27

- Leunens L, Celestin-Westreich S, Bonduelle M, Liebaers I, Ponjaert-Kristoffersen I (2006) Cognitive and motor development of 8-year-old children born after ICSI compared to spontaneously conceived children. *Hum Reprod* 21:2922–2929
- Levrán D, Nahum H, Farhi J, Weissman A (2000) Poor outcome with round spermatid injection in azoospermic patients with maturation arrest. *Fertil Steril* 74:443–449
- Lewin A, Reubinoff B, Poratz-Katz A, Weiss D, Eisenberg V, Arbel R, Bar-el H, Safran A (1999) Testicular fine needle aspiration: the alternative method for sperm retrieval in non-obstructive azoospermia. *Hum Reprod* 14:1785–1790
- Liu J, Nagy Z, Joris H, Tournaye H, Devroey P, Van Steirteghem AC (1995) Successful fertilization and establishment of pregnancies after intracytoplasmic sperm injection in patients with globozoospermia. *Hum Reprod* 10:626–629
- Liu J, Tsai Y-L, Katz E, Compton G, Garcia JE, Baramki TA (1997) High fertilization rate obtained after intracytoplasmic sperm injection with 100% nonmotile spermatozoa selected by using a simple modified hypo-osmotic swelling test. *Fertil Steril* 68:373–375
- Lombardi F, Gandini L, Dondero F, Lenzi A (2001) Immunology and immunopathology of the male genital tract. Antisperm immunity in natural and assisted reproduction. *Hum Reprod* 7:450–456
- Lopata A (1979) Effects of human seminal plasma on fertilizing capacity of human spermatozoa. *Fertil Steril* 31:321–327
- Lopata A, Patullo MJ, Chang A, James B (1976) A method for collecting motile spermatozoa from human semen. *Fertil Steril* 27:677–684
- Ludwig M, Al-Hasani S, Felberbaum R, Diedrich K (1999) New aspects of cryopreservation of oocytes and embryos in assisted reproduction and future perspectives. *Hum Reprod* 14(1):162–185
- Ludwig M, Katalinic A for the German ICSI follow-up study group (2003) Pregnancy course and health of children born after ICSI depending on parameters of male factor infertility. *Hum Reprod* 18:351–357
- Lundin K, Sjögren A, Nilsson L, Hamberger L (1994) Fertilization and pregnancy after intracytoplasmic microinjection of acrosomeless spermatozoa. *Fertil Steril* 62:1266–1267
- Maher ER (2005) Imprinting and assisted reproductive technology. *Hum Mol Genet* 14(1):R133–R138
- Mahutte NG, Arikci A (2003) Failed fertilization: is it predictable? *Curr Opin Obstet Gynecol* 15:211–218
- Meschede D, Horst J (1997) Sex chromosomal anomalies in pregnancies conceived through intracytoplasmic sperm injection - a case for genetic counselling. *Hum Reprod* 12:1125–1127
- Meschede D, Lemcke B, Behre HM, De Geyter Ch, Nieschlag E, Horst J (2000) Non-reproductive heritable disorders in infertile couples and their first degree relatives. *Hum Reprod* 15:1609–1612
- Moreno C, Ruiz A, Simón C, Pellicer A, Remohí J (1998) Intracytoplasmic sperm injection as a routine indication in low responder patients. *Hum Reprod* 13:2126–2129
- Morris DS, Dunn RL, Schuster TG, Ohi DA, Smith GD (2007) Ideal culture time for improvement of sperm motility from testicular sperm aspirates of men with azoospermia. *J Urol* 178:2087–2091
- Nagy ZP, Liu J, Joris H, Bocken G, Desmet B, Van Ranst H, Vankelecom A, Devroey P, Van Steirteghem AC (1995) The influence of the site of sperm deposition and mode of oolemma breakage at intracytoplasmic sperm injection on fertilization and embryo development rates. *Hum Reprod* 10:3171–3177
- Nicopoulos JD, Gilling-Smith C, Almeida PA, Norman-Taylor J, Grace I, Ramsay JW (2004) Use of surgical sperm retrieval in azoospermic men: a meta-analysis. *Fertil Steril* 82:691–701
- Niemitz EL, Feinberg AP (2004) Epigenetics and assisted reproductive technology: a call for investigation. *Am J Hum Genet* 74:599–609
- Nijs M, Vanderzwalmen P, Vandamme B, Segal-Bertin G, Lejeune B, Segal L, van Roosendaal E, Schoysman R (1996) Fertilizing ability of immotile spermatozoa after intracytoplasmic sperm injection. *Hum Reprod* 11:2180–2185
- Nuojua-Huttunen S, Tuomivaara L, Juntunen K, Tomás C, Kauppila A, Martikainen H (1995) Intrafollicular insemination for the treatment of infertility. *Hum Reprod* 10:91–93
- Nyboe Anderson A, Popovic-Todorovic B, Schmidt KT, Loft A, Lindhard A, Højgaard A, Ziebe S, Hald F, Hauge B, Toft B (2002) Progesterone supplementation during early gestations after IVF or ICSI has no effect on the delivery rates: a randomized controlled trial. *Hum Reprod* 17: 357–361
- Nygren KG, Andersen AN (2001a) Assisted reproductive technology in Europe, 1997. Results generated from European registers by ESHRE. European IVF-Monitoring Programme (EIM), for the European Society of Human Reproduction and Embryology (ESHRE). *Hum Reprod* 16:384–391
- Nygren KG, Andersen AN, European IVF-monitoring programme (EIM) (2001b) Assisted reproductive technology in Europe, 1998. Results generated from European registers by ESHRE. European Society of Human Reproduction and Embryology. *Hum Reprod* 16:2459–2471
- Oei ML, Surrey ES, McCaleb B, Kerin JF (1992) A prospective, randomized study of pregnancy rates after transuterotubal and intrauterine insemination. *Fertil Steril* 58:167–171
- Olivennes E, Fanchin R, Bouchard P, De Ziegler D, Taieb J, Selva J, Frydman R (1994) The single or dual administration of the gonadotropin-releasing hormone antagonist Cetrorelix in an in vitro fertilization-embryo transfer program. *Fertil Steril* 62:468–476
- Ombelet W, Bosmans E, Janssen M, Cox A, Vlasselaer J, Gyselaers W, Vandeput H, Gielen J, Pollet H, Maes M, Steeno O, Kruger T (1997) Semen parameters in a fertile versus subfertile population: a need for change in the interpretation of semen testing. *Hum Reprod* 12:987–993
- Ord T, Patrizio P, Marelló E, Balmedica JP, Asch RH (1990) Mini-Percoll: a new method of semen preparation for IVF in severe male factor infertility. *Hum Reprod* 5:987–989
- Palermo G, Joris H, Devroey P, Van Steirteghem AC (1992) Pregnancies after intracytoplasmic sperm injection of single spermatozoon into an oocyte. *Lancet* 340:17–18
- Papanikolaou EG, Camus M, Kolibianakis E, Van Landuyt L, Van Steirteghem A, Devroey P (2006) In vitro fertilization with single blastocyst-stage versus single cleavage-stage embryos. *N Engl J Med* 354:1139–1146
- Pattinson HA, Mortimer D, Curtis EF, Leader A, Taylor PJ (1990) Treatment of sperm agglutination with proteinolytic enzymes. I. Sperm motility, vitality, longevity and successful disagglutination. *Hum Reprod* 5:167–173
- Patton PE, Burry KA, Thurmond A, Novy MJ, Wolf DP (1992) Intrauterine insemination outperforms intracervical insemination in a randomized, controlled study with frozen, donor semen. *Fertil Steril* 57:559–564

- Paulson JD, Polakoski KL (1977) A glass wool column procedure for removing extraneous material from the human ejaculate. *Fertil Steril* 28:178–181
- Payne D, Flaherty SP, Barry MF, Matthews CD (1997) Preliminary observations on polar body extrusion and pronuclear formation in human oocytes using time-lapse video cinematography. *Hum Reprod* 12:532–541
- Peeraer K (2004) Pregnancy after ICSI with ejaculated immotile spermatozoa from a patient with immotile cilia syndrome: a case report and review of the literature. *RBM online* 9:659–663
- Pellinck MJ, Vogel NEA, Hoek A, Simons AHM, Arts EGJM, Mochtar MH, Beemsterboer S, Hondelink MN, Heineman MJ (2006) Cumulative pregnancy rates after three cycles of minimal stimulation IVF and results according to subfertility diagnosis: a multicentre cohort study. *Hum Reprod* 21:2375–2383
- Pellinck MJ, Vogel NEA, Arts EGJM, Simons AHM, Heineman MJ, Hoek A (2007) Cumulative pregnancy rates after a maximum of nine cycles of modified natural cycle IVF and analysis of patient drop-out: a cohort study. *Hum Reprod* 22:2463–2470
- Pickering SJ, Fleming TP, Braude PR, Bolton VN, Gresham GAG (1989) Are human spermatozoa separated on a Percoll density gradient safe for therapeutic use? *Fertil Steril* 51:1024–1029
- Pinborg A, Lidegaard Ø, la Cour Freiesleben N, Nyboe Andersen A (2007) Vanishing twins: a predictor of small-for-gestational age in IVF singletons. *Hum Reprod* 22:2707–2714
- Pisarska MD, Casson PR, Cisneros PL, Lamb DL, Lipshultz LI, Buster JE, Carson SA (1999) Fertilization after standard in vitro fertilization versus intracytoplasmic sperm injection in subfertile males using sibling oocytes. *Fertil Steril* 71:627–632
- Ponjaert-Kristoffersen I, Bonduelle M, Barnes J, Nekkebroeck J, Loft A, Wennerholm U-B, Tarlatzis BC, Peters C, Hagberg BS, Berner A, Sutcliffe AG (2005) International collaborative study of intracytoplasmic sperm injection-conceived, in vitro fertilization-conceived, and naturally conceived 5-year-old child outcomes: cognitive and motor assessments. *Pediatrics* 115:283–289
- Pouly J-L, Bachelot A, de Mouzon J, Devaux A (2004) Comparison of agonists versus antagonists for IVF stimulation: the French FIVNAT survey 2001–2002. *Gynecol Obstet Fertil* 32:737–740
- Primi MP, Senn A, Montag M, Van der Ven H, Mandelbaum J, Veiga A, Barri P, Germond M (2004) A European multicentre prospective randomized study to assess the use of assisted hatching with a diode laser and the benefit of an immunosuppressive/antibiotic treatment in different patient populations. *Hum Reprod* 19:2325–2533
- Ray BD, Howell RT, McDermott A, Hull MGR (1995) Testing the mutagenic potential of polyvinylpyrrolidone and methyl cellulose by sister chromatid exchange analysis prior to use in intracytoplasmic sperm injection procedures. *Hum Reprod* 10:436–438
- Raziel A, Schachter M, Strassburger D, Kasterstein E, Ron-El R, Friedler S (2006) In vivo maturation of oocytes by extending the interval between human chorionic gonadotropin administration and oocyte retrieval. *Fertil Steril* 86:583–587
- Ripps BA, Minhas BS, Carson SA, Buster JE (1994) Intrauterine insemination in fertile women delivers larger numbers of sperm to the peritoneal fluid than intracervical insemination. *Fertil Steril* 61:398–400
- Rovó A, Tichelli A, Passweg JR, Heim D, Meyer-Monard S, Holzgreve W, Gratwohl A, De Geyter C (2006) Spermatogenesis in long-term survivors after allogeneic hematopoietic stem cell transplantation is associated with age, time interval since transplantation, and apparently absence of GvHD. *Blood* 108:1100–1105
- Ruiz A, Remohí J, Minguez Y, Guanés PP, Simón C, Pellicer A (1997) The role of in vitro fertilization and intracytoplasmic sperm injection in couples with unexplained infertility after failed intrauterine insemination. *Fertil Steril* 68:171–173
- Rybouchkin AV, Van der Straeten F, Quatacker J, De Sutter P, Dhont M (1997) Fertilization and pregnancy after assisted oocyte activation and intracytoplasmic sperm injection in a case of round-headed sperm associated with deficient oocyte activation capacity. *Fertil Steril* 68:1144–1147
- Sagoskin AW, Levy MJ, Tucker MJ, Richter KS, Widra EA (2007) Laser assisted hatching in good prognosis patients undergoing in vitro fertilization-embryo transfer: a randomized controlled trial. *Fertil Steril* 87:283–287
- Said T, Agarwal A, Grunewald S, Rasch M, Baumann T, Kriegel C, Li L, Glander H-J, Thomas Jr. AJ, Paasch U (2006) Selection of nonapoptotic spermatozoa as a new tool for enhancing assisted reproduction outcomes: an in vitro model. *Biol Reprod* 74:530–537
- Sakkas D, D'Arcy Y, Percival G, Sinclair L, Afnan M, Sharif K (2004) Use of the egg-share model to investigate the paternal influence on fertilization and embryo development after in vitro fertilization and intracytoplasmic sperm injection. *Fertil Steril* 82:74–79
- Savasi V, Ferrazzi E, Lanzani C, Oneta M, Parrilla B, Persico T (2007) Safety of sperm washing and ART outcome in 741 HIV-1-serodiscordant couples. *Hum Reprod* 22:772–777
- Sawyer N, McDonald J (2008) A review of mathematical models used to determine sperm donor limits for infertility treatment. *Fertil Steril* 90:265–271
- Schieve LA (2006) The promise of single-embryo transfer. *N Engl J Med* 354:1190–1193
- Schmidt KLT, Ziebe S, Popovic B, Lindhard A, Loft A, Nyboe Andersen A (2001) Progesterone supplementation during early gestation after in vitro fertilization has no effect on the delivery rate. *Fertil Steril* 75:337–341
- Scholtes MCW, Roozenburg BJ, Verhoeff A, Zeilmaker GH (1994) A randomized study of transcervical intrafallopian transfer of pronucleate embryos controlled by ultrasound versus intrauterine transfer of four- to eight-cell embryos. *Fertil Steril* 61:102–104
- Schulze W, Thoms F, Knuth UA (1999) Testicular sperm extraction: comprehensive analysis with simultaneously performed histology in 1418 biopsies from 766 subfertile men. *Hum Reprod* 14(1):82–96
- Semprini AE, Levi-Setti P, Bozzo M, Ravizza M, Taglioretti A, Sulpizio P, Albani E, Oneti M, Pardi G (1992) Insemination of HIV-negative women with processed semen of HIV-positive partners. *Lancet* 340:1317–1319
- Senn A, Vozzi C, Chanson A, De Grandi P, Germond M (2000) Prospective randomised study of two cryopreservation poli-

- cies avoiding embryo selection: the pronucleate stage leads to a higher cumulative delivery rate than the early cleavage stage. *Fertil Steril* 74:946–952
- Sher G, Zouves C, Feinman M, Maassarani M (1995) 'Prolonged coasting': an effective method for preventing severe ovarian hyperstimulation syndrome in patients undergoing in-vitro fertilization. *Hum Reprod* 10:3107–3109
- Simoni M, Tüttelmann F, Gromoll J, Nieschlag E (2008) Clinical consequences of microdeletions of the Y chromosome: the extended Münster experience. *RBM online* 16:289–303
- Soliman S, Daya S, Collins J, Jarrell J (1993) A randomized trial of in vitro fertilization versus conventional treatment for infertility. *Fertil Steril* 59:1239–1244
- Spira A (1986) Epidemiology of human reproduction. *Hum Reprod* 1:111–115
- Staessen C, Camus M, Claesen K, De Vos A, Van Steirteghem A (1999) Conventional in-vitro fertilization versus intracytoplasmic sperm injection in sibling oocytes from couples with tubal infertility and normozoospermic semen. *Hum Reprod* 14:2474–2479
- Stephote PC (1970) Laparoscopic recovery of preovulatory human oocytes after priming of ovaries with gonadotrophins. *Lancet* 1:683–689
- Strandell A, Lindhard A, Waldenström U, Thorburn J, Janson PO, Hamberger L (1999) Hydrosalpinx and IVF outcome: a prospective, randomized multicentre trial in Scandinavia on salpingectomy prior to IVF. *Hum Reprod* 14:2762–2769
- Sultan KM, Munné S, Palermo GD, Alikani M, Cohen J (1995) Chromosomal status of uni-pronuclear human zygotes following in-vitro fertilization and intracytoplasmic sperm injection. *Hum Reprod* 10:132–136
- Sutcliffe AG, Peters CJ, Bowdin S, Temple K, Reardon W, Wilson L, Clayton-Smith J, Brueton LA, Bannister W, Maher ER (2006) Assisted reproductive therapies and imprinting disorders – a preliminary British survey. *Hum Reprod* 21:1009–1011
- Tan SL, Royston P, Campbell S, Jacobs HS, Betts J, Mason B, Edwards RG (1992) Cumulative conception and livebirth rates after in-vitro fertilization. *Lancet* 1:1390–1394
- Tejera A, Mollá M, Muriel L, Remohí J, Pellicer A, De Pablo JL (2008) Successful pregnancy and childbirth after intracytoplasmic sperm injection with calcium ionophore activation in a globozoospermic patient. *Fertil Steril* 90(4):1202.e1–5
- Terriou P, Hans E, Giorgetti C, Spach JL, Salzmann J, Urrutia V, Roulier R (2000) Pentoxifylline initiates motility in spontaneously immotile epididymal and testicular spermatozoa and allow normal fertilization, pregnancy, and birth after intracytoplasmic sperm injection. *J Assist Fert Genet* 17:194–199
- Tesarik J, Mendosa C (1996) Spermatozoa injection into human oocytes. I. Laboratory techniques and special features of zygote development. *Hum Reprod* 11:772–779
- Tournaye H (1999) Surgical sperm recovery for intracytoplasmic sperm injection: which method is to be preferred? *Hum Reprod* 14(1):71–81
- Tournaye H, Devroey P, Camus M, Staessen C, Bollen N, Smits J, Van Steirteghem AC (1992) Comparison of in-vitro fertilization in male and tubal infertility: a 3 year survey. *Hum Reprod* 7:218–222
- Tournaye H, Liu J, Nagy Z, Verheyen G, Van Steirteghem AC, Devroey P (1996) The use of testicular sperm for intracytoplasmic sperm injection in patients with necrozoospermia. *Fertil Steril* 66:331–334
- Trout SW, Kemmann E (1999) Fallopian sperm perfusion versus intrauterine insemination: a randomized controlled trial and metaanalysis of the literature. *Fertil Steril* 71:881–885
- Tschudin S, Steimann S, Bitzer J, Hösl I, Holzgreve W, Elzi L, Klimkait T, Rudin C, Battegay M, De Geyter Ch (2008) Round-table multidisciplinary counselling approach to couples with HIV prior to assisted reproduction. *Reprod BioMed Online* 17:167–174
- Tur-Kaspa I, Dudkiewicz A, Confino E, Gleicher N (1990) Pooled sequential ejaculates: a way to increase the total number of motile sperm from oligozoospermic men. *Fertil Steril* 54:906–909
- Urman B, Alatas C, Aksoy S, Mercan R, Nuhoglu A, Mumcu A, Isiklar A, Balaban B (2002) Transfer at the blastocyst stage of embryos derived from testicular round spermatid injection. *Hum Reprod* 17:741–743
- Van de Velde H, De Vos A, Joris H, Nagy ZP, Van Steirteghem AC (1998) Effect of timing of oocyte denudation and micro-injection on survival, fertilization and embryo quality after intracytoplasmic sperm injection. *Hum Reprod* 13:3160–3164
- Van den Bergh M, Revelard P, Bertrand E, Biramane J, Vanin A-S, Englert Y (1997) Glass wool column filtration, an advantageous way of preparing semen samples for intracytoplasmic sperm injection: an auto-controlled randomized study. *Hum Reprod* 12:509–513
- Van den Bergh M, Hohl MK, De Geyter Ch, Stalberg AM, Limoni C (2005) Ten years of Swiss National IVF Register FIVNAT-CH. Are we making progress? *Reprod Biomed Online* 11:632–640
- Van der Ven HH, Jeyendran RS, Al-Hasani S, Tännerhoff A, Hoebbel K, Diedrich K, Krebs D, Perez-Palaez M (1988) Glass wool column filtration of human semen: relation to swim-up procedure and outcome of IVF. *Hum Reprod* 3: 85–88
- van der Westerlaken L, Naaktgeboren N, Verburg H, Dieben S, Helmerhorst FM (2006) Conventional in vitro fertilization versus intracytoplasmic sperm injection in patients with borderline semen: a randomized study using sibling oocytes. *Fertil Steril* 85:395–400
- Veleva Z, Vilska S, Hydén-Granskog C, Tiitinen A, Tapanainen JS, Martikainen H (2006) Elective single embryo transfer in women aged 36–39 years. *Hum Reprod* 21:2098–2102
- Venn A, Watson L, Bruinsma F, Giles G, Healy D (1999) Risk of cancer after use of fertility drugs with in-vitro fertilisation. *Lancet* 354:1586–1590
- Verheyen G, Tournaye H, Staessen C, De Vos A, Vandervorst M, Van Steirteghem A (1999) Controlled comparison of conventional in-vitro fertilization and intracytoplasmic sperm injection in patients with asthenozoospermia. *Hum Reprod* 14:2313–2319
- Verheyen G, Vernaeve V, Van Landuyt L, Tournaye H, Devroey P, Van Steirteghem A (2004) Should diagnostic testicular sperm retrieval followed by cryopreservation for later ICSI be the procedure of choice for all patients with non-obstructive azoospermia? *Hum Reprod* 19:2822–2830
- Vidal F, Moragas M, Català V, Torelló MJ, Santaló J, Calderón G, Gimenez C, Barri PN, Egozcue J, Veiga A (1993) Sephadex filtration and human serum albumin gradients do not select spermatozoa by sex chromosome: a fluorescent in-situ hybridization study. *Hum Reprod* 8:1740–1743
- Vilska S, Tiitinen A, Hydén-Granskog C, Hovatta O (1999) Elective transfer of one embryo results in an acceptable

- pregnancy rate and eliminates the risk of multiple birth. *Hum Reprod* 14:2392–2395
- WHO (1999) *Laborhandbuch zur Untersuchung des menschlichen Ejakulates und der Spermien-Zervikalschleim-Interaktion*. 4. Auflage, Springer, Berlin Heidelberg
- Williams DB, Moley KH, Cholewa C, Odem RR, Willand J, Gast MJ (1995) Does intrauterine insemination offer an advantage to cervical cap insemination in a donor insemination program? *Fertil Steril* 63:295–298
- Yovich JM, Edirisinghe WR, Cummins JM, Yovich JL (1990) Influence of pentoxiphylline in severe male factor infertility. *Fertil Steril* 53:715–722

Sabine Kliesch, Axel Kamischke, Trevor G Cooper,
and Eberhard Nieschlag

Contents

24.1	Introduction	506	24.6	Use and Quality of Stored Cryopreserved Semen Samples	515
24.2	History of Cryopreservation of Human Semen	506	24.6.1	Use of Cryopreserved Samples.....	515
24.3	Indications for Cryopreservation of Semen	506	24.6.2	Quality of Stored Cryopreserved Semen Samples.....	516
24.3.1	Fertility Preservation.....	506	24.7	Problems and Limitations of Cryopreservation	517
24.3.2	Infertility Treatment.....	509	24.7.1	Genetic Risks.....	517
24.3.3	Donor Semen.....	511	24.7.2	Psychological Aspects.....	517
24.3.4	Quarantine of Potentially Infected Samples.....	511	24.7.3	Methodological Considerations.....	517
24.3.5	Quality Control of Semen Analysis.....	511	References		518
24.4	Requirements and Risk Assessment for Cryoconservation of Human Semen	511			
24.4.1	Required Resources.....	511			
24.4.2	Risk of Cross-contamination.....	512			
24.4.3	Staff Safety and Protection.....	512			
24.4.4	Labelling of Straws and Records.....	512			
24.5	Preparation of Semen Samples for Cryopreservation	512			
24.5.1	Preparing the Sample.....	512			
24.5.2	Routine Sample Freezing and Cryoprotectants.....	512			
24.5.3	Relative Resistance of Spermatozoa to the Freezing Process.....	513			
24.5.4	Standard Cryoprotectants.....	513			
24.5.5	Adding the Cryoprotectant.....	514			
24.5.6	Closing the Straws.....	514			
24.5.7	Freezing the Samples.....	514			
24.5.8	Storing the Samples.....	515			
24.5.9	Thawing the Samples.....	515			
24.5.10	Frozen Semen Transport.....	515			

S. Kliesch (✉)
Centre of Reproductive Medicine and Andrology
of the University, Domagkstrasse 11, 48149 Münster,
Germany
e-mail: Sabine.Kliesch@ukmuenster.de

24.1 Introduction

This chapter provides a review of the present state of technology, practicability and limits of cryopreservation of human spermatozoa. Its aim is to encourage physicians and health care providers to consider the needs of a patient's quality of life with respect to his family planning and fertility on a long-term basis and to include these topics when counselling the patient and planning therapy. Sperm cryopreservation is an important part of the work of many semen analysis laboratories, particularly those associated with infertility clinics. Spermatozoa may be stored for a variety of reasons and some of these may require modifications of the cryopreservation procedure.

Cryopreservation of semen represents a preventive therapeutic option for normal men, infertile and oncological patients and offers the chance of maintaining potential parenthood.

24.2 History of Cryopreservation of Human Semen

The first observation that the motility of human spermatozoa could be preserved after freezing and thawing was made by Lazzaro Spallanzani in 1776. In the middle of the nineteenth century the idea arose to establish a sperm bank for cattle breeding. Around the same time the possibility of freezing soldiers' semen before they went to war was considered, with the purpose, should they die, of enabling their wives to bear their children. Serious attempts to improve the technical requirements of the cryopreservation of semen were performed in the first half of the twentieth century (Trottmann et al. 2007). Great improvements were achieved by introducing the first cryoprotective substance, glycerol, into the cryopreservation process to protect spermatozoa during freezing. This led to the use of human spermatozoa stored on dry ice at -79°C (Polge et al. 1949). Subsequently liquid nitrogen (-196°C) was used and shortly thereafter the first successful fertilization and pregnancy with cryopreserved semen was reported. Since then thousands of births worldwide have resulted from the use of cryopreserved donor semen (Leibo et al. 2002). With the introduction

of the intracytoplasmic sperm injection (ICSI) technique the cryopreservation of spermatozoa was extended to testicular and epididymal tissue with single spermatozoa extracted by operative techniques (surgical incision or microsurgical procedure).

24.3 Indications for Cryopreservation of Semen

24.3.1 Fertility Preservation

Men may store semen before undergoing a procedure or exposure that might prevent or impair fertility, such as multimodality oncology treatment with especially cytotoxic alkylating agents, radiotherapy and/or surgical procedures, which is likely to impair spermatogenesis or semen deposition permanently, and vasectomy (as insurance against a change in marital situation or desire) (Meseguer et al. 2006; Schmidt et al. 2004). For patients about to undergo chemo- and radio-therapy, the semen should be collected before the patient commences any therapy because of the potential risk of mutagenesis in the spermatozoa (Krause 2007). Patients undergoing organ transplantation or treatment for rheumatic arthritis, Morbus Crohn or colitis ulcerosa should also be offered semen sampling prior to therapy. In certain countries, men on active duty in a dangerous occupation; e.g., in military defence forces, may provide samples when posthumous procreation is acceptable.

Prophylactic cryopreservation of semen offers the chance of preventing the hazardous effects of disease and therapy on fertility and may contribute to the personal stabilization of the mainly young patients in this critical and acute situation. Most patients deciding in favor of cryopreservation of semen are those with malignant diseases. Others seek cryopreservation because the extent of their disease is not yet clear, or potentially toxic treatments have to be performed because of benign diseases that may damage testicular function.

24.3.1.1 Vasectomy and After Vasovasostomy

Cryopreservation of spermatozoa may be seriously considered for patients who will undergo vasectomy because no hormonal, reversible contraceptive device

comparable to the female pill is available for men (Djerassi and Leibo 1994). Vasectomy is an invasive and often irreversible contraceptive method (see Chap. 28) and the patient and his female partner have to make a definite decision on their family planning. Daily clinical work, however, demonstrates that suddenly changed circumstances of the patients' lives (the death of a child or the female partner; a new partnership) give rise to the wish to reverse vasectomy and to perform microsurgical vasovasostomy or vasoepididymostomy (vasotubulostomy). For these patients cryopreserved semen might offer the chance to father a child by means of assisted fertilization in case of unsuccessful or impossible refertilization. After successful vasovasostomy or vasoepididymostomy there is a risk that patency of the ducts may not be permanent, resulting in re-obstruction. Therefore patients could be offered the possibility to cryopreserve either intraoperatively aspirated spermatozoa or ejaculated semen after successful refertilization. In about one third of patients intraoperative sperm aspiration is successful in collecting motile spermatozoa that may be used for later microinjection therapy if refertilization fails (Belker and Bergamini 1997). Alternatively, testicular sperm extraction (TESE) may also be combined with a microsurgical refertilization procedure, if vasal or epididymal sperm retrieval is not sufficient. However, the additional costs must be critically discussed with the patient, especially when considering the overall low frequency of patients using these intraoperatively cryopreserved depots after successful microsurgery (Practice Committee of the American Society for Reproductive Medicine 2006; Kolettis et al. 2005).

24.3.1.2 Oncological Diseases in Adults

Malignant diseases in adolescents and adults can be cured by surgery, chemo- and/or radio-therapy in a high percentage of cases, resulting in increased survival rates. In those patients where this is not possible, an increase of disease-free intervals may be achieved by adequate therapeutic strategies. Therefore the implications for long-term toxicity and delayed results of therapeutic intervention become more and more important. Chemo- and/or radiotherapy, as well as surgical intervention, have a negative influence on male reproductive functions; the effects can be irreversible and

depend on the therapeutic modalities, the substances and dosages chosen.

Malignant diseases strike many patients at a time when family planning has not started or is not yet finished. At this critical point of time, individual reproductive function may have a high impact on quality of life. Of the 1,132 oncological patients at our center (mean age 28 years) presenting for cryopreservation of their semen between 1989 and 2008, only 24% were already married and only 10% had already fathered at least one child before they became ill.

The extent of impairment of gonadal function by chemo- and/or radiotherapy cannot be predicted definitely and the possibility of testicular recovery depends on the therapeutic intervention itself, the dosages applied and the susceptibility of the patient (Kliesch et al. 1996; Palmieri et al. 1996). Until now it has not been possible to protect testicular function from the toxic effects of chemo- and/or radiotherapy (Kamischke et al. 2003). Retrograde ejaculation after retroperitoneal lymphadenectomy can be treated empirically with some medical effort, but *impotentia generandi* resulting from radical surgery (e.g., radical prostatectomy, cystoprostatectomy or rectal exenteration) can be treated only with TESE (Kamischke and Nieschlag 1999).

In patients with testicular tumors or other malignancies (e.g., Hodgkin disease, leukemia) impairment of testicular function is known. However, the underlying causes of reduced fertility in relation to the malignant disease are not understood (Hansen et al. 1991; Viviani et al. 1991). Data from our own patients revealed reduced semen parameter values with oligozoospermia in 63% of men with testicular tumors, 43% of men with lymphatic or leukemic diseases and 45% of patients with different solid tumors (Fig. 24.1) prior to cryopreservation. Prior to radio- and/or chemotherapy a total of 89 patients were azoospermic; 90 patients had sperm concentrations between $0.1 \times 10^6/\text{ml}$, but 433 patients had normal sperm concentrations (modified from Kamischke et al. 2004). However, reduced sperm concentrations do not play the most important role in predicting the success of assisted fertilization procedures (Palermo et al. 1992).

Sperm motility is particularly impaired by the cryopreservation process (Fig. 24.2). While the mean progressive motility of sperm in oncological patients is about 40%, a significant drop of sperm motility to a mean of 21% is noticed immediately after freezing and thawing an aliquot, independent of the underlying disease and the patients' age (Keck and Nieschlag 1993;

Fig. 24.1 Age and sperm concentrations in semen of 683 patients with malignancies at the time of cryopreservation. Note logarithmic scale. The lower normal limit for sperm concentration is 20 million spermatozoa/ml semen (broken line) (Updated and modified from Kamischke et al. 2004)

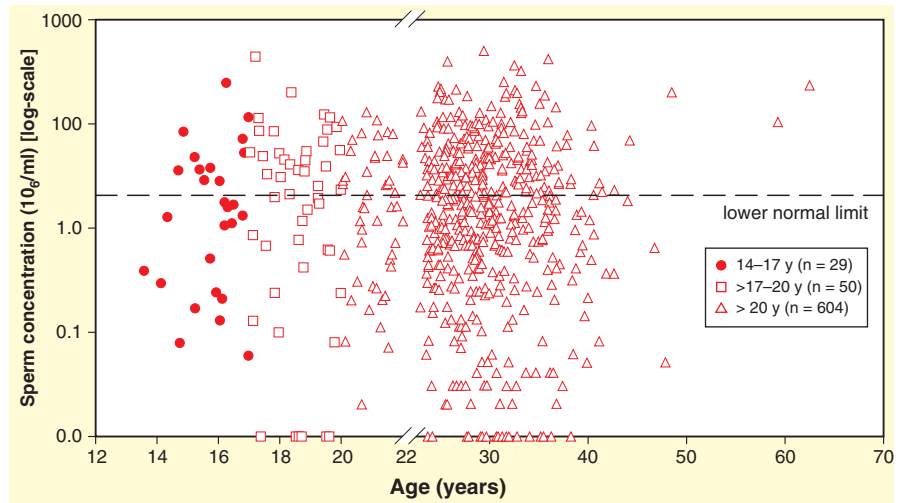

Kliesch et al. 1996). The better the pre-freeze sperm motility is (Fig. 24.2), the better post-thaw motility tends to be. As sperm motility is regarded as one of the important parameters for increasing success rates in insemination and in vitro fertilization (IVF) therapies (De Geyter et al. 1992), this decrease of sperm motility due to the cryopreservation itself, may explain the often unsuccessfully performed insemination or IVF cycles. However, with respect to ICSI, the percentage of motile sperm is not as relevant. In ICSI treatment sperm motility is used as an indicator of vitality of the spermatozoon selected for microinjection (see Chap. 23).

24.3.1.3 Oncological Diseases in Childhood

The survival rates of oncological patients who become ill at a young age, e.g., with testicular tumors, Hodgkin disease, leukemia or Ewings sarcoma, have increased, owing to early detection and improved therapeutic concepts. Cryopreservation cannot only be offered successfully to adults but also to juvenile patients with malignancies. Prior to and after cryopreservation adolescent boys show semen parameters comparable to those of adults, independent of the underlying oncological disease (Kliesch et al. 1996; Kamischke et al. 2004).

Fig. 24.2 Sperm motility prior to (abscissa) and after (ordinate) freezing and thawing of semen from patients with different oncological diseases at the time of cryopreservation of semen. The lower normal limit for the pre-freeze progressive sperm motility is 50%

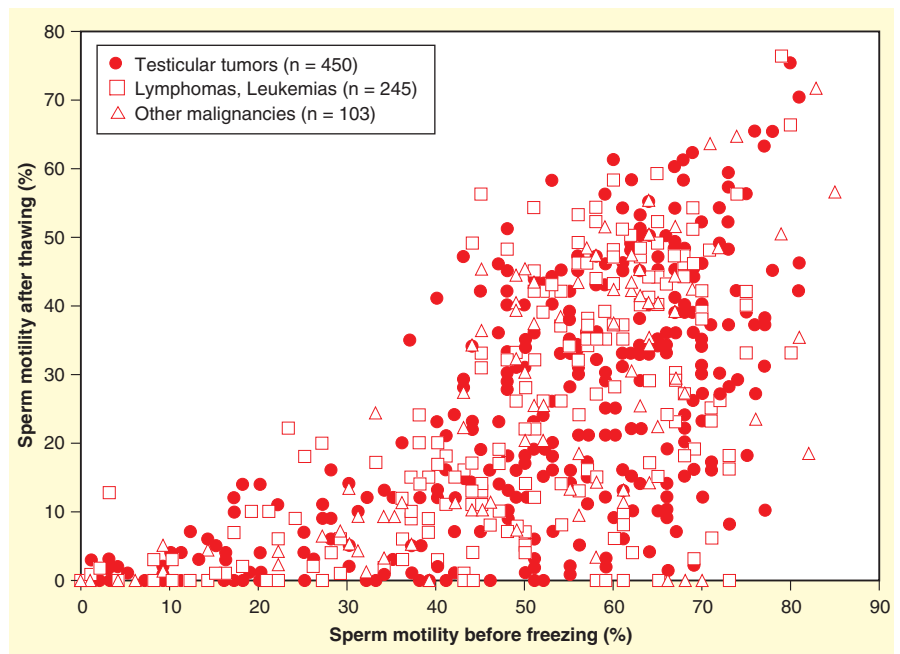

All our adolescent oncological patients showed age-adjusted normal or above normal testicular volumes in the lower or subnormal adult range, irrespective of sperm count. As in our department only one of the adolescent patients showed azoospermia, one might speculate that an age-adjusted normal testicular volume in the lower to subnormal adult range is a positive predictor for successful spermatogenesis and subsequent cryopreservation (Kamischke et al. 2004). Although chemotherapy protocols used in childhood have become less harmful, the prognosis concerning gonadal toxicity and impairment of gonadal function on a long-term basis remains difficult and depends on the chemotherapeutic combinations and the necessity of multimodal treatment options used. Up to 16% of patients exposed to therapies not using alkylating substances (e.g., adriamycin, vincristine, methotrexat) show persistent azoospermia during adulthood after childhood treatment.

When cisplatin-based chemotherapies are used, a mean of 37% of cured patients remains azoospermic during adulthood. If alkylating substances (e.g., cyclophosphamide or procarbazine) are used during childhood cancer treatment, infertility may result in 68% of the treated patients during adulthood (for review see Kliesch et al. 1996). Whether the possibility of sampling gonadal tissue in oncologically ill (prepubertal) boys prior to toxic treatment will offer a real chance for later re-transplantation to regain fertility depends on future research developments. So far, first experimental attempts have been made to establish germ cell transplantation techniques (for review see Bahadur and Ralph 1999; Schlatt et al. 1999).

The preventive aspect of cryopreservation of spermatozoa in respect to long-term life quality, including potential paternity, should be considered when counselling the very young patient and his parents prior to treatment which may prove toxic to the gonads.

24.3.2 Infertility Treatment

Men may store spermatozoa for treatment of their partner by intra-uterine insemination (IUI), IVF or ICSI in cases of severe oligozoospermia, intermittent presence of motile spermatozoa in the semen or partially successful treatment of infertility, such as surgery for genital tract obstruction or gonadotropin treatment for hypogonadism.

Under special circumstances, such as assisted ejaculation for anejaculation, spermatozoa may be prepared from urine after retrograde ejaculation or collected surgically from the genital tract (TESE; microsurgical epididymal sperm aspiration, MESA). It is used rarely for patients unable to provide fresh semen on the day of a therapeutic procedure.

24.3.2.1 Assisted Fertilization

The cryopreservation of surgically sampled spermatozoa for use in assisted fertilization techniques has become increasingly important in recent years. Epididymal sperm aspiration and testicular extraction of spermatozoa, in combination with cryopreservation, have become routine procedures in reproductive centers for cases with both reconstructable and non-reconstructable obstruction and primary testicular failure (non-obstructive azoospermia).

Information on the quality of cryopreserved sperm samples used for assisted fertilization is variable. No systematic information on the number of treatment cycles, methods of gynecological therapy and the total number of treated andrological patients is available. Between 1983 and 1992 a total of 117 pregnancies and 115 births after insemination or IVF with cryopreserved semen samples of oncological patients was published (Sanger et al. 1992). In Germany two centers provided data on cryopreserved semen samples of oncological patients. They reported on 136 cryopreserved specimens collected between 1974 and 1988, including those from eight patients who used their cryopreserved spermatozoa for assisted fertilization after a period of up to 5 years (Köhn and Schill 1988; Holland-Moritz and Krause 1990). In our centre patients with long-term depots use their cryopreserved semen samples for assisted reproduction in up to 14% of cases.

Simultaneous with the further development of the techniques of assisted reproduction (insemination, IVF, microinjection), chances of inducing a pregnancy increased because of the improvement in sperm quality by better freezing techniques and improved preservation of sperm function. Therefore the “minimal criteria” for spermatozoa to be cryopreserved (e.g., post-thaw-motility of at least 10%, sperm concentration $>10 \times 10^6$ ml) (Köhn and Schill 1988; Keck and Nieschlag 1993) that were generally accepted several years ago have become irrelevant in view of microinjection therapy.

24.3.2.2 MESA and TESE Samples Including Onco-TESE

In the context of andrologically relevant microsurgery, MESA offers the chance of obtaining spermatozoa from patients with obstructive azoospermia who cannot be successfully treated by reconstructive microsurgery. Patients with post-infectious obstructive azoospermia, as well as those with congenital bilateral agenesis of the vas deferens or abnormalities of the epididymides, belong to this treatment group (Craft and Tsirigotis 1995). Aspirated spermatozoa not used for fertility treatment can be cryopreserved and may be used for further treatment cycles in assisted fertilization. Cryopreservation of surgically obtained sperm specimens may prevent more invasive surgery. Experience with the quality of these cryopreserved samples has shown that microinjection therapy may be performed successfully with fresh, as well as with cryopreserved, epididymal spermatozoa. However, it is also known that both post-thaw motility of epididymal spermatozoa and pregnancy rates are lower compared with those from microinjection therapy with fresh spermatozoa (Palermo et al. 1999).

In addition to epididymal spermatozoa, testicular spermatozoa can be frozen from patients with severe oligoasthenoazoospermia or hypergonadotrophic azoospermia with testicular dysfunction due to focal Sertoli-cell-only syndrome or incomplete arrest of spermatogenesis. For this, TESE from surgically obtained testicular tissue is used in combination with ICSI (Devroey et al. 1995; Silber et al. 1995). Patients should be offered the possibility of cryopreserving unused testicular tissue for later preparation in further treatment cycles. Experience in recent years with TESE itself, as well as with that of cryopreserved testicular tissue, has proved it to be an effective treatment option for infertile azoospermic men. Overall, in up to 70% of azoospermic men, spermatozoa may be extracted from testicular tissue (Jezek et al. 1998). However, pregnancy rates vary – depending on the center and especially on the severity of spermatogenic impairment – between 10% and 30% (Friedler et al. 1997). The chances for fertilization and pregnancy achieved with testicular spermatozoa are much higher when single spermatozoa are found in the sediment of the patient's ejaculate (Palermo et al. 1999).

Comparing the different methodologies for sperm extraction in men with obstructive azoospermia, the puncture procedure does not allow any control concerning the punctured area and, in addition, it was

shown that percutaneous sperm aspiration resulted in successful sperm extraction in only 61%. With the surgical technology of MESA or TESE, sperm recovery rates were 93% and 100%, respectively. The MESA aspirates obtained during one operation may be used for altogether seven ICSI-treatment cycles, if necessary. Moreover, the trauma by fine needle punctures is even worse than that induced by open surgical sperm retrieval (Shufaro et al. 2002).

Especially in severely infertile men, namely those with non-obstructive azoospermia, open surgical testicular sperm extraction results in better sperm retrieval rates compared to fine needle aspiration. In 452 azoospermic men, altogether 63 were found to have positive sperm results with TESA (14%) compared to 228 men with TESE (50%) (Friedler et al. 1997; Mercan et al. 2000). Whether microsurgical TESE procedures result in further improvement of sperm cryopreservation remains to be elucidated in further studies (Colpi et al. 2009). In addition, testicular histology is useful in hypergonadotrophic infertile men, being at higher risk for TIN or testicular tumor compared to normal males (see Chap. 13).

In addition, onco-TESE may play a special role in patients with bilateral testicular tumor, with single tumor bearing testicles and azoospermia after gonadotoxic treatment without sufficient pre-treatment cryopreservation depots. This severely impaired subgroup of oncological patients needs special attention. Bilateral (synchronous or metachronous) testicular tumor may occur in 2–3% of testis cancer patients and contralateral TIN in another 5% of men. If treatment options are discussed and semen analysis reveals azoospermia, tumor enucleation or inguinal orchiectomy should be combined with TESE for cryopreservation in specialized centers. Long-term survivors of oncological diseases revealing azoospermia may be offered testicular biopsy for diagnosis and TESE options to determine fertilization potential (Schrader et al. 2003).

24.3.2.3 Patients with Anejaculation

A minor, less extensively considered patient group is that with lesions of the spinal cord. Up to 95% of these patients lose their ability to ejaculate. By electrovibration or rectal electric stimulation ejaculations may be produced and semen may be successfully used for assisted fertilization (Kamischke and Nieschlag 1999). The penile electrovibrator offers a simple, and rectal electrostimulation a more complex and inconvenient

method for the treatment of anejaculation and much depends on interdisciplinary and logistic cooperation between patient and physicians. Cryopreservation offers the advantage of collecting semen samples for later use in artificial fertilization treatment (Chung et al. 1995).

24.3.3 Donor Semen

Semen is stored from healthy donors known or presumed to be fertile. These donors may be recruited by the clinic or sperm bank and used anonymously or as donors known to the recipients. The use of donor gametes is accepted in some countries but not in others. Where accepted, there are relatively uniform guidelines for the selection and screening of donors. However, legal regulation varies widely. For example, anonymity of donors is required in some countries, whereas elsewhere donor children will be told the identity of the donor upon request when they have attained legal age. The use of cryopreserved donor semen for heterologous assisted fertilization is practiced in various countries and depends on applicable laws (ESHRE 2004).

Donor spermatozoa may be used for IUI, IVF or ICSI to treat the partner of an infertile man who has no live spermatozoa or elongated spermatids suitable for ICSI, or where treatment has failed or is too costly; to prevent transmission of an inherited disorder or to prevent fetal hemolytic anaemia from blood group incompatibility. Additional uses are for recurrent abortion – donor insemination may result in a successful pregnancy and, for single or lesbian women wishing to conceive.

24.3.4 Quarantine of Potentially Infected Samples

The advent of acquired immunodeficiency syndrome human immunodeficiency virus (HIV – AIDS) in the early 1980s required the introduction of a quarantine period and further testing of the donor before use of his stored semen in order to minimize infectious disease transmission. Men with HIV controlled by anti-retroviral therapy may store samples with undetectable viral load for IUI, IVF or ICSI to attempt conception while reducing the risk of transmission of HIV to the female partner (Gilling-Smith et al. 2005).

24.3.5 Quality Control of Semen Analysis

Cryopreservation of spermatozoa can play a role in establishing internal and external quality control systems in andrology (Cooper et al. 1992; Neuwinger et al. 1990). However, the costs of transport of such samples and the quality of the post-thaw specimens severely limits such application and since these pioneering studies no others have been reported.

24.4 Requirements and Risk Assessment for Cryoconservation of Human Semen

Running a cryolaboratory successfully involves ensuring the physical security and scrupulous labelling of the frozen specimens. Comprehensive risk assessment is recommended.

The cryopreservation and subsequent storage of human spermatozoa is a highly complex process posing a special responsibility for, and potential liability of, the laboratory staff. All procedures involving the identity of donor or patient samples, including receipt of samples, preparation and labelling of straws, placement in tanks and thawing of straws for use or discarding, should be double-checked by two people and evidence of this checking witnessed in laboratory records (Tedder et al. 1995; Mortimer 2004; Gilling-Smith et al. 2005; Tomlinson 2005). Ideally one person should only process one semen sample at any given time. It is necessary to comply with local legislation regarding genetic and infection screening (see guidelines in American Fertility Society (1990); British Andrology Society (1999); Canadian Fertility and Andrology Society (1992); Fertility Society of Australia; Jalbert et al. 1989; EU Regulations 2006).

24.4.1 Required Resources

Running a cryolaboratory also involves ensuring the physical security of the vessels, specimens and storage room to reduce risk of loss by theft or fire and to guard against the failure of cryopreservation straws, ampoules and vessels. Splitting of samples and storage at different

sites may be considered to reduce risk of total loss of samples. As well as ensuring a constant liquid nitrogen supply, detectors to indicate low liquid nitrogen levels in the freezers and low atmospheric oxygen alarm systems in the rooms are necessary.

24.4.2 Risk of Cross-contamination

There is a risk of cross-contamination with infectious agents between samples via a cryopreservation vessel in storage. This will depend on the protocol used and the location and method of storage of high risk samples (known to contain or possibly containing viruses such as HIV and HCV), including the type of storage container (whether vials or straws), the method of sealing the straws (whether heat or polymer) and the nature of storage (whether in liquid nitrogen or its vapor). Storage in the vapor phase rather than in the liquid nitrogen itself may reduce the chances of cross-contamination. However, large temperature gradients can exist in vapor storage vessels depending on the shape, sample load and type of sample containers. In extreme cases, a temperature of less than -100°C cannot be achieved (Tomlinson 2005). If vapor phase storage is used, care must be taken to avoid the samples warming to greater than -130°C (the glassy transformation temperature), as this may damage the spermatozoa (see Clarke 1999).

24.4.3 Staff Safety and Protection

For protection of the staff working in the unit, there should be provision of personal protective equipment (insulated gloves, goggles), and the room should be fitted with an oxygen sensor with alarm.

24.4.4 Labelling of Straws and Records

To ensure patient samples, there should be double checking of the identity of samples at each step vulnerable to error; a robust labelling and identifying code, a procedure and mechanism of regular audit of the use of material and samples remaining in storage.

It is important to have a unique code for each donor or storage client and to use a code in laboratory data sheets and computer databases to maintain anonymity. The key to the code identifying the donor should be kept separately and securely.

24.5 Preparation of Semen Samples for Cryopreservation

24.5.1 Preparing the Sample

The liquefied ejaculate is analyzed according to the guidelines of the World Health Organization (WHO 2009) (see Chap. 9). The standard parameters of sperm concentration, total number of spermatozoa, sperm morphology and sperm motility prior to cryopreservation give important information for later use of the semen in assisted fertilization procedures. Additional sperm function tests can be performed, such as the hypo-osmotic swelling (HOS) test to investigate whether the sperm's flagellar membrane remains intact. However, no correlation between hypo-osmotic swelling and sperm quality after cryopreservation is evident (Chan et al. 1993). The eosin test (of sperm head membranes) may be useful to demonstrate the percentage of vital sperm after cryopreservation.

Selection of motile spermatozoa by a swim-up procedure prior to cryopreservation improves the morphology and motility of spermatozoa obtained after freezing and thawing (Pérez-Sánchez et al. 1994). However, the swim-up spermatozoa are damaged to the same extent as spermatozoa in the original sample so the improvement reflects merely the better quality of the initial sample.

24.5.2 Routine Sample Freezing and Cryoprotectants

Intracellular ice crystals lead to cellular lesions and death during thawing, whereas extracellular ice crystal formation raises extracellular tonicity and damages cell membranes by the cell shrinkage invoked. To minimize this, cryoprotective media are added to the ejaculate prior to the freezing process. These are based

either on egg yolk mixed with low molecular weight (penetrating) compounds such as glycerol or consist of culture media with macromolecular, non-penetrating compounds such as human serum albumin together with or without glycerol. Cryoprotective substances that do not penetrate the sperm membrane (e.g., human serum albumin and additions based on egg yolk) are protective by binding to and stabilizing the cell membrane (Watson et al. 1992).

Several cryopreservation protocols are now used with variations in composition of the cryoprotectant and complexity of the freezing procedure. Cell survival with freezing and thawing depends largely on minimizing intracellular ice crystal formation by the use of appropriate cryoprotectants and appropriate rates of cooling and warming to control the amount of intracellular water subject to ice formation (Sherman 1990; Keel and Webster 1993; Watson 1995). Temperatures above -130°C , the glassy transition temperature, are important because if the spermatozoa spend significant periods of time above this temperature, recrystallization can occur with growth of potentially damaging intracellular ice crystals, particularly during the thawing process.

24.5.3 Relative Resistance of Spermatozoa to the Freezing Process

During the process of freezing, spermatozoa are exposed to extreme temperature changes that alter sperm morphology and damage sperm function at many levels. Spermatozoa may be more resistant than other cells to cryopreservation damage because of their lower water content. Human spermatozoa tolerate a range of cooling and warming rates and samples do not need seeding to induce ice crystal formation. They are not very sensitive to rapid initial cooling (cold shock), possibly because of high membrane fluidity from the unsaturated fatty acids in the lipid bilayer (Clarke et al. 2003). Nevertheless, osmotic efflux of water by hypertonic cryoprotectants and raised osmolality as a result of extracellular ice formation leads to dehydration, changes in intracellular electrolyte concentrations and disruption of sperm membrane permeability (Hammerstedt et al. 1990; Watson et al. 1992). On average only about 50% of the motile

spermatozoa survive freezing and thawing (Keel and Webster 1993). Optimizing the cryopreservation process should minimize this damage and increase pregnancy rates (Woods et al. 2004).

24.5.4 Standard Cryoprotectants

24.5.4.1 For Normal Samples

A commonly used cryoprotectant is glycerol-egg yolk-citrate (GEYC). Cryoprotectants similar to GEYC can also be obtained commercially (see Table 24.1) but other cryoprotectants, freezing and sperm bank management protocols are available (Mortimer 2004; Wolf 1995). Improvements to the basic cryoprotectant include the addition of antioxidants (e.g., vitamin E), Ca^{2+} -chelating agents (e.g., EDTA) or derivatives of phosphatidylcholine (platelet-activating factor) and derivatives of methylxanthine (pentoxifylline) to the cryopreservatives (Alvarez and Storey 1993; Wang et al. 1993) that may be beneficial in certain cases but are not adopted routinely.

Table 24.1 Indications and frequency of cryopreservation (of 1,136 consecutive patients of the Centre of Reproductive Medicine and Andrology of the University, Münster, Germany)

Diagnosis	Number of patients (%)
Testicular tumors	573 (50)
Hodgkin disease/non-Hodgkin disease	201 (18)
Leukemias	99 (9)
Bone tumors	74 (7)
Other malignancies	61 (5)
Benign diseases	128 (11)

24.5.4.2 For Samples with Low Sperm Numbers

Epididymal fluid, testicular extracts or other sperm suspensions processed by swim-up or centrifugation on density gradients and resuspended in a sperm preparation medium with Hepes buffer and human serum albumin 4mg/ml can be cryopreserved with Tyrode-glucose-glycerol cryoprotectant or a commercial cryoprotectant containing human albumin.

24.5.4.3 Improvements in Cryopreservation Techniques

Novel techniques aimed at improving post-thaw sperm motility by non-linear temperature changes of extracellular solute concentration (Morris et al. 1999) have shown promise and vitrification (the very rapid freezing of cells without ice crystal formation) achieved by plunging a very small (~20 µl) sample in a cryo-loop directly into liquid nitrogen, with or without cryoprotectants, produces good results (Isashenko et al. 2004a, b, 2005), but neither technique has been adopted into routine practice. Further, not broadly distributed methods for cryopreservation of single spermatozoa include the use of empty zona pellucida as a sperm storage container, freezing in micro-droplets, the microencapsulation of spermatozoa and the use of mini-straws.

24.5.5 Adding the Cryoprotectant

24.5.5.1 For Normal Samples

After liquefaction at 37°C the sterile ejaculate is carefully mixed with the same volume of a cryoprotective medium (CPA). This can be done in several steps in order to prevent excessive volume changes during CPA additions (Gao et al. 1997). Several cryoprotectants are commercially available (Table 24.2).

For fertility preservation or infertility treatments, sufficient normal specimens should be stored to provide ten or more inseminations, in order to ensure a good chance of pregnancy. The diluted semen sample in the vial is transferred to “straws” under sterile laboratory conditions. Each straw has a maximum volume of 300 µl and consists of a plastic material that offers optimal temperature distribution during cooling. Great care should be taken to prevent the admission of air bubbles into the straw, as they can expand upon warming and cause the straw to explode. Depending on the

equipment, usually a maximum of 12 straws can be stored in one cryo-cassette.

24.5.5.2 For Samples with Low Sperm Numbers

For semen samples containing only a few motile spermatozoa (from oligozoospermic ejaculates) and sperm suspensions obtained from the genital tract stored for subsequent ICSI, it is necessary to centrifuge the semen at 1,500 g for 10 min to concentrate the spermatozoa to a minimum volume of 0.4 ml before treating the same as above. Surgically retrieved spermatozoa (either epididymal or testicular) are placed in a special medium for transportation and further preparation, mixed with cryoprotectives, cryopreserved and stored in liquid nitrogen. The ampoules for storage vary from laboratory to laboratory. Usually for epididymal probes “straws” are used, whereas for testicular probes small tubes suitable for sterile cryopreservation are employed.

24.5.6 Closing the Straws

To avoid cross-contamination, total closure of the straw is necessary: straws with an upper plug of dry polyvinyl alcohol powder held between two sections of cotton wool automatically seal when the semen contracts and polymerizes the powder. Secure straws made from heat-sealable ionomeric resin are available for storage in liquid nitrogen (CBS High Security Straws). These are leak-, bacteria- and virus-proof and mechanically resistant at -196°C (Mortimer 2004; Gilling-Smith et al. 2005; Tomlinson 2005).

24.5.7 Freezing the Samples

Most groups work with stepwise freezing. Shortly after reaching the freezing point of water, extracellular ice

Table 24.2 Cryoprotectants (CPA) used for human spermatozoa

Name	Supplier	Macromolecule	Lipid	CPA
Freezing medium	Irvine Scientific	No albumin	Egg yolk	Glycerol
SpermCryo™	Provitro	No albumin	No egg yolk	Glycerol
SpermCryo™ All-round	Cryosinternational	No albumin	No egg yolk	Glycerol
SteriTec®	Steripharm	Albumin	No egg yolk	Glycerol

crystal formation begins at about -5°C , and at about -15°C to -80°C intracellular ice crystal formation occurs. There are no uniform guidelines for the optimal freezing time to be chosen between 0°C to -80°C . In principle, cooling leads to increased cell shrinkage by dehydration if it is performed too rapidly, while it promotes ice crystal formation if it is performed too slowly. A freezing speed of $8\text{--}21^{\circ}\text{C}$ per min is used by most groups working with cryopreservation of human semen. After -196°C is reached, the cryopreserved semen samples are stored in liquid nitrogen.

With programmable freezers, e.g., Planer Kryo 10-Serie II (Planer) and ICEcube 1,810 (tec-lab), in which the programme controls injection of liquid nitrogen vapor into the freezing chamber, the cryo-cassettes are cooled by a computerized, automated process that offers standardized and reproducible cryopreservation conditions. Manual methods are naturally less controllable than those from programmable freezers but can give adequate results. Here the straws are first placed in a refrigerator freezer (-20°C) for 30 min, then on dry ice (-79°C) for 30 min before placing in liquid nitrogen (-196°C).

24.5.8 Storing the Samples

Long-term storage of semen samples may be undertaken in the institution performing cryopreservation. Constant storage temperatures must be guaranteed and should not be endangered by repeated opening of the liquid nitrogen containers. Long-term storage may also be performed in a commercial cryobank. Patients who decide on long-term storage sign a contract with the institution performing long-term storage that may be continued or cancelled on a yearly basis. The costs are usually paid by the patient, but in very exceptional cases costs may be borne by the health insurance. If the semen sample is needed for assisted fertilization, it can be sent to the doctor on the patient's authorization.

24.5.9 Thawing the Samples

Inadequate freezing and thawing conditions may lead to cell shrinkage, osmotic cell lesions and ice crystal formation. Therefore the freezing and thawing times

should be well adjusted (Leibo et al. 2002). When semen samples are thawed, thawing speed should be adapted to the freezing speed (Leibo et al. 2002). Programmed cryo-machines can thaw as in the freezing process, but in reverse, and thawing at room temperature or in a water bath at 37°C can be acceptable. More rapid thawing may be better if the freezing process is rapid (Verheyen et al. 1993). After cryopreservation is performed, a small aliquot of the sample should be thawed and analyzed for sperm motility. This information may be helpful for later use of the sperm during assisted fertilization techniques. Removing cryoprotectant by sequential dilution in small volume steps avoids undue osmotic stresses (Gao et al. 1997) and may improve pregnancy results.

24.5.10 Frozen Semen Transport

Once frozen, spermatozoa can be transported in commercially available dry shipper tanks which are cooled with liquid nitrogen; during its evaporation suitably low temperatures are maintained for several days to several weeks, depending on the size of the tank. Compliance with local, national or international regulations on shipping liquid nitrogen should be observed. Shipping samples on dry ice requires the notification code UN-1845 and shipment of liquid nitrogen requires UN-1977.

24.6 Use and Quality of Stored Cryopreserved Semen Samples

24.6.1 Use of Cryopreserved Samples

Up to now, existing cryo-depots have only rarely been used. Altogether 69% of the patients of the Department of Clinical Andrology of the Center of Reproductive Medicine and Andrology (former Institute of Reproductive Medicine) initially store their semen samples on a long-term basis. In a retrospective analysis, 455 patients who opted initially for long-term storage of their semen samples were asked about their cryo-depots by a questionnaire. Two hundred and one

Fig. 24.3 Fate of the cryo-depots with respect to the initial oncological diagnoses of 201 patients who were referred for cryopreservation between 1984 until July 1999 and who opted initially for long-term cryopreservation of their semen and responded to a questionnaire

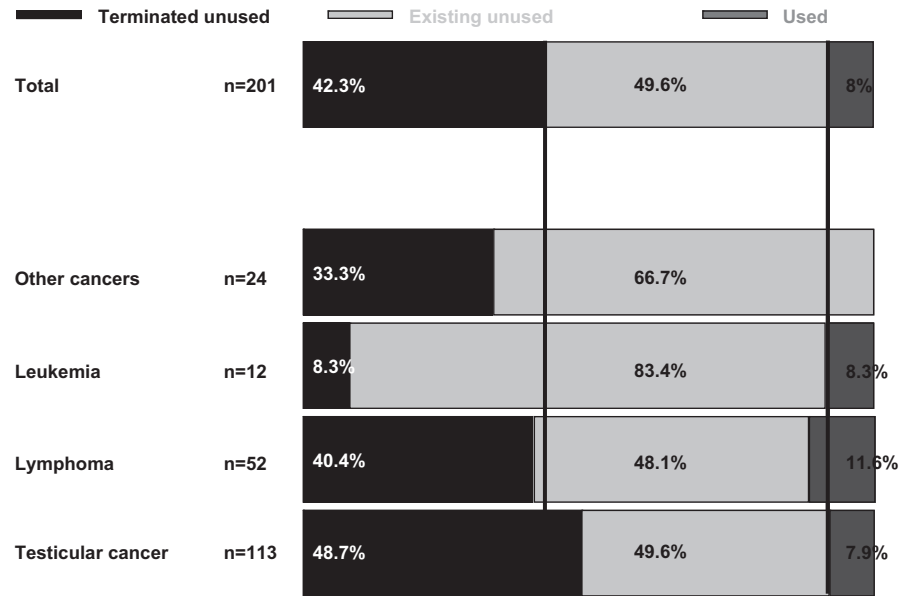

questionnaires were completed and during a mean of 4.1 years (range 0–12 years) 8% of patients used their cryopreserved samples for artificial reproduction techniques (Fig. 24.3). Twenty-nine of these patients achieved a spontaneous pregnancy after cessation of the oncological therapy without further medical help. Cryopreserved spermatozoa were used in 39 treatment cycles. A total of 14 pregnancies resulted, of which five failed to carry to term. A triplet pregnancy was achieved, resulting in a live birth of twins. One third of treatment cycles was performed after ICSI was offered at the end of 1994. Twenty-seven cycles with ICSI resulted in fertilization and 12 pregnancies, of which four were aborted. Reports concerning the use of cryopreserved semen from oncological patients for ICSI therapy are still rare, possibly due to the short period of time since introduction of the technique (Lass et al. 1998; Naysmith et al. 1998). The introduction of microinjection therapy will definitely contribute to the more successful use of cryopreserved semen samples of oncological patients.

24.6.2 Quality of Stored Cryopreserved Semen Samples

Only little information is available about whether long-term storage of cryopreserved semen samples using

modern cryo-techniques leads to a decrease of sperm quality. Smith and Steinberger (1973) were able to show that storage for longer than 36 months resulted in a decrease of sperm motility. However, no systematic or prospective studies exist that investigate the influence of modern standardized cryopreservation techniques on the maintenance of sperm quality during long-term storage. So far, results and experience with cryopreserved semen are based on investigations with sperm of normal healthy donors. However, these results may not be applicable to oncological patients because these patients already show limitations of sperm concentration, motility and morphology prior to anti-tumor therapies.

On the assumption that most oncological patients will undergo aggressive chemo- and/or radiotherapy after cryopreservation of their ejaculates, there will be a certain period of time following treatment before samples are used for family planning. Our youngest patient to use cryopreservation was 13 years old (Kliesch et al. 1996) and it is probable that at least a 5-year period may pass before these patients use their cryopreserved semen for assisted fertilization. Adequate counselling in respect to the chances of inducing a pregnancy by means of assisted reproduction using cryopreserved semen samples remains difficult. Semen stored under appropriate conditions shows no obvious deterioration of sperm quality with time, and children have been born from semen stored for over 28 years (Clarke et al. 2006; Feldschuh et al. 2005).

The best pregnancy rates by artificial insemination with cryopreserved donor semen are not different from those achieved with fresh semen and range from 15% to 25% per month or cycle of treatment. However, pregnancy rates of 7–12% per month are more usual, often related to post-thaw sperm quality, timing of insemination and particularly, recipient factors such as older age, previous pregnancy with donor insemination and ovulatory and uterine tubal disorders (Le Lannou and Lansac 1993). The evidence suggests that there is no increase in abnormal pregnancy outcomes after the use of frozen spermatozoa by artificial insemination: the rates of spontaneous abortion (13%), major birth defects (about 1%) and sex ratio (51:49, male:female) are similar to those of natural pregnancies (Sherman 1986).

24.7 Problems and Limitations of Cryopreservation

24.7.1 Genetic Risks

The question whether an increased genetic risk exists for the offspring of patients suffering from malignancies or treated by oncological chemo- and/or radiotherapy remains difficult to answer. In principle, two different aspects are to be considered. One refers to the risk arising from the malignant disease itself and possibly mutagenic effects of chemo- and/or radiotherapy. The other involves the possible risk of a genetically determined disease in the offspring when using assisted fertilization techniques with cryopreserved spermatozoa.

The available cytogenetic investigations in spermatozoa from patients after chemo- and/or radiotherapy show a significantly increased proportion of structural chromosomal anomalies in comparison with controls (Genescà et al. 1990; Rousseaux et al. 1993). However, these *in vitro* results are not supported by clinical data that suggest increased rates of anomalies in children born. With respect to the clinical aspect of a potentially increased genetic risk, no case-control studies exist that provide reliable answers to these questions. In addition, the problem of familial cancer risk exists and should lead to the recommendation to offer any cancer patient genetic counselling prior to fertilizing therapies.

The documented data of IVF centres and the data obtained from offspring of oncological patients indicate that no increased genetic risk and no increased risk for malformation exists that could result from the underlying oncological disease or the applied assisted fertilization technique with cryopreserved spermatozoa (Sanger et al. 1992; Dodds et al. 1993; Rufat et al. 1994; Schenker and Ezra 1994).

24.7.2 Psychological Aspects

Counselling of patients in respect to cryopreservation takes place when the physical and psychological integrity of the patient is disturbed. In view of the acute and stressful situation (confrontation with diagnosis and treatment), it seems difficult for both patient and doctor to consider the relative importance of cryopreservation to preserve potential parenthood with respect to the long-term quality of life. Semen storage before a potentially sterilizing procedure often has significant psychological value because of the hope of future paternity. However, for juvenile patients this counselling requires a high degree of involvement and willingness to break taboos and to discuss problems of sexuality and fertility. Notwithstanding, cryopreservation may contribute to the patient's personal stability in an acute and oppressive situation. In adolescents (aged 12–21 years at diagnosis) it was shown that successful cryopreservation in 67% of males leads to significant release in terms of anxiety concerning fertility aspects. Moreover, discussion of fertility aspects is much easier after successful cryopreservation (Edge et al. 2006). Saito et al. (2005) could show that cryopreservation also leads to some relief in dealing with the life-threatening illness. However, up to date only a maximum of 67% of adult patients at risk for gonadotoxic treatment are informed about and only 51% are offered the possibility of cryopreservation of semen (Saito et al. 2005).

24.7.3 Methodological Considerations

One methodological problem of cryopreservation is insufficient preparation of the ejaculate with reduced

quality, contributing to further decrease of sperm quality and function by the process of freezing. These methodological shortcomings render the later use of cryopreserved spermatozoa for assisted fertilization difficult. Consequently, the cryopreservation of semen only preserves the ability to produce offspring if the oncological patient is offered a high technical standard of assisted reproduction in qualified interdisciplinary reproductive centers with optimal gynecological treatment options for the female partner. Moreover, there is need for discussion of ethical questions arising from the fact that cryopreservation depots and thus preservation of potential paternity is established for patients who may die. While destruction of cryo-depots is contractually defined if the patient dies, the use of semen samples of incurably ill patients confronts doctor, patient and the patient's female partner with a situation that is neither regulated nor – at least so far – thoroughly discussed.

The cryopreservation of human sperm offers a preventive, pre-therapeutic possibility of preserving fertility in oncological patients prior to toxic therapies that can impair gonadal function. Moreover, cryopreservation may be used in patients who undergo microsurgical therapies during assisted fertilization treatment (MESA, TESE). In combination with ICSI and IVF the cryopreserved semen may be successfully used for fertilization. Chances of inducing pregnancy in the female partner have been improved and continue to increase by modern techniques of assisted fertilization.

References

- Alvarez JG, Storey BT (1993) Evidence that membrane stress contributes more than lipid peroxidation to sublethal cryodamage in cryopreserved human sperm: Glycerol and other polyols as sole cryoprotectant. *J Androl* 14:199–208
- American Fertility Society (1990) New guidelines for the use of semen donor insemination. *Fertil Steril (Suppl 1)*:1S–13S
- Bahadur G, Ralph D (1999) Gonadal tissue cryopreservation in boys with paediatric cancers. *Hum Reprod* 14:11–17
- Belker AM, Bergamini DA (1997) The feasibility of cryopreservation of sperm harvested intraoperatively during vasectomy reversals. *J Urol* 157:1292–1294
- British Andrology Society Guidelines for the Screening of Semen Donors for Donor Insemination (1999) *Hum Reprod* 14:1823–1826
- Canadian Fertility and Andrology Society (1992) Guidelines for Therapeutic Donor Insemination, 2nd edn (CFAS Montreal). http://www.hc-sc.gc.ca/dhp-mps/brgtherap/applic-demande/guides/semen-sperme-acces/semen-sperme_directive_e.html
- Chan SYW, Pearlstone A, Uhler M, et al (1993) Human spermatozoal tail hypo-osmotic swelling test, motility characteristics in hypotonic saline, and survival of spermatozoa after cryopreservation. *Hum Reprod* 8:717–721
- Chung PH, Yeko TR, Mayer JC, et al (1995) Assisted fertility using electroejaculation in men with spinal cord injury - a review of literature. *Fertil Steril* 64:1–9
- Clarke GN (1999) Sperm cryopreservation: Is there a significant risk of cross-contamination? *Hum Reprod* 14:2941–2943
- Clarke GN, Liu Y, Baker HW (2003) Improved sperm cryopreservation using cold cryoprotectant. *Reprod Fertil Develop* 15:377–381
- Clarke GN, Liu DY, Baker HWG (2006) Recovery of human sperm motility and ability to interact with the human zona pellucida after more than 28 years of storage in liquid nitrogen. *Fertil Steril* 86:721–722
- Colpi GM, Colpi EM, Piediferro G, Giacchetta D, Gazzano G, Castiglioni FM, Magli MC, Gianaroli L (2009) Microsurgical TESE versus conventional TESE for ICSI in non-obstructive azoospermia: a randomized controlled study. *Reprod Biomed Online*. 18:315–319
- Cooper TG, Neuwinger J, Bahrs S, et al (1992) Internal quality control of semen analysis. *Fertil Steril* 58:172–177
- Craft I, Tsirigotis M (1995) Debates: Simplified recovery, preparation and cryopreservation of testicular spermatozoa. *Hum Reprod* 10:1623–1627
- De Geyter C, De Geyter M, Schneider HPG, et al (1992) Subnormal sperm parameters in conventional semen analysis are associated with discrepancies between fertilization and pregnancy rates in in vitro fertilization and embryo transfer. *Int J Androl* 15:485–491
- Devroey P, Liu J, Nagy Z, et al (1995) Pregnancies after testicular sperm extraction and intracytoplasmic sperm injection in non-obstructive azoospermia. *Hum Reprod* 10:1457–1460
- Djerassi C, Leibo SP (1994) A new look at male contraception. *Nature* 370:11–12
- Dodds L, Marrett LD, Tomkins DJ, et al (1993) Case-control study of congenital anomalies in children of cancer patients. *Br Med J* 307:164–168
- Edge B, Holmes D, Makin G (2006) Sperm banking in adolescent cancer patients. *Arch Dis Child* 91:149–152
- ESHRE (2004) Task Force on Ethics and Law. Taskforce 7: Ethical considerations for the cryopreservation of gametes and reproductive tissues for self use. *Hum Reprod* 19:460–462
- EU Regulations on Cryoconservation of Germ Cells. *Amtsblatt der Europäischen Union. Richtlinie 2006/17/EG der Kommission* Feldschuh J, Brassel J, Durso N, et al (2005) Successful sperm storage for 28 years. *Fertil Steril* 84:1017
- Fertility Society of Australia. <http://www.fsa.au.com/rtac/>
- Friedler S, Raziel A, Soffer Y, et al (1997) Intracytoplasmic injection of fresh and cryopreserved testicular spermatozoa in patients with nonobstructive azoospermia – a comparative study. *Fertil Steril* 68:892–897
- Gao D, Mazur P, Critser JK (1997) Fundamental cryobiology of mammalian spermatozoa. In: Karow AM, Critser JK (eds) *Reproductive tissue banking*. Academic, San Diego, CA, pp 263–328

- Genescà A, Benet J, Caballín MR, et al (1990) Significance of structural chromosome aberrations in human sperm: Analysis of induced aberrations. *Hum Genet* 85:495–499
- Gilling-Smith C, Emiliani S, Almeida P, et al (2005) Laboratory safety during assisted reproduction in patients with blood-borne viruses. *Hum Reprod* 20:1433–1438
- Hammerstedt RH, Graham JK, Nolan JP (1990) Cryopreservation of mammalian sperm: What we ask them to survive. *J Androl* 11:73–88
- Hansen PV, Glavind K, Panduro J, et al (1991) Paternity in patients with testicular germ cell cancer: pretreatment and post-treatment findings. *Eur J Cancer* 27:1385–1389
- Holland-Moritz H, Krause W (1990) Inanspruchnahme von Sperma-Kryodepots bei Tumorpatienten. *Hautarzt* 41: 204–206
- Isachenko E, Isachenko V, Katkov II, Rahimi G, Schöndorf T, Mallmann P, Dessole S, Nawroth F (2004a) DNA integrity and motility of human spermatozoa after standard slow freezing versus cryoprotectant-free vitrification. *Hum Reprod* 19:932–939
- Isachenko V, Isachenko E, Katkov II, et al (2004b) Cryoprotectant-free cryopreservation of human spermatozoa by vitrification and freezing in vapor: Effect on motility, DNA integrity, and fertilization ability. *Biol Reprod* 71: 1167–1173
- Isachenko V, Isachenko E, Montag M, et al (2005) Clean technique for cryoprotectant-free vitrification of human spermatozoa. *Reprod BioMed Online* 10:350–354
- Jalbert P, Leonard C, Selva J, et al (1989) Genetic aspects of artificial insemination with donor semen: The French CECOS Federation guidelines. *Am J Med Gen* 33:269–275
- Jezek D, Knuth UA, Schulze W (1998) Successful testicular sperm extraction (TESE) in spite of high serum follicle stimulating hormone and azoospermia: Correlation between testicular morphology, TESE results, semen analysis and serum hormone values in 103 infertile men. *Hum Reprod* 13: 1230–1234
- Kamischke A, Nieschlag E (1999) Treatment of retrograde ejaculation and anejaculation. *Hum Reprod Update* 5:448–474
- Kamischke A, Kuhlmann M, Weinbauer GF, et al (2003) Gonadal protection from radiation by GnRH antagonist or rhFSH: A controlled trial in the male nonhuman primate. *J Endocrinol* 179:183–194
- Kamischke A, Jürgens H, Hertle L, Berdel WE, Nieschlag E (2004) Cryopreservation of semen from adolescents and adults with malignancies. *J Androl* 25:586–592
- Keck C, Nieschlag E (1993) Kryokonservierung von Spermien als Zeugungsreserve für onkologische Patienten. *Internist* 34:775–780
- Keel BA, Webster BW (1993) Semen cryopreservation methodology and results In: Barratt CLR, Cooke ID (eds) *Donor insemination*. Cambridge University Press, Cambridge, pp. 71–96
- Kliesch S, Behre HM, Jürgens H, et al (1996) Cryopreservation of semen from adolescent patients with malignancies. *Med Ped Oncol* 26:20–27
- Köhn FM, Schill WB (1988) Kryospermabank München – Zwischenbilanz 1974–1986. *Hautarzt* 39:91–96
- Kolettis PN, Fretz P, Burns JR, et al (2005) Secondary azoospermia after vasovasostomy. *Urology* 65:968–971
- Krause W (2007) Procreation by means of cryopreserved spermatozoa from tumor patients. *J Reprod Med Endocrinol* 4:9–96
- Lass A, Akagbosu F, Abusheikha N, et al (1998) A programme of semen cryopreservation for patients with malignant disease in a tertiary infertility centre: Lessons from 8 years' experience. *Hum Reprod* 13:3256–3261
- Leibo SP, Picton HM, Gosden RG (2002) Cryopreservation of human spermatozoa. In: Vayena E, Rowe PJ, Griffin PD (eds) *Current practices and controversies in assisted reproduction*. World Health Organization, Geneva, pp 152–165
- Le Lannou D, Lansac J (1993) Artificial procreation with frozen donor semen: The French experience of CECOS. In: Barratt CLR, Cooke ID (eds) *Donor insemination*. Cambridge University Press, Cambridge, pp 152–169
- Mercan R, Urman B, Alatas C, Aksoy S, Nuhoglu A, Isiklar A, Balanban B (2000) Outcome of testicular sperm retrieval procedures in non-obstructive azoospermia: percutaneous aspiration versus oprn biopsy. *Hum Reprod* 15:1548–1551
- Meseguer M, Molina N, Garcia-Velasco JA, et al (2006) Sperm cryopreservation in oncological patients: a 14-year follow-up study. *Fertil Steril* 85:640–645
- Morris GJ, Acton E, Avery S (1999) A novel approach to sperm cryopreservation. *Hum Reprod* 14:1013–1021
- Mortimer D (2004) Current and future concepts and practices in human sperm cryobanking. *Reprod Biomed Online* 9:134–151
- Naysmith TE, Blake DA, Harvey VJ et al (1998) Do men undergoing sterilizing cancer treatment have a fertile future? *Hum Reprod* 13:3250–3255
- Neuwinger J, Behre HM, Nieschlag E (1990) External quality control in the andrology laboratory: an experimental multicenter trial. *Fertil Steril* 54:308–314
- Palermo G, Joris H, Devroey P, et al (1992) Pregnancies after intracytoplasmic injection of single spermatozoon into an oocyte. *Lancet* 340:17–18
- Palermo GD, Schlegel PN, Hariprasad JJ, et al (1999) Fertilization and pregnancy outcome with intracytoplasmic sperm injection for azoospermic men. *Hum Reprod* 14: 741–748
- Palmieri G, Lotrecchiano G, Ricci G, et al (1996) Gonadal function after multimodality treatment in men with testicular germ cell cancer. *Eur J Endocrinol* 134:431–436
- Pérez-Sánchez F, Cooper TG, Yeung CH, Nieschlag E (1994) Improvement in quality of cryopreserved human spermatozoa by swim-up before freezing. *Int J Androl* 17:115–119
- Polge C, Smith AU, Parkes AS (1949) Revival of spermatozoa after vitrification and dehydration at low temperatures. *Nature* 164:626–627
- Practice Committee of the American Society for Reproductive Medicine (2006) Vasectomy reversal. *Fertil Steril* 86: S268–S271
- Rousseaux S, Sèle B, Cozzi J, et al (1993) Immediate rearrangement of human sperm chromosomes following in-vivo irradiation. *Hum Reprod* 8:903–907
- Rufat P, Olivennes F, de Mouzon J, et al (1994) Task force report on the outcome of pregnancies and children conceived by in vitro fertilization (France: 1987 to 1989). *Fertil Steril* 61:324–330
- Saito K, Suzuki K, Iwasaki A, Yumura Y, Kubota Y (2005) Sperm cryopreservation before cancer chemotherapy helps in the emotional battle against cancer. *Cancer* 104:521–524
- Sanger WG, Olson JH, Sherman JK (1992) Semen cryobanking for men with cancer – criteria change. *Fertil Steril* 58: 1024–1027

- Schenker JG, Ezra Y (1994) Complications of assisted reproductive techniques. *Fertil Steril* 61:411–422
- Schlatt S, Rosiepen G, Weinbauer GF, et al (1999) Germ cell transfer into rat, bovine, monkey and human testes. *Hum Reprod* 14:144–150
- Schmidt KL, Larsen E, Bangsboll S, et al (2004) Assisted reproduction in male cancer survivors: fertility treatment and outcome in 67 couples. *Hum Reprod* 19:2806–2810
- Schrader M, Müller M, Sofikitis N, Straub B, Miller K (2003) “Onco-tese”: Testicular sperm extraction in azoospermic cancer patients before chemotherapy – new guidelines? *Urology* 61: 421–425
- Sherman JK (1986) Current status of clinical cryobanking of human semen. In: Paulson JD et al (eds) *Andrology*. Academic, Orlando, pp 517–547
- Sherman, JK (1990) Cryopreservation of human semen. In: Keel BA, Webster BW (eds) *CRC handbook of the laboratory diagnosis and treatment of infertility*. CRC Press, Boca Raton, FL, pp 229–259
- Shufaro Y, Prus D, Laufer N, Simon A (2002) Impact of repeated testicular fine needles aspirations (TEFNA) and testicular sperm extraction (TESE) on the microscopic morphology of the testis: An animal model. *Hum Reprod* 17:1795–1799
- Silber SJ, Van Steirteghem AC, Liu J, et al (1995) High fertilization and pregnancy rate after intracytoplasmic sperm injection with spermatozoa obtained from testicle biopsy. *Hum Reprod* 10:148–152
- Smith KD, Steinberger E (1973) Survival of spermatozoa in a human sperm bank. *J Am Med Ass* 223:774
- Tedder RS, Zuckerman MA, Goldstone AH, et al (1995) Hepatitis B transmission from contaminated cryopreservation tank. *Lancet* 346:137–140
- Tomlinson M. (2005) Managing risk associated with cryopreservation. *Hum Reprod* 20:1751–1756
- Trottmann M, Becker AJ, Stadler T, et al (2007) Semen quality in men with malignant diseases before and after therapy and the role of cryopreservation. *Eur Urol* 52:355–367
- Verheyen G, Pletincx I, Van Steirteghem A (1993) Effect of freezing method, thawing temperature and post-thaw dilution/washing on motility (CASA) and morphology characteristics of high-quality human sperm. *Hum Reprod* 8:1678–1684
- Viviani S, Ragni G, Santoro A, et al (1991) Testicular dysfunction in Hodgkin’s disease before and after treatment. *Eur J Cancer* 27:1389–1392
- Wang R, Sikka SC, Veeraragavan K, et al (1993) Platelet activating factor and pentoxifylline as human sperm cryoprotectants. *Fertil Steril* 60:711–715
- Watson PF (1995) Recent developments and concepts in the cryopreservation of spermatozoa and the assessment of their post-thawing function. *Reprod Fertil Develop* 7:871–91
- Watson PF, Critser JK, Mazur P (1992) Sperm preservation: fundamental cryobiology and practical implications. In: Templeton AA, Drife JO (eds) *Infertility*. Springer Verlag, New York/London/Heidelberg, pp 101–114
- WHO (2009) *Laboratory manual for the examination and processing of human semen*. WHO, Geneva, (in press)
- Wolf DP (1995) Semen cryopreservation. In: Keye WR, Chang RJ, Rebar RW et al (eds) *Infertility evaluation and treatment*. W.B. Saunders, Philadelphia, PA, pp 686–695
- Woods EJ, Benson JD, Agca Y, et al (2004) *Fundamental cryobiology of reproductive cells and tissues*. *Cryobiology* 48: 146–156

Contents

25.1	Introduction and Overview	521
25.2	Psychological Conditions of Unwanted Childlessness	522
25.3	Psychological Effects of Unwanted Childlessness	523
25.4	The Psychology of Male Fertility Disorders	524
25.5	Psychological Aspects of the Desire for Children	525
25.5.1	Acceptance of Multiple Pregnancies.....	526
25.6	The Role of Clinical and Psychosocial Factors in the Indication and Contraindication of Therapeutic Procedures	526
25.6.1	Psychosocial Consultation Within an ART Team for Persons Seeking Parenthood.....	527
25.6.2	Aims of Psychotherapeutic Intervention.....	528
25.6.3	Effects of Psychotherapeutic Intervention.....	529
25.6.4	Further Psychosocial Developments Following Infertility Treatment with Special Reference to Family Constellations.....	529
25.6.5	Outlook and Future Psychological Research.....	533
	References	534

25.1 Introduction and Overview

The World Health Organisation (WHO), which, as early as 1967, recognized unwanted childlessness as a disease, anticipates an approximate increase of two million new infertile couples. Many couples try to overcome this difficult crisis with the help of reproductive medicine. The medical and psychological opportunities regarding treatment, consultation and therapy available to the couple to overcome this crisis are extremely important.

The present-day techniques of assisted reproduction (ART) belong to the areas of modern high-tech medicine. In addition to traditional methods such as surgery, hormone treatment and insemination, these include in-vitro fertilization (IVF), intracytoplasmic sperm injection (ICSI), including cryotransfer, testicular sperm extraction (TESE), microsurgical sperm aspiration from the epididymis (MESA), as well as the donation of gametes (Chap. 23).

In 2006 almost 60,000 IVF, respectively ICSI treatments were carried out. The success rate of IVF and the ICSI treatments measured by the baby-take-home rate was between 16.9 and 22.3% in 2005 (Deutsches IVF-Register 2006).

The decision for invasive infertility therapy can be seen as the expression of a conscious decision to become parents. On the other hand, developments in reproductive medicine could also give the couples desiring a child the impression that they can put off realizing this wish until they are older, thus causing a postponed wish to have a child to become an unfulfilled wish for a child (Wischmann 2006b).

At the beginning of infertility treatment, the majority of unintentionally childless couples have unrealistically high expectations regarding its success. Thus the

R. Oberpenning (✉)
 Clinic for Urology and Paediatric Urology, St.-Agnes Hospital
 Bocholt, Germany
 e-mail: f.oberpenning@st-agnes-bocholt.de

general public assess the birth rate as 40% of each embryo transfer (Stöbel-Richter et al. 2006). A relatively large number of couples discontinue therapy because of psychological stress, others find it very hard to cope with their unfulfilled wish for parenthood and are hard put to find any alternative life prospects.

In the course of this chapter, the following psychological themes will be treated:

- Former and current psychological research on the unfulfilled desire for a child with particular consideration of the psychological conditions and effects of infertility
- Psychological aspects of the desire for a child
- The role of psychosocial factors in the indication/contraindication for therapeutic procedures
- Effects of psychosocial/psychotherapeutic interventions
- Further psychosocial developments following infertility treatment with particular consideration of selected family constellations (e.g., families with twins or other multiple births, starting a family by donor insemination, donor eggs, donor embryos or adoption)
- Prospects and future psychological research

25.2 Psychological Conditions of Unwanted Childlessness

When categorizing the psychological studies on the conditions of unwanted childlessness, personality-psychological, psycho-dynamic, stress-theoretical and psychobiological approaches can be distinguished.

At the end of the fifties and the middle of the sixties, personality-psychological approaches, which saw infertility in relation to certain personality traits of those concerned, were dominant among psychological investigations on unwanted childlessness (Sturgis et al. 1957). Thus, a great number of psycho-vegetative complaints were attributed to infertile couples, and childless couples were seen as mainly depressive, fearful and inhibited personalities. Comparative psychological investigations on fertile and infertile couples in the seventies and eighties expressed reservations towards the concept of “psychogenic infertility” or refused to attribute male/female infertility to certain personality traits or emotional disorders (Seibel and Taymor 1982).

More recent results of a prospective study on 1,088 women before and during their first IVF or ICSI treatment support the above-mentioned reservations since there is no connection between the variables of “fearfulness” or “depression”, on the one hand, and the fertilization or pregnancy rates, on the other hand (Lintsen et al. 2006).

In a study on the psychosocial aspects of unwanted childlessness Wischmann and Stammer (2001) plead for depathologizing childless couples because no psychosocial predictors for the start of a pregnancy could be determined. There were merely some indications that men’s being unburdened was a predictor for pregnancy initiation. Thus psychological traits as a predictor for infertility proved to be of no use.

Further investigations on the psychological characteristics of couples’ involuntary childlessness should rather pursue prevention of infertility since knowledge about the complexities of conception is often insufficient among the general public. Forty percent of the persons questioned in a representative study in 2007 (Institute for Demoscopy Allensbach 2007) presumed, for example, that it only becomes more difficult for a woman to conceive from the age of 40 onwards. Approximately 20% of couples report to their physician that they do not have sexual intercourse during the time which is optimal for conception. Moreover, many unintentionally childless couples are not aware that the consumption of nicotine can limit the man’s ejaculation parameters. For example, the success rates of ICSI treatment are significantly lower if the male partner smokes (Zitzmann et al. 2003). Smokers who are ignorant of this could be offered a withdrawal-from-nicotine program aimed at conveying appropriate coping strategies in order to improve chances of successful treatment in the future.

The stress theory of infertility formerly assumed that persisting stress caused various reduced organic functions and that a subjectively experienced stress situation can lead to infertility resulting from disturbed endocrine functions. Schuermann in 1948 and Stieve in 1952 suspected that extreme stress impulses such as, for example, death sentences, wartime events, imprisonment and internment in a concentration camp are accompanied by anatomically recognizable alterations in gonads and can reduce sperm production. This theory stimulated research into male infertility based on stress theory. The following studies further differentiated connections between stress and infertility according to

the kind of stress (e.g., stress burdens in the private/professional area) and ejaculation parameters (Stauber 1979; Poland et al. 1986).

Psychobiological investigations pursued stress theory and attempted to determine those psychological factors which are a part of the organism's stress reaction. In the mid 1980s Hellhammer et al. 1985 investigated the possible connection between personality and infertility. The surprising result of these investigations was that infertile men displayed personality characteristics such as self-confidence, extroversion and social competence, whereas persons with a tendency to depression, introversion and social fear showed higher fertility parameters (Hubert et al. 1985).

Stress-induced infertility is seen in connection with specific forms of coping and specific personality traits. Men with idiopathic infertility compared to a fertile male control group showed no significantly greater tendency to active coping (Deipenwisch et al. 1994). In active coping, individuals do not avoid stress situations and rather tackle them actively, thus possibly changing them in such a way that the burden may be reduced. It appears worth noting that men with idiopathic infertility, compared to the control group were characterized by a greater regularity in the rhythm of daily activities as well as in the pattern of sleep quality (Matzen et al. 1999).

In a current study with 157 test persons, a general connection between psychological stress factors (job stress/life-event stress) and semen parameters could not be proven. However, in one case, the death of a close relative correlated significantly with a temporary reduction of sperm motility (Fenster et al. 1997).

Although lower stress levels promote natural fertility, stress reduction in infertile couples has not been proven to lead to successful fertility treatment (Campagne 2006). Nevertheless it is conceivable that an initial therapy for stress reduction can reduce the number of treatment cycles required, prepare the couple for possible unsuccessful treatment, or can make further invasive measures unnecessary.

Even after 40 years of research, the connections between psychological stress (as cause or reaction) and infertility have still not been fully explained and doubts about the concept remain (Sanders and Bruce 1997; Wischmann 2006a).

Psychodynamic investigations in the 1950s were based on psychoanalytic theory and regarded the repression of psychological conflicts as the central factor in the conditional connection with infertility (Jacobsen 1946; Langer 1953). With particular consideration of the couple's relationship, which was described as clinging and symbiotic (Stauber 1979, 1989), involuntary childlessness appeared as a common symptom of a couple to fend off other psychic problems (Goldschmidt and De Boer 1976). Even if these and similar investigations contained stimulating ideas on psychological conflicts as possible conditions for infertility, they could not adequately and, in fact, rather only speculatively explain the reciprocal relationship between psyche and soma (Bents 1985; Ulrich 1988). More recent studies conclude that it is now time to put the concept of "psychogenic sterility, as psychoanalysis sees it" to rest since, when all is said and done, women with serious psychological problems can also become pregnant without any difficulties (Apfel and Keylor 2002).

According to the current guidelines for psychosomatically oriented diagnosis and therapy of fertility disturbances, a fertility disturbance of psychological origin (Strauß et al. 2004) can be said to exist if a couple

- In spite of medical counselling, behaves in a manner detrimental to achieving fertility (e.g., substance abuse, high-performance sports, extreme professional stress, eating disorders, etc.)
- Do not have sexual intercourse on fertile days, or if there are no organically caused disturbances of sexual function
- Agree to medically indicated fertility treatment, but fail to initiate it after a long period of consideration (e.g., checking tubal patency or recording semen parameters, etc.)

At present the prevalence of infertility of psychological origin may be assessed at 5% (Wischmann 2006a). In contrast, idiopathic sterility, a medically unexplained fertility disturbance, has a frequency of approximately 10%.

25.3 Psychological Effects of Unwanted Childlessness

Investigators' statements vary considerably according to their psychological orientation (e.g., psychoanalysis, behavioral or cognitive psychology), according to

the cause of infertility (on the part of the woman, the man or both partners) or according to the strength of their desire to have a child. The fact that infertility represents a very stressful life happening is, however, mainly confirmed. In most of the studies, women were more fearful, depressive and had less self-confidence than those in the control groups throughout infertility treatment. Moreover, the longer the treatment period, the lower the level of contentment regarding partnership and sexuality, the latter of which was caused by the necessity to have sexual intercourse at the time prescribed (Eckert et al. 1998; Strauß et al. 2004).

In the study by Hölzle et al. (2000), the connection was clearly evident between women's sense of how impossible it would be for them to conceive of a life without a child and the low rate of pregnancies. Strauß, on the other hand, found a higher rate of pregnancies among women who idealized pregnancy.

A model for the process of coping with a diagnosis of infertility suggests eight phases, comprising: shock, denial, annoyance-anger related to not becoming pregnant, a sense of guilt and shame, isolation, depression, grief and, in the end, acceptance of the diagnosis (Guttormsen 1992). Skipping over the acceptance phase of the diagnosis of infertility can result in a considerably higher level of stress during medical treatment of these couples (Onnen-Isemann 2000).

Studies concerned with the emotional preconditions and long-term results of childlessness indicate that, in the case of some couples, their regrets about childlessness increase with age and that these negative thoughts affect their subjective well-being (Wirtberg et al. 2007). Women generally feel more burdened by not having children than men, both in the short and the long-term (Hjelmstedt et al. 1999). Partners who were both responsible for not having children generally remain together more often than couples in whom only one of the partners was the cause of childlessness (Snarey et al. 1987).

In a followup-examination of couples with heterologous treatment by insemination, the highest rate of separation occurred among those who had not managed to have children either by means of the treatment or by adoption or by spontaneous pregnancy (Goebel and Lübke 1987): on the other hand, an investigation of IVF couples ascertained that the couples on average assessed their marital contentment as greater after conclusion of treatment than beforehand, regardless of whether the treatment was successful or not (Leiblum et al. 1987).

The first retrospective study which dealt with the different coping styles of 281 IVF or ICSI couples

(Beutel et al. 1999) showed that women, regardless of the kind of treatment, had significantly more depressions than the reference population and their male partners. The men of the ICSI/MESA/TESE group felt considerably more responsible for the infertility, and less content with their daily life, as a result of the partly stressful kind of treatment. All in all, the investigation considered the following groups at risk for depression:

- Unsuccessfully, or repeatedly treated couples
- Couples with lower social status
- Couples of foreign nationality and
- Couples in which the male partner does not provide adequate support to his partner in a properly sympathetic manner

An important and psychologically influential component of IVF/ICSI treatment is the uncertainty during ovarian stimulation, fertilization, embryo transfer and while waiting for the result of the pregnancy test. This uncertainty is accompanied by ambivalent feelings, emotional stress and positive feelings such as hope and confidence. Accordingly, conveying the results of the examination to the couple as quickly and realistically as possible can greatly reduce their sense of stress (Boivin et al. 1998).

Nowadays there is agreement that unwanted childlessness or limited fertility of couples can be understood as a bio-psycho-social occurrence. The results of psychological examinations which were reached with standard measuring instruments and control groups mostly reveal no or unessential differences between fertile couples and those with disturbed fertility.

Couples desiring children do not show any psychopathological peculiarities. There are only higher levels of depression, fear and psychosomatic complaints among the women, which can, however, be regarded as the result of infertility treatment/therapy (Strauß et al. 2004).

25.4 The Psychology of Male Fertility Disorders

There are also disorders among the males in almost half of the couples with an unfulfilled desire for offspring. Only after methods such as MESA/TESE/ICSI/

became available, was treatment of serious fertility disturbances in males possible.

When an andrological factor is involved, there are indications of mildly raised levels of fearfulness and increased psychosomatic complaints among the men afflicted (Kedem et al. 1990; Glover et al. 1996). Research into the treatment of serious male fertility disorders indicate that during this treatment the man feels more seriously responsible for childlessness than before, and perceives the therapy, especially MESA/TESE, as a stressful experience (Beutel et al. 1999).

During the counselling sessions infertile men often report a sense of guilt towards their partner, who normally bears the main burden of the treatment. Studies in which the cause of infertility lies with the man indicate greater emotional stress on the man (Nachtigall 1992; Beutel et al. 1999), especially among those who are vulnerable for stress situations in general and rather deal with them in a passive manner or avoid coping (e.g., resignation). Thus, a longitudinal section study on 120 men who were involuntarily without offspring found that raised stress levels correlated with reduced semen parameters (Pook et al. 2004). Moreover, men less often seek social support to help them cope better with their unfulfilled desire to have a child (Band et al. 1998). Besides, men who are solely responsible for the infertility show a more negative attitude to sexuality (Fischer et al. 1996) as they often equate sexual potency with fertility. Often disappointment about infertility turns into loss of interest in sex (Chap. 26).

25.5 Psychosocial Aspects of the Desire for Children

The motivation for offspring is essentially formed by parental upbringing and society.

It is well known from research on bonding that individual experiences with most important role models can decisively influence later expectations, behavior and experience in relationships (Gloger-Tippelt 2001). A study carried out on 331 persons aged from 18 to 50, on recollections of parental upbringing and their own wishes for parenthood indicated that the behavior of parents which was recalled as “negative/disapproving, overprotective and not emotionally warm enough” was connected with such motives (e.g., fears regarding personal limitations and a lack of support) which tend to be opposed to fulfillment of one’s

Table 25.1 Reasons for desire for a child according to (Lalos et al. 1985)

Philosophical motives
Hopes for immortality through one’s own children
Ensuring human survival
Meaning of life
God’s will
Socio-cultural motives
Satisfying social needs
Improving the woman’s or the man’s status
Interpersonal motives
Confirmation of relationship by pregnancy
A child as the expression of a couple’s love
Intrapsychological motives
Confirmation of one’s own sexual identity
Replacement for another lost person
Understanding and identification with one’s own parents
Revival of one’s own childhood
Sign of independence

own desire for children. At the same time, there was a stronger wish for a child among persons with negative recollections of their parents’ manner of upbringing in expectation of satisfying desire for social recognition. There were, however, no relevant connections found between the recollection of their parents’ manner of rearing them and the intensity of their desire for a child (Schumacher et al. 2002).

In the event of childlessness social pressure on the couple can reduce their self-esteem considerably. When infertile couples are asked about their wish to have a child, they normally mention the motives listed in Table 25.1.

These motives clearly show the wish not only to be there for oneself and one’s partner. Frequently the motives for a pregnancy are ambivalent, i.e., together with the wish for a child, there is also the fear of the pressures and limitations related to it. Together with the “first” decision to want to have a child, the decision becomes of importance for unwillingly childless couples whether, and to what extent, medical help is taken to fulfil their desire for children.

For a long time, the investigation into the male desire to have children was neglected. The representative study “Männer leben” (men’s lives) (Federal Centre for Health Education (BZgA) 2004), found a time window for becoming a father ranking from “too young” to “too old”. Thus 60% of 25–34-year-old men do not have children as opposed to only 25% among the 35–44-year-old men. Compared to the study “Frauen leben” (women’s lives) (BZgA 2001), it is

Fig. 25.1 The influence of net income on the number of children of 40-54 year old men (n=660) (“Men’s lives”, BZgA 2004)

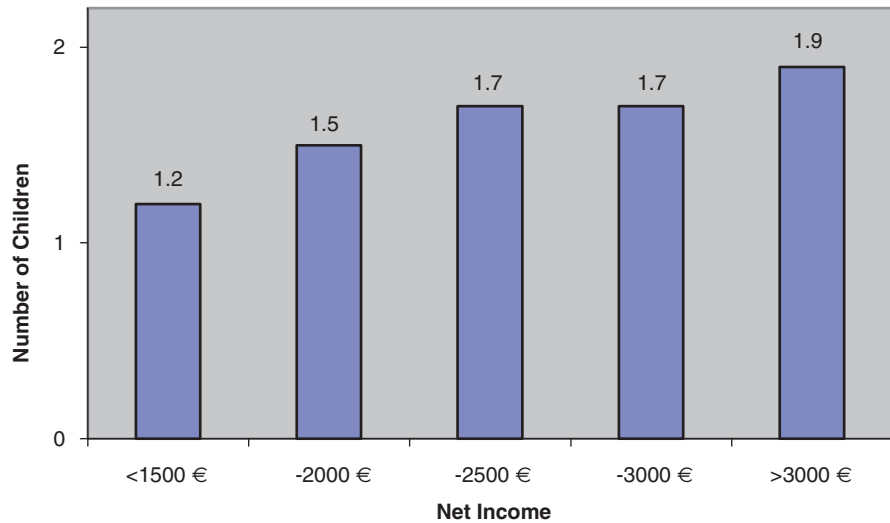

clear that men only manage to complete the transition into parenthood later than the women. Furthermore, highly qualified men rather tend to have children than poorly qualified ones (Fig. 25.1), whereas in the case of women, it is the other way around. Poorly qualified women more frequently have children than those highly qualified. The higher their income, the earlier men marry and have children. Forty percent of men with a net income below €1,000 live without children and without a permanent partner. On the other hand, the highest income group (>€2,500 and more) comprises only a small number of men without children.

25.5.1 Acceptance of Multiple Pregnancies

Before they started their first IVF cycle, 95% of American couples stated that they would prefer a pregnancy with triplets, and, in 70% of the cases, even a pregnancy with quadruplets rather than not become pregnant (Goldfarb et al. 1996; Bindt 2001). In addition, an analysis of new studies relating to the desire to have children between 1990 and 2004 indicated that couples wishing to have children have a great preference for a pregnancy with twins and a medium-to-great preference for a pregnancy with triplets, and, it must be said, that the older the woman, the stronger her preference for multiple pregnancy (Borkenhagen et al. 2004). If, however, the problem of multiple births is discussed between the physician and the patient regarding the

emotional and cognitive level of decision, women who cannot have children become less accepting of multiple pregnancies (Grobman et al. 2001; Kowalcek 2008).

Couples are frequently unrealistic in their assessment of the burden of stress brought about by multiple births, especially since there is a great lack of information on this aspect of the question. For example, when the amount of work related to families with triplets in the first postnatal year was investigated, a theoretical level of 190h per week was achieved (Mariano and Hickey 1998). Behind the wish of many couples for a multiple birth at the beginning of reproductive medical treatment there might well be, apart from the motives of rational family planning, unconscious concepts of repairing the “hurt through infertility” (Bindt 2001).

25.6 The Role of Clinical and Psychosocial Factors in the Indication and Contraindication of Therapeutic Procedures

When considering psychological developmental research on life-span, parenthood is given as a structural point of the normative transition in the course of life (Gloger-Tippelt 1988). Coping or not coping with a psychosocial task is decisive for favorable or unfavorable development of the individual. A mature adult must feel that he is needed (Erikson 1976). Accordingly, if a pregnancy does not occur, the individual or the couple may experience a development crisis.

Under certain circumstances, infertility may be seen as the worst critical life event, followed by divorce and the death of a loved one.

Apart from somatic criteria, psychosocial criteria play a comparatively marginal role in the indication for assisted fertilization.

Psychosocial counselling and possibly therapy in the context of infertility therapy should be offered to everyone afflicted by unwanted childlessness before, during and after treatment. This seems imperative, particularly in the cases of psychogenic sterility as well as gamete donation.

Contraindications for medical therapy in the case of fertility disturbances, from a psychosomatic point of view are (Bundesärztekammer 2006):

Absolute Contraindications

- All contraindications for pregnancy

Limited Contraindications for Pregnancy:

- In individual cases a pregnancy-related high medical risk for the health of the woman or the development of the child
- Psychogenic fertility disturbance: This may develop especially when sexual disturbances may be an essential factor in infertility (infrequent sexual intercourse, avoiding intercourse at the optimal time for conception, non-organically caused disturbance of sexual function). In this case, sexual consultation for the couple should first be carried out

25.6.1 Psychosocial Consultation Within an ART Team for Persons Seeking Parenthood

The current guidelines of the Federal Medical Board (Hoppe 2006) urgently recommend psychosocial counselling by ART teams of couples seeking help. In Germany at least one member of an ART team should be qualified in basic psychosomatic care. Doctors working in reproductive medicine should cooperate with the independent counselling networks in their country, such as, for example, the advisory network Kinderwunsch in

Deutschland (BkiD), the British Infertility Counselling Association (BICA), the Mental Health Professional Group (MHPG), the American Society for Reproductive Medicine (ASRM) among others.

If persons concerned contact an independent outside organization, the latter should refer them to a medical reproductive center regarding medical care. Although all professional groups of an ART team, such as physicians, psychologists, social workers etc. basically agree about the need for psychosocial support for a couple who remain unwillingly childless, there are considerable differences in the basic psychosocial qualifications required (Kentenich and Tandler-Schneider 2008; Thorn and Wischmann 2008).

The basic precondition for psychosocial consultation for couples seeking parenthood should always be the couple's own motivation, which can be stimulated and supported by information from written brochures, general literature concerning "unwanted childlessness" from videos, internet pages and self-help groups. The treating physician should provide an opportunity to ask questions about the treatment. He should explain its effects and side-effects and its risks (e.g., emotional crises, such as depression, fears, disturbances of sexual function (Chap. 26), multiple pregnancies, malformations). Detailed and honest explanation about the realistic chances of success may prevent premature discontinuation. Three factors characterize the expectations of infertile couples regarding optimal medical treatment (Schuth and Keck 2001):

1. Correct procedural information and explanation
2. Stressfree diagnosis and therapy according to currently valid standards
3. Offers of psychosocial help for any crisis

Infertile couples have to make many decisions, e.g., regarding

- Whom they consult for treatment
- When they undertake treatment for infertility
- Form and consequences of treatment (e.g., the genetic father in the case of donor insemination, the biological mother, in the case of ovum donation, possible step – siblings etc.)
- When they want to end treatment
- Alternatives if their desire to have a child is not fulfilled

Needless to say, ensuing conflicts and tensions are understandable. As well as coping with such typical conflicts,

psychotherapeutic procedures should be offered to the couples to help deal with the experiences of loss.

Within the framework of initial psychosocial consultation couples who have developed an alternative life plan (e.g., life without children, further professional qualification, adoption and fostering a child), can, as a rule, better deal with unsuccessful treatment.

Table 25.2 presents the areas which can be discussed with an infertile couple together with clinical data to help medical professionals survey the couple's psychological as well as social situation.

25.6.2 Aims of Psychotherapeutic Intervention

The aim of psychotherapeutic intervention is, first and foremost, to support the couple, rather than to discover conflicts or initiate a pregnancy. Couples who are clearly psychogenetically sterile (cf. criteria for contraindication – Sect. 25.2), should be referred to sexual therapy, or individual and group therapy before beginning invasive infertility treatment. This is required before the ART team can decide whether medical treatment is promising. In general, however, offering the couples psychosocial advice regarding the physically and emotionally burdensome treatment suffices.

Couples from other cultures or with a strong religious orientation may have reservations about certain methods of treatment; these have to be resolved prior to the beginning of therapy (Gacinski et al. 2000). Moreover, possibilities for dealing with the fertility disorder should be discussed. A conscious period of mourning for the loss of a prospect of “life with a child” is important to be able to cope with long-term childlessness. Coping strategies, such as “brooding” or “remaining stuck in a feeling of powerlessness,” as well as “focusing on children as an essential aim in life” have proven disadvantageous (Strauß 2000).

At present, short-term psychotherapeutic procedures for supporting infertile couples are increasingly being implemented. In this context, from the beginning of the first session, the therapist focuses on areas in which the client has already been successful, thus enhancing potential for self-reinforcement. No attempt is made to solve the problem comprehensively because, in the theory of short-term therapy, it is assumed that the solution itself is its own best explanation. The following consultation and therapeutic aims demonstrate

Table 25.2 Guidelines for recording the psychosocial situation of patients during office hour/consultation on fertility (Lalos et al. 1985)

Anamnesis/ anamnesis of couple/ history of couple
Getting to know one another, development of the couple's relationship
Couple's motivation for wanting to have a child
Assigning special roles within the couple's relationship
Changes in the couple's relationship as a result of the diagnosis of infertility
Subjective theories
Subjective assessment of the cause of childlessness
Possible accusations (e.g., earlier abortions, infections etc.)
Fantasies regarding the as-yet unborn child
Sexuality (cf. also Chap. 26)
Contentment with one's current sex life
Frequency and quality of sexual intercourse
Sexual role identity as male/female, or as the case may be
Importance of sex for the relationship
Possible changes in one's sexuality as a consequence of one's unfulfilled desire for a child
Psychosomatic aspects and coping processes for involuntary childlessness (how does the couple deal with it emotionally, intellectually, in concrete actions and in the couple's relationship?)
Typical psychological complaints, such as depression, fear, etc.
Psychosomatic complaints, such as tension headaches
Sleep disturbances, stomach complaints etc.
Body image and health behavior
Dealing with, and attitude to one's own body (e.g. health)
Behavior in general and in stress situations, subjective
Assessment of physical deficits, such as a small breast or penis etc.
Social situation
Economic conditions
Professional position/contentment
Social/emotional support by friends, acquaintances, close family members
Leisure-time behavior
Alternatives to the desire for children
Attitude to adoption/fostering
Considering possible professional/social compensations
Further goals in life, with or without a child

a psychotherapeutic procedure for the involuntarily childless (Atwood and Dobkin 1992; BkiD 2007):

1. Acceptance of the infertility crisis
2. Acquisition of appropriate styles of communication, and learning how to deal creatively and constructively with the unfulfilled wish for a child, as well as recognizing and changing obstructive behavior (e.g., professional stress, poor eating habits, alcohol and nicotine abuse)

3. Provision of information (e.g., surgery, prospects of success, limitations of psychology, academic medicine, alternative medicine and other therapeutic procedures (e.g., relaxation exercises)
4. In the case of gamete /embryo donation, the question of long-term consequences of this way of founding a family
5. Redefinition of the problem with infertility (e.g., with the help of metaphors)
6. Clarifying the effects of infertility on the partnership, family, friends and job
7. Raising awareness that starting a pregnancy cannot be controlled by the couple
8. Raising awareness of the couple's exceptional situation or the alternative positive rewards (e.g., questions such as: is it true that you always think of your infertility?)
9. Redefining the couple's real situation
10. Presenting future perspectives

During or after such a consultation/therapy, the couple then define for themselves the importance of the fertility problem. Nowadays, when they are older, women and men without children of their own are frequently painfully reminded of their former own inability to have children, when in their circle of friends of the same age, grandchildren are born (Wirtberg et al. 2007). To date no concept for advising and treating this clientele has been developed.

25.6.3 Effects of Psychotherapeutic Intervention

The research presented below essentially includes behavioral therapy, discussion psychotherapy, psychoanalytically oriented concepts of therapy, as well as methods from relaxation procedures.

Thus five out of 15 patients became pregnant 4 months after the end of behavioral therapy for couples à la Hahlweg et al. (1982). Moreover increased sperm numbers, improved communication as well as reduced levels of fear were ascertained in the couple's relationship (Bents 1991). In seven out of 15 patients, a pregnancy was initiated after short-term psychotherapy (three–four sessions) prior to IVF-therapy (Brandt and Zech 1991).

Essential improvement of infertile patients' level of knowledge regarding infertility and its causes, conjugal communication and communication strategies in gen-

eral was achieved following an 8-week group psychotherapy once weekly for 2h (Stewart et al. 1992).

Similarly, 17 couples with male factor infertility underwent intervention based on behavior therapy (repeated sexual contacts during the fertile period, emotional stress reduction by exercises based on behavioral therapy, cognitive restructuring of those couples who at first seemed to be unable to induce a pregnancy). The therapeutic group showed a higher birth rate, improvement of sperm concentration, reduction of negative thoughts, such as a sense of helplessness, as well as an improvement of the partnership. Moreover, 6 months after the end of the therapy, the couples who had been unsuccessfully treated had gained greater distance to their desire to have a child (Florin et al. 2000).

Psychosocial interventions have, in cases of infertility, positive effects on the psychological condition of the persons concerned. However, they do not have any significant influence on rates of pregnancy or the special personality traits of the persons concerned.

Basically psychotherapeutic intervention should be offered to the couple as a whole, even if it is well-known that women are more commonly prepared to undergo psychological counselling (cf. also Strauß et al. 1999). In selected cases individual therapy sessions should also be considered.

A meta-analysis of 25 individual investigations showed that although group therapy (psychological education, relaxation procedures) was, in fact, more effective than individual therapy (Boivin 2003) and a further meta-analysis showed positive effects on the persons' psychological reactions (e.g., anxiety and depression), there was no positive effect on the pregnancy rates of the women (de Liz and Strauss 2005). Nevertheless, no negative effects of therapy have been heretofore reported in the literature.

25.6.4 Further Psychosocial Developments Following Infertility Treatment with Special Reference to Family Constellations

Family conditions and constellations after successful medical reproductive treatment may differ considerably.

First of all, successful achievement of parenthood may curtail marital contentment for a period of time. During pregnancy, IVF mothers fear often that their pregnancy will not continue. Thus the child's room may only be assembled in the postnatal period. Men, on the other hand, frequently express fear that the ICSI child may be physically impaired. At the present time there may be some statistical support for these fears. Palermo et al. (1996) found that the frequency of serious physical impairments among ICSI children was not greater. However, in a more recent meta-analysis of 25 studies, the authors come to a different conclusion, namely ICSI children have an increased risk of 30–40% for serious malformations or chromosomal anomalies (Hansen et al. 2005). In a prospective study among 3,372 children, serious malformations were seen in 8.7% of the cases, in comparison to 6.1% of a group of 8,016 children born after spontaneous conception (Ludwig and Katalinic 2005). This means that in every 12th pregnancy after ICSI and in every 15th pregnancy after spontaneous conception malformations must be expected. The study also showed an increased risk for the development of the pregnancy and birth after ICSI. Here the degree of the male's subfertility was not relevant.

The authors, however, attribute this increased rate of malformations less to the procedure as such, but rather more to the genetic constellation of the parents. This is why it is important to inform couples about risks when conception takes longer than 12 months.

The parent–child relationship among IVF children and their psychological as well as social development is generally considered to be unproblematic (Strauß et al. 2004). Nevertheless, IVF mothers tended to worry more about their child's well-being in the first year of life, which can probably be seen in relation to the period of waiting for fulfilment of their desire to have a child (Gibson et al. 1998). Golombok et al. 2002 found that such parents had a tendency to overprotect their IVF children. All in all, however, the mothers and fathers of IVF children excel in their extraordinary parental competence and warmth.

The fields of family sociology and family psychology have created a new definition of the concept “family” in recent years, since in Germany too the classical father-mother-child family can no longer be considered as the most common way of life. The

family sociologist Hans Bertram emphasizes: “Family members are mostly relations, although they do not have to be. From the point of view of those questioned, however, not all persons who could belong to the family are, in fact, members of their family. On the other hand, persons are considered as being part of their own family who do not in fact belong to it, according to general understanding” (Bertram 1991). This statement and the following forms of family presented indicate what great variety of family forms are possible by means of ART.

25.6.4.1 Twin and Multiple Birth Families

Reports based on the experiences of twin and multiple birth families show that these have underestimated the degree of prenatal complications in pregnancy, as well as psychosocial burdens, particularly the social isolation of the mother (Bindt et al. 1998). They also show that premature birth and a birth weight <1,500 g are associated with impairment of the cognitive and social development of the child, which only manifest themselves when the children start school (Bindt 2001).

IVF parents with twins, in comparison to the control group, feel under greater stress by having to rear twins (Cook et al. 1998). The parental, especially the maternal burden, is particularly high with regard to bringing up triplets. Thus in a prospective study over a period of 2 and 4 years Garel et al. (1997) found that the mothers felt “seriously” to “very seriously” emotionally stressed throughout the whole period of investigation. The majority complained about stress situations in child rearing (dealing with children's aggressions and conflicts regarding closeness and distance to their three children), as well as about the increased fatigue caused by caring for three children at the same time. Of the 11 mothers of triplets, four had high levels of depression and were taking tablets/medication. During the questioning four mothers reported spontaneously that after 4 years they regretted having triplets because of great physical and psychic pressure. Even if this research represents only a random sampling it makes the extremely high pressure on multiparous families abundantly clear.

The parent–child relationship among multiparous parents is always quantitatively reduced. They are

required to build up a parent–child relationship to several potentially difficult babies at the same time. As a result, mothers of triplets establish a delayed or impaired bonding relationship to their children (Garel et al. 1994).

Mothers of triplets tend to withdraw emotionally from all their children (Robin et al. 1991). In the case of 54 triplets, a rate of 20% deaths at birth and early deaths of children were ascertained (Roest et al. 1997). Of 18 parents of triplets in this random sampling, six were confronted by the death of at least one of their children. Generally, multiparous children tend more towards disturbances of behavioral and language development (Bindt 2001). More recent research on families with multiple births following ART, in comparison to families with individual children, indicated that the birth of twins or triplets causes considerable problems for the parents bringing them up during the first years. Individual twin and triplet children themselves also showed a low degree of delay in language development throughout this investigation. On the other hand, psychological behavior-associated problems of multiple birth children were not discovered (Golombok et al. 2007).

Because of these pressures on families with multiple births, the Federal Medical Board recommends that for patients under 38 years only two embryos be transferred in the first and second cycles. In the case of more than four fetuses, the Medical Board favors selective abortion with a view to reducing risks for mother and child, even at the risk of a possible complete loss of pregnancy. At the present time single-embryo-transfer is being discussed on the international level.

It is clear that families with multiple births need sufficient social support from members of their family, friends or helpers, such as day mothers, babysitters or au-pairs. The latter can usually not be paid for by the family alone in the long run.

These results show the importance of specialists from the field of psychotherapy and social work within an ART team. They can make the future parents aware of forthcoming psychosocial as well as financial pressures and can offer them possibilities and help to unburden themselves and their children. Well-informed parents can take precautions in advance to provide adequate care of their children, thus allowing for a more carefree pregnancy and fewer complications in parent–child bonding.

25.6.4.2 Family Bonding Through Donor Insemination

The reasons for founding a family through donor insemination are mostly serious disturbances of male fertility, together with rejected or failed reproductive medical treatment. Moreover, avoiding the possibility of transferring an inherited disease to the child can be a motive.

In the USA, about 30,000 infants per year are born after donor insemination. For Europe, the European Society of Human Reproduction and Embryology (ESHRE) recorded altogether 15,000 intrauterine inseminations with donor sperm which were carried out in various European countries in 2002 (Andersen et al. 2006). The leaders among them are Great Britain, with 5,338, France, with 3,321, Spain, with 1,893, and Denmark, with 1,594 annual donor inseminations. According to estimates, more than 50,000 persons are currently living in Germany who have been conceived by donor semen since 1970. Since the introduction of ICSI in 1993, however, the number of children born after donor insemination has been reduced to 1,000 births per year.

Many couples deal discretely with the way their child was conceived in their social surrounds since they fear that their child, who was conceived by donor semen, will be stigmatized. As in Germany the rights and obligations of the father as well as the semen donor have only been established for heterosexual married couples (§ 1,600 BGB, para. 4), donor insemination (DI) is restricted to these. Donor insemination presents a collision of two interests: the possible desire of the child to learn about his/her parental extraction, on the one hand, as well as the donor's possible claim to anonymity, on the other hand (Katzorke 2008).

Currently the latter issue is unclear. Court decisions and legal interpretations allow the assumption that every person of legal age has the right to know from whom he descends (BkiD 2008).

Since 2006, physicians are thus obliged to preserve documentation about semen donors and the recipient couple safely for at least 30 years. A notarial deposition about the right of the child to inspect these documents should be considered and the parents should inform the attending physician who carried out the insemination about the birth of the child.

In countries without anonymous semen donation, the rate of disclosure among the conceived children is, on the other hand, low. In a survey in Sweden, for

example, even 20 years after receiving anonymous donor insemination, 89% of the parents had still not told the children the truth about their extraction. Only 20% of the couples are in favor of informing the children from the very beginning. The following can be counted among the psychological reasons for this reservation (Schilling 1995):

- The fears of infertile men that they could break with their own parents
- The fantasies of the men that the child might later prefer the biological father
- Their own feelings of insufficiency because of infertility

Many German couples are still not at ease with DI. The question of remaining silent or being frank with the child has remained an unsolved problem up to today. This is also reflected by the fact that concepts such as “DI-family” and “DI-father”, common in English usage, do not exist in German, in contrast to other family concepts such as “adoptive family”, “foster family” or “patchwork family” (Thorn 2000). Since, however, family secrets can negatively affect the well-being of all family members, psychosocial experts plead in favor of disclosing the biological identity of the donor, as this – similarly to cases of adoption – can, under certain circumstances, be of great importance for the development of the child’s personality. More recent studies indicate that the rate of disclosure has been increasing in recent years (Daniels et al. 2007).

Research carried out on young adults, who were only informed after puberty about how they were conceived, reported about the concerned persons’ feelings of a loss of trust towards their parents, as well as feelings of frustration and a desire for information about the semen donor (Turner 2000). The fact that the child conceived by DI is told early on about his father can also affect the family system favorably was shown in the study by Lycett et al. (2004), in which informed and uninformed children were compared. The parental competence was more highly esteemed and there was less fighting in the family among the children who had been informed.

Comprehensive research on the psychological social development of DI-children in comparison to children born after infertility treatment, adoption and spontaneous conception showed no significant differences in the development of the children (Golombok et al. 2002). The father–child relationship was unproblematic although there was no genetic relationship between

the two. These results are supported by further investigations (Golombok et al. 2004).

In countries such as the Netherlands, Australia, and Canada, lesbian couples also have donor inseminations performed. Initial fears that the absence of a father could affect the child’s development negatively have not been confirmed to date. Indeed, the children of lesbian mothers also express the wish to know more about the semen donor (Vanfraussen et al. 2001).

25.6.4.3 Starting a Family by Egg Donation

According to the Law for the Protection of Embryos, egg donation is forbidden in Germany at the present time. In the case of egg donation, the mother bearing the child is called the social mother, the father is the biological father. German couples can, for example, have egg donation carried out in neighboring countries such as Spain, the Czech Republic, Slovakia as well as Russia, but also in the USA. Up to now there have been no studies on families who had egg donation carried out abroad, although roughly 450 children are born in Germany every year as a result of the procedure (Kentenich and Utz-Billing 2006).

Studies which have examined family development after egg donation found nothing conspicuous, either among the children or the parents (Golombok et al. 2005; Murray et al. 2006). In comparison to IVF children, children conceived by egg donation showed considerable advantages in language development (Söderström et al. 1998).

Couples deciding for egg donation abroad must, however, face the fact that the identity of the donor is not revealed in all countries. As a result, the child is not given the opportunity to find its real identity or it is, at least, more difficult.

25.6.4.4 Starting a Family by Embryo Donation

Embryo donation is also described as prenatal adoption because, as in the case of adoption, there are parents who give, and parents who receive. Not only parents who have completed their family are motivated to donate an embryo, but also couples who are undergoing infertility treatment and would like to help other infertile couples (Newton et al. 2003). In a study on the attitudes of IVF patients to egg and embryo donation,

it was found that two-thirds would be willing to donate an egg or an embryo. Approximately 47% would decide to accept an egg, and approximately 40% an embryo. Up to now, there are no studies on family dynamics (Weghofer et al. 2002) and the situation of the children in this kind of family system.

At the present time children from the more complex family systems (e.g., lesbian couples with donor insemination, single mothers with donor insemination) do not differ from children from a traditional family with regard to their social and psychological development (Brewaeyts et al. 2005)

The way a child is conceived thus has relatively little influence on its development as a human being. What is important for the child is, above all, how the parents build up a relationship to their child and whether they love him/her unconditionally.

25.6.4.5 Starting a Family by Adoption or Fostering

Those couples who, instead of having their own biological child, decide in favor of adopting or fostering a child can receive much help especially from authorities, such as the Youth Office in charge. It is more common for women to decide in favor of adopting or fostering than men. Men seem clearly to have greater difficulties with accepting a non-genetic child into their family (Leiblum et al. 1998).

The basic precondition for starting an adoption or fostering process is, however, that it be the shared and unconditional decision of the couple to take a child. Nor can the acceptance of a child be seen as an alternative to a biological child. It has proven favorable if the couple's own unfulfilled wish to have a child has been worked through as far as possible up to this time, so that the couple are as free as possible to build up a healthy parent-child relationship and they are able to dedicate themselves to their adopted child without reservations. Couples who have been in therapy for several years who continue to feel at odds with their fate should not see adoption or fostering as the next step towards the goal of having a child. The distress not of having become pregnant is too great for such a couple (von Schelling 1994).

In contrast to donor insemination, adopted children in Germany have, by 16 years at the latest, the right to learn the names of their biological parents, their profession/job, where they live, their nationality and their religion. Generally this information is provided by the agency responsible for the adoption.

This chapter cannot deal with the more or less costly process of adoption/fostering a child. Interested couples should be referred by their physician to the responsible local authority – this also applies to adoptions of foreign children which are recognized in Germany. It must be noted that the number of children who are free for adoption is decreasing. This may well result from decreasing birth rates, as well as from improved psychosocial support of the families of origin, which are often problematic.

25.6.5 Outlook and Future Psychological Research

Undesired childlessness often represents a critical life experience for the couple, which they must cope with, along with the help of specialized physicians and psychosocial experts. Comparative psychological research projects between fertile and infertile couples largely come to the conclusion that there are no significant differences between these couples. So too studies concerned with the psychological differences between fertile and infertile men in particular arrive at similar results.

The connections between psychic stress and infertility as a cause or simply as a reactive effect have not been clarified, even after 40 years of research (Wischmann 2006a). For this reason, studies which aim to prevent infertility should be carried out on a much wider basis.

Even if women are more intensely involved in the medical-therapeutic process than men, men often suffer just as much from their undesired childlessness as women. Investigations into the male desire for offspring indicate that the male desire to have children is just as strong as that of women, although it comes into play at a later time. Men are much more concerned with keeping their infertility secret. This problem becomes particularly clear in the context of psychological investigations regarding foundation of a family by donor insemination.

Because of the varied and complex types of families which can be formed with the aid of reproductive

medicine, it is time to think about a new definition of the concept of family. When the guidelines for psychosocial care of couples who do not wish to remain childless were revised by the Federal Medical Board (BÄK) in 2006, psychosocial consultation of the couple was urgently recommended. This is important before, during and after therapy, and especially during therapy crises when multiple births take place, after successful heterologous insemination, as well as termination of unsuccessful therapy.

For this reason, contributions on a routine basis by social workers/psychologists in fertility centers and practices, as well as by external agencies are imperative, as they provide relief for the couple as well as for medical personnel. Besides informal offers, such as discussion rounds, psychological telephone counseling on IVF/ICSI/DI, physicians' referrals to special internet pages of professional associations and self-help groups, as well as copious multilingual information brochures, have proven useful.

Essential research questions have not yet been sufficiently answered, so that, above all, the following psychosocial and ethical topics of concrete relevance to persons under treatment, to the doctor-patient relationship and to procedures during and after treatment, are worth pursuing:

- Preventative studies with a view to recording further relevant physical and psychic fertility parameters
- Long-term studies on psychosocial and intellectual development of IVF/ICSI children, especially in the case of parents with chromosomal disorders
- Recording psychosocial circumstances of multiple-birth families, also after intrauterine or postpartum child death, with particular consideration of the childhood development of remaining siblings
- Recording the psychological problems and conflict situation of families founded by DI abroad
- Studies on the effects of psychosocial counselling and care of ART-families
- Studies on the advantages and disadvantages of "open" versus "anonymous" gamete donation
- Studies on the relationships of children with varied family constellations to their biological and social parents after ART
- Recording the ethical attitude of lay persons and professionals to various ART techniques and the family constellations possibly resulting from them

- Psychological studies on using ART or surrogate motherhood in constructs beyond conventional family structures (homosexual couples, single men or women)
- Psychological studies on the persons undergoing pre-implantation diagnosis in countries where this is legal
- Investigations on psychological and social consequences, as well as legal formulation of problems in cases of anonymous versus open sperm donation
- Studies on the use of ART in countries with different cultures, religious or ethical and moral concepts

References

- Andersen AN, Gianaroli L, Felberbaum R, de Mouzon J, Nygren KG (2006). Assisted reproductive technology in Europe, 2002. Results generated from European registers by ESHRE. The European IVF-monitoring programme (EIM) for the European Society of Human Reproduction and Embryology (ESHRE), ESHRE Central Office, Grimbergen. *Belgium Hum Reprod* 21:1680–1697
- Apfel RJ, Keylor RG (2002) Psychoanalysis and infertility. Myths and realities. *Int J Psychoanal* 83:85–104
- Atwood JD, Dobkin S (1992) Storm clouds are coming. Ways to help couples reconstruct the crisis of infertility. *Human Sci Press* 14:385–402
- Band DA, Edelmann RJ, Avery S, Brinsden PR (1998) Correlates of psychological distress in relation to male infertility. *Br J Health Psycho* 3:245–256
- Bents H (1985) Psychology of male infertility – a literature survey. *Int J Androl* 8:325–336
- Bents H (1991) Verhaltenstherapeutische Paartherapie bei Kinderwunschpatienten. In: Brähler E, Meyer A (Hrsg). *Jahrb Med Psychol* 5:144–155
- Beratungsnetzwerk Kinderwunsch Deutschland e.V. (BKID) (2007) Richtlinien "Psychosoziale Beratung bei unerfülltem Kinderwunsch". <http://www.bkid.de/richtlinien.pdf>
- Beratungsnetzwerk Kinderwunsch Deutschland e.V. (BKID) (2008) Richtlinien "Psychosoziale Beratung bei Gametenspende". http://www.bkid.de/gs_leitlinien.pdf
- Bertram H (1991) *Die Familie in Westdeutschland*. Opladen, Westdeutscher Verlag
- Beutel M, Kupfer J, Kirchmeyer P, Kehde S, Köhn FM, Schroeder-Printzen I, Gips H, Herrero HJG, Weidner W (1999) Treatment-related stresses and depression in couples undergoing assisted reproductive treatment by IVF or ICSI. *Andrologia* 31:27–35
- Bindt C (2001) Das Wunschkind als Sorgenkind? Mehrlingsschwangerschaften nach assistierter Reproduktion. *Reproduktionsmedizin* 17:20–29
- Bindt C, Berger M, Ohlsen K (1998) Psychosomatische Aspekte zur Elternschaft und kindlichen Entwicklung. In: Brähler E, Goldschmidt S (eds) *Psychosoziale Aspekte von Fruchtbarkeitsstörungen*. Huber, Bern, pp 104–113

- Boivin J (2003) A review of psychosocial interventions in infertility. *Soc Sci Med* 57:2325–2341
- Boivin J, Shoog-Svanberg A, Andersson, Skoog-Svanberg A, Hjelmsstedt, Collins A, Bergh T (1998) Psychological reactions during in-vitro fertilization: similar response pattern in husbands and wives. *Hum Reprod* 13:3262–3267
- Borkenhagen A, Stöbel-Richter Y, Brähler E, Kentenich H (2004). Mehrlingsproblem bei Kinderwunschpaaren. Einstellungen und Informationsgrad zur Mehrlingsschwangerschaft, selektiven Mehrlingsreduktion und zum Single-Embryo-Transfer. *Gynäkol Endokrinol* 2:163–168
- Brandt KH, Zech H (1991) Auswirkungen von Kurzzeitpsychotherapie auf den Erfolg in einem in-vitro-Fertilisierung/Embryotransfer-Programm. *Med Wochenschr Wien* (1–2): 17–19
- Brewaeyns A, Dufour S, Kentenich HJ (2005) Sind Bedenken hinsichtlich der Kinderwunschbehandlung lesbischer und allein-stehender Frauen berechtigt? *Reproduktionsmed Endokrinol* 2:35–40
- Bundesärztekammer(2006)(Muster-)Richtlinie zur Durchführung der assistierten Reproduktion – Novelle 2006. [tp://www.bundesaeztekammer.de/downloads/AssRepro.pdf](http://www.bundesaeztekammer.de/downloads/AssRepro.pdf)
- Bundeszentrale für gesundheitliche Aufklärung (BZgA) (2001) Studie “Frauen leben”. http://www.bzga.de/bzga_stat/pdf/13314000.pdf
- Bundeszentrale für gesundheitliche Aufklärung (BZgA) (2004) Studie “Männer leben”. <http://www.bzga.de/pdf.php?id=30a4b5778bd22b776e8a58342d557ead>
- Campagne DM (2006) Should fertilization treatment start with reducing stress? *Hum Reprod* 21:1651–1658
- Cook R, Bradley S, Golombok S (1998) A preliminary study of parental stress and child behaviour in families with twins conceived by in-vitro fertilization. *Hum Reprod* 13:3244–3246
- Daniels K, Thorn P, Westerbrooke R (2007) Confidence in the use of donor insemination: An evaluation of the impact of participating in a group preparation programme. *Hum Fertil (Camb)* 10:13–20
- de Liz TM, Strauss B (2005). Differential efficacy of group and individual/couple psychotherapy with infertile patients. *Hum Reprod* 20:1324–1332
- Deipenwisch U, Hilse R, Oberpenning F, Nieschlag E, Sader M (1994) Persönlichkeit und Stressverarbeitungsstrategien von ungewollt kinderlosen Männern. *Fertilität* 10:118–121
- Deutsches IVF Register (2006) Jahrbuch 2006. [http:// www.deutsches-ivf-register.de](http://www.deutsches-ivf-register.de)
- Eckert H, Sobeslavsky I, Held HJ (1998) Psychische Merkmale bei Paaren mit unerfülltem Kinderwunsch vor IVF. In: Brähler E, Goldschmidt S (eds) *Psychosoziale Aspekte von Fruchtbarkeitsstörungen*. Huber, Bern, Göttingen, pp 27–50
- Erikson EH (1976) *Identität und Lebenszyklus*. Suhrkamp, Frankfurt
- Fenster L, Katz DF, Wyrobek AJ, Pieper C, Rempel DM, Oman D, Swan SH (1997) Effects of psychological stress on human semen quality. *J Androl* 18:194–202
- Fischer C, Rohde A, Klauen R, Warneros A, Dietrich K (1996) Einstellung zu Sexualität, Schwangerschaft und Geburt bei männlichen Patienten einer Kinderwunschsprechstunde. *Z Med Psycho* 4:176–1985
- Florin I, Tuschen B, Krause W, Pook M (2000) Psychologische Therapie bei idiopathischer Infertilität: Ein Stressreduktionskonzept. In: Strauss B (Hrsg) *Ungewollte Kinderlosigkeit*. Göttingen, Hogrefe, pp 93–118
- Gacinski L, Yüksel E, Kentenich H (2000) Sterilitätsberatung und –behandlung türkischer Paare in der Migration. In: Strauss B (ed) *Ungewollte Kinderlosigkeit*. Psychologische Diagnostik, Beratung und Therapie. Göttingen, Hogrefe, pp 75–89
- Garel M, Chavanne E, Blondel B (1994). Two-year follow-up cohort studies on triplets: Development of children and mother-child relationship. *Arch Pediatr* 1:806–812
- Garel M, Salobir C, Blondel B (1997) Psychological consequences of having triplets: A 4-year follow-up study. *Fertil Steril* 67:1162–1165
- Gibson FL, Ungerer JA, Leslie GI, Saunders DM, Tennant CC (1998) Development, behavior and temperament: a prospective study of infants conceived through in-vitro fertilization. *Hum Reprod* 13:1727–1732
- Gloger-Tippelt G (1988) Die Entwicklung des Konzept “eigenes Kind” im Verlauf des Übergangs zur Elternschaft In: Brähler E, Meyer A (eds) *Partnerschaft, Sexualität und Fruchtbarkeit*. Beiträge aus Forschung und Praxis. Springer, Berlin/Heidelberg, pp 57–69
- Gloger-Tippelt G (Hrsg) (2001) *Bindung im Erwachsenenalter*. Ein Handbuch für Forschung und Praxis. Bern, Huber
- Glover L, Gannon K, Sherr L., Abel PD (1996) Distress in sub-fertile men: A longitudinal study. *J Reprod Infant Psychol* 14:23–36
- Goebel P, Lübke F (1987) Katamnestic Untersuchung an 96 Paaren mit heterologer Insemination. *Geburtsh Fr* 47:636–640
- Goldfarb J, Kinzer DJ, Boyle M, Kurit D (1996) Attitudes of in vitro fertilization and intrauterine insemination couples toward multiple gestation pregnancy and multifetal pregnancy reduction. *Fertil Steril* 65(4):815–820
- Goldschmidt O, de Boor C (1976). Psychoanalytic examination of functionally sterile couples. *Psyche (Stuttg)* 10:899–923
- Golombok S, Brewaeyns A, Giavazzi MT, Guerra D, MacCallum F, Rust J (2002) The European study of assisted reproduction families: the transition to adolescence. *Hum Reprod* 17: 830–840
- Golombok S, Lycett E, MacCallum F, Jadv V, Murray C, Rust J, Abdalla H, Jenkins J, Margara R (2004) Parenting infants conceived by gamete donation. *J Fam Psychol* 18:443–452
- Golombok S, Jadv V, Lycett E, Murray C, Maccallum F (2005) Families created by gamete donation: follow-up at age 2. *Hum Reprod* 20:286–293
- Golombok S, Olivennes F, Ramogida C, Rust J, Freeman T (2007) Follow-Up team parenting and the psychological development of a representative sample of triplets conceived by assisted reproduction. *Hum Reprod* 22:2896–2902
- Grobman WA, Milad MP, Stout J, Klock SC (2001) Patient perceptions of multiple gestations: An assessment of knowledge and risk aversion. *Am J Obstet Gynecol* 185:920–924
- Guttormsen G (1992) Unfreiwillige Kinderlosigkeit: ein Familienproblem. *Praxis Kinderpsychol Kinderpsychiat* 41: 247–252
- Hahlweg K, Schindler R, Revenstorf D (1982) *Partnerschaftsprobleme*. Springer, Heidelberg
- Hansen M, Bower C, Milne E, de Klerk N, Kurinczuk JJ (2005) Assisted reproductive technologies and the risk of birth defects – a systematic review. *Hum Reprod* 20:328–338
- Hellhammer DH, Hubert W, Freischem CW, Nieschlag E (1985) Male infertility: Relationships among gonadotropins, sex

- steroids, seminal parameters and personality attitudes. *Psychos Med* 47:58–66
- Hjelmstedt A, Andersson L, Skoog-Svenberg A, Bergh T, Boivin J, Collins A (1999) Gender differences in psychological reactions to infertility among couples seeking IVF- and ICSI-treatment. *Acta Obstet Gynecol Scand* 78:42–48
- Hölzle C, Lütkenhaus R, Wirtz M (2000) Psychologisch-prognostische Kriterien für den Verlauf medizinischer Sterilitätsbehandlungen. In: Brähler E, Felder H, Strauß B (Hrsg) *Fruchtbarkeitsstörungen aus psychosozialer Perspektive*. Jahrbuch der Medizinischen Psychologie 17. Göttingen, Hogrefe, 177–205
- Hoppe JD (2006) (Muster-)Richtlinie zur Durchführung der assistierten Reproduktion der Bundesärztekammer – Novelle 2006. *Deutsches Ärzteblatt* 20:1392–1403
- Hubert W, Hellhammer DH, Freischem CW (1985) Psychobiological profiles in infertile men. *J Psychosom* 2: 161–165
- Institut für Demoskopie Allensbach, Allensbacher Bericht 11/2007 Unfreiwillige Kinderlosigkeit (2007). <http://www.ifd-allensbach.de/>
- Jacobson E. (1946) A case of sterility. *Psychoanal Quart* 12:0–350
- Katzorke T (2008) Artificial insemination by donor in Germany – a review. *J Reproduktionsmed Endokrinol* 5:4–20
- Kedem P, Mikulincer M, Nathanson YE (1990) Psychological aspects of male infertility. *Br J Med Ps* 63:3–80
- Kentenich H, Tandler-Schneider A (2008) Kommentar zu Thorn, P, Wischmann, T.: Eine kritische Würdigung der Novellierung der (Muster-) Richtlinie der Bundesärztekammer 2006 aus der Perspektive der psychosozialen Beratung. *J Reproduktionsmed Endokrinol* 5:153–154
- Kentenich H, Utz-Billing, I. (2006) Verbot der Eizellspende. *Gynäkologische Endokrinologie* 4:229–234
- Kowalcek I (2008) Die Mehrlingsproblematik aus psychologischer Sicht. *J Reprod Endocrinol* 5:280–284
- Lalos A, Jacobsson L, Lalos O, von Schoultz B (1985) The wish to have a child. A pilot-study of infertile couples. *Acta Psychiatr Scand* 72:476–481
- Langer, M. (1953) *Maternidad y sexo*. Buenos Aires, Ediciones Paides
- Leiblum S, Kemman E, Lane M (1987) The psychological concomitants of in vitro fertilization. *J Psychosom Obstet Gynaecol* 6:165–178
- Leiblum SR, Aviv A, Hamer R (1998) Life after infertility treatment: A long-term investigation of marital and sexual function. *Hum Reprod* 13:3569–3574
- Lintsen AME, Verhaak CM, Eijkemans MJC, Braat DDM (2006) The prognostic value of psychological factors on the outcome of IVF. *Hum Reprod* 21:i71
- Ludwig M, Katalinic A (2005) Die deutsche ICSI-Follow-up-Studie – Zusammenfassung der Ergebnisse publizierter Arbeiten und Einordnung in die aktuelle Studienlage. *Journal für Reproduktionsmedizin und Endokrinologie*, *J Reprod Med Endocrinol* 2:151–162
- Lycett E, Daniels K, Curson R, Golombok S (2004) Offspring created as a result of donor insemination: A study of family relationships, child adjustment, and disclosure. *Fertil Steril* 82:172–179
- Mariano C, Hickey R (1998) Multiple pregnancy, multiple needs. *Can Nurse* 94:26–30
- Matzen K, Pook M, Schnapper U, Krause W, Florin I (1999) Tages-Aktivitäts-Rhythmik und Schlafqualität bei idiopathisch infertilen Männern. In: Brähler E, Felder H, Strauß B (eds) *Fruchtbarkeitsstörungen*. Jahrbuch der Medizinischen Psychologie 17. Hogrefe, Göttingen, pp 165–174
- Murray C, MacCallum F, Golombok S (2006). Egg donation parents and their children: Follow-up at age 12 years. *Fertil Steril* 85(3):610–618
- Nachtigall R, Becker G, Wozny M (1992) The effects of gender-specific diagnosis on men's and women's response to infertility. *Fertil Steril* 57:113–121
- Newton CR, McDermid A, Tekpetey F, Tummon IS (2003) Embryo donation: Attitudes toward donation procedures and factors predicting willingness to donate. *Hum Reprod* 18: 878–884
- Onnen-Isemann C (2000) Ungewollte Kinderlosigkeit und ihre Auswirkungen der Reproduktionsmedizin: Der Fall Deutschland. *Forum Qualitative Sozialforschung* vol 1, No 1 on-line Journal. <http://qualitative-research.net/fqs>
- Palermo GD, Colombero LT, Schattman GL, Davis OK, Rosenwak Z (1996) Evolution of pregnancies and initial follow-up of newborns delivered after intracytoplasmic sperm injection. *J Am Med A* 276:1893–1897
- Poland ML, Giblin PT, Ager JW, Moghissi KS (1986) Effect of stress on semen quality in semen donors. *Int J Fertil* 31: 229–231
- Pook M, Tuschen-Caffier B, Krause W (2004) Is infertility a risk factor for impaired male fertility? *Hum Reprod* 19:954–959
- Robin M, Josse D, Tourrette C. (1991) Forms of family reorganization following the birth of twins. *Acta Genet Med Gemellol (Roma)* 40:53–61
- Roest J, van Heusden AM, Verhoeff A, Mous HV, Zeilmaker GH (1997) A triplet pregnancy after in vitro fertilization is a procedure-related complication that should be prevented by replacement of two embryos only. *Fertil Steril* 67:290–295
- Sanders KA, Bruce NW (1999) Psychosocial stress and treatment outcome following assisted reproductive technology. *Hum Reprod* 14:1656–1662
- Schilling G (1995) Zur Problematik familiärer Geheimnisse am Beispiel der heterologen Insemination. *Psychother Psychosom Med Psychol* 45:16–23
- Schurman H (1948) Über die Zunahme männlicher Fertilitätsstörungen und über die Bedeutung psychischer Einflüsse für die zentralnervöse Regulation der Spermio-genese. *Med Klin* 13:366–368
- Schumacher, J., Stöbel-Richer Y, Brähler E (2002) Erinnerungtes Erziehungsverhalten der Eltern und eigener Kinderwunsch – Gibt es hier Zusammenhänge? *Psychother Psychosom Med* 52:314–322
- Schuth W, Keck C (2001) The ideal reproduction medicinal treatment – as seen by the involved persons. *Geburtsh Frauenhilk* 61:476–482
- Seibel MM, Taymor ML (1982) Emotional aspects of infertility. *Fertil Steril* 37:137–145
- Snarey J, Son L, Kuehne V, Hauser S, Vaillant G (1987) The role of parentin in men's psychological development: A longitudinal study of early adulthood infertility and midlife generativity. *Develop Psychol* 23:593–603
- Söderström-Anttila V, Sajaniemi N, Tiitinen A, Hovatta O (1998) Health and development of children born after oocyte donation compared with that of those born after in-vitro fertilization, and parents' attitudes regarding secrecy. *Hum Reprod* 13:2009–2015

- Stauber M (1979) Die Psychosomatik der sterilen Ehe. Grosse, Berlin
- Stauber M (1989) Psychosomatische Aspekte der Sterilität. In: Bettendorf G, Breckwolfdt M (eds) Reproduktionsmedizin. Fischer, Stuttgart pp 390–398
- Stewart DE, Boydell KM, McCarthy K, Swerdlyk S, Redmond C, Cohrs W (1992) A prospective study of the effectiveness of brief professionally-led support groups for infertility patients. *Int J Psychiatry Med* 22:173–182
- Stieve H (1952) Der Einfluß des Nervensystems auf Bau und Tätigkeit der Geschlechtsorgane des Menschen. Thieme, Stuttgart
- Stöbel-Richter Y, Borkenhagen A, Wisch S, Brähler E (2006) Wissen und Einstellungen der deutschen Bevölkerung zu Aspekten der modernen Reproduktionsmedizin. Ergebnisse einer aktuellen Bevölkerungsbefragung. In: Stöbel-Richter Y, Ludwig A, Franke P, Neises M, Lehmann A (Hrsg) Anspruch und Wirklichkeit in der psychosomatischen Gynäkologie und Geburtshilfe. Gießen, Psychosozial-Verlag, pp 163–171
- Strauß B (2000) Herausgeber. Ungewollte Kinderlosigkeit. Hogrefe, Göttingen
- Strauß B, Beyer K (2004) Gesundheitsberichterstattung des Bundes. Heft 20 Ungewollte Kinderlosigkeit. Robert-Koch-Institut, Statistisches Bundesamt, Berlin
- Strauß B, Brähler E, Kantenich H (Hrsg) (2004) Fertilitätsstörungen – Psychosomatische Diagnostik und Therapie (Leitlinien und Quellentext). Schattauer, Stuttgart
- Strauss B, Hepp U, Städing G, Mettler L (2000) Fokale Beratung von Frauen und Männern mit Kinderwunsch: Ein dreistufiges Modell. In: Straus (Hrsg) Ungewollte Kinderlosigkeit Göttingen, Hogrefe, pp 119–148
- Strauß B, Städing G, Hepp U, Mettler L (1999) Fokale Beratungskonzepte in der Fertilitätsmedizin. In: Brähler E, Felder H (eds) Jahrbuch der Medizinischen Psychologie 17. Hogrefe, Göttingen, pp 272–290
- Sturgis SH, Taymor ML, Morris T (1957) Routine psychiatric interviews in an sterility investigation. *Fertil Steril* 8: 521–526
- Thorn P, Daniels K (2000) Psychosoziale Fragestellungen, die bei der Familienbildung mit donogener Insemination entstehen. *Reproduktionsmedizin* 16:202–207
- Thorn P, Wischmann T (2008) Eine kritische Würdigung der Novellierung des (Muster-) Richtlinien der Bundesärztekammer 2006 aus der Perspektive der psychosozialen Beratung. *J Reproduktionsmed Endokrinol* 5:39–44
- Turner AJ, Coyle A (2000) What does it mean to be a donor offspring? The identity experiences of adults conceived by donor insemination and the implications for counselling and therapy. *Hum Reprod* 15:2041–2051
- Ulrich, D (1988) Zur Psychosomatik des unerfüllten Kinderwunsches: Literaturübersicht. In: Brähler E, Meyer A (eds) Partnerschaft, Sexualität und Fruchtbarkeit. Springer, Berlin, 101–113
- Vanfraussen K, Ponjaert-Kristoffersen I, Brewaeys A. (2001) An attempt to reconstruct children's donor concept: A comparison between children's and lesbian parents' attitudes towards donor anonymity. *Hum Reprod* 16:2019–2025
- von Schelling C (1994) Wir wollen ein Kind adoptieren. Mosaik, Verlag München
- Weghofer A, Margreiter M, Gerhold B, Edjalipour C, Renezeder K, Sowelem H, Feichtinger W (2002) Attitudes of women undergoing IVF regarding supernumerary embryos, oocyte donation, and embryo adoption. *Geburtsh Frauenheilk* 62: 574–577
- Wirtberg I, Möller A, Hogström L, Tronstad SE, Lalos A (2007). Life 20 years after unsuccessful infertility treatment. *Hum Reprod* 22:598–604
- Wischmann T (2006a) The Psychogenesis of infertility: An Overview. *Geburtsh Frauenheilk* 66:34–43
- Wischmann T (2006b) Unerfüllter Kinderwunsch – Stereotype und Fakten. *J Reproduktionsmed Endokrinol* 3:220–225
- Wischmann T, Stammer H (2001) Der Traum vom eigenen Kind. Psychologische Hilfen bei unerfülltem Kinderwunsch. Stuttgart, Kohlhammer
- Zitzmann M, Rolf C, Nordhoff V, Schröder G, Rickert-Föhring M, Gassner P, Behre HM, Greb RR, Kiesel L, Nieschlag E. (2003) Male smokers have a decreased success rate for in vitro fertilization and intracytoplasmic sperm injection. *Fertil Steril* 9(Suppl 3):1550–1554

Contents

26.1	Sexual Medicine in Clinical Practice	539
26.2	Interdisciplinary References in Sexual Medicine	540
26.3	Basic Understanding of Human Sexuality	540
26.4	The Spectrum of Sexual Disorders	541
26.4.1	Sexual Dysfunction.....	543
26.4.2	Disorders of Sexual Development	545
26.4.3	Disorders of Gender Identity	546
26.4.4	Disorders of Sexual Preference (Paraphilias).....	547
26.5	Impact of disorders of Sexual Preference, Sexual Behavior and Sexual Reproduction	547
26.5.1	Disorders of Sexual Behavior (Dissexuality).....	548
26.5.2	Disorders of Sexual Reproduction.....	549
26.6	Principles of Diagnosis in Sexual Medicine	549
26.6.1	Exploration of a Sexual Disorder/Dysfunction	550
26.6.2	Exploration of the Three Dimensions of Sexuality.....	551
26.7	Principles of Therapy in Sexual Medicine	552
26.7.1	Sexological Consultation	553
26.7.2	Sexual Therapy	553
26.7.3	Integration of Somatic Therapy Options	554
	References	554

K. M. Beier
 Institute of Sexology and Sexual Medicine, Center for Human and Health Sciences, Charité-Universitätsmedizin Berlin, Freie und Humboldt-Universität zu Berlin, Luisenstrasse 57, D-10117 Berlin
 e-mail: klaus.beier@charite.de

26.1 Sexual Medicine in Clinical Practice

Sexual medicine is concerned with recognition/identification, treatment, prevention and rehabilitation of disorders and diseases in sexuality. These may involve sexual functions, sexual and/or partnership experience and behavior (also possibly resulting from other illnesses and/or their treatment), gender identity, or be associated with sexual trauma. Sexual medicine places priority on the dimension of attachment as well as drawing on scientific knowledge and proceedings of medical, psychological and sociological disciplines (Vogt et al. 1995). Scientific findings on the psychology of behavior and development are especially useful for sexological methods, showing that mammals, especially primates and certainly humans are “relational” beings programmed to depend on attachment: their chances of survival depend on the satisfaction of existential elementary needs such as acceptance and belonging. These are most likely to be fulfilled and particularly intensive during body contact in (intimate) relationships providing feelings of comfort and security. All sexological interventions are based on this elementary understanding.

In some areas there are considerable parallels between sexual medicine and andrology. According to the current postgraduate curriculum of the German Federal Medical Board, the definition of andrology covers the “prevention, diagnosis, conservative treatment and rehabilitation” of “attachment disorders” and “erectile dysfunction including disorders in libido, ejaculation and cohabitation”.

Thus the andrological examination of patients and couples offers an appropriate opportunity for simultaneously recording existing sexologically relevant disorders in addition to the primarily presented symptom (e.g., childlessness).

Sound sexological competence on the part of andrological specialists is highly desirable. At the very least, they should be involved with a network providing an option for postgraduate education, and offering the opportunity of referring potential couples to specialized sexologists.

A positive development is that since 2007 sexual medicine has been recognized as a subspecialty according to the postgraduate curriculum of the Berlin Medical Board. Colleagues from various fields of specialization such as gynecology, dermatology, internal medicine, general medicine, psychosomatic medicine, psychotherapy or urology can apply for recognition after qualification in theoretical knowledge and practical skills. This postgraduate education qualifies participants for diagnosis and therapy of all sexual and gender identity disorders (Sect. 26.3)

By definition sexual medicine derives its substance from anthropological, biomedical, psychological and sociocultural aspects of gender, and is by nature interdisciplinary and constantly integrates know-how from other specialized fields such as general medicine, gynecology, urology, andrology, endocrinology, psychiatry, psychosomatic medicine, psychotherapy as well as from adjoining human sciences, especially biology, psychology, sociology etc.

26.2 Interdisciplinary References in Sexual Medicine

Consequently, the variety of patients is large: For instance, the diabetes patient complaining of sexual disorders at some stage during his chronic disease (erectile dysfunction in men, arousal and orgasm problems in women); the hypertonic patient whose medication affects his sexual reactions negatively; the patient suffering depression, lacking sexual desire (as well as perhaps having to cope with arousal and orgasm difficulties). All these patients fit the pattern, as does the young man with sexual performance anxiety; the couple, whose unresolved conflicts or struggles for power within their partnership lead to sexual symptoms; the woman, who suffers pain during coitus caused by lack of lubrication after menopause (Fig. 26.1).

When the increasing numbers of disorders in sexual reproduction (including the often massive effects of involuntary childlessness on sexual and partnership

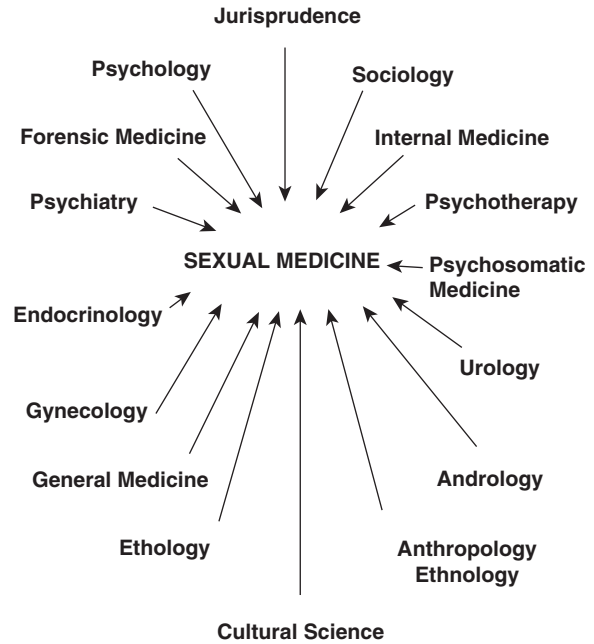

Fig. 26.1 Interdisciplinary references in sexual medicine

satisfaction), are considered, the spectrum of sexual disorders (see Sect. 26.3) and the challenges to medical options become obvious.

26.3 Basic Understanding of Human Sexuality

Sexuality can be defined as a biologically, psychologically and socially determined experience quality in human beings, which is formed by the unique development of a person's own life history. From the functional point of view, one can speak of the multifunctionality of sexuality containing single aspects interacting with one another, and which may be differentiated by the following terms:

- The **dimension of desire** encompasses sexuality in all conceivable ways of experiencing and increasing desire by sexual stimulation
- The **reproductive dimension** stands for the significance of sexuality for reproduction purposes
- The **dimension of attachment** emphasizes the importance of sexuality for the fulfillment of biosociological fundamental needs for acceptance,

closeness, warmth and security by sexual communication in partnerships (Beier and Loewit 2004; Beier et al. 2005).

Of the three dimensions, the reproductive dimension of sexuality is the phylogenetically oldest. For women this dimension is limited to the time span of reproductive capability extending from puberty to menopause; it is also dependent on biographical decisions, making it optional. The availability of reliable contraceptive methods on one hand, and the progress of reproductive medicine on the other, has made it possible to separate the dimension of reproduction from the other two dimensions of desire and attachment.

In evolutionary development the dimension of attachment occurs later, but for today's human beings it is without doubt an integral and essential element of sexuality. Its huge significance derives from the fact that humans are "relational" beings: from the very beginning of life, their fundamental needs for acceptance, security, trust, warmth and closeness can only be satisfied in relationships (Bowlby 1969–1980, Brisch 1999). This is fulfilled during infancy by body contact and the emotional experience of being taken care of, for instance by the sheltering manner in which an infant is held during breastfeeding. By this parental loving care the modus of satisfying psychosocial fundamental needs by skin contact is learned by the infant and reinforced on a **neuronal level**, the way all processes of learning elementary skills generally are (Rüegg 2003).

Feelings transmitted by interaction and body language determine human development from birth onward and remain a core characteristic of partnership organization: At first, they are not dependent on genital involvement, but indeed allow deep satisfaction obtained by skin and eye contact as well as by all other senses. They are therefore the first dimension of "sexual" experience, broadened later in life by the option of genital-sexual communication.

Today imaging methods are able to show (Bartels und Zeki 2004) that the same brain regions are deactivated when mothers are shown pictures of their children as when they see pictures of their spouses (compared to pictures of known persons as control persons). Possibly, the functions for anxiety and rejection, functionally-anatomically located in the **amygdala**, are deactivated at the same time. This means that any apprehension concerning the partner is "turned off" (as in the proverb "love is blind") in order to enable close interaction. This

would also explain the assumption of earlier authors who did not have imaging means as evidence, like the observations of M. Balint (1965) about the "primeval forms of love" as being the core and basis of adult intimacy, or why A. Montagu (1987) called sexual interaction between adults "in some ways a recapitulation of the tender love between mother and child".

The **dimension of desire** provides sexuality with the unique sensual experience of sexual arousal and orgasm, which distinguishes it from other human experience. It establishes the motivational quality of sexuality and simultaneously provides the impulse and reward of sexual behavior. The dimension of desire predominates in subjective experience in autoeroticism and in experienced attachment, passion and ecstasy. It is, however, difficult to view it in isolation because it is closely connected to other functions.

At the same time data from neuroscientific research justify the assumption that, along with specialized brain areas (such as the limbic system), basal cerebral areas close to the midline area play a decisive role in causing directly physiologically observable sexual reactions. Here the area preoptica of the hypothalamus seems to be of central importance and in animal experiments increased activity in this core region, anatomically connected with other hypothalamic regions, has been observed during sexual activity. Steroid hormones modulate the activity of the area preoptica; in both male and female animals conductance experiments showed selective activation in sexually promising or coitus-relevant situations (Pfaff 1999). In the human this core is "wired" so that androgen or estrogen metabolites can be recognized nasally as signals. Activation is dependent on sexual orientation and not on gender: androgen metabolites activate core regions of women who are oriented to men, and of male-oriented men, while in men who are female-oriented this region is activated by estrogen metabolites (Savic et al. 2005). The dependence of central sexual activation patterns on sexual orientation (and not on gender) was shown by Ponseti et al. (2006) for visual stimuli.

26.4 The Spectrum of Sexual Disorders

The suggested categories of the clinical classification systems ICD-10 (WHO 1993) and DSM-IV-TR (APA 2000) are purely descriptive and random concepts which

fail to do justice to the complexity of human sexuality. Even on closer examination, the differentiation of the three dimensions of sexuality required from a sexological point of view exemplify the inadequacy of such categorization. Thus sexual dysfunction cannot only influence the dimension of desire, but very likely the dimension of attachment as well; not only disturbed sexual function but moreover the disturbance of partnership comfort ends up being the actual reason for suffering.

According to present knowledge, chronic lack of security transmitted by body communication (frustration of psycho-social fundamental needs) increases the probability of developing psychological and physical disorders. Furthermore it hinders overcoming prevailing diseases (Egle et al. 1997).

The symptoms presented by the patient seen in clinical practice are usually described as “psychosomatic ailments”, “depressive state of mood”, “anxiety and/or nervous restlessness” i.e., “nervous anxiety, tension and

restlessness” or additionally as “emotionally caused state of restlessness”. So it can be assumed that in many areas of medicine male and female patients with varying disorders or dysfunctions consult a practitioner, because – again for different reasons – of a lack of availability of a functioning and therefore emotionally stabilizing social/intimate attachment. Also included are chronically ill or older persons, suffering from psycho-social destabilization due to reduced opportunities for contacts.

This explains why very different symptoms can dominate the clinical impression, as a result various medical disciplines may come into contact with the patient concerned:

The orthopedist for muscle tension, the general practitioner for symptoms of the autonomic nervous system, the psychiatrist for intrapsychological tension or states of depression or the andrologist concerning involuntary childlessness. Also, other sexual dysfunction may perhaps be only one of many possible symptoms (apart from, of course, sexual dysfunction caused by illness, e.g. condition after paraplegia). The special quality of sexological therapy lies in the fact that it deals with the

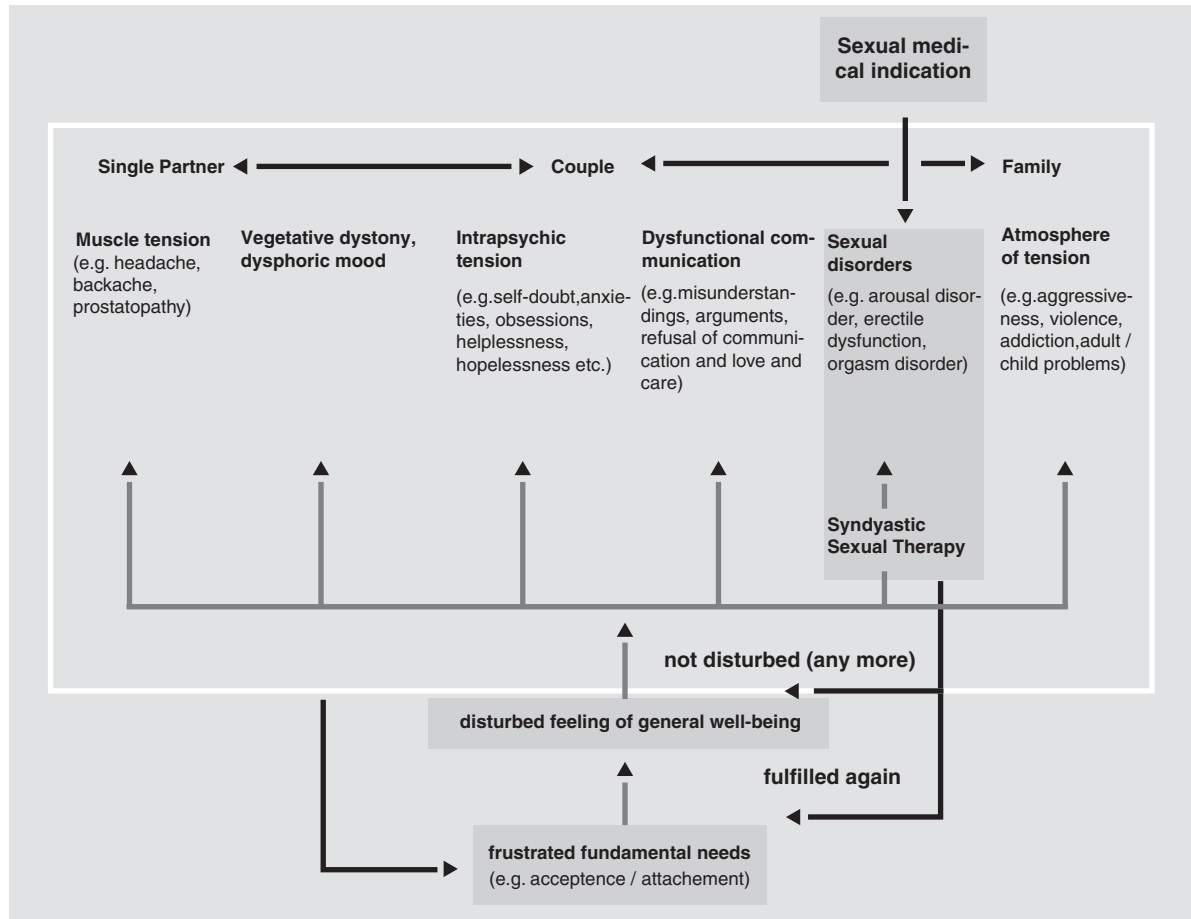

Fig. 26.2 Connection between psychosocial fundamental needs and various symptoms

actual roots (the frustrated basic social needs) of possible causes at a level not reached elsewhere because it aims to restore the feeling of complete attachment by accepting physical intimacy with the partner, which also has curative effects on symptoms and positive consequences in other areas of life (Fig. 26.2).

So, even when spinal pains are successfully cured by an orthopedist, there is nevertheless no change on the level of fundamental needs. Potential frustration of these needs is not resolved and may lead to a recurrence or cause other symptoms.

These limited and only partially useful systematic categorizations notwithstanding, clinically significant sexual disorders are compactly characterized as follows, along with their coding possibilities – according to the international classification systems (ICD-10 and DSM-IV-TR) (Ahlers et al. 2005).

1. Sexual Dysfunctions (ICD-10: F 52.0 ff.; DSM-IV-TR: 302.71 ff.)
2. Disorders of Sexual Development (ICD-10:F 66.0 ff.; coded in a generalized category designated “not otherwise specified” in DSM-IV-TR: 302.9)
 - (a) Disorder of Sexual Maturity
 - (b) Disorder of Sexual Orientation
 - (c) Sexual Identity Disorder
 - (d) Sexual Partnership Disorder
3. Disorders of Gender Identity (ICD-10: F 64; DSM-IV-TR: 302,85)
4. Disorders of Sexual Preference/Paraphilias (ICD-10: F 65.O ff.; DSM IV-TR: 302.81 ff.)
5. Disorders of Sexual Behavior/Dissexuality (a generalized category designated “not otherwise specified” in ICD-10: F 63.8 and DSM-IV-TR: 312.30)
6. Disorders of Sexual Reproduction (coded in a generalized category called “not otherwise specified” in ICD-10: F 69 and DSM-IV-TR: 309.9)

26.4.1 Sexual Dysfunction

The sexual response cycle can be subdivided into the following phases: desire, excitement, orgasm and resolution/relaxation. Disorders of sexual response may occur at one or more of these phases (Masters and Johnson 1966). Like psychological and behavioral disorders, all sexual dysfunction reveals biological and psychological as well as sociological aspects, so that only a holistic viewpoint

on these aspects guarantees an appropriate description and consequently effective treatment. Because sexual dysfunction not only affects the patient, but also has an impact on the well-being of the partner involved, treatment should principally be carried out with both partners. Moreover, all dysfunctions can occur independently from other illnesses and disorders, or they may result from other illnesses and/or their treatment.

With regard to sexual dysfunctions in men, the following is based mainly on the latest findings by Rösing et al. (2009).

In a representative random sample of 18–59-year-old US-Americans. Laumann et al (1999) found that 5% of the test persons had desire dysfunction, 5% erectile dysfunction and 21% orgasmic dysfunction in the form of ejaculatio praecox. In international comparison results were partly concurrent, but partly showed significant intercultural variations, which verifies the bio-psycho-social roots of such disorders (Laumann et al. 2005). Since then, several studies have also verified the negative impact of sexual dysfunctions on partnership and life quality (Chevret et al. 2004; Rosen et al. 2004; Fisher et al. 2005; Abraham et al. 2008).

26.4.1.1 Disorders of Sexual Desire

These disorders are becoming an ever growing problem in men seeking sexological treatment, although the patients themselves often state erectile dysfunction as their reason for seeking help. The cause is often found to be hidden, frequently revealing sub-depressive conditions of exhaustion (with and without substance abuse), disharmonies in partnership and – always recurrent – disorders of sexual preference. Organic causes (testosterone deficit, hyperprolactinemia, side effects of medication) are definitely significant for differential diagnosis, but are sometimes overestimated in somatomedical literature.

26.4.1.2 Erectile Dysfunction

The prevalence of **erectile dysfunction** is well investigated. In 17% of the 40–70-year-old men questioned, the Massachusetts Male Aging Study (MMAS) established a minimal, in 25% a moderate, and in 10%, a complete failure of erection (Feldman et al. 1994). Braun et al. (2000) found erectile dysfunction in 19.2% of their 4,489 30-year-old respondents, in whom the

authors were able to show that absolutely not all test persons with reported erectile dysfunction were not satisfied with their sexual life.

Here, as well as in frequency of dysfunctions, there was a significant age effect. The same is true for the Berlin Male Study (Schäfer et al. 2003; Englert et al. 2007), in which the authors support the idea of differentiating between “erectile dysfunction” and “erectile disorder”. In their opinion, only an “erectile disorder” is to be regarded as a pathological disorder, because the diagnosis is made according to DSM-IV-TR only if the disturbance causes “marked distress or interpersonal difficulty”. An important finding in these surveys was the high coincidence between general medical symptoms (especially diabetes, heart disease and high blood pressure). It is often overlooked that the occurrence of an erectile disorder beyond the age of 40 can be a first indication for chronic ischemic coronary disease (Görge et al. 2003; Chew et al. 2008).

26.4.1.3 Premature Ejaculation

Premature ejaculation, defined as a constant occurrence before or immediately after penetration over which the patient has no or very little control and is unable to experience the satisfaction of orgasm, is the most frequent sexual dysfunction in men. Approximately 20–25% of men questioned in modern industrial countries have premature ejaculation accompanied by psychological stress (Mathers et al. 2007; Porst et al.

2007). In giving valid prevailing figures, however, two problems arise: first, the normal ejaculation/orgasm time period is assessed highly subjectively and is subject to great interindividual and also cultural variability (Althof 2006; Montorsi 2005); secondly, exactly at this point it becomes obvious that “impairment of function” and clinically relevant disorders are not identical or concurrent (see above).

Practically every clinical medical department takes care of patients possibly suffering from sexual dysfunction through an illness and/or its treatment. Primarily cardiovascular diseases (heart failure, coronary heart disease, myocardial infarction and hypertension) are the main ones which are sexologically relevant. In addition there are metabolic diseases such as diabetes mellitus, serious general illnesses, especially cancer, locomotor restrictions (e.g., arthritis), neurological illnesses such as multiple sclerosis or Parkinson disease, but also neurologically related handicaps, psychiatric illnesses like anxiety disorder or depression, but also mental retardation and finally gynecological and urogenital illnesses.

An independent specific coding of illness-related or treatment-related sexual dysfunctions is as complicated in DSM-IV-TR as it is in ICD-10. In ICD-10 the primary illness is coded separately, while in DSM-IV-TR the dysfunction is identified, but the primary illness has to be filled in by free text. The multitude of possible reasons for the development of erectile dysfunction caused by illness or treatment are shown in Fig. 26.3 (in Rösing et al. 2009).

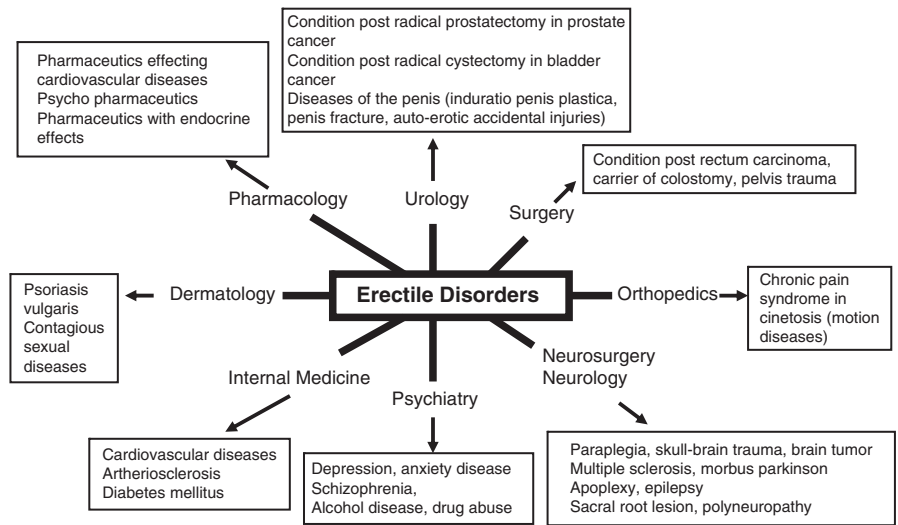

Fig. 26.3. Erectile disorders caused by illnesses and/or their treatment

26.4.2 Disorders of Sexual Development

This area deals with disorders surfacing in the context of somatosexual, psychosexual and sociosexual development over a whole lifespan and which interfere with the persons' sexual interaction abilities, even as far as making sexual contact altogether impossible for them. Often, these disorders lead to a secondary appearance of other psychic behavioral disorders, which then become the pretext for visiting the practitioner, replacing the original problem itself. It is believed that most sexual development disorders themselves remain unconsidered and are only treated on the (secondary) symptom level – often because the individual is unable to state exactly that the difficulties originally (or also) are rooted in personal sexual development.

This is even more so, when the problem is embedded within complete development delay (retardation) (physical and psychological development disorder) or when the patient is altogether retarded. Retardation as a handicap does not alter the need for sexual contact and longing for a sexual relationship.

26.4.2.1 Disorders of Sexual Maturity

The category “disorders of sexual maturity” deals with psychosexual and sociosexual effects of delayed or undeveloped physical sexual maturity (e.g., “pubertas tarda”). In many cases it causes disturbances of gender and sexual identity formation and finally leads to developmental delay on the psychosexual/sociosexual level; it results in retardation of sexual development and difficulties in taking up sexual contact with potential partners of the patients' own age.

Disorders of sexual maturity are especially serious when they manifest themselves as sexual assault on children, because in such a case an adult suffering from somatosexual, psychosexual or sociosexual retardation is unable to form adequate sexual relationships with persons his own age and, seeking substitute gratification, uses children to meet his needs (Beier et al. 2005).

26.4.2.2 Disorders of Sexual Orientation

Sexual orientation towards one or the other gender is an axis of the human sexual preference structure, regardless of which type (homosexual, bisexual or heterosexual)

and is not to be defined as pathological or any kind of disorder, but as a possible variation of human sexuality (see Sect. 26.4). Problematic or pathological disorders may develop when a conflict in processing strategies and inadequate integration of the preferred orientation is involved, causing the person to suffer.

The most frequent manifestation of sexual orientation disorder is to be found in self-alien homosexual orientation (so-called “ego-dystonic homosexuality”). Not least: in the light of a sociocultural background of a heterosexual population majority there are fears of actually being homosexual or of being unable to accept a realistic awareness of one's own homosexuality and certainly of not being integrated into one's own sexual identity (see below). Consequently denial or suppression attempts follow which are usually of short duration and often lead to outright rejection of one's own sexual orientation: the result is a desire to change this condition.

26.4.2.3 Sexual Identity Disorders

A “sexual identity disorder” is defined as an uncertain approach towards one's masculinity or femininity but without questioning affiliation to one of these genders (compare Sect. 26.3.3.)

If gender identity is expressed by the question: “Am I a man or a woman?”, then sexual identity is expressed by the question: “Am I a real male or female, i.e., sufficiently male or female?” So it is all about feelings of adequacy and whether or not affected persons esteem themselves as being a real man or a real woman, especially in the sense of sexual attractiveness.

While in gender identity sexual attractiveness does not play a leading role, in sexual identity the question arises whether one's own gender-typical qualities can be integrated into a sexual self-concept and whether gender-typical sexual behavior can be put into practice. Taking on substantial, continuous sexual relationships may be especially difficult for men suffering from strong self-doubt and fear of failure concerning their sexual performance and potency, triggering anxiety.

This is a case of “male identity disorder” with resulting consequences for self-evaluation and an inner attitude toward the male gender role, as well as toward trust in their own (sexual-) functional adequacy as a “man”. (This often is the basis for wishing to alter physical features, such as employing breast and buttock implants and penis extensions.) This development can be described as

“sociosexual self-insecurity”, which far exceeds general, i.e., surmountable “shyness in the face of the other sex” and can be one reason for affected persons remaining without desired partnerships over a long period of time.

26.4.2.4 Disorder of Sexual Partnership

A sexual partnership disorder is given when, over a long period of time, a person suffers from the incapability to enter into or maintain a sexual relationship.

The psychological stress arising from this condition is often a negative factor influencing life quality in general and health in particular. The reasons for these problems may well lie in the spectrum of other sexual disorders, as well as in psychological and behavioral disorders, which make taking up and/or maintaining sexual relationships difficult or impossible. This nearly always places a disorder of sexual partnership in a secondary position; the impossible or disturbed sexual relationship is usually a sociosexual expression of a different, mainly primary problem which generally emerges within the context of a non-integrated social dimension of sexuality.

If, for instance, the dimension of desire is separated from the attachment dimension, this can result in an exaggeration of the dimension of desire at the expense of the attachment dimension, which is more often found in men than in women. These men are then so focused on pleasure and its satisfaction in sexual experience, that they do not experience this within the context of being connected with a partner (social) relationship. Their partner often reacts by sexual withdrawal, because during sexual interaction they do not feel “wanted” or even feel “abused”.

This disassociation can also take place during pharmaceutical symptomatic treatment of erectile dysfunction (e.g., PDE-5-inhibitors) without any sexual therapy treatment and without including the partner in this treatment. It may cause an unintended increase of the sexual partnership disorder. One reason why many men use erection-enhancing medication for only a short period of time – aside from the high costs – is because their partners signal that obviously the male’s focus is on erection and thus on the experience of lust so that the woman’s own need for attachment, warmth and security is neglected and ignored; she feels disregarded and even degraded.

Even when the dimension of reproduction is unbalanced, i.e., overemphasized, it can lead to a sexual

disorder, for instance, when one partner aims at sexual contact only for reasons of reproduction, while perhaps the other partner does not share the strong desire for offspring and would refuse sexual intercourse. Often a disorder of sexual partnership again expresses itself in the absence of sexual reactions or even in sexual dysfunction.

26.4.3 Disorders of Gender Identity

Patients with this disorder show insecurities, irritation and misperception concerning their own gender categorization. An inner feeling of belonging to the opposite gender is dominant, contrary to their own biological birth gender, they are living in the “wrong” body, giving rise to a desire to change this situation.

Within this disorder group there are different levels and stages with varying causes and must to be dealt with in different ways. For this reason these problems are summarized under the generic term **gender identity disorders**. A passing (not persistent) sense of discomfort in one’s own gender, discontentment and insecurity regarding ones own social gender role, cosmetic or other subjectively founded personal needs for measures to alter body contours have nothing whatsoever to do with this group. Persons with a genuine gender identity disorder nearly always need specialized psychotherapeutic treatment, the therapy aim of which is not “combat or reversal” of the desire to achieve a change in gender, but solely to offer these persons a strategy for tackling their own gender identity insecurity over a long period of time and with an open outcome. At the same time, therapeutic guidance allows the patient to test the gender genuinely felt under all circumstances and in all social areas of their own everyday life (so-called everyday life test). With skilled help and advice the patient will be able to understand and process the developing impressions, experiences and feelings.

The strongest and irreversible form of gender identity disorder is described as **transsexuality**. In such (more seldom) cases the origin lies in a lifelong persisting conviction of an irreversible i.e., final disintegration of one’s own masculine or feminine body feeling. These cases often have to be treated with cross-gender hormone medication and in some cases with sex-reassignment surgery, along with the necessary psychotherapeutic sessions. In the far more frequent

non-transsexual forms of gender identity disorder, however, body-altering measures (hormones, surgery) are not considered as being indicated; the priority is on psychotherapy accompanying attainment of a suitable identity (Beier et al. 2005).

26.4.4 Disorders of Sexual Preference (Paraphilias)

Patients with **disorders of sexual preference (paraphilias)** experience deviating sexual impulses.

Therefore, persons who have such inclinations, but do not suffer by them, are not considered as disturbed, ill or in need of treatment, as long as they do not impair or endanger others or themselves by acting out their deviating sexual needs.

It is regarded as a special quality of sexual preference structure, which is manifest in every human on three basic axes: (a) with regard to the preferred gender of the sex partner (male and/or female), (b) regarding the preferred (bodily development), age of the sex partner (children, teenagers, young adults, adults, elderly persons) and (c) regarding the preferred kind and modus of sexual activity with and without sex partner(s) (type, object, method etc.).

Final manifestation of sexual structure takes place during youth and remains a constituent for life in its basic features and is invariable. This includes invariability of certain special sexual inclinations, which are also manifest from youth on and which partly or completely characterize the sexual structure of the person involved (Sect. 26.4).

Table 26.1 gives a summary of the most important disorders of sexual preference (paraphilias) in DSM-IV-TR (APA 2000)/ICD-10 (WHO 1993)

26.5 Impact of Disorders of Sexual Preference, Sexual Behavior and Sexual Reproduction

First epidemiological data shows (Langström and Zucker 2005; Ahlers et al. 2008) that the **prevalence** of paraphilia-related sexual arousal patterns is higher than assumed. This is valid for German-speaking countries based on data of the *Berlin Male Study (BMS)* in which

Table 26.1 Disorders of sexual preference/paraphilias by ICD10/DSM-IV-TR

F65.0 Fetishism	302.81 Fetishism
F65.1 Transvestic fetishism	302.3 Transvestic fetishism
F65.2 Exhibitionism	302.4 Exhibitionism
F65.3 Voyeurism	302.82 Voyeurism
F65.4 Pedophilia	302.2 Pedophilia
F65.5 Sadomasochism	302.83 Sexual masochism
302.84 Sexual sadism	
302.89 Frotteurism	
F65.6 Multiple disorders of sexual preference	
F65.8 Other disorders of sexual preference	
F65.9 Sexual disorder not otherwise specified	302.9 Not otherwise specified paraphilia

the prevalence of erectile dysfunction, its age-dependency and its relation to general health variables as well as quality of life measures were determined in 6,000 men aged 40–79. In the first phase of this study 1915 men took part (Schäfer et al. 2003). These men were then invited to take further part in a comprehensive sexological study by filling out an extensive questionnaire on sexual experiences and behavior, including their (female) partners (later also questioned). The outcome was a sample of 373 men, of whom 63 were single and 310 involved in a relationship (108 female partners were additionally involved and personally interviewed). The data give an impression of possible paraphilia-related tendencies within the general population for arousal patterns which were characterized according to frequency of occurrence in sexual phantasies, during masturbation (as contents of phantasies) and during actual practice (Ahlers et al. 2008).

57.6% of the questioned men recognized one of these arousal patterns as part of their phantasies, 46.9% used them for arousal enhancement during masturbation and 43.9% acted out these patterns on the behavioral level. Even though the obligatory, almost unavoidable selection effects do not allow these figures to be applied to the general population, there is nevertheless a relevant hint given about the presumptive distribution, which explains the extent and diversity of offers by the pornography industry (Table 26.2).

It is, however, to be assumed that most “deviating” sexual impulses are rooted in “normal” sexual response and only turn into pathological disorders by their isolation or generalization.

The DSM-IV-TR (APA 2000) takes this into account by admitting a diagnosis conditional upon the involved

Table 26.2 Prevalence of paraphilia-associated sexual arousal patterns on different experience levels in men between 40 and 79 years (no clinical population-based sample); results of the Berlin male study II

	Levels of Experience					
	Sexual Fantasies		Fantasies Accompanying Masturbation		Sexual Behavior	
	n	%	n	%	n	%
Non-human objects (e.g. material or shoes) (fetishism)	110	29.5	97	26.0	90	24.1
Wearing female clothes (transvestic fetishism)	18	4.8	21	5.6	10	2.7
Being humiliated (masochism)	58	15.5	50	13.4	45	12.1
Torturing other persons (sadism)	80	21.4	73	19.6	57	15.3
Secretly watching others in intimate situations (voyeurism)	128	34.3	90	24.1	66	17.7
Presenting one's genitals to strangers (exhibitionism)	13	3.5	12	3.2	8	2.1
Touching strangers in public (frotteurism, toucheurism)	49	13.1	26	7.0	24	6.4
Childrens' bodies (pedophilia)	35	9.4	22	5.9	17	3.8
Not otherwise specified	23	6.2	23	6.2	17	4.6
Sexual response to at least one arousal pattern/stimulus	215	57.6	175	46.9	163	43.7

n = 373; Responses for different arousal patterns were prompted on a 5-step rating-scale with gradings: few - moderate - strong - very strong. All answers from "few" to "strong" were rated as a response to a sexual arousal pattern.

person's claims to suffer on account of this paraphilic inclination or if it causes restrictions in significant social or vocational life functions, or, if paraphilias potentially endanger others (e.g., a pedophile inclination), if the involved person has acted out his impulses (regardless of any possible psychological pressure).

On the basis of these findings it is quite remarkable that a significant number (nearly one third) of the questioned men taking part in *BMS II* regarded paraphilia-related sexual arousal patterns as inadequate and voluntarily relinquished acting them out – even if these do not involve harming or endangering others (e.g., fetishistic). Nonetheless an also remarkable number of participants revealed a potential for sexual infringement (e.g., exhibitionism, voyeurism, frotteurism) or had already taken part in sexual (e.g., pedosexual) infringement in the past.

26.5.1 Disorders of Sexual Behavior (Dissexuality)

This category summarizes all forms of sexual behavior by which health and well-being of others is damaged or their sexual self-determination is endangered, being

subject to prosecution. **Dissexuality** is defined as failure to conform to social norms – regarding less whether that failure has been prosecuted or is subject to prosecution. It concerns all harmful sexual conduct (physical or psychological) and is defined as irresponsible sexual behavior which disregards the individual rights of others (Beier 1995).

Attempts at or actual performance of sexual acts on or with children or juveniles or other persons unable to consent to these also belong in the category of sexual behavior disorders (so-called "pedo-sexual" acts; in criminal law: "sexual abuse of children").

On the one hand disorders of sexual behavior can be attributed to acting out certain paraphilias, i.e., a paraphilic impulse pattern can be the root of disturbed sexual behavior, defined as **acts of inclination**. In other cases dissexual behavior is related to a different primary problem (e.g., a personality disorder, reduced intelligence or drug-abuse etc.): such irresponsible sexual acts are understood as **substitute acts**, compensating for the actually desired sexual interaction with a partner, which for several reasons is not realizable in a socially acceptable form. For sexological diagnosis this implies that disorders of sexual preference and sexual behavior have to be well differentiated and not confused, or even equated.

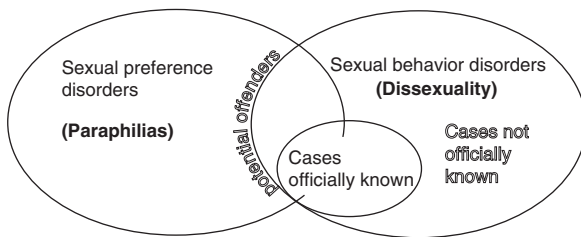

Fig. 26.4 Spectrum of disorders in sexual preference and behavior

Figure 26.4 is a schematic representation of sexual preference and disturbances showing that within the whole spectrum of paraphilias the preponderant part has *nothing* to do with harmful sexual contact, i.e., dissexuality. Conversely, dissexuality is *usually not* attributed to paraphilia. In simple terms, the majority of men with disorders of sexual preference (“paraphilia”) are not dissexual, and the large number of men with sexual behavior disorders (“dissexuality”) are not paraphilic.

Moreover, only a minor number of dissexual acts are performed openly, meaning that they mostly do not come to the attention of the judiciary or police – but do, however, play an important role in clinical sexual medicine.

26.5.2 Disorders of Sexual Reproduction

These disorders are characterized by psychological and psychophysiological impairment of reproduction in its various phases ([pre]conception, pregnancy, birth as well as child care and raising); they cause significant suffering and/or difficulties within human relationships. Adequate coding by the international classification systems (ICD-10 and DSM-IV-TR) is not possible. Clinically, however, they are distinguishable (Beier et al. 2006):

- **Preconceptional Disorders:** e.g., involuntary childlessness; phantasized pregnancy: In such cases, non-existing physical and psychophysiological conversion processes normally assigned to a manifest pregnancy (suspended menstruation, weight gain, child movement) are definitely experienced by the woman and presented convincingly to her social environment.
- **Prenatal Disorders:** e.g., denied pregnancy: In such cases physical and psychophysiological conversion

processes normally assigned to a manifest pregnancy (suspended menstruation, weight gain, child movement) are not perceived by the woman or are covered up (kept secret); abortions and miscarriages.

- **Postnatal Disorders:** e.g., postpartal depression, certain characteristics in educational behavior such as child abuse, but also treating the child as a *self-object* (Beier 1995, 2000).

In all these disorders the reproductive dimension of sexuality in its various phases – preconceptional, prenatal and postnatal – is physically and psychophysiological impaired and leads to clinical symptoms causing much suffering and/or endangering social integration.

Moreover, disorders of sexual reproduction are generally linked with disorders of sexual relationship (see above), which can open up useful aspects for therapeutic procedures.

26.6 Principles of Diagnosis in Sexual Medicine

In order to tackle the problem of a disturbed partnership and/or sexual life, it is essential to address the issue adequately and to explore sexual disorders as well as to evaluate physical findings and laboratory parameters competently.

The therapist offers a **model** for the opportunity of speaking openly about sexuality as a basic element of human life. This is one of the most important foundations of sexological skills and definitely shows therapeutic effects. It is long proven that patients actually wait for certain signals (Vincent 1964; Buddeberg 1996; Zettl and Hartlapp 1997; Fröhlich 1998). For instance, on prescribing a new medication, the therapist can provide a signal in terms of a question (e.g., “Should the illness or its treatment lead to problems or changes in your sexual life, we can talk about that and look for solutions”). It is stressed, however, that the therapist should not retreat into the role of an expert. He/she will always be confronted by subjective interpretations – the patient’s, as well as his/her own – making personal compassion inevitable.

26.6.1 Exploration of a Sexual Disorder/ Dysfunction

Successfully carrying out treatment with decisiveness is based on extensive information on the specific sexual experience and behavior of a patient/couple. In the case of an ongoing partnership, the information has to provide the investigator with insight into the level of sexual functions and the sexual preference structure of *both* partners; otherwise therapeutic steps remain ineffective or can even cause harm (e.g., if a preference disorder remains undetected as a reason for dysfunction).

When a couple is involved, it must be decided whether the sexual anamnesis should be taken with each partner alone or immediately with both partners together.

Single anamnesis has the advantage that the partner may be more uninhibited and speak more openly than in the presence of the other, particularly on subjects like masturbation phantasies or topics like paraphilic inclinations and past relationships. This can, however, make of the therapist a “keeper of secrets”, which could make future work with the couple difficult.

It is not crucial for the therapist to know every detail about each partner. In fact, it is more important to gather information of relevance for both partners as a couple because it can be referred to later during couple therapy.

In view of this, the sexological anamnesis as a direct **couple-interview** has great advantages, because all information issues are gathered together and processed from the beginning, which can demonstrate and increase the extent of openness and trust among the partners involved.

It is important to know which kind of disorder (e.g., direct or indirect sexual dysfunction/function disorder; disorder of sexual partnership) is being dealt with and under which circumstances or conditions it arises (e.g., primary or secondary; generalized or situative). What is the partner’s opinion on this disorder complained about? Who takes the initiative in sexual contact? Are there differences and where and how are they expressed? Which preferences or aversions are there and how are they dealt with?

This inevitably leads to analysis of possibly existing peculiarities of sexual preference structure, but can and should be investigated unreservedly (Table 26.3).

It must also be said that effects on sexuality and partnership caused by aging or illnesses and/or their

Table 26.3 Sexual preference structure: exploration tools

Three Axes

The human sexual preference structure is generally configured on three axes, i.e.

- **Gender** (of the desirable partner): the other or the same gender (or both);
- **Age** (of the desirable partner): children, adolescents, adults or the elderly; and
- **Way** (of the desirable partner or object or of an interaction): type, object, mode, procedure etc.,

all intermingling with one another and of which all (from nonconform to paraphilic) should be explored.

Three Levels

Sexual experience and behavior should be investigated into on three different levels, i.e.:

- the **sexual self-concept**
- the **sexual phantasies** and
- the concrete **sexual behavior**,

all intermingling with one another and of which all should be explored.

Three Forms

The concrete sexual behavior should again be explored within three forms:

- **masturbation**: self-stimulation and self-satisfaction;
- **extragenital sexual interaction**: e.g. stroking, cuddling, kissing and
- **genital stimulation**: manual, oral or other stimulation, e.g. petting incl. sexual intercourse (penis or penis surrogate penetrating vagina or anus,

and these should also all be explored.

treatment(s) only become evident through outright questioning. Involvement of the partner in the interview comes about automatically, because sexuality is a subject concerning both partners and in situations of intimacy, wishes and expectations of the partner have to be taken into account if the partnership is to be successful.

This is demonstrated in the latest interview-study by Kleinplatz et al. (2007), in which men and women (older than 65 years and involved in a long-term partnership) comment on “great sex”, mentioning experienced features such as *authenticity, intense emotional connection, communication and acceptance*.

Here functioning genital sexuality is not necessarily a condition for this experience; on the other hand, sexual functioning alone is not sufficient for achieving sexually fulfilling experiences.

Therefore, from a sexological point of view, the following questions are diagnostically of special interest:

What is communication like within the partnership in general and in sexual matters in particular? Can feelings, needs and wishes be communicated and does this happen? Are set limits respected? Are there self-strengthening mechanisms, “vicious circles” or self-fulfilling prophecies and how do these affect partnership communication? Can misunderstandings due to misinterpretations of partner-behavior play any sort of role?

26.6.2 Exploration of the Three Dimensions of Sexuality

Diagnostically and therapeutically it is essential to note the subjective classification of the patients/the couple on the three dimensions (reproduction, desire and attachment). This usually involves first-time analysis and discussions about their own sexuality and partnership which may already cause therapeutic effects. In the end, the aim is to gain an idea of what “sexuality” actually means to the patient/couple (“What does sleeping with your partner mean to you?”). In many patients, this may lead to the observation that some things are not so taken for granted as they might have thought to be (“we/I have never thought about that” is a frequent answer to the above question).

26.6.2.1 Dimension of Attachment

Is there a connection between sexuality and partnership and how is it seen? Which contents and values are indispensable within the relationship? How well are fundamental needs fulfilled on the basis of this relationship? To what extent is sexuality understood as a way of communicating these elementary needs on one hand and satisfying them by communication on the other, so that showing affection, cuddling up or having coitus can be experienced as “mimic and gesture” in this relationship? For example, is physical closeness and acceptance obtained during coitus also an expression and implementation of psychosocial closeness and acceptance existing in partnership? Is this communicative point of view realized, implicitly acted upon or does it fail to play any part, neither in theory nor in practice?

26.6.2.2 Dimension of Reproduction

What significance does reproductive capability have; what role do children (the child) play within the relationship? Do the partners have different views and attitudes on this? Are there any problems, which may, for instance, cause an exaggerated desire to have children?

26.6.2.3 Dimension of Desire

How much significance, which priority and what position within the three dimensions is given to genital sex? (How) has the degree of significance concerning desire changed during the course of the relationship? Are there disturbing discrepancies between the partners? Are the partners aware of the complexity of experiencing lust?

26.6.2.4 Individual and Partner-Related Interaction of these Three Dimensions

Are there imbalances detectable by the individual partner or by the couple that could be connected to a current sexual disorder? Here, the possibility of (a) the discrepancy between phantasized and sexuality experienced in reality and (b) the predominance of one of the dimensions at the expense of the other or (c) a completely different distribution must be taken into consideration.

26.6.2.5 History of Diseases and Somatic Findings

All significant illnesses treated medically at the present time or previously should be taken into account, but particularly those which might be connected with the sexual disorder. This includes all urological, gynecological or psychosomatic illnesses and surgery as well as medication and/or substance abuse or addiction. It is also important to record all information concerning pregnancies and childbirth. In addition, all therapy relevant to sexual disorders and previous psychotherapeutic treatment need to be looked into.

Bio-psycho-social anamnesis needs to include diagnostics for somatic findings. This concerns **sexual functions** as well as **general physical functions**. An overview on the necessary physical diagnostics

Table 26.4 Organ diagnostics in sexual dysfunctions in men (Rösing et al. 2009)

Physical Diagnostics	Diagnostic Method	For Exclusion	Indication
Clinical examination	Inspection, palpation, pulse, exercise tolerance test	Urogenital, neurological and cardiovascular diseases	General examination in connection with risk factors (e.g. age, overweight)
Laboratory	Blood sugar Lipids Testosterone	Diabetes mellitus Dyslipidosis Hypogonadism	General examination General examination If necessary in arousal disorder or erectile dysfunction (ED), depending on further hypogonadism symptoms
Imaging	Prolactin	Prolactinoma	
	Duplex sonography with intracavernous pharmacotesting	Cavernous insufficiency	If necessary in ED; in the case of no response to oral medication and wish for SKAT
	Neurophysiology (e.g. corpus-cavernosum-EMG)	Neurogenic deficit (e.g. following an accident)	If necessary in ED when expertise or scientific issues are concerned
	Penile angiography	Pelvic vascular occlusion	Only in planned revascularisation surgery

concerning sexual dysfunctions in males is shown in [Table 26.4](#) (Rösing et al. 2009).

26.7 Principles of Therapy in Sexual Medicine

The described bio-psycho-social cause of sexual disorders calls for an appropriate therapeutic approach, a combination of methods of “talking medicine” with those of somatic-/and pharmacological intervention (Rösing et al. 2009).

Taking the treatment of post-prostatectomy erectile dysfunction caused by prostate cancer in Germany as an example, Herkommer et al. (2006) show that in long-term exclusive use of medication or mechanical treatment options, the patients were clearly less satisfied than their treating urologists would have imagined. Even concerning selection of therapy options the patients’ comments were clearly discrepant to the judgment of their treating physicians. Questions concerning the importance of partnership, of non-genital sexuality (the exchange of affectionate words and deeds) and genital sexuality (intercourse) put to prostate cancer patients and their partners showed that before and after radical prostatectomy only the importance of genital sexuality decreased. Partnership in general and the meaning of physical attachment (the exchange of affectionate words, gestures and touches)

maintained an unchanged high value (Rösing and Berberich 2004). The high rating of satisfaction of psycho-social intimacy, closeness and security in comparison to aiming at sexual erotic satisfaction has also been validated by other studies (Deneke 1999).

Sexological interventions, therefore, are absolutely based on consideration of bio-psycho-social aspects of sexuality and on systematic involvement of aspects of partnership and communication. Such modifications of the conventional patient concept also lead to a different understanding of therapy.

The familiar relationship of “therapist-patient” is extended – especially in the case of sexual disorders – to a new **“therapist-couple” relationship**. Advocacy for the patient turns into plural advocacy for the couple and their partnership, as long as this is the mandate given to the therapist. According to a Paracelsus quotation: “The patient is the doctor and the doctor is his assistant”, here lies the real therapeutically effective work with a couple; the “assistant” accompanying – making suggestions, settling problems, supporting, confronting, possibly acting as interpreter between different personalities and genders. He enables the couple to gain new insights, especially new experiences which are designed to improve life quality. So the therapeutic aim is focused on partnership and sexuality.

As patients with all sexual disorders described ([Sect. 26.3](#)) may attend an andrological clinical practice, various common links would very well serve as a

basis for the application of sexological therapy options. In everyday practice an indication-based cooperation between andrology and sexual medicine has already proved itself: this applies particularly to the use of pharmacological options in the treatment of sexual preference disorder and/or behavioral disorders (cyproterone acetate, LHRH-analoga) as well as use of cross-gender hormone treatment in transsexual gender identity disorders.

26.7.1 Sexological Consultation

The foremost principle is to create awareness in the patient/couple concerning the attachment dimension of sexuality and to apply this therapeutic aspect. Many patients/couples do not realize that genital/coital sexuality is only one of many ways of satisfying wishes within a partnership concerning needs for authenticity, appreciation, satisfaction, closeness, security etc.

Accordingly sexological counselling will be adapted to the specific needs of the patient/couple, in which the following priorities alone or combined may play a role:

Passing on knowledge (where deficits are obvious) concerning anatomic, physiological or psychological processes of sexual reaction, and, if necessary, correcting false ideas in the sense of sexual myths (e.g., masturbation causes harm) which one or both of the partners may believe in.

Assessment of mutual hopes and expectations concerning sexuality and partnership. **Teaching communicative strategies**, if diagnostics have established that general communication difficulties are a reason for the development or continuation of the disorder/dysfunction concerned.

When basic illnesses are involved, specific information must be obtained:

- About the time elapsed between surgery and resumption of sexual contact (usually after approximately 6 weeks)
- About the use of lubrication gel, if, for instance, the vaginal epithelium is altered by radiological or chemotherapy or due to menopause
- In some cases concerning the use of aids (such as an erection ring, a vacuum pump, oral or injectable medication options) – but not before dealing with discrepancies in the relationship between the part-

ners concerning the significance of the different dimensions of sexuality

26.7.2 Sexual Therapy

A largely negative experience of sexuality may create and continue sexual disorders which are bound to put strain on a partnership. Here, within the setting of sexological treatment, the (newly found or rediscovered) understanding about the interrelatedness of the three dimensions of sexuality can be combined with well-directed evaluation and openness in talks about new physical experiences. In this way, partnership intimacy may revive because of new shared sexual experiences and change intimacy previously experienced.

The general aim of therapy is, as mentioned before, to enable both partners to satisfy each others' fundamental human needs – which are based on full acceptance – through their sexual behavior in partnership again.

The method developed by Beier and Loewit (2004) called *Syndyastic Sexual Therapy* (this new term “syndyastic” is derived from the Greek word “syndyastikós” – “inclined to intimate relations in the sense of “affiliation” of two people, i.e., a couple or partnership”, was first applied by Aristoteles in his Nicomachean Ethics) puts fulfillment of psychosocial fundamental needs into therapy focus. This makes it quite different from all other treatment methods (Rösing et al. 2009).

The priority is not to restore sexual function, the therapeutic aim is to broaden the context of sexuality (particularly to appreciate the dimension of attachment), thereby gathering new experiences of (sexual) body communication and improving (sexual) partnership satisfaction on the whole. (The option of effective medication or other aids is no contradiction and can be a helpful supplement at times) (see Sect. 26.5.3).

Thus, within the course of therapy, new, mutually agreed upon, intimate experiences for the couple emerge, allocating a new significance of sexuality in a much broader sense. These are not “prescriptions”, because it is not possible to “prescribe” anything in a relationship; they are genuine, holistic and consciously lived partnership experiences.

It is immediately evident that, in an existing partnership, the syndyastic focus is most effectively carried out by genuine involvement of the partner, placing the partnership itself, i.e., the couple into the center of attention.

Particularly by sexually-lustful bodily acceptance and intimate closeness basic needs are likely to be most intensively fulfilled. It is, however, to be noted, that this involves activation of basically already existing potential. Something is retrieved and nothing is “added”, which also discloses the limits of this treatment method.

Finally it must be stressed, that the syndyastic sexual therapy method is not restricted to certain specialized fields or schools. It merely relies on a basic psychosomatic understanding and the willingness not to project oneself into the role of the objective expert, but to actually concentrate on the syndyastic focus – trusting in the knowledge that improvement of the fulfillment of psychosocial fundamental needs can lastingly affect all other areas of life and health.

26.7.3 Integration of Somatic Therapy Options

Including somatic options within sexual therapy takes the bio-psycho-social etiology of sexual dysfunction into consideration. Often it makes invasive somatic interventions unnecessary, can, however, restrict the duration of sexual therapy, improve compliance and prognosis of all treatment approaches – but is unfortunately hardly ever put to use in clinical practice.

As in all therapies, a combined course implies both problems and opportunities which have to be weighed up against one another in each single case: The patient/the couple may misunderstand the application of medication as a form of an uncomplicated “quick-repair method”, which paralyzes the self-healing energy of the couple and can reduce the motivation to deal with personal or partnership problems.

On the other hand, a combined course of action

- Improves the effectiveness and prognosis of the treatment in many cases
- Conveys to the patient that the therapist takes seriously the patient’s own viewpoint, often fixed on somatic causes
- Establishes an initial working relationship and
- By taking the patient seriously, opens a pathway to consideration of psychosocial aspects

Male patients are often convinced their problems are of physical nature. In clinical sexological practice the purpose is to lead them towards psychological or

partnership points of view and to persuade them about the quality of a bio-psycho-social context of sexuality.

This succeeds only (or at least better) if the therapist is well informed about the advantages and disadvantages of medical treatment options. If the therapist is able to convey to the patient that he sees their possibilities and limits and wants to consider them with the patient, particularly with regard to the dimension of relationship, then there is a good chance of building up a strong working relationship and a solid basis for dealing with psychological and partnership problems.

References

- Abraham L, Symonds T, Morris MF (2008) Psychometric validation of a sexual quality of life questionnaire for use in men with premature ejaculation or erectile dysfunction. *J Sex Med* 5:595–601
- Ahlers CJ, Schaefer GA, Beier KM (2005) Das Spektrum der Sexualstörungen und ihre Klassifizierbarkeit im ICD-10 und DSM-IV. *Sexuologie* 12:120–152
- Ahlers CJ, Schaefer GA, Mundt IA, Beier KM (2009) Diversity and prevalence of paraphilia-associated sexual arousal patterns (PASAPs): First results of the Berlin Male Study II. *J Sex Med* (in press)
- APA (American Psychiatric Association) (2000) Diagnostic and statistical manual of mental disorders, 4th edn rev. (DSM-IV-TR). APA-Press, Washington, DC
- Althof SE (2006) Prevalence, characteristics and implications of premature ejaculation/rapid ejaculation. *J Urol* 175: 842–848
- Balint M (1965) *Die Urformen der Liebe und die Technik der Psychoanalyse*. Huber, Klett, Bern/Stuttgart
- Bartels A, Zeki S (2004) The neural correlates of maternal and romantic love. *NeuroImage* 21:1155–1166
- Beier KM (1995) Aurorismus: Klinische Erscheinungsform einer “weiblichen Analogie” zur Perversion. *Geburtsh Frauenheilk* 55:323–330
- Beier, KM (2000) Female analogies to perversion. *J Sex Marit Ther* 26:79–93
- Beier KM, Loewit K (2004) *Lust in Beziehung. Einführung in die Syndyastische Sexualtherapie*. Springer, Heidelberg
- Beier KM, Bosinski HAG, Loewit K (2005) *Sexualmedizin. München/Jena/Elsvier/ Urban & Fischer* 2, Auflage
- Beier KM, Wille R, Wessel J (2006) Denial of pregnancy as a reproductive dysfunction: A proposal for international classification systems. *J Psychosom Res* 61:723–730
- Bowlby J (1969, 1973, 1980) *Attachment and loss*, vol. 1, 2, 3. Basic Books, New York
- Braun M, Wassmer G, Klotz T, Reifenrath B, Mathers M, Engelmann U (2000) Epidemiology of erectile dysfunction: Results of the ‘Cologne Male Survey’. *Int J Impot Res* 12:305–311
- Brisch KH (1999) *Bindungsstörungen. Von der Bindungstheorie zur Therapie*. Klett-Cotta, Stuttgart
- Buddeberg C (1996) *Sexualberatung. Eine Einführung für Ärzte*,

- Psychotherapeuten und Familienberater, 3. erw. Aufl. Stuttgart, Enke
- Chevret M, Jaudinot E, Sullivan K, Marrel A, De Gendre AS (2004) Impact of erectile dysfunction (ED) on sexual life of female partners: Assessment with the Index of Sexual Life (ISL) questionnaire. *J Sex Med* 5:595–601
- Chew KK, Bremner A, Jamrozik K, Earle C, Stuckey B (2008) Male erectile dysfunction and cardiovascular disease: Is there an intimate nexus? *J Sex Med* 5:928–934
- Deneke FW (1999) Psychische Struktur und Gehirn: die Gestaltung subjektiver Wirklichkeiten. Schattauer, Stuttgart/New York
- Egle UT, Hoffmann SO, Steffens M (1997) Psychosoziale Risiko- und Schutzfaktoren in Kindheit und Jugend als Prädisposition für psychische Störungen im Erwachsenenalter. *Nervenarzt* 68:683–695
- Englert H, Schaefer G, Roll S, Ahlers C, Beier K, Willich S. (2007) Prevalence of erectile dysfunction among middle-aged men in a metropolitan area in Germany. *Int J Impot Res* 19:183–188
- Feldman HA, Goldstein I, Hatzichristou D G, Krane RJ, McKinlay JB (1994) Impotence and its medical and psychosocial correlates: Results of the Massachusetts male aging study. *J Urol* 151:54–61
- Fisher WA, Rosen RC, Eardley I, Sand M, Goldstein I (2005) Sexual experience of female partners of men with erectile dysfunction: The female experience of men's attitudes to life events and sexuality (FEMALES) study. *J Sex Med* 2:675–684
- Fröhlich G (1998) Psychosomatik männlicher Sexualität. *Sexuologie* 5:203–211
- Görge G, Flüchter S, Kirstein M, Kunz T (2003) Sexualität, erektile Dysfunktion und das Herz: Ein zunehmendes Problem. *Herz* 28:284–290
- Herkommer K, Niespodziany S, Zorn C, Geschwend JE, Volkmer BG (2006) Versorgung der erektilen Dysfunktion nach radikaler Prostatektomie in Deutschland. *Urologe* 45:336–342
- Kleinplatz PJ, Ménard AD (2007) Building blocks toward optimal sexuality: Constructing a conceptual model. *Family Journal: Counseling and Therapy for Couples and Families* 15:72–78
- Långström N, Zucker KJ (2005) Transvestic fetishism in the general population: Prevalence and correlates. *J Sex & Marital Ther* 31:87–95
- Laumann EO, Paik A, Rosen, RC (1999) Sexual dysfunction in the United States: Prevalence and predictors. *JAMA* 281:537–544
- Laumann EO, Nicolosi A, Glasser DB, et al (2005) Sexual problems among women and men aged 40–80 y: Prevalence and correlates identified in the Global Study of Sexual Attitudes and Behaviors. *Int J Impot Res* 17:39–57
- Masters WH, Johnson VE (1966) Human sexual response. Little, Brown, Boston (dt.: Die sexuelle Reaktion. Reinbek, Rowohlt 1970)
- Mathers MJ, Schmitges J, Klotz T, Sommer F (2007) Einführung in die Diagnostik und Therapie der Ejakulatio praecox. *Dtsch Arztebl* 104:A-3475–3480
- Montagu A (1987) Körperkontakt. Stuttgart, Klett-Cotta
- Montorsi F (2005) Prevalence of premature ejaculation: a global and regional perspective. *J Sex Med* 2(Suppl 2):96–102
- Pfaff DW (1999) Drive. Neurobiological and molecular mechanisms of sexual motivation. MIT Press, Cambridge
- Ponseti J, Bosinski HAG, Wolff S, Peller M, Jansen O, Mehdorn HM, Büchel C, Siebner, HR (2006) A functional endophenotype for sexual orientation in humans. *NeuroImage* 33:825–833
- Porst H, Montorsi F, Rosen RC, Gaynor L, Grupe S, Alexander J (2007) The premature ejaculation Prevalence and Attitudes (PEPA) survey: Prevalence, comorbidities, and professional help-seeking. *Eur Urol* 51:816–823
- Rosen RC, Seidman SN, Menza MA, et al (2004) Quality of life, mood, and sexual function: a path analytic model of treatment effects in men with erectile dysfunction and depressive symptoms. *Int J Impot Res* 16:334–340
- Rösing D, Berberich HJ (2004) Krankheits- und behandlungsbedingte Sexualstörungen nach radikaler Prostatektomie – Eine bio-psycho-soziale Betrachtung *Urologe [A]* 43:291–295
- Rösing D, Klebingat KJ, Berberich HJ, Bosinski HAG, Loewit K, Beier KM (2009) Sexualstörungen des Mannes – Diagnostik und Therapie aus sexualmedizinisch-interdisziplinärer Sicht. *Dtsch Arztebl* (in press)
- Rüegg JC (2003) Psychosomatik, Psychotherapie und Gehirn. Neuronale Plastizität als Grundlage einer biopsychosozialen Medizin. Schattauer, Stuttgart
- Savic I, Berglund H, Lindström, P (2005) Brain response to putative pheromones in homosexual men. *Proc Natl Acad Sci USA* 102:7356–7361
- Schäfer GA, Engert HS, Ahlers ChJ, Roll S, Willich SN, Beier KM (2003) Erektionsstörungen und Lebensqualität: Erste Ergebnisse der Berliner Männer-Studie. *Sexuologie* 10(2/3):50–60
- Vincent CE (Hg) (1964) Human sexuality in medical education and practice. Thomas, Springfield, IL
- Vogt HJ, Loewit K, Wille R, Beier KM, Bosinski HAG (1995) Zusatzbezeichnung “Sexualmedizin” – Bedarfsanalyse und Vorschläge für einen Gegenstandskatalog. *Sexuologie* 2: 65–89
- WHO (1993) Internationale Klassifikation psychischer Störungen: ICD-10, Kapitel V (F): Klinisch-diagnostische Leitlinien. Bern, Huber
- Zettl S, Hartlapp J (1997) Sexualstörungen durch Krankheit und Therapie. Ein Kompendium für die ärztliche Praxis. Springer, Berlin/Heidelberg

Contents

27.1 Requirements and Perspectives	557
27.1.1 Contraception, Family Planning and World Population.....	557
27.1.2 Global Goal of WHO: Reproductive Health.....	560
27.1.3 Acceptability of Male Contraception.....	560
27.1.4 Possibilities	561
27.2 Existing Methods	562
27.2.1 Coitus Interruptus.....	562
27.2.2 Periodic Abstinence	562
27.2.3 Condoms	563
References	564

27.1 Requirements and Perspectives

Making contraceptive methods available to men is one of the tasks of andrology. Such methods are necessary both to maintain stable populations in industrial nations, as well as to diminish population growth in developing countries.

This chapter deals with the reasons for male contraception as well as social and demographic factors and the conventional methods for male contraception are described. A separate chapter is devoted to vasectomy and refertilization (Chap. 28), while research and development in the field of male contraception are dealt with in Chaps. 29 and 30.

27.1.1 Contraception, Family Planning and World Population

When giving advice about contraception and family planning as well as prescribing contraceptives, the physician must always concentrate on the desires and problems of the individual couple. Over and beyond this he should be aware that contraception also has demographic implications and influences population dynamics. While the individual couple may have its own ideas about the number of children they want, representative opinion surveys on the ideal size of the family show that these wishes have hardly changed in the course of the history of the German Republic and have remained at about two children per family; however, the actual number of children per couple had already started to decline from the beginning of industrialization in the nineteenth century i.e., a trend which

E. Nieschlag
Centre of Reproductive Medicine and Andrology
of the University, Domagkstr. 11, D-48149 Münster/Germany
e-mail: Eberhard.Nieschlag@ukmuenster.de

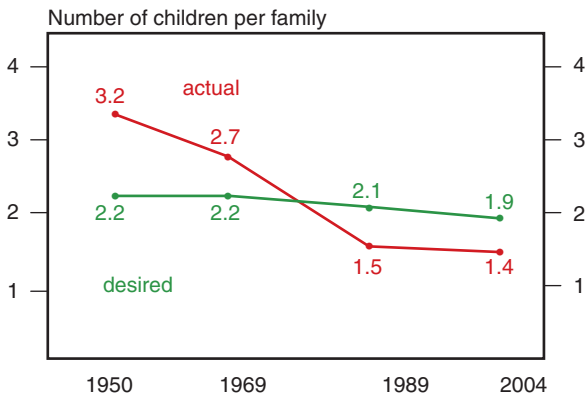

Fig. 27.1 Desired vs. actual number of children per family; representative surveys among Germans over 16 years of age in 1950, 1969, 1989 and 2004 (Allensbach Opinion polls 32, 2043, 5053 and 5177)

began in Germany and Europe even prior to modern contraception (Birg 2001). However, with the introduction of oral contraception and other modern methods in the 1960s, the number of births began to slowly decline and today the actual birthrate lies even lower than the desired goal (Fig. 27.1).

The introduction of modern contraceptive methods led to a social revolution which has above all benefited

women (Benagiano et al. 2007). Deliberate birth control, e.g., for economic reasons, was already practiced during earlier centuries (Bengtson and Dribe 2006). Today's contraceptive methods enable the couple to realize their goals more closely. Conversely, it is incorrect to assume that the mere availability of contraceptives leads to a reduction of population in lesser developed countries; the individual couple's motivation and desires remain decisive.

In 2007, the world population was 6.6 billion, having tripled in the last 50 years. Even conservative prognoses estimate that **8 billion** will populate the earth by 2020 (Fig. 27.2). Lesser developed countries bear the onus of this enormous population growth, while the population of industrial nations is largely stable. The population explosion creates hardly surmountable ecological and economic problems. India can be taken as an example, where one sixth of the world's population occupies 2.5% of the earth's land surface, and where uncontrolled population growth wipes out the country's economic progress, which has in part been spectacular. Medical progress has decisively lowered mortality, particularly of children, so that life expectancy worldwide is currently 64.2 years for men and 68.6 for women. Ever more people reach reproductive age.

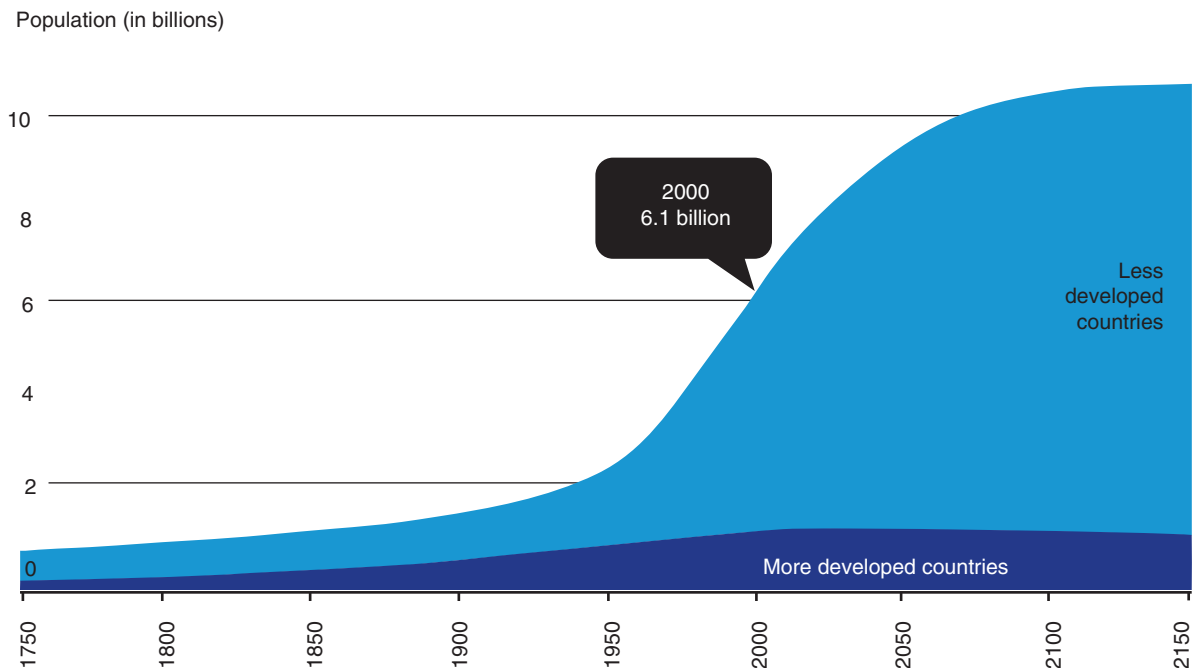

Fig. 27.2 Worldwide population growth from 1750 to 2150. Medium level projection by the United Nations World Population Prospects 2007

Life expectancy has increased due to possibilities offered by effective medical intervention. In contrast, medicine offers only limited possibilities of adjusting reproduction to altered social and cultural life circumstances. Thus even today abortion, considered ethically and culturally unacceptable in many countries, is used for “family planning.” As a consequence, of the approximately 1,000,000 conceptions taking place daily, of which about 50% are unplanned and 25% unwanted, **150,000 are terminated daily worldwide by abortion.** Of these terminations, 500 end lethally for the woman. Comparative investigations have shown unequivocally that the highest numbers of abortions are performed in those countries where effective contraceptive methods are not available (Fig. 27.3). Thus the Netherlands and Germany have the lowest rate, while the formerly eastern block states (with the exception of Catholic Poland), and Cuba have the highest numbers. The example of Russia illustrates this reciprocal relationship: just prior to the dissolution of the old Soviet empire the rate of legal abortions was 64 per 1,000 inhabitants. With the fall of the Iron Curtain the use of modern contraceptives rose rapidly and the abortion rate fell to below 40 per 1,000 inhabitants in 1996 and has now reached 19.3 per 1,000 inhabitants (Fig. 27.3). The low birth rates

in western industrial nations and the generally stable demographic status are of decisive importance for prosperity and are largely due to contraceptive methods.

It is, however, of much concern that research in the field of contraception has greatly declined in recent years. Especially industrial nations have reduced their efforts. Leading pharmaceutical firms have drastically reduced studies on female methods and some have even terminated research programs dealing with male contraception (Strauss and Chaudhuri 2007).

Publicly funded programs exist *only* in the USA (on a modest level) and **only** a few organizations such as the WHO and the World Bank, as well as philanthropic foundations (Population Council, New York) have active research programs (Vogel song et al. 2008). To date the EU has systematically excluded contraception from its funding.

In the meantime researchers have become alarmed (Nieschlag and Henke 2005; Nieschlag 2009) and politicians are beginning to acknowledge the problem. Thus a committee of the British Parliament has clearly recognized that without limitation of population growth the “Millenium Development Goals” cannot be met (All Party Parliamentary Group 2007). The connection between world population growth, prosperity

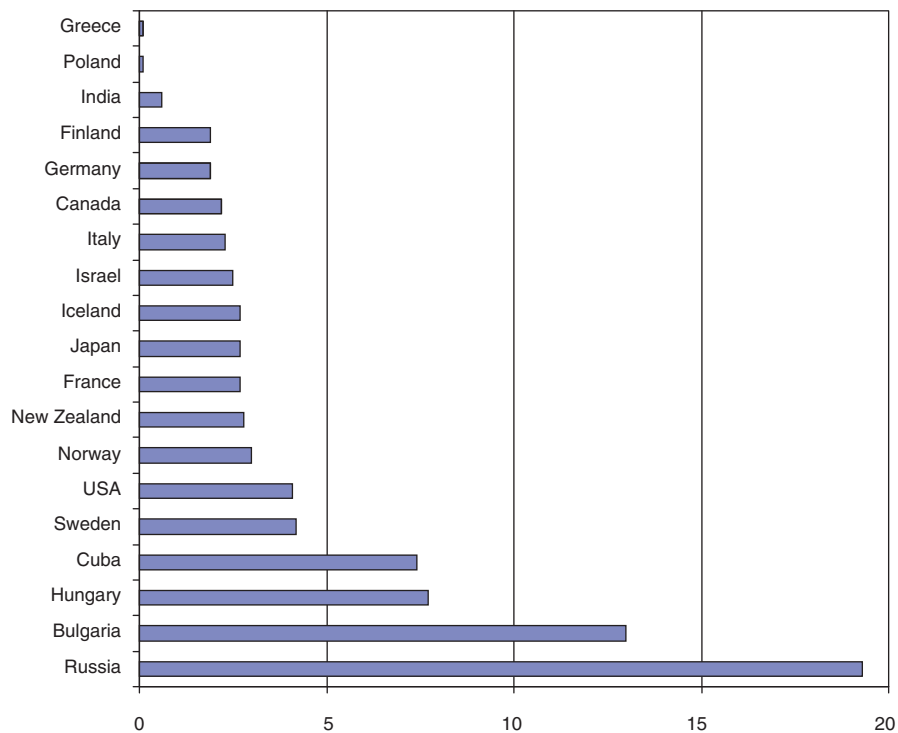

Fig. 27.3 Number of annual abortions per 1,000 inhabitants in various countries (Most recent available data compiled by United Nations Human Development Report 2009)

for all and uncontrollable ecological problems is becoming evident to ever growing circles. Ultimately however, research can only provide the means for contraception. Its application in the sense of “reproductive rights” remains with the couple and the decision to use contraceptive methods depends on other factors such as education and professional training of young women. Thus a clear correlation between reduction of illiteracy and the use of contraception was found.

27.1.2 Global Goal of WHO: Reproductive Health

Deeply aware of the situation, WHO introduced the concept of “Reproductive Health” as its goal in this area. **Reproductive health** means that reproductive processes and functions should take place under conditions of “complete physical, mental and social well-being” and signifies not only freedom from disease and from possible disturbances of reproductive functions. A child, once conceived, should have optimal conditions for undisturbed gestation and birth as well as for healthy childhood and development. Reproductive health implies the possibility of realizing the desire for

offspring, as well as of controlling and planning fertility. **Contraceptive methods for men and women are considered essential components of strategies which should lead to a high standard of reproductive health worldwide.**

27.1.3 Acceptability of Male Contraception

Recently public interest in male methods for contraception has notably grown. It is increasingly expected that men share with their partners not only the advantages but also the risks of family planning. As risks tend to increase with duration of use, sharing contraception between men and women would reduce dangers for each partner. Population conferences and women’s world forums have explicitly called for new male contraceptive methods.

Worldwide **one quarter of all couples practicing contraception rely on male methods**, albeit with varying preferences (Fig. 27.4) and the proportion of men practicing contraception is increasing. Thus in the Netherlands the percentage of vasectomized men whose wives were of reproductive age rose from 2%

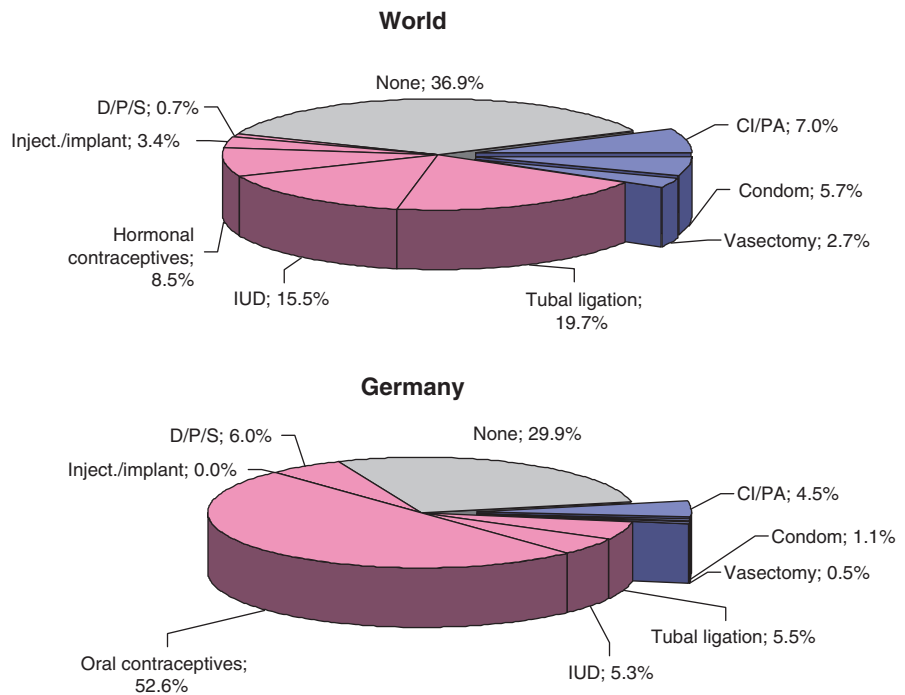

Fig. 27.4 Use of contraceptive methods worldwide and in Germany. D/P/S: diaphragms, cervical cap, spermicides etc. CI/PA: coitus interruptus, periodic abstinence (UN Population Division, New York 2007)

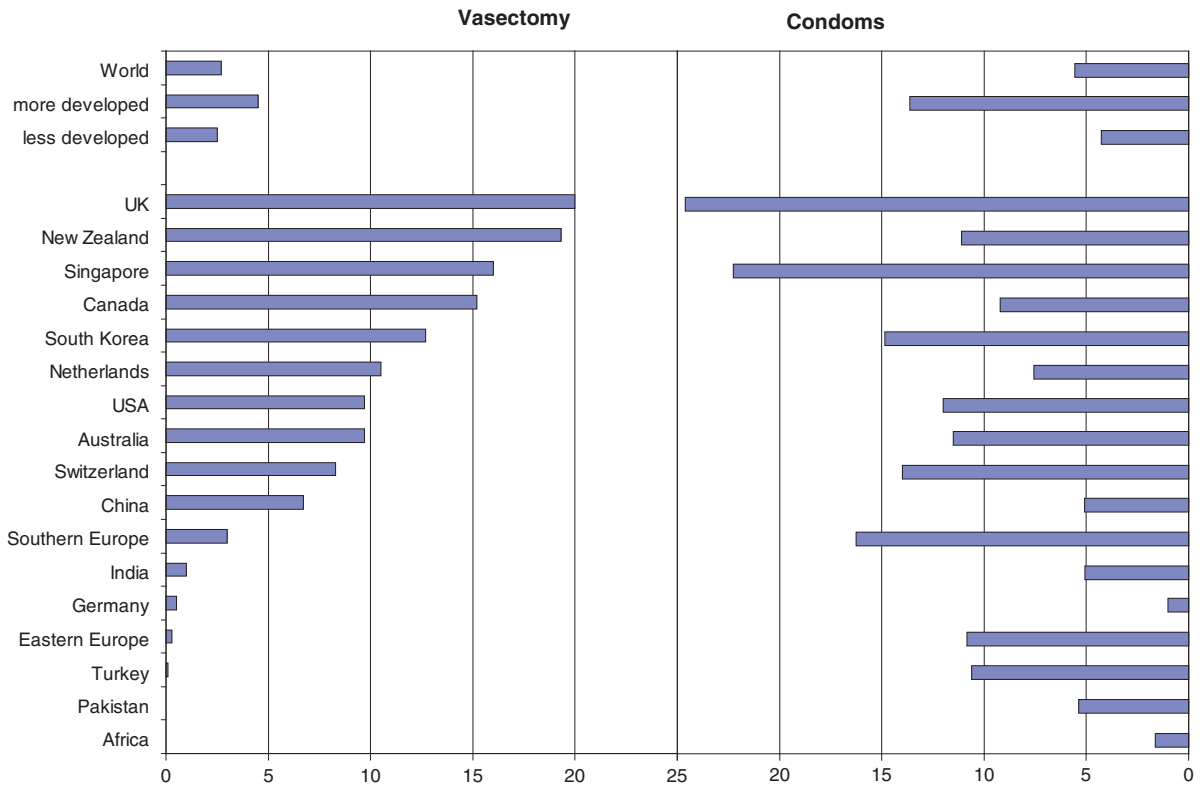

Fig. 27.5 Worldwide and country-specific use of vasectomy and condoms. Figures represent percentages of women who are married or in union in 2007 (www.unpopulation.org)

to 10.5% from 1975 to 2008 and from 8% to 12.2% in the USA; the highest rate of vasectomized men is found in the United Kingdom and in New Zealand. Worldwide, however, only 2.7% of men are vasectomized. Similarly, the use of condoms for contraception varies from country to country with a worldwide average of 5.7% (Fig. 27.5). It is to be expected that the percentage of men willing to practice contraception varies between cultures and with methods available. According to a survey in Hongkong and Shanghai 10 years ago, half the men interviewed were willing to take a daily contraceptive pill; in Edinburgh and Capetown two thirds were willing to do so (Anderson and Baird 1997). After almost 50 years of female oral contraception, the attitude of men towards **new** methods of male contraception has changed. Worldwide and also in Germany surveys showed men willing to use pharmacological contraceptive methods (Heinemann et al. 2005) (Fig. 27.6).

27.1.4 Possibilities

In general men's willingness to contribute to contraception can be considered to be high. However, before men accept such a contraceptive method certain prerequisites must be fulfilled. The method should:

1. Be as **effective** as comparable female methods
2. Be **acceptable** to both partners
3. Be **rapidly effective**
4. Be **free of side-effects** and especially be without influence on masculinity, libido and potency
5. Be **without influence** on progeny
6. Be **reversible** in regard to fertility
7. Be easily **available** and financially **affordable**

These criteria provide guidelines for evaluating existing methods and experimental innovations. Basically these methods can be characterized as follows:

Fig. 27.6 Multinational male fertility control survey among 9,342 men. “If available would you be willing to use the new male fertility control method?” (Heinemann et al. 2005)

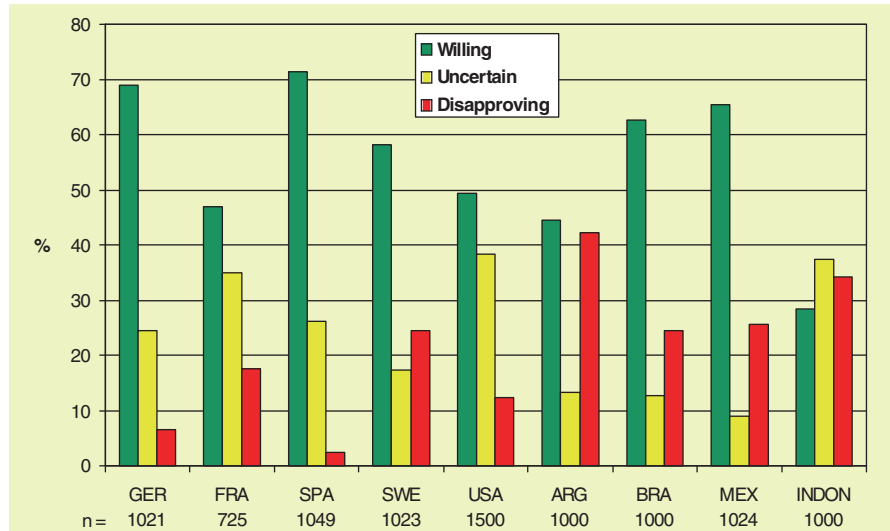

1. Those preventing sperm transport into the female genital tract
2. Those suppressing spermatogenesis or
3. Those preventing sperm maturation or function

All existing methods belong to the first group, whereas current research concentrates on influencing germ cell development and maturation.

The possibilities of effective **and** reversible contraception are limited to female methods. **Periodic abstinence**, the **condom** and **coitus interruptus**, as relatively unsafe methods, or **vasectomy**, as a method with limited reversibility, are **available to the male**.

The distribution of male and female methods used worldwide and, for example in Germany, shows (Fig. 27.4) that basically only a narrow spectrum of methods is actively available. All pharmacological methods derive from **one** principle, namely **hormonal contraception**. The danger of overdependence on this method becomes apparent when one considers a possibly drastic reduction in its use. This should provide sufficient impulse to search for new methods. As no male pharmacological method for contraception yet exists, research in this field remains a major task (see Chaps. 29 and 30) (Fig. 27.6).

Existing and experimental methods are described in the following section.

27.2 Existing Methods

27.2.1 Coitus Interruptus

The criteria given in Sect. 27.1.4 can be used to evaluate existing and new methods for male contraception. The method practiced longest, **coitus interruptus**, has the advantage of being completely free of side-effects, requires nothing additional and costs nothing. It does, however, require dexterity and self-discipline and reduces sexual pleasure. Moreover, **its failure rate is high**, as a pregnancy occurs in 19 out of 100 couples during the first year of practice. Other non-penetrating sexual practices (“dry sex”) probably have lower pregnancy rates, but no exact figures are available.

27.2.2 Periodic Abstinence

Periodic abstinence, on which the various methods of **natural family planning (NFP)** are based, limits sexual activity to so-called “safe days” on which the likelihood of conception is low. Even if this method relies on observations based on the female cycle, it does require a male contribution as spontaneity and intercourse must be foregone for relatively long phases of the cycle. The methods’ safety increases with the number of days of abstinence from intercourse. On average a large number

of failures is presumed in which 20 of 100 couples per year conceive (Trussell et al. 1998). In a German women's hospital 38 of 87 (= 45%) women gave birth after pregnancies occurring despite contraception based on "safe days" (Knuth and Mühlenstedt 1991).

If a portable monitoring device (Persona®) is used to indicate days on which abstinence is to be practiced by measuring LH and estrone-3-glucuronide in urine, the pregnancy rate drops to 12% (Bonnar et al. 1999). On average 13 days within a cycle must be considered "unsafe" or other contraceptive methods must be used during this time.

When evaluating coitus interruptus, periodic abstinence and non-penetrating sexual practices it must be considered that despite their low effectiveness, in demographic terms these methods may contribute to population control, even if the risk of pregnancy remains high for the individual couple.

27.2.3 Condoms

The condom is the oldest contraceptive method available today. Early Egyptian drawings show men wearing condoms. In 1200 BC fishbladders were used at the Minoan court on Cyprus to prevent disease and pregnancies. In 1564 the Italian anatomist Fallopio described linen bags saturated with medication to be used to avoid venereal disease. In seventeenth century England condoms were first used for birth control. It is not certain whether the name derives from the English physician Condom, who was active at the court of Charles II from 1660 to 1685 and who recommended lamb intestines for contraception. The method was quickly exported to France and became widely used in Paris. Condoms were known there as "capote anglaise," while in England they were called "French letters." The latex-based condom was made possible by the American Charles Goodyear (1800–1860) after he invented the process of vulcanization. The first large-scale manufacturer was Julius Fromm, who produced 150,000 condoms daily in 1920.

At present condoms continue to be manufactured largely from latex, but polyurethane condoms are also available. As these have a higher rupture rate and offer even less contraceptive protection than latex condoms, their use is limited to users allergic to latex (Gallo et al. 2006). At present spray-on condoms are being tested, which would solve the problem of size.

Today the manufacture of condoms is subject to standardized quality control and specifications of the WHO (2004). Since 1996 condoms sold in Europe must fulfill quality requirements as prescribed in the DIN EN 600, international ISO 4074 (since 2002). These norms prescribe a size of 17 or 16 cm length and a maximum diameter of 5.6 cm. In addition, the contraceptives must undergo serial tests for impermeability, inflatability, elasticity and microbiological purity.

Even if manufacturing is subject to quality control, in a high percentage of cases the condom may tear during intercourse. The older the condom, the higher the risk of damage (Steiner et al. 1992). Apparently sexual practice also plays a role, as some couples always report a higher rate of tearing than others, as seen in trials with motivated and experienced couples who had no problems with tearing (Rosenberg and Waugh 1997).

Reports on contraceptive effectiveness of the condom show considerable variation. In general, it is assumed that 19 out of 100 couples will conceive during the first year of condom use (Trussell 1998). This is considerably better than the 85% of conceptions arising from unprotected intercourse, but ranges far behind the 3% probably achieved by female oral contraceptive methods. Contraceptive protection is lower for polyurethane condoms than for latex condoms (Gallo et al. 2006). In addition, effectiveness drops if condoms are used for a longer timespan. This depends not only on technical defects of the product but on the fact that condoms must be used in direct connection with the sexual act and require constant motivation and attention. For this reason many couples in stable relationships consider condoms only as a temporary contraceptive method.

The acceptability of condoms varies greatly with socio-cultural factors. It is estimated that in Japan almost four fifths of couples practicing contraception use condoms. In Germany about a quarter of all couples of reproductive age use them.

Since the beginning of the AIDS epidemic and the call for "safe sex" the condom has greatly gained in popularity to avoid the risk of infection. Its effectiveness in avoiding HIV transmission is, however, markedly lower than in preventing pregnancies. This is not surprising in view of the technical failure rate and in view of the fact that the danger of infection exists not only at the time of ovulation but during every sexual act. Meta-analyses conclude that the failure rate in the prevention of HIV infections is about 31% (Weller 1993) to 50% (April et al. 1993). Thus the protective

effect of the condom against this often lethal disease must be considered inadequate.

References

- All Party Parliamentary Group on Population, Development and Reproductive Health (2007) Return of the population growth factor: Its impact upon the Millennium Development Goals. House of Commons, London
- Anderson RA, Baird DT (1997) Progress towards a male pill. *IPPF Med Bull* 31:3–4
- April K, Köster R, Schreiner W (1993) Wie effektiv schützen Kondome vor einer HIV-Übertragung? *Med Klinik* 88: 304–311
- Benagiano G, Bastianello C, Farris M (2007) Contraception: A social revolution. *Europ Contracept Reprod Health Care* 12:3–12
- Bengtson T, Dribe M (2006) Deliberate control in a natural fertility population: Southern Sweden, 1766–1864. *Demography* 43:727–746
- Birg H (2001) Die demographische Zeitwende. 4. Auflage, C.H. Beck, München
- Bonnar J, Flynn A, Freundl G, Kirkman R, Royston R, Snowden R (1999) Personal hormone monitoring for contraception. *Br J Fam Plann* 24:128–134
- Connelly M (2008) Fatal misconception: The struggle to control world population. Belknap Press of Harvard University Press, Cambridge, MA
- De Vincenzi I for the European Study Group on Heterosexual Transmission of HIV (1994) A longitudinal study of human immunodeficiency virus transmission by heterosexual partners. *N Engl J Med* 331:341–346
- Gallo MF, Grimes DA, Lopez LM, Schulz KF (2006) Non-latex versus latex male condoms for contraception. *Cochrane Database Syst Rev* CD 003550
- Heinemann K, Saad F, Wiesemes M, White S, Heinemann L (2005) Attitudes toward male fertility control: Results of a multinational survey on four continents. *Hum Reprod* 20:549–556
- Knuth UA, Mühlenstedt D (1991) Kinderwunschdauer, kontrazeptives Verhalten und Rate vorausgegangener Infertilitätsbehandlung. *Geburtsh Frauenheilk* 51:1–7
- Nieschlag E (2009) Male hormonal contraception: love's labour's lost? *J Clin Endocrinol Metab* 94: 1890–1892
- Nieschlag E, Henke A (2005) Hopes for male contraception. *Lancet* 365:554–556
- Rosenberg MJ, Waugh MS (1997) Latex condom breakage and slippage in a controlled clinical trial. *Contraception* 56:17–21
- Steiner M, Foldesdy R, Cole D, Carter E (1992) Study to determine the correlation between condom breakage in human use and laboratory test results. *Contraception* 46: 279–288
- Strauss JF, Chaudhuri G (2007) The accelerated pace of pharmaceutical abandonment of research and development in family planning and fertility: Will reproductive health technology be frozen in time? *Fertil Steril* 87:818–718
- Trussell J (1998) Contraceptive efficacy. In: Hatcher RA, Trussell J, Stewart F (eds) *Contraceptive technology*. New York: Ardent Media, New York, pp. 779–844
- Vogelsong K, Gabelnick HL, Nieschlag E (2008) Partnerships offer promise in developing systemic methods of male fertility regulation. *Global Forum Update on Research for Health* 4:128–130
- Weller SC (1993) A meta-analysis of condom effectiveness in reducing sexually transmitted HIV. *Soc Sci Med* 36: 1635–1644
- WHO (2004) The male latex condom: Specifications and guidelines for condom procurement. Geneva

Contents

28.1	History of Vasectomy	565
28.2	Social and Demographic Relevance	566
28.3	Indications for Vasectomy	566
28.4	Informed Consent	567
28.5	Surgical Vasectomy Techniques.....	567
28.6	Technical Modifications.....	568
28.7	Effectiveness and Cost Efficiency	568
28.8	Complications.....	568
28.9	Vasectomy and Long-Term Morbidity.....	569
28.10	Psychosexual Effects	570
28.11	Refertilization.....	570
	28.11.1 History of Refertilization Surgery	570
	28.11.2 Current Demand and Frequency of Refertilization	570
	28.11.3 Vasovasostomy.....	571
	28.11.4 Epididymovasostomy.....	573
	28.11.5 Future Developments in Surgical Refertilization.....	573
28.12	Future Development of Vasectomy.....	574
	References.....	575

28.1 History of Vasectomy

It is impossible to date the earliest vasectomy. At the end of the nineteenth century such operations were not performed for sterilization, but for other medical indications. At the time of the earliest vasectomies it was believed that severing the vas deferens would improve prostate disease, heal impotence or extend life expectancy. Vasectomy was advocated as a “**fountain of youth**” (Isnardi 1896; Wolfers and Wolfers 1974).

Eugenic aspects also played an important role among the indications for sterilization, as did elements of **social control** as advocated by Ochsner (1899) and Sharp (1902). In the 1920s and 1930s a series of nations passed laws justifying sterilization for eugenic reasons. Along with the other cruelties practiced by the Third Reich, compulsory sterilization for eugenic purposes achieved worldwide notoriety following the end of World War II. This resulted in the abrogation of the legal basis for eugenic sterilization in most states. Some states, however, maintained these laws and later some tried to apply them. Drake et al. (1999) describe the varied history of vasectomy and its changing indications over the course of time.

Vasectomy as a means of **contraception** became popular in the 1960s, first in the USA, then in Europe and Third World nations. Countries with particularly rapid population growth such as India and Thailand (Nirapathpongporn et al. 1990) established vasectomy camps and, according to Smith et al. (1985), in the USA sterilization became the form of fertility control most frequently chosen by married couples over 30 years of age. According to a survey, in Germany a frequency of about 50,000 vasectomies per year can be extrapolated (Deindl 1990).

U. Engelmann (✉)
Urologic University Hospital, Joseph-Stelzmann-Str. 9,
D-50924 Köln
e-mail: u-h-engelmann@uni-koeln.de

28.2 Social and Demographic Relevance

Countries with high birth rates should be considered apart from industrial nations. Contraceptive vasectomy is not popular in all developing countries, and in some it plays no role at all. In India and China, and, to a lesser extent, in Korea, Sri Lanka and Bangladesh, vasectomy is widely performed (Ross and Huber 1983). Generally, sterilization in the male always **competes directly with corresponding measures in the female**, i.e., tubal ligation, which ironically has become increasingly popular because of improved techniques, although vasectomy was always technically simple (Ross and Huber 1983). In any event, the introduction of **minimally invasive “no scalpel” techniques** serves to make vasectomy much more acceptable (Xiaozhang and Shungiang 1993; Reynolds 1994; Ozvaris et al. 1998). These are based on percutaneous electrocoagulation or chemical denaturing of the vas, or specialized puncture instruments which are used to minimize surgical trauma.

Particular ethical considerations concerning male sterilization apply in developing countries (Rizvi et al. 1995) and explain the former preference for female over male sterilization (3:1) with the rationale that vasectomy is hardly reversible and thus unpopular. New and advanced technologies such as sperm cryopreservation are only available in wealthy countries.

Sixty-seven to 88% of the American population use contraceptive methods for obviation of pregnancy, as reported by the “Behavioral Risk Factor Surveillance System”. According to this survey, women favor oral contraceptives, while men primarily rely on the surgical approach, i.e., vasectomy (Bensyl et al. 2002).

Another study found that about 25% of eligible couples in the USA rely on sterilization for birth control, with distinct differences between black and white populations: among Caucasians vasectomy and tubal ligation are performed about equally, while among blacks tubal ligation is clearly preferred (Forste et al. 1995). In the USA vasectomized men generally have above-average education, their family planning is complete and they learned about vasectomy methods in newspapers or magazines (Kohli 1973). Thirty years later, no significant changes can be ascertained: vasectomized men in the USA are typically well-educated, married Caucasians with good medical insurance (Barone et al. 2004).

In England only minimal differences between social classes were found with respect to the acceptance of vasectomy (Wright et al. 1977). The general acceptance

of vasectomy as compared to tubal ligation has increased over the years in England (Rowlands and Hannaford 2003), as well as in Canada. The use of oral contraceptives and tubal ligation in the Canadian population is decreasing, while requests for vasectomies are steadily rising (Martin and Wu 2000). With advanced and ongoing aging of the population, vasectomy is no longer only an issue for young men. Older men also engage in sexual activity and favor vasectomy for contraception. In an Australian study of middle-aged males, 25.1% had been vasectomized, 5.6% of the vasectomized men did not have children and 37% of men above 70 years of age were still sexually active (Holden et al. 2005).

In Germany, Schirren (1983) above all drew attention to the subject of vasectomy, to indications for the intervention and to its possible complications. In 1983 he propagated the incorrect, and unfortunately still prevalent, opinion that vasectomy represented an irrevocable intervention which, if performed without sufficient consultation with one’s partner and “inner circle”, could be considered a “dangerous undertaking”. Considerable consequences for the personality structure of the man and thus for the partnership were postulated. On the contrary, it has since been demonstrated that men who are prepared to undergo vasectomy usually live in **relationships with a strong emphasis on partnership**. Under certain conditions, positive and beneficial effects for a relationship can even be expected (Goebel et al. 1987). This influences patient selection made by counselling and operating physicians, resulting in the fact that in Germany predominantly men living in stable relationships are vasectomized. The number of vasectomized men varies in German-speaking countries: in Germany 422 men per million inhabitants are vasectomized annually; in Austria the number is only 81 (Engelmann et al. 1990).

28.3 Indications for Vasectomy

In contrast to formerly held but still widely accepted opinions, we believe that the indication for contraceptive vasectomy is easily established.

Every man of legal age and able to give consent may decide in favor of vas ligation or occlusion for the purpose of sterilization.

No special medical or social indication is necessary. But many physicians performing vasectomy require certain preconditions, mostly to provide backup support for the physician. In such cases, for example, a certain number of children are required, a stable relationship with written consent given by the partner is desired; finally, the chances for refertilization are deliberately and falsely minimized. These measures represent a bias concerning the affected persons; only those highly determined to undergo vasectomy will be accepted. This procedure may be understandable, but it is not in the best interest of the responsible citizen and patient. He has the right to objective counselling about the chances and risks concerning the intervention he wishes. Well-meaning, but false-negative counselling of the patient must not deprive him of the possibility of deciding in favor of vasectomy. This does not limit the surgeon's right to decline to perform a vasectomy in individual cases.

28.4 Informed Consent

As in all other surgical procedures, the patient must be informed and his consent obtained at least 1 day prior to the operation itself. We observe **the procedures generally accepted for surgery** without any special modifications. Neither consent of the female partner, nor even her existence is required. Information is provided about the procedure, which is almost always carried out on an outpatient basis. The **chances for subsequent refertilization** are explained according to statistics in the literature with patency rates of 70–90%. **Acute complications** consisting of bleeding and infections, usually negligible, rarely occur, but are mentioned. **Possible connections between vasectomy and other diseases**, e.g., arteriosclerosis or prostate cancer, discussed in the past and again recently, are mentioned to the patient with reference to the relevant investigations. In cases of doubt, the physician's explanation and personal interpretation may be helpful. The need for **postoperative semen analysis** is stressed. Although other surgeons proceed differently, we do not regularly use written forms for informing the patient and we do not even insist on a written statement of consent. We do, however, note in the patient's chart that **informative counselling** has taken place.

Special considerations are involved when **vasectomies are performed on patients who are not able**

to consent to the procedure themselves. Due to Germany's recent past, this is a particularly sensitive subject there. Various lobbies as well as the German Society of Medical Law (DGMR) have discussed this subject in publications, lectures and workshops. In Germany, vasectomy policy for patients who are not able to consent to the procedure is regulated by law. Consent demands the authorization of a guardianship court. **Vasectomy of minors is forbidden** in Germany. Neither the underage patient nor his parents can consent to sterilization (Hiersche and Hiersche 1995).

28.5 Surgical Vasectomy Techniques

Vasectomy is a good example of how simple matters can be made complicated. What is to be achieved? The goal of the operation is to occlude the ducts reliably to prevent passage by spermatozoa, permanently or as long as the patient desires it. The following procedure has been established:

In the ambulatory patient both spermatic cords are infiltrated with an anesthetic. Only in rare and exceptional cases is the intervention performed under general or regional anesthesia. The cords are digitally localized through the scrotal skin and, if necessary, local anesthesia is supplemented by deeper infiltration. After ascertaining the effectiveness of the anesthesia, the ejaculatory duct is clamped through the skin, using a small clamp, and the scrotal skin is incised over a distance of 0.5–1 cm. The vas is separated from the sheath and divided over two mosquito clamps. The vas is then dissected and a piece of approximately 1 cm is excised and fixed in formalin. The vasal ends are ligated and electrocoagulated. The entrance wound is sutured with a single suture (Figs. 28.1 and 28.2). The identical procedure is performed on the contralateral side. The wounds are covered with two small dressings. After 1 h the area is checked and the patient can be discharged to home care.

The following is important: the patient must be **well-informed** and not be afraid of the procedure. In dubious cases, **premedication** is highly effective. In sensitive patients placement of a venous catheter is recommended. It should not be forgotten that even in

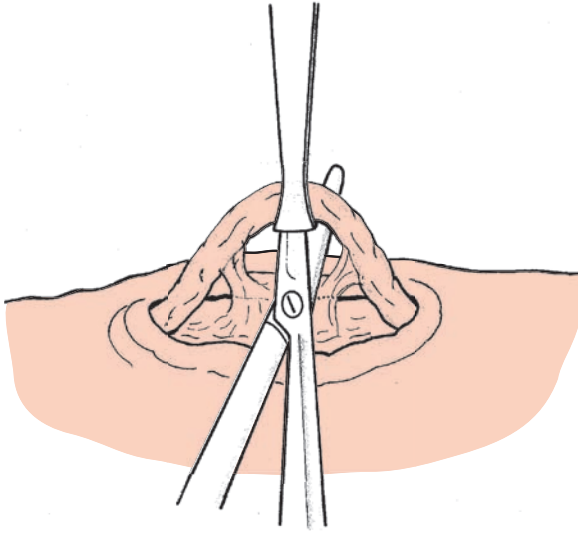

Fig. 28.1 Following a longitudinal incision of the scrotal skin along the vas deferens the vas is lifted by a small clamp

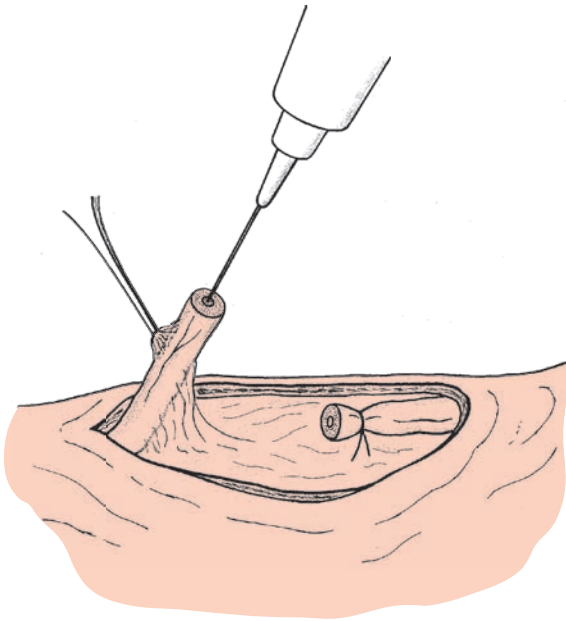

Fig. 28.2 Distal ligation of the vas deferens and cauterization of the proximal lumen

such minor surgery emergency measures may become necessary. **Acute complications** are rare, but when they do occur, they are extremely irritating. Even minor bleeding can spread throughout the soft tissue, resulting in **scrotal hematoma** up to the size of a fist.

28.6 Technical Modifications

The technique described above, practiced and well-documented for over 30 years, represents a combination of several important features. The use of a special puncture device has obtained general acceptance as a “no scalpel” technique; the same is true for electrocoagulation of the cut edges of the vas deferens or the interposition of connective tissue (fascial interposition: FI). Labrecque et al. (2004) concluded in a systematic review that the “no scalpel” vasectomy is the safest surgical approach to the vas deferens and that a combination of FI and electrocoagulation yields the most effective occlusive results. Comparable data were reported by Cook et al. (2007a, b) in two Cochrane Reviews: the “no scalpel” technique is associated with a lower rate of hematoma and infection and less postoperative pain compared to the conventional technique. Moreover, fascial interposition reduces the occurrence of vasectomy failures.

28.7 Effectiveness and Cost Efficiency

When correctly performed, vasectomy is among the **safest contraceptive methods**. In most larger-scale studies the failure rate lies below 1% (Trussell et al. 1990), or between 0% and 2% (Awsare et al. 2005). This makes vasectomy as effective as tubal ligation. Failure is due to **recanalization** of the divided duct in up to 1.5% of cases (even possible in the form of late recanalization after two negative spermograms in 0.04–0.2% of patients), or to the extremely rare occurrence of a **double vas** or **incomplete division** of the duct. Failure rates increase with lack of experience, inferior operating techniques and difficult anatomical circumstances.

Vasectomy is the most cost-efficient method of contraception (Nakhaee et al. 2002); thus, its implementation could achieve considerable cost savings in public health (Sonnenberg et al. 2004).

28.8 Complications

Acute postoperative complications must be distinguished from long-term complications. **Hematoma** of various degrees, **epididymitis** or **wound infections** up

to formation of an abscess occur with a frequency of up to 1–6% (Alderman 1991; Schwingl and Guess 2000). While this rate seems high, it should be remembered that vasectomy is a minor operation performed by many surgeons with only limited experience with this procedure. Its supposed harmlessness tempts some surgeons to perform it on an outpatient basis, quickly and inattentively. The price is necessarily an increased rate of acute complications. These lead to short-term **absence from work** of an average of 2.3 days (Randall and Marcuson 1985). **Serious complications virtually never occur**; deaths during or after vasectomy have not been reported, whereas in the USA 14 deaths/year are attributed to female sterilizations. Concerning **costs**, vasectomy is more economical than tubal ligation, with the short-term costs of tubal ligation about three to four times higher (Smith et al. 1985; Hendrix et al. 1999).

Long-term surgical complications include **recanalization** on the one hand and the development of **sperm granuloma** on the other. Recanalization rates are reported to be about 0–3%. The actual rate depends on the surgical technique used. Resection of larger sections of the vas, burying the ends of the ducts in different planes of tissue, the use of fibrin glue or fulguration of the lumen are all useful methods for minimizing the rate of recanalization. The use of minimally invasive techniques can, on the one hand, increase the chance of later refertilization, but, on the other hand, it can also greatly increase the chance of recanalization by up to 50% (Goldstein 1983). The occurrence of sperm granuloma is likewise correlated with surgical procedures used and varies considerably. The data in the literature vary between 3% and 75%. In terms of refertilization chances, a sperm granuloma can be evaluated positively as it reduces pressure in the epididymis and epididymal tubule and thus reduces the risk of a “blow-out”. This is an intraoperative tubal rupture, requiring an epididymovasostomy, which may be made impossible by the anatomical localization of the rupture.

It is important to explain **acute complications** to the patient and particularly to make him aware of the **possibility of failure**; he must be informed that, in individual cases, recanalization may occur even when postoperative semen analysis shows azoospermia on several occasions. If recanalization is to be completely excluded, the duct should be resected over several centimeters. Furthermore, **polyorchidism** and a **duplex vas** must be ruled out. For liability reasons, it is

advisable to perform histological examinations of the resected parts of the duct to demonstrate the resection in complete tubal diameter.

28.9 Vasectomy and Long-Term Morbidity

Complaints of congestion, a feeling of obstruction or heaviness in the testis and epididymis as well as **pain** of different degrees are occasionally described by the patient, but are usually temporary. Chronic epididymal pain is in all events rarely seen; its appearance is sparsely documented in the literature. **Sperm antibodies** in the serum can be found in up to 70% of those sterilized (Heidenreich et al. 1994). Their presence is often associated with sperm granulomas. If refertilization is desired, we are not influenced by the presence of sperm antibodies nor by the titre, but perform refertilization in any case.

In the past, **various diseases have been causally attributed to vasectomy**. Based on monkey studies in 1978 it was concluded that vasectomy could enhance arteriosclerosis. Several large-scale investigations involving over 10,000 men determined that vasectomized men bore no higher risk for **arteriosclerosis, diabetes mellitus or immunological diseases** (Nieschlag 1987; Giovannucci et al. 1992). The risk of cardiovascular diseases after vasectomy is not increased in the long term, as Manson et al. reported in the “Physicians’ Health Study” in 1999. A few years ago a **possibly higher incidence of prostate carcinoma** in vasectomized males was suggested by retrospective investigations (Giovannucci 1993). Follow-up studies and risk factor analyses were unable to prove a connection. Various national urological societies, including the American Urological Association (AUA) and the German Society for Urology (DGU), have recommended informing the patient about current findings and leaving the decision to him as a consenting adult. The basic problem lies in the retrospective nature of these studies. Prospective, adequately controlled studies are necessary (Roth and Hertle 1994; NIH 1993; Farley et al. 1993; John et al. 1995). In the case of prostate cancer, these studies must additionally be designed over a 5-year or, even better, a 10-year period. Neither large population-based case control studies (Lesko et al. 1999), population-based cohort-studies

(Lynge 2002), nor systematic literature reviews (Bernal-Delgado et al. 1998) have been able to demonstrate an increased risk for the development of prostate carcinoma after vasectomy.

From the present state of knowledge, vasectomy does not promote a higher risk for the development of prostate carcinoma.

28.10 Psychosexual Effects

The history of vasectomy has already shown that psychosexual effects associated with vasectomy need not always be negative. On the contrary, the fact that the problem of contraception has been responsibly resolved usually has a positive effect on a relationship (Weidner and Weissbach 1992). The fear of unwanted pregnancy may disappear and sexual enjoyment may increase (Vaughn 1979; Miltsch and Senn 1999; Bertero et al. 2005). Conversely, those men who are pressured into being vasectomized (e.g., vasectomy camps!), whose religion discourages or even forbids such procedures and whose partners are opposed to it or who are not sufficiently informed, may experience vasectomy as associated with increased conflicts and complications. Thus the initial situation of the person, the expectations he places in vasectomy and how well informed he is are key factors for success. Correct information, pre-surgical counseling and post-operative care and attention are important. These measures can prevent fear concerning a loss of male identity and masculinity.

The long-term benefits and effectiveness of vasectomy continue to be discussed controversially (Jequier and Pryor 1998), even to the extent of spurious arguments that cryopreservation of sperm may replace refertilization or – even worse – replace information and counseling about vasectomy.

28.11 Refertilization

28.11.1 History of Refertilization Surgery

Isolated cases of vasovasostomy following accidental dissection of the vas deferens, mostly during hernia surgery, have been reported since the beginning of this century. After World War II true refertilization surgery,

namely vasovasostomy and epididymovasostomy, following deliberate ligation of the ducts became more frequent, and in 1948 O'Connor presented the first national survey on vasovasostomy. It is astonishing that at that early stage nationwide surveys were implemented to establish the indications, frequency and success of refertilization surgery. In the USA such surveys were repeated in 1973 (Derrick et al. 1973) and in 1979 (Wicklund and Alexander 1979).

In German-speaking countries the following situation prevails (Engelmann et al. 1990): along with the increase in vasectomies, there is a rising number of patients who wish to reverse the procedure. Of the many reasons, three concerns emerge. First, the higher divorce rate plays an essential role; the main reason for refertilization is **divorce followed by remarriage or a new partnership**. The second most frequent request comes from couples whose family planning had been completed by vasectomy, but who now have changed their minds or who have suffered the **unexpected death of one of their children**. The third reason is **improved economic standing** and the resulting possibility of being able to afford offspring.

Refertilization vasovasostomy has been performed for more than 40 years, but the technique has undergone major changes during that time. Initially, the macroscopic one-layer anastomosis technique, perhaps even with splinting of the small vas lumen, was applied. Increasing use of the operating microscope brought with it excellent postoperative results reported mainly by Silber (1977). This prompted the development of microscopic two-layer anastomosis without splints. Improved surgical results affected the mechanical patency of anastomosis, which must be considered the true control parameter of surgical quality. However, there is a discrepancy between surgical patency of the restored vas deferens and pregnancy rates, which are distinctly lower. Today refertilization surgery is largely performed with optical devices, i.e., with loupe magnification or surgical microscopes. Patency rates of 90% are common and are achieved by many.

28.11.2 Current Demand and Frequency of Refertilization

The potential demand for refertilization surgery can be roughly extrapolated from the number of sterilization

vasectomies performed, from the divorce rate and from other (secondary) parameters. It has been estimated to be 250,000–300,000 in the USA per year (Cos et al. 1983). In German-speaking countries a survey taken in 1990 revealed that the vasectomy reversal rate was 3.5% and requests for reversal were twice as high (Engelmann et al. 1990). In Sweden, the refertilization rate was 0.5–5.4/100,000 residents (Ehn and Liljestr nd 1997). It can be assumed that the number of refertilization operations will continue to increase due to improved counselling.

28.11.3 Vasovasostomy

28.11.3.1 Indications, Counseling, Consent, Costs

The typical patient desiring refertilization contacts his doctor, usually his urologist, often the same one who performed the vasectomy. The indication is the patient’s request, which in turn arises from the arguments described above. As for other surgery, refertilization requires truthful counseling. Invasiveness is comparable to that of vasectomy, with the exception that vasovasostomy requires more difficult surgical techniques. For this reason, general anesthesia is recommended and **hospitalization of 1–2 days** should be planned. As a general rule, we estimate **patency rates of 80%**; **pregnancy rates** are lower, at **60%**. If vasectomy was performed more **than 5 years prior**, we reduce these estimates by **a further 20%**. The surgeon’s experience with this operation (both positive and negative) should be considered. The possibility of a “blow-out” in the epididymis or even in the rete testis should be mentioned. This would then necessitate epididymovasostomy or can make surgery impossible for technical reasons.

In most countries, including Germany, expenses for surgical refertilization are **not covered by insurers** as a general rule. In some special cases, such as the death of a child with concomitant parental distress, or persistent pain due to sperm granuloma, exemptions are granted. In these cases, cost transfer agreements should be arranged preoperatively. According to Heidenreich et al. (2000), the expenses per childbirth after vasovasostomy account for only a fifth of those after MEAS/TESE and ICSI.

28.11.3.2 Vasovasostomy Technique

The patient is placed in supine position; usually a scrotal incision bilaterally or in the median of the raphe scroti is chosen. Less frequently an inguinal or infra-pubic approach is used. Usually the surgeon operates while seated, avoiding interference with the operating table pillar; the operating microscope should be placed before the patient is positioned. Operating time of 2–3 h should be anticipated; for this reason an indwelling catheter is sometimes inserted. Differing techniques have been described: initially macroscopic techniques with or without splinting of the lumen, followed by **microsurgical techniques** with loupe magnification or the operating microscope.

Macrosurgical techniques. Initially, surgical techniques without magnification and relatively coarse suturing material of 4-0 or 5-0 were used. Results were relatively poor because of complications such as sperm leakage and bad anatomical adaptation of the lumen. The advantages lay in simple and rapid performance of surgery and for these reasons some surgeons prefer macroscopic techniques even today. As late as 1999 Feber and Ruiz saw advantages in the shorter operating time, reduced costs and the need for fewer surgical skills (despite a patency rate of 87% and pregnancy rate of 50%).

Silber (1977) made a great contribution when he described the anatomical peculiarities of the severed vas, with sizes differing between the dilated side proximal to the testis and the non-dilated side, and demonstrated that good operating results were best achieved with anatomically correct adaptation of the lumina.

Microsurgical techniques. In our view, using **solely macrosurgical techniques for refertilization is obsolete**. While they may be applied for vas-anastomosis, although inferior in patency, patent epididymovasostomy is achieved purely by coincidence or not at all. Whether **loupes** with a two- to eightfold magnification or an **operating microscope** with the advantage of variable magnification and increased field of vision is used depends on the personal preference of the surgeon, even though the best patency results are achieved with the operating microscope.

In the event of scrotal vasectomy, we dissect the ends of the vas deferens via a lateral scrotal incision. The scarred ends of the vas are excised. Patency of the proximal vas deferens is determined after insertion of a small flexible Teflon canula by careful injection of

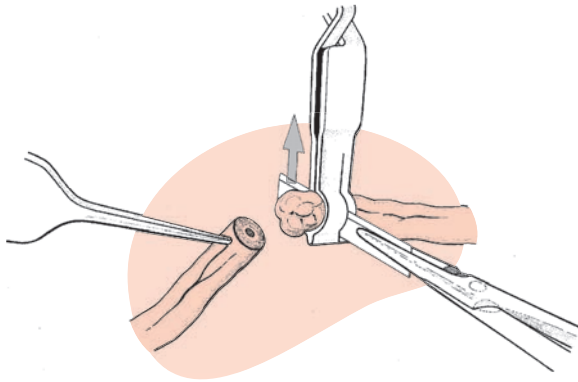

Fig. 28.3 Clean cuts of the two ends of the vas and careful bipolar hemostasis

saline solution. The fluid emerging from the distal vas end is assessed in the operating room under the operating microscope. If necessary, the epididymis is digitally massaged to obtain fluid. If no fluid is present, a “blow-out” must be assumed and the epididymis is examined. In such case we perform epididymovasotomy. Typically, whitish or yellowish fluid emerges containing viable or dead sperm. In this event, surgery is continued as vasovasostomy.

The best anatomical adaptation of the lumen is achieved using a two-layer technique by which mucosal approximation is accomplished with six interrupted sutures using 9-0 or 10-0 suturing material. Special vasovasostomy needles that are doubly armed and whose degree of curvature is adapted to the size of the vas have proven useful. The vas ends can be aligned by using an approximator, facilitating placement of sutures. First, the inner mucosal layer is sutured and should ensure a leak-proof connection. Precise positioning of the sutures will ensure optimal patency rates; Goldstein et al. (1998) were able to achieve rates of 99.5% using their “microdot marking technique” and eight mucosa stitches. The mechanical strength of the anastomosis is achieved through the second muscular layer, also using 9-0 or 10-0 sutures, however, with a single-sided and spatulated cutting needle. The short scrotal wound is closed in two layers. A well-fitting dressing supporting the scrotum is preferred by most patients and is left in place for a few days (Figs. 28.3–28.5).

28.11.3.3 Results of Vasovasostomy

Results of vasovasostomy are quite variable, depending on whether one reads reports by individual authors or

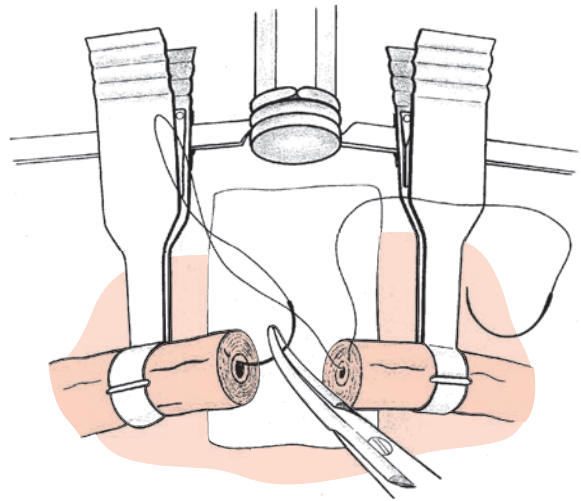

Fig. 28.4 Tension-free adaptation of the two ends of the vas by use of an approximator. Anastomosis of the mucosa is performed with nylon 10-0 double sutures

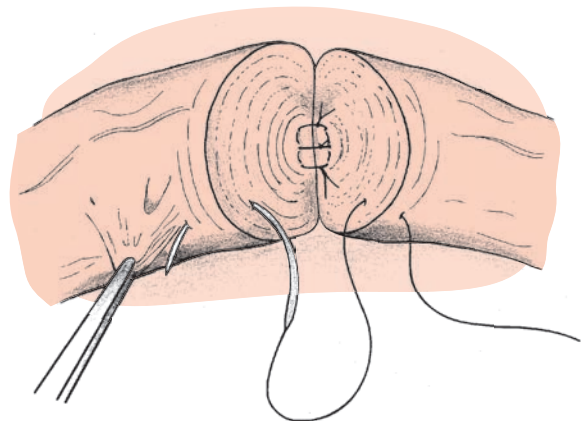

Fig. 28.5 Adaptation of the muscle layer of the vas by nylon 9-0 sutures

results from surveys. Similar variations are seen depending on whether patency rates are compared, describing surgical success, or pregnancy rates, which is the factor that most interests patients. Individual authors report patency rates of 100% and pregnancy rates slightly below. Nationwide surveys report average results more accurately: in 1948 O’Connor had a cumulative success rate of 38–40%; in 1973 Derrick calculated a patency rate of 38% and pregnancy rate of 11–26%. In 1990, Deindl found a cumulative patency rate of 73% in German-speaking Europe and a pregnancy rate of 47%. Centers with a high operating frequency, with skilful techniques and thin sutures, achieve better results. The time period between sterilization

vasectomy and refertilization plays a role; even if these limits are arbitrary, the best results can be expected within the first 2 years, while 10 years after vasectomy the chances for refertilization are markedly reduced (Belker et al. 1991).

28.11.3.4 Complications Following Vasovasostomy

The rate of **acute complications** is comparable with that for vasectomy or scrotal exploration, but for different reasons. Specific **long-term complications** result from re-obstruction after initial patency. A 3% chance of such obstruction because of scar tissue formation must be expected. If patients remain azoospermic following refertilization, it is probably due to surgical failure or a more distal “blow-out” that had not been verified at the time of surgery. In these cases re-operation is indicated. Oligozoospermia can be the result of partial obstruction – in such cases re-operation may be successful – or due to limited testicular production. If vasectomy dates back more than 5 years, we inform all patients about the option of concomitant cryo-TESE.

28.11.4 Epididymovasostomy

If the epididymal tubule is damaged by a “blow-out”, epididymovasostomy must be carried out. For technical reasons this procedure is only successful at the corpus or the cauda epididymidis. In the caput region, the diameter of the tubule is too small to accomplish fully patent anastomosis. **Epididymovasostomy** urgently requires microsurgical techniques, preferably using an operating microscope. We prefer to employ the end-to-side technique; others prefer side-to-side. After excising an oval window of the epididymal tunica, a single tubule containing sperm is chosen and is opened longitudinally. By placing four interrupted 11-0 sutures, anastomosis of the tubule with the mucosa of the vas deferens is completed. The anastomosis is then finished by means of further interrupted sutures between the epididymal tunica and the muscularis of the vas (Figs. 28.6–28.10).

End-to-end anastomosis is more difficult. The patency rates of microsurgical tubulovasostomy are between 39% and 100%, including single-case reports. The average patency rate is 45% and pregnancy rates are 18% (Deindl 1990).

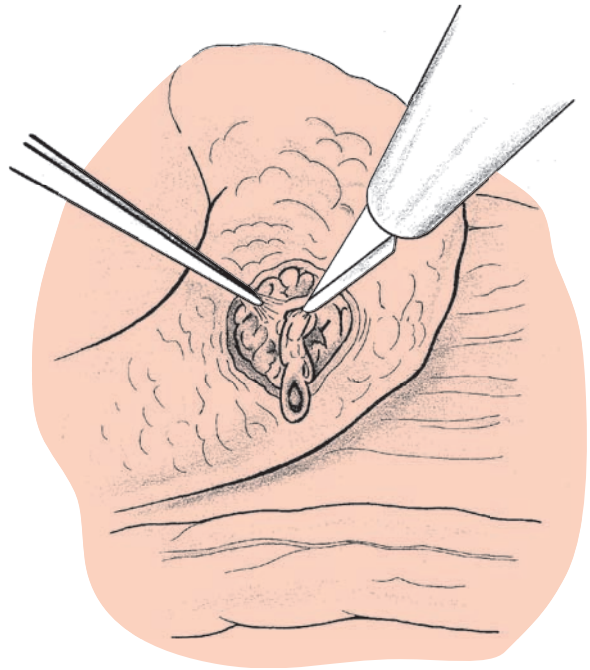

Fig. 28.6 A tubule is prepared and incised longitudinally

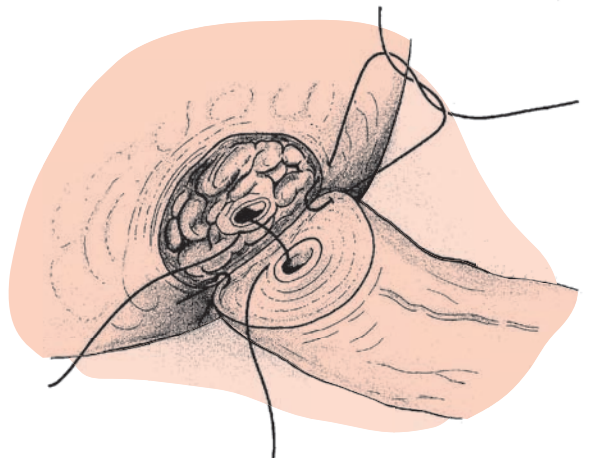

Fig. 28.7 Adaptation of the muscle layer of the vas and the tunica of the epididymis at the posterior circumference by nylon 9-0 single sutures

28.11.5 Future Developments in Surgical Refertilization

Refertilization surgery will become more common in future along with contraceptive vasectomy. The good results achieved have reached a stable level and have

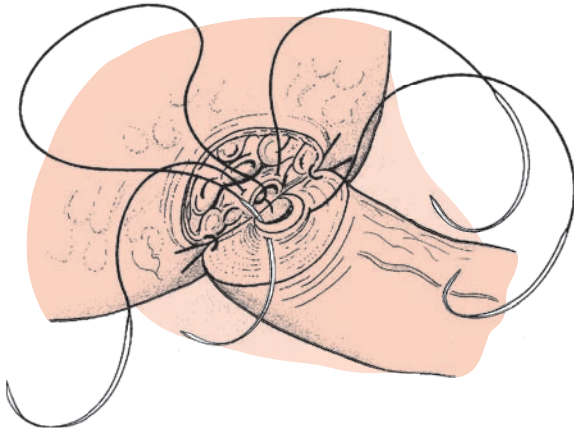

Fig. 28.8 Anastomosis between the tubule and the mucosa of the vas by nylon 10-0 doubly armed sutures

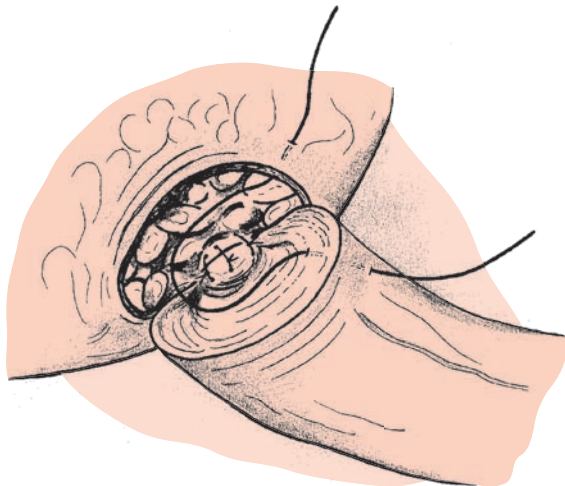

Fig. 28.9 Adaptation of the muscle layer of the vas and the tunica of the epididymis. Interrupted sutures at the anterior circumference with nylon 9-0 sutures

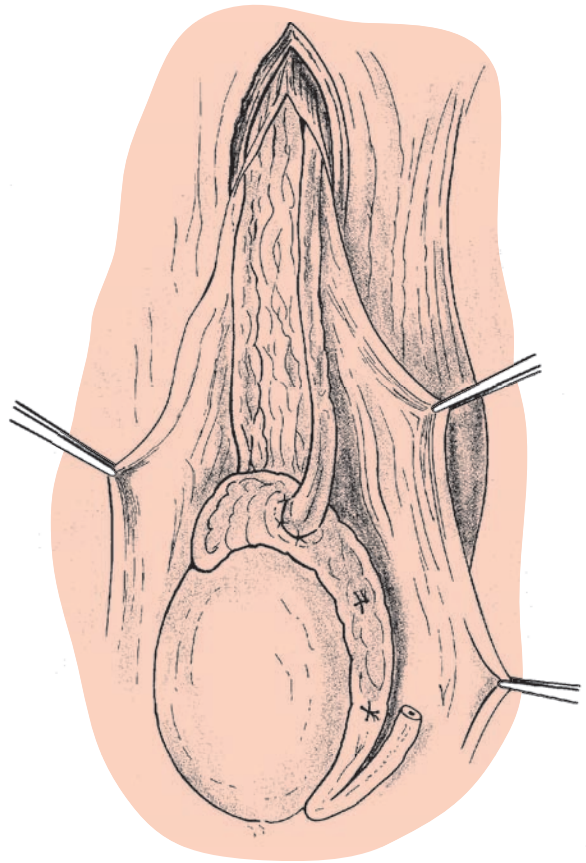

Fig. 28.10 Ligation of the epididymal tunic

We do not believe in abstaining from refertilization surgery and instead first harvesting sperm testicularly or – even worse – epididymally for use with ICSI. This method can by no means measure up to “conventional” refertilization surgery – either in terms of pregnancies achieved, the cost and effort involved, or with regard to complication rates.

not seen any further improvements during the past 10 years. Microsurgical training must continue to be emphasized for the surgeons involved.

The **intraoperative harvesting of sperm** which – cryopreserved – can be made available for later ICSI in case of a non-patent anastomosis (especially in the case of epididymovasostomies) should be discussed with patients even during the initial consultation (Djerassi and Leibo 1994). For those who wish to have children after vasectomy, surgical refertilization remains the method of choice from the standpoint of costs and chances for success.

28.12 Future Development of Vasectomy

Both from a demographic and political point of view, as well as for the individual selecting a contraceptive method, vasectomy represents a highly safe option that can be performed rapidly at low cost, with few inconveniences for the patient. Without doubt it is superior to the equivalent female operation. It is hoped that changes in the understanding of the male role and

better knowledge will bring about wider acceptance of vasectomy, especially in view of the fact that it is no longer to be considered final as in a high percentage of patients refertilization can be achieved by vasectomy reversal.

References

- Alderman PM (1991) Complications in a series of 1,224 vasectomies. *J Fam Pract* 33:579–584
- Awsare NS, Krishnan J, Boustead GB, Hanbury DC, McNicholas TA (2005) Complications of vasectomy. *Ann R Coll Surg Engl* 87:406–410
- Barone MA, Johnson CH, Luick MA, Teutonico DL, Magnani RJ (2004) Characteristics of men receiving vasectomies in the United States, 1998–1999. *Persps Sex Reprod Health* 36:27–33
- Belker AM, Thomas AJ, Fuchs EF, Konnak JW, Sharlip ID (1991) Result of 1,469 microsurgical vasectomy reversals by the vasovasostomy study group. *J Urol* 145:505–511
- Bensyl DM, Iuliano DA, Carter M, Santelli J, Gilbert BC (2002) Contraceptive use – United States and territories, Behavioral Risk Factor Surveillance System, 2002. *MMWR Surveill Summ* 54:1–72
- Bernal-Delgado E, Latour-Pérez J, Pradas-Arnal F, Gómez-López LI (1998) The association between vasectomy and prostate cancer: a systematic review of the literature. *Fertil Steril* 70:191–200
- Bertero E, Hallak J, Gromatzky C, Lucon AM, Arap S (2005) Assessment of sexual function in patients undergoing vasectomy using the international index of erectile function. *Int Braz J Urol* 31:452–458
- Cook LA, Pun A, van Vliet H, Gallo MF, Lopez LM (2007a) Scalpel versus no-scalpel incision for vasectomy. *Cochrane Database Syst Rev* CD 4112
- Cook LA, van Vliet H, Lopez LM, Pun A, Gallo MF (2007b) Vasectomy occlusion techniques for male sterilization. *Cochrane Database Syst Rev* CD 3991
- Cos LR, Valvo JR, Davis RS, Cockett ATK (1983) Vasovasostomy: Current state of the art. *Urology* 22:567–575
- Deindl F (1990) Die Refertilisationssituation in der Bundesrepublik Deutschland, der Republik Österreich und der Schweiz – eine Dreiländerumfrage. Inaugural Dissertation, Ruhr-Universität Bochum
- Derrick FC, Yarbrough W, Agostino JD (1973) Vasovasostomy: Results of questionnaire of members of the American Urological Association. *J Urol* 110:556–557
- Djerassi C, Leibo SP (1994) A new look at male contraception. *Nature* 370:11–12
- Drake MJ, Mills IW, Cranston D (1999) On the chequered history of vasectomy. *Br J Urol Int* 84:475–481
- Ehn BE, Liljestrand J (1997) Female and male sterilization in Sweden. *Gynecol Obstet Invest* 44:182–186
- Engelmann UH, Schramek P, Tomamichel G, Deindl F, Senge TH (1990) Vasectomy reversal in central Europe: Results of a questionnaire of urologists in Austria, Germany and Switzerland. *J Urol* 143:64–67
- Farley TMM, Meirik O, Mehta S, Waites GMH (1993) The safety of vasectomy: Recent concerns. *Bulletin of the World Health Organisation* 71:413–419
- Feber KM, Ruiz HE (1999) Vasovasostomy: Macroscopic approach and retrospective review. *Tech Urol* 5:8–11
- Forste R, Tanfer K, Tedrow L (1995) Sterilization among currently married men in the United States, 1991. *Fam Plann Perspect* 27:100–107, 122
- Giovanucci E, Tosteson TD, Speizer FE, Vessey MP, Colditz GA (1992) A long-term study of mortality in men who have undergone vasectomy. *N Engl J Med* 326:1392–1398
- Giovanucci E, Ascherio A, Rimm EB, Colditz GA, Stampfer MJ, Willett WC (1993) A prospective cohort study of vasectomy and prostate cancer in US men. *JAMA* 269:873–877
- Goebel P, Ortman K, Blattner TH (1987) Vasektomie und Beziehungssituation – eine empirische Untersuchung an 156 Männern (Paaren). *Zschr Psychosom Med* 33:119–138
- Goldstein M (1983) Vasectomy failure using an open-ended technique. *Fertil Steril* 40:699–700
- Goldstein M, Shihua PhL, Matthews GJ (1998) Microsurgical Vasovasostomy: The microdot technique of precision suture placement. *J Urol* 159:188–190
- Heidenreich A, Bonfig R, Wilbert DM, Strohmaier WL, Engelmann UH (1994) Risk factors for antisperm antibodies in infertile men. *Am J Reprod Immunol* 31:69–76
- Heidenreich A, Altmann P, Neubauer S, Engelmann UH (2000) Die mikrochirurgische Vasovasostomie im Zeitalter der modernen Reproduktionsmedizin – eine Kosten-Nutzen-Analyse. *Urologe A* 39:240–245
- Hendrix NW, Chauhan SP, Morrison JC (1999) Sterilization and its consequences. *Obstet Gynecol Surv* 54:766–777
- Hiersche HD, Hiersche F (1995) Die Sterilisation geistig Behinderter. *Gynäkologe* 28:452–458
- Holden CA, McLachlan RI, Cumming R, Wittert G, Handelsman DJ, de Kretser DM, Pitts M (2005) Sexual activity, fertility and contraceptive use in middle-aged and older men: Men in Australia, Telephone Survey (MATEs). *Hum Reprod* 20: 3429–3434
- Isnardi L (1896) Die Behandlung der senilen Dysurie mit Durchschneidung und doppelseitiger Ligatur der vasa deferentia. *Therap Wschr* 111:25–36
- Jequier AM, Pryor JP (1998) Is vasectomy of long term benefits? *Hum Reprod* 13:1757–1760
- John EM, Whittemore AS, Wu AH, Kolonel LN, Hislop TG, Howe GR, West DW, Hankin J, Dreon DM, Teh CZ (1995) Vasectomy and prostate cancer: Results from a multiethnic case-control study. *J Natl Cancer Inst* 87:662–669
- Kohli KL (1973) Motivational factors and socioeconomic characteristics of vasectomized males. *J Biosoc Sci* 5:169–177
- Labrecque M, Dufresne C, Barone MA, St-Hilaire K (2004) Vasectomy surgical techniques: A systematic review. *BMC Medicine* 2:21
- Lesko SM, Louik C, Vezina R, Rosenberg L, Shapiro S (1999) Vasectomy and prostate cancer. *J Urol* 161:1848–1853
- Lynge E (2002) Prostate cancer is not increased in men with vasectomy in Denmark. *J Urol* 168:488–490
- Manson JE, Ridker PM, Spelsberg A, Ajani U, Lotufo PA, Hennekens CH (1999) Vasectomy and subsequent cardiovascular disease in US physicians. *Contraception* 59:181–186
- Martin K, Wu Z (2000) Contraceptive use in Canada. *Fam Plann Perspect* 32:65–73

- Miltsch B, Senn E (1999) Vasektomie: Präoperative Bedenken und postoperative Akzeptanz. *Akt Urol* 30:237–241
- Nakhaee N, Mirahmadizadeh AR, Gorji HA, Mohammadi M (2002) Assessing the cost-effectiveness of contraceptive methods in Shiraz, Islamic Republic of Iran. *East Mediterr Health J* 8:55–63
- National Institutes of Health (NIH) (1993) Does vasectomy cause prostate cancer? *JAMA* 269:2620
- Nieschlag E (1987) Vasektomie – pro und contra. *Dtsch med Wschr* 112:1107–1109
- Nirapathpongporn A, Huber DH, Krieger JN (1990) No-scalpel vasectomy at the King's birthday vasectomy festival. *Lancet* 335:894–895
- Ochsner AJ (1899) Surgical treatment of habitual criminals. *JAMA* 33:867–868
- O'Connor VJ (1948) Anastomosis of the vas deferens after purposeful division for sterility. *J Urol* 59:229–233
- Ozvaris SB, Dogan BG, Akin A (1998) Male involvement in family planning in Turkey. *World Health Forum* 19:76–78
- Randall PE, Marcuson RW (1985) Absence from work following vasectomy. *J Soc Occup Med* 35:77–78
- Reynolds RD (1994) Vas deferens occlusion during no-scalpel vasectomy. *J Fam Pract* 39:577–582
- Rizvi SAH, Naqvi SAA, Hussain Z (1995) Ethical issues in male sterilization in developing countries. *Brit J Urol* 76:103–105
- Rowlands S, Hannaford P (2003) The incidence of sterilisation in the UK. *BJOG* 110:819–824
- Ross JA, Huber DH (1983) Acceptance and prevalence of vasectomy in developing countries. *Stud Fam Plan* 14:67–73
- Roth S, Hertle L (1994) Verursacht die Sterilisations-Vasektomie ein Prostatakarzinom? *Dt Arztebl* 91:409–410
- Schirren C (1983) Erfahrungen mit der Vasektomie. *Urologe A* 22:29–34
- Schwingl PJ, Guess HA (2000) Safety and effectiveness of vasectomy. *Fertil Steril* 73:923–936
- Sharp HC (1902) The severing of the vasa deferentia and its relation to the neuropsychopathic constitution. *NY Med J* 75:411–414
- Silber SJ (1977) Perfect anatomical reconstruction of vas deferens with a new microscopic surgical technique. *Fertil Steril* 28:72–77
- Smith GL, Taylor GP, Smith KF (1985) Comparative risks and costs of male and female sterilization. *Am J Pub Health* 75:370–374
- Sonnenberg FA, Burkman RT, Hagerty CG, Speroff L, Speroff T (2004) Costs and net health effects of contraceptive methods. *Contraception* 69:447–459
- Trussell J, Hatcher RA, Cates W, Stewart FH, Kost K (1990) Contraceptive failure in the United States: An update. *Stud Fam Plan* 21:51–54
- Vaughn R (1979) Behavioral response to vasectomy. *Arch Gen Psychiatry* 36:815–821
- Weidner W, Weißbach L (1992) Freiwillige Vasektomie in der Familienplanung – Gedanken zur Nutzen-Risiko-Analyse. *Akt Urol* 23:328–331
- Wicklund R, Alexander NJ (1979) Vasovasostomy: Evaluation of success. *Urology* 13:532–534
- Wolfers D, Wolfers H (1974) *Vasectomy and vasectomania*. London, Mayflower Books
- Wright N, Johnson B, Wiggins P, Vessey M (1977) The use of sterilisation as a method of birth control among participants in the Oxford/Family Planning Association Contraceptive Study. *Fertil Contracept* 1:41–44
- Xiaozhang L, Shungiang L (1993) Vasal sterilization in China. *Contraception* 48:255–265

Contents

29.1	Principle of Hormonal Male Contraception.....	577
29.2	Androgens Alone.....	578
29.2.1	Testosterone Enanthate	578
29.2.2	Testosterone Buciclate	579
29.2.3	Testosterone Undecanoate	579
29.2.4	Testosterone Pellets.....	581
29.2.5	19-Nortestosterone.....	581
29.2.6	7 α -Methyl-19-Nortestosterone (MENT)	581
29.3	Androgens Combined with GnRH Analogues ...	581
29.3.1	GnRH Agonists	581
29.3.2	GnRH Antagonists	581
29.4	Androgens Plus Gestagens	582
29.4.1	Depot Medoxyprogesterone Acetate (DMPA).....	583
29.4.2	Levonorgestrel	583
29.4.3	Norethisterone.....	583
29.4.4	Cyproterone Acetate	583
29.4.5	Desogestrel and Etonogestrel	584
29.5	Résumé and Outlook	584
References		585

29.1 Principle of Hormonal Male Contraception

Of all the different experimental approaches and pharmacological methods tested so far for male contraception, hormonal methods come closest to fulfilling the criteria set out above (see Chap. 27). The endocrine feedback mechanism operating between hypothalamus, pituitary and testes is the basis on which hormonal approaches to male contraception rest. Its goal is to suppress spermatogenesis and to reduce sperm concentration, if possible to azoospermia or at least to a sperm concentration low enough to provide contraceptive protection (<1 million sperm per ml ejaculate).

Sperm production and secretion of testicular testosterone are so closely interwoven that it has remained impossible to interrupt spermatogenesis by hormonal means without inhibiting androgen production (see Chap. 2 and Fig. 29.1). Inhibition of FSH alone, e.g., by antibodies, leads to reduction of sperm concentration but not to azoospermia, as monkey studies have shown. Suppression of both FSH and LH would indeed lead to azoospermia, but would also induce symptoms of androgen deficiency which affects libido, potency, male role behavior and general metabolic processes (erythropoiesis, protein, mineral and bone metabolism). For this reason inhibition of gonadotropins will always necessitate androgen administration.

Thus the principle of hormonal male contraception is based on

1. The suppression of LH and FSH
2. Depletion of intratesticular testosterone and atrophy of spermatogenesis
3. Substitution of peripheral testosterone to maintain androgenicity

E. Nieschlag (✉)
Centre of Reproductive Medicine and Andrology of the
University of Münster, D-48149 Münster, Germany,
e-mail: Eberhard.Nieschlag@ukmuenster.de

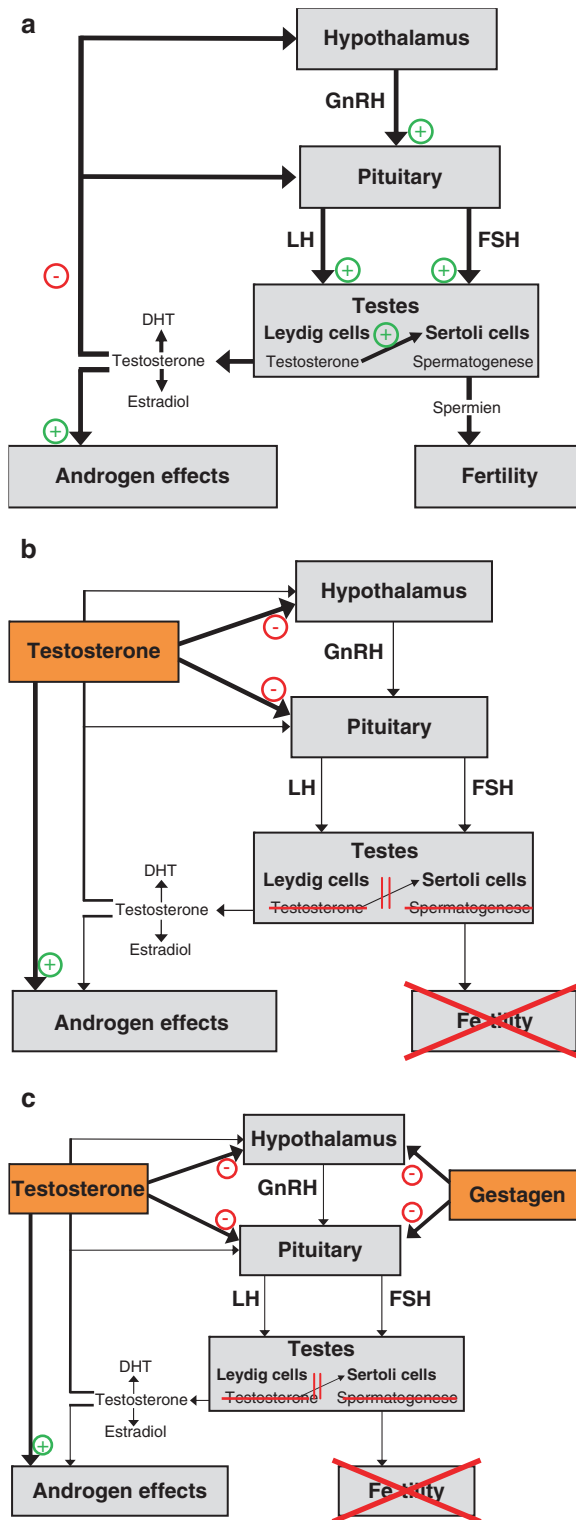

Fig. 29.1 Schematic representation of the endocrine mechanism controlling testicular function (Figure a). Figure b shows the principle of hormonal contraception using testosterone; figure c shows the principle of hormonal contraception using testosterone plus gestagens

At first sight testosterone itself would be the steroid of choice as it suppresses the gonadotropins and maintains androgenicity simultaneously. However, studies showed that by administration of testosterone alone azoospermia could only be achieved in two-thirds of Caucasian men, so that another gonadotropin-suppressing agent must be added to interrupt spermatogenesis as completely as possible. GnRH analogues and several different steroid combinations and delivery systems such as oral, transdermal, subcutaneous and intramuscular have been examined. Each has its respective merits and drawbacks (Fig. 29.2).

This chapter provides a broad overview of the various hormonal approaches to male contraception. For further details recent reviews (e.g., Kamischke and Nieschlag 2004; Wenk and Nieschlag 2006; Page et al. 2008) and the individual studies should be consulted.

29.2 Androgens Alone

29.2.1 Testosterone Enanthate

Soon after testosterone was synthesized and became available for clinical use in the late 1930s, its spermatogenesis-suppressing effect was recognized (Heckel 1939), but not until the 1970s did investigations start to exploit this phenomenon for male contraception. As in most hormonal male contraceptive studies to date, in the early studies sperm concentrations and counts were used as surrogate parameters for efficacy.

The **first efficacy study** of testosterone-based hormonal male contraception was sponsored by the WHO (1990) and included ten centers on four continents. Healthy fertile participants were given 200mg of the longer-acting testosterone enanthate weekly by intramuscular injection. One hundred and fifty-seven men (70%) reached azoospermia after 6 months of treatment and entered the efficacy phase for a further year, during which no other contraceptive was used by the couple. Only one pregnancy was reported in this first proof-of-principle study. Although the efficacy of this study was very high, it cannot be used to determine the overall efficacy of testosterone alone as a contraceptive because only men who became azoospermic could enter the efficacy phase while the others were excluded.

In order to clarify the question whether men developing oligozoospermia can be considered infertile, a

Fig. 29.2 Contraceptive efficacy of testosterone enanthate (250 mg weekly) in 364 volunteers: pregnancy rates per 100 person-years in relation to sperm concentration (WHO 1996)

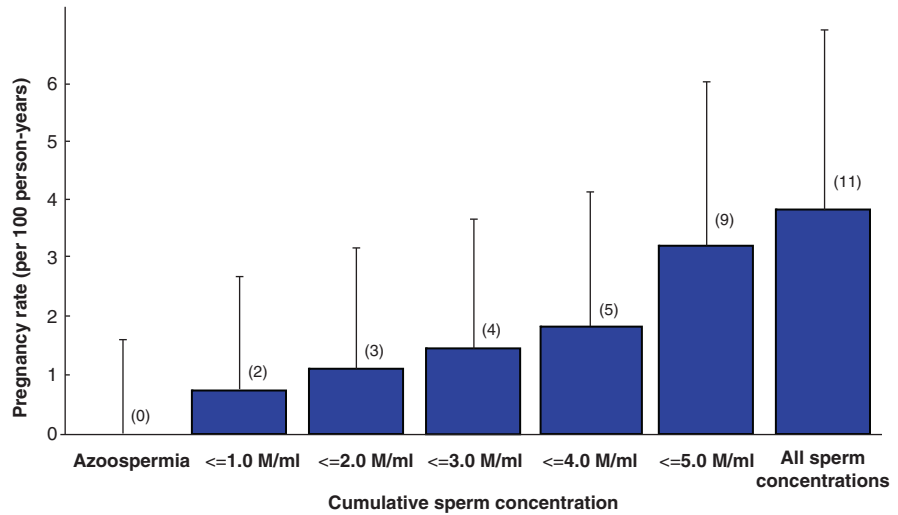

second worldwide multicenter efficacy study involving 357 couples followed (WHO 1996). In this study azoospermia again proved to be a most effective prerequisite for contraception. If sperm concentration, however, failed to drop below 3 million/ml ejaculate, resulting pregnancy rates were higher than when using condoms. When sperm concentrations decreased below 3 million/ml, which was the case in 98% of the participants, then protection was not as effective as for azoospermic men, but was better than that offered by condoms (Fig. 29.3).

Even if these WHO studies represented a breakthrough by confirming a principle of action, they did not offer a practicable method. For a method requiring weekly i.m. injections is not acceptable for broad use. Moreover, several months, often up to 1 year, are required before sperm production reaches significant suppression. For this reason current research is concentrating on the development of long-acting testosterone preparations and on methods to hasten the onset of effectiveness.

29.2.2 Testosterone Buciclate

As long-acting testosterone preparations appeared more promising in terms of practicability and acceptability, WHO and the NIH initiated a synthesis programme for such preparations (Waites 2003), through which the long-acting testosterone ester **testosterone buciclate** was identified. This molecule showed a half-life of 29.5 days when tested in hypogonadal men,

much longer than the 4.5 days of testosterone enanthate (Behre et al. 1995, 2004). Suppression of spermatogenesis was comparable to that of weekly testosterone enanthate injections, reaching azoospermia in three out of eight volunteers after a single injection of 1,200 mg of testosterone buciclate. Despite its promising pharmacokinetic profile, no industrial partner could be found to undertake the development of this preparation.

29.2.3 Testosterone Undecanoate

Initially **testosterone undecanoate** was studied as an **oral preparation** in volunteers of Caucasian origin (Nieschlag et al. 1978). Subjects were given a daily dose of 240 mg over a period of 12 weeks, but only one out of seven volunteers reduced sperm output sufficiently for contraception. This low effectiveness is probably due to the short half-life of testosterone undecanoate when given orally. Even if administered four times a day, the peaks are not sufficient to suppress gonadotropins consistently and thereby to achieve azoospermia.

While testosterone undecanoate had been developed as an oral preparation in Europe (see Chap. 21), it was turned into an **injection in China**, using **tea seed oil** as a vehicle and is used as such in China for hypogonadism and in trials for male contraception. Back in Europe, the half-life of this Chinese preparation could be extended even further when dissolved in **castor oil** and is now available for clinical use in 1,000 mg depot injections (see Chap. 21).

Fig. 29.3 Gestagens derived from (a) testosterone or (b) progesterone that have been used successfully in male contraceptive trials

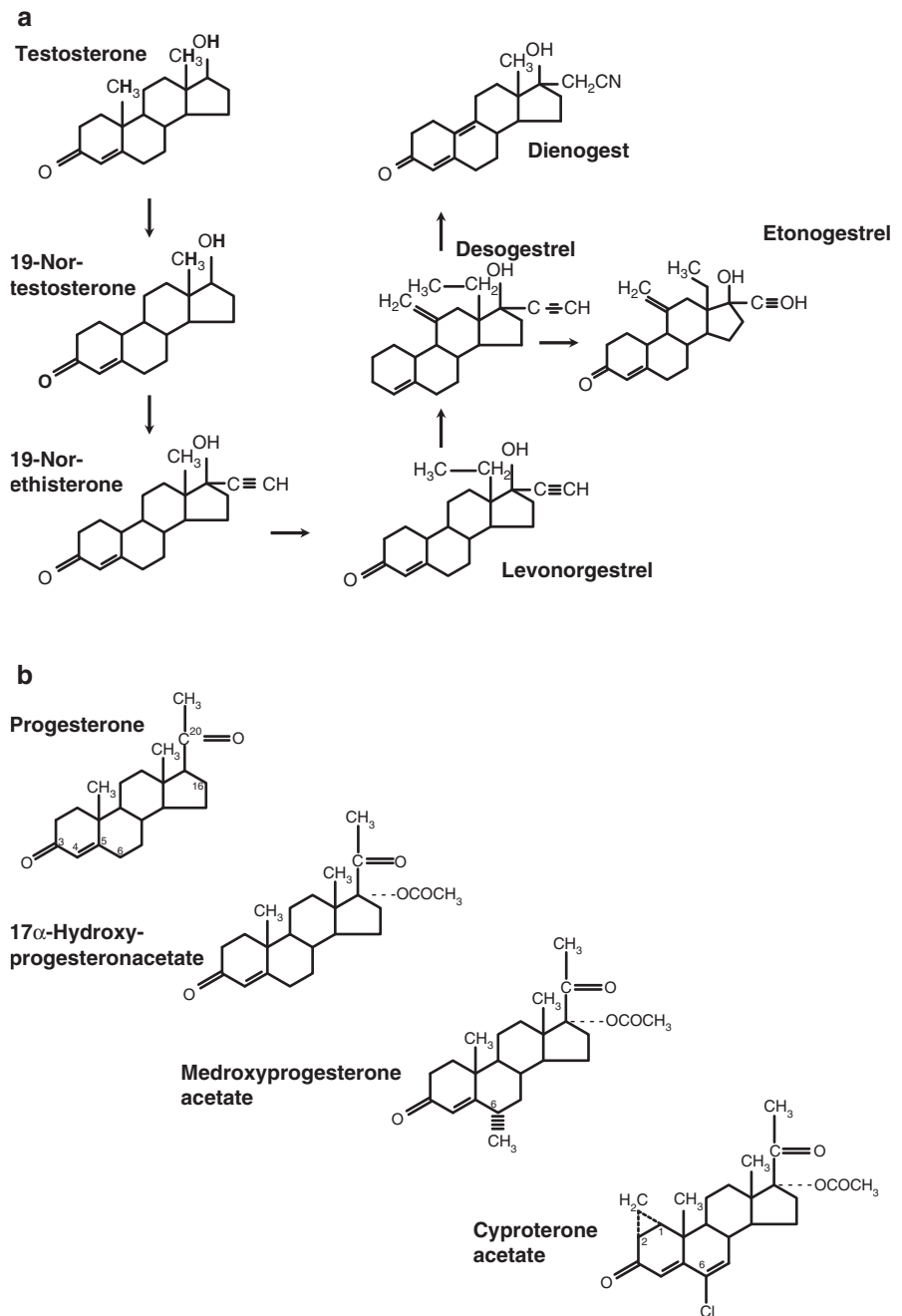

In the clinical trials in China testosterone undecanoate alone administered every 4 weeks resulted in azoospermia in all Chinese men who received a dose of 1,000 mg and in azoospermia or severe oligozoospermia in 95% of Chinese men who received a dose of 500 mg during a 4–6 month suppression phase (Zhang et al. 1999). In the ensuing **Phase III study** involving 305 couples an efficacy phase followed the

suppression phase and no pregnancies were caused by men exhibiting azoospermia or severe oligozoospermia (Gu et al. 2009). However, reappearance of sperm occurred in six men during the efficacy phase; one pregnancy was attributed to “sperm rebound.” Side-effects observed in subjects were all typical of elevated testosterone serum levels. The largest efficacy study to date was also performed in China, based on monthly

injections of 500 mg testosterone undecanoate. Eight hundred and fifty five men entered the efficacy phase during which only nine pregnancies were recorded. This represents a pregnancy rate of 1.1/100 person years (Gu et al. 2009). **Thus, in China testosterone undecanoate provides better protection against pregnancy than condom use.**

In a first contraceptive trial of testosterone undecanoate in castor oil 1,000 mg were injected into 14 Caucasian volunteers at 6-week intervals. 8/14 men achieved azoospermia (Kamischke et al. 2000a). Although this rate of azoospermia is not different from that achieved with testosterone enanthate alone, the three-fold longer injection interval represents a significant advantage. A later pharmacokinetic study concluded that 8-week intervals of 1,000 mg injections would be sufficient for contraceptive purposes (Qoubaitary et al. 2006).

Considering that ten to 14-week intervals of 1,000 mg testosterone undecanoate are required for substitution of hypogonadal men, about 1/3 more testosterone is required for contraception in normal volunteers.

29.2.4 Testosterone Pellets

Pellets consisting of pure testosterone are used for substitution in hypogonadism in some countries (see Chap. 21). In male contraceptive studies the sperm-suppressing effect was comparable to weekly testosterone enanthate injections (McLachlan et al. 2000). The disadvantage of minor surgery required for insertion under the abdominal skin is compensated for by their low price. Spontaneous extrusion may be a disadvantage.

29.2.5 19-Nortestosterone

When searching for preparations with longer lasting effectiveness **19-nortestosterone-hexoxyphenylpropionate** was tested whose spectrum of effects is very similar to that of testosterone and which had been used as an anabolic steroid since the 1960s. The 19-nortestosterone ester injected every 3 weeks enabled azoospermia to be reached by as many men as by testosterone enanthate. Thus the 19-nortestosterone ester is as effective as testosterone enanthate but allows a longer interval (Knuth et al. 1985).

Although effective in suppressing spermatogenesis and without any notable side-effects in the studies, it could not be determined whether this synthetic androgen would have any unwanted effects under long-term use. The lack of negative reports from widespread use of 19-nortestosterone in athletics cannot be taken as evidence for its clinical application as systematic evaluations in athletes have not been published.

29.2.6 7 α -Methyl-19-Nortestosterone (MENT)

The synthetic androgen 7 α -methyl-19-nortestosterone (MENT) offers an approximately ten-fold higher potency to suppress pituitary gonadotropins than does testosterone. In contrast to testosterone there is no 5 α -reduction so that effects on the prostate could be minimal. A first dose-finding study showed that MENT administered in subcutaneous implants was as effective as testosterone given alone (von Eckardstein et al. 2003). The potential of these implants either alone or in combination with gestagen implants is currently being investigated by the Population Council.

29.3 Androgens Combined with GnRH Analogues

29.3.1 GnRH Agonists

The pituitary-inhibiting effects of **GnRH agonists** are well known from their use in females and in the therapy of prostate cancer. After an initial phase of gonadotropin stimulation they suppress gonadotropins and, consequentially, intratesticular testosterone by GnRH receptor down regulation. However, trials for hormonal male contraception in which mostly testosterone was added showed that sperm numbers were only insufficiently reduced, thus rendering these agonists unsuitable as male contraceptives (Nieschlag et al. 2004).

29.3.2 GnRH Antagonists

GnRH antagonists lack the effect of initial gonadotropin release as they competitively inhibit pituitary

GnRH receptors, thus leading to a more immediate onset of azoospermia. This could be demonstrated by small clinical studies using various GnRH antagonists in addition to a testosterone preparation (summarized in Nieschlag et al. 2004). Out of 47 volunteers participating in various clinical trials with different GnRH-antagonists, azoospermia was achieved in 39 subjects and oligozoospermia <1 million sperm per ml ejaculate occurred in one further volunteer, while only three men maintained sperm concentrations above 3 million per ml ejaculate. Of the more recently developed GnRH antagonists Acycline has been tested in male contraceptive trials. Although Acycline given alone had a potent gonadotropin-suppressing effect (Page et al. 2008), the addition of Acycline to a combination of testosterone gel plus DMPA did not increase the suppression of sperm achieved by the steroids alone (Page et al. 2006).

Despite these encouraging results, the requirement for daily or weekly injections and the high costs of the available preparations have hindered the further development of GnRH antagonists for hormonal male contraception. Promising attempts to use the GnRH antagonists only to initiate azoospermia and then maintain this by androgens alone were not pursued further (Swerdloff et al. 1998; Behre et al. 2001).

29.4 Androgens Plus Gestagens

The potency of gestagens to suppress gonadotropins is well known from female contraceptives where gestagens effectively supplement estrogens. Numerous studies combining androgens (mainly testosterone) with various gestagens have been performed over the past 4 decades in order to identify a regimen suited for male contraception (Fig. 29.4). Unfortunately, a systematic comparison of the different gestagens with regard to their contraceptive potency in males has never been performed. Even worse, a Cochrane Review analyzing 45 clinical trials came to the conclusion that the studies comprised too small numbers of volunteers so that significant differences between the various steroid combinations could not be detected (Grimes et al. 2007). Not all studies followed strict criteria for randomized controlled trials. However, it should be kept in mind that single centers are financially and logistically unable to cope with the numbers of volunteers and criteria demanded by regulatory agencies. Stimulated by researchers and by public demand, the pharmaceutical industry finally performed a trial fulfilling the Cochrane criteria – and left the field! (Mommers et al. 2008). In the following, important studies are briefly summarized

Fig. 29.4 Most promising testosterone/progestin combinations currently tested in clinical trials. (MENT, 7α-methyl-19-nortestosterone; DMPA, depot-medroxyprogesterone acetate; NETE, norethisterone enanthate; NETA, norethisterone acetate; ETN, etonogestrel; DSG, desogestrel; LNG, levonorgestrel)

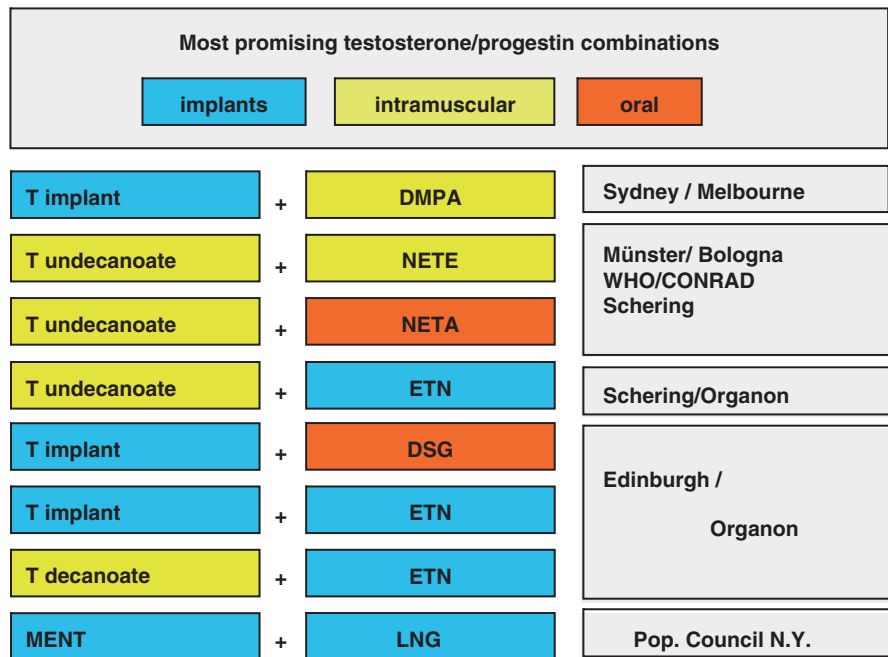

to highlight the cumbersome and often frustrating development.

The gestagens used in these studies derive either from **19-nortestosterone** or from **17-hydroxyprogesterone** and are all being used in female contraceptives (Fig. 29.3).

29.4.1 Depot Medroxyprogesterone Acetate (DMPA)

From early studies in the 1970s initiated by the WHO and the Population Council, DMPA emerged as a gestagen with great potential in male contraception (Barfield et al. 1979). The combination of DMPA with 19-nortestosterone in 3-week intervals first tested in Caucasians (Knuth et al. 1989) was especially promising in Indonesian men (WHO 1993).

One of the very few efficacy studies aiming at pregnancy rates also used DMPA, however, in combination with testosterone pellets (Turner et al. 2003). In this Australian study, 53/55 volunteers suppressed to azoospermia and during the 1-year efficacy phase no pregnancy occurred. However, the discontinuation rate in this study was high and onset of and recovery from azoospermia took several months.

In order to test whether one of the two steroid entities could be self-administered, the addition of a testosterone transdermal gel to the DMPA injections (300 mg/3 months) was tested (Page et al. 2006). The results were comparable to those from trials where DMPA was combined with injectable testosterone.

29.4.2 Levonorgestrel

Oral levonorgestrel, when combined with testosterone enanthate i.m. slightly enhanced the effect of testosterone enanthate alone (Bebb et al. 1996). Similarly, when combined with testosterone undecanoate i.m. the additional effect of oral levonorgestrel remained marginal in Caucasian men (Kamischke et al. 2000b), but seemed to increase effectiveness in Chinese men (Wang et al. 2007).

In a comparative study, when **levonorgestrel implants** were combined with testosterone pellets, an

additive effect of levonorgestrel was seen in Caucasian men, but not in Chinese men who responded equally well to testosterone pellets alone (Wang et al. 2005).

When MENT implants were combined with levonorgestrel implants in different doses, a clear dose-dependent effect could be observed, but it remains undetermined whether implants with sufficiently long duration can be manufactured; non-biodegradable implants that have to be removed surgically from the implantation site when contraceptive protection is no longer required appear impractical for widespread use unless they can be left *in situ* for long periods (Wang et al. in preparation).

29.4.3 Norethisterone

The injectable depot preparation **norethisterone enanthate (NETE)** and the orally effective **norethisterone acetate (NETA)** are hydrolysed to release the active compound **norethisterone**, which can be 5 α -reduced to 5 α -norethisterone and aromatized to ethinyl estradiol. While norethisterone has strong androgenic activity (~10% of testosterone), 5 α -norethisterone also shows anti-androgenic properties.

13/14 men who received 200 mg NETE combined with 1,000 mg testosterone undecanoate every 6 weeks achieved azoospermia (Kamischke et al. 2001). Further investigations showed that the injection intervals could be extended to 8 weeks (Meriggiola et al. 2005) or that testosterone undecanoate could be combined with oral NETA without loss of effectiveness (Kamischke et al. 2002). Based on these findings, together with CONRAD WHO is planning a Phase II efficacy study involving 400 couples in eight centers worldwide (WHO 2005).

29.4.4 Cyproterone Acetate

The orally effective **antiandrogen cyproterone acetate (CPA)** has strong gestagenic properties. In early studies combining oral CPA with testosterone enanthate injections, the sperm-suppressing effects were considerable, but the antiandrogenic effects (e.g., reflected by decreased hematocrit) were undesirable. However, when combining 1,000 mg testosterone undecanoate every 6

Fig. 29.5 Percentage of 333 men with sperm concentrations below or equal to different cutoff values, participating in a double-blind, randomized, placebo-controlled multicentre trial using various combinations of etonogestrel implants and testosterone undecanoate injections (from Mommers et al. 2008)

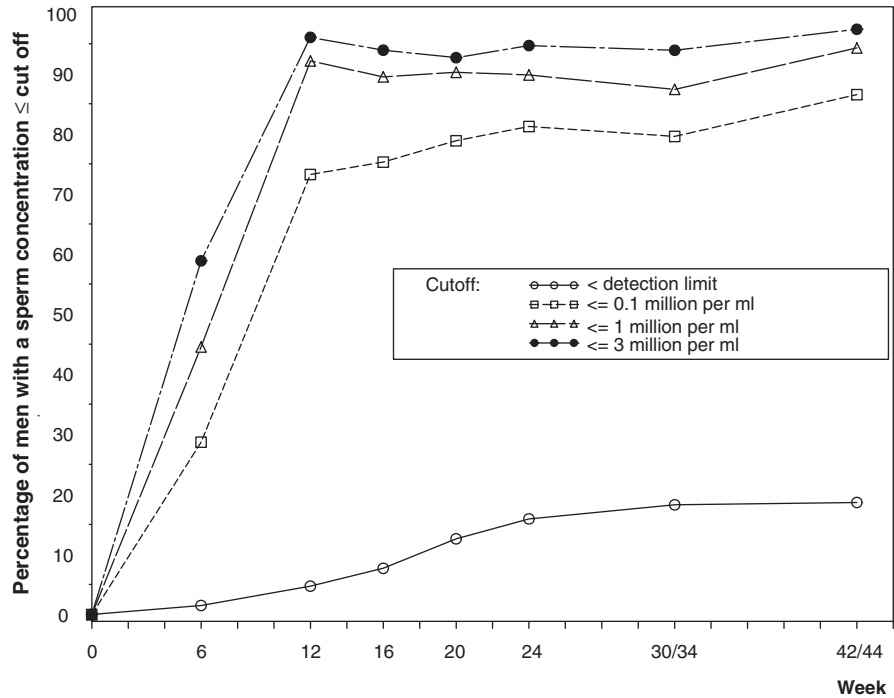

weeks with 20 mg CPA daily initially, followed by only 2 mg CPA/day the initial suppression of spermatogenesis could be maintained and antiandrogenic effects prevented (Merigiola et al. 2003).

29.4.5 Desogestrel and Etonogestrel

Desogestrel is an orally effective gestagen which becomes active after conversion to **etonogestrel**. Etonogestrel can be administered directly as an implant (Implanon®). In combination with testosterone enanthate or testosterone pellets desogestrel showed good suppression of spermatogenesis (Wu et al. 1999; Kinniburgh et al. 2001).

Etonogestrel implants combined with testosterone pellets s.c. resulted in a high azoospermia rate, although it took up to 28 weeks to reach this goal in individuals (Brady et al. 2004).

In the first (and so far last) **industry-sponsored trial**, Organon and Schering decided to test etonogestrel implants with testosterone undecanoate injections in various combinations (Mommers et al. 2008). This study involved 354 volunteers in seven treatment groups receiving either placebo or 750–1,000 mg

testosterone undecanoate every 10–12 weeks with two doses of etonogestrel for 42–44 weeks. 90% of treated men suppressed spermatogenesis ≤ 1 million/ml ejaculate (Fig. 29.5). Although the combination of an implant with injections may not appear too attractive for practical use, the study showed a high success rate and could have formed the basis for a Phase III efficacy study. Unfortunately, both companies discontinued their male contraception programs when they were taken over by other firms.

29.5 Résumé and Outlook

A multitude of smaller and larger studies using testosterone in combination with gestagens or GnRH antagonists has demonstrated the principle of hormonal male contraception. Beyond the **proof of principle, five efficacy studies** (WHO 1990 and 1996; Gu et al. 2003, 2009; Turner et al. 2003) resulted in pregnancy rates below the rates of condoms (when properly used) and close to that of female oral contraceptives. Yet no definite steroid combination could be established and the search for a marketable steroid combination and application form must continue, a target that would be a

genuine task for the pharmaceutical industry which, unfortunately, left the field prematurely.

In view of the many single studies varying in scope it is puzzling that no greater coordination of efforts and resources ever emerged. The latter became all too evident when WHO terminated the **Task Force for the Regulation of Male Fertility in 1996** and thereby surrendered the leadership role it had maintained for almost 3 decades.

Recognizing this vacuum, investigators initiated the **Annual Summit Meetings of Male Contraception** in 1997, a private forum for the exchange of ideas and results. From this forum two important analyses of previous studies emerged. In the first, an integrated multivariate time-to-event analysis of 1549 participants in 30 studies published from 1990–2005 was compiled and showed that all the various hormonal male contraceptive regimens resulted in **full reversibility of suppression of spermatogenesis** (Liu et al. 2006). A second analysis of the same studies showed that the **rate of suppression of spermatogenesis** was enhanced by the addition of gestagens to testosterone and that East Asian and younger men suppressed better than Caucasian and older men, respectively (Liu et al. 2008).

Encouraged by these results, the participants of the Summit Meetings envisioned an efficacious and marketable product that could be licensed by the regulatory authorities and drafted recommendations for studies and prerequisites leading to such a product (Nieschlag and 10th Summit Meeting Group 2007). Active participation by the pharmaceutical industry in the search for a hormonal male contraceptive (Mommers et al. 2008) reinforced this view. This first placebo-controlled study also showed that side-effects of a testosterone-gestagen regimen were tolerable and consisted mainly of moderate weight gain caused by the anabolic effects of testosterone, which could probably be mitigated by dose-reduction.

In the light of these overall positive findings and anticipated good acceptance of a male contraceptive by the consumer (Heinemann et al. 2005), the sudden withdrawal by industry from the field came as a surprise. Reasons for this withdrawal may be manifold, but financial considerations of public companies may be prevailing. Basically, the components of a hormonal male contraceptive would be relatively cheap and competitive with female methods, but are currently sold at high prices. For example, one injection of testosterone undecanoate costs almost 140 in a German pharmacy; four

injections per year required for the substitution of a hypogonadal man cost as much as 560. At that price the ± 7 injections required per year for male contraception would cost 980 and costs for the gestagens need to be added. In order to compete with female contraceptives, the annual price of which is less than 100, the price for testosterone undecanoate would have to be drastically reduced and industry would destroy the lucrative market for hypogonadism (and other applications). Under these circumstances, only hope remains that a governmental or philanthropic organization would undertake the final steps needed for development of a usable product which would allow a reasonable price for the end-product.

References

- Barfield A, Melo J, Coutinho E, Alvarez-Sanchez F, Faundes A, Brache V, Leon P, Frick J, Bartsch G, Weiske WH, Brenner P, Mishell D Jr, Bernstein G, Ortiz A (1979) Pregnancies associated with sperm concentrations below 10 million/ml in clinical studies of a potential male contraceptive method, monthly depot medroxyprogesterone acetate and testosterone esters. *Contraception* 20:121–127
- Bebb RA, Anawalt BD, Christensen RB, Paulsen CA, Bremner WJ, Matsumoto AM (1996) Combined administration of levonorgestrel and testosterone induces more rapid and effective suppression of spermatogenesis than testosterone alone: A promising male contraceptive approach. *J Clin Endocrinol Metab* 81:757–762
- Behre HM, Kliesch S, Keck C, Simoni M, Nieschlag E (1995) Potential of testosterone buccinate for male contraception: Endocrine differences between responders and nonresponders. *J Clin Endocrinol Metab* 80:2394–2403
- Behre HM, Kliesch S, Lemcke B, von Eckardstein S, Nieschlag E (2001) Suppression of spermatogenesis to azoospermia by combined administration of GnRH antagonist and 19-nortestosterone cannot be maintained by this non-aromatizable androgen alone. *Hum Reprod* 16:2570–2577
- Behre HM, Wang C, Handelsman DJ, Nieschlag E (2004) Pharmacology of testosterone preparations. In: Nieschlag E, Behre HM (eds) *Testosterone: Action, Deficiency, Substitution*, 3rd edn. Cambridge University Press, Cambridge, pp 405–444
- Brady BM, Walton M, Hollow N, Kicman AT, Baird DT, Anderson RA (2004) Depot testosterone with etonogestrel implants result in induction of azoospermia in all men for long-term contraception. *Hum Reprod* 19:2658–2667
- Grimes DA, Lopez LM, Gallo MF, Halpern V, Nanda K, Schulz KF (2007) Steroid hormones for contraception in men (review). *Cochrane Database Syst Rec* 004316
- Gu YQ, Wang XH, Xu D, Peng L, Cheng LF, Huang MK, Huang ZJ, Zhang GY (2003) A multicenter contraceptive efficacy study of injectable testosterone undecanoate in healthy Chinese men. *J Clin Endocrinol Metab* 88:562–568

- Gu Y, Liang X, Wu W, Liu M, Song S, Cheng L, Bo L, Xiong Ch, Wang X, Liu X, Peng L, Yao K (2009) Multicenter contraceptive efficacy trial of injectable testosterone undecanoate in healthy Chinese men. *J Clin Endocrinol Metab* 94:1910–1915
- Heckel M (1939) Production of oligospermia in a man by the use of testosterone propionate. *Proc Soc Exp Biol Med* 40: 658–659
- Heinemann K, Saad F, Wiesemes M, White S, Heinemann L (2005) Attitudes toward male fertility control: Results of a multinational survey on four continents. *Hum Reprod* 20: 549–556
- Kamischke A, Nieschlag E (2004) Progress towards hormonal male contraception. *TRENDS in Pharmacological Sciences* 25:49–57
- Kamischke A, Diebacker J, Nieschlag E. (2000a) Potential of norethisterone enanthate for male contraception: Pharmacokinetics and suppression of pituitary and gonadal function. *Clin Endocrinol* 53:351–358
- Kamischke A, Plöger D, Venherm S, von Eckardstein S, von Eckardstein A, Nieschlag E (2000b) Intramuscular testosterone undecanoate with or without oral levonorgestrel: A randomized placebo-controlled feasibility study for male contraception. *Clin Endocrinol* 53:43–52
- Kamischke A, Venherm S, Plöger D, von Eckardstein S, Nieschlag E (2001) Intramuscular testosterone undecanoate and norethisterone enanthate in a clinical trial for male contraception. *J Clin Endocrinol Metab* 86:303–309
- Kamischke A, Heuermann T, Krüger K, von Eckardstein S, Schellschmidt I, Rübiger A, Nieschlag E (2002) An effective hormonal male contraceptive using testosterone undecanoate with oral or injectable norethisterone preparations. *J Clin Endocrinol Metab* 87:530–539
- Kinniburgh D, Anderson RA, Baird DT (2001) Suppression of spermatogenesis with desogestrel and testosterone pellets is not enhanced by addition of finasteride. *J Androl* 22: 88–95
- Knuth UA, Behre HM, Belkien L, Bents H, Nieschlag E (1985) Clinical trial of 19-nortestosterone-hexyloxyphenylpropionate (Anadur) for male fertility regulation. *Fertil Steril* 44:814
- Knuth UA, Yeung CH, Nieschlag E (1989) Combination of 19-nortestosterone-hexyloxyphenylpropionate (Anadur) and depot-medroxyprogesterone-acetate (Clinovir) for male contraception. *Fertil Steril* 51:1011
- Liu PY, Swerdloff RS, Christenson PD, Handelsman DJ, Wang C, Hormonal Male Contraception Summit Group (2006) Rate, extent, and modifiers of spermatogenic recovery after hormonal male contraception: An integrated analysis. *Lancet* 367:1412–1420
- Liu PY, Swerdloff RS, Anawalt BD, Anderson RA, Bremner WJ, Elliesen J, Gu YQ, Kersemaekers WM, McLachlan, RI, Meriggiola MC, Nieschlag E, Sitruk-Ware R, Vogelsong K, Wang XH, Wu FC, Zitzmann M, Handelsman DJ, Wang C (2008) Determinants of the rate and extent of spermatogenic suppression during hormonal male contraception: An integrated analysis. *J Clin Endocrinol Metab* 93:1774–1783
- McLachlan RI, McDonald J, Rushford D, Robertson DM, Garrett C, Baker HW (2000) Efficacy and acceptability of testosterone implants, alone or in combination with a 5 α -reductase inhibitor, for male hormonal contraception. *Contraception* 62:73–78
- Meriggiola MC, Costantino A, Cerpolini S, Bremner WJ, Huebler D, Morselli-Labate AM, Kirsch B, Bertaccini A, Pelusi C, Pelusi G (2003) Testosterone undecanoate maintains spermatogenic suppression induced by cyproterone acetate plus testosterone undecanoate in normal men. *J Clin Endocrinol Metab* 88:5818–5826
- Meriggiola MC, Costantino, SF, D’Emidio L, Morselli Labate AM, Bertaccini A, Bremner WJ, Rudolph I, Ernst M, Kirsch B, Martorana G, Pelusi G (2005) Norethisterone enanthate plus testosterone undecanoate for male contraception: Effects of various injection intervals on spermatogenesis, reproductive hormones, testis, and prostate. *J Clin Endocrinol Metab* 90:2005–2014
- Mommers E, Kersemaeker WM, Elliesen J, Kepers M, Apter D, Behre HM, Beynon J, Bouloux PM, Costantino A, Gerbershagen HP, Gronlund L, Heger-Mahn D, Huhtaniemi I, Koldewijn EL, Lange C, Lindenberg S, Meriggiola MC, Meuleman E, Mulder PFA, Nieschlag E, Perheentupa A, Solomon A, Väisälä L, W FC, Zitzmann M (2008) Male hormonal contraception: A double-blind, placebo-controlled study. *J Clin Endocrinol Metab* 93:2572–2580
- Nieschlag E, 10th Summit Meeting Group (2007) 10th Summit Meeting on consensus: Recommendations for regulatory approval for hormonal male contraception. *Contraception* 75:166–167, 22–23 October 2006
- Nieschlag E, Hoogen H, Bölk M, Schuster H, Wickings EJ (1978) Clinical trial with testosterone undecanoate for male fertility control. *Contraception* 18:607
- Nieschlag E, Kamischke A, Behre HM (2004) Hormonal male contraception: The essential role of testosterone. In: Nieschlag E, Behre HM (eds) *Testosterone: Action, Deficiency, Substitution*, 3rd edn. Cambridge University Press, Cambridge, pp 685–714
- Page ST, Amory JK, Anawalt BD, Irwig MS, Brockenbrough AT, Matsumoto AM, Bremner WJ (2006) Testosterone gel combined with depomedroxyprogesterone acetate is an effective male hormonal contraceptive regimen and is not enhanced by the addition of a GnRH antagonist. *J Clin Endocrinol Metab* 91:4374–4380
- Page ST, Amory JK, Bremner WJ (2008) Advances in male contraception. *Endocr Rev* 29:465–493
- Qoubaitary A, Meriggiola C, Ng CM, Lumbreras L, Cerpolini S, Pelusi G, Christensen PD, Hull L, Swerdloff RS, Wang C (2006) Pharmacokinetics of testosterone undecanoate injected alone or in combination with norethisterone enanthate in healthy men. *J Androl* 27:853–867
- Swerdloff RS, Bagatell CJ, Wang C, Anawalt BD, Berman N, Steiner B, Bremner WJ (1998) Suppression of spermatogenesis in man induced by Nal-Glu gonadotropin releasing hormone antagonist and testosterone enanthate (TE) is maintained by TE alone. *J Clin Endocrinol Metab* 83: 3527–3533
- Turner L, Conway AJ, Jimenez M, Liu PY, Forbes E, McLachlan RI, Handelsman DJ (2003) Contraceptive efficacy of a depot progestin and androgen combination in men. *J Clin Endocrinol Metab* 88:4659–4667
- von Eckardstein S, Noe G, Brache V, Nieschlag E, Croxatto H, Alvarez F, Moo-Young A, Sivin I, Kumar N, Small M, Sundaram K, International Committee for Contraception Research, The Population Council (2003) A clinical trial of 7 α -methyl-19-nortestosterone implants for possible use as a long-acting contraceptive form en. *J Clin Endocrinol Metab* 88:5232–5239
- Waites GMH (2003) Development of methods of male contraception: Impact of the World Health Organization Task Force. *Fertil Steril* 80:1–15

- Wang C, Wang XH, Nelson AL (2005) Levonorgestrel implants enhanced the suppression of spermatogenesis by testosterone implants: Comparison between Chinese and non-Chinese men. *J Clin Endocrinol Metab* 91:460–470
- Wang C, Cui YG, Wang XH, Jia Y, Hikim AS, Lue YH, Tong JS, Qian LX, Sha JH, Zhou ZM, Hull L, Leung A, Swerdloff RS (2007) Transient scrotal hyperthermia and levonorgestrel enhance testosterone-induced spermatogenesis suppression in men through increased germ cell apoptosis. *J Clin Endocrinol Metab* 92:3292–3304
- Wenk M, Nieschlag E (2006) Male contraception: a realistic option? *European Journal of Contraception and Reproductive Health* 11:69–80
- WHO Task Force on Methods for the Regulation of Male Fertility (1990) Contraceptive efficacy of testosterone-induced azoospermia in normal men. *Lancet* 336:955–959
- WHO Task Force on Methods for the Regulation of Male Fertility (1993) Comparison of two androgens plus depot-medroxyprogesterone acetate for suppression to azoospermia in Indonesian men. *Fertil Steril* 60:1062
- WHO Task Force on Methods for the Regulation of Male Fertility (1996) Contraceptive efficacy of testosterone-induced azoospermia and oligozoospermia in normal men. *Fertil Steril* 65:821–829
- WHO (2005) Controlled trials register NET-EN plus TU as a male contraceptive (WHO-HRP ID A25165) (accessed 2005-11-29). <http://www.who.int/reproductive-health/rhl/a25165.html>
- Wu FC, Balasubramanian R, Mulders TM, Coeling-Benning HJ (1999) Oral progestogen combined with testosterone as a potential male contraceptive: additive effects between desogestrel and testosterone enanthate in suppression of spermatogenesis, pituitary-testicular axis, and lipid metabolism. *J Clin Endocrinol Metab* 84:112–122
- Zhang GY, Gu YQ, Wang XH, Cui YG, Bremner WJ (1999) A clinical trial of injectable testosterone undecanoate as a potential male contraceptive in normal Chinese men. *J Clin Endocrinol Metab* 84:3642–3647

Contents

30.1	Introduction	589
30.2	Attacking Sperm Production in the Testis	590
30.2.1	Chemically Blocking Spermato-genesis	590
30.2.2	Physically Blocking Spermato-genesis	590
30.3	Preventing Sperm Maturation and Survival in the Epididymis	591
30.3.1	Altering the Epididymal Transport of Spermatozoa	591
30.3.2	Modifying the Composition of Epididymal Fluid	592
30.3.3	Attacking Epididymal Spermatozoa	594
30.4	Preventing Seminal Emission	595
30.4.1	Surgical Approaches	595
30.4.2	Pharmacological Blockade of Seminal Emission	596
30.5	Sperm-Specific Targets	596
30.6	Overall Conclusion	596
	References	597

30.1 Introduction

Alternatives to suppressing spermatogenesis by exogenous hormones for male contraception (see Chap. 29) include chemical approaches to destroy pituitary gonatotrophes, immunological targeting of the hypothalamic GnRH, physically damaging the testis by local heating and ultrasound application or administering toxicants that compromise Sertoli cell or germ cell function (Page et al. 2008). They all lead to the same end result of azoospermia and, as for hormonal contraception, these approaches take months for sperm numbers to be reduced sufficiently for effective contraception. Mechanically blocking seminal emission pathways, such as vasectomy (see Chap. 28), also aim to induce azoospermia but without loss of androgenic status and are quicker in onset.

Between halting the production of spermatozoa in the testis and preventing them from leaving the body through the vas deferens, lies an alternative approach, that of producing non-functional spermatozoa (“functional sterility”). This is being pursued by both chemical and immunological interference with epididymal epithelial cells and spermatozoa within the epididymis with the aim of discovering druggable targets (enzymes, receptors, channels). Some of these aim to mimic the natural infertility stemming from epididymal dysfunction observed in several domestic species and some transgenic mice (see Cooper and Barfield 2006). The advantage of a post-testicular, epididymal, contraceptive lies in the rapid onset of infertility and the fast return to fertility once therapy is withdrawn. This is because they target already formed spermatozoa in the epididymis; the short transit time (less than 1 week in man) means that freshly produced testicular spermatozoa, unaffected by the contraceptive, would rapidly

T. G. Cooper (✉)
Centre of Reproductive Medicine and Andrology
of the University, Domagkstrasse 11, D-48129 Münster, Germany
e-mail:Cooper@uni-muenster.de

replace the non-fertilizing population. It could be used together with a hormonal contraceptive to initiate rapid contraception before the onset of azoospermia.

30.2 Attacking Sperm Production in the Testis

30.2.1 Chemically Blocking Spermatogenesis

A wide range of chemicals is able to upset spermatogenesis and current knowledge can locate their site of attack on specific cell types (Sertoli or germ cells or their regions of contact). The following list is not exhaustive (Mruk 2007), but the major classes of spermatotoxic compounds in animals include:

- Alkylating agents, e.g., busulphan, now used routinely to deplete the spermatogenetic epithelium for stem cell transplantation studies
- Imidazole derivatives, e.g., metronidazole (1-(2-chloroethyl)-2-methyl-5-nitro-imidazole)
- Alkylated iminosugars, e.g., miglustat (N-butyldeoxyjirimycin), but not unalkylated iminosugars, that inhibit glucosylceramide synthesis in mice, but are not contraceptive in rabbits or men
- Indenopyridines, developed as antihistamines, e.g., CDB-4022 (Mruk 2007) that cause detachment of germ cells (except spermatogonia) from Sertoli cells and have deleterious effects on the blood-testis barrier in rats, with less effect on monkeys
- Indazole-carboxylic acid derivatives, e.g., adjudin, that interferes with adhesion of the Sertoli cell with most spermatids, few spermatocytes and no spermatogonia (but causes liver inflammation in male rats) and gamendazole, active at lower doses than adjudin
- Many compounds of plant origin, e.g., papaya seed extracts (*Carica papaya*), neem leaf, bark or seed extracts (*Azadirachta indica*), myrtle tree flower extracts (*Eugenia jambolana*). Most information is known about the polyphenolic binaphthyl dialdehyde gossypol, from cotton plant seeds (*Malvaceae*) and the multiglycoside extracts of *Tripterygium wilfordii* and *hypoglaucom* whose active ingredient triptolide is a diterpenoid triepoxide that acts on the immune system. They have either been shown to be toxic or ineffective as antifertility agents

- Retinoic acid receptor antagonists. These are currently being tested as retinoic acid receptor- α knockout mice are infertile

30.2.1.1 Targeting Drug Accumulation Within the Testis

Species' differences in action reflect a drug's metabolism and excretion and its access to the targeted cells. A drug in the circulation passing through the capillaries in the testicular interstitium only has access to the spermatogonia, outside the blood-testis barrier. For drugs affecting post-meiotic cells, passage through the blood-testis barrier is necessary. Adjudin coupled to an inactive, mutated FSH molecule that binds to the FSH-receptor can be targeted to Sertoli cells and far lower doses of drug ($\mu\text{g}/\text{kg}$ v. mg/kg) are required for anti-spermatogenic activity (Wong et al. 2007).

30.2.1.2 Clinical Observations

Initiated by Chinese observations during the 1980s, comprehensive clinical studies on the contraceptive effectiveness of gossypol were carried out under the auspices of the WHO. Because of unsurmountable toxic effects on spermatogenesis, these studies have been abandoned; however, studies were continued elsewhere. In a multinational study in which gossypol acetate was administered orally at 15 mg/day for 12–16 weeks, sperm concentrations fell between 4 and 12 weeks of treatment and remained low during subsequent treatment with 7.5 mg or 10 mg per day for 40 weeks in the responders. Over the next 52 weeks sperm concentration rose to exceed $20 \times 10^6/\text{ml}$ but not to the pre-treatment values (Coutinho et al. 2000). A systematic review of attempts at non-hormonal contraception concluded that neither gossypol nor *Tripterygium* (Lopez et al. 2005) was effective or safe.

30.2.2 Physically Blocking Spermatogenesis

The position of the testes in the scrotum, a natural cooling device, has invited the use of scrotal heating as a means of male contraception. Scrotal warming can

be caused by a variety of factors that are met in the workplace and have been put forward as causes of male infertility. These include diseases (varicoele, fever), occupational exposure to excessive heat (furnace workers), continuous exposure to mild heat (sitting at desks, in vehicles, on heated seats or floors), clothing (tight-fitting underwear or trousers) and lifestyle choices (laptop computers, hot water baths, saunas, exercise). Although many of these situations lead to increased scrotal or intra-testicular temperature, for most of them, data on semen quality is lacking or interpretation is compromised by confounding factors (Jung and Schuppe 2007).

In a study in which heat was used as a supplement to hormonal contraception, in the control arm of the study, immersion of the scrotum in water held at 43°C for 30 min a day for six consecutive days led to a decrease in sperm concentration by 3 weeks, a maximum decline by 6 weeks and a return to pre-heating values by 12 weeks and associated with unchanged circulating steroid and gonadotropin concentrations (Wang et al. 2007). Increased germ cell apoptosis on testicular biopsies was noted. A decline in sperm motility was also measured but sperm concentration never fell below 3×10^6 /ml. This is a mild heat treatment and higher temperatures have led to greater declines in sperm concentration in other studies but azoospermia was never achieved, so that the method is considered inconsistent and unsafe as a contraceptive method (Jung and Schuppe 2007).

The daily wearing of close-fitting athletic supports with additional insulation for 52 weeks was effective in raising scrotal temperature 0.8–1.0°C but had no significant change in semen volume, sperm concentration, motility or vitality (Wang et al. 1997). In other studies, azoospermia was induced in some men whose testes were held in close apposition to the inguinal region, but this could not be confirmed (Jung and Schuppe 2007).

Effective non-hormonal approaches to arresting spermatogenesis in man, whether by chemical or physical means, are not far advanced.

30.3 Preventing Sperm Maturation and Survival in the Epididymis

The post-testicular maturation of sperm involves their generally slow transport through the epididymal canal (see Chap. 3) during which they take up specific

secretions that influence sperm fertilizing ability. Approaches to inducing infertility in animals can thus be categorized as those that (i) interrupt sperm transport, (ii) modify luminal fluid composition or (iii) attack spermatozoa themselves.

30.3.1 Altering the Epididymal Transport of Spermatozoa

The aim is to speed up or arrest sperm transport through the epididymis. The former should reduce the time that sperm spend in contact with epididymal secretions and lead to the ejaculation of immature, potentially non-fertilizing spermatozoa; it may also deplete the caudal sperm reserve so that suboptimal numbers of sperm are ejaculated. Arresting distal epididymal sperm transport should prevent seminal emission from the cauda epididymidis and produce temporary azoospermia.

30.3.1.1 Effective Classes of Compounds in Animal Studies

- Drugs that act on sympathetic innervation

Compounds tested in rats include *sympathomimetics*, e.g., methoxamine, that induce rapid infertility as a consequence of reduced ejaculated sperm numbers; *parasympatholytic agents*, e.g., oxyphenonium, that cause a temporary reduction in fertility owing to reduced ejaculated sperm numbers; *sympathoplegic agents*, such as α -receptor blockers e.g., phenoxybenzamine, prozasin, tamsulosin, that interfere with seminal emission, cause sperm retention in the tail of the epididymis and decrease vaginal sperm numbers post-copulation. These drugs can either decrease vaginal sperm numbers and cause infertility as a result of an ejaculation and but the effects may be incomplete when preimplantation losses are observed; *sympatholytic agents*, e.g., guanethidine, that deplete noradrenaline from local short adrenergic neurones. Guanethidine induces irreversible infertility at high doses, and rapid, but temporary, infertility at lower doses, by reducing ejaculated sperm numbers. The spermatozoa themselves, however, are viable, motile, display normal chromatin condensation and can fertilize eggs by uterine insemination (Kempinas et al. 1998a, b).

- Drugs that act on peptidergic receptors

The male tract hosts peritubular receptors for endothelin, angiotensin, oxytocin, whose presence implies an involvement of paracrine and endocrine protein factors in epididymal motion. Vasopressin, oxytocin, endothelin and angiotensin increase epididymal contractions *in vitro*, although the fertility of treated males has not been examined.

- Drugs that act on purinergic receptors

P2 α purinergic receptors are present in the epididymis (Ventura and Pennfather 1991) and a rapid and reversible impairment of fertility of male rats follows intra-epididymal administration of the P2 α -receptor desensitizing agent α,β -methylene ATP.

- Other compounds affecting epididymal sperm transport

Other agents that increase sperm transport through the epididymis of rats and mice include lowered serum testosterone, raised serum oestrogen, oxytocin, the anti-androgen hydroxyflutamide, sulphapyridine and chloroethyl-methanesulphonate. The hormonal effects are not purely epididymal, for infertility caused by oestrogens can be due to effects in the testis, and testosterone depletion/blockade can be explained by reduced androgen-dependent epididymal secretions. Chloroethyl-methanesulphonate is an effective antifertility agent in the presence of normal androgen levels but has additional effects on sperm proteins (Klinefelter and Suarez 1997) and the epididymis that may contribute to the infertility.

For drugs administered to reduce sperm transit time, failure to reduce potentially fertilizing sperm numbers below those required for fertilization may produce pre-implantation losses or retarded embryo development (Mieusset 1995; Ricker et al. 1997). For drugs intended to block seminal emission, disadvantages of persistent paralysis of the genitourinary tract include immotility and decapitation of stored spermatozoa, rupture in the distal cauda epididymidis with inflammation, antibody generation and irreversible infertility (Evans et al. 1972). These problems could be avoided by permitting intermittent sexual activity to relieve epididymal pressure, which is the aim of most post-epididymal, vasal-acting, contraceptive procedures.

30.3.2 Modifying the Composition of Epididymal Fluid

As luminal epididymal fluid is important for the maintenance of spermatozoa and specific aspects of their maturation and storage (see Chap. 3), altering its composition should have repercussions on sperm function (Gong et al. 2000). Creating a hostile luminal environment would prevent the acquisition of sperm functions or kill the spermatozoa. As fluid constituents are transported from blood, synthesized by the epithelial cells or secreted into the lumen (Cooper 1998), any agent that modifies epithelial cells, or interferes with resorption, synthesis and secretion, could be a potential contraceptive.

30.3.2.1 Compromising Epithelial Structure

In a natural murine model of primary carnitine deficiency ("juvenile visceral steatosis"), with a mutant, inactive carnitine transporter, the males are infertile (Toshimori et al. 1999). Azoospermia results from thinning of the epididymal epithelium, rupture of the proximal duct and appearance of granulomata. A transgenic infertile male mouse model, lacking the retinoic acid receptor- α model, presents a squamous rather than pseudostratified epithelium (Costa et al. 1997). Here the distal epididymal and vasal epithelia cannot resorb water; inspissated fluid accumulates and azoospermia results from ductal blockage.

These results demonstrate the importance of normal epithelial function but lead to irreversible infertility with the possibility of anti-sperm antibody formation that is not desired in a male contraceptive.

30.3.2.2 Interfering with Transepithelial Transport and Fluid Secretion and Resorption

Studies in rats show that interfering with fluid transport in the epididymis can be associated with infertility.

- Epididymal fluid resorption *in vivo* is inhibited by the antifertility agents α -chlorohydrin (Wong and Yeung 1977) and 6-chloro-6-deoxyglucose (Wong

et al. 1980), but infertility is thought to be mediated by their anti-glycolytic actions.

- Epididymal fluid secretion *in vitro* is enhanced by adrenalin (through α -receptors), endothelin, vasopressin, angiotensin, pituitary adenylyl cyclase-activating polypeptide, purinergic agonists and prostaglandins. *In vivo*, inhibition of prostaglandin production by the cyclo-oxygenase-1 inhibitor indomethacin does not alter fluid secretion, sperm motility or male fertility (Gong et al. 2000). Epididymal fluid secretion is inhibited by the alkaloid reserpine and both sperm concentration and fluid viscosity are increased under treatment whereas sperm motility is unaffected (Wen and Wong 1988).
- Glucose transport to the epididymis is reduced by the antifertility agents α -chlorohydrin and 6-chloro-6-deoxyglucose (Hinton et al. 1983). However, these agents are thought to be contraceptives because they inhibit sperm glucose metabolism (see below).
- Carnitine transporters are present in the rat epididymis (Rodriguez et al. 2002) but the effect of transport inhibitors on fertility has not been studied. Epididymal carnitine can be lowered by adding pivalate to the drinking water, as a result of increased urinary excretion of (pivaloyl)carnitine and a subsequent lowering of blood carnitine. Neither male rats nor hamsters administered pivalate become infertile following this treatment (Lewin et al. 1997; Cooper et al. 1997).
- There are epididymal transporters for glutamate in mice (EAAC1: Wagenfeld et al. 2002.) When lacking, as in *c-ros* KO mice, epididymal and sperm glutamate levels are depressed (Yeung et al. 2004), spermatozoa are unable to regulate their volume and the males are infertile.

Although theoretically satisfying, these approaches require more research to determine if specific epididymal inhibition of these transport processes is feasible.

30.3.2.3 Interfering with Specific Epididymal Proteins

Interference with specific epididymal proteins may have contraceptive effects, but only limited evidence from immune-suppression experiments in animals are compelling.

- Male rat fertility is not affected by abolishing the activity of an epididymal enzyme (α -glucosidase) with castanospermine (Yeung and Cooper 1994).
- Immunoglobulins can gain access to the epididymal lumen to reduce fertility *in vitro* and *in vivo* after passive immunization with murine sperm-specific antibodies and active immunization against rat epididymal proteins PES or D/E (see Cooper and Yeung 1999).
- Intrasplenic immunization with hamster sperm-derived epididymal P26h is completely effective in preventing fertilisation *in vivo* (Berubé and Sullivan 1994).

Whereas immunological contraception is being used to control wildlife at the population level (Barfield et al. 2006), the unpredictability of individual responses makes immunological contraception risky (Nieschlag and Henke 2005).

30.3.2.4 Inducing a Hostile Epididymal Environment

If the peculiar composition of epididymal fluid is necessary for sperm survival, gross changes to it may cause infertility (Gong et al. 2000).

- Osmolality. Cauda epididymal fluid has a higher osmolality than blood in every species examined (Cooper and Yeung 2003) so that lowering that osmolality, by reducing osmolyte secretion by the epithelium, should produce hypotonic swelling of spermatozoa within the lumen.
- Oxidative death. *In vitro* spermatozoa can generate superoxide anions (Fisher and Aitken 1997) which are potentially damaging. Contraceptive agents could stimulate enzymes producing oxygen radicals or inhibit enzymes removing them. Targets could be the epididymis-specific, extracellular isoenzymes of glutathione peroxidase (GPX5) and superoxide dismutase (SOD) present in epididymal fluid (Vernet et al. 1997; Williams et al. 1998) or tissue indoleamine 2,3-dioxygenase (IDO) and tryptophan dioxygenase (TDO) (Britan et al. 2006).
- pH. Intra-luminal acidification is thought to maintain epididymal spermatozoa in a quiescent state (Carr et al. 1985) and raising pH has been proposed as a contraceptive (Breton et al. 1996). Epithelial apical, narrow and clear cells, responsible for epididymal

luminal acidification, contain a cytoplasmic carbonic anhydrase (providing H⁺) and a vacuolar-type proton pump (H⁺)-ATPase (V-ATPase). In animals, the carbonic anhydrase inhibitor acetazolamide, has no effect on the pH of epididymal fluid *in situ* (Cafilisch and DuBose 1990).

No organ- or cell-specific inhibitors of any of these enzymes, transporters or channels are known, so that no attack in this way is currently possible.

30.3.2.5 Clinical Observations

As human spermatozoa undergo similar maturational processes as do spermatozoa from other species (see Chap. 3), post-testicular approaches to contraception for animals based on physiological principles of sperm transport, maturation and storage should be applicable to man. Although epididymal malfunction may account for 20% of cases of human necrozoospermia (Nduwayo et al. 1995), it is difficult to prove, and there are only a few cases of human male infertility unequivocally caused by epididymal dysfunction (De Kretser et al. 1998).

The many secreted human epididymal glycoproteins that bind to particular sperm membrane domains and are involved in facilitating sperm-ovum interaction (see Chap. 3) are targets for immune-contraception: a potential target is the zona binding protein P34H. Immunotargeting another epididymal secretion, the protease inhibitor Eppin, in monkeys led to incomplete, and not always reversible, infertility (O'Rand et al. 2006).

30.3.3 Attacking Epididymal Spermatozoa

30.3.3.1 Displacing Fertility-Related Sperm Proteins

One protein displaced from spermatozoa of infertile toxicant-treated rats is "contraception associated protein 1" (CAP: Wagenfeld et al. 1998) or SP22 (Klinefelter et al. 1997). This is normally present on the entire sperm head but is missing from a distinct distal equatorial region of spermatozoa from ornidazole-fed rats (Wagenfeld et al. 2000). A dose-dependent

loss of sperm SP22 in males administered ethanedimethanesulphonate is predictive of fertilization after uterine insemination (Klinefelter et al. 1997).

Some of the compounds that displace sperm proteins with deleterious effects on fertility have other effects on male rats *in vivo* (via Leydig cells, epididymal clear cells) and as such are not organ- or cell-specific.

30.3.3.2 Inhibiting Sperm Glycolysis

The concept is to block the metabolism of epididymal spermatozoa irreversibly so they remain inhibited after ejaculation. Whether glycolysis (Miki et al. 2004) or respiration (Ford 2006) supports the energy requirement of spermatozoa remains controversial (Ruiz-Pesini et al. 2007) but α -chlorohydrin inhibits the sperm-specific isoenzymes of glyceraldehyde 3-phosphate dehydrogenase (GAPDH, Gapds) and triose-phosphate isomerase (TPI) and causes "functional sterility" (Jones and Cooper 1999).

Male rats are healthy after continuous daily feeding of α -chlorohydrin for 60 weeks (Jones and Cooper 1999) and ornidazole for 2 years (von Richle et al. 1978), but side effects are observed at the higher doses required for toxicological testing, although there are questions about the purity of the compounds used in early studies (Jones and Cooper 1999).

To avoid side effects associated with circulating drug inhibition of GADP in somatic tissues, inhibitors should be targeted to or accumulated in the epididymis, but none has been identified so far.

30.3.3.3 Preventing Sperm Volume Regulation

Spermatozoa need to regulate their volume upon ejaculation in order to progress within the female tract (see Chap. 3) and this provides a novel contraceptive opportunity. When regulatory volume decrease (RVD) fails, male infertility ensues (Cooper and Barfield 2006) as swollen spermatozoa with angulated flagella fail to pass the uterotubal junction. In the mouse the cause of the sperm swelling may be insufficient osmolyte reserves (Xu et al. 2003; Yeung et al. 2004) so

mimicking this situation to create infertile males could be achieved by:

- Preventing the secretion of osmolytes by the epididymal epithelium. Epididymal transporters have been identified for glutamate in mice (Wagenfeld et al. 2002) and carnitine in rats (Rodriguez et al. 2002) and man (Enomoto et al. 2002).
- Preventing the uptake of osmolytes into spermatozoa. Transporters in spermatozoa have been characterized for carnitine from rats (Kobayashi et al. 2007) and for glutamate in spermatozoa from mice and man (Hu et al. 2004).
- Blocking the channels used by effluxing osmolytes. These include K^+ channels, Cl^- channels and KCC co-transporters (see Yeung et al. 2006; Cooper and Yeung 2007) but only non-specific and reversible inhibitors are known.

No tissue-specific inhibitors are currently known for epithelial transporters, or channels mediating sperm osmolyte influx and efflux to make this approach feasible.

30.3.3.4 Targeting Drug Accumulation in the Epididymis

Targeting the drug to the epididymis would reduce the dose of administered compounds, and ameliorate side effects. This may be achieved by making use of the highly active, pro-luminal epithelial transporters in the epididymis to force entry of the compound into the lumen, but more research on the nature of these transporters is required.

30.3.3.5 Clinical Observations

CAP1 is present in human ejaculated spermatozoa (Wagenfeld et al. 2000) but only on the sperm tail (Whyard et al. 2000). As it is now known that the structure of CAP1/SP22 is identical to that of the human proto-oncogene DJ-1, the RS subunit of an RNA-binding protein and the Parkinson's protein PARK7, all of which are ubiquitous, attacking this protein is unlikely to have a specific effect on spermatozoa.

Human spermatozoa contain a specific form of GAPDH analogous to the murine Gapd-s, which is

bound to the fibrous sheath (Westhoff and Kamp cited in Cooper and Yeung 1999) and are susceptible to glycolytic inhibitors. The rodent antifertility agent ornidazole is used in the clinic for treatment of genital tract infections but human semen quality under treatment has not been examined. Although safe under the acute conditions of use, the doses employed therapeutically are 20–30 times lower than the antifertility dose for rats and its cleavage to the potentially active side chain in man is less extensive than that in the rat, so that changes are unlikely (Cooper and Yeung 1999).

Osmolyte channels involved in human sperm volume regulation include K^+ and Cl^- channels. That spermatozoa from patients display less volume regulating ability than those of fathers (Fetic et al. 2006) or normozoospermic donors (Yeung and Cooper 2008) suggests that inhibiting RVD may well be a fruitful contraceptive approach. Furthermore, when voltage-sensitive K^+ channels are blocked with quinine, human spermatozoa swell and fail to penetrate far into surrogate mucus (Yeung and Cooper 2001). For a contraceptive action initiated in the male to continue in the female in the absence of the inhibitor, such inhibitors should be irreversible.

Despite good evidence for epididymal dysfunction being responsible for male infertility in domestic species, the prospect of mimicking this for human contraception is bleak, since sperm-proteins are not specific and there is a lack of specific inhibitors of glycolytic enzymes or channels mediating volume regulation.

30.4 Preventing Seminal Emission

30.4.1 Surgical Approaches

30.4.1.1 Use of a Scalpel

The procedures for vasectomy are covered in Chap. 16.

30.4.1.2 No-scalpel Approaches

Various extra-luminal and intra-luminal devices to close the vas deferens reversibly are being developed (Barfield et al. 2006) but none is 100% successful. The

use of intra-luminal plugs that solidify after insertion, including RISUG (Reversible Inhibition of Sperm Under Guidance) are being tested. They can block the passage of spermatozoa within a month and reduce the secretion into semen of neutral α -glucosidase, but not fructose and acid phosphatase (Chaki et al. 2003).

30.4.2 Pharmacological Blockade of Seminal Emission

30.4.2.1 Animal Studies

The importance of purinergic receptors in the ejaculatory process is highlighted in the P2X1 knockout mouse, which is sterile owing to an inability of the vas deferens to contract at ejaculation, despite normal adrenergic input (Mulryan et al. 2000).

30.4.2.2 Clinical Observations

The use of α -adrenergic blockers for human contraception was suggested from clinical observations that men receiving sympatholytic agents present with ejaculatory failure (Kedia and Markland 1975). Phenoxybenzamine was the first α 1-blocker studied intentionally as an oral contraceptive (Homonnai et al. 1984); it reduces semen volume, sperm concentration and eventually causes aspermia (anejaculation). Intermittent administration was recommended and normal ejaculate volumes were produced at the end of treatment. Treatment from 7 days before to 5 days after ovulation was suggested, with treatment withheld during menstruation to permit unprotected intercourse. The side effects of one putative contraceptive, thioridazine, were sufficient to have the drug withdrawn (WHO 2005).

Peptidergic agonists are present in the peritubular musculature of the human epididymis (Tainio 1994) and endothelin is a potent stimulator of epididymal contractility in vitro (Peri et al. 1997). Thus peptidergic agonists or antagonists may affect sperm transport through the human epididymis: paralysis of the vas deferens solely at ejaculation by receptor antagonists may be a feasible way of providing rapid, post-epididymal contraception.

30.5 Sperm-Specific Targets

There are now several sperm-specific sperm proteins that may be amenable to attack to achieve male contraception. Spermatozoa could be targeted in the male tract, or after ejaculation in the female tract by administration to the male (or the female) partner. They include:

- Calcium channels. Reports of a widely available calcium channel blocker nifedipine inducing infertility have not been confirmed.
- The catsper calcium channels (1–4). These are specific to the principal piece and evolutionarily similar to potassium channels but inhibitors for them have yet to be developed.
- Soluble sodium-hydrogen exchangers (sNHE). These regulate intracellular pH which is crucial for motility but no inhibitors are known.
- Soluble adenylyl cyclase (sAC). No inhibitors for these are yet known.
- Spermicides. Used as female contraceptives these contain detergents that destroy sperm membranes but also damage the vaginal wall. The contain nonoxynol-9, gramicidin or benzalkonium chloride but more potent spermicides are being developed that could be used in the male, if delivery to and activation in the epididymis could be achieved (Hughes et al. 2007).

30.6 Overall Conclusion

This review has highlighted the possibilities that non-hormonal testicular and pharmacological post-testicular approaches offer to male contraception; most of them under-researched. Of the three approaches reviewed, those involving arrest of muscular contraction at ejaculation could be quite close to clinical testing since autonomic drugs are known, tested and available, and only small developments are required on timing and modes of delivery. Modulating the composition of epididymal fluid for contraceptive purposes does not currently seem promising because of the lack of organ-specificity of epithelial synthetic, secretory and transport processes, the unpredictability of immune responses and the lack of characterization of transporters in the epithelium and spermatozoa. To avoid

systemic side effects, any drug acting on spermatozoa within the epididymal canal should be accumulated in the epididymis, but this is also an area where research needs to be targeted.

References

- Barfield JP, Nieschlag E, Cooper TG (2006) Fertility control in wildlife: Man as model. *Contraception* 73:6–22
- Bérubé B, Sullivan R (1994) Inhibition of in vivo fertilization by active immunization of male hamsters against a 26-kDa sperm glycoprotein. *Biol Reprod* 51:1255–1263
- Breton S, Smith PJS, Lui B, Brown D (1996). Acidification of the male reproductive tract by a proton pumping, H⁺-ATPase. *Nature Med* 2:470–472
- Britan A, Maffre V, Tone S, Drevet JR (2006) Quantitative and spatial differences in the expression of tryptophan-metabolizing enzymes in mouse epididymis. *Cell Tiss Res* 324:301–310
- Caffisch CR, DuBose TD (1990). Effect of α -chlorohydrin on in situ pH in rat testis and epididymis. *Contraception* 41: 207–212
- Carr DW, Usselman MC, Acott TS (1985) Effects of pH, lactate, and viscoelastic drag on sperm motility: a species comparison. *Biol Reprod* 33:588–595
- Chaki SP, Das HC, Misro MM (2003) A short-term evaluation of semen and accessory sex gland function in phase III trial subjects receiving intravaginal contraceptive RISUG. *Contraception* 67:73–78
- Cooper TG (1998) Epididymis. In: Neill JD, Knobil E (eds) *Encyclopedia of reproduction* 2. Academic, San Diego, CA
- Cooper TG, Barfield JP (2006) Utility of infertile male models for contraception and conservation. *Mol Cell Endocrinol* 250:206–211
- Cooper TG, Yeung CH (1999) Recent chemical approaches to post-testicular, epididymal contraception. *Hum Reprod Update* 5:141–152
- Cooper TG, Yeung CH (2003) Acquisition of volume regulatory response of sperm upon maturation in the epididymis and the role of the cytoplasmic droplet. *Microsc Res Tech* 61:28–38
- Cooper TG, Yeung CH (2007) Involvement of potassium and chloride channels and other transporters in volume regulation by spermatozoa. *Curr Pharm Design* 13:3222–3230
- Cooper TG, Wang XS, Yeung CH, Lewin LM (1997) Successful lowering of epididymal carnitine by administration of pivalate to rats. *Int J Androl* 20:180–188
- Costa SL, Boekelheide K, Vanderhyden BC, Seth R, McBurney MW (1997) Male infertility caused by epididymal dysfunction in transgenic mice expressing a dominant negative mutation of retinoic acid receptor- α 1. *Biol Reprod* 56:985–990
- Coutinho EM, Athayde C, Atta G, Gu ZP, Chen ZW, Sang GW, Emuveyan E, Adekunle AO, Mati J, Otubu J, Reidenberg MM, Segal SJ (2000) Gossypol blood levels and inhibition of spermatogenesis in men taking gossypol as a contraceptive. *Contraception* 61:61–67
- De Kretser DM, Huidobro C, Southwick GJ, Temple-Smith PD (1998) The role of the epididymis in human infertility. *J Reprod Fertil* 53(Suppl):271–275
- Enomoto A, Wempe MF, Tsuchida H, Shin HJ, Cha SH, Anzai N, Goto A, Sakamoto A, Niwa T, Kanai Y, Anders MW, Endou H (2002) Molecular identification of a novel carnitine transporter specific to human testis. Insights into the mechanism of carnitine recognition. *J Biol Chem* 277:362–371
- Evans B, Gannon BJ, Heath JW, Burnstock G (1972) Long-lasting damage to the internal male genital organs and their adrenergic innervation in rats following chronic treatment with the antihypertensive drug guanethidine. *Fertil Steril* 23:657–667
- Fetic S, Yeung CH, Sonntag B, Nieschlag E, Cooper TG (2006) Relationship of cytoplasmic droplets to motility, migration in mucus, and volume regulation of human spermatozoa. *J Androl* 27:294–301
- Fisher HM, Aitken RJ (1997) Comparative analysis of the ability of precursor germ cells and epididymal spermatozoa to generate reactive oxygen metabolites. *J Exp Zool* 277:390–400
- Ford WLC (2006) Glycolysis and sperm motility: does a spoonful of sugar help the flagellum go round? *Hum Reprod Update* 12:269–274
- Gong XD, Leung GPH, Cheuk BLY, Wong PY (2000) Interference with the formation of the epididymal microenvironment – a new strategy for male contraception. *Asian J Androl* 2:39–45
- Hinton BT, Hernandez H, Howards SS (1983) The antifertility agents α -chlorohydrin, 5-thio-D-glucose, and 6-chloro-6-deoxy-D-glucose interfere with sugar transport across the epithelium of the rat caput epididymidis. *J Androl* 4:216–221
- Homonnai ZT, Shilon M, Paz GF (1984) Phenoxybenzamine – an effective male contraceptive pill. *Contraception* 29:479–491
- Hu JH, Yang N, Ma YH, Jiang J, Zhang JF, Fei J, Guo LH (2004) Identification of glutamate receptors and transporters in mouse and human sperm. *J Androl* 25:140–146
- Hughes LM, Griffith R, Aitken RJ (2007) The search for a topical dual action spermicide/microbicide. *Curr Med Chem* 14:775–786
- Jones AR, Cooper TG (1999) A re-appraisal of the post-testicular antifertility action and toxicity of chlorinated antifertility compounds. *Int J Androl* 22:130–138
- Jung A, Schuppe HC (2007) Influence of genital heat stress on semen quality in humans. *Andrologia* 39:203–215
- Kedia K, Markland C (1975) The effect of pharmacological agents in ejaculation. *J Urol* 114:569–573
- Kempinas WDG, Suarez JD, Roberts NL, Strader L, Ferrell J, Goldman JM, Klinefelter GR (1998a) Rat epididymal sperm quantity, quality and transit time after guanethidine-induced sympathectomy. *Biol Reprod* 59:890–896
- Kempinas WDG, Suarez JD, Roberts NL, Strader LF, Ferrell J, Goldman JM, Narotsky MG, Perreault SD, Evenson DP, Ricker DD, Klinefelter GR (1998b). Fertility of rat epididymal sperm after chemically and surgically induced sympathectomy. *Biol Reprod* 59:897–904
- Kjaergaard N, Kjaergaard B, Lauriken JG (1988) Prazosin, an adrenergic blocking agent inadequate as male contraceptive pill. *Contraception* 37:621–629
- Klinefelter GR, Suarez JD (1997) Toxicant-induced acceleration of epididymal sperm transit: androgen-dependent proteins may be involved. *Reprod Toxicol* 11:511–519
- Klinefelter GR, Laskey JW, Ferrell J, Suarez JD, Roberts NL (1997) Discriminant analysis indicates a single sperm

- protein, SP22, is predictive of fertility following exposure to epididymal toxicants. *J Androl* 18:139–150
- Kobayashi D, Tamai I, Sai Y, Yoshida K, Wakayama T, Kido Y, Nezu J, Iseki S, Tsuji A (2007) Transport of carnitine and acetylcarnitine by carnitine/organic cation transporter (OCTN) 2 and OCTN3 into epididymal spermatozoa. *Reproduction* 134:651–658
- Lewin LM, Fournier-Delpech S, Weissenberg R, Golan R, Cooper T, Pholpramool C, Shochat L (1997) Effects of pivalic acid and sodium pivalate on L-carnitine concentrations in the cauda epididymidis and on male fertility in the hamster. *Reprod Fertil Develop* 9:427–432
- Lopez LM, Grimes DA, Schulz KF (2005) Nonhormonal drugs for contraception in men; a systematic review. *Obstet Gynecol Surv* 60:746–752
- Mieusset R (1995) Spermatozoa and embryo development. In: Hamamah S, Mieusset R, Dacheux JL (eds) *Frontiers in endocrinology, Epididymis: Role and importance in male infertility treatment*. Ares Sero Symposia, Rome
- Miki K, Qu W, Goulding EH, Willis WD, Bunch DO, Strader LF, Perreault SD, Eddy EM, O'Brien DA (2004) Glyceraldehyde 3-phosphate dehydrogenase-S, a sperm-specific glycolytic enzyme, is required for sperm motility and male fertility. *Proc Natl Acad Sci USA* 101:16501–16506
- Mruk DD (2007) New perspectives in non-hormonal male contraception. *Trends in Endocr Metab* 19:57–64
- Mulryan K, Gitterman DP, Lewis C, Vial C, Leckie BJ, Cobb AL, Brown JE, Conley EC, Buell G, Pritchard CA, Evans RJ (2000) Reduced vas deferens contraction and male infertility in mice lacking P2X1 receptors. *Nature* 403:86–89
- Nduwayo L, Berthélémy C, Lansac J, Tharanno MJ, Leconte P (1995) Conduite à tenir devant une nécrozoospermie. *Contr Fertil Sexual* 23:682–685
- Nieschlag E, Henke A (2005) Hopes for male contraception. *Lancet* 365:554–556
- O'Rand MG, Widgren EE, Wang Z, Richardson RT (2006) Eppin: an effective target for male contraception. *Mol Cell Endocrinol* 250:157–162
- Page ST, Amory JK, Bremner WJ (2008) Advances in male contraception. *Endocr Rev* 29:465–493
- Peri A, Fantoni G, Granchi S, Vannelli GB, Barni T, Amerini S, Pupilli C, Barbagli G, Forti G, Serio M, Maggi M (1997) Gene expression of endothelin-1, endothelin-converting enzyme-1, and endothelin receptors in human epididymis. *J Clin Endocr Metab* 82:3797–3806
- Queiróz DB, Porto CS, Grossman G, Petrusz P, Avellar MC (2008) Immunolocalization of α 1A-adrenoceptors in rat and human epididymis. *Cell Tissue Res* 332:509–522
- Ricker DD, Crone JF, Chanmess SL, Klinefelter GR, Chang TS (1997) Partial sympathetic denervation of the rat epididymis permits fertilization but inhibits embryo development. *J Androl* 18:131–138
- Rodríguez CM, Labus JC, Hinton BT (2002) Organic cation/carnitine transporter, OCTN2, is differentially expressed in the adult rat epididymis. *Biol Reprod* 67:314–319
- Ruiz-Pesini E, Díez-Sánchez C, López-Pérez MJ, Enríquez JA (2007) The role of the mitochondrion in sperm function: is there a place for oxidative phosphorylation or is this a purely glycolytic process? *Curr Top Dev Biol* 77:3–19
- Tainio H (1994) Peptidergic innervation of the human testis and epididymis. *Acta Histochem* 96:415–420
- Toshimori K, Kuwajima M, Yoshinaga K, Wakayama T, Shima K (1999) Dysfunction of the epididymis as a result of primary carnitine deficiency in juvenile visceral steatosis mice. *FEBS Lett* 446:323–326
- Ventura S, Pennefather JM (1991) Sympathetic co-transmission to the cauda epididymis of the rat: characterization of postjunctional adrenoceptors. *Br J Pharmacol* 102:540–544
- Vernet P, Faure J, Dufaure JP, Drevet JR (1997) Tissue and developmental distribution, dependence upon testicular factors and attachment to spermatozoa of GPX5, a murine epididymis-specific glutathione peroxidase. *Mol Reprod Dev* 47:87–98
- von Richle R, Scholer HJ, Angehrn P, et al. (1978) Grundlagen der Chemotherapie von Trichomoniasis und Amoebiasis mit Ornidazol. *Arzneim Forsch* 28:612–625
- Wagenfeld A, Yeung CH, Strupat K, Cooper TG (1998) Shedding of a protein from rat epididymal sperm associated with infertility induced by ornidazole and α -chlorohydrin. *Biol Reprod* 58:1257–1265
- Wagenfeld A, Yeung CH, Shivaji S, Sundareswaran VR, Ariga H, Cooper TG (2000) Expression and cellular localization of contraception associated protein 1. *J Androl* 21:954–963
- Wagenfeld A, Yeung CH, Lehnert W, Nieschlag E, Cooper TG (2002) Lack of glutamate transporter EAAC1 in the epididymis of infertile c-ros receptor tyrosine-kinase deficient mice. *J Androl* 23:772–782
- Wang C, McDonald V, Leung A, Superlano L, Berman N, Hull L, Swerdloff RS (1997) Effect of increased scrotal temperature on sperm production in normal men. *Fertil Steril* 68:334–339
- Wang C, Cui YG, Wang XH, Waltzer WC, Hod Y (2007) Transient scrotal hyperthermia and levonorgestrel enhance testosterone-induced spermatogenesis suppression in men through increased germ cell apoptosis. *J Clin Endocrinol Metab* 92:3292–3304
- Wen RQ, Wong PYD (1988) Reserpine treatment increases viscosity of fluid in the epididymis of rats. *Biol Reprod* 38:969–974
- WHO (2005) Pharmaceuticals Newsletter No. 1; <http://www.who.int/medicine>
- Whyard TC, Cheung W, Sheynkin Y, et al. (2000) Identification of RS as a flagellar and head sperm protein. *Mol Reprod Develop* 55:189–196
- Williams K, Frayne J, Hall L (1998) Expression of extracellular glutathione peroxidase type 5 (GPX5) in the rat male reproductive tract. *Mol Hum Reprod* 4:841–848
- Wong PYD, Yeung CH (1977). Effect of α -chlorohydrin on transport processes in perfused rat cauda epididymidis. *Contraception* 16:637–644
- Wong PYD, Au CL, Ngai HK (1980) Effects of 6-chloro-6-deoxyglucose on electrolyte and water transport in the epididymis and fertility of male rats. *Int J Androl* 3:82–86
- Wong CH, Mruk DD, Lee WM, Cheng CY (2007) Targeted and reversible disruption of the blood-testis barrier by an FSH mutant-occludin peptide conjugate. *FASEB J* 21: 438–448
- Xu Y, Yeung CH, Setiawan I, Avram C, Biber J, Wagenfeld A, Lang F, Cooper TG (2003) Sodium-inorganic phosphate cotransporter NaPi-IIb in the epididymis and its potential role in male fertility studied in a transgenic mouse model. *Biol Reprod* 69:1135–1141
- Yeung CH, Cooper TG (1994) Study of the role of epididymal α -glucosidase in the fertility of male rats by administration

- of the enzyme inhibitor castanospermine. *J Reprod Fertil* 102:401–410
- Yeung CH, Cooper TG (2001) Effects of the ion-channel blocker quinine on human sperm volume, kinematics and mucus penetration, and the involvement of potassium channels. *Mol Human Reprod* 7:819–828
- Yeung CH, Cooper TG (2008) Potassium channels involved in human sperm volume regulation – quantitative studies at the protein and mRNA levels. *Mol Reprod Dev* 75: 659–668
- Yeung CH, Anapolski M, Setiawan I, Lang G, Cooper TG (2004) Effects of putative epididymal osmolytes and the ion channel blocker quinine on sperm volume regulation of fertile and infertile transgenic mice. *J Androl* 25:216–233
- Yeung, CH, Barfield, JP, Cooper TG (2006) Physiological volume regulation by spermatozoa. *Mol Cell Endocrinol* 250: 98–105

Contents

31.1 Social and Cultural Context	601
31.1.1 A Shared Intellectual Responsibility	601
31.1.2 The Structures of Interdisciplinary Dialogue.....	602
31.1.3 The Dilemma of the Theologian.....	602
31.2 Church Statements	603
31.2.1 Previous History: Artificial Insemination	603
31.2.2 In Vitro Fertilization	604
31.2.3 The Dignity of Man and the Right to Life	604
31.3 The Coordinates of Ethical Discussion	606
31.3.1 The Basic Understanding of Marriage	606
31.3.2 Concern for Psycho-Social Health.....	607
31.3.3 Rights and Certainties.....	608
31.4 The Context of in Vitro Fertilization (“Dignitas Personae” nn. 24–35)	609
31.5 Challenges to Tolerance	610
31.6 Conclusions	611
References	611
Church Documents	612

*Translated by S. Nieschlag

K. Demmer
Professor emeritus, Moral Theology of the Pontifical
Gregorian University of Rome, Johanniterstrasse 6, 48145
Münster, Germany

31.1 Social and Cultural Context

31.1.1 A Shared Intellectual
Responsibility

Medical research and clinical practice are not imprisoned in a self-sufficient ivory tower of scholars. Rather, within enlightened democratic society there is a public interest in all matters touching upon the responsible handling of human life over which, thanks to medical research, mankind has been given increasing control. **Critical and constructive solidarity** with all potentially affected persons is therefore called for which lays the foundation for consensual legal standards; effective laws do not arise from unconcerted efforts by legislators or monopoly-seeking lobbyists, but reflect the intellectual responsibility of the whole community. For the physician this provides welcome relief. Serious decisions that have far-reaching consequences in shaping the lives of individual patients must not be made by the scientist in the solitude of his conscience, even though certain tensions between truth's claim for universal validity and any consensus achieved will never be fully resolved.

Ethicists and moral theologians share in the efforts to form opinion in our pluralistic and largely fragmented society; as part of the intellectual elite, they contribute solutions to problems with which society can live responsibly and with intellectual honesty. This is also true for the official teachings of the **Christian churches**, regardless of whether or not the discussants share a basic Christian understanding of man. When the churches make a statement about medical research and its clinical application, they do so under the tacit presupposition that the content of the message can be

rationally justified and thus be credible. In general Christianity has always had a constructive influence on the scientific culture of the west, and will continue to do so if it succeeds in introducing into public discourse guidelines for a meaningful life which are in all respects convincing and exemplary.

31.1.2 *The Structures of Interdisciplinary Dialogue*

It often happens that the public has a mistaken conception of the competency of either philosophical ethicists or moral theologians so that any contribution they may make is not given its proper or due respect. Different styles of thinking which have become virtually institutionalized collide with one another, occasionally giving the impression that they have come to stand next to each other with nothing in common. This image, however, does not correspond to reality; it is better to envision underground channels developing and running here and there linking the various disciplines. In this way, the medical researcher makes tacit assumptions which touch on fields usually claimed by philosophy, scientific theory and anthropology; he is not autonomous, but thinks and acts within the framework of an open system in which compatibility must be achieved: bridgeheads must be established continuously and connections must be made.

The same is true for the ethicist, be he philosopher or moral theologian. He does not design a self-sufficient body of thought to whose rigorous and unyielding logic every knee must bend; his thought is open to the entire range of human scientific experience and remains flexible in light of the variety of human endeavors. He is capable of learning, true to the axiom that facts cannot be argued with. And he becomes acutely aware of his limited competence, whenever he is confronted by the professionalism of the physician. This does not condemn the ethicist or moral theologian to silence. He is always available when the physician touches upon the implicit presuppositions with which he works but oversteps his professional limits and, as a result, draws ethical conclusions. For purely scientific results are ambivalent: whether they are considered a blessing or a curse depends on the underlying understanding of humanity. Finding a sustainable consensus is difficult in a pluralistic society. Who decides and

upon what authority? Transparency and consistency will determine the better argument and win the case. Patience is required and mutual honesty. The physician must not hold back relevant facts nor embroider them with words. Dialogue must not be debased to a politics of language. And the ethicist must make it clear that ethical theories are part of a supporting system of thought whose conclusiveness can provide answers. Only under these conditions can one dare to make value judgements without being backed into a corner or labelled a troublemaker or spoilsport.

31.1.3 *The Dilemma of the Theologian*

When the moral theologian engages in interdisciplinary dialogue, he does not propose exclusively his private opinions, regardless of how well-founded they may be. He always recognizes that the churches hold a privileged place for sound moral instruction and teaching; there is an initial reliance on and confidence in the church's intellectual tradition. Furthermore, as a Roman Catholic, the theologian considers his mandate in terms of partnership with the Church's authority which finds institutional expression in the magisterium of the pope and bishops. Nor is the concept of the magisterium foreign to the Protestant theologian, albeit with varying emphases, comprehensiveness and linguistic forms.

A precarious relationship of trust exists between official church representatives and professional theologians. Their relationship is not always an unclouded one. For the theologian, often the first to be confronted with problems, is not able to withdraw to a "secure corner" and leave it to others to debate and set policy. This carries unavoidable risks for his work; at times he cannot proceed beyond hypothetical answers which demand the courage to revise his position. It is his task both to anticipate and then to interpret official Church statements. This requires much time; he must put up with the continuous tension between ethical insight and its convincing presentation. The physician or medical researcher will understand this; they know, too, the provisional character of their knowledge. Mutual recognition of each other's limitations makes the dialogue all the more credible.

It is a different situation for the magisterium. Whoever speaks with the teaching authority of the church,

be it ever so differentiated can take fewer risks. Occasionally an impression of balking cannot be avoided. However, the theologian always appeals – though in a nuanced variety of ways – to his opposite’s freedom of conscience which is not abrogated. Authority has no intention of trumping plausibility. Differentiated positions will begin to emerge and patience is required on the part of all. Inspired by growing insight, the magisterium strives towards greater clarity and consistency; by learning it conquers its own tradition. In feedback with the institutional community of dialogue, the theologian assumes the role of mediator, always pushing forward and seeking to resolve emerging difficulties in understanding. This is anything but a one-way street.

31.2 Church Statements

31.2.1 *Previous History: Artificial Insemination*

The criticism of artificial insemination by Pope Pius XII († 1958) worthy of consideration set the stage for all further discussions surrounding the pros and cons of the various forms of infertility therapy. The arguments put forward can be briefly summarized as follows: what was deplored by Pope Pius XII was the artificial separation of the procreative purpose from the bodily expression of marital love; they belong essentially together. Here is a line of argumentation that will reemerge in connection with *in vitro* fertilization, and which continued to influence the thinking of Pope John Paul II († 2005).

Man is a bound steward, not an arbitrary creator of a given order of nature, which is interpreted as God’s good creation. It does not fetter or restrain the individual, but, over the entire spectrum of its expression it protects the dignity of the person. In consistent fashion, Pope Pius XII spoke out against the collection of sperm through masturbation. Although the end – the conception of new life – may be good, it does not justify the use of a means that is “in itself” evil.

Moreover, the underlying understanding of the institution of marriage became a matter for discussion. In heterologous protocols, for instance, the exclusivity of the community of life is apparently no longer

safeguarded, insofar as a third person – via donor sperm – invades the intimate union of the couple. In purely objective terms, it was thus quite understandable to speak of adultery. It is not surprising that the pope acknowledged the emerging legal and demographic policy consequences of this problem, nor is it surprising that those issues helped confirm his negative stance. Finally, when public debate introduced the issue of a “right to a child,” he was persuaded to intervene; the existence of a human being is always a free and unmerited gift, never a product which is rightfully owned; in the end, that would imply a deliberate instrumentalization of human existence.

The ethical discussion immediately following was able to introduce first, more precise distinctions. One point of criticism focused on the interpretation of masturbation. Similar to the collection of sperm for diagnostic purposes, its underlying intention was underscored: the purpose of the act is conception and not masturbation. The phenomenal structure of the act itself should be interpreted in this light; neither by itself nor in the final analysis does the act itself determine its morality.

Similarly the papal understanding of the conjugal act also became subjected to question. Without wanting to detract from the fundamental unity that exists between the openness to procreation and the expression of love in the conjugal act, it should not be over-interpreted so as to excessively burden or strain practice. The fundamental dual meaning of the conjugal act is not undermined by any medical intervention but is rather borne out by the couple’s primary goal; technology must not necessarily burden the spontaneity of the couple’s expression of love. If a certain uneasiness continued to persist, then because of the spontaneous feeling that the independent expressivity of conjugal love fell by the wayside; that wherein nature and culture are joined, is torn apart. Does technical progress create cultural relapse?

In general, however, the pope and his critics were to a large extent in agreement in their evaluation of the population policy issues, and the legal and psychological problems associated with heterologous protocols; the dangers were seen clearly and there is no need to list them here, except perhaps to mention that sperm donation required in heterologous protocols epitomizes the tendency to trivialize human sexuality. The child falls victim, as a rule the child is denied the right to know his own father. And the (genetic) father removes himself from any responsibility for the child.

Should it ever be the case that he not remain anonymous, as is currently required, e.g., by German and English lawgivers, there is an enormous risk of inner conflict. Whether and to what extent the child so conceived is a lingering reminder of the absent father, thus putting pressure on the marriage or even leading to its ultimate failure, depends on the basic attitudes of the legal parents.

31.2.2 *In Vitro Fertilization*

The stage was now set for later conflicts concerning in vitro fertilization. The prohibition expressed by official teaching was unequivocally clear. The decisive texts are contained in the Instruction “*Dignitas personae*” nn. 11–23 issued by the Congregation of the Doctrine of the Faith (2008) and Pope John Paul II’s encyclical “*Evangelium vitae*” (1995). Corresponding to the rejection of artificial insemination, here too the hard core of the argument is the underlying anthropology of the conjugal act. With reference to Pope John Paul VI’s encyclical “*Humanae vitae*” (1968), the inseparable unity of the two meanings of the conjugal act – the expression of the couple’s mutual love and the openness to new life – is affirmed as part of the continuous official church teaching. Man does not have the right to separate them artificially, as usually occurs in all technical variations of assisted fertilization.

The reasons and fears looming in the background are manifold. On the one hand they are connected with the morally questionable previous history of this technology. Does the use of IVF necessarily affirm it? On the other hand, reservations arose from the feared mechanization and accompanying despiritualization of the most spontaneous expressions of human life and experience. Not without reason there was talk of “cold conception.” The new context is the aseptic laboratory. Is a cultural relapse paving its way? Ultimately the linking of both elements is a cultural achievement which has nothing to do with naturalism or even biologism; it is aroused by the introduction of technology into one of the most spontaneous expressions in human life. Reproductive technologies that, as Pope John XXIII noted earlier, could be legitimately used with non-human species, cannot be transferred directly to the

human situation. This judgement is definitive; the motives of those involved or concrete circumstances brook no alterations. A threshold value is established which necessarily polarizes belief. The opinion of the Protestant Churches of Germany published under the title “*Von der Würde des menschlichen Lebens*” (On the Dignity of Human Life) (1985) lacks this decisive clarity. Nonetheless there is the fear, held in common, that understanding the child as a “gift” may take second place to that of a “product”.

For the present time, and in somewhat declamatory fashion, in his encyclical “*Evangelium vitae*” Pope John Paul II diagnosed the “culture of death” and contrasted it with a “culture of life.”

Such an emphatic choice of words may be surprising in the context of reproductive medicine which avowedly serves the transmission of life (n. 13 ff.). The expression is clarified in view of the possibility of using spare embryos as raw material or “biological waste” in human experiments that are unnecessary except for the sake of so-called high ranking research and therapeutic goals. This is in no way an exclusively Catholic concern. The Council of the Evangelical-Lutheran Church of Germany and the Catholic German Bishops Conference share the same fears in their joint statement “*Gott ist ein Freund des Lebens*” (God is a Friend of Life) (1989). Here there is complete agreement which does not exclude the perception that, seen as a whole, Catholic statements are clearer and more pronounced.

31.2.3 *The Dignity of Man and the Right to Life*

A consensus crossing confessional boundaries concerning both the ontological as well as the moral status of the early embryo is presently beginning to dissolve. The official Catholic position is that specifically human life that is owed protection begins with the syngamy or fusion of the gametes, even though this fusion does not occur at any one moment but is understood as an ongoing process. A determining factor of this concept is the theological theory of simultaneous ensoulment propagated by the early church, later taken up by the Council of Vienne (1311/12), the 5th Lateran Council (1513) and confirmed by Pope John Paul II (Enc. *Evangelium*

vitae, n. 60f.). This is in contrast to successive ensoulment which, under the influence of Aristotle, who, referring back to mythological concepts, was introduced into Catholic theology by way of Thomas Aquinas († 1274) in disagreement with his teacher Albert the Great († 1280); up to the very present day this concept has maintained a lasting influence.

With syngamy, a new entity – distinct from the mother and with its own genetic programme – is brought forth, and begins its own course of development. That this process is subject to both endogenous as well as exogenous risks does not change its basic ontological and moral status.

This is also true in view of the extremely weak autarchy as well as individuality of the early embryo. The maternal environment **certainly** is indispensable for its survival and thereby exerts causal influence on its epigenesis. But that such an influential process can take place at all presupposes an individual counterpart with independent activity, be it ever so slight. Pure passivity does not exist, it is nothing than an intellectual construct. And moreover, the metaphysical category of **autonomy** should not be reduced to the physical category of **autarchy**, if confusion of categories is to be avoided.

As the most fundamental of rights, the logic of the right to life is equally compelling at all times. It is not constrained by achievement of a certain developmental stage which can never be fixed arbitrarily, free of instrumentalization. If, in this context, the idea of cultural attribution arises, it is firmly founded in an undeniable reality. Whoever shall set such boundaries and on what authority: society, the physician, the mother? The right to life precedes any acknowledgement, by whomsoever. Is it thus not more consistent to reduce the self-purpose of human life to its very beginnings? The embryo does not develop **into** a person but **as** a person. The bioethical argument put forth by the German Evangelical Church, “Im Geist der Liebe mit dem Leben umgehen” [Dealing with Life in the Spirit of Love] (2002) speaks of the developing person without claiming a final position for the Protestant viewpoint. This process is continuous without natural stages allowing total disposability of human life. It retains its identity in the dynamism of its beginnings and at all moments of its development. It possesses an active potentiality to form whatever higher degrees of differentiation. Whatever exists – to whatever differing degrees – arises from potentiality which is already

carried over into the act. Moreover, potentiality is not to be considered synonymous with capacity. And this, under differing conditions, pertains to the totality of human development.

It is not a case of a life less worthy of protection. The concept of the individual cannot be conceived in quantitative categories; one cannot be “more” or “less” a person. At this stage of vulnerability and weakness the demands to protect human life should increase all the more, and this in terms of advocacy.

To be sure, a capacity for abstraction is challenged when a human being with his/her own rights is expected to be seen in a being the size of a pinhead. But how much greater a capacity is demanded by the fields of physics or mathematics! Abstraction is the price of science. Not all Protestants share this view. Occasionally when theoretical doubts remain, tendencies to consider graduated solutions are observed. Here underlying confessional assumptions have proved themselves effective which play a role in the use of terms such as dilemma, compromise, tragic guilt and the lesser evil.

When it speaks out in these matters the Catholic Church does not adopt any particular philosophical system as its own when it speaks of “man” or “person”, only the transparency of argument counts. In the encyclica “Evangelium vitae” (n. 60f.) “person” is used with reference to biological events, in connection with a rhetorical question. Facts, however, are not compelling, they suggest independent processes of comprehension and interpretation, underlain by a theologically grounded thought process which should refrain from forcible distortion of facts. The acceptance of personal life appears as the relatively most befitting alternative; in contrast, the distinction between pre-personal and personal life seems arbitrary. A broadly formulated concept of person is assumed which follows on from observed stages of development.

This affirms the legitimate desire for a maximum amount of protection for human life; it acts as a dam. The task of natural philosophical discussion is to reconcile the classical categories of understanding which had been developed against the background of past scientific concepts with the current knowledge of embryo development. This concerns key terms such as substance, teleology and individuality. Here culturally determined patterns of thought are of influence, but cannot be used arbitrarily.

31.3 The Coordinates of Ethical Discussion

31.3.1 *The Basic Understanding of Marriage*

Official church statements have the merit of providing indispensable guideposts to those engaged in public discourse. They are focal points or axes around which discussion turns regardless of the outcome. Ethical reflection within the Church is especially requested, further distinctions and clarification can be made with various degrees of authority; positions that are taken are not wholly specific to any one confession. Morality has an autonomous character which permits universal communication transcending confessional and even philosophical boundaries.

One genuine concern in this discussion is the underlying understanding of sexuality and marriage. Those who believe that relevant principal issues of reproduction are fundamentally tied to the institution of marriage will consistently apply these principles to homologous protocols. Reproductive medicine is bound by this logic; it may not claim criteria or norms all its own. These concerns render an extension to quasi-homologous protocols meaningless. Responsibility for the social context of sexuality and reproduction fades in importance. The dominating criterion is the care for the child conceived, in particular providing the child a home with a stable heterosexual couple, as it is of supreme importance for the formation and development of a mature and well-integrated personality as well as for the discovery of one's identity. In light of this, there arises a question for the physician: regardless of the procedures' legality, is this extension of strict regulations meant to be interpreted as evidence of responsible tolerance? The main goal of reforms in the laws of inheritance sometimes referred to in this context is to protect the illegitimately conceived child from unjust harm. They must not undermine the shield afforded by the institutions of marriage and family.

Ethical reservations multiply when the desire for a child arises quite outside the limits of such a socially supportive background. In that case it is irrelevant whether the desire for a child is on the part of a single parent or same-sex couple. In either case, the wish for offspring is fulfilled at the cost of the child. It is completely ignored that social contexts have a supportive

function by providing security; the child is robbed of this protection. This is equally the case when advanced age of the woman makes long-term performance of parental duties more difficult. This is particularly the case if a younger woman is involved as egg-donor. Parents exist for the sake of the child, not vice-versa. In every case this principle demands respect.

The tendency to delay childbearing for professional reasons and then, when nature fails, to make use of all possible medical technologies, creates a great pressure for justification on the part of the would-be parents. Nature's odds are defied to produce a child. This creates an urgent appeal to social and labor laws to enable parenthood to be achieved at the timepoint biologically best suited for mother and child.

In vitro fertilization by donor will continue to cause disagreement as it presents unsurmountable difficulties. The precipitous use of the word "adultery" should be avoided because it connotes an element of unfaithfulness on the part of the individual which may never be assumed. This limitation, however, cannot overcome the concerns mentioned earlier. They arise from the separation of genetic and legal parenthood. This applies equally to both sperm and egg donors, whereby the latter is exposed to health risks. In terms of giving life to a child, the bodily and spiritual aspects of the relationship are separated, revealing the danger – perhaps already a burden on the couple – of a dualistic anthropology.

Certainly the child as the weakest part is affected to the extent that he no longer has an unambiguous and manifest genetic identity. Is there a subliminal fear here of losing one's sense of belonging? Ultimately, self-awareness of the person depends on knowledge about his origin; renouncing this legitimate expectation seems unjust, and society shares in the harm that is done. The couple's wish for a child – a wish that is completely understandable – must not ignore the social responsibility they also share; the price paid to fulfil such a wish is the loss of any sense of proportion.

Adoption of embryos may be considered as an open question. Is the phrase a semantic trick, which reverses the original meaning? So that childless parents can be provided with a child instead of children without parents being provided with father and mother? But why should such a reversal be so subject to criticism? Moreover, couples affected will ask themselves whether classic adoption is an option. And, last but not least, the possibility of accepting one's own fate might

be considered, for it too offers the chance to consolidate the partnership and release forces beyond the limitations of the partnership. Openness for conception is not to be equated with fixation.

Reproductive medicine renews the challenge to intellectual plausibility which revolved around artificial insemination. It concerns the **anthropology of the conjugal act**, in particular the inseparability of the act's two meanings (see Sect. 31.2.2). The ethical debate has dealt with the basic issue for a long time, although under the aspect of contraception; it has also been discussed in scholarly circles within the Catholic church. The question is: does the separation of procreation from its expressive qualities through techniques of assisted fertilization that provide relief from infertility – albeit temporarily – merit such condemnation? Is the connection between the couple's expression of love and their openness to offspring understood too restrictive and narrow?

Ethical discussions have focused on a flexible interpretation of human action per se. Although the phenomenal aspect of the act is surely an important indicator, it is with certainty not the exclusive criterion determining the act's morality. The whole ensemble of factors and circumstances likewise has to be taken into account. When a couple accepts the burden of techniques accompanying assisted reproduction in order to fulfil their wish for a child this may indeed be interpreted as a valid expression of marital love. The governing intention unites both meanings of the conjugal act; technical separation will be counterbalanced by this intentional unity. Precipitous moral evaluations of reproductive technologies must take notice of this. Whosoever maintains his reservations concerning in vitro fertilization and simultaneously affirms the permitted use of contraception, must be prepared to defend a contradiction in his thinking. For he too accepts a separation of the two aspects, albeit in reverse direction. In his favour he might note a more intensive perception in the case of IVF.

31.3.2 Concern for Psycho-Social Health

Those facilities that offer reproductive technologies to couples aim at protecting comprehensive well-being of the child; his well-being is the foremost concern. At the same time, all psychological and social factors

must also be taken into account. One such consideration is the free decision of the couple; couples should not undertake therapeutic procedures under any emotional or psychological pressure from whatever source because such coercion will unquestionably affect the child negatively. It is necessary for the couple, then, to examine very carefully whether or not available alternatives offer more acceptable choices. Whoever sincerely considers all the alternatives available will achieve a greater understanding of their desire for offspring as well as a mature sense of peace.

Consultation with a trained psychologist can help in this regard. This is true especially in those situations in which the fate of childlessness proves to threaten the stability of the marriage. In such a situation, just having a child is not the solution; one risks the danger of a subliminal but real disregard for the child. Such a point of departure can have adverse effects on the child's later development; perhaps expectations are subliminally imposed on the child which, even with the best intentions, cannot be fulfilled.

When disillusionment sets in, repercussions will also be felt throughout the marriage. A human person is never a "therapy" for a couple in a precarious relationship. Their healing must be sought at a deeper level; fulfilling the wish for a child can easily be a diversionary tactic saving the couple from the challenge of deeper emotional and psychological therapy. Emotional and psychological distress cannot be redressed through proxy. Moreover, the welfare of the larger community should be kept in mind. The perspective may not only be focussed on the immediate world – perhaps at the expense of longstanding social structures. Nor should it be ignored that such a perfect "dream child" can all too easily be saddled with great expectations, exaggerated wishes which can be projected onto the potential mother, who is put under pressure. In the event of failure, the disappointment will be all the greater. A more relaxed approach in dealing with involuntary childlessness is therefore desirable.

The moral evaluation of **surrogate motherhood** in its various forms follows relatively easily. Pregnancy is not a purely physiological process and moreover, should not be commercialized. Rather, a deep and personal bond is formed affecting both the pregnant woman as well as the child to be born. The relationship between them cannot end at the moment of birth simply on the basis of an agreement without doing violence to nature. Moreover, it cannot be ignored that

resolution of conflicts possibly arising is made exceedingly more difficult. Who decides in the case of a high-risk pregnancy? Is it the surrogate mother alone who bears the responsibility or does the genetic mother have a right to speak, and if so, to what extent? Can the assumption of higher risks be settled through a contractual waiver? Could it be legally enforced? Here unresolved conflicts arise which are at the expense of the child, as the one primarily affected but having no voice at all in the matter. For this reason moral reservations need no further justification.

31.3.3 Rights and Certainties

The demand for a precarious reconciliation between rights and certainties arises with regard to determining the quality of embryos conceived “in vitro” as it occurs in connection with single-embryo-transfer (SET). As is known, from among several embryos the most ideal embryo, i.e., the one most capable of survival is selected and transferred. The others are “set aside”, that is, the basic conditions for survival are withdrawn and they are left to die. The goal of SET is the precision landing, that is, to avoid precarious pregnancies and to increase the success rates of IVF. This reduces the stress factors for the patient. The German Law for the Protection of Embryos secretly mutates into a Law for the Protection of Pregnancy. A balance is directly struck between high ranking qualities of life such as the mother’s health and the child’s right to life. The idea of a suicide mission comes to mind. But the laboratory is not a war theatre. Moreover, the question arises what degree of certainty is offered by such quality control. Must one not decide, in doubtful cases, in favour of the embryo? In cases of dubious facts which affect the right of life, protective strategies and not probabilistic ones are to be favoured. This represents good ethical tradition. SET appears acceptable only under the condition of graded protection of the embryo.

However, SET should not be rejected all too easily. Even an approach which is protective in principle allows certain degrees of certainty, so that selection is not unacceptable in every case. There may be sufficient certainty founded on experience for not performing a transfer. The slogan of the “survival of the fittest” is not always applicable. The ability to differentiate is expected of the ethicist. In the case of a patient’s

advanced age, if the patient accepts the risk of multiple pregnancy, the physician has the duty to inform her and ensure her acceptance of that risk.

The definition of the embryo as a being unto itself implies the rejection of experiments using human material. The individual is never exclusively a means to achieve an end independent from his own self. This variation on the categorical imperative guides the researcher who shares the anthropological premises previously mentioned. The right to intrude into the bodily integrity of the embryo in its earliest stages must be considered along similar lines. Deliberate abuse or disregard of the bodily integrity of the embryo cannot be allowed as it is the case whenever the well-being of the child – the first one to be affected – is no longer given absolute priority. The unequivocalness of this position places strict requirements on the researcher to prevent the dangers from a breach in the dyke. This also applies to the embryo eliminated because of its inability to survive; it does not lose its dignity. And finally, the physician must rely on proxy decisions. Without doubt the embryo is in the weaker and more vulnerable position. The instruction of the Congregation of the Doctrine of the Faith “*Dignitas personae*” (2008) is the advocate for these considerations.

It then follows from this line of argument that the genetic manipulation of the embryo is not admissible. At the basis of this proscription is the recognized right to unadulterated genetic patrimony. This touches on the eventual possibility of germ line therapy. The reservations emerging here envisage not only the medical consequences of such research, but they also seek to prevent the danger of a **eugenic mentality**. To raise a veto at this point is not a sign of naturalism or even biologism, rather only the natural preconditions for personal identity are protected. The German Law for the Protection of Embryos, § 8 embraces the fears mentioned. Admittedly it does not fail to recognize that even other means may rob a person of his identity, of which not the least and perhaps more effective means, is intellectual indoctrination.

Now the objection could be raised that absolute genetic identity is an abstract utopia. Medical technology does nothing more than to hasten entirely normal processes. The objection, however, is not fully convincing, because the supposed risks are not only knowingly provoked but condensed in time and made increasingly unclear. It may remain an open question whether or not the same apprehensions hold in the case

of sex determination because of eugenic indications, also its extension in the sense of “family planning”. Is a natural balance disturbed? The same restrictive attitude should be applied to the attempt at targeted enhancement of genetic material. Are there operable criteria free of a racist-materialistic concept of man? “Pure chance” may be the best guarantee for achieving the end in and of itself, irrespective of any protective regulation through choice of partner.

Initially microinjection (intracytoplasmic sperm injection: ICSI), the method used in cases of disturbed male fertility, had to defend itself against the suspicion of a manipulative intervention: it was not left to the natural process which of the many sperm contained in the semen would fuse with the egg. However, the targeted intervention demonstrably serves to increase the success rate; selection made by nature is supported. This offers the advantage of avoiding an abnormal child early on without resorting to illegal measures. Should, however, damages occur, they will rest with the parents. Thus a point of criticism mentioned initially becomes invalid.

The duty to minimize risks applies to all techniques used. Early reservations against assisted fertilization arose because of the implied disproportionality. But is this still justified? When comparing these risks with those complications arising from naturally induced pregnancies they are almost identical. And the same applies to the baby-take-home rate. The two-embryo transfer reduces risks similarly. The physician’s principle of “nil nocere” is not invalidated. Are therefore any small, remaining differences still valid in ethical terms? Any exact balancing seems neither warranted nor covered by ethical tradition. One is reminded of previously sanctioned attempts by the woman to achieve pregnancy despite proven tendencies toward spontaneous abortion. Or has there been a rise in ethical sensibility?

Ethicists and physicians working in reproductive medicine doubtlessly agree that biological nature can never be understood as the authority for ethical action. They deal with nature that is accessible empirically but also introduce into their data a projection that goes beyond it and humanizes it, subject to the underlying assumptions of the person. This is the perspective from which to deal with artificially induced risks – especially for the embryo, which has deliberately been placed in this precarious position. This was heavily reflected with regard to cryoconservation. Risks can never be

avoided completely. Weighing and ranking benefits and calculable risks cannot be avoided. There is also a tendency to fearful over-reflection. However, careful dealing with nature is always the motto. Avoidance of over-stimulation and in vitro maturation are part of this perspective.

31.4 The Context of In Vitro Fertilization (“*Dignitas Personae*” nn. 24–35)

In vitro fertilization marked a crossing of the Rubicon which was followed by others. It opened the door to preimplantation diagnosis (PGD) and the attendant controversies. The ethical problems are polarized between arguments of status and purpose. The problem is on-demand conception. Here selection is made purely according to genetic criteria or tissue compatibility with a putative cell recipient. In this context, the word “reprogenetics” is fully justified. The dominant concept is that in its earliest phase, life is generally exchangeable. Moreover, in the background stands a genetic determinism of questionable understanding. What prognostic value can be claimed by such diagnosis? The lack of clearcut criteria as well as the rejection of damaged cells suggest an analogy to roulette. All those involved are sucked into the vortex of technology. This is in view of the human burden and the ever increasing costs, be they for the parents of a handicapped child, or for society, of which normally an expression of solidarity is expected. The horror vision of being stigmatized threatens both child and parents and cannot be ignored. And the physician and his team, burdened by sheer limitations of time, is pressured into making decisions. The teleology of clinical action is put to the extreme test. Finally PGD brings with it the willingness to abort. The ethical problems associated with single-embryo-transfer recur under the label of eugenics.

When, in expectation of abnormal offspring following prenatal diagnosis, couples are determined to abort and consider PGD as the lesser evil, they are dependent on purely descriptive categories. These recommend themselves through the lack of sensation of pain during early embryonic stages. In the background stands the slogan: no brain, no pain, no person. Nevertheless it seems inappropriate to speak of the

choice of lesser ethical problems. One never chooses a problem, but rather the more convincing solution. Protestant authors show a careful acceptance of PGD, a certain pluralism is recognizable.

Comparisons with prenatal diagnosis are inevitable. Regardless of differences of principle, in the event of diagnosis of incurability, abortion tends to be the rule. This puts the coherency of medical action to the test. Aside from the physician's duty to inform the patient, should he also be prepared to carry out the abortion demanded, or can he delegate such a demand to others? Is his refusal free of double morality? Or, in the view of such a vicious circle in the sense of ethical prophylaxis, should he not get involved?

Ethical considerations of in vitro fertilization should at least mention **cloning techniques**. All previously mentioned arguments return within a new context. There is great controversy concerning the question of status. The ethicist will refrain from any suspicion of representing researchers' interests and will not question the therapeutic goal. Rejection of reproductive cloning will be understood, not only for reasons to do with technology, but also because of injuring the right to genetic identity. Whether this argument is convincing is open to question. Moreover it contributes to biological impoverishment, which cannot be desired. In therapeutic cloning, also called research cloning, there is no doubt about the intention. Generally the classical principles of transplantation medicine apply. Concern arises about the means used, i.e., the consumption of embryos or totipotent cells. Research stands before a provoked dilemma: in order to possibly save lives and heal disease in the distant future, present life must be sacrificed or the chance for its development must be deliberately be withheld. Whether alternatives are sought or not depends on the answer to the question of status.

The stem cell researcher will argue that he "rededicates" supernumerary embryos produced during in vitro fertilization for a good purpose. Here the goal of healing is given preference over that of protection. An uncertain future is preferred to the secure present, only convincing those who call for graded protection of life in the status question.

Treating egg cells with stopper genes, which produces an artefact and no viable organism, can be considered harmless when seen in isolation. Who, however, extends his vision to the consequences, will likely have strong reservations because the road to genetic

engineering is open. Is this another Rubicon? In the background basic questions are hidden. They concern the tension between scientific and philosophical thinking: in order to avoid reductionistic monism this tension should be maintained. Does the extremely weak teleology provide a legal case for controlling intervention or does it demand a case for protection according to anthropological assumptions?

The advantage of clear decisions is obvious, especially with regard to legal regulations. Those who legalize consuming embryo research must scrutinize existing legislation governing abortion. Is the *Fristenlösung* (arrangement allowing abortion within the first trimester) a consistent postulate? If life becomes disposable in virtual conflicts, how much more so under actual circumstances! Deadlines, whether fixed or not, make no difference. Whoever seeks the goal also desires the means.

31.5 Challenges to Tolerance

Strenuous efforts to achieve a moral consensus upon which sound legal standards are built will never resolve all conflicting points of view. There remain areas open for discussion and grey areas which can become a burden for anyone working in reproductive medicine who is sensitive to ethical issues. He sees himself confronted with expectations by those who do not share his convictions. A pluralistically structured society reinforces the lack of agreement between legal and moral spheres. Quick recourse to what is legally allowed can never free one from the burden of independent moral judgment. Whoever is satisfied with plumbing the depths of the grey zones of legality to his own advantage or that of his patients avoids the challenge of the pluralistically structured democratic state. Occasionally the courage to say no is demanded. The physician is never a living tool in the hands of the patient. Active tolerance, such as is demanded from every citizen, cannot avoid drawing boundaries. Ethical pluralism may be a fact, but it is not a maxim for action. Whoever overlooks this continuously provokes new claims and promotes a consumer mentality which exercises pressure to conform on the physician. Whether and if corresponding cartels of opinion exist to increase this pressure cannot be dealt with here.

The self-understanding of the physician is also tested. His partnership with the patient certainly demands a non-directive approach. Results of consultations must remain open. But firmness of position is not identical with hegemonization. The danger of reverse paternalism is a threat when human problems are reduced to their technological aspects and are thus “solved.” One withdraws from the right to mutual autonomy. This danger is particularly great in an increasingly globalized society. For it is utterly impossible to find legal regulations across borders. Different legal cultures make the prevailing ethical pluralism less controllable than in a relatively homogenous national legal and cultural domain. Available formulaic compromises are then so insubstantial that they lack any power and are reduced to comforting formulas. Can an independent national solution be made internationally plausible?

Contradictions of judgement within the legal system may occasionally be confusing. The different standards in embryo protection and abortion laws are recalled to mind: the embryo created in vitro is obviously better protected than the embryo and fetus during natural pregnancy. It should be remembered in this proper context that legal possibilities are not always equivalent and that they react to different situations of conflict. How strong and how certain are the conflicting rights? Are these conflicts actual or virtual? Imposed or provoked, avoidable or without alternative? Contradictory evaluations therefore appeal to the autonomy of moral judgment. The same applies to the legal treatment of emergency contraception: punishment can only be considered when a crime can be proven. This, however, does not apply to the current case. Generally, a legal vacuum should not be confused with moral approval by the lawmaker.

31.6 Conclusions

Whatever the attitude to IVF is, there are concerns across confessional borders. These are caused, on the one hand, by the difficulty of maintaining strict criteria in day-to-day practice, and on the other hand, by the necessity for further embryo research unless one wants to freeze the standard currently achieved. The social context must also be considered: will natural structures with cultural values be dissolved and be exposed to

uncontrolled arbitrariness – especially in a pluralistic environment? Of what value are ethical traditions to the individual? And which sacrifices can society demand for their defense? Are aspects of feminist ethics dealt with sufficiently?

The final conclusion is therefore divided. The ethicist should not deprecate the tragedy of involuntary childlessness. If nonetheless reservations concerning the mechanization of the most spontaneous and intimate situations of life remain, then because of considerations that the expression of human sexuality could suffer, and the prevailing intention could obscure the value of individual action. Past experience has demonstrated that drifting dunes threaten to uncover new, underlying problems. This especially concerns the status of the embryo. Couples afflicted should therefore ask themselves whether they really want such treatment and the physician is obliged to inform them about the ethical dilemma, thereby considering that in vitro fertilization is only a segment of the “therapeutic” possibilities available.

References

- Bainbridge D (2001) *Making babies: The science of pregnancy*. Harvard University Press, Cambridge, MA
- Deech R, Smajdor A (2007) *From IVF to immortality: Controversy in the era of reproductive technology*. Oxford University Press, New York
- Gerris J, Olivennes F, De Sutter P (eds) (2004) *Assisted reproductive technologies: Quality and safety*. Taylor & Francis, Boca Raton, FL
- Hull RT (ed) (2005) *Ethical issues in the new reproductive technologies*. Prometheus Books, 2nd edn. Amherst, New York
- Jackson TP (2005) *The morality of adoption: social-psychological, theological, and legal perspective*. Eerdmans, Grand Rapids, MI
- Kilner JF, Cunningham PC, Hager WD (eds) (2000) *The reproduction revolution: A Christian appraisal of sexuality, reproductive technologies, and the family*. Eerdmans, Grand Rapids, MI
- Rothschild J (2005) *The dream of the perfect child*. Indiana University Press, Bloomington, IN
- Shenfield F, Sureau C (2006) *Contemporary ethical dilemmas in assisted reproduction*. Taylor & Francis, Boca Raton, FL
- The President's Council on Bioethics (2004) *Reproduction and responsibility: The regulation of new biotechnologies*. Washington, DC
- Warnock M (2002) *Making babies: Is there a right to have children?* Oxford University Press, New York
- Wildes KW (1997) *Infertility: A crossroad of faith, medicine, and technology*. Kluwer, Dordrecht, NL

Church Documents

Pope Paul VI, Encyclical letter "Humanae vitae" (1968)
Congregation for the Doctrine of Faith, Instruction "Dignitas
personae" (2008)

Pope John Paul II, Encyclical letter "Evangelium vitae" (1995)
Gemeinsame Erklärung des Rates der Evangelischen Kirche
Deutschlands und der deutschen Bischofskonferenz, "Gott
ist ein Freund des Lebens" (1989)

Index

A

- Abdominal circumference, 95
- Abortion, 248, 559
- Abstinence, 125, 128, 129, 483, 560, 562–563
- Abstinence period, 69
- Abuse anabolic steroids, 452–453
- Acceptability of male contraception, 560–561
- Acceptance of multiple pregnancies, 526
- Acceptance of penile implants, 316
- Achondroplasia, 248, 367
- Acid phosphatase, 72, 132
- Acne, 329
- Acquired anorchia, 195–197
- Acquired immune deficiency syndrome (AIDS), 352, 353, 398, 511, 563
- Acquired penile deviation, 281–282
- Acromegaly, 256
- Acrosin, 66, 68, 69, 77
- Acrosomal phase, 19
- Acrosome, 126, 130
- Acrosome reaction, 66, 68, 74–78, 141, 143–145, 273, 274
- Acrosome reaction to ionophore challenge (ARIC), 144, 145
- Actin, 14
- Activating and inactivating mutations of the gonadotropin receptors, 31
- Activating LH receptor mutations, 225
- Activating mutations, 224, 226, 231
- Activin, 23, 35
- Acts of inclination, 548
- Acupuncture, 464
- Acute bacterial prostatitis, 264, 266
- Acute epididymitis, 264
- Acute orchitis, 206
- Acute toxicity, 365
- Acycline, 582
- Addison's disease, 419
- Adnexitis, 265
- Adolescent gynecomastia, 331–334
- Adoption, 522, 524, 528, 532, 533
- Adoption of embryos, 606
- Adrenal tumors, 333
- Adrenarache, 54
- Adrenocorticotrophic hormone (ACTH), 395, 415
- Adrenomedullin, 14
- Adriamycin, 509
- Adverse side-effects, 294
- AFP, 229
- Age, 392–393, 396, 397, 407, 411, 416, 419, 421, 425, 429, 431
 - of the female partner, 4, 5
 - of the male partner, 4
- Agglutination, 126, 127, 131, 132, 483
- Aggregation, 126, 127
- Aging, 239–258
- Alcohol, 343, 350, 355, 376, 395, 430
 - abuse, 289
 - and social drugs, 376
- Algopareunia, 394
- Alkaline gel electrophoresis, 149
- Alkylated iminosugars, 590
- Alkylating agents, 590
- Alloimmunity, 430–431
- Alopecia, 96
 - Alopecia areata, 419
- Alpha-adrenergic substances, 484
- Alzheimer disease, 348
- Amenorrhea, 404, 408–411, 413, 414, 417, 418, 427
- Aminoglutethimide, 341
- Amygdala, 541
- Amyloidosis, 354
- Anabolic steroids, 355, 441, 449, 452–453
- Anamnesis, 93–100
- Anatomical variations of the vagina, 420
- Andractim[®], 445
- Andriol[®], 439, 443, 448
- Androderm[®], 442, 445
- Androgenetic alopecia, 325–326
- Androgen insensitivity (AI), 323–328
- Androgen receptor (AR), 14, 24, 33, 34, 39, 43, 44, 46–52, 253, 256, 324, 325, 327, 328, 335, 457
 - antagonists blocking, 341
 - CAG repeats, 113
 - polymorphism, 52, 113
- Androgens, 459–463
 - action, 34, 36, 39, 44–50
 - bioactivity, 115
 - deficiency, 93–95, 243, 250–253, 340–345, 347, 350–356
 - plus gestagens, 582–584
- Andrological factor, 525
- Andropatch[®], 442
- Androstane-3 α , 12, 44
- Androstendione, 439

- Δ 4-Androstendione, 223
 Androstenedione, 33, 42, 47, 115, 116
 Androsterone, 33, 42
 Androtop[®], 443, 445
 Anejaculation, 317
 Aneuploidy, 248, 346
 Angelman syndrome, 496
 Angiographic occlusion, 205
 Angiotensin, 411
 Ankylosing spondylitis, 352
 Anorchia, 98, 194–197, 199, 222
 Anorexia, 345, 351
 Anorexia nervosa, 351, 418
 Anosmia, 96
 Antagonists of androgen action, 341
 Antegrade ejaculation, 484
 Antegrade sclerosing of the spermatic vein, 205
 Anterior pituitary, 21, 22
 Anthropology of the conjugal act, 604, 607
 Antiandrogens, 196, 257
 Antibodies of the IgG- and IgA-class, 273
 Antibody testing, 428
 Anticholinergics, 484
 Anticonvulsants, 341, 348
 Antidepressants, 290
 Antiestrogens, 416, 459–461
 Antihistamines, 290
 Antihypertensive drugs, 290, 307
 Anti-mullerian hormone (AMH), 52, 115–116, 194, 195, 220, 221, 323, 392, 400, 414
 Antimycotic drugs, 290
 Antioxidants, 463–464
 Anti-sperm antibodies (ASA), 70, 141, 145, 268, 273–275, 349, 481
 Apert syndrome, 248, 367
 Aplasia of the mullerian duct, 421
 Aplastic and renal anemia, 437
 Apomorphine, 301, 302
 Apoptosis, 21, 37, 366–368, 370
 AR mutation, 325, 328
 Aromatase gene (CYP19A1), 333
 Aromatase inhibitors, 416, 417, 426–428, 459–460
 Array CGH, 120, 122
 Arterial inflow, 284–286, 288, 310
 Arterial insufficiency of the penile vessels, 288
 Arterial penile circulation, 295
 Arteriosclerosis, 567, 569
 Arteriosclerotic alterations, 244
 Artificial insemination, 603–604, 607
 Ascorbic acid, 464
 Asherman's syndrome, 410
 Aspermia, 50, 317
 Assays of chromatin compaction, 147–149
 Assisted hatching, 478, 491–492
 Assisted reproduction, 268–271, 465, 470–471, 483–485, 493–497, 607
 Assisted reproductive techniques (ART), 61, 68, 521, 527–528, 530, 531, 534
 Asthma, 397
 Asymptomatic inflammatory prostatitis, 264
 Ataxia, 347, 348
 Atherosclerotic cardiovascular disease, 354
 Autoantibodies, 351, 352, 419
 Auto-antigens, 38
 Autoimmune diseases, 419, 430
 Autoimmune factors, 395
 Autoimmune orchitis, 352
 Autoimmunity, 430
 Autoinjection therapy, 281, 311–313, 315
 Autonomic nerve fibers, 299
 Autotransplantation, 199
 Average path velocity (VAP), 141
 Axillary, hair 48, 51
 Axonemal complex, 67, 72, 73
 Axoneme, 67, 72–73
 Azathioprine, 342, 343
 AZFa, 218, 495
 AZFa deletions, 218, 219
 AZFb, 218
 deletions, 218, 219
 regions, 495
 AZFc, 218
 deletions, 218–220
 regions, 123, 495
 Azoospermia, 126, 128, 132, 135, 198, 208, 212, 213, 218–221, 229, 231, 264, 267–269, 272, 509–511, 577–584, 589–592
 Azoospermia factors, 218

B
 Bacterial orchitis, 206
 Balanced and unbalanced structural chromosomal anomalies, 217
 Balding, 95
 Bands, 309
 Barbiturates, 341
 Barr bodies, 212
 Basal body temperature, 403, 405, 408
 Basal cell naevi, 248
 Basal cells, 63, 70
 Basedow's disease, 419
 Beard growth, 51, 93, 95, 329, 331, 447
 Beckwith-Wiedemann syndrome, 496
 Behçet disease, 354
 Benign prostate hyperplasia (BPH), 48, 50, 254, 256–257, 449
 Bifurans, 374
 Bilateral congenital anorchia, 194, 195
 Bilateral obstruction of the ejaculatory ducts, 266, 272
 Bilateral testicular biopsy, 268
 Bilateral testicular tumor, 510
 Birth weight, 475, 496
 Blastocyst, 80
 Blood-brain-barrier, 39
 Blood pressure, 52
 Blood-testis barrier, 13, 16, 35, 38, 273, 369, 590
 Blow-out, 571–573
 Blunt trauma, 281, 291
 Body communication, 542, 553
 Body fat, 242, 250
 Body mass, 27, 30
 Body mass index (BMI), 241, 249, 251, 253, 351
 Body weight, 410, 416, 418, 446, 447

- Bone age, 106, 447, 452
Bone density, 50, 250, 446, 450
Bone mass, 450–451
BRCA-1, 334
BRCA-2, 334
Breast cancer, 327, 334
Breast carcinoma, 212
Bromocriptine, 413, 464
Bronchiectasis, 272–273, 344
Bronchitis, 94, 344
Buccal administration, 441
- C**
Cabergoline, 413
Cadmium, 373, 374
Caffeine intake, 430
CAG repeats, 213, 253, 324, 328, 333, 335, 447
CAG triplets, 49
CAG triplets on the androgen receptor, 256
Calcifications, 281, 282
cAMP, 287, 293, 294, 304
Cancer risk after assisted reproduction, 494–495
Capability for cohabitation, 280
Capacitation, 61, 62, 74–75, 77, 141, 143, 151, 421
Carcinogenesis, 365, 370
Carcinoma in situ (CIS), 199, 222, 227, 370, 379, 484
Carcinoma in situ of the uterine cervix, 398
Cardiac disease, 397
Carnitin, 464
Castration, 195–197
Causes of obstruction in the seminal ducts, 267
Cavernosal autoinjection, 281, 311
Cavernosal insufficiency, 289, 293, 296, 298, 309, 310, 312, 314, 315
Cavernosal occlusion mechanism, 288, 289, 293, 297, 309, 310
Cavernosography, 297–299, 312, 314
Cavernosometry, 297–299, 314
Cavernous sinusoids, 285
Cell death, 366, 367, 370, 372
Central nervous system (CNS), 30, 51
Central sheath, 72, 73
Cervical mucus, 67, 73, 74
 contact (Kremer) test, 74
 production, 403, 420
CF alleles, 268, 269
CFTR gene, 123, 124, 268–270, 272, 273, 495, 496
CFTR gene mutation, 268, 269–273, 344, 457
cGMP-dependent protein, 287
Charles Goodyear, 563
Chemiluminescence assays, 143
Chemo/radiotherapy, 345–346
Chemotaxis, 76
Chlamydia trachomatis, 132, 264–266, 420, 422–424, 430
Chlomipramine, 318
6-Chloro-6-deoxyglucose, 592, 593
Cholesterol, 40–42, 45
Chorion carcinoma of the testis, 333
Chromatin, 61, 66, 68, 76, 79
Chromatin condensation, 68
Chromosomal abnormalities, 495, 496
Chromosomal analysis, 122, 248, 496
Chromosomal anomalies, 530
Chromosomal defect, 429, 430
Chromosomal disorders, 122
Chronic abacterial prostatitis, 264
Chronic active hepatitis, 343, 352
Chronic anovulation, 414
Chronic bacterial prostatitis, 264–266
Chronic coronary heart disease, 284
Chronic epididymitis, 264, 266
Chronic hepatitis, 398
Chronic liver failure, 343
Chronic obstructive pulmonary disease (COPD), 344
Chronic opioid consumption, 354
Chronic orchitis, 206
Chronic sinobronchial disease, 272
Chronic sinusitis, 344
Cimetidine, 341, 349
Circadian rhythm, 54, 112, 116, 243
Circumcision, 266
Cirrhosis, 343, 352
Cisplatin, 229–231
Cisplatin/vinblastine/bleomycin, 345
Citric acid, 72, 132
Classification of andrological disorders, 87–92
Clinical picture and diagnosis, 264–265, 267–269, 271–274
Clitoromegaly, 327
Clofibrates, 290
Clomiphene, 335, 407, 416–418, 459, 488, 489, 493
Cloning techniques, 610
Clotting system, 449
Cluster headache, 349
Cocaine, 355, 376
Coeliac disease, 349
Cognitive and social development of the child, 530
Cohabitation, 279–318
Cohabitation problems, 280
Coital frequency, 393, 394
Coitus interruptus, 560, 563
Cold shock, 513
Colitis ulcerosa, 506
Collection of semen, 483–485
Color-coded duplex sonography, 103, 105, 297
Comet assay, 148–150
Comparative genomic hybridization (CGH), 120–122
Complete androgen insensitivity (CAI), 30, 324–327
Complete bilateral obstruction, 267
Complete phimosis, 280
Complication of autoinjection therapy, 312
Complications of assisted reproduction, 493–495
Complications of cavernosometry and cavernosography, 298
Complications of intracavernosal testing, 295
Compounds of plant origin, 590
Computer-aided sperm analysis (CASA) systems, 127, 133, 134, 140, 141, 143, 146
Computer-assisted sperm motion analysis, 476
Conceptions, 559, 563
Condoms, 561–564
Congenital adrenal hyperplasia, 101, 105, 350
Congenital bilateral absence of vas deferens (CBAVD), 65, 105, 270–273, 344, 457

- Congenital bilateral agenesis of the vas deferens, 510
 Congenital bilateral anorchia, 195
 Congenital germ cell aplasia, 207
 Congenital numerical chromosome aberration, 210
 Congenital penile deviation, 280, 282, 292
 Conservative therapy of IPP, 282
 Constitutionally delayed puberty, 437
 Contraception, 565, 566, 568, 570, 589–597
 Contraception associated protein 1 (CAP), 594, 595
 Contraceptive efficacy, 579
 Contraindications
 for autoinjection, 311
 for intracavernosal vasoactive testing, 394
 for medical therapy, 527
 Contralateral testicular tumor, 227
 Controlled, prospective, randomized and, if possible,
 double-blind clinical studies, 7
 Conventional semen analysis, 471, 476
 Cooling of the scrotal organs, 464
 Coping, 522–528
 Copy number variations (CNV), 120
 Corona radiata, 476–478
 Coronary heart disease, 242, 254, 256
 Corporal resection, 280
 Corpus cavernosum, 71, 280, 285, 288, 294, 296–299, 314
 Corpus luteum, 399, 402, 404, 405, 407, 408, 412
 Corpus spongiosum, 71
 Corticosteroids, 274, 275
 Corticosteroids for treatment of immunological
 infertility, 275
 Corticotropin-releasing hormone (CRH), 395
 Cortisol, 241
 Counselling, 523, 525, 527, 529, 534
 Couple-interview, 550
 Couples, 521–534
 Crohn's disease, 349, 397
 Cross contamination, 512, 514
 Cryoconservation, 609
 Cryopreservation, 505–518
 of oocytes, 492–493
 of oocytes in pronucleate stage, 492–493
 and sperm extraction, 156
 Cryoprotectants, 512–514
 Cryoprotective medium, 514
 Cryostorage, 340, 346, 356
 Cryptorchidism, 98, 101–103, 105, 195, 198–200, 221,
 222, 340, 452
 Cumulative pregnancy rates, 6, 9, 203, 247
 Cumulus cells, 141, 144
 Cumulus oophorus, 75–76, 476–478
 Cycliguanosine monophosphate (cGMP), 287, 303, 304, 307
 Cyclophosphamide, 367, 371
 Cyproterone acetate (CPA), 341, 514, 583–584
 Cystic fibrosis (CF), 65, 94, 268–270, 344, 495
 Cystic-fibrosis transductance regulator-gene (CFTR),
 483, 495, 496
 Cytochrome 450 aromatase, 329
 Cytochrome P450_{ssc}, 42
 Cytogenetic methods, 120–121
 Cytokines, 341, 345, 349, 352
 Cytokines (IL 6, IGF-1), 345
 Cytoplasm, 140, 142, 147
 Cytoplasmic droplets (CDs), 142
 Cytotoxic drugs, 341, 345, 352
- D**
 Danazol, 335, 426, 427
 Dapoxetine, 318
 Decapacitation factors, 75
 Deferent ducts, 99–100
 Dehydroepiandrosterone (DHEA), 115, 241, 242, 255, 439
 Dehydroepiandrosterone sulphate (DHEAS), 241, 242
 Delayed puberty, 216, 224, 340–342, 344, 349
 Deletions of the Y chromosome, 208, 217, 218
 Density gradient centrifugation, 485–487
 Depot medroxyprogesterone acetate (DMPA), 582–584
 Depressed mood, 250
 Depressions, 524
 Descending phase, 36
 Desire for a child, 522, 525, 528
 17,20-Desmolase-defect, 222
 Desogestrel, 582, 584
 Detumescence, 71
 Detumescence phase, 286
 Development, 605–607, 610
 DHEA substitution, 255
 Diabetes mellitus (DM), 212, 241, 242, 249, 250, 255,
 280, 284, 288–290, 292, 310, 311, 313, 315,
 350, 351, 569
 Diabetes mellitus type II, 242, 250, 251, 254
 Diagnosis in sexual medicine, 549–554
 Diagnostic evaluation of the cycle, 405–408
 Dibromochloropropane, 371, 373
 Diethylstilbestrol, 371, 374
 Differential diagnostic workup, 290
 Diffquik, 130
 Dignitas personae, 604, 608–610
 Digoxin, 341
 5 α -Dihydrotestosterone, 26, 33, 34, 42–44, 47, 50–53,
 115, 116, 438, 441
 Dihydrotestosterone (DHT), 244, 256, 324, 328
 γ -Diketones, 369
 Dilatations of the ejaculatory ducts, 105
 Dimension of attachment, 539–542, 551, 553
 Dimension of desire, 540–542, 546, 551
 Dimension of reproduction, 541, 546, 551
 Dimensions of sexuality, 542, 551, 553
 17 β -diol, 12, 44
 Dioxins, 374
 Di(n-butyl) phthalate, 375
 Direct intraperitoneal insemination (DIPI), 473
 Disintegrins, 78
 Disorders in sexual preference and behavior, 549
 Disorders of gender identity, 543, 546–547
 Disorders of liquefaction, 273
 Disorders of sexual behavior (dissexuality), 543, 548–549
 Disorders of sexual desire, 543
 Disorders of sexual development (DSD), 90, 323,
 543, 545–546
 Disorders of sexual maturity, 545
 Disorders of sexual orientation, 545
 Disorders of sexual partnership, 546

- Disorders of sexual preference (paraphilias), 543, 547–549
Disorders of sexual reproduction, 543, 549
Disruption of spermatogenesis, 340, 341
Dissexuality, 543, 548–549
Disturbances of lipid metabolism, 284, 288
Diurnal variations, 112
DNA, 141, 143, 144, 147–151
 demethylation, 79
 flow cytometry, 133
 fragmentation, 148, 149
 methylation, 149
 synthesis, 17, 35
DNA-binding domain, 44, 46, 47
Donor, 603, 606
 insemination, 522, 527, 531–533
 semen, 506, 511, 517
Dopamine, 411–413
Doppler sonography, 103–105
 of the penile vessels, 293, 295
 of the plexus pampiniformis, 103–105
Droplet, 142, 144
Drug history, 291
Drug-induced erectile dysfunction, 289
Drug-induced hyperprolactinemia, 341
Drugs, 341, 345, 348, 349, 352, 353, 355
Drug toxicity testing, 380
Dual energy X ray absorptiometry (DXA), 106
Dual regulation system, 33
Ductus epididymis, 324
Duplex sonography, 296–297
Duplex sonography of the cavernosal artery, 296
Duration of the spermatogenic cycle, 19
Dutasteride, 34, 341
Dynein arms, 72, 73
Dysfunction of cohabitation and ejaculation, 264
Dysfunction of the seminal vesicle, 105, 106
Dyskinetic cilia syndromes, 344
Dyspareunia, 394
Dysthymic disorders, 349
- E**
Ecstasy, 355
Ectopic testis, 98, 106
Ectopic veins, 288, 298, 314
Effects of psychotherapeutic intervention, 529
Efferent ducts, 62–66
Efficacy studies, 583, 584
Egg donation, 532
Egg-donor, 606
Ejaculate, 61, 65, 67, 69, 71–72, 74, 264–269, 271–274
Ejaculate volume, 242, 245, 246, 265, 267, 269, 446, 449
Ejaculation, 63, 69, 71, 75, 241, 242
Ejaculation disorders, 316–318
Ejaculatio praecox, 317
Ejaculatory frequency, 244
Electroejaculation, 483
Electromagnetic fields, 396
Electromagnetic radiation, 376–377
Electrophoresis, 487
Elongated spermatid injection (ELSI), 65
Embryo, 604–606, 608–611
 donation, 529, 532–533
 transfer, 477, 492
Emission, 316, 317
Emphysema, 345
Empirical therapy, 92, 458–464
Empty-sella syndrome, 412
Endocrine erectile dysfunction, 289
Endocrine functions, 522
Endocytosis, 12, 28, 40–42, 45
Endometrial biopsy, 407, 408
Endometriosis, 406, 410, 420, 422, 424–429, 471, 495
Endometrium, 403–407, 409, 410, 418, 422, 425
Endothelial nitric oxide synthase (eNOS), 287
Endothelins, 14
End-to-end anastomosis, 573
Environmental factors, 395–396, 416, 430
Enzyme defects, 222, 223
Enzyme-linked immunosorbant assays (ELISA), 110
Eosin test, 131
Epidemiology, 283–284, 288
Epidermal growth factor (EGF), 35, 36
Epididymal corpus and cauda, 269
Epididymal fluid, 592–594
Epididymal maturation, 62–71
Epididymal occlusion, 64, 70
Epididymal transport of spermatozoa, 591–592
Epididymal-blood-barrier, 38
Epididymis, 61–72, 75, 77
Epididymitis, 102, 264, 266, 568
Epididymoorchitis, 264
Epididymovasostomy, 569–573
Epilepsy, 196, 212
Epiphyseal maturity, 451, 452
Epispadias, 279–280
Epithelial cells, 127
Erectile disorders, 544
Erectile dysfunction (ED), 241, 242, 245, 249, 250, 257, 281, 283–285, 288–293, 295, 297, 299–316, 438, 539, 540, 542–544, 546, 547, 552
Erection frequency, 93
Erection phase, 286, 300
Erections, 51, 71
Erythrocyte count, 446, 448
Erythrocyte production, 52
Erythropoietin, 342
Escherichia coli, 264, 265
Escitalopram, 318
Estradiol, 26, 29, 34, 42–44, 47, 50, 52, 116, 392, 399, 400, 402, 406–408, 410, 415, 416, 418, 419, 427, 438, 444–446, 448
Estradiol (E2), 244, 250
Estrogens, 24–26, 29, 30, 34, 36, 38, 42–44, 48, 50–52
 deficiency, 329
 resistance, 329
 substitution, 256
Estrone (E1), 244
Etonogestrel, 582, 584
Eugenic aspects, 565
Eugenic mentality, 608
Eunuchoid bodily proportions, 447

- Eunuchoidism, 195, 196
 Eunuchoid tall stature, 94, 95
 Eunuchs, 196
 European Academy of Andrology (EAA), 1, 2, 123
 European Association Urology (EAU), 155, 157
 European molecular genetics quality network (EMQN), 123
 Evaluation of the ovaries, 406
 Evaluation of venous drainage, 297–299
Evangelium vitae, 604
 Evidence-based andrology, 7–9
 Evidence-based medicine, 7, 8, 458
 Evolutionary development, 541
 Ewings sarcoma, 508
 Excessively tall stature, 437, 451
 Exogenous estrogen substitution, 326, 328
 Exploration of a sexual disorder/dysfunction, 550–551
 External quality control, 134–135
 External vacuum devices, 300, 309
 Extragonadal germ cell tumor, 227
 Extratesticular metabolism of testosterone, 43–44
- F**
- Fallopian tube, 74, 75, 393, 406, 410, 419, 421–426, 429
 Fallopio, 563
 Familial mediterranean fever (FMF), 354
 Family constellations, 522, 529, 534
 Family medical history, 94
 Fas–fas–ligand system, 367
 Father–child relationship, 532
 Fear, 523–525, 527–532
 Female, 392–396, 398–400, 405, 406, 411, 412, 415, 416, 419, 421–423, 427–429
 Female partner, 266, 270, 271
 Female pronucleus, 61, 76, 79, 80
 Female sexual interest, 394
 Female-to-male transsexuals, 416
 Feminization, 231, 232
 Fertility, 2–5, 7–9, 268–271, 274
 Fertility of the aging male, 246–247
 Fertilization, 61–80, 399, 421, 422, 428, 429, 431
 Fertilizing capacity, 64–65
 FGF8, 25
 FGFR1, 25
 Fibroids and adhesions, 421
 Fibrosis incidence, 15
 Fibrous sheath, 72, 73
 Filtration, 485
 Finasteride, 34, 257, 334, 336, 341
 Findings of scrotal sonography, 105
 Fine needle aspiration, 510
 Fine needle biopsy, 268
 First pass effect, 439
 First polar body, 399
 FISH analysis, 212
 Five erectile phases, 286
 Fixation of testicular biopsies, 158
 Flagellar function, 140–141
 Flagellation, 73
 Flagellum, 19
- Flowchart for the diagnosis and principal therapeutic options for erectile dysfunction, 291
 Flow cytometry, 15, 274
 Fluorescence in-situ hybridization (FISH), 119–122, 147
 Fluorescence probes, 143
 Fluoxetine, 318
 Fluoxymesterone, 441
 Focal SCO, 457
 Follicle maturation, 399, 400, 405, 419
 Follicle selection, 399, 400
 Follicle-stimulating hormone (FSH), 21–23, 25–34, 54, 109–111, 115, 116, 244, 246, 267, 268, 272, 343, 345, 352, 392, 399, 400, 402, 410, 411, 414–419, 427
 Follicular phase, 392, 394, 402–404, 414, 415
 Foreign nationality, 524
 Fostering, 528, 533
 Four-specimen test, 264
 Fractures, 43, 50, 95, 241, 250, 251
 Fragile-X syndrome, 347
 Free testosterone, 112–115
 Frequency of coitus, 4
 Frequency of ejaculations and sexual intercourse, 447
 Friedreich, 348
 Frontal hairline, 95
 Frozen-thawed, 482, 492
 Fructose, 132, 245, 265, 267, 269, 271, 272
 FSH receptor mutation, 110, 111
 FSH receptors, 29, 30, 33, 34, 399
 Fucoidan, 77
 Fucose, 77
 Functional sterility, 589, 594
 Fusion of the labioscrotal folds, 327
- G**
- Gamete intra-fallopian transfer (GIFT), 476
 G banding, 120
 General physical functions, 551
 Genetic change, 366, 370
 Genetic counselling, 124, 270, 271
 Genetic counselling assisted reproduction, 495–496
 Genetic disease, 483, 487
 Genetic disturbances and advanced paternal age, 248–249
 Genetic mutations, 248
 Genetic risk, 517
 Genetic testing, 119, 123–124
 Gene transcripts, 150
 Genome, 119–122
 Germ cell aplasia (SCO Syndrome), 206–207
 Germ cell tumors, 227–231
 Gestagens, 578, 580–585
 Glass beads, 485
 Glasswool, 484
 Globozoospermia, 130, 208–209, 481, 482
 Glomerulonephritis, 398
 Glucocorticoids, 399, 416, 429, 430
 Glucose tolerance, 43
 α -Glucosidase, 265, 267, 269
 Glutathione, 464
 Glycerol, 506, 513
 Glycerol-egg yolk-citrate (GEYC), 513

- Glycerophosphocholine (GPC), 63, 72, 132
Glycol ethers, 371
Glycoprotein hormones, 28
Glycosylation, 27–29
GnRH-antagonists, 489, 490
GnRH-I, 24, 27
GnRH-II, 24, 27
GNRHR, 123
Golgi apparatus, 15
Golgi complex, 22, 25
Golgi phase, 19
Gonadal dysgenesis, 198, 217, 221–222, 226, 227
Gonadotropin genes, 110
Gonadotropin receptor genes, 110
Gonadotropin releasing hormone (GnRH), 22–31, 33, 437, 447
 agonists, 581
 agonist treatment, 427
 analogs, 426, 427
 down-regulation, 417
 gene, 111
 pump test, 111
 receptor, 26–28
 receptor gene, 111
 test, 111
Gonadotropins, 15, 21–35, 54, 446, 448
Gonadotropin therapy, 437
Gonorrhoea, 264, 266, 353
Gossypol, 590
GPR54, 22–26, 30, 123
Graft-*versus*-Host disease, 346
Gram-negative bacteria, 264, 265
Granulocyte elastase, 265
Granulosa and theca cells, 399
Group therapy, 528
Growth factors, 14, 15, 25, 33, 35, 36
Growth hormone (GH), 241, 255, 256
Guidelines for recording the psychosocial situation, 528
Gynec mastectomy, 335
Gynecomastia, 97, 211, 212, 214, 215, 226, 229, 231, 232, 323, 327–335, 340, 342, 343, 347, 350, 447, 448, 453
- H**
Habitual miscarriages, 122, 124
Hair, 23, 43, 48, 51
Hair patterns, 96
Hamster oocyte penetration (HOP) test/Sperm penetration assay (SPA), 145
Hamster-ovum-penetration test, 244
Haploid germ, 16, 18, 38
Hashimoto thyroiditis, 419
 β -HCG, 229
HCG and GnRH therapy, 199, 200
HCG/hMG treatment, 458, 459
Head injuries, 349
Health of the offspring after assisted fertilization, 496–497
Heat, 367, 371, 374, 377
Heat shock protein 90 (HSP 90), 47
Heavy metals, 371
Helical patterns, 20
Hematocrit, 446, 448, 449
Hematological diseases, 349–350
Hematoma, 568
Hemochromatosis, 333, 343, 344, 349
Hemodynamic factors, 285
Hemoglobin, 446, 448
Hemophilia, 350
Hepatic enzyme inducers, 341
Hepatitis, 342, 343, 352, 356
Hepatitis A, 397
Hepatitis B, 397, 398
Hepatitis C, 397
Hereditary angioedema (HAE), 354
Heterologous insemination, 534
Heterologous protocols, 603
HGH pulse frequency, 241
High density lipoprotein (HDL), 52
High ligation, 204, 205
Highly purified FSH, 459, 460
Hirsutism, 222
Histones, 68, 76, 79
HIV infections, 266
HIV-positive men, 352, 353
hMG and FSH, 417
hMG/FSH-stimulation, 416
hMG or hCG/FSH directly, 416
Hodgkin disease, 345, 346, 507, 508
Hormonal contraception, 562
Hormonal male contraception, 577–585
Hormonal stimulation
 of ovarian function, 494
 of the ovaries, 474, 477
Hormone receptor complex, 28, 47
Hormones and female sexuality, 394
Hormone therapy, 301–302
HOS test, 209
Hostile epididymal environment, 593–594
Hot flushes, 340
HPLC of DNA oxidation products, 149
Humanae vitae (1968), 604
Human chorionic gonadotropin (hCG), 28–30, 32, 33, 35, 38, 54, 480, 490, 494
Human immunodeficiency virus (HIV), 483, 487, 511, 512, 563
Human urinary gonadotropins, 489
Huntington disease (HD), 347
Hyaluronic acid (HA), 141, 144, 147
Hyaluronidase, 478, 480
Hydraulic implants, 315, 316
Hydrocele, 101, 102, 202, 205
17-Hydroxyprogesterone, 33, 42
17 β -Hydroxysteroid-dehydrogenase-defect, 222
Hyperactivated motility patterns, 140, 141
Hyperactivation, 73, 75, 140, 141
Hyperandrogenemia, 414–418, 427
Hypercortisolism, 350
Hyperestrogenism, 335
Hypergonadotropic azoospermia, 481, 484
Hypergonadotropic NOA, 155, 157, 163
Hypergonadotropic oligoasthenoteratozoospermia, 481
Hyperprolactinemia, 341, 342, 410–413, 415
Hypersecretion of LH, 430

Hypertension, 284, 353
 Hyperthyroidism, 332, 333, 335, 350, 419
 Hypertonic patients, 307
 Hypogonadism, 87, 89, 94, 95, 97, 100, 105, 210, 213, 222, 224, 228, 289, 292, 300, 437, 438, 441, 443, 444, 446–451, 453
 Hypo-osmotic swelling (HOS), 131
 Hyposmia, 96
 Hypospadias, 100, 279–280, 327–329, 332, 340, 472
 Hypospermatogenesis, 160, 161, 163, 199, 341, 347–349
 Hypothalamic amenorrhea, 410, 417, 418
 Hypothyroidism, 341, 350
 Hysterosalpingography, 410, 420, 423–425, 430
 Hysteroscopy and laparoscopy, 424

I

ICSI/IVF, 155
 Idiopathic infertility, 89, 90, 92, 393, 431, 457–465
 Idiopathic male infertility, 437, 475
 IGF-I receptors, 416
 Imidazole derivatives, 590
 Imipramin, 317
 Immotile cilia, 344
 Immotility, 127
 Immune effector cells, 70
 Immune system, 69, 70
 Immunoassays, 110–115
 Immunobead test, 132, 274
 Immunocytology, 265
 Immunofluorometric assays (IFMA), 110
 Immunological diseases, 569
 Immunological infertility, 92, 273–275
 Immunological modulation and stress, 395
 Immunoradiometric assays (IRMA), 110
 Implantation, 69, 80, 395, 407, 425, 429
 Impotentia coeundi, 472
 Inactivating FSH receptor mutations, 225
 Inactivating LH receptor mutations, 224–225
 Inactivating mutations, 30, 31, 33, 40, 43, 48, 224
 Income, 526
 Increased pregnancy rate after adoption, 395
 Increased sweat chloride concentration, 269
 Indazole-carboxylic acid derivatives, 590
 Indenopyridines, 590
 Indirect immunobead test, 132, 428
 Induced acrosome reaction, 66, 68, 74
 Infections, 264–266, 272, 274
 Infertility, 1–3, 5–9, 87, 89–92, 94, 100, 102, 103, 105, 264, 267, 271, 273–275, 340–345, 350–356
 Inflammation, 264–266
 Inflammatory bowel disease (IBD), 349, 397
 Inguinal hernias, 325
 Inguinal testis, 98, 198
 Inguino-scrotal phase of descent, 36
 Inhibin B, 23, 30, 31, 392
 Innervation, 285, 287, 291, 299, 300, 310, 317
 Insemination, 471, 488–489
 Insensitivity, 30, 44, 48
 In situ hybridization assays, 149
 In situ nick translation assays, 149
 INSL3 gene, 116

INSL3 levels, 116
 Insulin-like factor 3 (INSL3), 11, 34–37, 115–116
 Insulin-like growth factor (IGF), 400
 Insulin-like growth-factor-1 (IGF-1), 16, 35, 241, 255, 256, 400
 Insulin-like growth factor 2 (IGF 2), 400
 Insulin resistance, 251, 254, 416, 418
 Integration of somatic therapy options, 554
 Integrins, 78
 Intellectual psychomotoric development, 496
 Interdisciplinary references in sexual medicine, 540
 Interleukin-1, 19, 27
 Internal quality control, 131, 134
 International classification of diseases (ICD), 89
 International classification systems, 543, 549
 International germ cell cancer classification, 230
 International prostate symptom score (IPSS), 256, 257
 International recommendations for LOH, 438
 Intersexuality, 323
 Interstitial compartment, 11–14
 Intracavernosal pressure, 285, 286, 294, 297, 298
 Intracavernosal testing with vasoactive substances, 292–295
 Intracervical insemination (ICI), 471, 472
 Intracytoplasmic sperm injection (ICSI), 62, 65, 67, 68, 79, 155–157, 162, 163, 165, 207, 209, 214–216, 220, 268, 270–273, 275, 376, 464, 465, 471, 475, 478, 479, 481, 482, 488, 506, 508–511, 514, 516, 521, 522, 524, 530, 531, 534, 609
 Intra-fallopian transfer of zygotes (ZIFT), 477
 Intrafollicular insemination, 473–474
 Intramuscular testosterone, 442–445
 Intraoperative harvesting of sperm, 574
 Intraprostatic cysts, 105
 Intrapsychological motives, 525
 Intratesticular calcification, 105
 Intratubal insemination (ITI), 473
 Intratubular concentric microliths, 162
 Intraurethral application of prostaglandin E1, 302
 Intrauterine insemination (IUI), 275, 280, 472–473, 509, 511
 In vitro bioassays, 110, 115
 In vitro fertilization (IVF), 275, 376, 392, 396, 397, 400, 402, 405–407, 423, 424, 428–431, 471, 474–476, 508, 509, 511, 517, 518, 603, 604, 606–611
 In vitro fertilization by donor, 606
 Involuntary childlessness, 204, 212, 213, 227, 607, 611
 Ionizing radiation, 370, 372
 Iron deficiency anemia, 350
 Iron overload, 343, 344, 349, 350, 355
 Irradiation, 341, 345, 346, 348
 Isodicentric Y chromosome, 218
 Izumo, 78

J

Juvenile diabetes, 419

K

KAL1, 123
 KAL1 gene, 25
 Kallikrein, 463
 Kallmann syndrome, 25, 93, 96, 119, 123, 218
 Kartagener syndrome, 94, 209, 344
 Karyotype, 119–121, 123, 210–218, 220–222, 226, 495

- Karyotyping, 147
Kennedy disease, 46, 328, 332, 335, 347
Ketoconazole, 341, 353
Kidney stones, 398
Kinase G (PKG), 287, 303
KISS1 gene, 22, 24
Kisspeptin-GPR54 system, 22–24
Klinefelter, 156, 157, 161, 163, 165
 patients, 441, 447
 syndrome, 157, 198, 210–214, 216, 248, 331, 332, 448
Kremer test, 132
- L**
L-acetyl carnitin, 464
Lactate dehydrogenase (LDH), 229
Laron dwarfism, 16
Larynx, 51, 447
Latency phase, 286
Late-onset hypogonadism (LOH), 113, 239–258
Laurence-Moon-Biedl syndrome, 348
Lazzaro Spallanzani, 506
L-carnitine, 63, 72, 132
Lead, 366–375, 377–379
Legal castration, 196
Length of childlessness, 393
Lepromatous leprosy, 353
Leptin, 24, 25, 27, 30
Leriche syndrome, 354
Leukemia, 372, 376, 507, 508, 513
Levonorgestrel, 582, 583
Levonorgestrel implants, 583
Leydig, 324–326, 332–335
Leydig cells, 11–14, 23, 31, 34–38, 40–42, 49, 50, 53,
 54, 161, 162, 165, 324–326
 adenoma, 326, 369
 agenesis, 224
 damage, 369
 hypoplasia, 224–225
 number, 244
 tumor, 105, 225, 231, 232
Leydig, F., 12
LH to FSH ratio, 415, 416
Libido, 212, 213, 438, 446
Libido dysfunction and orgasmic disturbances, 394
Life expectancy, 196, 197, 239, 240, 558, 559
Limbic system, 541
Lipid metabolism, 449
Lipomastia, 97, 329, 332
Liposome markers, 145–146
Lisuride, 413
Liver, 24, 29, 43, 44, 49, 51
 disease, 342–344
 function, 449
 toxicity, 441, 453
Local anesthesia, 318
Local control of erection, 287
Localized or generalized fibrosis of corpora cavernosa, 312
Long-acting GnRH-agonists, 489
Long-term consequences, 493
Loss of vigor, 438
Lower social status, 524
Lower urinary tract symptoms (LUTS), 256
Low ligation, 204
LUF syndrome, 407
Lumbago, 95
Luteal phase, 398, 402, 403, 408, 410, 418
Luteal quality, 407–408
Luteinizing hormone (LH), 14, 21–35, 40, 41, 54, 109–111,
 115, 116, 243, 244, 252
 assays, 110
 pulsatility, 109
 surge 399, 402, 403, 406, 407
Lymphocytes, 162
- M**
Macroorchidism, 347
Macrophages, 14, 38, 39, 63, 70
Macroprolactin, 112
Macroprolactinemia, 112
Macrosurgical techniques, 571
Magisterium, 602, 603
Magnetic, 376, 377
Magnetic bead sorting (MACS), 487
Magnetic resonance imaging, 105, 106
Maldescended testes, 98, 197–200, 207, 215, 216, 224, 227
Male breast cancer, 334
Male climacteric, 242
Male hair pattern, 447
Male hormonal contraception, 437
Male hypogonadism, 437, 453
Male immunological infertility, 472, 481, 483
Male pseudohermaphroditism, 194, 222, 224, 225
Malignant disease, 345–346, 506, 507, 517
Malignant germ cell tumor, 227, 228, 326
Malignant ovarian tumors, 398
Mamma carcinoma, 451
Mammography, 97
Mannose, 77
Marfan syndrome, 248
Marijuana, 353, 355, 376
Marker substances, 267, 268
MAR test, 127, 131, 132, 274
Mass spectrometry (MS), 113, 114
Mast cells, 15, 35, 38, 39
Masturbation, 51, 483, 603
Maternal estrogens, 29
Maturation arrest, 160, 163
Maturation of the follicle, 406
Mechanism of action of phosphodiesterase inhibitors, 303
Median eminence (ME), 22, 25
Medical counselling, 523
Medical risk, 527
Megaloblastic anemia, 350
Megalospermatocytes, 160, 161, 163
Meiosis, 16, 18, 21, 79, 368, 370, 399
Meiosis I, 210
Meiosis II, 210
Meiotic division, 15–18, 20, 32, 35
Meiotic recombination, 370
Melatonin, 242
Melatonin substitution, 255, 256
Membrane fluidity, 68, 75

- Menstrual blood flow, 404
 Menstrual cycle, 402–409, 417, 418
 MENT implants, 583
 Mercury, 373, 374
 Mercury intoxication, 374
 Mesterolone, 461
 Mesterolone (Proviron®, Vistimon®), 441
 Metabolic syndrome, 52, 212, 213, 250–251, 344, 351
 Metagoline, 413
 Metaphase II, 399, 478–480
 Metaphase I oocytes, 480
 Metformin, 418
 Methotrexat, 509
 Methoxyacetic acid (MAA), 367, 370
 2-Methoxyethanol (ME), 370, 371
 7 α -Methyl-19-nortestosterone (MENT), 581
 Methylation of genes, 68
 Methyl testosterone, 441
 Microadenoma, 412, 413
 Micro-assisted fertilization, 477–483, 491
 Microbiological investigations, 265
 Microdeletions, 119, 121–124
 Microdeletions of the Y chromosome, 457, 495
 Microdissection techniques, 157
 Micro-epididymal sperm aspiration (MESA), 65
 Microinjection, 609
 Microlithiasis, 102, 105
 Microlithiasis testis, 102, 105
 Microphallus, 224
 Microscopic investigations of the postcoital or postmasturbatory urine, 317
 Microsurgical epididymal sperm aspiration (MESA), 155, 266, 268, 270–273, 484, 509, 510, 518
 Microsurgical techniques, 268, 270, 571, 573
 Microtubules, 72, 73, 76, 80
 Mild upper airway disease, 271
 Millennium development goals, 559
 Minimal androgen insensitivity (MAI), 328
 Minisatellites, 370
 Minor variant of cystic fibrosis, 270, 272
 Minoxidil®, 336
 Miscarriage, 247, 248
 Miscarriage and paternal age, 248
 Misuse anabolic steroids, 452–453
 Mitochondrial DNA (mtDNA), 147, 149
 Mitochondrial function, 142
 Mitosis, 17, 35
 Mitotic spindle, 61, 80
 Mixed agglutination reaction (MAR), 127
 Mixed antiglobulin reaction (MAR), 126, 131, 132
 Mixed atrophy, 160, 162
 Mixed gonadal dysgenesis, 221
 Moderate cardiovascular risk, 308
 Monitoring testosterone therapy, 446–451
 Mononuclear infiltrates, 39
 Monozygotic twinning, 492, 494
 MOPP, 369
 MOPP for Hodgkin disease, 345
 Morbus Crohn, 506
 Mortality, 239, 241, 249–251, 255, 257
 Morula, 80
 Mosaic, 121
 Motory or sensory lesions, 299
 MRI scan, 412
 Mucus penetration tests, 141
 Mucus production, 403, 422
 Muellerian ducts, 194, 195, 220, 221, 323, 328
 Muellerian inhibiting hormone (MIH), 220
 Mullerian dysgenesis, 410
 Multimorbidity, 239, 241
 Multiple lentiginos syndrome, 348
 Multiple pregnancies, 474, 489, 494
 Multiple sclerosis (MS), 348
 Multiple testicular biopsy, 157–158
 Mumps, 352
 Mumps virus, 206
 Muscle mass, 249–251, 253, 254, 446, 447, 451, 452
 Muscles, 37, 49, 50
 Mutation of the voice, 447
 Mutations, 268–273
 Myasthenia gravis, 419
 Mycoplasma spp, 264
 Myocardial infarction, 284, 307
 Myofibroblasts, 14
 Myo-inositol, 63
 Myotonic dystrophy, 332, 333, 347
- N**
 Naltrexon, 418
 Natural family planning (NFP), 562
 Natural fertilization, 71–80
 Natural testosterone, 438, 439, 442, 444, 449
 Nebido®, 443, 444, 448, 449
 Necrosis, 366
 Necrozoospermia, 482
 Negative feedback, 24, 26, 27, 31, 32
 Negative result, 293, 297, 305
 Neonatal malformations, 495, 496
 Neoplasias, 398, 413
 Nerve growth factor (NGF), 14, 35
 Nesbit technique, 282, 283
 Neurogenic erectile dysfunction, 289, 299, 313, 315
 Neuronal level, 541
 Neuronal nitric oxide synthase (nNOS), 287
 Neurophysiological investigations, 299
 Neurophysiology, 286–287
 Neurotransmitters, 14, 27
 Neutral α -glucosidase, 72, 132
 Nicotine, 395, 396, 522, 528
 Nicotine abuse, 288, 290, 307
 Nightly or morning erections, 446
 Nitric oxide (NO), 14, 51, 287
 Nitroaromatic compounds, 369
 Nitroglycerine, 295
 Nocturnal erections, 287, 289, 292, 300
 Nocturnal penile tumescence (NPT), 241
 Nonarteritic anterior ischemic optic neuropathy (NAION), 307
 Non-disjunction, 210, 211
 Non-disjunction in paternal meiosis, 216
 Non-Hodgkin lymphoma, 345, 346
 Non-lethal germ cell damage, 367, 370
 Non-progressive motility, 127
 Non-responders, 306

- Non-seminoma, 228–231
Noonan syndrome, 198, 216
Norethisterone, 582, 583
Norethisterone acetate (NETA), 582, 583
Norethisterone enanthate (NETE), 582, 583
Normal fertility, 271
19-Nortestosterone, 438, 452, 581, 583
No-scalpel approaches, 595–596
No scalpel technique, 566, 568
NO therapy, 307
No-touch techniques, 156, 157
Nuclear DNA (nDNA), 147–149
Nuclear receptors, 44, 47
Numerical chromosomal abnormality, 248
- O**
- Obesity, 344, 351, 353, 416
Obstruction of the seminal ducts, 266–269, 272
Obstructions, 264, 266–268
Obstructive azoospermia (OA), 65, 155, 157, 267–269, 272, 481, 484, 495
Occlusion of the spermatic vein, 202, 204, 205
Occupational exposure to sex steroids, 368
Onco-TESE, 510
Ontogenic regression, 340–345, 348, 351, 353, 355
Oocyte, 471, 473–482
 collection, 484, 488–491
 development, 398–399
 retrieval, 421
Opiate antagonist naltrexone, 302
Opiates, 341, 353, 376, 415, 418
Oral antidiabetic medication, 418
Oral contraceptives, 371
Oral testosterone, 439–441, 448
Oral therapy, 292, 302–308, 310, 313
Orchidopexy, 195, 199, 200
Orchitis, 194, 206, 229, 352, 353
Organ diagnostics in sexual dysfunction, 552
Organ transplantation, 506
Orgasm, 71
Orgasmic dysfunction, 543
Orgasmic phase, 241
Osteodystrophy, 342
Osteoporosis, 43, 48, 50, 54, 95, 106, 212, 450
Otitis media, 344
Ovarian cycle and ovulation, 398–419
Ovarian follicular development, 488–489
Ovarian hyperstimulation, 480, 488, 495
Ovarian hyperstimulation syndrome (OHSS), 489, 490, 493–494
Ovarian stimulation, 488–489
Ovarian torsion, 494
Ovarian wedge resection, 417
Oviductal epithelium, 140, 143
Oviduct persistence, 220–221
Ovotestes, 226
Ovotesticular disturbances, 222
Ovotesticular disturbances of sexual development (DSD), 226–227
Ovulation, 398–419
Oxytocin, 14, 33, 464
- P**
- p53-independent intrinsic mechanisms, 367
Pain during erection, 281
Palindromic sequences, 47
Palmar aponeurosis, 281
Palpation of the penis, 292
Pampiniform plexus, 37, 99, 200, 202
Pancreatic insufficiency, 269
Papanicolaou, 130, 131
Papanicolaou staining, 130, 131
Papaverine, 293–295, 302, 312
Para-aminobenzoate (Potaba®), 282
Paraphilia, 543, 547–549
Paraphimosis, 280
Parent–child bonding, 531
Parent–child relationship, 530, 531, 533
Parkinson disease, 348
Paroxetine, 318
Partial AIS (PAIS), 44, 48, 49
Partial androgen insensitivity (PAI), 324, 325, 327–328, 334, 337–338
Partial deletions, 324, 325
Partial obstructions, 267
Partial zona dissection (PZD), 477, 478, 492
Partner-related interaction, 551
Patency rates, 567, 570–573
Pathological or psychological blockade, 483
Pathophysiology, 283, 288–290
Pathophysiology of erection, 288–290
 $\Delta 4$ pathway, 40
 $\Delta 5$ pathway, 40
Patients with cavernosal insufficiency, 310, 314, 315
Patients with high risk, 308
Patients with low cardiovascular risk, 308
PDE-5, 302–308, 310, 311
PDE-5 inhibitors, 302–308, 310, 311
Pedigree, 495
Penetration, 66–68, 75–78, 80
Penetration into cervical mucus, 486
Penile alterations, 271–283
Penile deviation, 279–283, 292, 312
Penile induration, 281
Penile rehabilitation, 300, 306
Penis growth, 50
Penis size, 50
Pentoxifylline, 463, 488
Percutaneous epididymal sperm aspiration (PESA), 266, 484
Percutaneous sperm aspiration, 268, 510
Peri- and paracentric inversions, 220
Perineoscrotal hypospadias with pseudovagina (5α -reductase 2-deficiency), 328–329, 332
Periodic abstinence, 560, 562–563
Periodic interval therapy, 311
Peritubular cells (PT), 13–15, 33–35, 38, 39, 49
Pernicious anemia, 419
Pesticides, 365, 371
Peyronie's disease, 279, 281–283, 288, 309
pF508del, 268
pH and fructose concentration of the ejaculate, 271, 272
Pharmacocavernosography, 297, 314
Pharmacology of testosterone, 439–446
Phentolamine, 294, 295, 302, 312

- Philosophical motives, 525
 Phimosis, 100
 Phosphate diesterases, 287
 Phosphodiesterase inhibitors, 303, 304
 Phthalates, 369
 Physical impairments, 530
 Physiology, 283, 285–287, 301
 Physiology of erection, 285–290
 Pick adenoma, 326
 Pituitary adenomas, 112, 410–413
 Pituitary gland, 11, 22, 23, 25, 26, 28, 29
 Pituitary or hypothalamus, 105
 Pituitary siderosis, 350
 Placebo-effect, 8
 Placental alkaline phosphatase (PLAP), 229
 Placentation, 80
 Plateau phase, 241
 Polyarteritis nodosa, 352
 Polychlorinated biphenyls, 368, 374
 Polycystic degeneration of the kidneys, 398
 Polycystic ovarian disease, 413–418, 430, 495
 Polycystic ovarian syndrome, 410
 Polycystic ovary (PCO), 406, 414, 415, 431
 Polycythemia, 254
 Polymorphism of the androgen receptor CAG repeats, 96
 Polymorphisms of the androgen receptor, 213
 Polyorchidism, 197
 Polyploidy, 79
 Polyposis coli, 248
 Polyspermy, 76, 79
 Polyvinylpyrrolidone (PVP), 479, 486, 488
 Pope John Paul II, 603, 604
 Pope John Paul VI, 604
 Population growth, 557–559
 Portacaval shunting, 343
 Postcoital test, 132
 Postgraduate education, 540
 Postnatal disorders, 549–554
 Postoperative semen analysis, 567, 569
 Post-thaw motility, 508, 510
 Potency, 212
 Prader-Labhart-Willi syndrome, 348, 496
 Prader orchidometer, 98
 Precocious epiphyseal closure, 50
 Precocious menopause, 419
 Precocious pseudopuberty, 231
 Preconceptional disorders, 549
 Predisposing illnesses, 290
 Pregnancy loss, 429–431
 Pregnancy rates, 64, 66, 68, 69, 392, 395, 421, 423, 427, 458–464, 510, 513, 517
 Pregnenolone, 33, 40–42
 Preimplantation diagnosis (PGD), 609, 610
 Premature ejaculation, 292, 317–318, 544
 Prenatal adoption, 532
 Prenatal diagnosis, 270
 Prenatal disorders, 549
 Preparation of sperm, 485
 Prevalence of idiopathic varicocele, 201
 Prevalence of infertility, 5–7
 Prevalence of paraphilia-associated sexual arousal, 548
 Preventive treatment, 91
 Priapism, 289, 294, 295, 302, 309, 311, 312, 314, 315
 Primary amenorrhoea, 222
 Primary erectile dysfunction, 288, 292, 297, 309, 314
 Primary hypogonadism, 109, 115
 Primary hypothyroidism, 411
 Primary ovarian failure, 411, 418–419
 Principal cells, 63
 Proacrosin, 77
 Processing of sperm, 488
 Profound inhibition, 341, 351
 Progesterone, 24–27, 33, 34, 40, 42, 44, 47, 490
 levels, 407–408
 and pregnenolone, 33, 42
 secretion, 402, 403
 Progestins, 422, 426
 Progressive sperm motility, 127, 244
 Prokineticin 2 (PK2), 25
 Prolactin, 111–112, 244
 Prolactinoma, 411–413
 Prolactin-secreting adenomas, 412
 Prolonged erections, 294, 295, 312
 Pronucleate-stage oocyte transfer (PROST), 477
 Pronucleus, 61, 76, 79–80
 Propicia®, 336
 Prostaglandin E1 (PGE1), 306
 Prostaglandins, 14, 15, 132
 Prostanoids, 287, 294
 Prostate, 42–44, 46, 48–50, 53, 100, 105, 106, 325, 328, 336
 cancer, 244, 254, 256, 257
 carcinoma, 195, 196, 449, 451, 569, 570
 hypertrophy, 336
 volume, 105, 106, 449, 450
 Prostate specific antigen (PSA), 71, 72, 254, 256, 257, 446, 449, 450, 452
 Prostatic function, 132
 Prostatitis, 264–266, 272
 Prostatovesiculitis, 265
 Prosthesis surgery, 315–316
 Protamines, 68, 76, 79
 Protein synthesis, 15, 51
 Proteolytic enzymes, 483
 Pseudo-gynecomastia, 329, 332
 Psoriasis, 354
 Psychic stress, 533
 Psychoanalysis, 523
 Psychogenic erectile dysfunction, 287, 289, 300–302
 Psychogenic fertility disturbance, 527
 Psychogenic infertility, 522
 Psychological conditions of unwanted childlessness, 522–523
 Psychological effects of unwanted childlessness, 522–523
 Psychological social development, 532
 Psychological stress, 522, 523
 Psychological treatment, 300–301
 Psychosexual evaluation, 292
 Psychosocial consultation, 527–528, 534
 Psychosomatic complaints, 524, 525, 528
 Psychotherapeutic intervention, 522, 528–529
 Pubertal gynecomastia, 331
 Pubic hair, 51
 Pubic hairline, 95

- Pulmonary embolism, 212
Pulmonary tuberculosis, 397
Pulsatile GnRH, 416–418, 459
Pulsatile GnRH treatment, 416–418
Pulsatile LH secretion, 341–343
Pulsatile nature of GnRH secretion, 26
Pulsatile secretion of gonadotropins, 30
Pulsatility of pituitary secretion, 109
Pure gonadal dysgenesis, 221, 222
Pyelonephritis, 398
- Q**
Q-PCR, 149
Quality, 471, 478, 480–482, 489
Quality control, 131, 134–135
Quality control of semen analysis, 511
Quality of life, 451
Quantitative ultrasound, 106
- R**
Radiation, 367–373, 376–377, 382, 383
Radical prostatectomy, 345
Radioactivity, 396
Rate of conception, 393, 423
Rational therapies, 91
Reactive oxygen species (ROS), 142–143, 463
Rebound effect, 462
Recanalization, 568, 569
Receptor, 242, 251, 253, 256–258
 α -Receptor blocking agents, 463
Reciprocal translocations, 217, 218, 220
Recombinant FSH, 459
Recombinant growth hormone, 464
Recombinant zono proteins, 145
Re-counselling, 305, 306
Recreational drugs, 355
Reduced body weight, 418
Reduced libido, 250, 253
Reduced muscle mass, 250
5 α -Reductase, 34, 43, 44, 48, 50, 51, 53, 116
5 α -Reductase activity, 34, 50, 51
5 α -Reduction, 43
Refertilization vasovasostomy, 570
Reflexogenic, 286, 287, 289
Refractory phase, 241
Registration, evaluation, authorisation and restriction
of chemical substances (REACH), 365, 366, 381
Reifenstein syndrome, 327, 332
Relative phimosis, 280
Removal of contaminant infectious particles, 487–480
Renal anomalies, 270
Renal disease, 341–342
Renal failure, 342
Renal transplantation, 342, 398
Renal ultrasound, 271
Repair of non-genetic damage, 368
Reproductive and genetic toxicity, 365
Reproductive dimension, 540, 541, 549
Reproductive health, 1–3, 560
Research cloning, 610
Residual body (RB), 13, 17–19, 32
Respiratory diseases, 344–345
Respiratory system, 94
Retinitis pigmentosa, 307
Retinoic acid receptor antagonists, 590
Retractile testis, 98, 198
Retrograde ejaculation, 231, 280, 317, 472, 484, 507, 509
Retroperitoneal lymphadenectomy, 230, 231
Revascularization Surgery, 314–315
Reversible inhibition of sperm under guidance
(RISUG), 596
Rheumatic arthritis, 506
Rheumatoid arthritis, 352
Rigidity measurements, 300
Rigidity phase, 286
Rings, 308, 309
Risk of cross-contamination, 512
Robertsonian translocations, 220
Rokitansky-Küster-Hauser syndrome, 410
Round cells, 127, 130–133
Round spermatid injection (ROSI), 65
Round spermatid nucleus injection (ROSNi), 65
Round spermatids, 482
- S**
Saliva, 115
Salpingitis, 422–423
Sarcoidosis, 344
Satellite DNA, 120
Sclerosing of the spermatic vein, 205
Score count evaluation, 162–165
Scrotal cooling, 69
Scrotal heating, 590
Scrotal palpation, 269
Scrotal temperature, 200
Scrotal ultrasonography, 101–103
Sebum production, 49, 50
Secondary erectile dysfunction, 292
Secondary hair and beard growth, 213
Secondary hypogonadism, 109, 341, 342, 350
Secondary oocyte, 399
Second meiotic division, 18
Second polar body, 61, 76, 79, 399
Seeding, 513
Selective abortion, 531
Selective androgen receptor modulators (SARMs), 48
Selective serotonin re-uptake inhibitors, 318
Self-injection therapy, 293, 305–308, 310–313
Semen analysis, 125–137, 476
Semen characteristics, 481
Semen donation, 471, 482–483
Semenogelin I, 71
Semen volume, 126–128, 131
Seminal ducts, 263–275
Seminal emission, 589, 591, 592, 595–596
Seminal vesicles, 71, 72, 75, 105, 106, 127, 132, 265–267,
269, 270, 272, 324
Seminiferous tubules, 11, 14–16, 19, 20, 23, 34, 35, 37,
38, 156–159, 161, 162
Seminomas, 39, 105, 106, 199, 222, 227–231, 345
Senescent gynecomastia, 331
Sertaline, 318

- Sertoli cell-germ cell interactions, 35
 Sertoli cell-only syndrome (SCOS), 155, 157, 160, 161, 207, 219, 510
 Sertoli cells, 13–16, 19, 20, 23, 30, 33–36, 38, 42, 49, 62, 156, 159–163, 332, 325, 366–370, 374
 adenomas, 326
 tumors, 333
 Severe male infertility, 479
 Sex determining gene on the Y chromosome (SRY), 52
 Sex determining region Y (SRY), 194, 215, 217, 221, 226
 Sex hormone binding globulin (SHBG), 29, 34, 42–44, 50–52, 54, 112–115, 242–244, 252, 292, 325, 331, 333, 341–343, 345, 348–351, 415–417, 427, 446, 448, 449
 Sexological competence, 540
 Sexological consultation, 553
 Sexological therapy, 542, 552–554
 Sexual appetite, 446
 Sexual differentiation, 30, 52–54
 Sexual dimorphism, 51, 52
 Sexual disorders, 540–547, 549, 551–553
 Sexual disturbances, 527
 Sexual dysfunction, 339, 342–345, 348, 350, 356, 542–544, 546, 550, 552, 554
 Sexual functions, 539, 550, 551
 Sexual identity disorders, 545–546
 Sexual intercourse, 241
 Sexuality, 524, 525–528
 Sexuality in senescence, 240–241
 Sexually transmitted diseases (STD), 265, 266, 353
 Sexual phantasies, 51
 Sexual preference structure, 545, 547, 550
 Sexual response, 240
 Sexual therapy, 542, 546, 553–554
 SHBG test, 325
 Shorr, 130
 Short tandem repeats (STRs), 44, 46
 Sickle cell anemia, 350
 Side effects of PDE-5 inhibitors, 307
 Sildenafil, 303–305, 307
 Silver-Russell syndrome, 496
 Simultaneous ensoulment, 604
 Single-embryo-transfer (SET), 608, 609
 Single nucleotide polymorphisms (SNP), 120
 Sinusitis, 94
 Sitting dwarfs, 95
 Six stages of spermatogenesis, Clermont, 159
 Skin, 37, 43, 49, 50, 53
 Sleep apnea, 344
 Sleeping sickness, 353
 Smoking, 355, 374–376, 396, 430
 So-called adrenal rest tumors, 101, 105
 Social control, 565
 Social situation, 528
 Socio-cultural castration, 196–197
 Socio-cultural motives, 525
 Solvents, 369, 371
 Somatosensory innervation, 285, 299
 Sorting of spermatozoa, 487
 Specific androgen receptor agonists (SARMS), 258
 Spectral karyotyping FISH (SKY), 121
 Spectrum of sexual disorders, 540–547
 Sperm, 603, 606, 609
 Sperm agglutination, 127, 131, 274
 Sperm antibodies, 127, 131, 132, 134, 428–429, 569
 Sperm antibody tests, 428
 Spermatids, 13, 16–21
 Spermatocoele, 99, 102, 105
 Spermatocytes, 13, 16–18, 21, 32, 35, 38
 Spermatogenesis, 11, 14–21, 30–35, 37–39, 49, 155–165, 199, 208
 Spermatogenic arrest, 199, 207–208
 Spermatogenic cycle, 13, 15, 17, 19, 33, 340, 355
 Spermatogenic efficiency index, 21
 Spermatogenic failure, 457
 Spermatogenic suppression, 32
 Spermatogenic wave, 19, 20
 Spermatogonia, 13, 15–17, 20, 21, 32, 37, 38, 366, 368–370, 372, 373
 Spermatogoniogenesis, 16
 Spermatozoa, 482
 Sperm centrosome, 146–147
 Sperm chromatin dispersion assay (SCD)/Sperm dispersion assay (SDA), 148
 Sperm chromatin sensitivity assay (SCSA), 148, 150
 Sperm concentration, 127, 128, 131, 133, 134, 242, 244, 246, 529
 Sperm deposition
 Sperm function tests, 244
 Sperm glycolysis, 594
 Sperm granuloma, 569, 571
 Spermiation, 16, 19, 32, 159, 160
 Spermicides, 596
 Spermiogenesis, 16, 19, 32, 34
 Sperm morphology, 126, 130–131, 134
 Sperm motility, 126, 127, 133–134, 507, 508, 512, 514–516
 Sperm-mucus-interaction, 274
 Sperm numbers, 125, 126, 128–129
 Sperm production, 15, 16, 21, 35
 Sperm proteomics, 150–151
 Sperm rebound, 580
 Sperm RNA, 150, 151
 Sperm selection, 487
 Sperm transport, 371, 421, 422
 Sperm-vitellus recognition, 68
 Sperm volume regulation, 594–595
 Spinal cord damage, 348
 Spironolactone, 341, 353
 Spontaneous acrosome reactions, 68, 76
 Spontaneous conception, 471
 Spontaneous conception rate, 474
 Squeeze technique, 318
 SRY gene, 194, 217, 221, 323
 SRY HMG-box-related gene 9 (SOX-9), 52
 SRY-positive men, 215
 Staging, 229
 Staging of endometriosis, 426
 Standing giants, 95
 Stanazolol, 325
 Stem cell, 12, 13, 16–18, 32, 33, 35, 36, 52, 610
 Steps of fertilization, 480
 Stepwise therapeutic plan, 308

- Sterility, 3
Sterilization for eugenic reasons, 565
Steroidogenesis, 11, 14, 22, 35, 40, 41
Steroidogenic acute regulatory protein (StAR), 40, 41
Steroid sulphatase deficiency, 348
Steroid synthesis, 15, 40
Stopper genes, 610
Storage capacity, 69
Stress, 394–395, 411, 415
Stress-induced infertility, 523
Stress theory of infertility, 522
Structural abnormalities of the autosomes, 220
Structural chromosomal aberrations, 216, 217
Structural chromosomal abnormalities, 248
Structural chromosomal anomalies, 517
Structural sperm defects, 208–209
Subfertility, 3
Sub-lethal cell damage, 366
Subnormal volume, 272
Substitute acts, 548
 α Subunit, 28, 35
Subzonal sperm injection (SUZI), 477, 478
Successive ensoulment, 605
Sugar residues, 28, 29
Summit meetings of male contraception, 585
Supernumerary testes, 197
Suppression of FSH, 32
Surgical ablation, 228
Surgical correction, 313
Surgical management, 272
Surgical reconstruction, 270
Surgical therapy of penis deviations, 282–283
Surgical treatment, 300, 313–316
Surplus embryos, 494
Surrogate motherhood, 607
Swim-up, 485–486
Swim-up or centrifugation on density gradients, 513
Swyer syndrome, 221
Sympathomimetic substances, 317
Symptomatic therapy, 91
Symptom-specific threshold levels, 438
9 + 0 Syndrome, 209
Syndyastic sexual therapy, 542–554
Synthesis of androgens, 40–42, 48
Systemic lupus erythematosus, 352
- T**
Tadalafil, 304–307
Tamoxifen, 335, 416, 417, 459, 460, 463
Tandem CAG, 347
Task force for the regulation of male fertility, 585
Teaching communicative strategies, 553
Tea seed oil, 579
Temperature regulation, 37
Temporal hair recession, 95
Temporal lobe epilepsy, 348
Teratogenesis, 365, 383
Teratomas, 333, 345
4-Tert-octylphenol, 375
TESE/ICSI, 163, 165, 207, 215
Testicular androgens, 34, 39–54
Testicular biopsy, 155–165, 207, 208, 213, 219, 220, 224, 228, 229, 268, 269
Testicular cancer, 484
Testicular descent, 36–37
Testicular dysgenesis syndrome, 375, 379
Testicular ectopy, 198
Testicular fine needle aspiration (TEFNA), 156, 157, 484
Testicular function, 339, 341, 342, 346–352, 354, 355
Testicular intraepithelial neoptasia (TIN), 102, 155–158, 161–163, 227–229, 510
Testicular macrophages, 38, 39
Testicular maldescent, 93
Testicular sperm extraction (TESE), 65, 102, 155–157, 162, 163, 165, 268, 270–273, 484, 507, 509, 510
Testicular stem cells, 13, 17, 18, 32
Testicular temperature, 37
Testicular testosterone concentrations, 32, 34, 38
Testicular tissue, 482
Testicular tumor, 97, 98, 101–103, 199, 206, 227, 229, 231, 327, 507, 508, 510, 513
Testicular volume, 12, 14–16, 98, 101, 102, 242, 244, 267, 268
Testim[®], 443, 445
Testocaps[®], 439, 443
Testogel[®], 443, 445
Testolactone, 459, 460
Testopatch[®], 443, 445, 448
Testosterone, 11, 12, 14, 23, 26, 29–35, 38–40, 42–44, 47, 49–54, 241–244, 246, 249–256, 287, 289, 292, 301, 306, 324–329, 331, 333–335, 414–416, 427
 bioactivity, 114
 deficiency, 339, 342, 351, 438, 451
 depot, 442
 gels, 439, 445
 implants, 439, 445–446
 levels, 109, 113–115
 patches, 444–445
 pellets, 581, 583, 584
 preparations, 438–446, 449, 453
 production, 242, 243, 246, 255
 replacement therapy, 342, 343, 348, 351, 353
 substitution, 250, 251, 253–255, 438, 439, 446–451
 therapy, 437–453
Testosterone buciclate, 579
Testosterone cyclohexanecarboxylate, 442
Testosterone cypionate, 442
Testosterone/DHT ratio, 329
Testosterone enanthate, 439, 442–444, 447–449, 451, 578–579, 581, 583, 584
Testosterone propionate (Testoviron[®]), 442–443
Testosterone undecanoate, 439–444, 447–449, 460–463, 579–581, 583–585
Testosterone undecanoate (Andriol[®]), 448
Testosterone undecanoate (Nebido[®]), 443, 448, 449
Testosterone undecanoate plus tamoxifen, 460
Testoviron[®], 442, 443
Testoviron[®] depot 250mg, 442
 β -Thalassemia, 349, 350
Theories of aging, 240
Therapeutic cloning, 610
Therapeutic procedures, 522, 526–534

- Therapist-couple relationship, 552
 Therapy, 266, 268–271, 273–275
 Thermoregulatory systems, 37
 Thyrotropin releasing hormone (TRH), 111–112
 Thyroid cancer, 346, 350
 Thyroid diseases, 242, 350
 Thyroid stimulating hormone (TSH), 27, 28
 Thyrotropin releasing hormone (TRH), 411
 Tight junctional complexes, 63, 70
 Tight junctions, 15, 16, 38
 Time to pregnancy (TTP), 4, 6, 135, 137, 247, 373–375, 377, 379, 381, 382
 Timing of coitus, 4
 TIN cells, 158, 162
 Topical therapy, 302
 Total body irradiation (TBI), 346
 Toxoplasmosis, 352, 353
 Tramadolol, 318
 Tranquilizers, 290
 Transabdominal phase of descent, 36
 Transdermal dihydrotestosterone, 445
 Transdermal testosterone, 342, 355, 439, 442, 444, 445, 448
 patches, 445
 substitution, 254
 Transforming growth factor (TGF), 35
 Transforming growth factor (TGF) β gene, 400
 Transient biochemical androgen deficiency, 341
 Translocations, 208, 215–218, 220
 Transport of spermatozoa, 69
 Transrectal electrostimulation, 317
 Transrectal sonography of the prostate, 106, 317
 Transrectal ultrasonography (TRUS), 446, 449
 Transrectal ultrasonography of the seminal vesicles, 105
 Transrectal ultrasound, 269, 272
 Trans-scrotal therapeutic system (Testoderm®), 444
 Transsexuality, 546
 Transurethral resection, 268
 Trazodone, 302
 Triple drug therapy, 294
 Triplet repeats, 347
 Triplets, 526, 530, 531
 Tripterygium, 590
 Trisomy 21 (Morbus Down), 248
 Troglitazone, 418
 True hermaphroditism, 222, 226, 227
 Tubal ciliary movement, 422
 Tubal embryo transfer (TET), 476, 477
 Tubal insufflation, 423
 Tubal ligation, 566, 568, 569
 Tuberculosis, 353
 Tubular hyalinization, 161
 Tubular shadows, 160–162
 Tumescence phase, 286
 Tumor patients, 482
 TUNEL, 149, 150
 Turner syndrome, 216, 217, 221, 248, 409, 419
 Twins, 522, 526, 530, 531
 Two-cell-theory, 399, 400
 Two-embryo transfer, 609
 Type 2 diabetes mellitus, 250, 251, 254
 Type 5, 287, 304, 307
- U**
 Ulcerative colitis, 349, 397
 Ulcerative disease, 398
 Ultrasonography, 264, 267
 Ultrasound, 282, 295–297, 405–407, 414, 416, 417, 424, 429, 430
 Ultrasound-guided transvaginal puncture of the follicles, 490
 Unexplained infertility, 476
 Unilateral absence of the vas deferens, 271–272
 Unilateral maldescent, 198
 Unilateral obstruction, 267
 Unilateral orchidectomy, 345
 Unwanted childlessness, 521–524, 527
 Upper pubic hairline, 95
 Ureaplasma urealyticum, 132, 264–266
 Uremia, 342
 Urethral swab, 265
 Urethritis, 264, 265
 Urinary tract anomalies, 271, 272
 Urogenital sinus, 327
 Use of assisted reproduction in various countries, 470
 Use of cryopreserved samples, 515–516
 Uterine anomalies, 421, 430
 Uterine peristalsis, 74
 Uterine placement of embryos, 492
 Uterotubal junction, 74
- V**
 Vaccination against mumps, 206
 Vaginismus, 394
 Valsalva maneuver, 101, 103, 105, 202, 204
 Vardenafil, 304, 305, 307
 Variable numbers of tandem repeats (VNTR), 120
 Varicocele grade I, 202
 Varicocele grade II, 202
 Varicocele grade III, 202
 Varicocele in adolescence, 205–206
 Varicoceles, 37, 92, 99, 101, 103, 105, 200–206, 229, 246, 331
 Varicosis, 212
 Vasa deferentia, 324
 Vasculogenic erectile dysfunction, 288
 Vasectomy, 273, 506, 507, 557, 560–562, 565–575
 Vasoactive intestinal peptide (VIP), 411
 Vasoepidymostomy (vasotubulostomy), 268, 507
 Vasotubulostomy, 155
 Vasovasostomy, 155, 268, 506–507, 570–573
 Veins, 285, 286, 288, 297, 298, 314, 315
 Venous surgery, 314
 Vesiculitis, 264, 265
 Vincristine, 509
 Viral orchitis, 206
 Virilization, 211, 221, 222, 224, 226, 324, 328–331, 340, 445, 452, 453
 Visceral fat, 250, 251, 254
 Vitamin E, 464
 Vitelline block to polyspermy, 76, 79
 Vitiligo, 419
 Vitrification, 514
 Voice mutation, 93, 95

W

Wolffian ducts, 50, 53, 194, 195, 324
World Bank, 559
World Health Organisation (WHO), 1, 2, 5, 8, 559, 560, 563, 578, 579, 583–585
World population, 557–560
Wound infections, 568

X

X chromosome, 210, 212, 215, 218
Xenoestrogens, 374, 375, 381
X-linked spinal and bulbar muscular atrophy (SBMA), 328, 333
X-rays, 281, 282, 371, 396
XX male syndrome, 214–215, 331
XX men, 198, 214, 215, 226
46, XY disorders of sexual development (DSD), 222–224
XYY syndrome, 216

Y

Y chromosome, 194, 207, 208, 210, 215, 217–220, 222, 226
Y chromosome microdeletions, 207, 218–220
Yohimbine, 302
Young syndrome, 266, 272–273, 344

Z

Zinc, 71, 72, 132, 265, 268
 fingers, 47
 supplementation, 342
Zona binding, 67, 75, 77
Zona binding tests, 143–144
Zona block to polyspermy, 76, 79
Zona drilling, 477, 478, 492
Zona-induced acrosome reaction, 145
Zona pellucida, 67, 74–77, 80, 492, 494
Zona pellucida-induced acrosome reaction (ZPIAR), 141, 144, 145
Zona penetration, 68, 77, 78
Zona penetration test, 144
Zona-preferred spermatozoa, 130
Zygote, 61, 79, 80, 421, 422, 425
Zygote intra-fallopian transfer (ZIFT), 476