



# AAiT

Addis Ababa Institute of Technology  
አዲስ አበባ ቴክኖሎጂ ስኬት-ቴክኖሎጂ  
Addis Ababa University  
አዲስ አበባ ዩኒቨርሲቲ

# SCHOOL OF CIVIL AND ENVIROMENTAL ENGINEERING

## Transport Engineering CENG 3201



## Chapter 5 Traffic Control

Tamru T.



JPG Preview

service@clipartof.co

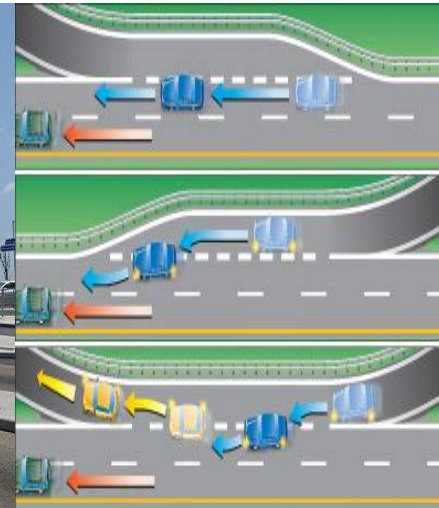

www.clipartof.com/56390

No Free Use Allowed





# Lecture Overview

## Traffic Control

---

- Traffic markings
  - Longitudinal markings
  - Transverse markings
  - Object markers and delineator
- Traffic signs
  - Regulatory signs.
  - Warning signs.
  - Guide signs.
- Traffic signals
  - Signal Timing Design- Webster method





# Traffic Controls

---

- Traffic control devices are the media by which traffic engineers communicate with drivers.
- Traffic Control devices broad categorized to three
  - Traffic markings
  - Traffic signs
  - Traffic signals



# Traffic Controls Cont...

---

➤ Traffic control messages are conveyed through

❖ Color

❖ Shape

❖ Pattern

❖ Legend





# Traffic Markings

---

- Markings are applied to the roadway surface using a variety of materials, the most common of which are paint and thermoplastic.
  - ✓ Longitudinal markings
  - ✓ Transverse markings
  - ✓ Object markers and delineators





# Traffic Markings Cont...

---

## *Longitudinal markings*

- Are those markings placed parallel to the direction of travel.
- Provide guidance for the placement of vehicles on the traveled way cross-section and basic trajectory guidance for vehicles traveling along the facility.
  - Centerlines,
  - Lane lines, and
  - Pavement edge lines
  - Warning lines



# Traffic Markings Cont..

## Centre line

- Separates the opposing streams of traffic and facilitates their movements. Are those markings placed parallel to the direction of travel.
- May be marked with either single broken line, single solid line, double broken line, or double solid line depending upon the road and traffic requirements.

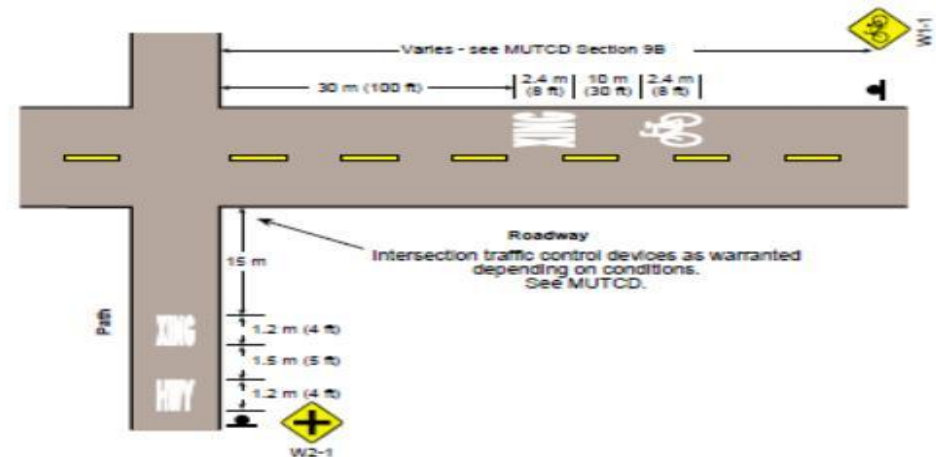
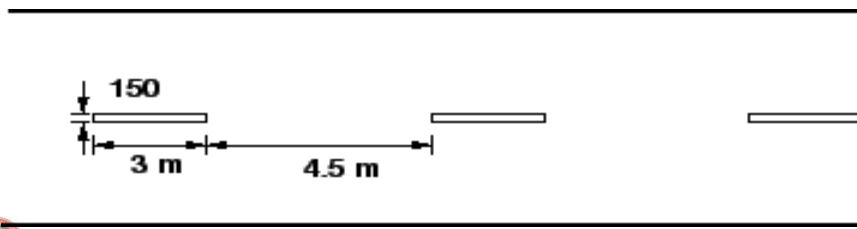

**AAiT**

Addis Ababa Institute of Technology  
አዲስ አበባ ተቴክኖሎጂ ስራተኞች  
Addis Ababa University  
አዲስ አበባ ዩኒቨርሲቲ

# Traffic Markings Cont...

## *Lane Markings*

- Is a single white dashed line separating lanes of traffic in the same direction.
- MUTCD (Manual on Uniform Traffic Control Devices) standards require the use of lane markings on all free-ways and Interstate highways and recommend their use on all highways with two or more adjacent traffic lanes in a single direction.

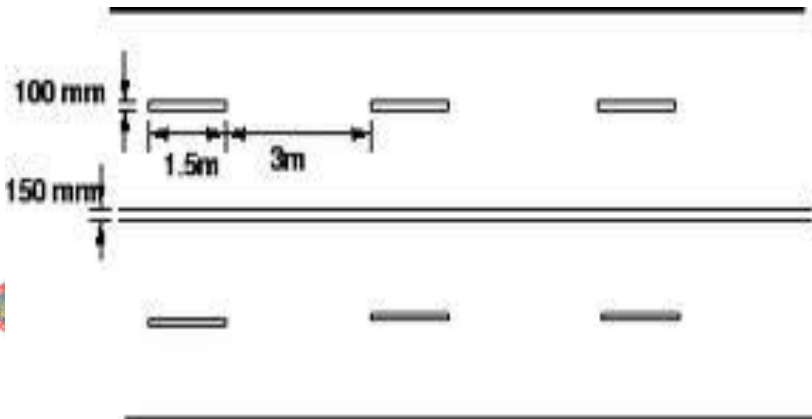



# Traffic Markings Cont...

## *Edge Markings*

- Indicate edges of rural roads which have no curbs to delineate the limits up to which the driver can safely venture.
- Should be preferably light reflective, so that they will be visible during night also.



# Traffic Markings Cont...

## *Warning lines*

- Warn the drivers about the obstruction approaches.
- Are marked on horizontal and vertical curves

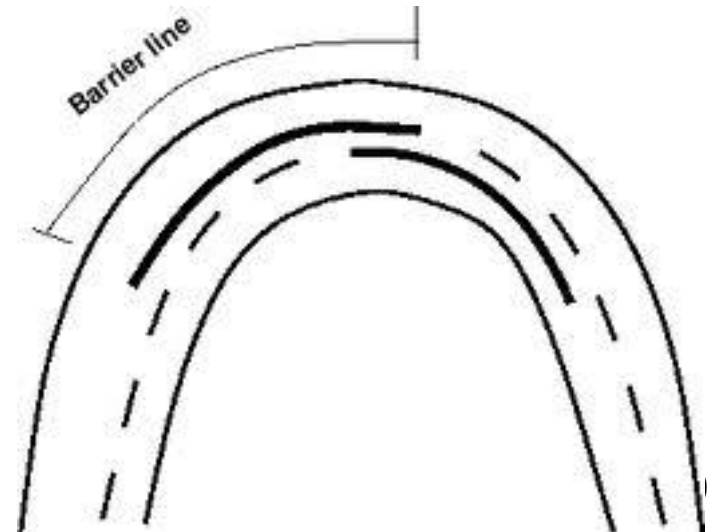



# Traffic Markings Cont...

---

## *Transverse Markings*

- Any and all markings with a component that cuts across a portion or all of the traveled way.
- All transverse markings are
  - Crosswalk Markings
  - Parking Space Markings
  - Directional arrows
  - Word and Symbol Markings



# Traffic Markings Cont...

## *Crosswalk Markings*

- It is recommended that crosswalks be marked at all intersections with "substantial" conflict between vehicles and pedestrian exists.



AA

Addis Ababa Institute  
የአዲስ አበባ ኮሌግ  
Addis Ababa University  
የአዲስ አበባ ዩኒቨርሲቲ





# Traffic Markings Cont.

## *Directional arrows*

- Used to guide the drivers in advance over the correct lane to be taken while approaching busy intersections.

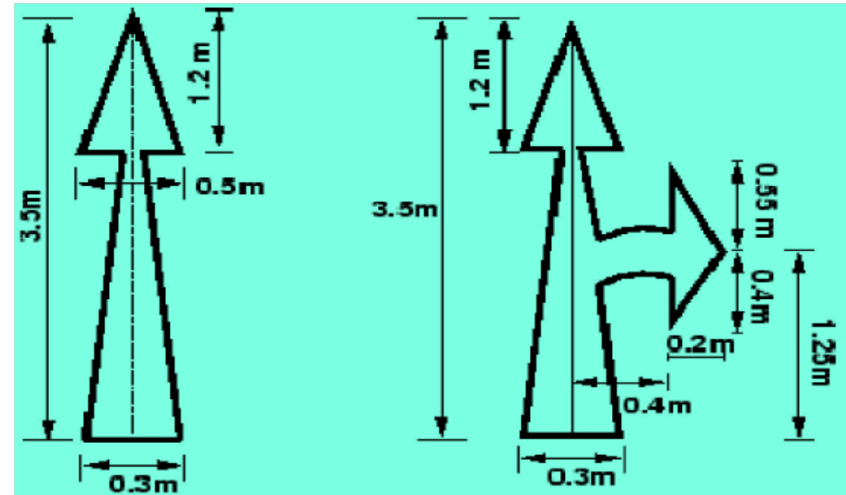

# Traffic Markings Cont...

## *Word and Symbol Markings*

- Word markings include "ONLY" used in conjunction with lane use arrows, "SLOW", and "STOP" which can be used only in conjunction with a STOP line and a STOP sign.





# Traffic Markings Cont...

## Object Markers

- Are used to denote obstructions either or adjacent to the traveled way.

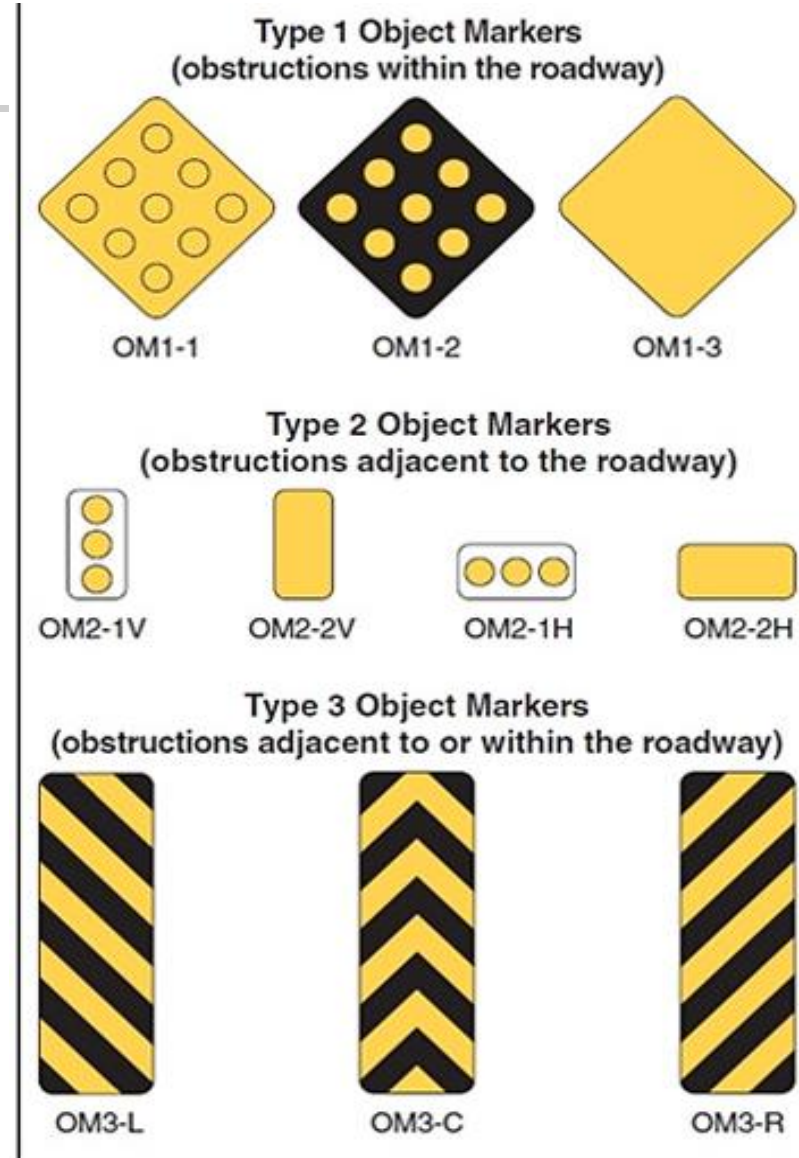

**AAiT**

Addis Ababa Institute of Technology  
አዲስ አበባ ቴክኖሎጂ ኢንስቲትዩት  
Addis Ababa University  
አዲስ አበባ ዩኒቨርሲቲ



# Traffic Signs

- Regulatory signs.



- ✓ Warning signs.

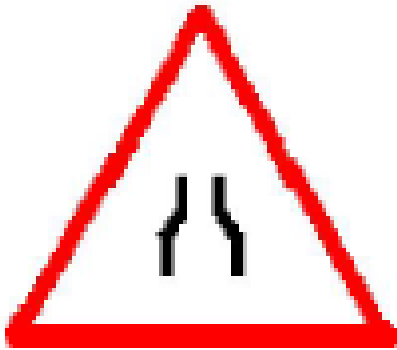

- Guide signs.

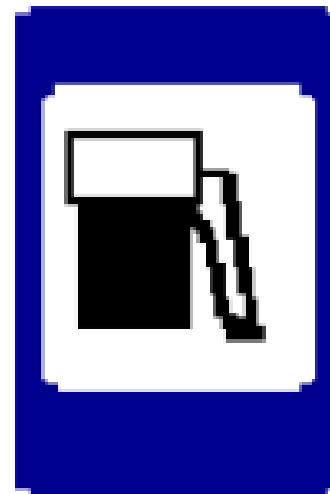

# Traffic Signs Cont...

## *Regulatory signs*

- Shall be used to inform road users of selected traffic laws or regulations and indicate the applicability of the legal requirements.
- Regulations may relate to right-of-way, speed limits, lane usage, parking, or a variety of other functions.
  - Right of way series
  - Speed series
  - Movement series
  - Parking series
  - Miscellaneous
  - Pedestrian series



# Traffic Signs Cont...

## *Warning Signs*

- Call attention to unexpected conditions on or adjacent to a highway or street and to situations that might not be readily apparent to road users.
- Most warning signs are diamond-shaped, with black lettering or symbols on a yellow background.

- Changes in horizontal alignment
- Intersections
- Advance warning of control d
- Converging traffic lanes
- Narrow roadways
- Changes in highway design
- Grades
- Roadway surface conditions
- Railroad crossings

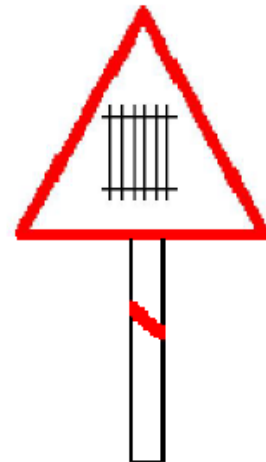

# Traffic Signs Cont...

## *Guide/Informative/ Signs*

- Provide information to road users concerning destinations, available services, and historical/recreational facilities.
- Familiar or regular users of a route will generally not need to use them.
- Clarity and consistency of message is the most important aspect of guide signing.

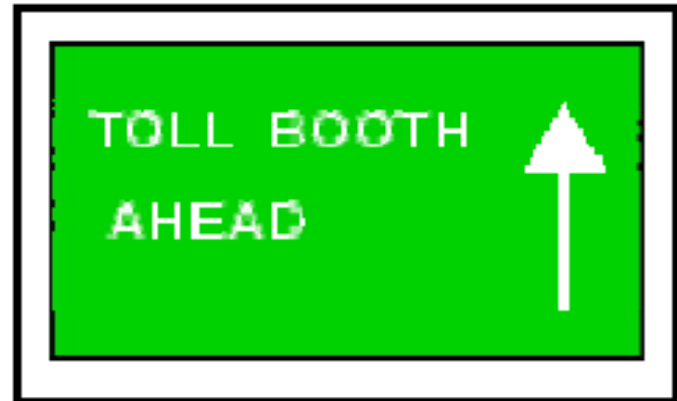

# Traffic signal

## *Objectives*

- To reduce the average delay of all vehicles and the probability of accidents.
- Minimize the possible conflict points.

## *Types of Signal Operation*

- Pre timed operation
- Full actuated operation
- Semi-actuated operation.
- Computer control.

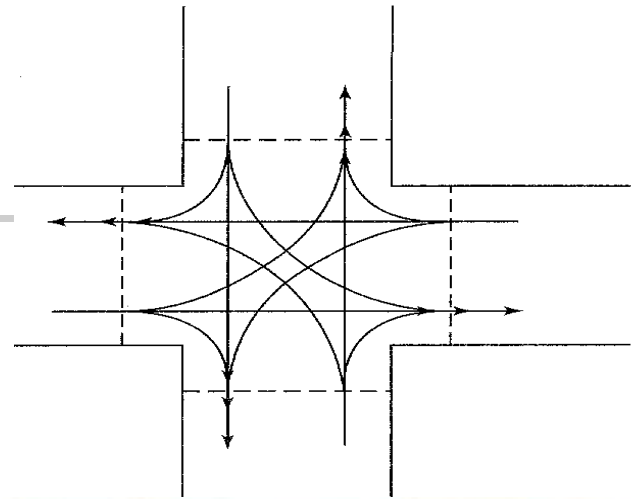



# Traffic signal Cont...

## *Components of a Signal Cycle*

- *Cycle*:- is one complete rotation through all of the indications provided.
- *Cycle length*:- is the time (in seconds) that it takes to complete one full cycle of indications.
- *Interval*:- is a period of time during which no signal indication changes.
  - *Change interval (yellow)* :- is the "yellow" indication for a given movement.
  - *Clearance interval (all red)*:- is also part of the transition from "green" to "red" for a given set of movements.
  - *Green interval*:- Each movement has one green interval during the signal cycle.
  - *Red interval*:- Each movement has a red interval during the signal cycle.
- *Phase*:- A signal phase consists of a green interval, plus the change and clearance intervals that follow it.

# Vehicles flow at an intersection

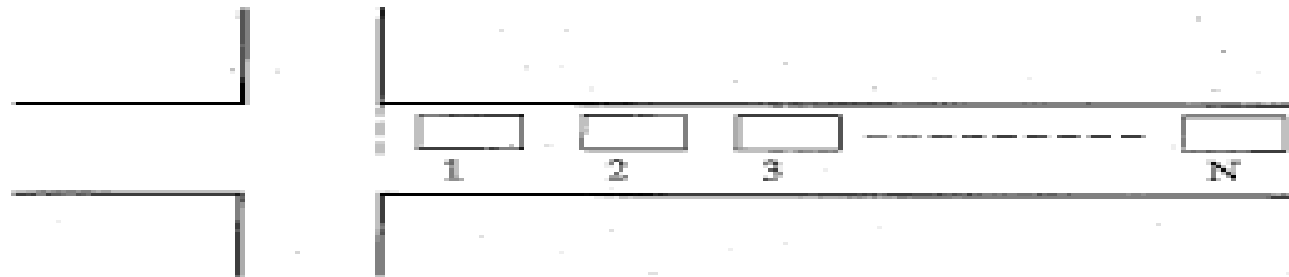

(a) Vehicles in an Intersection Queue

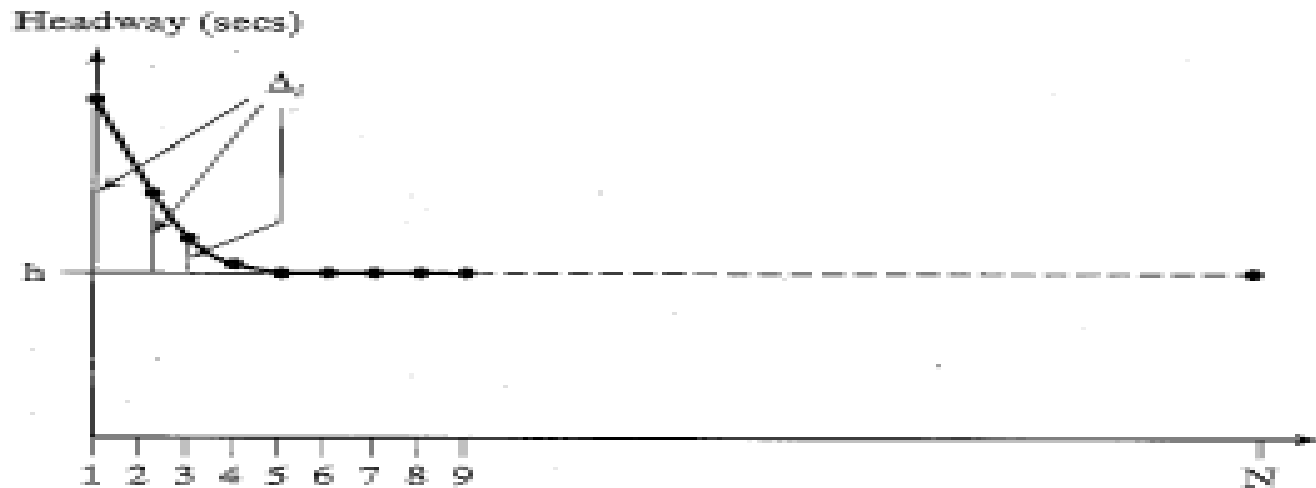



(b) Average Headways Departing Signal

Flow From a Queue at a Signalized Intersection

# Traffic signal Cont...

## Lane Group

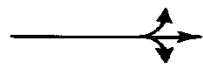
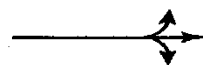
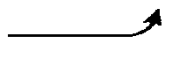
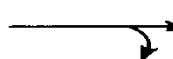
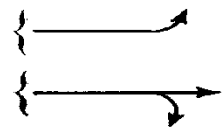
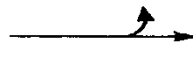
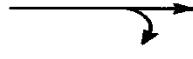
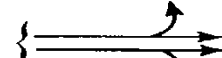
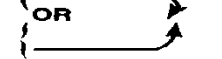
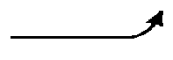
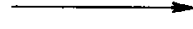
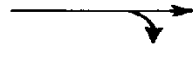
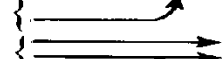
A lane group consists of one or more lanes on an intersection approach and having the same green phase.

| NO. OF LANES | MOVEMENTS BY LANES  | LANE GROUP POSSIBILITIES   |
|--------------|---|--|
| 1            | LT + TH + RT   | ① <br>Single-lane approach  |
| 2            | EXC LT <br>TH + RT    | ②   |
| 2            | LT + TH <br>TH + RT   | ① <br>OR<br>②  |
| 3            | EXC LT <br>TH <br>TH + RT  | ② <br>OR<br>③  |







# Traffic signal Cont...

---

## *Signal Timing at Isolated Intersections*

- An isolated intersection is one in which the signal time is not coordinated with that of any other intersection and therefore operates independently.

## *Yellow Interval*

- The main purpose of the yellow indication after the green is to alert motorists to the fact that the green light is about to change to red and to allow vehicles already in the intersection to cross it.
- Is the time period that guarantees that an approaching vehicle can either stop safely or proceed through the intersection without speeding.

# Traffic signal Cont...

- For the dilemma zone to be eliminated the distance  $X_o$  should be equal to the distance  $X_c$ .

$$X_c = u_o(\tau_{min}) - (W + L)$$

Where:  $X_c$  is the distance within which a vehicle traveling at the speed limit ( $u_o$ ) during the yellow interval  $\tau_{min}$  time

$W$  = width of intersection(m);

$L$  = length of vehicle (m)

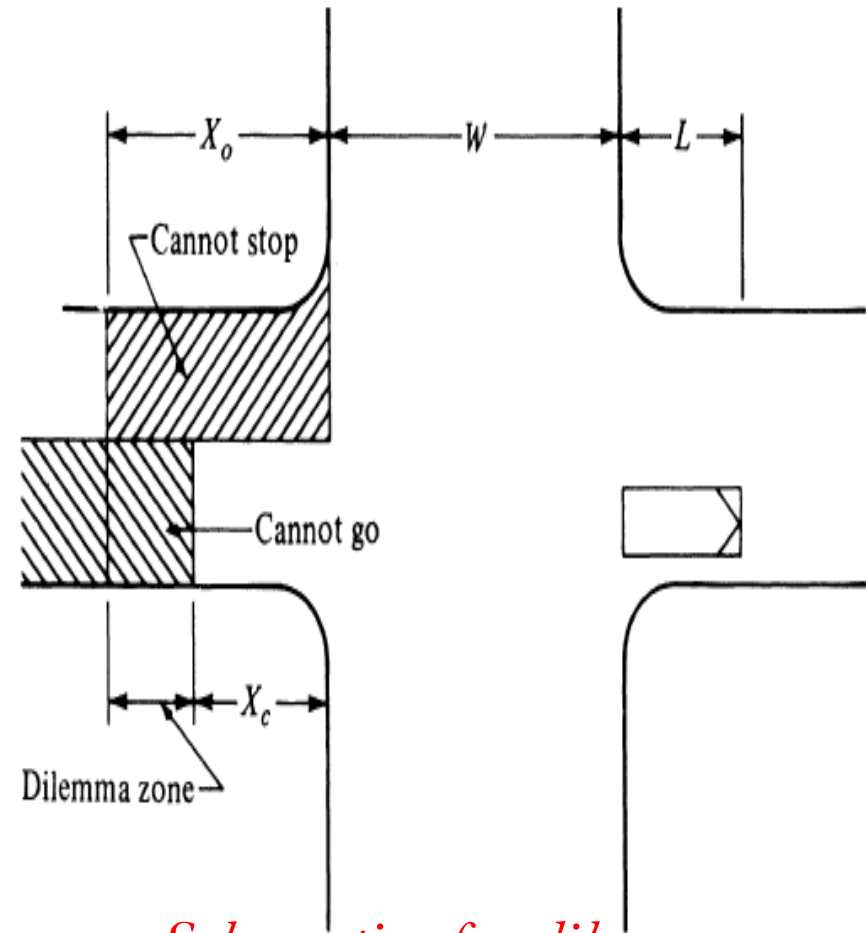

*Schematic of a dilemma zone at an intersection* 26



# Traffic signal Cont...

---

- For vehicles to be able to stop, however,

$$X_o = u_o \delta + \frac{u_o^2}{2a}$$

Where:  $X_o$  = the minimum distance from the intersection for which a vehicle traveling at the speed limit  $u_o$  during the clearance interval  $\tau_{\min}$  cannot go through the intersection without accelerating; any vehicle at this distance or at a distance greater than this has to stop;

$\delta$  = perception-reaction time; (sec)

$a$  = constant rate of braking deceleration (m/sec<sup>2</sup>)

# Traffic signal Cont...

- For the dilemma zones to be eliminated,  $X_o$  must be equal to  $X_c$ .

$$u_o(\tau_{\min}) - (W + L) = u_o\delta + \frac{u_o^2}{2a}$$
$$\tau_{\min} = \delta + \frac{W + L}{u_o} + \frac{u_o}{2a}$$

If the effect of  
grade is added,

$$\tau_{\min} = \delta + \frac{W + L}{u_o} + \frac{u_o}{2(a + Gg)}$$

Where,  $\tau_{\min}$  = the minimum yellow interval, (sec)

$\delta$  = perception-reaction time (sec)

$W$  = width of intersection, (m)

$L$  = length of vehicle, (m)

$u_o$  = speed (m/sec)

$a$  = deceleration, (m/sec<sup>2</sup>)

$G$  = grade of the approach road, and

$g$  = acceleration due to gravity





## Example 1

---

Determine the minimum yellow interval at a 4% grade intersection whose width is 40 ft if the maximum allowable speed on the approach roads is 30 mi/h. Assume average length of vehicle is 20 ft.

### solution

$$\tau_{\min} = \delta + \frac{W + L}{u_o} + \frac{u_o}{2(a + Gg)}$$





# Traffic signal Cont...

---

Several design methods have been developed to determine the optimum cycle length, two of which

*1. The Webster Method*

*2. Highway Capacity Method*



**AAiT**

Addis Ababa Institute of Technology  
አዲስ አበባ ቴክኖሎጂ ኢንስቲትዩት  
Addis Ababa University  
አዲስ አበባ ዩኒቨርሲቲ



# 1. The Webster Method.

---

Webster has shown that for a wide range of practical conditions minimum intersection delay is obtained when the optimum cycle length is obtained by the equation:

$$C_o = \frac{1.5L + 5}{1 - \sum_{i=1}^{\phi} Y_i}$$

Where,  $C_o$  = optimum cycle length (sec)

$L$  = total lost time per cycle (sec)

$Y_i$  = maximum value of the ratios of approach flows to saturation flows for all traffic streams using phase  $i$  (i.e.,  $V_{ij}/S_j$ ) (critical flow ratio)

$\phi$  = number of phases

$V_{ij}$  = flow on lane  $j$  having the right of way during phase  $i$

$S_j$  = saturation flow on lane  $i$



# The Webster Method ...

## Total Lost Time

Figure shows a graph of rate of discharge of vehicles at various times during a green phase of a signal cycle at an intersection.

- The number of vehicles that go through the intersection is represented by the area under the curve.
- Dividing the number of vehicles that go through the intersection by the saturation flow will give the effective green time, which is less than the sum of the green and yellow times.

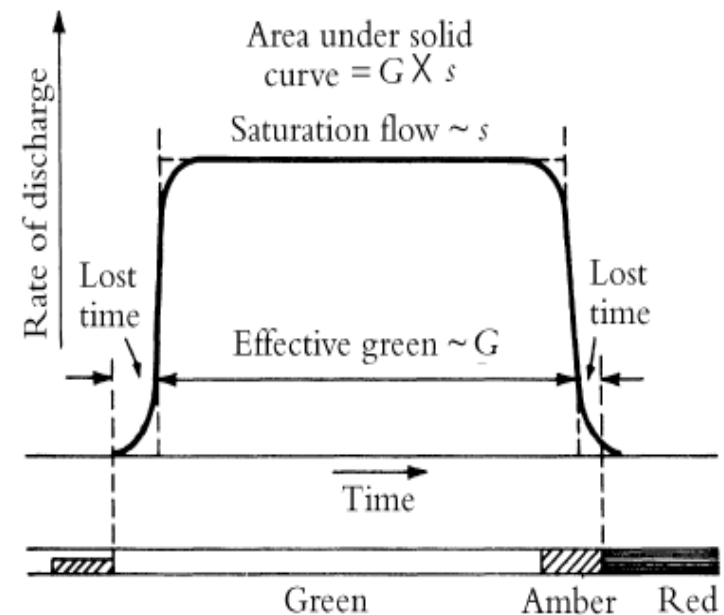





# The Webster Method ...

---

- This difference is considered lost time.

$$l_i = G_{ai} + \tau_i - G_{ei}$$

Where,  $l_i$  = lost time for phase  $i$

$G_{ai}$  = actual green time for phase  $i$  (not including yellow time)

$\tau_i$  = yellow time for phase  $i$

$G_{ei}$  = effective green time for phase  $i$

- Total lost time is given as

$$L = \sum_{i=1}^{\phi} l_i + R$$

Where,  $R$  is the total all-red time during the cycle.





# The Webster Method ...

---

## Allocation of Green Times.

In general, the total effective green time available per cycle is given by

$$G_{te} = C - L = C - \left( \sum_{i=1}^{\phi} l_i + R \right)$$

Where,  $C$  = actual cycle length used (usually obtained by rounding off  $C_o$  to the nearest five seconds)

$G_{te}$  = total effective green time per cycle





# The Webster Method ...

---

To obtain minimum overall delay, the total effective green time should be distributed among the different phases in proportion to their  $Y$  values to obtain the effective green time for each phase.

$$G_{ei} = \frac{Y_i}{Y_1 + Y_2 + \dots + Y_\phi} G_{te}$$

And the actual green time for each phase is obtained as

$$G_{a1} = G_{e1} + l_1 - \tau_1$$

$$G_{a2} = G_{e2} + l_2 - \tau_2$$

$$G_{ai} = G_{ei} + l_i - \tau_i$$

$$G_{a\phi} = G_{e\phi} + l_\phi - \tau_\phi$$





## Minimum Green Time

- At an intersection where a significant number of pedestrians cross, it is necessary to provide a minimum green time that will allow the pedestrians to safely cross the intersection.
- The length of this minimum green time may be higher than that needed for vehicular traffic to go through the intersection.
- The green time allocated to the traffic moving in the north–south direction should, therefore, not be less than the green time required for pedestrians to cross the east–west approaches at the intersection. Similarly, the green time allocated to the traffic moving in the east–west direction cannot be less than that required for pedestrians to cross the north–south approaches.



# Minimum Green Time

- The minimum green time can be determined by using the **HCM** expressions given

$$G_p = 3.2 + \frac{L}{S_p} + \left[ 2.7 \frac{N_{ped}}{W_E} \right] \dots \dots W_E > 10 ft$$

$$G_p = 3.2 + \frac{L}{S_p} + (0.27 N_{ped}) \dots \dots W_E \leq 10 ft$$

Where,  $G_p$  = minimum green time (sec)

$L$  = crosswalk length (ft)

$S_p$  = average speed of pedestrians, usually taken as 4ft/sec (assumed to represent 15<sup>th</sup> percentile pedestrian walking speed)

3.2 = pedestrian start-up time

$W_E$  = effective crosswalk width

$N_{ped}$  = number of pedestrians crossing during an interval





# Through vehicle equivalent

---

## Left turns

It is depend on the opposing flow and no. of lane in opposing direction.

## Right turns

It is depend on Number of pedestrian in the conflicting crosswalk (ped/hr)



## 2. Highway Capacity Method

---

Please refer to the Book  
Nicholas J. Garber (Part 2  
Chapter 8)



**AAiT**

Addis Ababa Institute of Technology  
አዲስ አበባ ቴክኖሎጂ ኢንስቲትዩት  
Addis Ababa University  
አዲስ አበባ ዩኒቨርሲቲ



## Example 2

Figure and table shown bellow shows peak-hour volumes for a major intersection on an arterial highway. Using the Webster method, determine suitable signal (green) timing for the intersection using a four-phase as system as shown in diagram and the additional data given in the figure.

|                        | <i>East Approach</i> |      |      | <i>West Approach</i> |      |     | <i>South Approach</i> |      |      | <i>North Approach</i> |      |      |
|------------------------|----------------------|------|------|----------------------|------|-----|-----------------------|------|------|-----------------------|------|------|
| <i>Lane</i>            | L                    | T    | R    | R                    | T    | L   | R                     | T    | L    | L                     | T    | R    |
| <i>PHV</i>             | 35                   | 610  | 70   | 50                   | 500  | 25  | 175                   | 800  | 250  | 220                   | 700  | 185  |
| <i>Saturation flow</i> | 956                  | 3850 | 1023 | 1000                 | 3400 | 856 | 1520                  | 3962 | 1500 | 3562                  | 3800 | 1520 |



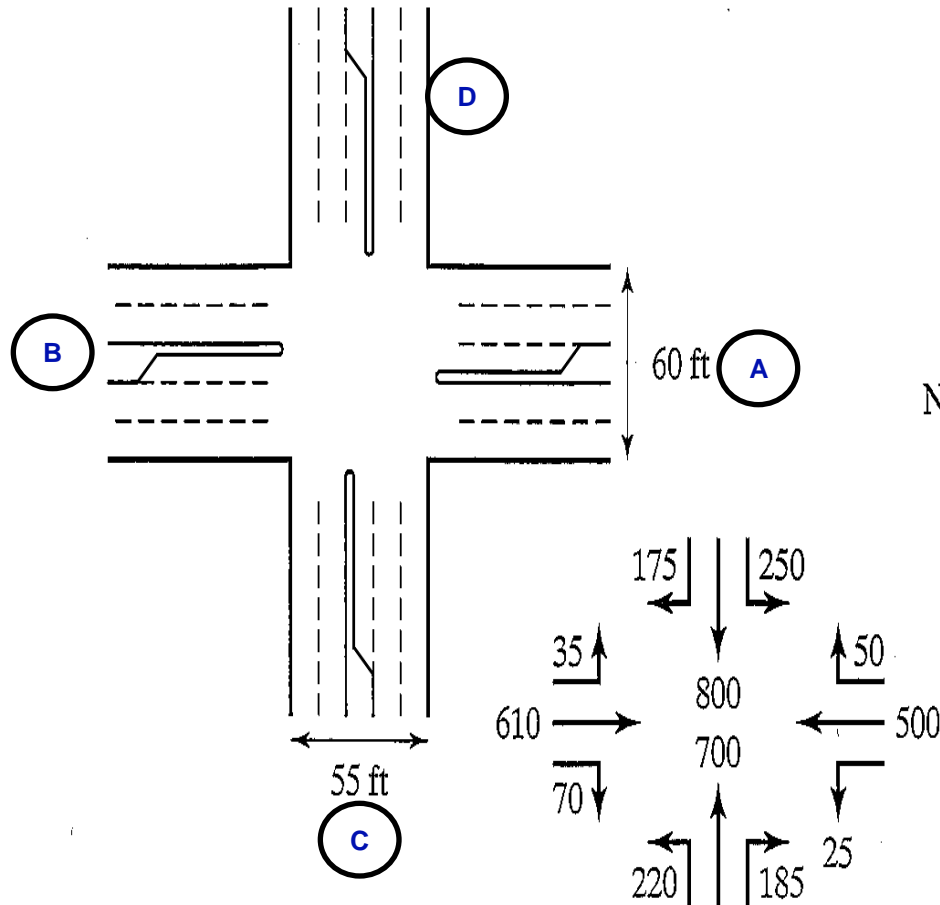

- PHF=0.92
- Driver reaction time=1 sec
- Ped. walking speed=6fps
- Speed limit=13mph
- Assume 14 pedestrian cross per interval (the same for all)
- Level grade
- Deceleration rate=10ft/s<sup>2</sup>
- Effective Crosswalk width
  - 10ft for approach C and D
  - 15ft for approach A and B
- There are 3% truck in all lanes.
- Take 1.6 PC for truck
- Length of veh. 20ft
- Assume 3.5 sec for li
- Left turn factor of 2.4
- Right turn factor of 1.18

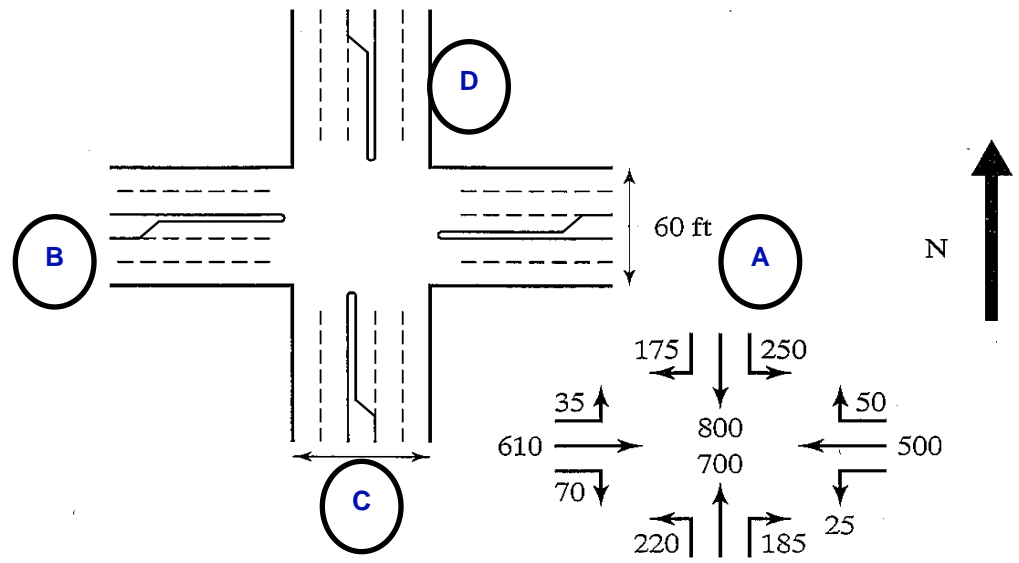
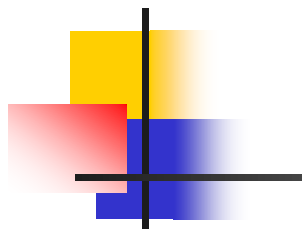

|                 | <i>East Approach (Ph. B)</i> |       |          | <i>West Approach (Ph. A)</i> |       |          | <i>South Approach (Ph.D)</i> |       |          | <i>North Approach (ph. C)</i> |       |          |
|-----------------|------------------------------|-------|----------|------------------------------|-------|----------|------------------------------|-------|----------|-------------------------------|-------|----------|
| <i>Lane</i>     | L (2.4)                      | T     | R (1.18) | L (2.4)                      | T     | R (1.18) | L (2.4)                      | T     | R (1.18) | L (2.4)                       | T     | R (1.18) |
| <i>PHV</i>      | 35                           | 610   | 70       | 50                           | 500   | 25       | 175                          | 800   | 250      | 220                           | 700   | 185      |
| <i>Sat. fl.</i> | 956                          | 3850  | 1023     | 1000                         | 3400  | 856      | 1520                         | 3962  | 1500     | 3562                          | 3800  | 1520     |
| <i>TH equ.</i>  | 84                           | 610   | 83       | 120                          | 500   | 30       | 420                          | 800   | 295      | 528                           | 700   | 218      |
| <i>DHV</i>      | 91                           | 663   | 90       | 130                          | 543   | 32       | 457                          | 870   | 321      | 574                           | 761   | 237      |
| <i>PCE</i>      | 93                           | 675   | 91       | 133                          | 553   | 33       | 465                          | 885   | 326      | 584                           | 775   | 242      |
| <i>PCE/S</i>    | 0.097                        | 0.175 | 0.089    | 0.133                        | 0.163 | 0.038    | 0.306                        | 0.223 | 0.218    | 0.164                         | 0.204 | 0.159    |
| <i>Yi</i>       |                              | 0.175 |          |                              | 0.163 |          | 0.306                        |       |          |                               | 0.204 |          |



**QUESTIONS?**

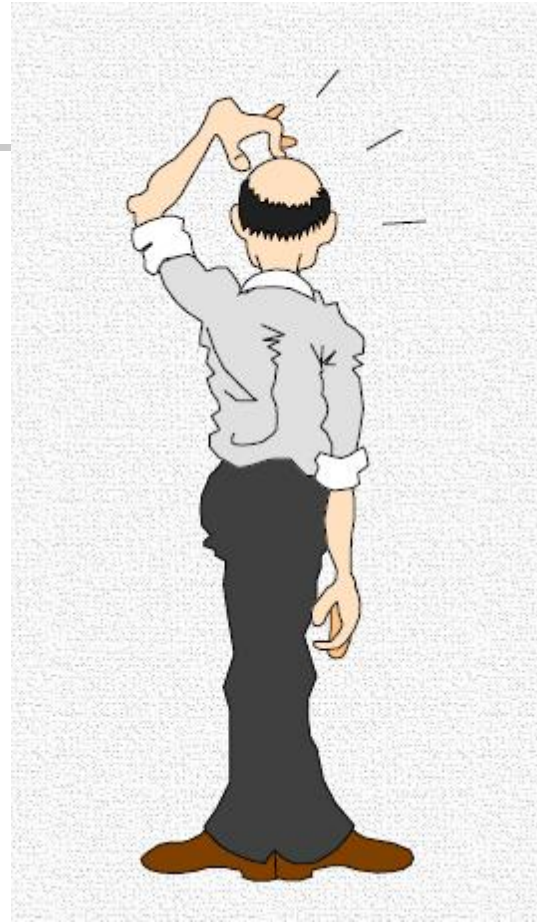

# End of the Course



**Thank you!**