

THE STABILISATION OF THE LEANING TOWER OF PISA

J. B. BURLAND¹⁾, M. JAMIOLKOWSKI²⁾ and C. VIGGIANI³⁾

ABSTRACT

The stabilisation of the Tower of Pisa has been a very difficult challenge for geotechnical engineering. The Tower is founded on weak, highly compressible soils and its inclination has been increasing inexorably over the years to the point at which it was about to reach leaning instability. Any disturbance to the ground beneath the south side of the foundation is very dangerous; therefore the use of conventional geotechnical processes at the south side, such as underpinning, grouting etc., involved unacceptable risk. The internationally accepted conventions for the conservation and preservation of valuable historic buildings, of which the Pisa Tower is one of the best known and most treasured, require that their essential character should be preserved, with their history, craftsmanship and enigmas. Thus any intrusive intervention on the Tower had to be kept to an absolute minimum and permanent stabilisation schemes involving propping or visible support were unacceptable and in any case could have triggered the collapse of the fragile masonry.

In 1990 the Italian Government appointed an International Committee for the safeguard and stabilisation of the Tower. It was conceived as a multidisciplinary body, whose members were experts in arts, restoration and materials, structural engineers and geotechnical engineers. After a careful consideration of a number of possible approaches, the Committee adopted a controlled removal of small volumes of soil from beneath the north side of the Tower foundation (underexcavation). This technique provided an ultra soft method of increasing the stability of the Tower, which is completely consistent with the requirement of architectural conservation.

The paper reports the analyses and experimental investigations carried out to explore the applicability of the procedure for the stabilisation of the Leaning Tower of Pisa. All the results having been satisfactory, the actual underexcavation of the monument was carried out in the years 1999–2001; the results obtained are presented and discussed.

Key words: leaning instability, leaning tower of Pisa, numerical modelling, physical modelling, stabilisation works (IGC: E3)

INTRODUCTION

A cross section of the Leaning Tower of Pisa is reported in Fig. 1. It is nearly 60 m high and the foundation is 19.6 m in diameter; the weight is 141.8 MN. In the early 1990's, the foundation was inclined southwards at about $5\frac{1}{2}^\circ$ to the horizontal. The average inclination of the axis of the Tower to the vertical is somewhat less, due to a slight curvature resulting from corrections that were made by masons during the construction, to counteract the inclination already occurring. The seventh cornice was overhanging the first one by about 4.1 m.

Construction is in the form of a hollow cylinder. The inner and outer surfaces are faced with marble and the annulus between these facings is filled with rubble and

mortar, within which extensive voids have been found. A spiral staircase winds up within the annulus.

Figure 1 shows that the staircase forms a large opening on the south side just above the level of the first cornice, where the cross section of the masonry reduces. The high stress within this region was a major cause of concern since it could give rise to an abrupt brittle failure of the masonry.

The ground profile underlying the Tower is shown in Fig. 2. It consists of three distinct horizons. Horizon A is about 10 m thick and primarily consists of estuarine deposits, laid down under tidal conditions; as a consequence, rather variable sandy and clayey silts are found. At the bottom of horizon A there is a 2 m thick medium dense fine sand layer. Based on sample descriptions and

¹⁾ Professor of Geotechnical Engineering, Imperial College of Engineering and Medicine, London and Member of the International Committee for the Safeguard of the Leaning Tower of Pisa.

²⁾ Professor of Geotechnical Engineering, Technical University of Torino, and Member of the International Committee for the Safeguard of the Leaning Tower of Pisa (sgi_jamiolkowski@studio-geotechnico.it).

³⁾ Professor of Geotechnical Engineering, University Federico II, Napoli, and Member of the International Committee for the Safeguard of the Leaning Tower of Pisa.

Manuscript was received for review on August 8, 2002.

Written discussions on this paper should be submitted before May 1, 2004 to the Japanese Geotechnical Society, Sugayama Bldg. 4F, Kanda Awaji-cho 2-23, Chiyoda-ku, Tokyo 101-0063, Japan. Upon request the closing date may be extended one month.

$V \cong 142 \text{ MN}$, $M \cong 327 \text{ MNm}$, $e \cong 2.3 \text{ m}$
 Situation in year 1990

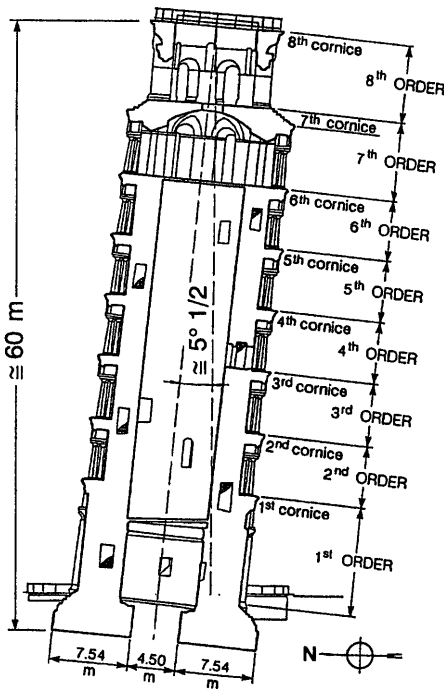

Fig. 1. Cross section of the Leaning Tower of Pisa

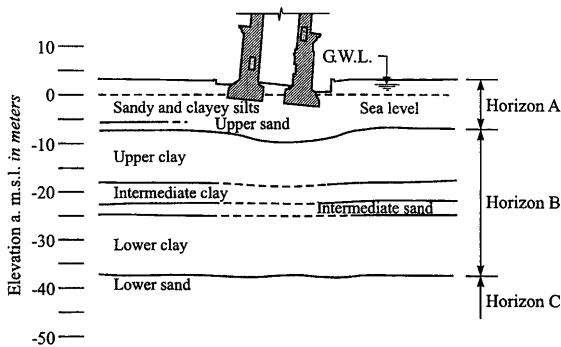

Fig. 2. Subsoil profile

piezocone tests, the materials to the south of the Tower appear to be more silty and clayey than to the north, and the sand layer is locally thinner. This is believed to be the origin of the southward inclination of the Tower.

Horizon B consists primarily of marine clay which extends to a depth of about 40 m. It is subdivided into four distinct layers. The upper layer is a soft sensitive clay, locally known as the Pancone. It is underlain by an intermediate layer of stiffer clay, which in turn overlies a sand layer (the intermediate sand). The bottom layer of horizon B is a normally consolidated clay known as the lower clay. Horizon B is very uniform laterally in the vicinity of the Tower. Horizon C is a dense sand (the lower sand) which extends to considerable depth. The water table in horizon A is between 1 m and 2 m below the ground surface. Pumping from the lower sand has resulted in downward seepage from horizon A with a

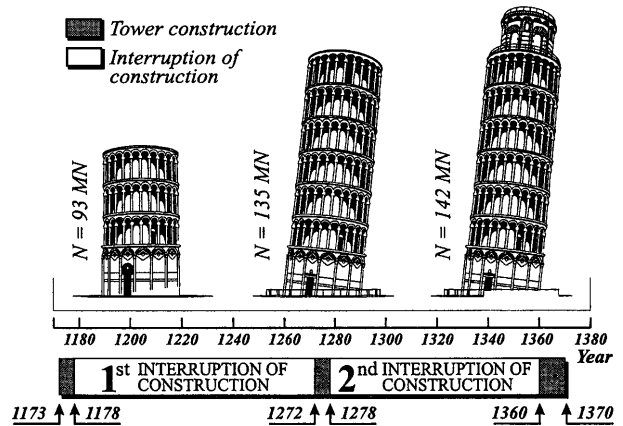

Fig. 3. History of the construction

pore pressure distribution with depth which is slightly below hydrostatic.

The many borings beneath and around the Tower show that the surface of the Pancone clay is dished beneath the Tower, from which it can be deduced that the average settlement of the monument is approximately 3 m. Fuller details about the Tower and its subsoil, including a wide list of references, are reported by Burland et al. (1999).

Work on the Tower began in 1173 (Fig. 3). Construction had progressed to about one third of the way up the 4th order by 1178, when the work was interrupted. The reason for stoppage is not known, but had it continued much further, the foundations would have experienced an undrained bearing capacity failure. The work recommenced in 1272, after a pause of nearly 100 years, by which time the strength of the ground had increased due to consolidation under the weight of the structure. By about 1278, construction had reached the 7th cornice when work again stopped. Once again, there can be no doubt that, had work continued, the Tower would have fallen over. In about 1360, work on the bell chamber was commenced and was completed in about 1370, two centuries after the start of the work. It is known that the Tower must have been tilting to the south when work on the bell chamber began, as it is noticeably more vertical than the remainder of the Tower. Indeed on the north side there are four steps from the seventh cornice up to the floor of the bell chamber, while on the south side there are six steps (Fig. 4).

Another important detail of the history of the Tower is that in 1838, a walkway was excavated around the foundation. This is known as the *catino*, and its purpose was to expose the column plinths and foundation steps for all to see as was originally intended. The operation resulted in an inflow of water on the south side, since here the excavation is below the water table.

A reliable clue to the history of the tilt lies in the adjustments made to the masonry layers during construction and in the resulting shape of the axis of the Tower. This is depicted in Fig. 5; based on this shape and a hypothesis on the manner in which the masons corrected for the progressive lean of the Tower, the history of inclination

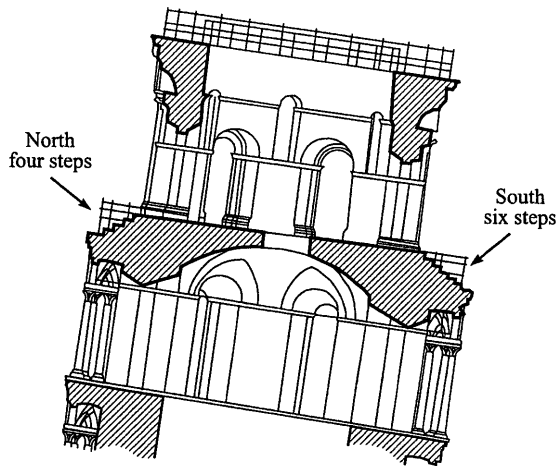

Fig. 4. Detail of the bell chamber

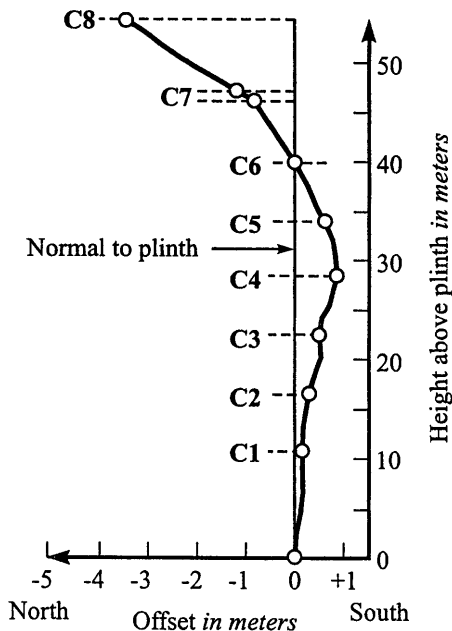

Fig. 5. Shape of the axis of the Tower

of the foundation of the Tower reported in Fig. 6 may be deduced. During the first phase of construction to just above the third cornice (1173 to 1178), the Tower inclined slightly to the north. The northward inclination increased slightly during the rest period of nearly 100 years to about 0.2° . When construction recommenced in about 1272 the Tower began to move towards the south and accelerated shortly before construction reached the seventh cornice in about 1278, when work again ceased, at which stage the inclination was about 0.6° towards the south. During the next 90 years, the inclination increased to about 1.6° . After the completion of the bell chamber in about 1370, the inclination of the Tower increased significantly. In 1817, when Cresy and Taylor made the first recorded measurement with a plumb line, the inclination of the Tower was about 4.9° . The excavation of the *catino* in 1834 appears to have caused an increase of inclination of

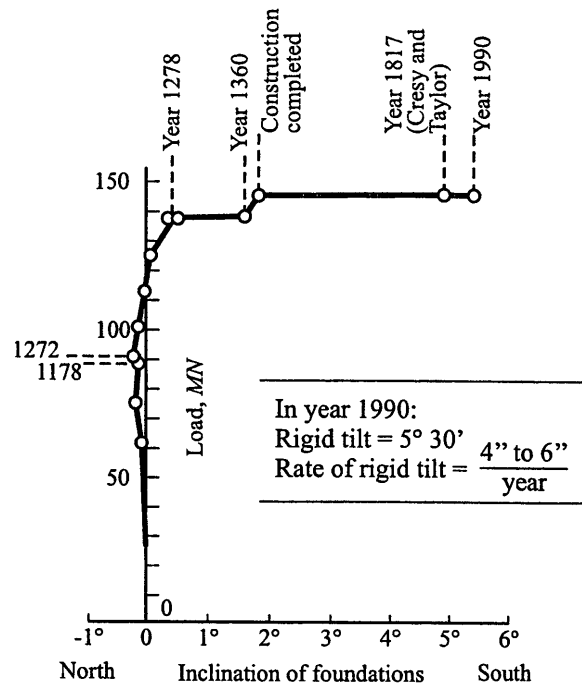

Fig. 6. History of inclination

approximately 0.5° and the inclination of the foundation in the early 1990 was about 5.5° .

In 1990, the Italian Government appointed an International Committee to safeguard and stabilise the Tower. It was conceived as a multidisciplinary body composed of: experts of arts, restoration and materials; structural and geotechnical engineers. The present paper reports the physical and numerical models developed by the Committee to investigate the stability of the Tower and to design the final stabilisation measures. The implementation of these measures and the results obtained are then presented.

LEANING INSTABILITY

The Committee has developed a detailed understanding of the history of the inclination of the Tower, and in particular, of the movements it has experienced in the last century. These have been observed by a very comprehensive monitoring system, installed on the Tower since the beginning of the 20th century and progressively enriched. The behaviour of the Tower, as depicted in Fig. 6, clearly indicates that it is affected by leaning instability, a phenomenon controlled by the stiffness of the soil rather than by its strength (Gorbunov Possadov and Serebriany, 1961; Habib and Puyo, 1970; Schultze, 1973; Hambly, 1985; Lancellotta, 1993; Desideri and Viggiani, 1994; Desideri et al., 1997; Potts and Burland, 2000; Jamiolkowski et al., 2000).

Edmunds (1993) performed a number of small scale physical tests on a model Tower resting on a bed of fine sand, to study the effect of underexcavation on a Tower close to collapse for leaning instability. A sketch of the experimental set up is reported in Fig. 7. A model tower

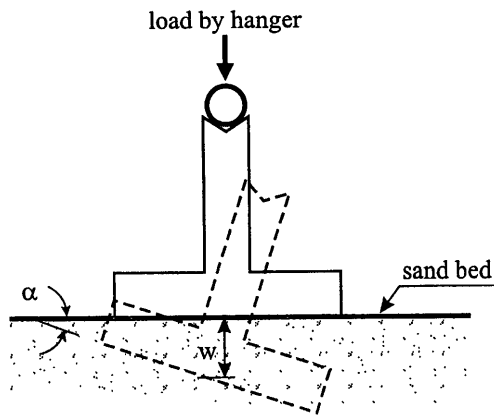

Fig. 7. Set up of the experiments by Edmonds (1993)

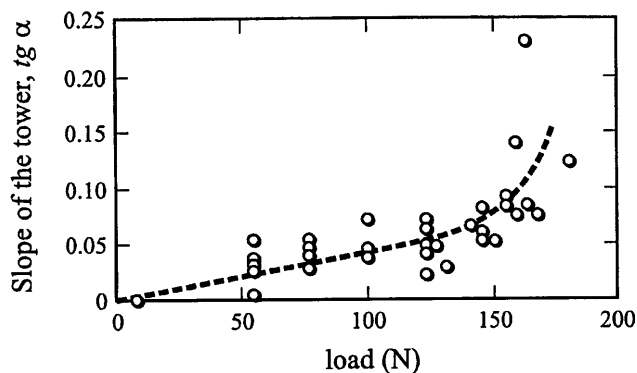

Fig. 8. Results of the experiments by Edmonds (1993)

with a diameter of 102 mm was placed on top of a very loose fine sand bed, and loaded through a hanger at a height of 126 mm over the base. The ratio 126/102 is approximately equal to the ratio of the height of the centre of gravity of the Tower of Pisa to the diameter of its foundation.

Loading the model tower produced a settlement and a rotation α . A total of 8 load tests were carried out; the load at failure varied between 120 and 190 N. Failure in all cases was by toppling with the lowest edge of the model tower's base sinking into the sand as the Tower rotated toward horizontal. The individual plots of α varying with load give somewhat variable results, but when combined into one plot, as in Fig. 8, a well defined envelope of results emerges. The envelope shows a pronounced change in curvature at a load of 160 to 165 N, where the inclination averages 0.09 ($\alpha \approx 5^\circ$).

Potts and Burland (2000), using Finite Element analysis, investigated the differences between leaning instability and the usual bearing capacity failure. Figure 9 shows the plane strain problem of a Tower resting on a uniform deposit of undrained clay. The clay is modelled as a linear elastic-perfectly plastic Tresca material with an undrained strength $s_u = 80$ kPa. The Tower was given an initial tilt of 0.5° ; the self weight was then increased in a large displacement finite element analysis. Figure 10 shows the results obtained in two analyses with different

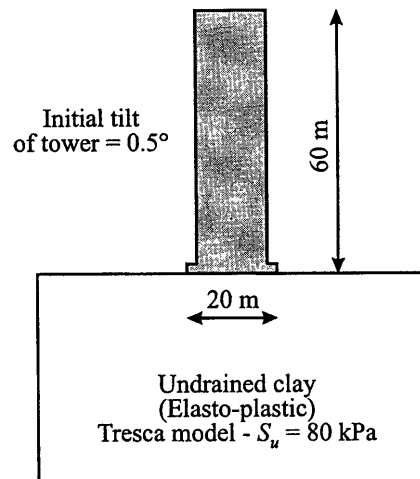

Fig. 9. Plane strain problem of a tower resting on a uniform deposit of undrained clay

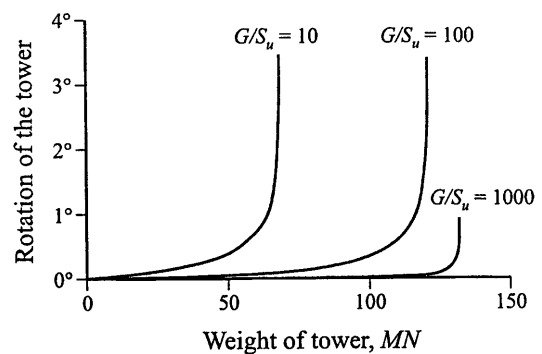

Fig. 10. Load-settlement response of the tower on soft and stiff clay

shear stiffness G : viz. $G/s_u = 10$ and $G/s_u = 1000$; in both cases the strength of the soil s_u was 80 kPa. The results show that failure occurs abruptly with little warning and that the weight of the Tower at failure is dependent on the shear stiffness of the soil. The failure load with $G/s_u = 10$ is about half of that with $G/s_u = 1000$.

Figure 11 shows vectors of incremental displacement for the soft soil, in the last increment of the analysis. The displacements are located in a zone below the foundation and indicate a rotational type of failure. At first sight, this looks like a plastic type collapse mechanism. However, examination of the zone in which the soil has gone plastic, also shown in Fig. 11, indicates that it is very small and not consistent with a plastic failure mechanism. Consequently, this figure indicates a mechanism of failure consistent with leaning instability.

Vectors of incremental displacement just before collapse for the stiffer soil are shown in Fig. 12. They indicate a traditional "general failure" type mechanism with the soil being pushed outwards on both sides. The plastic zone is very large and therefore the results clearly indicate a plastic bearing capacity type mechanism of failure.

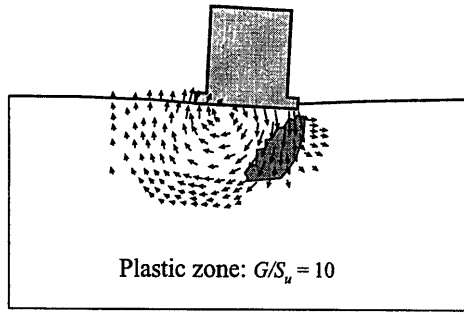

Fig. 11. Vectors of incremental displacement and extension of plastic zone in soft clay at failure

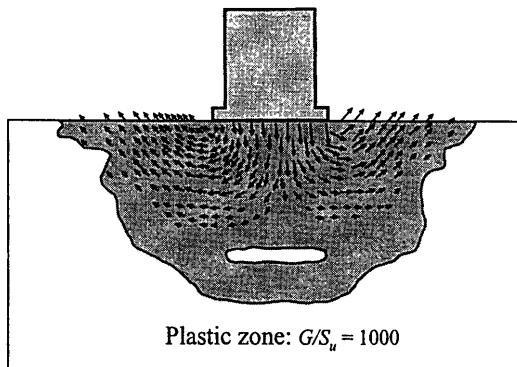

Fig. 12. Vectors of incremental displacement and extension of plastic zone in stiff clay at failure

SIMPLE LINEAR MODELS

To demonstrate leaning instability, the simple conceptual model of inverted pendulum may be used. It is a rigid vertical pole (Fig. 13) of length h , with a concentrated mass of weight W at the top and hinged at the base to a constraint that reacts to a rotation α with a stabilising moment $M_s = M_s(\alpha)$. On the other hand, a rotation α induces an overturning moment $M_o = Wh \sin \alpha$.

In the vertical position ($\alpha = 0$), the system is in equilibrium. Let us imagine that a rotation α occurs. If $M_s > M_o$, the equilibrium is stable; the system returns to the vertical configuration. If $M_s < M_o$, the equilibrium is unstable; the system collapses. If $M_s = M_o$, the equilibrium is neutral; the system stays in the displaced configuration. The stability of the equilibrium may be characterised by a safety factor $FS = M_s/M_o$.

Modelling the Tower as an inverted pendulum, the restraint exerted by the foundation may be evaluated assuming that the foundation is a circular plate (diameter D) resting on a linearly elastic medium. The latter may be either a Winkler type bed of springs of stiffness k or an elastic half space of constants E, ν (Desideri and Viggiani, 1994; Desideri et al., 1997). Defining W and $M_o = We$ as the vertical load and the overturning moment ($e =$ eccentricity of load), and ρ, α as the settlement and rotation of the foundation, it may be shown that:

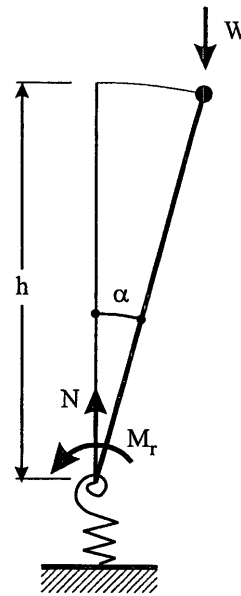

Fig. 13. The inverted pendulum

$$\begin{Bmatrix} \rho \\ \alpha \end{Bmatrix} = \begin{vmatrix} 1 & 0 \\ k_\rho & 1 \\ 0 & k_\alpha \end{vmatrix} \begin{Bmatrix} W \\ M_o \end{Bmatrix}$$

The equation shows that there is no coupling between settlement and rotation. For a bed of Winkler type springs the expressions of the stiffness are:

$$k_\rho = \frac{\pi D^2}{4} k = Ak; \quad k_\alpha = \frac{\pi D^4}{64} k = Jk$$

where A and J are respectively the area and the moment of inertia of the circular foundation. For an elastic half space the expressions are:

$$k_\rho = \frac{ED}{1 - \nu^2}; \quad k_\alpha = \frac{ED^3}{6(1 - \nu^2)}$$

In this simple linear elastic model the stability of equilibrium is thus an intrinsic property of the ground—monument system. For instance, for the case of an elastic half space:

$$FS = \frac{M_s}{M_o} = \frac{k_\alpha \alpha}{Wh \sin \alpha} \approx \frac{k_\alpha}{Wh} = \frac{E}{6(1 - \nu^2)} \frac{D^3}{Wh}$$

assuming $\alpha \approx \sin \alpha$.

For the case of Winkler springs:

$$FS = \frac{\pi D^4}{64} \frac{k}{Wh}$$

In the case of the Tower of Pisa, an evaluation of FS may be obtained based on the knowledge of the settlement of the Tower, that is around 3 m. This gives $k = 0.157 \text{ MN/m}^3$; $E/(1 - \nu^2) = 2.85 \text{ MN/m}^2$. Accordingly, $FS = 0.36$ for the Winkler springs and $FS = 1.12$ for the elastic half space. It may be concluded that the linear Winkler springs are less suitable than the elastic half space to

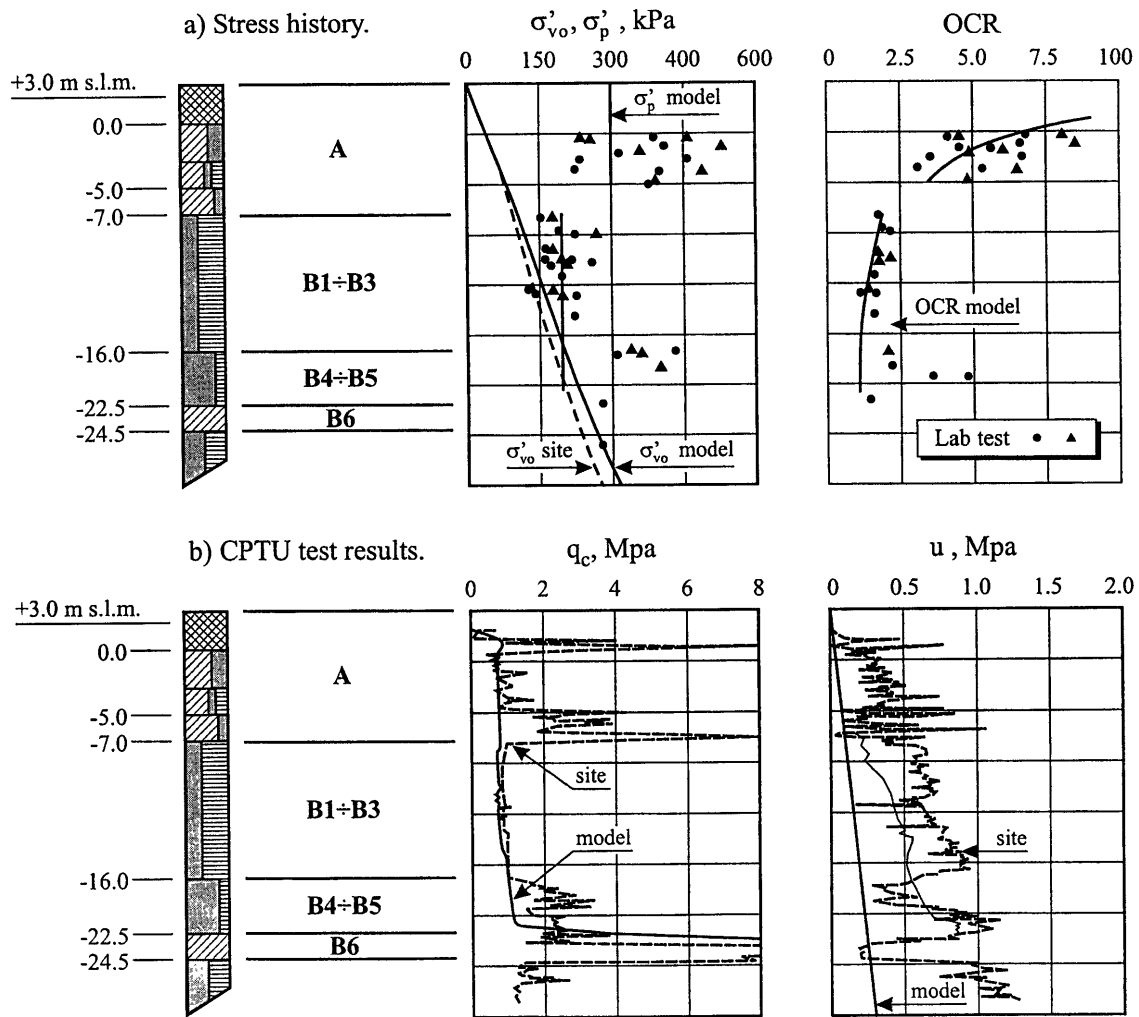

Fig. 14. Subsoil model used in centrifuge tests

model the Tower. In any case, even the very simple linearly elastic models allow an important practical conclusion: the Tower is very nearly in a state of neutral equilibrium. For most of the 20th century the inclination of the Tower has been steadily increasing, but the changes of inclination have been extremely small compared with those that occurred during and immediately following the construction. The rate of inclination of the Tower in 1990 was about six arc seconds per year. The cause of the continuing movement is believed to be a phenomenon of ratchetting, triggered by the fluctuations of the water table in Horizon A; it is made possible by the fact that the Tower was substantially in a state of neutral equilibrium. It is to be noted that a state of neutral equilibrium is possible, in principle, only if the system is a linear one; in the case of non-linearity, neutral equilibrium is but a transition stage to overturning. Of course, creep has also some effects on the process.

NON-LINEARITY

The relationship between M_s and α may be linearised over a short interval, but it is certainly non-linear and approaches a limiting value of M_s asymptotically. In a

case like that of the Tower of Pisa, that is on the verge of instability, consideration of non-linearity appears mandatory. To this aim, the knowledge of the relationship $M_s = M_s(\alpha)$ is necessary.

Centrifuge modelling of the Tower and its subsoil was carried out at ISMES; the results obtained are reported and discussed by Pepe (1995). They gave further insight into the mechanisms of the instability and confirmed the elastoplastic character of the restraint exerted by the foundation and the subsoil on the motion of the Tower.

In Fig. 14 the properties of the foundation soils of the Tower are compared with the properties obtained in the small scale model after consolidation under geostatic load in the centrifuge; the main features of the soil profile are satisfactorily reproduced in the model. Figure 15 shows the simulation of the construction of the Tower, as obtained from one of the centrifuge tests. In the first stage of the construction, the model Tower was constrained to settle without rotation. In the second stage the model Tower was left free to rotate. It may be seen that both the settlement and the rotation, scaled to the prototype, are in good overall agreement with those of the Tower.

Finite element analyses of the behaviour of the Tower

and its subsoil have been carried out using a finite element geotechnical computer program developed at Imperial College and known as ICFEP (Potts and Gens, 1984). The constitutive model is based on Critical State concepts and is non-linear elastic work hardening plastic. Fully coupled consolidation is incorporated, so that time effects due to the drainage of pore water in the soil skeleton are included.

The prime object of the analysis was to improve the understanding of the mechanisms controlling the behaviour of the Tower (Burland and Potts, 1994). Accordingly, a plane strain approach was used for much of the work, and only later was three dimensional analysis used to explore certain detailed features.

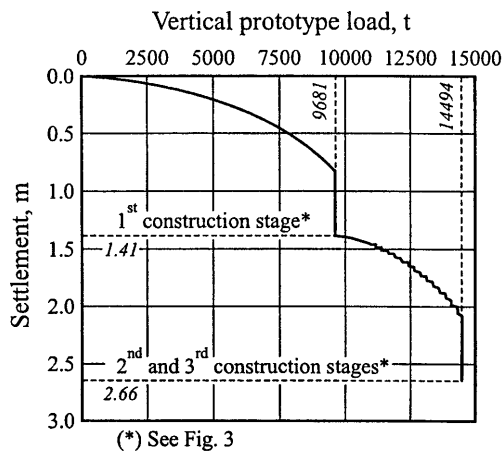

Fig. 15. Typical centrifuge simulation of the construction of the Tower

The layers of the finite element mesh matched the soil sub-layering that had been established from soil exploration studies. Figure 16(a) shows the adopted mesh, while Fig. 16(b) shows the detail of the mesh in the immediate vicinity of the foundation. In Horizon B the soil is assumed to be laterally homogeneous; however, a tapered layer of slightly more compressible material was incorporated into the mesh for layer A₁ as shown by the shaded element in Fig. 16(b). This tapered layer represents a more clayey material found beneath the south side of the foundation; in applied mechanics terms, this slightly more compressible tapered layer may be considered as an “imperfection”. The overturning moment generated by the lateral movement of the centre of gravity of the Tower was incorporated into the model as a function of the inclination of the foundation, as shown in Fig. 16(b). The construction history of the Tower was simulated by a series of load increments applied to the foundation at suitable time intervals. The excavation of the catino in 1838 was also simulated in the analysis. Calibration of the model was carried out by adjusting the relationship between the overturning moment generated by the centre of gravity and the inclination of the foundation. A number of runs were carried out with successive adjustments being made until good agreement was obtained between the actual and the predicted present day value of the inclination.

Figure 17(a) shows a graph of the predicted changes in inclination of the Tower against time, compared with the deduced historical values, the same data are plotted in Fig. 17(b) in the style of Fig. 6.

From about 1272 onwards there is a remarkable agree-

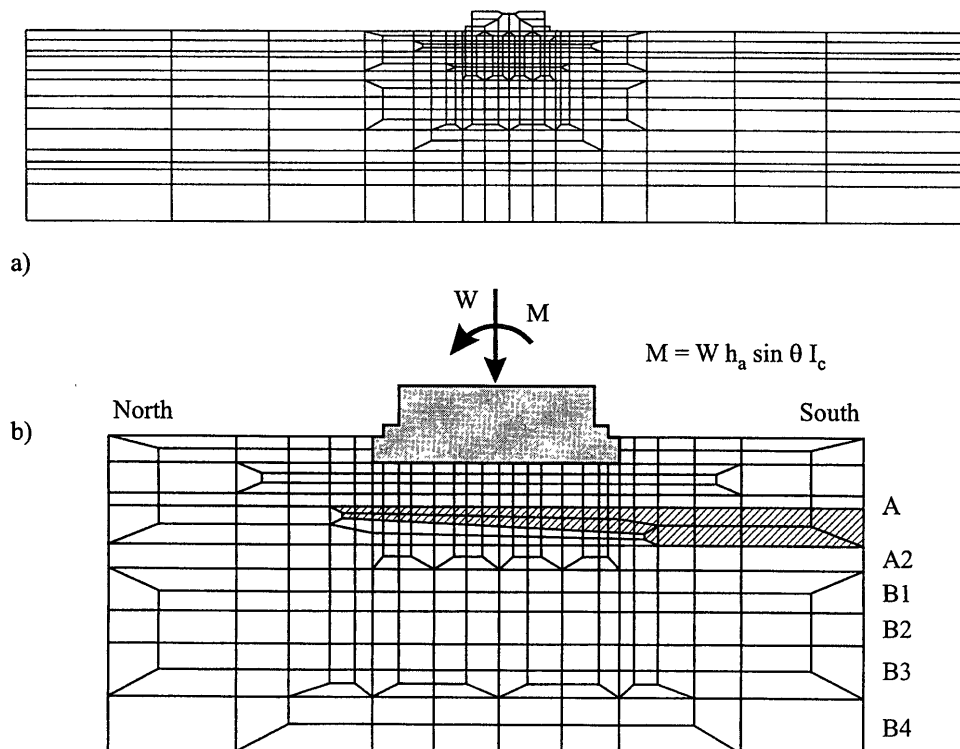

Fig. 16. Finite Element model: a) general mesh, b) detail of the mesh in the vicinity of the Tower

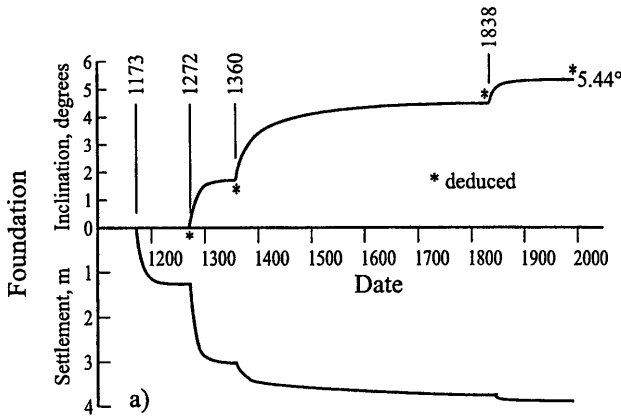

Fig. 17. Comparison between deduced historical values of the Tower inclination and values predicted by the FEM model

ment between the model and the historical inclination. Note the excavation of the catino in 1838 which results in a predicted rotation of about 0.75°. The final imposed inclination of the model tower is 5.44°, slightly less than the 1993 value of 5.5°. It was found that any further increase in the final inclination of the tower model resulted in instability: a clear indication that the Tower is very close to falling over.

The analysis has demonstrated that the lean of the Tower results from the phenomenon of settlement instability due to the high compressibility of the Pancone Clay. The principal effect of the layer of slightly increased compressibility beneath the south side of the foundation is to determine the direction of lean, rather than its magnitude. The main limitation is that the model does not deal with creep. Nevertheless, the model provided important insights into the basic mechanisms of behaviour and later it proved invaluable in assessing the effectiveness of various proposed stabilisation measures.

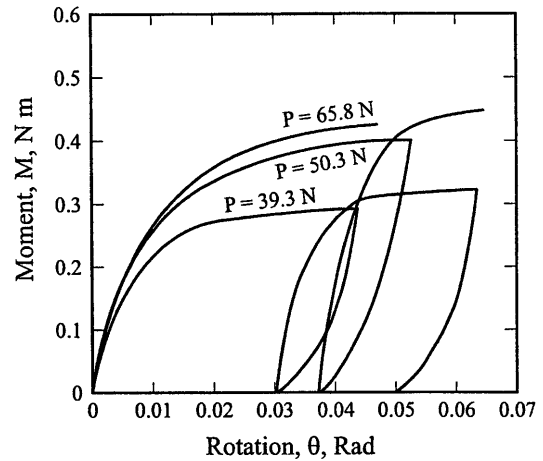

Fig. 18. Centrifuge experiments by Cheney et al. (1991)

STABILISING MEASURES

If an elasto-plastic model is assumed, then the relation between loads and displacement has to be written in incremental form (Desideri et al., 1997):

$$\begin{Bmatrix} \partial \rho \\ \partial \alpha \end{Bmatrix} = \begin{vmatrix} \frac{1}{k_p} & \frac{1}{k_{p\alpha}} \\ \frac{1}{k_{\alpha p}} & \frac{1}{k_\alpha} \end{vmatrix} \begin{Bmatrix} \partial W \\ \partial M \end{Bmatrix}$$

There is a coupling between settlement and rotation; the increment of displacement depends on the load increment, the current state of load and the load history. Hence the factor of safety depends on the current state of stress and stress history, and decreases with increasing inclination.

The centrifuge experiments by Cheney et al. (1991, Fig. 18) show coupling between settlement and rotation, together with non-linearity and strain hardening plasticity. It may be seen that a decrease of inclination strongly increases the stiffness of the foundation—ground system. This generated the idea that a decrease of inclination increases M_s and FS , and can be used to stabilise the Tower. This has been the basic approach of the Committee to the stabilisation of the Tower; among other things, it is completely respectful of its integrity. In fact, it may be said that movements are in the DNA of the Tower!

An important experimental confirmation of this approach came from a temporary safety measure taken to prevent overturning of the Tower. The Committee soon recognised the need for temporary and fully reversible interventions for the improvement of the safety against overturning by foundation failure, and for gaining time to complete the investigations and analyses necessary to conceive and implement the final stabilisation measures. The observation that the northern side of the Tower foundation had been steadily rising for most of the 20th century led to the suggestion of applying a counterweight on the north side as a temporary measure. Accordingly, a design was developed consisting of a prestressed concrete ring cast around the base of the Tower for supporting a

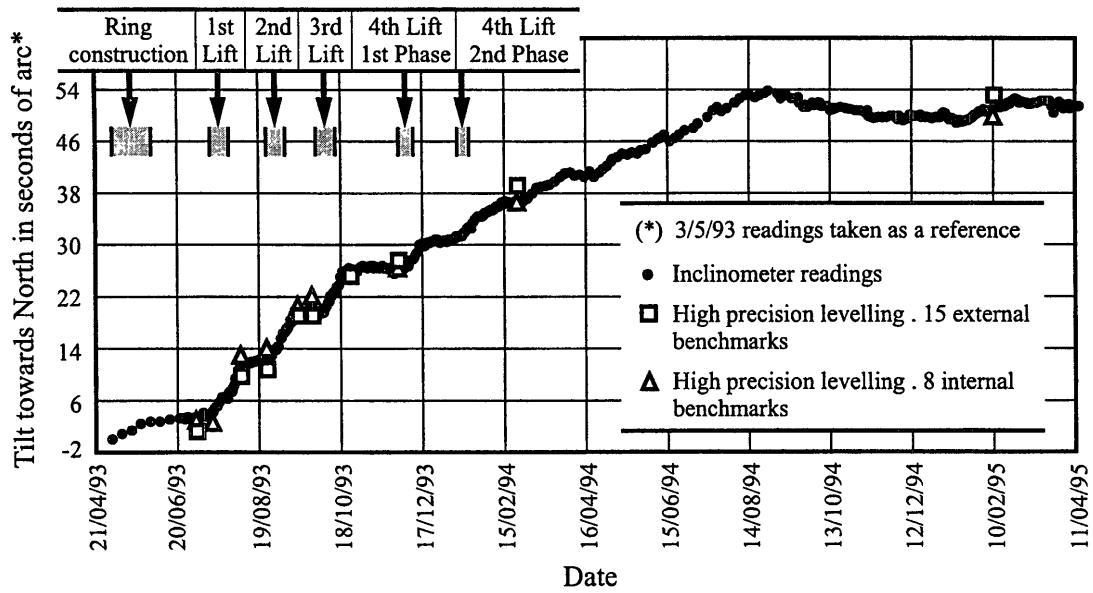

Fig. 19. Behaviour of the Tower during and after the application of lead weights

number of lead ingots. A total of 6.9 MN of ingots were installed at an average distance from the axis of the foundation of around 6.3 m. This intervention was successfully implemented between May 1993 and February 1994. On 29th February 1994, one month after completion of loading, the northward change of inclination was 33"; by the end of July it had increased to 48". On the 21st of February 1994, the average settlement of the Tower relative to the surrounding ground was about 2.5 mm. Figure 19 shows the observed changes in inclination of the Tower during and after the application of the lead weights.

During the application of the counterweight, the rotational stiffness of the Tower was:

$$k_{\alpha} = \frac{6.96MN \times 6.3m}{48''} = 188423MNm$$

The factor of safety was thus increased to:

$$FS = \frac{k_{\alpha}}{Wh} = \frac{188423}{141.8 \times 22.6} = 59$$

where $h = 22.6$ m is the height of the centre of gravity of the Tower. Of course, the only meaning of similar computations is to show that there is a substantial improvement of the stability of the Tower. In this respect, it is noteworthy that, after a small decrease of the inclination, the Tower has remained essentially motionless for over three years, apart from the seasonal cyclic movements and some accidents in September 1995.

The observed behaviour of the Tower during the counterweight application was used to check and refine the finite element model further. Figure 20 shows a comparison of the Class A prediction and measurements of (a) the changes in inclination and (b) the average settlement of the Tower during the application of the lead ingots. The computed settlement is in good agreement with the measured value; the predicted changes in inclination are about

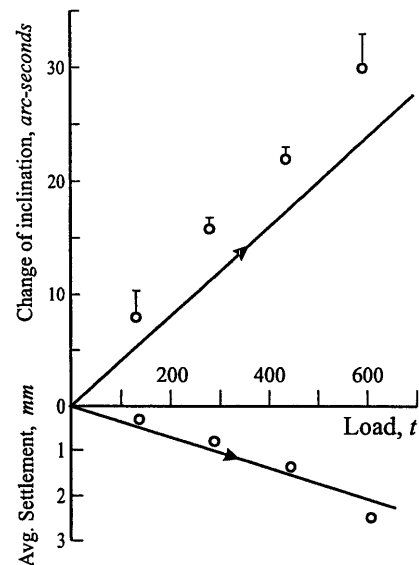

Fig. 20. Comparison between prediction and measurements of changes in inclination and average settlement of the Tower during the application of lead ingots

80% of the measured values.

The refinement of the model involved a small reduction of the value of G/p'_0 in horizon A. After that, a better overall agreement between computed and observed values was obtained (Fig. 21).

UNDEREXCAVATION

Investigations

Among different possible options to obtain a decrease of the inclination, the Committee has explored:

1. surface loading north of the Tower;
2. vacuum pumping from the Pancone clay north of the Tower;
3. electroosmosis;

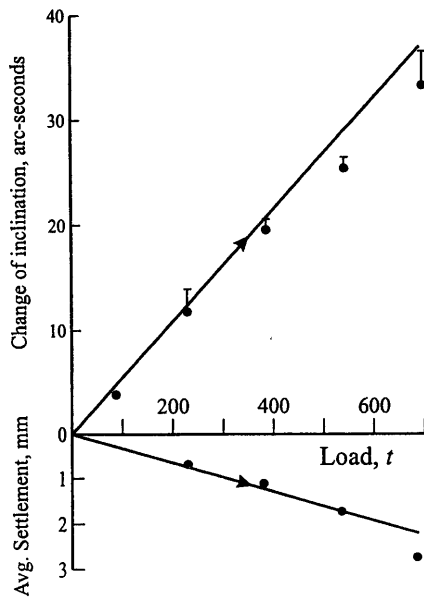

Fig. 21. Ditto as in Fig. 20 after refinement of the model

4. removal of soil north of the foundation and below it (underexcavation).

All these solutions have been explored to different degrees by physical and numerical models; electroosmosis and underexcavation were investigated also by full-scale field trial.

The underexcavation option was finally selected; the related analyses and investigation are briefly reported.

After the small scale model tests performed by Edmunds (1993) described in §2, further model underexcavation tests were performed starting with a load of 165 N and a rotation of 5.5° . These conditions are believed to be representative of a Tower on the verge of leaning instability.

The removal of soil was carried out by inserting a stainless steel tube with an outer diameter of 6 mm and, inside it, an inner suction tube connected to a vacuum pump. The inner tube, with an outer diameter of 2.1 mm, removes the sand from inside the larger tube, that is thus advanced into the soil by self boring, without significant disturbance of the surrounding soil. The whole probe is advanced to the desired location and then retracted, leaving a cavity that closes instantaneously.

The underexcavation tubes are held in position by external guides and penetrate the sand at an angle to the horizontal of $18^\circ 26'$ (3/1). Five radial tubes were provided, covering a sector of 90° centred on the north side of the model tower.

A total of 14 model underexcavation tests, with different combinations of probe positions and penetration sequence, were performed. The most important conclusions reached are as follows:

- underexcavation can be used to reduce the tilt of the model in a controllable manner. A reduction of tilt up to 1° has been obtained;
- the movement of the Tower can be steered using differ-

- ent probes inserted around the Tower;
- the results are reproducible, at least qualitatively;
- a *critical point* exists some 5 m north of the central axis of the model tower, in the ground beneath it, beyond which ground removal aggravates the tilt, but behind which underexcavation produces a decrease in tilt;
- repeated use of one probe in isolation rapidly ceases to affect the Tower's tilt significantly.

These findings have been found to apply qualitatively to the case of the Tower of Pisa and demonstrate the value of simple experiments for exploring mechanisms of behaviour.

The centrifuge was also used to assess the effectiveness of underexcavation as a means to stabilise the Tower. The process of soil extraction was modelled by inserting into the ground beneath the model tower flexible tubes with wires inside, prior to the commencement of the experiment. Once the model tower had come to equilibrium at an appropriate inclination under increased gravity, the wires were pulled out of the flexible tubes by an appropriate amount, while the model was in flight, causing the tubes to close simulating the closure of the cavity produced by a drill probe.

Figure 22 shows the results of a typical experiment. The test results confirm the existence of a critical line and show that soil extraction north of this line always gives a positive response.

The finite element model was used to simulate the extraction of soil from beneath the north side of the foundation. It should be emphasised that the finite element mesh had not been developed with a view of modelling underexcavation; the individual elements were rather large for representing regions of extraction. Thus, the purpose of the modelling was to throw light on the mechanisms of behaviour rather than attempt a somewhat illusory "precise" analysis.

The soil extraction has been simulated by reducing the volume of any chosen element of ground incrementally, so as to achieve a predetermined reduction in volume of that element. The insert in Fig. 23 shows the finite element mesh in the vicinity of the foundation on the north side. The elements numbered 6 to 12 were used for carrying out the intervention and are intended to model an inclined drill hole. The procedure for simulating the underexcavation intervention was as follows:

- the stiffness of element 6 was reduced to zero;
- equal and opposite vertical nodal forces were applied progressively to the upper and lower faces of the element until its volume reduced by about 5%. The stiffness of the element was then restored;
- the same procedure is then applied successively to the elements 7, 8, 9, 10 and 11 thereby modelling the progressive insertion of the drill probe. For each step, the inclination of the Tower reduced;
- when element 12 was excavated the inclination of the Tower increased, confirming that excavation south of a critical line gives a negative response. The analysis was therefore restarted after excavating element 11;
- the retraction of the drill probe was then modelled by

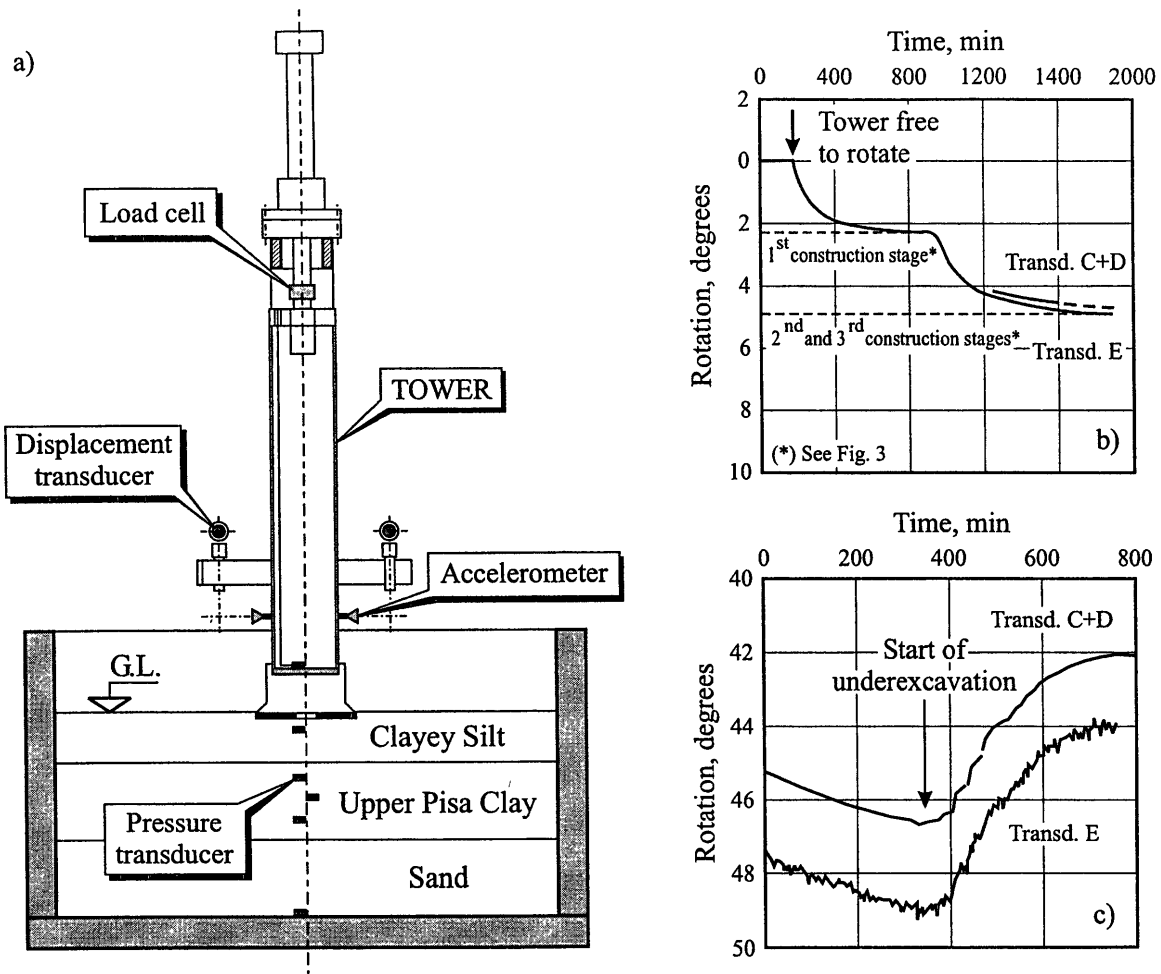

Fig. 22. Simulation of the underexcavation in a centrifuge test: a) Model of the Tower, b) Construction of the Tower and c) Underexcavation

excavating elements 10, 9, 8, 7 and 6 successively. For each step the response of the Tower was positive;

- the whole process of insertion and retraction of the drill probe was then repeated. Once again excavation of element 12 gave a negative response.

The computed displacements of the Tower are plotted in Fig. 23. The sequence of excavation of the elements is given on the horizontal axis; the upper diagram shows the change of inclination of the Tower due to underexcavation; the lower diagram shows the settlement of the north and south sides of the foundation.

As underexcavation progresses from elements 6 through 11, the rate of change of northward inclination increases as do the settlements. As the drill is retracted the rate decreases. At the end of the first cycle of insertion and retraction of the drill, the inclination of the Tower is decreased by 0.1° . The settlement of the south side is more than one half of the north side. For the second cycle a similar response is obtained but the change of inclination is somewhat larger. After the third insertion of the drill the resultant northward rotation is 0.36° . The corresponding settlements of the north and south sides of the foundation are 260 mm and 140 mm respectively.

As regards the contact stress distribution, the process results in a slight reduction of stress beneath the south side. Beneath the north side, some fluctuations in contact

stress take place, as is to be expected, but the stress changes are small. In general, the stress distribution after retraction of the drill are smoother than after insertion.

The results of the physical and numerical modelling work on underexcavation were sufficiently encouraging to undertake a large scale development trial of the field equipment. The objectives of the trial were:

- to develop a suitable method of forming a cavity without disturbing the surrounding ground during drilling;
- to study the time involved in the cavity closure;
- to measure the changes in contact stress and pore water pressures beneath the trial footing;
- to evaluate the effectiveness of the method in changing the inclination of the trial footing;
- to explore methods of “steering” the trial footing by adjusting the drilling sequence;
- to study the time effects between and after the operation.

For this purpose a 7 m diameter eccentrically loaded circular reinforced concrete footing was constructed in the Piazza north of Baptistry, as shown in Fig. 24. Both the footing and the underlying soil were instrumented to monitor settlement, rotation, contact pressure and pore pressure.

After a waiting period of a few months, allowing the

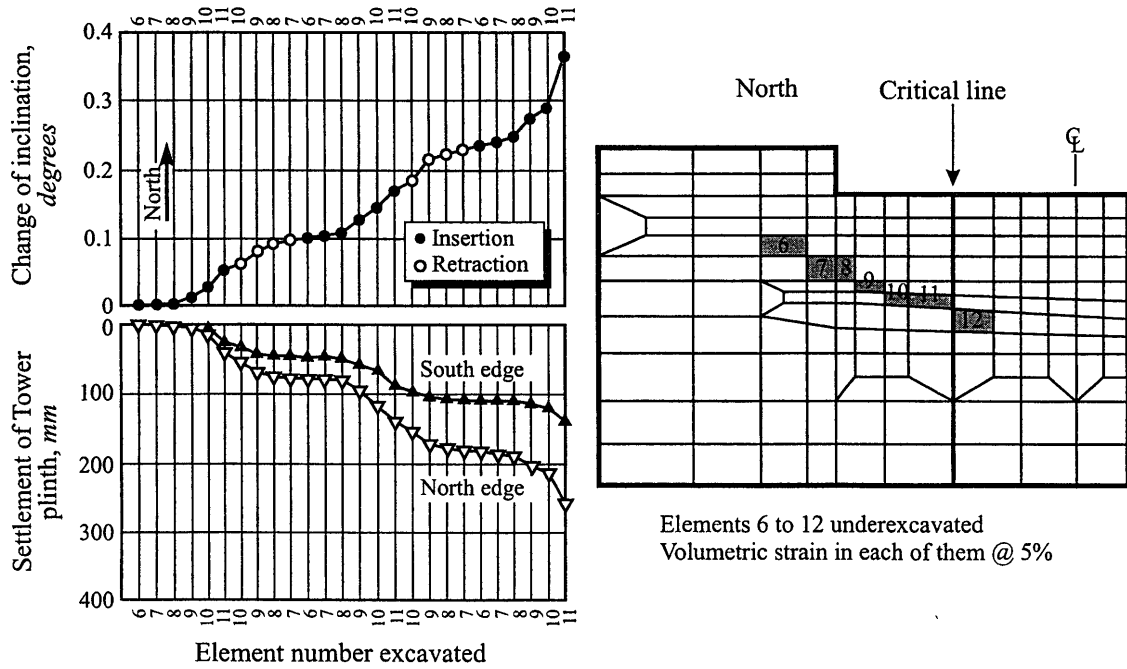

Fig. 23. Finite element simulation of the underexcavation, performed after the history of inclination up to 5% has been simulated

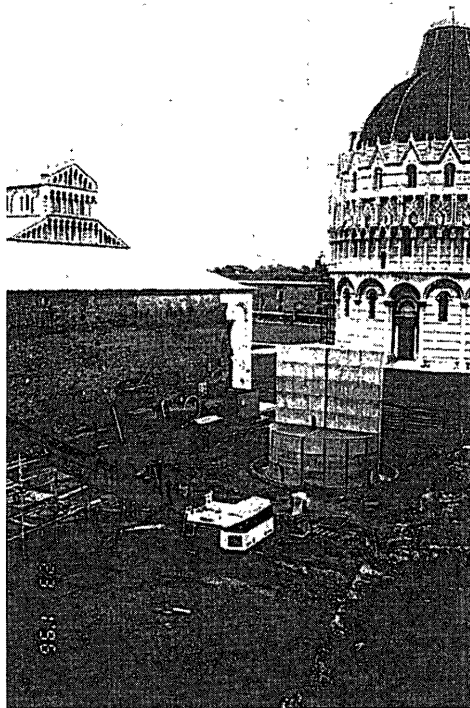
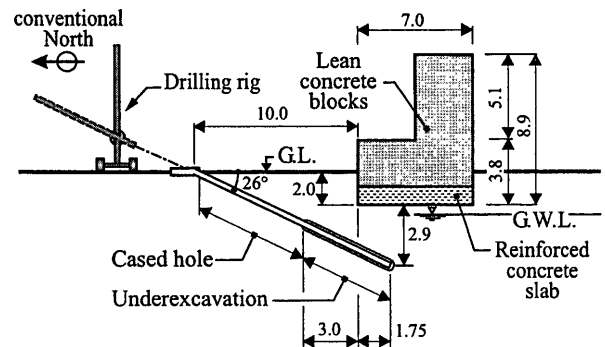

Fig. 24. Large scale experiment of underexcavation

settlement rate to come to a steady value, the ground extraction commenced by means of inclined borings, as shown schematically in Fig. 25. Drilling was carried out using a hollow stemmed continuous flight auger inside a contra-rotating casing.

The trial was very successful. When the drill was withdrawn to form the cavity, an instrumented probe located in the hollow stem was left in place to monitor its closure (Fig. 26). A cavity formed in the Horizon A material was found to close smoothly and rapidly.



Drawing not to scale - all dimensions in meters

Fig. 25. Vertical section of the large scale trial test of underexcavation

Figure 27 shows the measurements of the contact stress at the soil-foundation interface along the north-south axis, before underexcavation (19.09.95) and after a substantial rotation of the footing (01.12.95). The stress changes beneath the foundation were found to be very small. The trial footing was successfully rotated by about 0.25° and directional control was maintained even though the ground conditions were somewhat non uniform. Rotational response to soil extraction was rapid, taking a few hours. On the completion of the underexcavation, on February 1996, the plinth came to rest and since then it has exhibited negligible further movements (Fig. 28). Very importantly, an effective system of communication, decision taking and implementation was developed.

It is of importance to note that, early in the trial, over enthusiastic drilling resulted in soil extraction from excess penetration beneath the footing causing a counter rotation. Therefore the trial also confirmed the concept of a critical line.

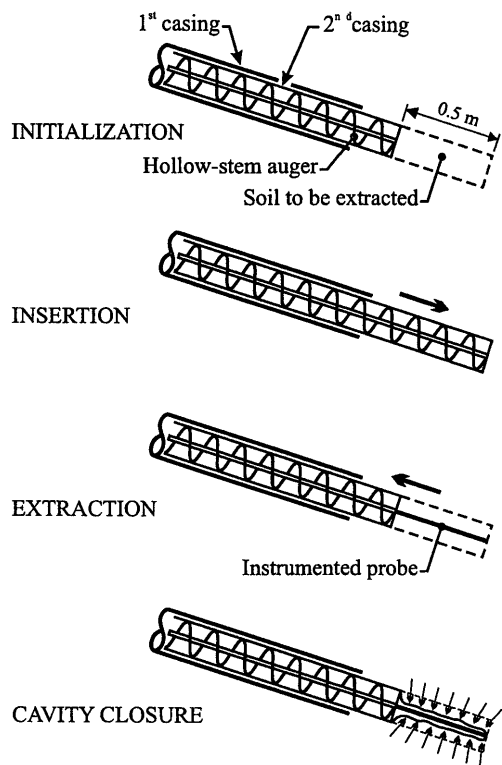

Fig. 26. Drilling technique adopted to remove the soil

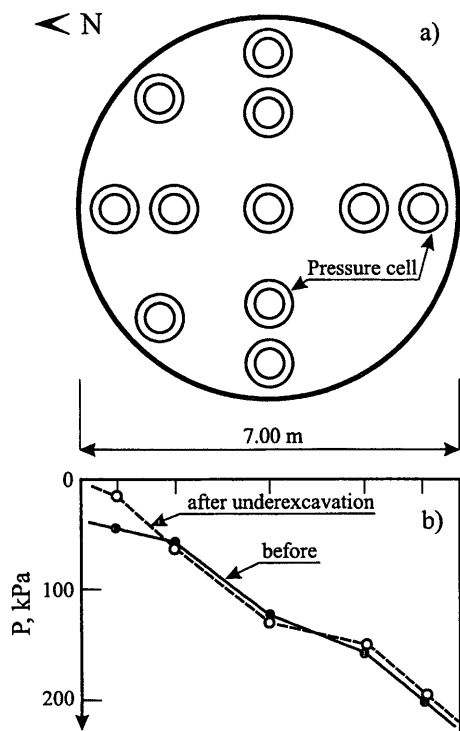

Fig. 27. Variations of contact stress during the underexcavation experiment: a) Location of pressure cell, b) Distribution of contact stress along the plane of maximum tilt

Preliminary Underexcavation of the Tower

The results of all the investigations carried out on the underexcavation were positive, but the Commission was well aware that they might not be completely representa-

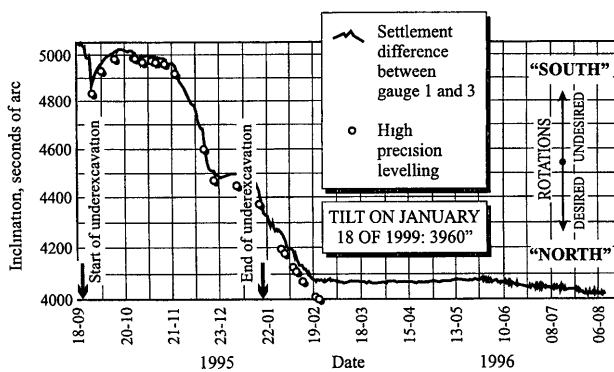

Fig. 28. Result of large scale underexcavation experiment

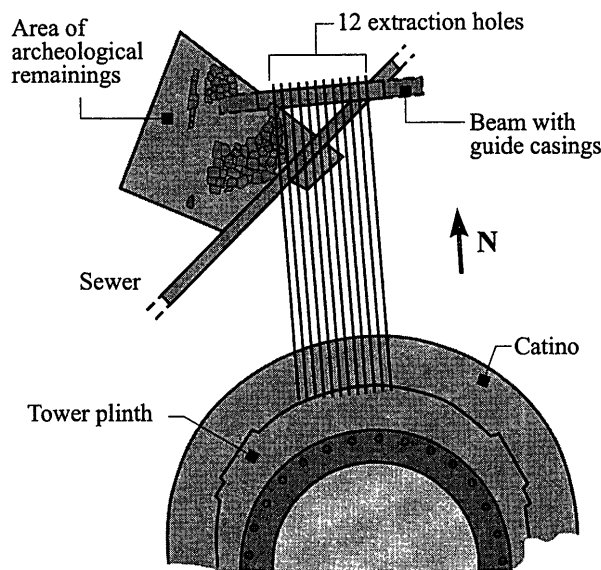

Fig. 29. Holes for the preliminary ground extraction

tive of the possible response of a Tower affected by leaning instability. Therefore it was decided to implement preliminary ground extraction beneath the Tower itself, with the objective of observing its response to a limited and localised intervention. It consisted of 12 holes (Figs. 29 and 30) to extract soil from Horizon A to the north of the Tower foundations, penetrating beneath the foundation not more than 1 m. The goal was to decrease the inclination of the Tower by a small amount, but enough to confirm the feasibility of underexcavation as a means of stabilising the Tower permanently, and to adjust the extraction and measurement techniques.

To protect the Tower from any unexpected adverse movement during this or any other interventions aimed at the final stabilisation of the monument, a safeguard structure was considered mandatory. The structure finally chosen consisted of two sub-horizontal steel stays connected to the Tower at the level of the third order and to two anchoring steel frames located behind the building of the Opera Primaziale, to the north of the Tower. The scheme of the safeguard structure is illustrated in Fig. 31; it was installed and connected to the Tower in December 1998.

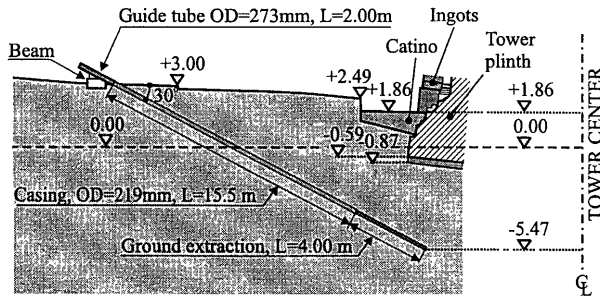

Fig. 30. A hole for the preliminary ground extraction

Each stay was capable of applying a maximum force of 1500 kN, with a safety factor equal to 2. The force could be applied by dead weights or by hydraulic jacks; the value of the applied load being continuously monitored. Under normal operating conditions, the load applied to each stay was equal to about 72 kN, just enough to keep it in position.

The preliminary underexcavation trial was carried out between February and June, 1999. The obtained results are plotted in Fig. 32. During the underexcavation period the Tower rotated northwards at an increasing rate, as the extraction holes gradually approached the north boundary of the foundation and penetrated below it. At the beginning of June 1999, when the operation ceased, the northwards rotation of the Tower was 90"; by mid-September it had increased to 130". At that time three of the 97 lead ingots (weighing about 10 t each) acting on the north side of the Tower were removed; after that the Tower exhibited negligible further movements. As a matter of fact, the preparatory operations for the final underexcavation (removal of the 12 guide casings of the preliminary underexcavation, installation of the 41 guide casings for the final underexcavation) produced a slight further northward rotation, bringing the overall decrease of inclination in March, 2000 to 135".

The total volume of soil removed during the preliminary underexcavation was 7 m³, 86% of which was north of the Tower and 14% was from below the foundation.

The rotation in the east-west plane was much smaller, reaching a final value of about 10" westwards, as intended.

During preliminary underexcavation, the north side of the Tower foundation underwent an overall settlement equal to 1, 3 cm while at the same time, the south side first heaved by 2 mm, and then gradually settled by the same amount, showing that the axis of rotation was located between the two points.

To put these preliminary stabilising results into perspective, the evolution of the tilt of the Tower base since 1993 is plotted in Fig. 33. The effect of the underexcavation trial can be seen to have been far greater than that of counterweight and outweighs the seasonal cyclic movements.

A longer time perspective is given in Fig. 34 which shows the inclination since 1935, as measured by a pendulum inclinometer installed at that time. It may be seen

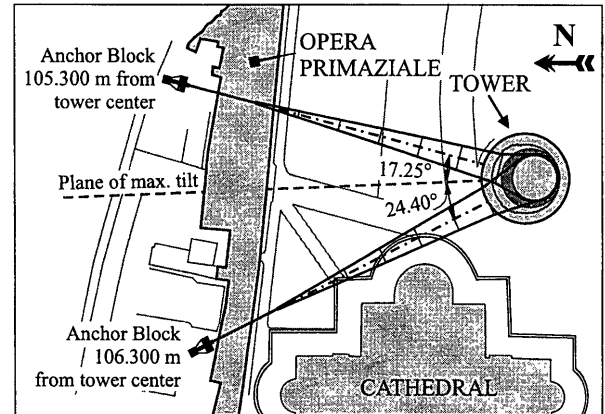
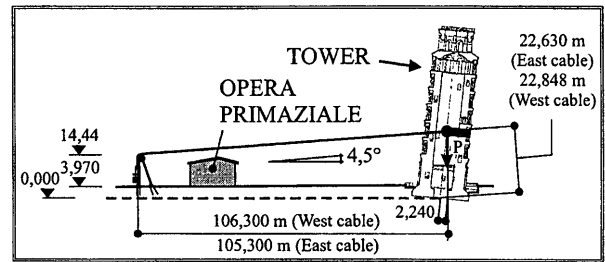

Fig. 31. Cable stays safeguard structure

that the effect of the preliminary underexcavation has been to bring the Tower "back to future" by over 30 years to 1968 which was considered to be very satisfactory.

Final Underexcavation

After the very encouraging results of the preliminary underexcavation trial, the Committee proceeded to the final underexcavation, which was carried out between February 2000 and February 2001. This time 41 holes were drilled, see Fig. 35; the layout in a vertical section is shown in Fig. 36. During the final underexcavation all the lead ingots, and the concrete beam on which they rested, were progressively removed. In June 2001 the steel cable stays were also dismantled, without once having been operated as a safeguard.

The results obtained from the final underexcavation are plotted in Fig. 37. The target of decreasing the tilt of the Tower by half a degree was successfully achieved (Fig. 38). During this final stage, 38 m³ of soil were removed, 31% of which was extracted north of the Tower and 69% from below the foundation. The maximum penetration below the foundation was 2 m.

To put these results in perspective, the evolution of the tilt of the Tower base since 1993 is plotted in Fig. 39. A longer time perspective is given in Fig. 40, which shows the change in inclination since 1911, when the modern style of measurement began. It can be seen that the overall effect of the underexcavation has been to bring the Tower "back to future" to the time just before the excavation of the catino in 1838. Thus, a well-conceived and executed excavation programme has compensated for the effects of the old excavation of the catino!

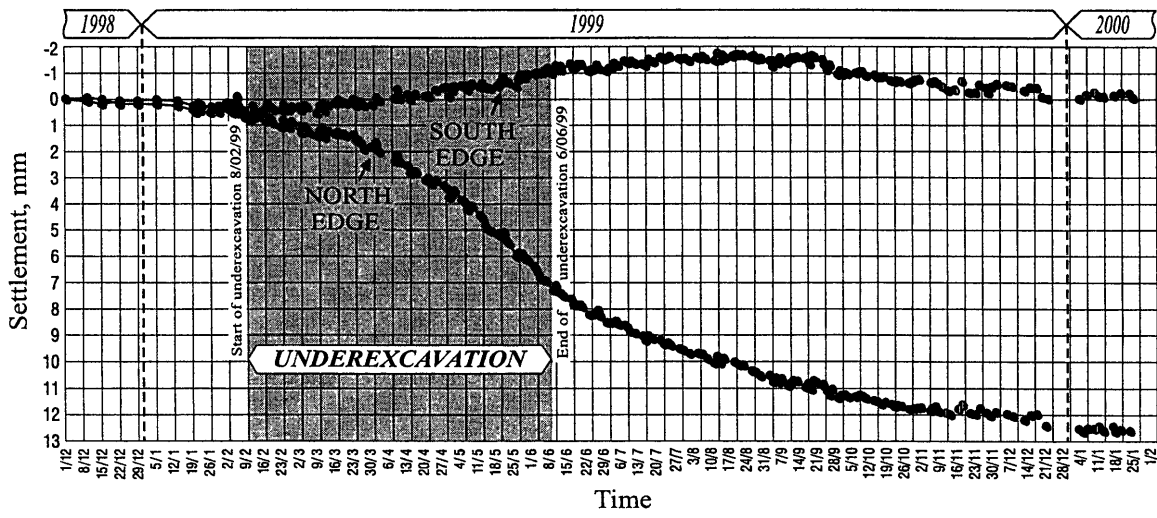
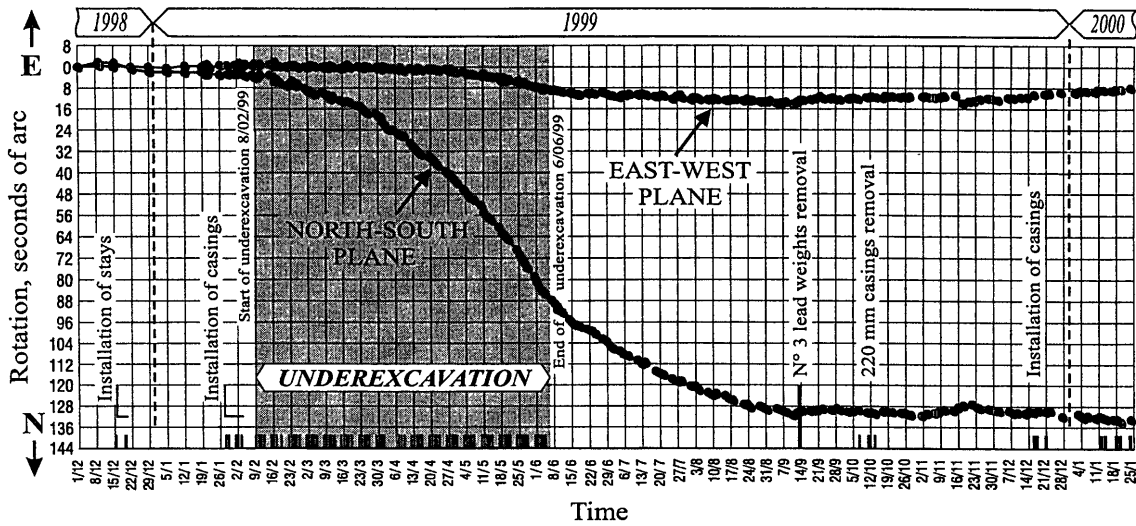

Fig. 32. Results of the preliminary underexcavation

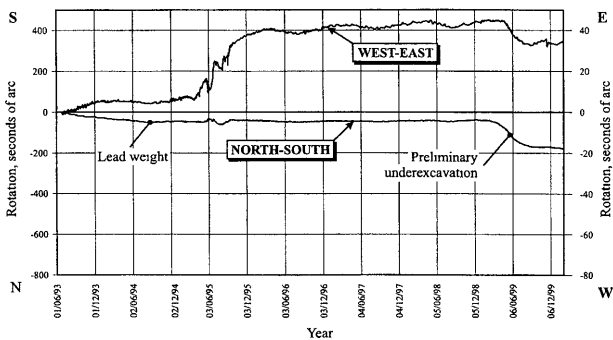

Fig. 33. Reduction of the Tower inclination from 1993 to 1999

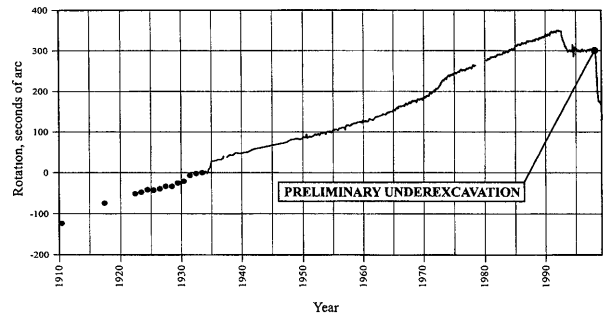

Fig. 34. Rotation of the Tower from 1911 to 1999

DRAINAGE

The level of the water table in horizon *A* is rapidly and markedly variable, under the direct influence of rainfall. In fact, it has been repeatedly observed that peaks of water level corresponding to intense rainfall events produce small and almost instantaneous southward rota-

tions of the Tower. At the end of the event, the increment of rotation is not completely recovered; the gradual accumulation of such small irreversible rotations is believed to be one of the main factors for the steady increase of inclination the Tower has experienced in the past. In order to eliminate or mitigate the process, the continuous fluctuations of the water table have to be controlled. To this aim, a drainage system connected to the gravel layer

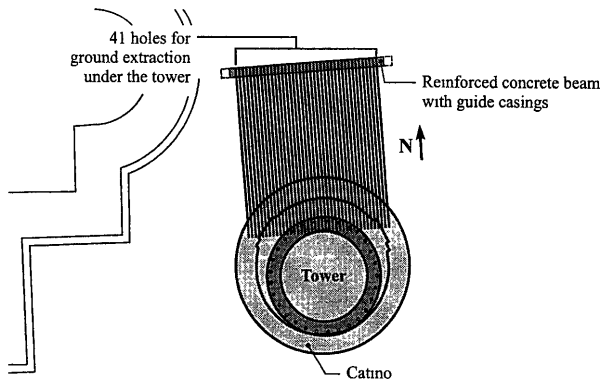

Fig. 35. Holes for full ground extraction

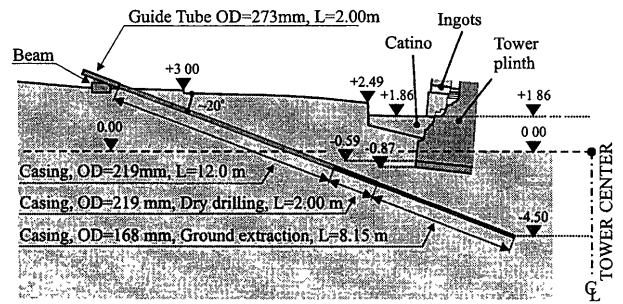

Fig. 36. A hole for full ground extraction

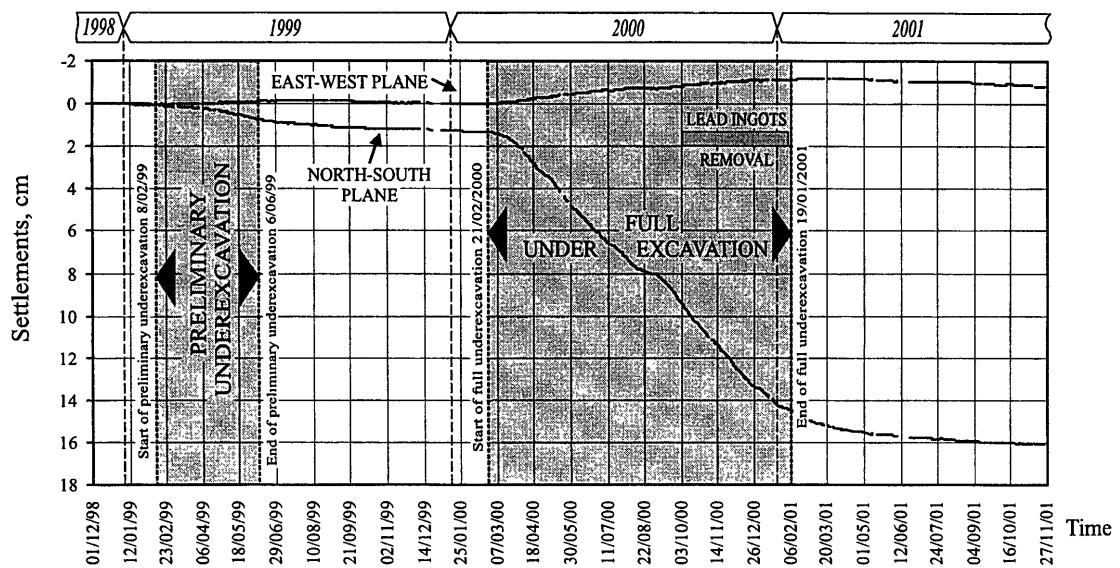
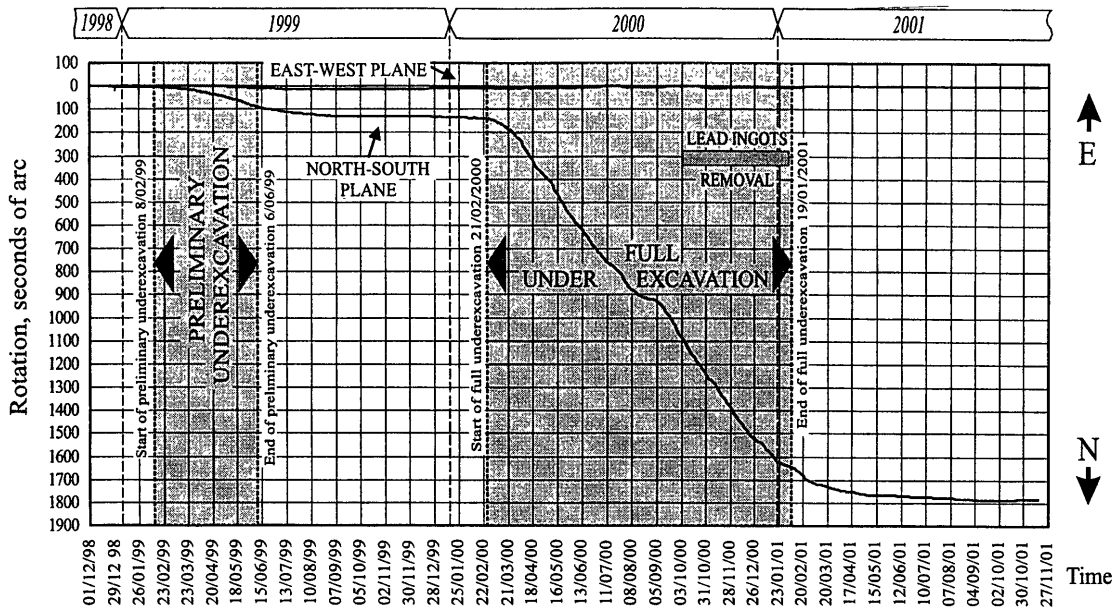

Fig. 37. Results of full underexcavation

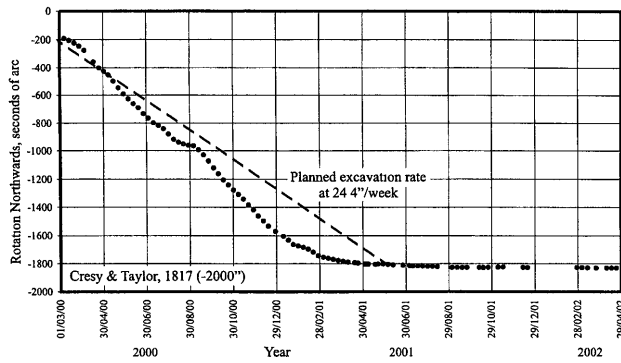

Fig. 38. Results of full underexcavation (2000-2001)

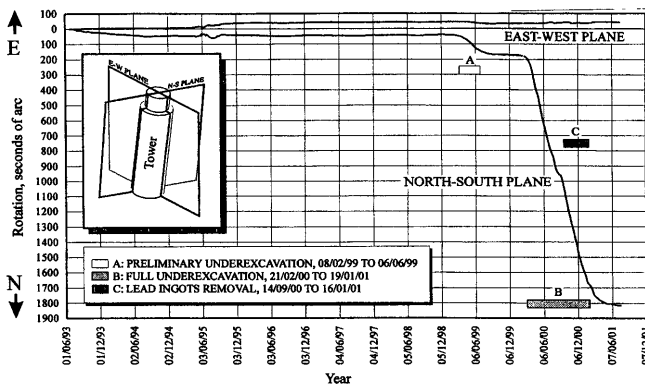

Fig. 39. Rotation of the Tower from 1993 to 2001

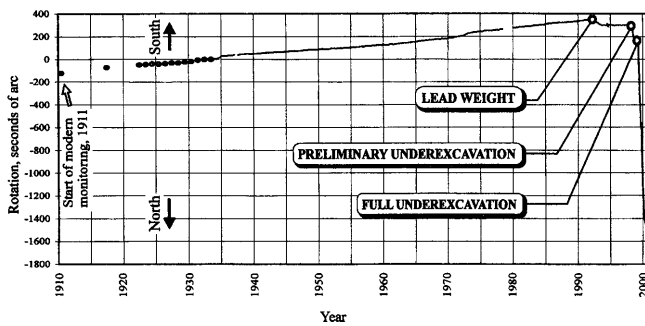

Fig. 40. Rotation of the Tower from 1911 to 2001

below the bottom of the catino has been implemented.

The system consists of three wells (A, B and C, Fig. 41) drilled to the north of the Tower, about one metre outside the perimeter of the catino. Five radial sub-horizontal drains reaching the drainage layer below the catino have been drilled from each well (Fig. 42). The wells are connected each other by an outlet pipe, discharging into a nearby sewer after having crossed two more wells, having only a constructional purpose.

The drainage system has been implemented in April and May, 2002. The decrease of the pore pressure connected with it has induced a further northward rotation of the Tower, that can be seen in the diagram of Fig. 39.

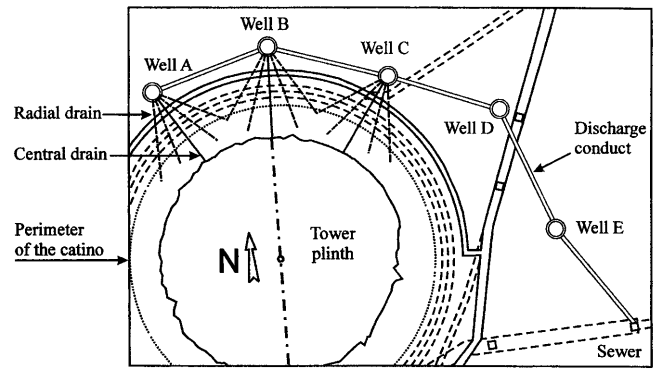

Fig. 41. Control of water table on north side—plane view

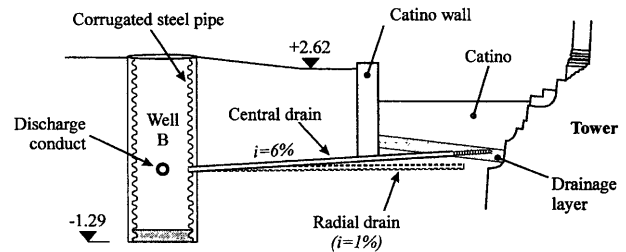

Fig. 42. Control of water table on north side—cross-section

CONCLUDING REMARKS

The stabilisation of the Tower of Pisa has been a very difficult challenge for geotechnical engineering. The Tower is founded on weak, highly compressible soils and its inclination had been increasing inexorably over the years to the point at which it was about to reach leaning instability. Any disturbance to the ground beneath the south side of the foundation is very dangerous. Therefore the use of conventional geotechnical processes at the south side, such as underpinning, grouting, etc., involved unacceptable risk.

The internationally accepted conventions for the conservation and preservation of valuable historic buildings, of which the Pisa Tower is one of the best known and most treasured, require that their essential character should be preserved, with their history, craftsmanship and enigmas. Thus any intrusive interventions on the Tower had to be kept to an absolute minimum and permanent stabilisation schemes involving propping or visible support were unacceptable and in any case could have triggered the collapse of the fragile masonry.

The technique of underexcavation provided an ultra soft method of increasing the stability of the Tower, which is completely consistent with the requirements of architectural conservation. Different physical and numerical models have been employed to predict the effects of soil removal on the stability. It is interesting to point out that some mechanisms (as, for instance, the occurrence of a critical line beyond which the underexcavation becomes dangerous) are predicted by physical modelling and by the FEM analyses, while these are missed by the simplified Winkler type models. The preliminary un-

derexcavation intervention, only undertaken once the Commission was satisfied by comprehensive numerical and physical modelling together with a large scale trial, has demonstrated that the Tower responds very positively to soil extraction. The final underexcavation has attained the target of reducing the tilt of the Tower by half a degree. The drainage system north of the Tower has further slightly reduced the tilt and will mitigate the effects of the fluctuations of the water table.

It is believed that geotechnical stabilisation has been finally attained; monitoring the behaviour of the Monument for the forthcoming few years will confirm it.

REFERENCES

- 1) Burland, J. B., Jamiolkowski, M. and Viggiani, C. (1999): The restoration of the Leaning Tower: geotechnical aspects, *Workshop on the Restoration of the Leaning Tower of Pisa*, Pre-print **105**.
- 2) Burland, J. B. and Potts, D. M. (1994): Development and application of a numerical model for the Leaning Tower of Pisa, *IS Prefailure Deformation Characteristics of Geomaterials*, Hokkaido, Japan, **2**, 715-738.
- 3) Cheney, J. A., Abghari, A. and Kutter, B. L. (1991): Leaning instability of tall structures, *J. Geotech. Engrg., Proc. ASCE*, **117**(2), 297-318.
- 4) Desideri, A. and Viggiani, C. (1994): Some remarks on the stability of Towers, *Symp. on Development in Geotech. Engrg.*, Bangkok.
- 5) Desideri, A., Russo, G. and Viggiani, C. (1997): La stabilità di torri su terreno deformabile, *RIG*, **XXXI**(1), 5-29.
- 6) Edmunds, H. (1993): *The use of underexcavation as a means of stabilising the Leaning Tower of Pisa: scale model tests*, MSc Thesis, Imperial College, London.
- 7) Gorbunov-Posadov, M. I. and Serebrajanyi, R. V. (1961): Design of structure upon elastic foundations, *Proc. VICSMFE*, Paris, **1**, 643-648.
- 8) Habib, P. and Puyo, A. (1970): Stabilité des fondations des constructions de grande hauteur, *Annales ITBTP*, 117-124.
- 9) Hambly, E. C. (1985): Soil buckling and leaning instability of tall structures, *Struct. Eng.*, **63**(3), 78-85.
- 10) Jamiolkowski, M. B. (2001): The Leaning Tower of Pisa: end of an Odessey, *Terzaghi Oration Proc. XV ICSMGE*, Istanbul, **4**, 2979-2996.
- 11) Lancellotta, R. (1993): Stability of a rigid column with non linear restraint, *Géotechnique*, **41**(2), 243-256.
- 12) Pepe, M. (1995): *La Torre Pendente di Pisa. Analisi teorico-sperimentale della stabilità dell'equilibrio*, PhD Thesis, Politecnico di Torino, 265.
- 13) Potts, D. M. and Burland, J. B. (2000): Development and application of a numerical model for simulating the stabilisation of the Leaning Tower of Pisa, *Proc. John Booker Memorial Symp. on Developments in Theoretical Geomechanics* (eds. by Smith and Carter), Sidney, 737-758.
- 14) Potts, D. M. and Gens, A. (1984): The effect of the plastic potential in boundary value problems involving plane strain deformation, *Int. J. Analytical and Numerical Methods in Geomechanics*, **8**, 259-286.
- 15) Schultze, E. (1973): Der Schiefe Turm von Pisa, *Mitteilungen Technische Hochschule Aachen*.
- 16) Terracina, F. (1962): Foundation of the Leaning Tower of Pisa, *Géotechnique*, **12**(4), 336-339.