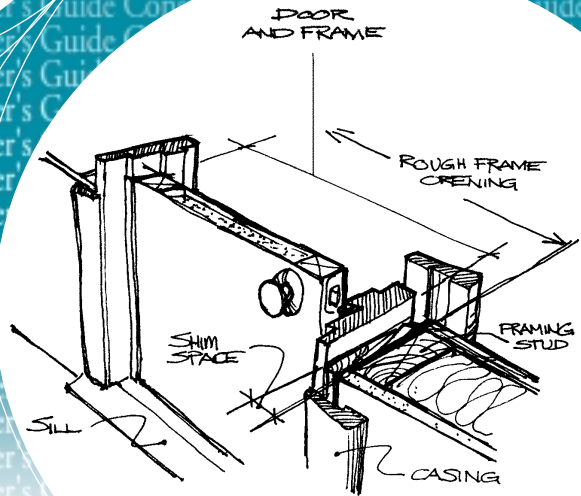
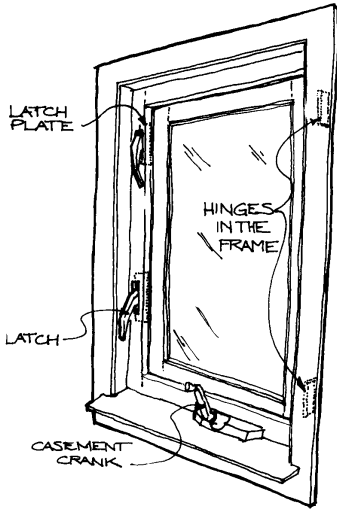




# Consumer's Guide To Buying Energy-Efficient Windows and Doors



Natural Resources  
Canada

Ressources naturelles  
Canada

Canada

## **Take the One-Tonne Challenge, a national effort to take action on climate change.**

Improving energy efficiency reduces greenhouse gas (GHG) emissions that contribute to climate change.

By using energy efficiently and making wise consumer choices, you can reduce your individual GHG emissions by one tonne, or about 20%. Like most Canadians, you probably already take steps to conserve resources and protect the environment. Now the One-Tonne Challenge calls on you to make a bigger commitment.

---

The One-Tonne Challenge asks Canadians to reduce their annual greenhouse gas emissions by 20% or about one tonne.



[www.climatechange.gc.ca](http://www.climatechange.gc.ca)

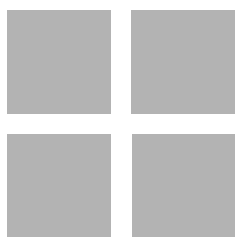
*Leading Canadians to Energy Efficiency at Home, at Work and on the Road*

The Office of Energy Efficiency of Natural Resources Canada strengthens and expands Canada's commitment to energy efficiency in order to help address the challenges of climate change.

Canada

# *Consumer's Guide*

---



**To Buying  
Energy-Efficient  
Windows and Doors**

## Canadian Cataloguing in Publication Data

Main entry under title:

Consumer's Guide to Buying Energy-Efficient Windows and Doors

Rev. ed.

*Aussi disponible en français sous le titre : Guide du consommateur – L'achat de portes et de fenêtres à bon rendement énergétique*

Title on added t.p.: L'achat de portes et de fenêtres à bon rendement énergétique

Previously published: Energy, Mines and Resources Canada, 1988.

ISBN 0-662-37461-4

Cat. No. M144-47/2004E-REV

1. Windows—Energy conservation—Handbooks, manuals, etc.
  2. Doors—Energy conservation—Handbooks, manuals, etc.
  3. Dwellings—Energy conservation—Handbooks, manuals, etc.
- I. REIC Ltd. II. Canada. Natural Resources Canada.

TH2261.C66 1994      690'.182      C94-980147-X

© Her Majesty the Queen in Right of Canada, 2004

Revised December 2004

We wish to thank the Canadian Window and Door Manufacturers Association and the Association des manufacturiers de fenêtres d'aluminium for providing their comments on this booklet.

This publication was developed under contract with REIC Limited, Aurora, Ontario.

To receive additional copies of this free publication, write to:

Energy Publications  
Office of Energy Efficiency  
Natural Resources Canada  
c/o S.J.D.S.

1770 Pink Road  
Gatineau, QC J9J 3N7

Fax: (819) 779-2833

Toll-free: 1 800 387-2000

TTY : (613) 996-4397 (teletype for the hearing-impaired)



Recycled paper

# **Table of Contents**

---

<b>Section 1 – Introduction</b>	<b>5</b>
<b>Section 2 – How to Get Started</b>	<b>6</b>
<b>Section 3 – Understanding Basic Terms</b>	<b>9</b>
<b>Section 4 – How Windows Perform</b>	<b>16</b>
<b>Section 5 – Condensation and Windows</b>	<b>20</b>
<b>Section 6 – The Ratings Game</b>	<b>23</b>
<b>Section 7 – High-Performance Windows</b>	<b>27</b>
<b>Section 8 – The Benefits of High- Performance Windows</b>	<b>32</b>
<b>Section 9 – Doors, Patio Doors and Skylights</b>	<b>35</b>
<b>Section 10 – Deciding What You Need</b>	<b>38</b>
<b>Section 11 – Getting What You Pay For</b>	<b>40</b>
<b>Section 12 – Need More Information?</b>	<b>44</b>





# Section 1 – Introduction

It has often been said that windows are the eyes of the home, allowing the occupants the opportunity to observe what is happening outside. But window functions don't just end there. We rely on windows for natural lighting and ventilation, as emergency exits, and as an integral component of the architectural style of the home.

In calling on windows to perform these many functions, we still expect our windows to be inexpensive, easy to operate and maintain, durable and attractive – and energy-efficient. Improving energy efficiency reduces greenhouse gases that contribute to climate change. Because they are called upon to perform so many functions, it may be difficult for windows to do all of them equally well.

For example, a large north-facing picture window may give you a breathtaking view of the countryside. But if the window is not very energy-efficient, the heat loss from it may be quite high; indeed, it may be very uncomfortable to sit beside this window on a cold winter day.

Fortunately, technical breakthroughs have improved window technology immensely, ushering in the era of *high-performance windows*. If your windows are over fifteen years old, it may be time to think about replacing them.

In recent years, Canadians have spent more on renovations than on new construction, with windows representing one of the largest single investments in a typical renovation. And, when it comes time for major renovations around the home, an increasing number of Canadians are paying as much attention to energy efficiency and economics as they are to architecture and aesthetics.

Remember, a typical window will last up to twenty years or more. Therefore, the decisions consumers make in the selection of windows and doors – either for a renovation or a new home – can help define energy efficiency and comfort levels in the home for years to come.

*High-performance windows and doors* – the subject of this guide – offer significant improvements in solar control, thermal comfort and energy efficiency. They do this by incorporating low-E coatings, inert gas fills, and better edge spacers and frames. This guide explains how these advances in window and door technology work, and will help you make informed decisions about purchasing windows and doors – whether you are replacing units in an existing home or designing a new home.

Section 2 shows you how to assess your current situation and what to look for in windows and doors. Section 3 walks you through a primer of window and door types and terms. Section 4 discusses how windows perform as part of the house, while Section 5 explains the causes of condensation on windows and how to reduce or prevent it.

Section 6 introduces you to the various window rating systems currently in place, with special emphasis on the ER (Energy Rating) system. Section 7 describes the advances and innovations in window components currently coming on the market in the form of *high-performance windows*.



Section 8 translates all the technical terms and performance characteristics into the bottom line for you, the consumer. It helps you appreciate the *benefits* of high-performance windows, in addition to understanding the technology.

Section 9 describes what to look for in doors, patio doors and skylights. Section 10 shows you how to develop a checklist before you shop and how to choose a supplier. It also shows you how to make informed decisions about what to buy, based on the ER number, cost and appearance.

Section 11 makes sure that you understand the importance of warranties, choosing a contractor and proper installation. And, finally, Section 12 provides you with directions on where you can obtain further information.

## ■ ■ ■ Section 2 – ■ ■ ■ How to Get Started

### 2.1 Assessing Your Situation

As with most projects, the first step is deciding where to begin. When buying a new home, you should think seriously about the quality of window that you want to have. If you are purchasing an R-2000 home, an official mark of Natural Resources Canada, this will not be so much of a problem since your builder will have selected one of the more energy-efficient windows as part of the R-2000 Initiative requirements. With window improvements, you have to determine what is wrong with the existing units, what your expectations are in upgrading, and how much you want to spend. Some problems can be solved without replacing the entire window.

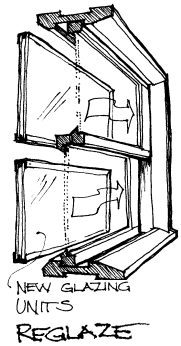
Uncomfortable drafts due to air leakage, for example, may be solved with a combination of new weatherstripping, new hardware and sealants. Interior storm windows that fit into, or over, primary window openings are another comfort solution which adds energy efficiency to an existing window. They are easy to install and remove. Costs of these storms can vary; some are disposable kits made from shrink-wrap plastic which are used only once, removed each spring and discarded.

In some cases, new windows will be required. Many frames are so inefficient, you may wish to replace them too.

### 2.2 Should You Reglaze, Retrofit or Replace?

If you're thinking of upgrading existing windows in your home, you have essentially three options. In option 1, let's say you have old, single-pane, double-hung windows in wood frames and sashes. The sashes (the part that moves) and frames (the part the sashes slide in) are in good condition, and you want to keep them. So, you decide to **reglaze** with double-paned, insulated glazing (IG) units which are custom-made to fit into the individual openings (**Fig. 1**). If the sash isn't thick enough, you may not be able to follow this option.

Fig. 1

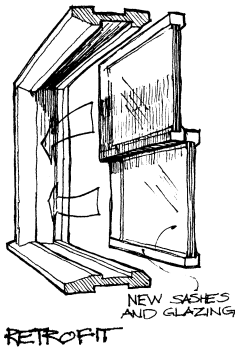


In option 2, suppose the sashes are in poor condition, but the perimeter frame is OK. In this case, you decide to **retrofit** the glazing *and* sash while keeping the perimeter frame and retaining the same window style (**Fig. 2**).

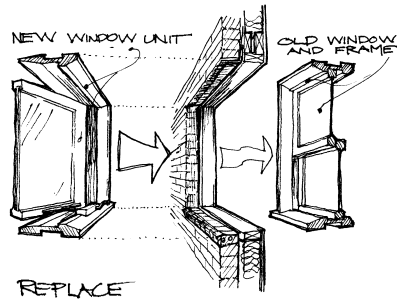
In option 3, let's assume the old double-hung window is in such bad shape that nothing is worth saving; even the perimeter frame and trim are in bad shape. In this case, you elect to **replace** the whole window as a unit – glazing, sashes, frames and all. This gives you the option of changing the style of window, say, from double-hung to vertical casement (**Fig. 3**).

Given these three options, make sure that you and your supplier are talking about the same type of installation.

**Fig. 2**



**Fig. 3**



## 2.3 Designing with Windows and Doors

The sun's energy is free. Solar energy can improve the lighting and comfort of your home, and it can cut your fuel bills; it can also provide too much warmth and cause overheating, both in summer and winter. Decisions you make at the planning stage about the number of windows, their size and location – particularly in relation to the sun's orientation at different times of the year – will be as important a consideration in determining your window requirements as their insulative properties or how they look.

For example, increasing window areas on the south side of a building can increase the contribution that the sun makes to heating the home in the winter, which may offset your heating costs. But be sure to plan for sufficient eave overhang to shade these south-facing windows in the summer months to prevent unwanted solar gain.

Until recently, an established rule of thumb in window placement was to install fewer and fixed windows on the north side of a home, to prevent excessive heat losses in the winter. Another rule of thumb recommended keeping east and west exposures to a minimum except when needed for aesthetics and daylight, in order to prevent excessive solar heat gain in the summer.

But over the past several years the rules for window placement have changed with advances in window technology. The arrival of *high-performance windows* (see Section 7) has given consumers more choice in window selection – whether it’s for an existing home renovation or for specifying in a new home.

Remember the following rule of thumb: keep the ratio of window area to floor area at about 1:10. That is, for every square metre of window area, make sure you have at least ten square metres of floor area. This will prevent overheating in the living space due to too much solar gain. There are also code requirements in many areas for kitchens, and dining and living rooms.

If you combine traditional passive solar design principles (described in Section 4) with high-performance windows (described in Section 7) you can get much greater net solar gain while reducing your energy consumption for space heating and cooling.

And remember, doors also play an important part in the energy performance of the home, especially if you have a lot of patio doors. Depending on the condition of existing doors, energy-efficient replacement units may contribute to increased comfort and reduced energy bills. An added bonus of energy-efficient doors is that they tend to be heavier and more robust than conventional doors, thus enhancing the security of the home.

## 2.4 What to Look for in Windows and Doors

The wide variety of windows and doors available on the market can make the task of selecting appropriate units confusing. Price may not always be the determining factor. The cheapest units you can find may not perform at the level you want. However, some inexpensive units may perform as well as, or even better than, higher-priced models. The best advice to keep in mind is that price is not always an indication of quality or performance.

The cost of energy-efficient, high-performance windows can be 10 to 15 percent more than the standard double-glazed unit. However, many window manufacturers are switching over their entire production line to produce only high-performance units so, in effect, there is no price differential as far as they are concerned. Today, the *high-performance window* is becoming the industry standard. Read about it in Sections 7 and 8.

But it can still be confusing. For example, some window manufacturers include low-E coatings in their standard windows, with gas fills as an upgrade, at higher cost, while others offer gas fills *and* special coatings as an upgrade. (See pages 27 to 29 for an explanation of low-E coatings and gas fills.)

Once you’ve done your homework by reading this guide, you’ll be better prepared to ask the right questions when you shop for windows and, equally important, know when you’re getting the right answers.

The key is to select windows or doors that are as energy-efficient as possible, given your needs and budget. Remember that some *super* high-performance windows may cost considerably more than normal high-performance windows. The energy rating (ER) system described in Section 6 will give you an indication of the energy benefits. In most cases, the more efficient

unit will probably offer other advantages, such as better comfort and resistance to condensation in very cold climates.

Don't forget to consider the advantages and disadvantages of framing materials, as well as the maintenance required and the durability of hardware. Windows are a long-term investment.

Inspect samples before making a decision, taking into account the following basic features described in greater detail in this publication:

- **Window type** may be fixed or operable.
- **Glazing type** affects energy efficiency and the amount of light which passes through the window.
- **Frame materials** affect the insulation value, strength, maintenance requirements and longevity of the window.
- **Energy performance (ER)** – there may be a trade-off between efficiency and price.
- **Warranties** differ from supplier to supplier and window to window; compare before you purchase.

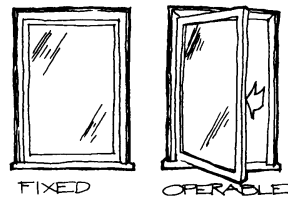
## Section 3 – Understanding Basic Terms

### 3.1 Window and Door Types

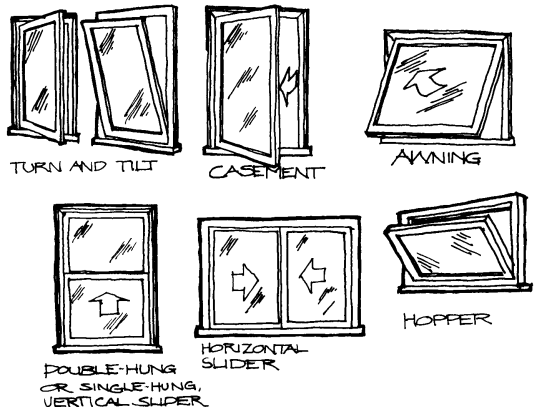
There are two types of windows: those that open and those that don't – called *operable* and *fixed*, respectively (**Fig. 4**). Use as many fixed windows as codes allow, keeping in mind that floors with bedrooms need at least one operable window for emergency exit. Fixed windows are more efficient because of their better airtightness characteristics. They also offer the most safety and security.

Of the operable units, there are many forms: awning, casement, hopper, horizontal slider, vertical slider (either single- or double-hung) and turn-and-tilt (**Fig. 5**).

**Fig. 4**

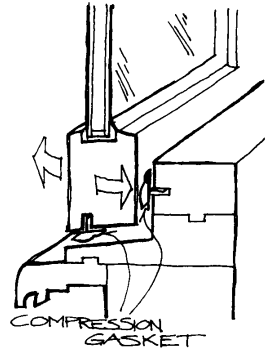


**Fig. 5**



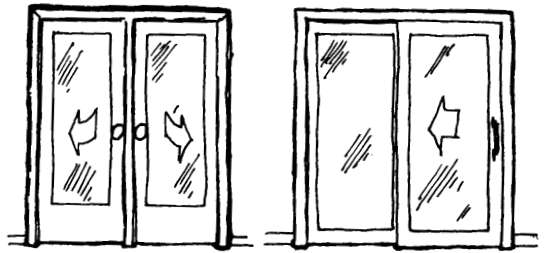
There are two ways of sealing operable windows to minimize air leakage: with a *compression* or a *sliding* seal. Windows with compression seals are generally the more airtight of operable types and should be the window of choice whenever possible. Casement, awning, hopper and turn-and-tilt windows, for example, should have a closure/locking mechanism that pulls the unit tight against the seal (**Fig. 6**). Make sure the gasket is a compression, neoprene rubber type.

**Fig. 6**



Doors are a little less complicated. They are either: solid, solid with an insulated core, solid with window(s), or solid with an insulated core and window(s). Patio doors operate like a large horizontal sliding window. Hinged French doors, with a solid centre post to close against, or rolling doors with a compression-fit like an aircraft door, are more energy-efficient (**Fig. 7**).

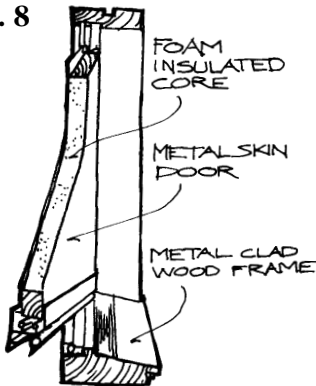
**Fig. 7**



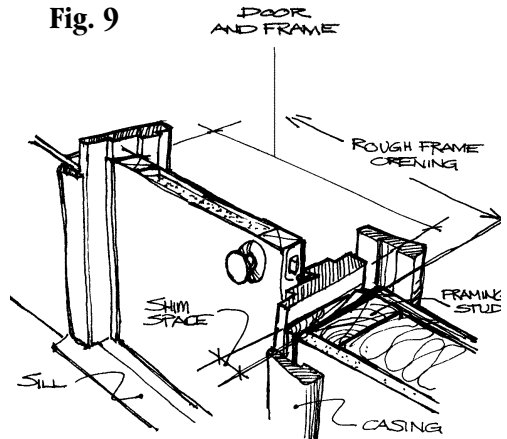
Some materials reduce heat flow better than others. Solid wood doors, for example, are not as good as metal-clad, insulated core doors, depending on the style of door and insulation material used to fill it (**Fig. 8**).

Otherwise, doors have a frame, sill, optional glazing, and rough frame opening in a wall as do windows (**Fig. 9**). Like windows, some doors are even installed in the frame and sill system while still at the factory.

**Fig. 8**



**Fig. 9**



### 3.2 Glazing Parts

Glazing is the generic term for the transparent – or sometimes translucent – material in a window or door. A window may be divided into one or more sashes, some of which may move and others which may be fixed. For example, a double-hung window generally has two moveable sashes, while a single-hung window has just one moveable sash (**Fig. 10**).

A sash may be divided into two or more *lights* (panes of glass) held in place by mullions and muntins (**Fig. 10**).

**Fig. 10**



### 3.3 Glazing Types

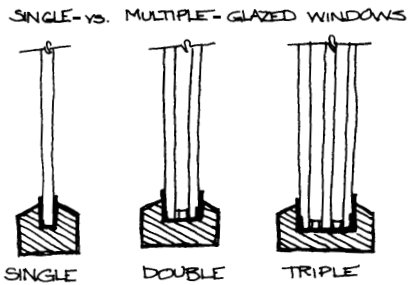
When we speak of windows, we tend to use the terms single-, double- or triple-glazed. These terms simply refer to the number of panes of glass incorporated into the window unit: single-glazed – one pane; double-glazed – two panes; triple-glazed – three panes (**Fig. 11**).

All windows in Canada should be at least double-glazed. To determine the number of glazings in a particular window, hold a light next to the glass and count the reflections (**Fig. 12**). In a double-glazed window, for example, you'll see two main reflections, corresponding to the number of glazings. (If you look carefully at each reflection, there are actually *two* reflections very close together, bouncing off both surfaces of each pane.)

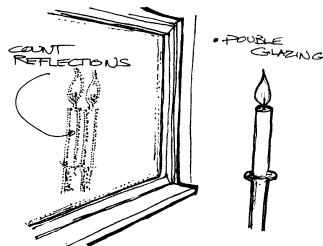
Most window manufacturers offer several types of glazing, which affect the insulation value of the window and the likelihood of condensation forming on the glass. Sometimes, transparent plastic films are placed inside the glazing unit between the panes of glass to increase energy efficiency.

A variety of coatings on the glazing surfaces – plastic films, or inert gases between glazings, for example – can increase the insulating value of a double-glazed window to more than equal that of a standard triple-glazed window. Coatings are often used with gas fill. (See Section 7 for a more detailed discussion of special coatings and gas fills.)

**Fig. 11**



**Fig. 12**



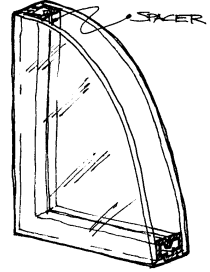
Most windows now incorporate sealed, insulated glazing (IG) units in which two or more glazing layers are sealed around the outside edge to prevent air or moisture from entering the air space, eliminating dirt and condensation between glazings. If moist air finds its way into the sealed air space, condensation may form between the glazings. This is usually caused by a faulty seal and cannot be corrected except by replacing the IG unit.

### 3.4 Spacers

If you look between the window panes in a conventional double-glazed window where the glass meets the frame, you will probably see a strip of material, known as a spacer. The purpose of spacers is to maintain a uniform separation between the panes of glass (**Fig. 13**).

Spacers have traditionally been made of hollow aluminum, containing a drying agent or desiccant designed to absorb the initial moisture present at the time of manufacture in the space between the glazings. Metal spacers conduct energy easily and are a significant source of heat loss and poor window performance. The best insulating spacers are often made from non-metallic materials. There are also hybrid spacers made out of metal and non-metallic materials. These materials do not conduct nearly as much heat (see Section 7.4).

**Fig. 13**



### 3.5 Frames and Sashes

A window consists of a glazed unit, a frame and a sash. The glazed unit fits into the sash, and the frame holds the sash. The frame and sash may occupy as much as one third of the total window area. Both the frame and the sash can be major sources of heat loss. This heat loss is a result of conduction through the material. Heat loss can also result from air leakage, sometimes increased by expansion and contraction or warpage of a window's frame or sashes. Highly conductive materials used in the construction of the frame and sash must have thermal breaks incorporated in order to reduce heat loss. A large amount of heat loss through the sash and frame will result in the formation of condensation and frost on interior window surfaces.

Frames and sashes are manufactured from a variety of materials – aluminum, fiberglass, vinyl, wood, and combinations of these materials. Each material has benefits and drawbacks in terms of insulating value, strength, durability, cost, aesthetics and maintenance requirements. Good quality windows can be made using any of these materials. **Use the Energy Rating (ER) to compare energy performance.**

The **ER** for windows takes into account the thermal performance of the frame, sash and the glass. Please refer to Section 6 of this guide for more details on the ER system and the CSA-A440 window standard.

## General Considerations

Check the following points on a full-sized window; some features may be visible only on a cutaway sample. Look carefully at the product literature and ask a sales representative to explain the features to you.

- Check for strong, tight-fitting sealed joints to prevent air and water leakage.
- For windows that require thermal breaks, inspect a corner cutaway sample of the frame and the sash. Ensure that the exterior and interior surfaces are separated by an insulating material (thermal break).
- For larger and heavier windows, inquire if additional reinforcement is required and how this might affect the thermal performance.
- The insulated glazing unit is held in the sash using various sealing methods to prevent water from entering the interface between the glass unit and the sash. Check the sealing system on both the interior and the exterior surfaces for an effective continuous seal. Trapped water in the sash is probably the greatest cause of failure of the glazing unit. Some manufacturers incorporate a drainage system into the sash; this feature allows any water that may otherwise be trapped to drain away.
- A price and quality comparison is essential. Low-priced, poor quality windows are not a good, long-term investment. Energy-efficient, durable and low-maintenance windows will provide energy savings, increase comfort levels, reduce or eliminate condensation on the interior surface of windows and last longer.

## Aluminum

Aluminum frames are strong and durable. Aluminum maintains its strength, offers low maintenance and resists warping. Aluminum frames and sashes must be designed with thermal breaks to reduce conduction heat loss. Use the ER number to assess the effectiveness of the thermal break.

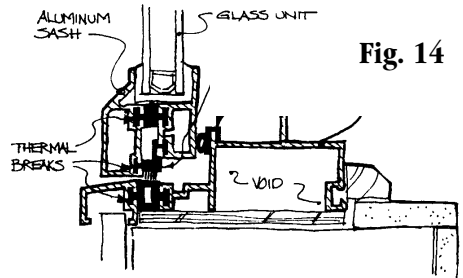


Fig. 14

## Fibreglass

In terms of energy performance, fibreglass frames rate highly. In some designs the hollow sections of the frame and sash are filled with foam insulation to further decrease heat loss. Fibreglass frames offer good structural strength and durability, and require minimal maintenance.

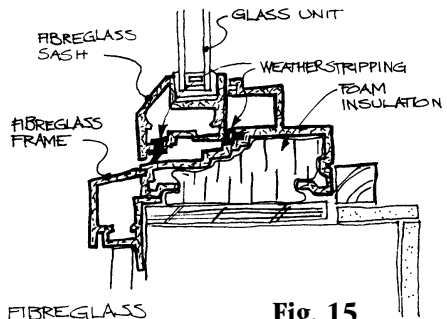


Fig. 15



## Vinyl

Extruded vinyl frames provide good thermal performance, and are easy to maintain. Large vinyl windows may be reinforced to increase their strength; some reinforcing materials may increase conductive heat loss. Use the ER number to assess the effect of the reinforcing material on thermal performance. Thermally welded corners can prevent air and water leakage if the welds are continuous. Hollow sections of vinyl frames can be filled with foam insulation to improve thermal performance.

## Wood

Solid wood frames have a good insulating value and structural strength but require protection from the weather. Low-maintenance, factory-applied claddings and finishes are available. They must prevent water from becoming trapped behind them. Look for well-sealed corners as well as gaskets between the cladding and the glazing. Heat-conductive cladding materials should not touch the glazing or extend in from the outside of the window towards the interior. When installed in this manner, they can cause condensation problems and lower the thermal performance of the window.

## Combination and Composite

The combination window frame or sash combines two or more materials, such as aluminum, fiberglass, wood and vinyl. The objective is to obtain the best features of each material so that the frame and sash will provide good thermal performance, durability and strength, and require minimal maintenance. Combination windows use different materials separately in appropriate areas, while windows made out of composite materials have frames and sashes made out of materials such as fiberglass and wood that have been “blended” together through a manufacturing process. Composite materials essentially adopt the positive attributes of the materials from which they are made, in a single unified form.

Fig. 16

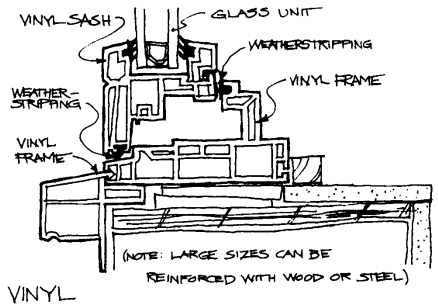


Fig. 17

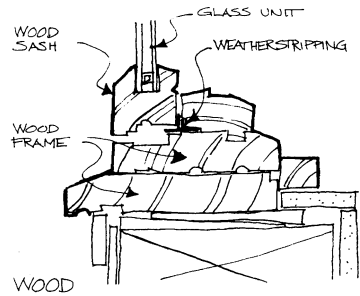
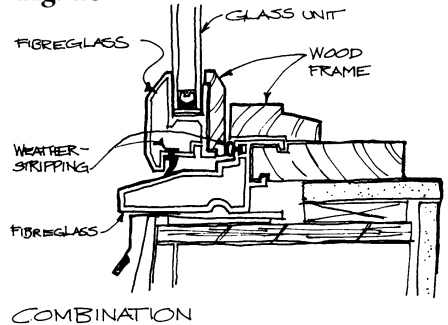


Fig. 18



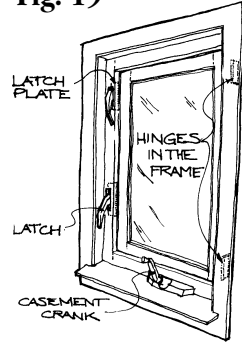
No matter what frame and sash materials you consider, remember that the ER number is your best indicator of window energy performance.

### 3.6 Hardware

Window hardware includes the hinges, casement cranks, handles, latch plates, etc., of operable units (**Fig. 19**). The quality of hardware and hardware placement can affect the performance of the weatherstripping.

Weather changes can affect the durability of the hardware design, its attachment, and window members to which it is attached. During a cold winter, opening a window may cause problems if ice builds up, making it difficult to close the window tightly.

**Fig. 19**



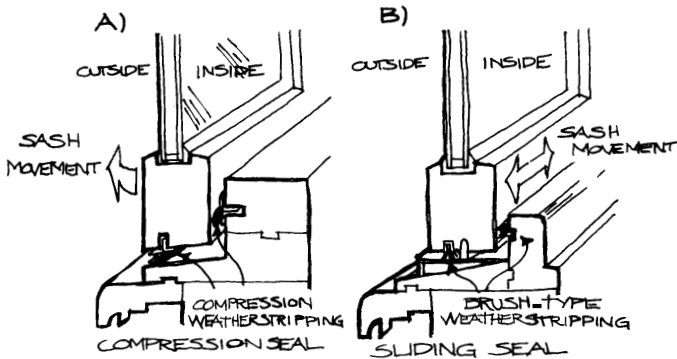
### 3.7 Weatherstripping

Windows should use durable, flexible gaskets to make an airtight seal between the operating sash and the window sill and frame. An airtight seal is also needed between a door and its frame. The airtightness of the joint between operable sashes and a window frame or between a door and frame depends on the type of weatherstripping used and the amount of pressure that can be applied on the joint.

Compression seals (**Fig. 20 a**), which can be squeezed tightly between the moving sash and the window sill and frame, and which are resilient over many years and not subject to cracking or other deterioration, are better than sliding seals with brush-type weatherstripping (**Fig. 20 b**).

You may not be able to avoid brush-type seals, especially if you are selecting horizontal sliders. On this type of window, look for thick brush seals with a thin flexible plastic flange embedded in the brush to minimize air leakage.

**Fig. 20**





## Section 4 –

# How Windows Perform

Before making a decision about which windows to buy, it is useful to review how windows perform, in terms of how they allow a home to gain energy from the sun, and how they affect energy loss when the sun isn't shining.

### 4.1 Factors Affecting Gains

There are several factors affecting the ability of windows to capture solar heat. They include: 1) placement and orientation; 2) design of the window unit (and the amount of clear window opening); 3) the type of glazing used; and 4) the amount of interior and exterior shading.

#### Placement and Orientation

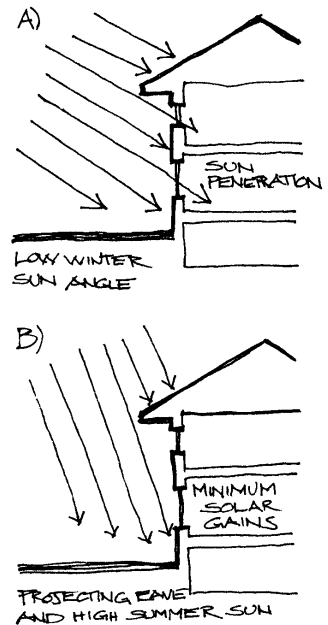
Placement and orientation of the window with respect to the sun will be the primary determining factor affecting solar gains, although some gain is possible in all directions from diffuse sky radiation.

During the winter, the sun's low elevation in the sky at midday enables it to shine through south-facing windows (**Fig. 21 a**). These *solar gains* can help reduce your heating costs during the winter.

In the summer, when the sun is much higher at midday, very little sun actually strikes a south-facing window (**Fig. 21 b**). And what sun does reach the window is at such a low angle that it reflects off the window. Awnings or a modest eave overhang can be used to shade south windows in the summer to minimize these unwanted heat gains even further. Properly placed, these shading devices shouldn't interfere with winter solar gains.

Overheating in summer tends to occur more from unshaded west-facing windows and, to a lesser extent, east windows. Well-placed deciduous trees will reduce summer overheating while permitting desirable winter solar gains.

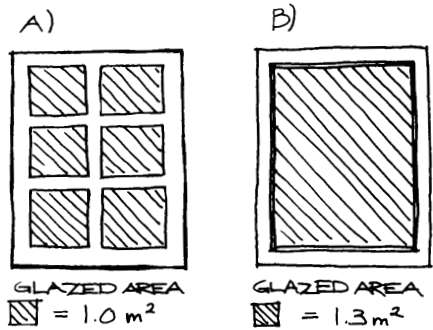
**Fig. 21**



## Window Design

The design and heat gain factor of a window will also have a bearing on its ability to capture solar heat. A window with a wide frame and numerous small lights separated by mullions and muntins has less glazing area available to capture solar energy (**Fig. 22 a**). By contrast, a window in the same rough opening with a thin frame and one large light will have a greater proportion of glass to frame area and so will allow more sunlight into the living space (**Fig. 22 b**).

**Fig. 22**

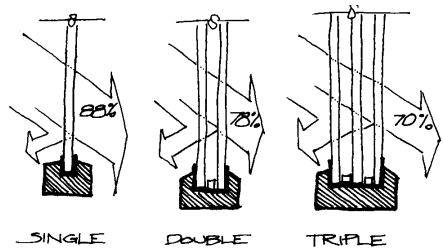


## Glazing Choice

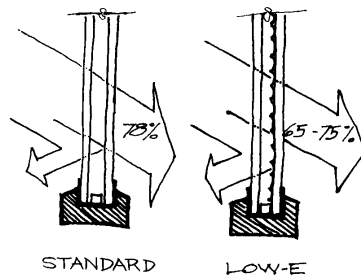
The number of glazing layers will also affect solar gains. For example, a triple-glazed window with ordinary glass reduces solar gain by 20 percent compared to a single-glazed window with the same glazing area. A double-glazed unit reduces solar gain by about 10 percent. (**Fig. 23**).

Glazing coatings and tints also make a difference. Clear glass transmits the most solar energy into a building. Tinted glass and glass with special insulating low-E coatings (discussed in Section 7) can reduce solar gains by up to one third. For example, a double-glazed window with a low-E coating on one glass surface may transmit up to 20 percent less solar heat to the interior, compared to a double-glazed window of similar area with standard glass (**Fig. 24**). Different types of low-E coatings vary greatly in terms of their effect on solar gains. Some that are designed for southern climates are not appropriate for use in Canada.

**Fig. 23**



**Fig. 24**



## Shading

The shading of windows, either from interior drapes and curtains, or from exterior landscape elements such as trees, will also influence the amount of solar gain. On sunny days during the winter, keep the drapes open to admit as much solar gain as possible.

Remember that the types of trees and shrubs you plant near your windows may affect the winter solar gain potential of the windows. Select deciduous trees with thin branching characteristics for southern exposures. They will provide shade in the summer but will lose their leaves in the fall and allow more sunlight through.

## 4.2 Factors Affecting Heat Losses

There are several processes at work which influence rates of heat loss through window components. These processes follow a basic law of nature: *heat energy tends to move from warmer areas to colder areas*. There is no way to get around this fundamental principle; all we can do is slow the processes down.

The principal heat transfer processes in windows are *radiation*, *conduction* and *convection*. In addition, *air leakage* is responsible for a significant portion of heat loss.

### Radiation, Conduction and Convection

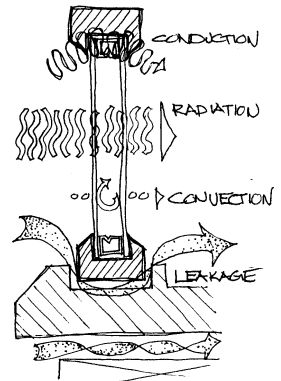
Absorbed by the inside pane of a double-glazed window, heat moves to the cooler outside pane and is released to the outdoors. This heat loss through windows takes place through the glazing (by radiation); across the spacer material which separates the two glazing layers at their edges and through the frame of the window (by conduction); through the movement of air in the space between the two glazings (by convection); and between the moveable or operable frame components (by air leakage) [Fig. 25].

*Radiation* losses through the window glass represent about two thirds of the total heat loss in a standard window. Because ordinary glass readily emits heat to colder surfaces (i.e., has a high emissivity), radiation losses can be reduced by lowering the emissivity of the glass (hence the term *low emissivity* or *low-E* glass).

*Conduction* losses in windows occur primarily through the edges and frames of the units. Advances in materials and designs that more effectively use insulating materials have dramatically reduced these losses.

*Convection* losses occur due to air movement between the spaces of multi-glazed windows. If the space is too small, conduction through the air is significant. If the air space is too large, the still air will begin to rise as it is heated on the warm interior side, and fall as it is cooled on the cold exterior side of the window. This convection movement of the air passes heat to the exterior. The best spacing to minimize convection losses is 12 to 16 mm (one half to two thirds of an inch) between the glazings. Other gases (argon, krypton) are often used to reduce convection heat loss. Optimum spacing for these gases can be different.

**Fig. 25**



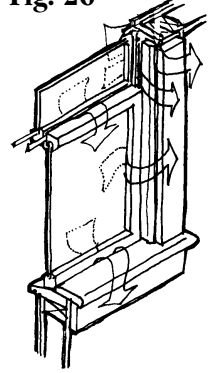
## Air Leakage

Air leakage is a significant contributor to energy costs during both heating and cooling seasons. Most of the air leakage of operable (i.e., openable) windows occurs between the window's sash and frame, or at the meeting rails of a sliding sash (**Fig. 26**). Bigger windows tend to leak less air per unit area. Air leakage can also occur in poorly constructed fixed windows between the insulated glass unit and the frame. (Remember: even in these types of windows, holes are required to effectively drain rainwater.)

Windows with the lowest leakage rates, regardless of type, tend to be *fixed* windows, that is, windows you can't open. Operable or openable windows come in many types, as described in Section 3. The operable windows with the least rates of air leakage are awning, casement and similar types with a closure mechanism which pulls the sash against a compression gasket, as shown in **Fig. 20 a**.

Air leakage can also be a big problem if the windows are poorly or carelessly installed in the rough opening. If the space between the outside perimeter of the window frame and the rough opening isn't sealed with either caulking or foam insulation, air will leak through it. This space should be insulated and sealed before the window trim is attached.

**Fig. 26**



## 4.3 Balancing Gains and Losses

As we have seen, there is a great deal of two-way “traffic” passing in both directions through windows. South windows often gain more solar energy during the day than they lose at night through convection, radiation and conduction losses.

North windows are usually net losers of energy, while east and west windows tend to be neutral during the heating season. However, during the summer, west windows may be net gainers of energy, posing an overheating problem.

High-performance window technology is pointing the way to significant improvements in this balancing act between gains and losses — maximizing gains when needed, while at the same time minimizing heat transmission as never before.



## Section 5 – Condensation and Windows

### 5.1 What Is Condensation?

The occupants of a house rightly feel that condensation on the inside surfaces of windows is not good. They immediately think of obstructed visibility, reduction of the intensity of natural lighting and, above all, deterioration of interior finishes (rings, stains, peeling paint) and mould.

Superficial condensation occurs when the surface temperature of a solid (glass, sash, frame) is lower than the dew point of the humid air in its immediate vicinity. The moisture, naturally present in the air in the form of vapour, changes into liquid water on contact with these cold surfaces. The resulting droplets form a film of water and run down the glass when the condensation is heavy or does not evaporate fast enough. In the case of windows, condensation will often occur at the edge of the glazing because of conduction through the spacer and air convection within the glazing cavity. Such condensation can be decreased or eliminated by raising the inside surface temperature and/or decreasing the relative humidity of the indoor air.

### 5.2 Prevention Techniques

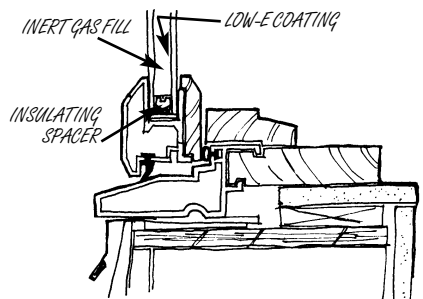
Reducing or eliminating condensation often means using several complementary techniques. These techniques concern the window itself, the method of installation, the interior window accessories (curtains, blinds, valances), the arrangement of heat sources (hot air registers, baseboard heating, convection heaters) and the relative humidity of the indoor air. The overall condensation resistance of a window depends on each of these factors.

### 5.3 Condensation Resistance of Windows

Several techniques are used by manufacturers to increase the condensation resistance of windows. These include windows filled with a convection-limiting inert gas, low-emissivity coatings that increase the temperature of the glass, insulating spacers that reduce heat conduction, and non-conducting sashes and frames (**Fig. 27**).

Energy-efficient windows are least likely to have condensation. Their resistance to condensation, however, depends on the indoor humidity level. A humidity level of more than 40 percent, when the outside temperature is  $-20^{\circ}\text{C}$  or colder, may cause condensation even on a well-performing window.

**Fig. 27**



## 5.4 Window Installation

To minimize condensation on windows, follow these guidelines during installation:

- position the window as close as possible to the interior finish;
- insulate the space between the window frame and the rough opening around the perimeter of the window; and
- seal the joint between the frame and the rough opening on the interior side.

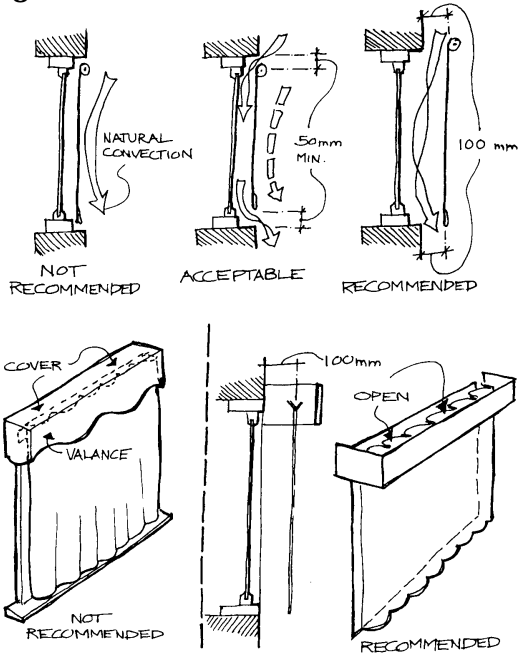
Section 11 discusses window installation in more detail.

## 5.5 Interior Window Accessories

To maintain the condensation resistance of the window, interior window accessories such as curtains, blinds and valances must not inhibit or impede the movement of air at the surface of the window. Any restriction of air movement will reduce the condensation resistance and thus increase “sweating” on the window.

**Fig. 28** illustrates installation techniques that are recommended, acceptable or not recommended.

**Fig. 28**



## 5.6 Arrangement of Heat Sources

Although energy-efficient windows are now available, the heat loss through them is still greater than through the adjacent walls. This is why windows with heat sources located below them are less prone to condensation. When the heating system is in operation, the air temperature will be higher in the vicinity of the window than in the centre of the room, resulting in increased condensation resistance. Care must nevertheless be taken to

ensure that the hot air from the registers does not flow directly onto the interior surface of the glass, as this could give rise to thermal stress problems in the glazed unit that could cause the glass to break.



## 5.7 Controlling the Relative Humidity of Indoor Air

Replacing old windows with new, more efficient ones generally results in a significant improvement in the airtightness of the building enclosure, and thus substantial energy savings and improved comfort for the occupants.

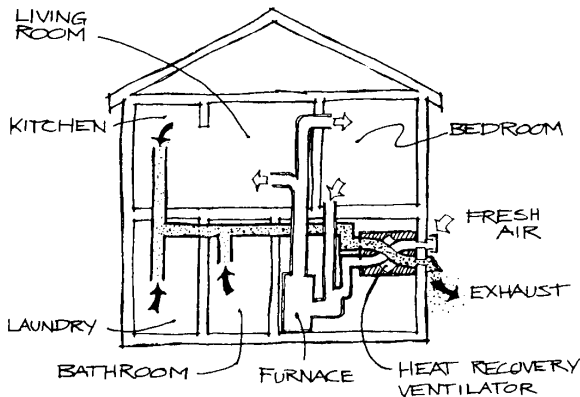
However, when living habits and the production of humidity in the house (showers, baths, cooking activities, plants, etc.) remain unchanged, and there is a significant reduction in the rate of air exchange, the resulting relative humidity at certain times during the winter may become excessive and cause condensation on the inside surface of new windows.

Reducing the amount of humidity in the house may enable you to limit or eliminate the problems caused by humidity. Some simple but effective measures can be applied.

- If your heating system is fitted with a humidifier, or if you use portable humidifiers, disconnect them.
- Avoid hanging laundry inside to dry, and make sure that the exhaust from the clothes dryer is vented outside.
- If you have a crawl space under your house, cover the beaten earth with 0.15 mm (6 mil) polyethylene. The crawl space may have to be ventilated during the summer.
- Make sure that your basement is well drained and protected against excess moisture. Also, make sure that gutters and the slope of the land around the house drain water away from the house.
- Try not to produce too much humidity. Plants, laundry, showers and cooking without lids are major sources of water vapour.
- Avoid drying firewood in the house. A cord of wood can release more than 270 litres (60 gallons) of water.

If the signs of excessive humidity persist, you should increase the ventilation of your house. When the frequency of condensation is low (once or twice during winter), you can reduce or eliminate the problem by briefly opening two windows located on opposite walls or by turning on the kitchen or bathroom exhaust fan. If the frequency of condensation is unacceptable, you should install a controlled mechanical ventilation system (**Fig. 29**). Systems incorporating a heat recovery unit and a relative humidity control are preferred.

**Fig. 29**





## Section 6 – The Ratings Game

Now that you know something about window technology and how windows perform, you're probably asking yourself "How can I verify the performance claims of manufacturers? How do I compare different window types, or the different product lines of various manufacturers? How do I decide which window type is best for my situation? Most importantly, how can I be sure I'm getting what I pay for?"

### 6.1 Certification, Testing and Standards

With the rapid growth in window technology improvements, a number of organizations and industry associations have been trying to sort out performance standards and certification procedures, both for industry and for the protection of consumers.

For example, the Canadian General Standards Board (CGSB) has had in place for some time an insulated glass unit (IGU) standard which sets performance limits on the durability of window edge seals (CAN/CGSB 12.8). CGSB also has a standard for sliding doors (CAN/CGSB 82.1).

The Insulating Glass Manufacturers Alliance (IGMA) certification program requires manufacturers to meet quality control standards and the CGSB edge seal standard (CAN/CGSB 12.8). All IGMA-certified products bear the following information: *IGMA logo*, along with a *date*, the *company name* and the *place of manufacture*. This information is normally stamped into the spacer bar between the glazings or etched onto the glass.

CSA International has a voluntary certification program for windows and doors. For further information, you should contact them at 1 800 463-6727.

## 6.2 CSA Standard A440

The Canadian Standards Association (CSA) has established the CSA-A440 standard. It is called an *omnibus* standard because it applies to windows constructed from diverse materials. It describes how to measure and rate a window's *airtightness, watertightness, wind resistance, condensation resistance, forced entry resistance, ease of operation, and other requirements*. It also sets out minimum requirements for all components and their materials, from hardware, insect screens or weatherstripping, to finishes, adhesives and thermal performance. In addition, all windows must be designed to allow on-site reglazing.

The CSA-A440 rating is a minimum to start with when purchasing new windows.

Independent testing by accredited laboratories assures each model meets minimum levels

of performance in the three categories: *airtightness, watertightness* and *wind resistance*. The *National Building Code of Canada* and most provincial/territorial building codes now require that windows used in new low-rise residential construction and renovations meet CSA-A440 requirements and have at least an A1, B1 and C1 performance rating (**Fig. 30**).

In general, a window can achieve high resistance to air, water and wind only by incorporating tight-fitting corner joints, good seals, proper gaskets and weatherstripping. Look for a window with a minimum A1, B1, C1 rating and a high Energy Rating number (CSA-A440.2; described in Section 6.3). There are also optional parts of this standard against which manufacturers may wish to rate their product, in areas such as condensation resistance, forced entry, etc.

Fig. 30

<b>Window Ratings</b>	<b>Max. Air Leakage Rate (m<sup>3</sup>/h)m<sup>-1</sup></b>
A1	2.79
A2	1.65
A3	0.55
Fixed	0.25
<b>Window Ratings</b>	<b>Water Leakage Test Pressure Differential (Pa)</b>
B1	150
B2	200
B3	300
B4	400
B5	500
B6	600
B7	700
<b>Window Ratings</b>	<b>Wind Load Resistance Test Pressure (kPa)</b>
C1	1.5
C2	2.0
C3	3.0
C4	4.0
C5	5.0

### 6.3 The Canadian Energy Rating (ER) System

Although CSA-A440 protects the consumer and is the minimum performance standard referenced in most building codes, the bottom line for the energy-conscious consumer is a window's Energy Rating, or ER number, based on the CSA-A440.2 *Energy Performance of Windows and Other Fenestration Systems* standard, which applies to all windows and sliding glass doors, and the CSA-A453.0 which applies to all swinging or entry door systems.

A window's ER rating is a measure of its *overall* performance, based on three factors:

1) solar heat gains; 2) heat loss through frames, spacers and glass; and 3) air leakage heat loss. A number is established in watts per square metre, which is either positive or negative, depending on heat gain or loss during the heating season. The range is wide. **Fig. 31** lists the typical ER ratings for windows most commonly available.

The ER system is based on a formula which calculates a single ER number for a specified window size in each of seven window categories (e.g., a 600 mm by 1220 mm / 24 inch by 48 inch casement selected as representative of that window type). Because all window Energy Ratings (ER) are evaluated in the same way, this makes it easy to do comparison shopping between different manufacturers – although a consumer should be aware that the rating given will be for windows in the standard size, and *not* a particular window.

However, there are still several things to keep in mind when comparing ER numbers of different windows. As you can see by looking at **Fig. 31**, most fixed windows tend to have better (higher) ER numbers than operable ones. There are two reasons for this. First, the standard size for a fixed window is nearly twice as large as most of the operable windows and thus has more glass area relative to frame area. Frames are also thinner because they do not need separate moveable sashes. This translates into more solar gain and less frame loss – hence a higher ER number. Second, fixed windows tend to have less air leakage compared to

**Fig. 31**

<b>Typical Energy Ratings (ER)</b>				
<b>Window Category</b>	<b>Type of Spacer</b>	<b>Type of Glazing</b>	<b>Fixed Window</b>	<b>Operable Window</b>
Common	Aluminum	Double	-15	-25
Moderate-cost, high-performance	Insulated	Double, low-E, argon gas	0	-8
Best high-performance commercially available	Insulated	Triple, low-E coating, krypton gas	+8	+1

operable ones. There is always going to be less air leakage with a window you can't open than with one you can. This translates into less heat loss and a higher ER number for fixed windows.

It stands to reason from this discussion that, when you shop, make sure you're comparing apples to apples. **Compare ER numbers within each window category – fixed, casement, sliders, etc. – because the ER numbers vary considerably for each type.**

Although intended only for comparison purposes, the ER number may be a good indicator of the effect windows will have on the annual heating costs in the home. A positive ER number means the windows actually add more heat to the home than they lose during the heating season, decreasing the home's heating costs. An ER number of 0 (zero) should be considered a minimum performance level for a fixed window. A window with an ER of 0 loses as much heat as it gains over the heating season. Consequently, it will have no impact on the house's annual fuel consumption.

A negative ER means a window loses more energy than it gains, making the heating system work harder. The lower the number, the more heat is lost and the harder the heating system has to work in colder weather. For example, an ER of -38 is worse than an ER of -20. An ER number of -11 is a good minimum performance level for an operable, *standard* high-performance window.

However, some of the *super* high-performance windows coming onto the market (for instance, ones with low-profile, foam-filled fiberglass frames, insulated spacers and low-E, gas-filled triple glazing) may provide *positive* ER numbers, even for operable units.

The ER system is a major step in giving consumers the information they need to make informed decisions about the energy performance of windows. It is a rating solely of a window's performance – regardless of how, or with what materials, it was built.

Just looking at the ER numbers might not be enough information if your house differs from the average house used for the calculations (i.e., if it is heavily air-conditioned because of large internal loads, or has extreme solar gains that come with a passive solar-heated home). How do designers deal with this problem? The answer is the ERS rating system.

## 6.4 The ERS Rating: Adding Location and Orientation

A window's ERS rating is its ER value calculated for a *specific house*. It is calculated based on house type, municipal location, window orientation and window size. Although simple ER comparisons are often all that are needed for most houses, the design of an ultra-low energy home (like the Advanced House), a passive solar house, or solar spaces might warrant use of ERS for comparison. By obtaining solar heat gain, rate of heat flow and air leakage characteristics of a particular window from the manufacturer, a more accurate picture of window performance is calculated according to the CSA-A440.2 standard.

The ERS values are used to make comparative estimates of the effect installing a particular window in a specific orientation will have on a home's annual heating energy requirements. It allows the designer to compare two seemingly identical windows – by their ER numbers – while ensuring that the right window is selected for the right location and compass orientation.

## 6.5 Making Ratings Work for You

Energy performance is only one of many considerations in the purchase of a window. Appearance, price and durability are also important considerations. A high-performance window that meets CSA standards and has a good ER number will also tend to be better designed and manufactured, and will offer better resistance to condensation.

High-performance windows, described in the next section, offer other benefits too – better comfort levels, fewer condensation problems and lower sound transmission. While these benefits are not something you can readily put in the bank, they may be important to consider as you make your decision.

## Section 7 – High-Performance Windows

The window industry has been quick to develop alternative window technologies to address most of the performance shortcomings of conventional glazing systems. Its efforts over the past decade have been nothing short of revolutionary, and the end-result is the *high-performance window*, which is several times better than the windows of just a few years ago.

The list of high-performance window improvements currently available – *low-E* coatings, inert *gas fills* and *insulated frame and edge* components – are indicative of the recent advances.

High-performance windows come in a wide variety of window types and applications. It can be very confusing for the uninitiated to sort through the new improvements. Understanding this new technology, as well as learning to use the ER system, are important steps to making informed decisions about new window purchases.

### 7.1 Low-E Coatings

Standard window glass easily allows the sun's energy to pass through it. However, at night, it is equally effective at emitting infrared heat energy back through it to the exterior through the process known as radiative heat loss (**Fig. 32**). This *high-emissivity* characteristic of conventional glazing has led researchers to develop *low-emissivity* (low-E) coatings.

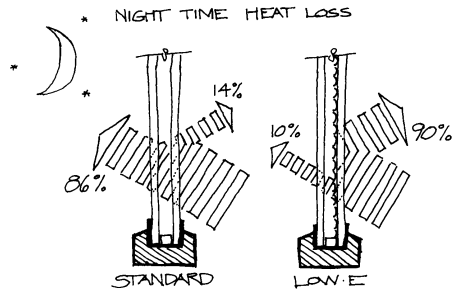
A low-E coating is a thin, invisible metallic layer – only several atoms in thickness – applied directly to glazing surfaces. In a typical double-pane application, the low-E coating is normally applied to the exterior face of the interior glazing (**Fig. 32**).

A low-E coating works in an ingenious way: while it is *transparent* to short-wave solar energy, it is *opaque* to long-wave infrared energy. What this means is that a low-E coating allows most of the sun's solar spectrum (including visible light) to pass through the window to the interior. But the coating reflects most heat energy (from room temperature objects) back to its source, which is a benefit both in the winter, because it keeps the heat in (**Fig. 33**), and in the summer, because it keeps out the heat radiated from warm objects outside (**Fig. 34**).

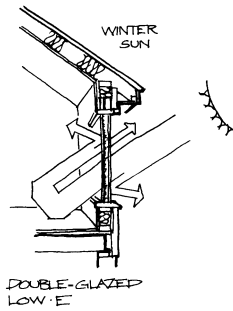
A low-E coating on one pane in a double-glazed window can give the window an insulating value about the same as a standard triple-glazed unit, without the added weight of a third glazing (**Fig. 35**). The lower weight reduces wear and tear on the window's hinges, casement cranks, etc. — making it easier to operate and giving the window longer life. It also reduces transportation costs, which means lower prices.

There is usually some loss of solar contribution due to the low-E coating (**Fig. 36**). But while this reduces the benefits of passive solar heat gains somewhat, it is more than offset by the improved insulative value of the low-E window at night. An added bonus is that fewer UV rays make it through, which can mean less fading of carpets and fabric.

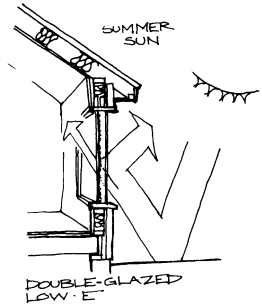
**Fig. 32**



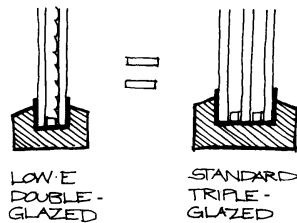
**Fig. 33**



**Fig. 34**

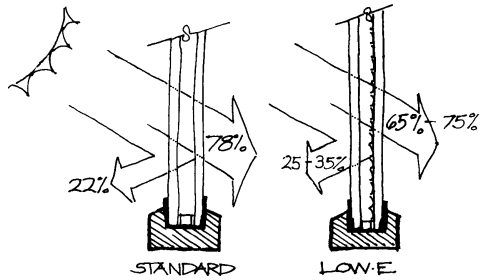


**Fig. 35**



There are now many different types of low-E coatings with different performance characteristics. *Northern* low-E coatings are probably your best compromise in a heating climate like Canada's. They maximize solar heat gains and reduce heat loss at night. *Solar control* low-E coatings might be justified on west-facing windows when no other means of solar control is possible. These reduce solar heat gain as well as visibility, and are often tinted.

**Fig. 36**



In most cases, the consumer has little control over window location, especially in an existing home. However, if you're designing a new home you may wish to use the ERS rating to compare different glazing options in different orientations.

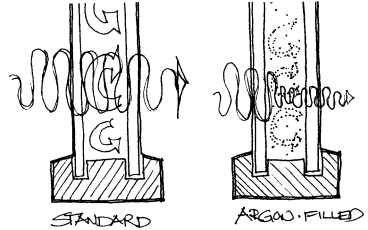
## 7.2 Gas Fills

The other big advance in window technology has been the introduction of *inert gas fills* into the space between glazings (**Fig. 37**). The term *inert* refers to a class of chemically stable, non-reactive (safe) gases. Argon and krypton are the usual choice, with argon being the most common and cheapest.

Filling the space between glazing layers with argon gas does two things: 1) it reduces *conduction* heat loss, because argon has a lower conductivity than air; and, 2) it reduces *convection* losses, because it is heavier than air and suppresses gas movement between the glazings (**Fig. 37**).

Krypton gives slightly better performance than argon and permits a smaller optimal spacing between panes (about 8 mm or a third of an inch). A narrow pane space requires less of this much more expensive gas, and allows multiple-pane systems with less chance of stress breakage. Since argon is more cost-effective, an increasing number of manufacturers offer it either as a standard feature or as an inexpensive upgrade.

**Fig. 37**





## 7.3 Special Films

Low-E coatings are also applied to thin sheets of transparent polyester, and suspended in the cavity between glazings (**Fig. 38**) or directly on the glass surface. This combines a high solar transmission with a low emissivity. Some films are designed to combine low emissivity with *reduced* solar transmission, making them ideal for southern climates or west-facing windows if solar gains are a severe problem during the summer.

While these films are effective in certain applications, you need to be sure that both you and the window supplier or manufacturer select the right film for the right application.

Researchers are working on exciting new categories of *smart* windows – *electrochromic*, *thermochromic* and *photochromic* – referred to as “switchable” glazing.

The most promising are electrochromic films that allow the amount of sunlight passing through windows to be controlled by means of a small current running through a transparent electrolyte layer in the window. The biggest application for these films in the residential sector will be in buildings with large amounts of west glazing, where overheating in the summer is a problem.

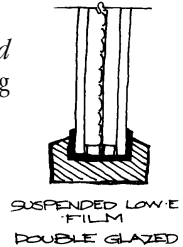
Be careful about the pressure-sensitive after-market films which can be applied directly to existing windows. They are normally designed for the commercial building market. While some of these solar control films do have low-E coatings, they also have very low solar transmission factors. In other words, the energy saved in heat retention may be more than offset by the large reductions in solar gains. Use of these films are recommended for residential applications in only very specific cases such as a sunroom which tends to overheat in the summer. Caution should also be advised as the use of after-market films may void the warranty of the insulated glazing unit.

## 7.4 Low-Conductivity Spacers

Once radiation losses have been reduced through low-E films, and convection and conduction losses through the glazing have been reduced by gas fills, the *spacer* at the perimeter of the window becomes the weak thermal link in the window unit. As discussed in Section 3.4, most spacers have traditionally been made out of hollow aluminum. Although lightweight and durable, this metal is, unfortunately, very effective at conducting heat.

From an energy efficiency point of view, the new low-conductivity spacer is a major improvement. Many different approaches and materials are appearing in the marketplace, but performance varies considerably. Generally speaking, these spacers can improve the energy performance of a low-E, gas-filled window by as much as 20 percent (**Fig. 39**). Use the ER number to compare spacer effectiveness.

**Fig. 38**



These better spacers also keep the inside glass warmer at the perimeter, which reduces thermal stresses on the glass and reduces the likelihood of condensation in cold weather.

## 7.5 Better Frame Materials

Window frames are another weak link in the overall window unit, as mentioned in Section 3.5. Recognizing that up to one third of the overall window may be frame materials – and that high-performance glazing is better insulated than most conventional frame materials – manufacturers have moved quickly to develop more efficient alternatives.

Window frames that combine different materials and take advantage of the strengths of each are available from a growing number of manufacturers. The best energy performance in window frames has been achieved using a fiberglass frame with foam insulation in the frame cavities.

The bottom line on frames is that if you are investing in windows with low-E coatings, gas fills and low-conductivity spacers, then select a frame material which minimizes conductive heat losses.

Remember also that frames can have a significant effect on solar gains (and the ER number). Stronger materials that allow narrow frames and sashes, such as thermally broken aluminum or fiberglass, allow more glass area and solar gain. These are called *low profile* frames. Again, frame thermal efficiency will be reflected in a higher ER number.

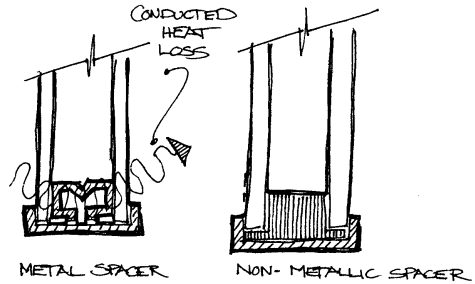
## 7.6 Design Summary

In the majority of cases, if you are replacing all the windows in your home, you will probably select the same glazing on all sides. In this case, make your selection on the basis of ER numbers. In exceptional cases, such as passive solar homes or sun spaces, more detailed comparisons may be required.

Keep the following principles in mind as you decide on your window approach:

- A few large windows are better than many small ones. Larger windows reduce the proportion of frame to glazing, and maximize overall performance.
- The thermally weakest areas of a high-performance window are frames and edges; once the centre of glazing is efficient, the frame and edge losses will be proportionally higher, so look for insulated (non-metal) spacers and thermally broken, low-profile frames.

**Fig. 39**



- Avoid large areas of west-facing glass. The sunsets may be beautiful, but your air conditioning bills won't be.
- Operable windows should be limited to locations where ventilation or emergency exits are required by codes.
- Reduced frame and sash areas contribute to better overall window performance.
- For passive solar designs, the ERS rating system may be used.
- In all other cases, select windows based on ER numbers.



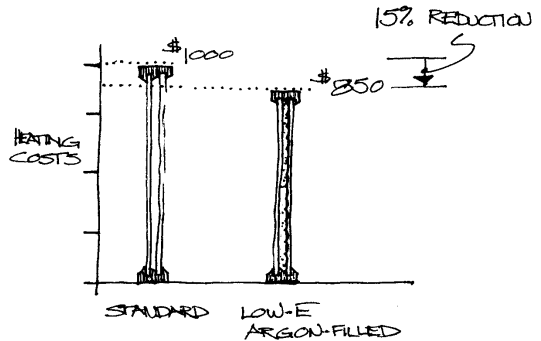
## Section 8 – The Benefits of High- Performance Windows

The *technology* of high-performance windows may be impressive, but the *benefits* are equally compelling. And these benefits extend beyond the more obvious ones.

### 8.1 Savings in Heating Costs

First and foremost, high-performance windows are *energy-efficient*. They offer immediate savings on home heating costs. Depending on the house design and the existing levels of efficiency in the rest of the building, switching to high-performance windows should yield 9 to 18 percent reductions in space heating costs (**Fig. 40**).

**Fig. 40**



### 8.2 Savings in Cooling Costs

Concerns about energy efficiency are not limited just to the heating season. In many parts of Canada, summertime heat requires space cooling. High-performance windows work equally well at keeping the heat out in the summer months. The same low-E coating that keeps infrared (heat) energy inside the home in the winter keeps unwanted heat out in the summer. This keeps the interior cooler and cuts down on the need for air conditioning.

Studies have shown that, for most of Canada, it is still appropriate to choose your windows on the basis of the ER number. Exceptions to this rule are those few locations where air conditioning costs are high relative to the amount spent on space heating. In these few cases, consider west-facing windows with a *lower* solar heat gain potential.

### 8.3 Increased Comfort

In houses with conventional windows, air leakage, drafts and radiative heat loss all contribute to occupant discomfort which the heating system must try – usually with only limited success – to overcome. But high-performance windows are better insulated and maintain a much higher surface temperature on the interior glazing. This characteristic, together with effective weatherstripping and proper installation, makes the window “feel” warmer to the occupant.

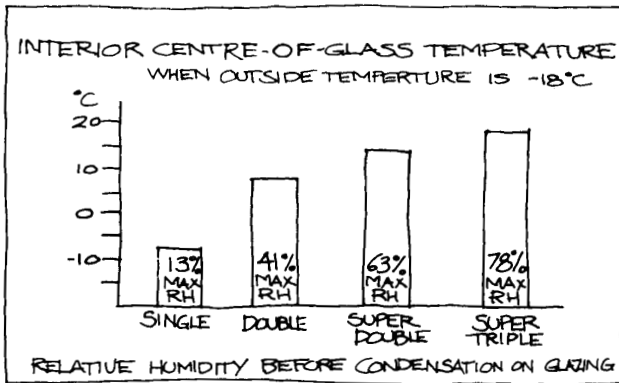
### 8.4 Higher Humidity Without Condensation

Improvements in comfort extend beyond the reduction in drafts and cold spots near windows. During the winter, outside air is very dry and can significantly lower the relative humidity (RH) inside. This in turn can lead to annoying static electric shocks when touching doors or light switches, as well as dry throats and other irritants.

If you try to compensate by humidifying the air, then once you get above about 40 percent RH, there is the risk of condensation forming on the windows. This reduces visibility and can lead to deterioration of the frame components and mould growth.

High-performance windows can change all this. The higher inside glass temperatures and improved thermal performance of edge spacer and frame components allow much higher RH levels inside (**Fig. 41**). This can reduce if not eliminate RH-related problems associated with poor windows. Since higher humidity levels are possible with better windows, this means reduced static shock, improved health, and healthier plants. **Fig. 41** shows the relative

**Fig. 41**



humidity at which condensation will start to form at the centre of the glass with different types of glazing. However, condensation will usually form at the edge of the glass at a lower relative humidity.

## **8.5 Lower Sound Transmission**

The heavy gas fills in high-performance windows, which reduce conductive and convective heat losses, also reduce sound transmission from the exterior to the interior. The greater the number of panes, the better the sound absorption. Sound attenuation is complex, depending on frequencies and other factors; some benefit may be realized with high-performance windows.

## **8.6 More Daylight**

The advent of high-performance windows is allowing larger glazing areas to be incorporated into house designs, in both new construction and renovations, without the penalty of either high heat loss in the winter or high heat gains during the summer. This not only enhances energy efficiency and improves the view, but it also lets in more daylight, which may lead to reductions in the use of electric lighting.

You save twice when you take advantage of this natural light: first, you save on electricity used for lighting; second, because a conventional light bulb uses only 15 percent of its energy for lighting and wastes the other 85 percent as heat, you lower the home's cooling load in summer. This is especially the case in larger buildings.

## **8.7 Increased Passive Solar Potential**

Conventional south-facing glazing offers, at best, a break-even proposition in terms of balancing heat gains and losses. In other words, the energy that south-facing windows gain during the day through solar inputs is about equal to the energy they lose through radiation, convection, and conduction heat loss during the night.

High-performance windows are changing all this. With the right selection of low-E coatings and gas fills, it is now possible for most windows to gain more energy during the day than they lose at night.

With window frame areas kept to a minimum, it is now possible to have even larger window areas and still obtain net energy gains. In addition to saving on space heating costs, this can give the house a brighter, more open feeling.

## 8.8 Reduced Mechanical Complexity

On a cold winter night, conventional windows (RSI 0.35 or R-2) lose about ten times as much heat as an equal area of a reasonably well-insulated wall (RSI 3.52 or R-20). It is for this reason that architects and heating contractors have been forced to locate heating registers, convectors and radiators directly *under* windows. This compensates for the high heat loss and air leakage in close proximity to these windows.

Lower air infiltration and the reduced conductive heat loss of high-performance windows may make the practice of perimeter heat distribution less important. It is now possible, thanks to high-performance windows, to locate heating registers on interior walls, either at the floor level, or near the ceiling. This reduces the length, diameter and complexity of heating duct layouts. Discharge outlets on an inside wall near the ceiling may provide more comfort, especially with air conditioning.

Reducing the length of duct or piping runs in the home saves on capital material costs as well as installation time, in either new homes or renovations. Shorter duct runs with smaller diameters can also mean smaller fans and less energy to run the fans. In some cases, cost savings may offset the additional costs of upgrading windows.

## Section 9 – Doors, Patio Doors and Skylights

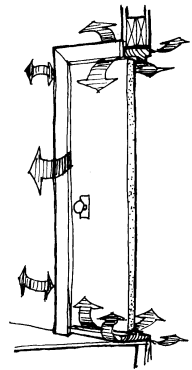
### 9.1 Doors

Doors have less impact than windows on the energy consumption of a home – unless they are patio or garden doors – simply because there are fewer of them. They come in a variety of materials, some of which reduce heat flow better than others. Depending on style and insulation material, for example, metal-clad doors are more efficient than solid wooden doors. No matter what the material, ill-fitting doors lose even more energy and can make the home drafty and uncomfortable.

Heat may be lost through the door and frame, between the door, frame, and sill, through glass in patio doors or doors with windows, and between the door frame and rough frame opening (**Fig. 42**). Heat loss through doors can be reduced through careful choice of the door, its location, and proper installation and maintenance. You can reduce heat loss simply by placing a door out of the path of prevailing winds, by locating it on the leeward side of a house, or by providing windbreaks. Another option is the use of an airlock vestibule which traps the air between the exterior door and the interior of the house.

Properly designed and installed storm doors will provide some degree of increased efficiency, as well as protection from the weather. And, with screen inserts, they'll provide summer ventilation. In southern and

**Fig. 42**



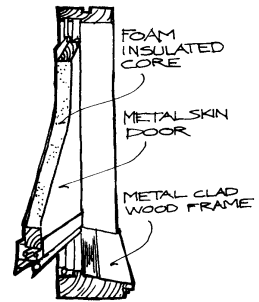
western exposures, care should be taken to avoid heat buildup between the doors which may cause the main door's finish to blister. In extreme cases, the main door may actually warp due to this heat buildup.

Missing or worn weatherstripping, improperly located strike plates, frames which no longer fit the door correctly, or warped doors that no longer contact the stops are the main contributors to air leakage. These problems can all be corrected by a carpenter or competent do-it-yourselfer.

A badly deteriorated door should be replaced with a new one with energy-efficient insulation. Select good quality units and install them properly.

New insulated doors are usually made of foam and wood covered with metal (**Fig. 43**). Door frames are normally wood, clad with metal or vinyl. Doors that are mainly glass and are used as windows (for the view, daylight, etc.) should be compared for energy performance by their ER number. Glass inserts and sidelights should have at least double-glazing with at least 12 mm (half inch) of air space between glazings and be compared on the basis of the U-value (or R-value) calculated for the complete door system.

**Fig. 43**



Using the existing casing, the door and frame can be replaced with a factory-made, core-insulated, pre-hung unit. Installation takes less time than site-assembled systems, air seals are tighter and more durable, and these systems come with a thermally broken, adjustable sill assembly to reduce heat loss even further. A variety of materials may be used for the door face and framing, insulation and weatherstripping.

In summary, when selecting doors for energy efficiency, look for:

- cores of materials that maintain high insulating values;
- wood, vinyl or thermally broken metal frames;
- weatherstripping fabricated from high-performance, durable materials;
- low air leakage rates (for pre-hung door systems);
- maintenance-free framing materials; and
- a high Energy Rating (ER) or a minimum of double glazing with a 12 mm (half inch) or greater air space.

For details on specific doors, check with the manufacturer.

## 9.2 Patio Doors

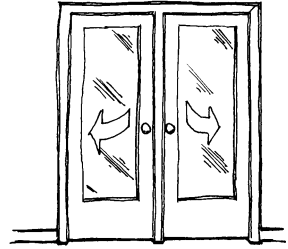
Sliding glass patio doors are popular in Canada and can be energy-efficient if selected on the same basis as for windows. Sliding glass doors are covered by the CSA-A440.2 Energy Rating (ER) system and the CGSB 82.1 Standard.

With an existing patio door of good quality and in reasonable condition, air leakage may be reduced by replacing the door's gaskets, weatherstripping and hardware. Doors not used in winter can be sealed shut with a removable sealant, or covered on the interior with heat-shrink plastic – kits are available to fit most doors.

A door in poor condition should probably be replaced. New sliders perform better than older models. However, hinged French doors with a centre post to close against (**Fig. 44**) will be more airtight, although they would still not be suitable in a more severe northern climate.

The same basic guidelines on glazing and frame materials apply for doors as for windows.

**Fig. 44**



## 9.3 Skylights

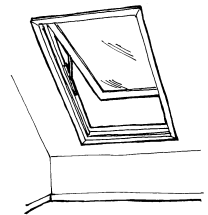
Skylights can bring added light to a home and make it more attractive. However, if not designed or installed properly, they can lose far more heat than a standard roof and window, and can present special problems including water leakage, condensation, and summer overheating. Also, because of their different solar heat gain characteristics, the Energy Rating (ER) system does not apply to them although they are included in the CSA-A440.2 standard. Normally, a skylight's thermal performance is indicated by its "U" value.

Skylights should be as resistant to heat loss as possible. This means that high, poorly insulated curbs should be avoided. The glazing should be as energy-efficient as possible. Low-E, gas-filled, insulated glazing units are a good choice. You may also want to consider light-reflective glass to reduce overheating, although this may also reduce the amount of daylight.

An exterior awning, reflective film, or even whitewash can be applied in summer to reduce overheating problems. An extra layer of glazing on the inside of a skylight may also reduce condensation and heat loss.

If a skylight is badly deteriorated but necessary for daylighting, a replacement unit should be purchased. It should have the same features as high-performance windows, including a tightly sealing closure mechanism. On steep roofs, an operable roof window can provide many of the features of a good quality vertical window, including the ability to ventilate (**Fig. 45**). Roof windows can also be equipped with blinds to reduce unwanted summer sun.

**Fig. 45**







# Section 10 – Deciding What You Need

## 10.1 Shopping Checklist

Take this handy checklist when you go window shopping and ask the salesperson to show you the energy and other performance ratings.

### Window Shopping Checklist

#### Performance results

- IGMA label present on sealed glazing unit
- CSA-A440 compliance
- CSA air leakage level (recommended minimum A3)
- CSA water penetration level (recommended minimum B3)
- CSA wind load level (recommended minimum C3)
- CSA condensation resistance (optional)
- CSA forced entry (optional)

#### Energy performance

- Energy Rating (ER) number
- ER: -11 for operable and +2 for fixed are good levels to aim for

#### Resistance to wear and tear

- Maintenance-free materials
- Joints well sealed
- Easily operated, well-balanced mechanisms
- Strong, durable hardware

#### Style

- Meets aesthetic needs
- Suitable for size and orientation
- Non-operable except for code or ventilation requirements

#### Price

- Three quotes for product and installation (site estimation)

#### Warranties

- Installation: minimum 90 days
- Sealed glazing unit: minimum five years
- Window: minimum one year

In northern areas, consider durability and operability under extreme conditions. Opening windows in very cold conditions can cause a heavy accumulation of ice from the condensing interior air, making them difficult to close again. Operable windows in northern houses must be extremely sturdy.

Choose a replacement window type that is compatible with the exterior architectural style of the building. Select high-performance windows that have the same “look” as the original windows. When replacing windows with divided lights, manufacturers may provide removable grid inserts that match the appearance of the original windows or grills placed within the sealed glazing unit.

For the maximum in energy efficiency, select doors with:

- well-insulated cores;
- wood, vinyl, fibreglass or thermally broken metal frames;
- weatherstripping made from high-performance, durable materials;
- low air leakage rates (for pre-hung door systems);
- maintenance-free framing materials; and,
- for glass areas, high-performance glazings.

## 10.2 Comparison Shopping Using the ER System

The goal of the ER system is to provide window buyers with a simple and easy way to compare the energy performance of windows. It's clearly the best standard to assist in this task because it rates the *entire* window, not just the edge seal or the centre of glazing.

The best window is the one that fits your needs for the least amount of money. Remember that some very moderately priced windows perform as well as more expensive ones.

## 10.3 Choosing a Supplier

Once you have decided to purchase new windows or doors, and you have a general idea of what you are looking for, it is time to choose a supplier. A good supplier knows the technology and will help you in your decision-making process. Start with the phone book, with recommendations from friends or neighbours, or by visiting home shows or dealer showrooms.

Visit several suppliers to inspect their products. Ask to be shown the installed product in a home, and don't hesitate to follow up on references provided by the supplier. If you are satisfied that the product suits your needs and the company is reputable, ask for a quote.

Normally, the supplier will visit your home and take measurements for each door and window. Obtain quotes from at *least* three different suppliers. When comparing costs and services, make sure the products are comparable. And don't forget the warranty.



# Section 11 – Getting What You Pay For

## 11.1 The Importance of Correct Installation

With the increasing complexity of window technology, installation is not something you want to play around with. Unless you are an experienced carpenter, window and door installation is *not* a do-it-yourself project. A crack in a gas-filled window will limit its effectiveness – and you won't have a warranty if anything goes wrong!

Installation is especially important with high-performance windows because poor installation techniques can negate their superior performance. Installation should be made according to the new CSA-A440.4 “Window and Door Installation Standard.” In addition, the Siding and Window Dealers Association of Canada (SAWDAC) has recently developed a certification program for window installers, although it is not widely available across Canada yet. Also, many manufacturers train their own installers. Be sure to ask about installation.

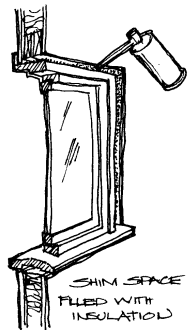
First, windows must be installed square, plumb and level with shims and spacers at appropriate points to ensure durability and continuing high performance.

Once the window has been installed in the rough opening in the wall, care must be taken to ensure good thermal resistance and good airflow resistance around the sides of the window frame, that is, in the space between the frame and the rough opening. High thermal resistance will keep heat loss to a minimum. Good airflow resistance will prevent cold air from leaking in or warm air from leaking out around the sides of the window frame. Because the warm air contains water vapour, it is important to prevent it from leaking into the exterior wall and causing condensation to form inside the wall.

The material most commonly chosen for insulating around windows is injected foam.

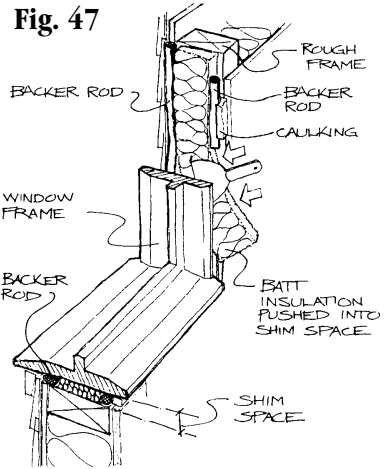
Injected foam has the advantage of providing good thermal resistance and resistance to the passage of air and water vapour, thus allowing installation in one stage using a single product (**Fig. 46**). However, the foam has to be applied with great care, because the pressure created by overfilling may distort the frame and cause the window to jam or the glass to break. Care must also be taken to ensure that the foam used is compatible with the materials with which it is in contact, such as the window frame and caulking products. When insulating foam is used with a vinyl or aluminum frame, there is a chance that the bond between the foam and the frame will break as a result of contraction and expansion of the frame.

**Fig. 46**



The older blanket insulation method is an effective solution, but requires careful installation using more than one product (**Fig. 47**). Blanket insulation offers good thermal resistance but poor resistance to the passage of air and water vapour. For this reason, another material, such as injected foam or a backer rod with caulking, must be used on the interior side. When installing the insulating blanket, care must be taken to avoid compressing it so as not to affect its insulating properties.

**Warning:** Older homes, especially those built prior to 1950, were often painted with lead-based paint. Caution should be exercised, especially when working with windows, doors, trimwork, wood siding or porches. For further information, you can obtain a copy of the publication entitled *Lead in Your Home* (publication number: NB6624). Contact: Canada Mortgage and Housing Corporation, 700 Montreal Road, Ottawa, Ontario K1A 0P7, or their nearest regional office.



## 11.2 The Contract

Because the supplier has to visit your home and take measurements for each door or window, many suppliers also install windows. The contract in this case would be to “supply and install.”

If you are replacing windows, this type of arrangement is a good one. The advantage is that one company is responsible for supplying and installing the windows in your home. Because much of their business is through referrals, suppliers usually do a good job to ensure customer satisfaction.

The “contractor supply and install” arrangement will come up if you are undertaking a major renovation. The general contractor will also likely arrange for the purchase of required windows.

Listen to the contractor’s opinions on the type of windows and suppliers, but make the final decision yourself. The benefit of working with a contractor is clear when problems arise and work such as structural changes to the wall or repairs to the drywall and trim must be done. A good contractor will ensure that the windows are properly installed and finished, inside and out.

You should have a contract signed by both parties before work begins (**Fig. 48**). It should stipulate the full cost of the work, including taxes, and provide a detailed description of the windows. The contract should also outline the products to be used and stipulate that they will meet CSA standards after installation. Make sure it covers the date by which the job is to be completed and describes both the manufacturer’s and installer’s warranties.

**Fig. 48**



Save costs and avoid later delays by inspecting the windows on delivery to ensure they are what you ordered. Check units for correct size and style, for all certification labels, and for conformity to specifications – sealed units, for example, should bear the IGMA name. Contact the supplier if special or invisible features, such as low-E coatings, gas fill or non-metallic spacer, are not labeled on the unit, or if faulty units need to be replaced.

And report excessive deflection of glass/glazing and any evidence of seal failure such as condensation, frosting, fogging or discolouration between glazings. Handle all units with care!

The supplier is normally responsible for correcting any problems with the product, while the installer is responsible for proper installation. Whatever the case, do not pay the full cost of the job until it has been properly completed.

You are legally entitled, under provincial/territorial construction liens legislation, to withhold a percentage of the cost of any construction project for a specified time to satisfy yourself that all sub-trades and suppliers have been paid by the contractor. This is an accepted construction practice you should follow. Details are available from your provincial/territorial ministry of consumer and commercial relations.

**Note:** Canada Mortgage and Housing Corporation offers a free publication entitled *How to Hire a Contractor* (publication number: NHA-5429). To obtain a copy, contact CMHC at the address listed on page 41.

### 11.3 The Work

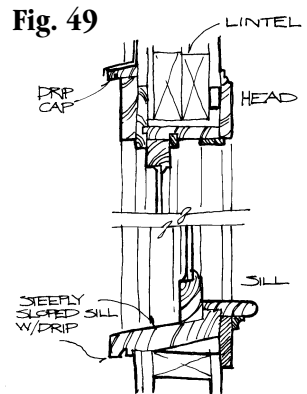
You may need a building permit if you are changing the size of an existing opening or making a new one. Check with your municipal office before work begins.

The installation of new windows will likely cause some disruption. Prepare for the work by finding out when the job will be started, and by moving furnishings and pictures.

Be prepared to find structural problems when an old window is removed. Rotting or missing wood, or undersized or improperly supported lintels, for example, must be corrected before the new unit is installed. Enlarging openings or cutting new ones involves structural work, and may require the rerouting of wiring and other services.

The surrounding structure must be sound and dry before the window is fitted, insulated and air-sealed. Outside, the window flashing or drip cap should extend across the top of the window to direct water away from the window (**Fig. 49**). New mouldings on either side of the window will likely be required.

There are two ways to place windows and doors in relatively thick walls: close to the outside face of the wall, or close to its inside face. Doors tend to be mounted flush with the inside face for aesthetics and ease of operation. Windows, too, should be mounted close to the inside for

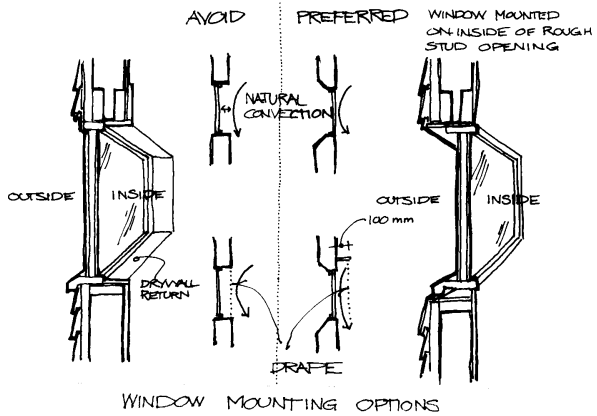


**Fig. 49**

energy efficiency, since the window surface is sheltered from the wind and in a warmer part of the wall (Fig. 50).

**Fig. 50**

Once the window is installed, check that it opens and closes easily, locks tightly, and is well-sealed. If condensation occurs between panes of sealed units, the seal is faulty and the unit should be replaced under warranty.



## 11.4 Understanding Warranties

A window is usually covered by a warranty for performance under normal operating conditions. The recommended minimum warranty for a window, both parts and labour, is one year.

Make sure that the installer's workmanship is also covered by a warranty. For example, if the installer accidentally breaks the Insulated Glazing Unit (IGU) during installation, this type of incident should be covered by the installer's warranty. Installation errors may not show up for a few months. Good glazing practice should ensure that the glazing cavity is drained or vented to the outside. The edge of the insulated glazing unit should not be allowed to sit in water. This may cause failure of the glazing unit. The installer must make sure that the drainage system is not blocked in the process of installing the window.

Most IGU manufacturers offer a five-year warranty against failure of the seal. If condensation or frosting appears between the layers of glazing during the warranty period, the manufacturer will supply a new replacement sealed unit. The consumer is normally responsible for the costs of the installation of replacement units. For details on the Insulating Glass Manufacturers Alliance (IGMA) certification program, see page 23.

Remember, warranties can be used for marketing purposes. Read the fine print carefully to see exactly what is covered and for how long.



## Section 12 – Need More Information?

### **Order Free Publications From the OEE**

Natural Resources Canada's Office of Energy Efficiency (OEE) offers many publications that will help you understand home heating systems, home energy use and transportation efficiency. These publications explain what you can do to reduce your energy use and maintenance costs while increasing your comfort and helping to protect the environment.

### **Take the One-Tonne Challenge**

It is a national effort to take action on climate change. The One-Tonne Challenge calls on each of us to reduce our annual greenhouse gas emissions by one tonne, or about 20%. By using energy more efficiently and producing less waste, you can protect our environment, improve air quality and cut your energy costs. A one-tonne reduction can be achieved with big changes, or with a number of small, simple changes. Discover lots of useful tips in *Your Guide to the One-Tonne Challenge*. Get your copy by visiting [www.climatechange.gc.ca](http://www.climatechange.gc.ca) or by calling 1 800 O-Canada (1 800 622-6232) or 1 800 465-7735 (teletype for the hearing-impaired).

### **EnerGuide for Renovating Your Home**

*Keeping the Heat In* is a guide to all aspects of home insulation and draftproofing. Whether you plan to do it yourself or hire a contractor, this 134-page book can help make it easier. Fact sheets are also available on air-leakage control, improving window energy efficiency and moisture problems. Consider getting the expert, unbiased advice of an EnerGuide for Houses evaluation before you renovate. Our telephone operators can connect you with an advisor in your local area.

### **EnerGuide for Home Heating and Cooling**

If you are interested in a particular energy source, the OEE has booklets on heating with electricity, gas, oil, heat pumps and wood. Other publications are available on heat recovery ventilators, wood fireplaces, gas fireplaces, air conditioning your home, and comparing home heating systems.

### **EnerGuide for Choosing the Most Energy-Efficient Products**

When shopping for household appliances, office equipment, lighting products, and windows and doors, consult the OEE's series of Consumer's Guides. They will help you know what to look for when it comes to energy efficiency.

The EnerGuide label, which is affixed to all new major electrical household appliances and room air conditioners, helps you compare the energy rating of all models sold in Canada. EnerGuide ratings are also listed in the OEE's annual directories of major electrical household appliances and room air conditioners.

### **. . . and Energy-Efficient New Housing?**

R-2000 homes use an average of 30 percent less energy than conventional dwellings. Features include state-of-the-art heating systems, high levels of insulation, use of solar energy, and whole-house ventilation systems that provide continuous fresh air to all rooms. Once completed, R-2000 homes are subject to third-party testing.

### **Buying, Driving and Maintaining Your Car**

For information on vehicle fuel consumption, look for the EnerGuide label that appears on every new automobile, van and light-duty truck for sale in Canada. It helps you compare different vehicle's city and highway fuel consumption ratings and estimated annual fuel costs. You can also check the OEE's *Fuel Consumption Guide*, produced annually, which provides the same information for all vehicles. The OEE's EnerGuide for Vehicles Awards also recognize the vehicles with the lowest fuel consumption in different categories.

Also available is the OEE's *Car Economy Calculator*, a fuel log that helps you calculate your fuel consumption and savings. The OEE's *Auto\$mart Guide* provides detailed fuel efficiency information and offers tips on purchasing, operating and maintaining personal vehicles.

### **To receive any of these free publications, please write or call:**

Energy Publications  
Office of Energy Efficiency  
Natural Resources Canada  
c/o S.J.D.S.

1770 Pink Road  
Gatineau QC J9J 3N7  
Fax: (819) 779-2833  
Toll-free: 1 800 387-2000  
TTY: (613) 996-4397

(teletype for the hearing-impaired)

In the National Capital Region, call (613) 995-2943.

Please allow three weeks for delivery.

**Publications can also be ordered or viewed on-line at the OEE's Energy Publications Virtual Library: [oee.nrcan.gc.ca/infosource](http://oee.nrcan.gc.ca/infosource).**



## For Information on Standards and Certification Programs

### Canadian Standards Association

Customer Service Department  
5060 Spectrum Way  
Mississauga ON L4W 5N6  
Tel.: 1 800 463-6727  
Fax: (416) 747-2473  
[www.csa.ca](http://www.csa.ca)

### Insulating Glass Manufacturers Alliance (IGMA)

27 Goulburn Avenue  
Ottawa ON K1N 8C7  
Tel.: (613) 233-1510  
Fax: (613) 233-1929  
[www.igmaonline.org](http://www.igmaonline.org)

### Window Wise Program

84 Adam Street  
Cambridge ON N3C 2K6  
Tel.: 1 800 813-9616  
Fax: (519) 658-4753  
[www.windowwise.com](http://www.windowwise.com)

## For Technical Information

### Canadian Construction Materials Centre

Client Services  
Institute for Research in Construction  
National Research Council  
1200 Montreal Road  
Ottawa ON K1A 0R6  
Tel.: (613) 993-2607  
Fax: (613) 952-7673  
[www.nrc.ca/ccmc](http://www.nrc.ca/ccmc)

### Canada Mortgage and Housing Corporation

700 Montreal Road  
Ottawa ON K1A 0P7  
Tel.: (613) 748-2000  
Fax: (613) 748-2098  
[www.cmhc-schl.gc.ca](http://www.cmhc-schl.gc.ca)

## For Information on Manufacturers, Contractors and Dealers

### Canadian Window and Door Manufacturers Association (CWDMA)

2121 Argentia Road, Suite 404  
Mississauga ON L5N 2X4  
Tel.: (905) 286-0660  
1 866 871-8885  
Fax: (905) 286-4873  
[www.cwdma.ca](http://www.cwdma.ca)

### Siding and Window Dealers Association of Canada (SAWDAC)

84 Adam Street  
Cambridge ON N3C 2K6  
Tel.: 1 800 813-9616  
Fax: (519) 658-4753  
[www.sawdac.com](http://www.sawdac.com)

# Notes

---

---

---

---

---

---

---

---

---

---

---

---

---

---

---

---

---

---

---

---

---

---

---

---

---

---

---

---

---

