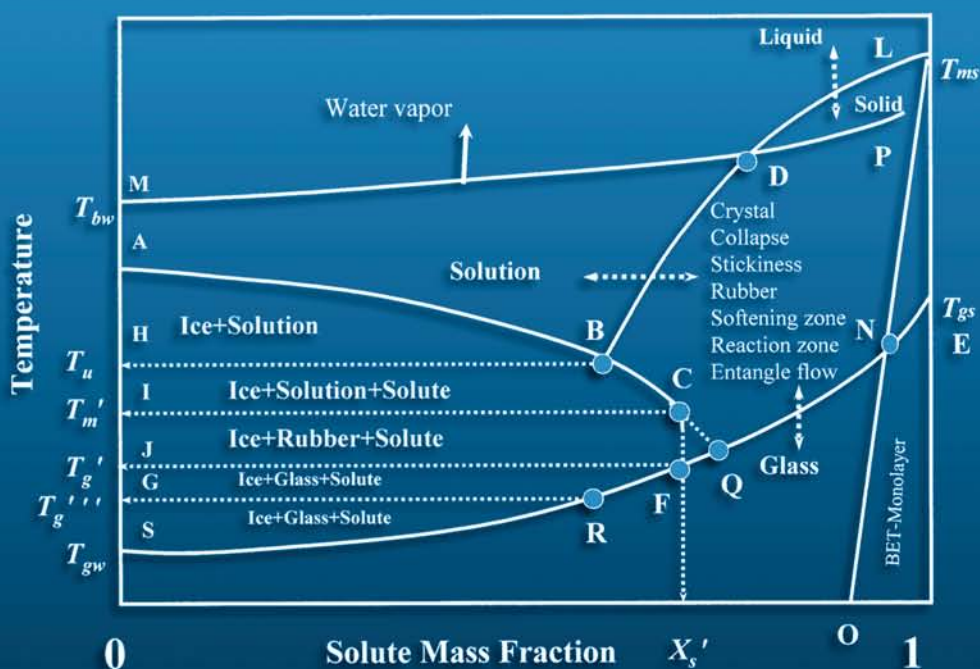


# Handbook of Food Preservation

## Second Edition



edited by  
M. Shafiur Rahman

---

Handbook of  
Food Preservation

---

Second Edition

# FOOD SCIENCE AND TECHNOLOGY

## *Editorial Advisory Board*

- Gustavo V. Barbosa-Cánovas** Washington State University–Pullman  
**P. Michael Davidson** University of Tennessee–Knoxville  
**Mark Dreher** McNeil Nutritionals, New Brunswick, NJ  
**Richard W. Hartel** University of Wisconsin–Madison  
**Lekh R. Juneja** Taiyo Kagaku Company, Japan  
**Marcus Karel** Massachusetts Institute of Technology  
**Ronald G. Labbe** University of Massachusetts–Amherst  
**Daryl B. Lund** University of Wisconsin–Madison  
**David B. Min** The Ohio State University  
**Leo M. L. Nollet** Hogeschool Gent, Belgium  
**Seppo Salminen** University of Turku, Finland  
**John H. Thorngate III** Allied Domecq Technical Services, Napa, CA  
**Pieter Walstra** Wageningen University, The Netherlands  
**John R. Whitaker** University of California–Davis  
**Rickey Y. Yada** University of Guelph, Canada

---

# Handbook of Food Preservation

---

Second Edition

edited by

M. Shafiur Rahman



CRC Press

Taylor & Francis Group

Boca Raton London New York

---

CRC Press is an imprint of the  
Taylor & Francis Group, an **informa** business



CRC Press  
Taylor & Francis Group  
6000 Broken Sound Parkway NW, Suite 300  
Boca Raton, FL 33487-2742

© 2007 by Taylor & Francis Group, LLC  
CRC Press is an imprint of Taylor & Francis Group, an Informa business

No claim to original U.S. Government works  
Printed in the United States of America on acid-free paper  
10 9 8 7 6 5 4 3 2 1

International Standard Book Number-10: 1-57444-606-1 (Hardcover)  
International Standard Book Number-13: 978-1-57444-606-7 (Hardcover)

This book contains information obtained from authentic and highly regarded sources. Reprinted material is quoted with permission, and sources are indicated. A wide variety of references are listed. Reasonable efforts have been made to publish reliable data and information, but the author and the publisher cannot assume responsibility for the validity of all materials or for the consequences of their use.

No part of this book may be reprinted, reproduced, transmitted, or utilized in any form by any electronic, mechanical, or other means, now known or hereafter invented, including photocopying, microfilming, and recording, or in any information storage or retrieval system, without written permission from the publishers.

For permission to photocopy or use material electronically from this work, please access [www.copyright.com](http://www.copyright.com) (<http://www.copyright.com/>) or contact the Copyright Clearance Center, Inc. (CCC) 222 Rosewood Drive, Danvers, MA 01923, 978-750-8400. CCC is a not-for-profit organization that provides licenses and registration for a variety of users. For organizations that have been granted a photocopy license by the CCC, a separate system of payment has been arranged.

**Trademark Notice:** Product or corporate names may be trademarks or registered trademarks, and are used only for identification and explanation without intent to infringe.

---

**Library of Congress Cataloging-in-Publication Data**

---

Handbook of food preservation / editor M. Shafiur Rahman. -- 2nd ed.  
p. cm. -- (Food science and technology ; 167)  
Includes bibliographical references and index.  
ISBN-13: 978-1-57444-606-7 (alk. paper)  
ISBN-10: 1-57444-606-1 (alk. paper)  
1. Food--Preservation. I. Rahman, Shafiur. II. Title. III. Series.

TP371.H26 2007  
664'.028--dc22

2006100043

---

Visit the Taylor & Francis Web site at  
<http://www.taylorandfrancis.com>  
and the CRC Press Web site at  
<http://www.crcpress.com>

---

# Contents

---

Preface .....	ix
Acknowledgments .....	xi
Editor .....	xiii
Contributors .....	xv

## Part 1 Preservation of Fresh Food Products

1. Food Preservation: Overview .....	3
<i>Mohammad Shafiur Rahman</i>	
2. Postharvest Physiology of Fruit and Vegetables.....	19
<i>Vijay Kumar Mishra and T.V. Gamage</i>	
3. Postharvest Handling and Treatments of Fruits and Vegetables.....	49
<i>Vijay Kumar Mishra and T.V. Gamage</i>	
4. Postharvest Handling of Grains and Pulses .....	73
<i>Ajit K. Mahapatra and Yubin Lan</i>	
5. Minimal Processing of Fruits and Vegetables .....	137
<i>Conrad O. Perera</i>	
6. Postharvest Handling and Preservation of Fresh Fish and Seafood.....	151
<i>Linus U. Opara, Saud M. Al-Jufaili, and Mohammad Shafiur Rahman</i>	
7. Postharvest Handling of Red Meat.....	173
<i>Isam T. Kadim and Osman Mahgoub</i>	
8. Postharvest Handling of Milk .....	203
<i>Nejib Guizani</i>	

## Part 2 Preservation Using Chemicals and Microbes

9. Fermentation as a Method for Food Preservation.....	215
<i>Nejib Guizani and Ann Mothershaw</i>	
10. Natural Antimicrobials for Food Preservation.....	237
<i>Eddy J. Smid and Leon G. M. Gorris</i>	
11. Antioxidants in Food Preservation .....	259
<i>Jan Pokorny</i>	
12. pH in Food Preservation.....	287
<i>Mohammad Shafiur Rahman</i>	

13. **Nitrites in Food Preservation** .....299  
*Mohammad Shafiur Rahman*

### **Part 3 Preservation by Controlling Water, Structure, and Atmosphere**

14. **Modified-Atmosphere Packaging of Produce**.....315  
*Leon G. M. Gorris and Herman W. Peppelenbos*

15. **Glass Transition and State Diagram of Foods**.....335  
*Mohammad Shafiur Rahman*

16. **Food Preservation and Processing Using Membranes** .....365  
*Shyam S. Sablani*

17. **Stickiness and Caking in Food Preservation** .....387  
*Bhesh R. Bhandari*

18. **Drying and Food Preservation** .....403  
*Mohammad Shafiur Rahman and Conrad O. Perera*

19. **Osmotic Dehydration of Foods** .....433  
*Mohammad Shafiur Rahman*

20. **Water Activity and Food Preservation**.....447  
*Mohammad Shafiur Rahman and Theodore P. Labuza*

21. **Surface Treatments and Edible Coatings in Food Preservation**.....477  
*Elizabeth A. Baldwin*

22. **Encapsulation, Stabilization, and Controlled Release of Food Ingredients and Bioactives**.....509  
*Ronald B. Pegg and Fereidoon Shahidi*

### **Part 4 Preservation Using Heat and Energy**

23. **Pasteurization and Food Preservation** .....571  
*M. N. Ramesh*

24. **Canning and Sterilization of Foods**.....585  
*M. N. Ramesh*

25. **Cooking and Frying of Foods**.....625  
*M. N. Ramesh*

26. **Food Preservation by Freezing** .....635  
*Mohammad Shafiur Rahman and Jorge F. Velez-Ruiz*

27. **Freezing–Melting Process in Liquid Food Concentration** .....667  
*Mohammad Shafiur Rahman, Mushtaque Ahmed, and Xiao Dong Chen*

<b>28. Microwave Pasteurization and Sterilization of Foods .....</b>	<b>691</b>
<i>Jaşim Ahmed and Hosahalli S. Ramaswamy</i>	
<b>29. Ultrasound in Food Processing and Preservation .....</b>	<b>713</b>
<i>P.J. Torley and Bhesh R. Bhandari</i>	
<b>30. Food Preservation Aspects of Ohmic Heating .....</b>	<b>741</b>
<i>Marybeth Lima</i>	
<b>31. Light Energy in Food Preservation .....</b>	<b>751</b>
<i>Mohammad Shafiur Rahman</i>	
<b>32. Irradiation Preservation of Foods .....</b>	<b>761</b>
<i>Mohammad Shafiur Rahman</i>	
<b>33. Pulsed Electric Fields in Food Preservation .....</b>	<b>783</b>
<i>Humberto Vega-Mercado, M. Marcela Gongora-Nieto, Gustavo V. Barbosa-Canovas, and Barry G. Swanson</i>	
<b>34. High-Pressure Treatment in Food Preservation .....</b>	<b>815</b>
<i>Enrique Palou, Aurelio Lopez-Malo, Gustavo V. Barbosa-Canovas, and Barry G. Swanson</i>	
<b>35. Applications of Magnetic Field in Food Preservation .....</b>	<b>855</b>
<i>Jaşim Ahmed and Hosahalli S. Ramaswamy</i>	
<b>36. Combined Methods for Food Preservation .....</b>	<b>867</b>
<i>Lothar Leistner</i>	
<b>37. Update on Hurdle Technology for Mild and Effective Preservation of Foods .....</b>	<b>895</b>
<i>Lothar Leistner</i>	
 <b>Part 5 Enhancing Food Preservation by Indirect Approach</b>	
<b>38. Packaging as a Preservation Technique .....</b>	<b>907</b>
<i>Mohammad Shafiur Rahman</i>	
<b>39. Types of Packaging Materials Used for Foods .....</b>	<b>917</b>
<i>Robert H. Driscoll and Mohammad Shafiur Rahman</i>	
<b>40. Food Packaging Interaction .....</b>	<b>939</b>
<i>Shyam S. Sablani and Mohammad Shafiur Rahman</i>	
<b>41. Hygienic Design and Sanitation .....</b>	<b>957</b>
<i>Mohammad Shafiur Rahman</i>	
<b>42. Hazard Analysis and Critical Control Point (HACCP) .....</b>	<b>969</b>
<i>Titus De Silva</i>	
<b>43. Good Manufacturing Practice (GMP) .....</b>	<b>1011</b>
<i>Titus De Silva</i>	
<b>44. Commercial Considerations: Managing Profit and Quality .....</b>	<b>1031</b>
<i>Anne Perera and Gerard La Rooy</i>	
<b>Index .....</b>	<b>1055</b>



---

# *Preface*

---

Food preservation is an action or a method of maintaining foods at a desired level of properties or nature for their maximum benefits. In general, each step of handling, processing, storage, and distribution affects the characteristics of food, which may be desirable or undesirable. Thus, understanding the effects of each preservation method and handling procedure on foods is critical in food processing. The first edition of this book was the first definitive source of information on food preservation. It was well received by readers and became a bestseller and was also translated into Spanish by Acribia, Spain, in 2003. Appreciation from scientists, academics, and industry professionals around the globe encouraged me to produce an updated version. This edition has been developed by expanding the previous one with the addition of new chapters and updating most of the chapters of the first edition. The 25 chapters in the first edition are now expanded to 44 chapters.

The processing of food is no longer as simple or straightforward as in the past. It is now moving from an art to a highly interdisciplinary science. A number of new preservation techniques are being developed to satisfy current demands of economic preservation and consumer satisfaction in nutritional and sensory aspects, convenience, absence of preservatives, low demand of energy, and environmental safety. Better understanding and manipulation of these conventional and sophisticated preservation methods could help to develop high-quality, safe products by better control of the processes and efficient selection of ingredients. Food processing needs to use preservation techniques ranging from simple to sophisticated; thus, any food process must acquire requisite knowledge about the methods, the technology, and the science of mode of action. Keeping this in mind, this edition has been developed to discuss the fundamental and practical aspects of most of the food preservation methods important to practicing industrial and academic food scientists, technologists, and engineers. Innovative technology in preservation is being developed in the food industry that can extend shelf life; minimize risk; is environment friendly; or can improve functional, sensory, and nutritional properties. The large and ever-increasing number of food products and new preservation techniques available today creates a great demand for an up-to-date handbook of food preservation methods. This book emphasizes practical, cost-effective, and safe strategies for implementing preservation techniques and dissects the exact mode or mechanisms involved in each preservation method by highlighting the effect of preservation methods on food properties.

The first edition was divided into four parts. Part 1: Preservation of Fresh Food Products encompassed the overview of food preservation and postharvest handling of foods. Part 2: Conventional Food Preservation Methods presented comprehensive details on glass transition, water activity, drying, concentration, freezing, irradiation, modified atmosphere, hurdle technology, and the use of natural preservatives, antioxidants, pH, and nitrites. Part 3: Potential Food Preservation Methods detailed new and innovative preservation techniques, such as pulsed electric fields, ohmic heating, high-pressure treatment, edible coating, encapsulation, light, and sound. Part 4: Enhancing Food Preservation by Indirect Approach described areas that indirectly help food preservation by improving quality and safety. These areas are packaging and hazard analysis.

The second edition is divided into five parts. The grouping of Parts 2 and 3 in the first edition could not be a clear approach since it was not easy to separate the conventional and the potential methods. In the second edition, a better rational approach is used for grouping. The basis of grouping is the mode of preservation method.

Part 1: Preservation of Fresh Food Products encompasses the overview of food preservation and postharvest handling of foods, which includes physiology of fresh fruits and vegetables; handling and postharvest treatments of fruits and vegetables; and postharvest handling of grains and pulses, fish and seafood, red meat, milk; and also minimal processing of fruits and vegetables. This part can be read independently for those who want a basic background in postharvest technology for foods of plant and animal origin. It also

gives valuable background information on the causes of food deterioration and classification of food preservation methods with the mode of their action.

Part 2: Preservation Using Chemicals and Microbes presents comprehensive preservation methods based on additives of chemical or microbiological nature, including fermentation, antimicrobials, antioxidants, pH-lowering agents, and nitrides. Each chapter covers the mode of preservation actions and their applications in food products.

Part 3: Preservation by Controlling of Water, Structure, and Atmosphere details preservation methods based on physical nature, including modified-atmosphere packaging; glass transition and state diagram; membrane technology; stickiness and caking; drying, including osmotic dehydration; water activity; surface treatment and edible coating; encapsulation and controlled release.

Part 4: Preservation Using Heat and Energy describes preservation methods based on thermal and other forms of energy, including pasteurization, canning and sterilization, cooking and frying, freezing, freezing–melting (or freeze concentration), microwave, ultrasound, ohmic heating, light, irradiation, pulsed electric field, magnetic field, and high pressure. In addition, chapters on hurdle technology (or combined methods) that uses a combination of preservation techniques are also included.

Part 5: Enhancing Food Preservation by Indirect Approach presents the approaches that indirectly help food preservation by improving quality and safety. These techniques are packaging, hygienic design and sanitation, hazard analysis and critical control point (HACCP), good manufacturing practice (GMP), and commercial considerations of managing profit and quality. Packaging is an integral part of food preservation and it has very wide scope. In this edition, packaging techniques are presented in three chapters.

This second edition will be an invaluable resource for practicing and research food technologists, engineers, and scientists, and a valuable text for upper-level undergraduate and graduate students in food, agriculture/biological science, and engineering. Writing a book is an endless process, so the editor would appreciate receiving new information and comments to assist in future compilations. I am confident that this edition will prove to be interesting, informative, and enlightening to readers.

**Mohammad Shafiur Rahman**

---

## *Acknowledgments*

I would like to thank Almighty Allah for giving me life and the opportunity to gain knowledge to write this book. I wish to express my sincere gratitude to the Sultan Qaboos University for giving me the opportunity and facilities to initiate such an exciting project, and supporting me toward my research and other intellectual activities. I would also like to thank all my earlier employers, BUET, UNSW, and HortResearch, from whom I built my knowledge and expertise through their support and resources. I wish to express my appreciation to the UNSW, SQU, and HortResearch Library staffs, who assisted me patiently with online literature searches and interlibrary loans.

I sincerely acknowledge the sacrifices made by my parents, Asadullah Mondal and Saleha Khatun, during my early education. Appreciation is due to all my teachers, especially Professors Nooruddin Ahmed, Iqbal Mahmud, Khaliqur Rahman, Jasim Zaman, Ken Buckle, Drs. Prakash Potluri and Robert Driscoll, and Mr. Habibur Rahman, for their encouragement and help in all aspects of pursuing higher education and research. I would like to express my appreciation to Professor Anton McLachlan, Drs. Hamed Al-Oufi, Malik Mohammed Al-Wardy, and Salem Ali Al-Jabri for their support toward my teaching, research, and extension activities at the Sultan Qaboos University. Special thanks to my colleagues Dr. Conrad Perera, Professor Dong Chen, Drs. Nejb Guizani, Shyam Sablani, Bhesh Bhandari, and Mushtaque Ahmed, and my other research team members, especially Mohd Hamad Al-Ruzeiki, Rashid Hamed Al-Belushi, Mohd Khalfan Al-Khusaibi, Nasser Abdullah Al-Habsi, Insaaf Mohd Al-Marhubi, and Intisar Mohd Al-Zakwani.

I wish to thank my relatives and friends, especially Professor Md. Mohar Ali Bepari and Dr. Md. Moazzem Hossain, Dr. Iqbal Mujtaba, and Arshadul Haque for their continued inspiration. I am grateful to my wife, Sabina Akhter (Shilpi), for her patience and support during this work, and to my little daughter, Rubaba Rahman (Deya), and son, Salman Rahman (Radhin), for allowing me to work at home and for sharing their computer. Most of the work on this book was done at home; thus, without my family's cooperation and support, it would have been very hard for me to complete and finalize this book.





---

## *Editor*

---

**Mohammad Shafiur Rahman** is an associate professor at the Sultan Qaboos University, Sultanate of Oman. He has authored or coauthored over 200 technical articles, including 70 refereed journal papers, 68 conference papers, 25 book chapters, 33 reports, 8 popular articles, and 3 books. He is also the author of the internationally acclaimed and award-winning *Food Properties Handbook*, published by CRC Press, Boca Raton, Florida, which was one of the bestsellers from CRC Press in 2002. The above book is in the process of becoming a second edition. He was invited to serve as one of the associate editors for the *Handbook of Food Science, Engineering and Technology*, and one of the editors for the *Handbook of Food and Bioprocess Modeling Techniques*, which is being published by CRC Press. Dr. Rahman initiated the publication of the *International Journal of Food Properties* (Marcel Dekker, Inc.) and is serving as its founding editor for more than 9 years.

Dr. Rahman has served as a member in the Food Engineering Series Editorial Board of Aspen Publishers, Maryland (1999–2003). In 2003 he was invited to serve as a member of the Food Engineering Series Board, Kluwer Academic/Plenum Publishers, New York. He was also invited to serve as a section editor for the *Sultan Qaboos University Journal of Agricultural Sciences* (1999). In 1998, he was invited to serve as a food science adviser for the International Foundation for Science (IFS) in Sweden.

Dr. Rahman is a member of the New Zealand Institute of Food Science and Technology and the Institute of Food Technologists, member of the American Society of Agricultural Engineers and the American Institute of Chemical Engineers, and member of the Executive Committee for International Society of Food Engineering (ISFE). He received his B.Sc. Eng. (Chemical) (1983) and M.Sc. Eng. (Chemical) (1984) from Bangladesh University of Engineering and Technology, Dhaka; M.Sc. (1985) in food engineering from Leeds University, England; and Ph.D. (1992) in food engineering from the University of New South Wales, Sydney, Australia. Dr. Rahman has received numerous awards and fellowships in recognition of his research/teaching achievements, including the HortResearch Chairman's Award, the Bilateral Research Activities Program (BRAP) Award, CAMS Outstanding Researcher Award 2003, and the British Council Fellowship.



---

## *Contributors*

---

**Jasim Ahmed** Department of Food Science, McGill University, Ste Anne de Bellevue, Quebec, Canada

**Mushtaque Ahmed** College of Agricultural and Marine Sciences, Sultan Qaboos University, Muscat, Sultanate of Oman

**Saud M. Al-Jufaili** Department of Marine Science and Fisheries, Sultan Qaboos University, Muscat, Sultanate of Oman

**Elizabeth A. Baldwin** Citrus and Subtropical Products Laboratory, Agricultural Research Service, U.S. Department of Agriculture, Winter Haven, Florida

**Gustavo V. Barbosa-Canovas** WSU Biological Systems Engineering, Center for Nonthermal Processing of Foods, Washington State University, Pullman, Washington

**Bhesh R. Bhandari** School of Land and Food Sciences, The University of Queensland, St. Lucia, Australia

**Titus De Silva** Montana Wines Ltd., Auckland, New Zealand

**Xiao Dong Chen** Department of Chemical Engineering, Monash University, Victoria, Australia

**Robert H. Driscoll** Food Science and Technology Program, School of Chemical Sciences and Engineering, The University of New South Wales, Sydney, Australia

**T.V. Gamage** Melbourne, Victoria, Australia

**M. Marcela Gongora-Nieto** Washington State University, Pullman, Washington

**Leon G. M. Gorris** European Chair in Food Safety Microbiology, Food Microbiology Laboratory, Wageningen University, The Netherlands

**Nejib Guizani** Department of Food Science and Nutrition, College of Agricultural and Marine Sciences, Sultan Qaboos University, Muscat, Sultanate of Oman

**Isam T. Kadim** Department of Animal and Veterinary Sciences, Sultan Qaboos University, Muscat, Sultanate of Oman

**Gerard La Rooy** Round Earth Business Process Improvement, Havelock North, New Zealand

**Theodore P. Labuza** Department of Food Science and Nutrition, University of Minnesota, St. Paul, Minnesota

**Yubin Lan** USDA-ARS-SPARC-APMRU, College Station, Texas

**Lothar Leistner** Formerly, Director and Professor of the Institute of Microbiology, Toxicology and Histology, Federal Centre for Meat Research, Kulmbach, Germany

**Marybeth Lima** Department of Biological and Agricultural Engineering, Louisiana State University Agricultural Center, Baton Rouge, Louisiana

**Aurelio Lopez-Malo** Chemical and Food Engineering Department, Universidad de las Americas-Puebla, Sta. Catarina Martir, Cholula, Puebla, Mexico

**Ajit K. Mahapatra** Agricultural Research Station, Fort Valley State University, Fort Valley, Georgia

**Osman Mahgoub** Department of Animal and Veterinary Sciences, Sultan Qaboos University, Muscat, Sultanate of Oman

**Vijay Kumar Mishra** Institute of Sustainability and Innovations and School of Molecular Sciences, Victoria University, Melbourne, Victoria, Australia

**Ann Mothershaw** Department of Food Science and Nutrition, College of Agricultural and Marine Sciences, Sultan Qaboos University, Sultanate of Oman

**Linus U. Opara** Agricultural Engineering and Postharvest Technology Program, College of Agricultural and Marine Sciences, Sultan Qaboos University, Muscat, Sultanate of Oman

**Enrique Palou** Chemical and Food Engineering Department, Universidad de las Americas-Puebla, Sta. Catarina Martir, Cholula, Puebla, Mexico

**Ronald B. Pegg** Department of Food Science and Technology, The University of Georgia, Athens, Georgia

**Herman W. Peppelenbos** Agrotechnology and Food Sciences Group, Wageningen University and Research, The Netherlands

**Anne Perera** Fresh Direct Ltd., Auckland, New Zealand

**Conrad O. Perera** Department of Chemistry, The University of Auckland, Auckland, New Zealand

**Jan Pokorny** Department of Food Chemistry and Analysis, Faculty of Food and Biochemical Technology, Prague Institute of Chemical Technology, Prague, Czech Republic

**Mohammad Shafiur Rahman** Department of Food Science and Nutrition, College of Agricultural and Marine Sciences, Sultan Qaboos University, Muscat, Sultanate of Oman

**Hosahalli S. Ramaswamy** Department of Food Science, McGill University, Ste Anne de Bellevue, Quebec, Canada

**M. N. Ramesh** Department of Food Engineering, Central Food Technological Research Institute, Mysore, India

**Shyam S. Sablani** Department of Food Science and Nutrition, College of Agricultural and Marine Sciences, Sultan Qaboos University, Muscat, Sultanate of Oman

**Fereidoon Shahidi** Department of Biochemistry, Memorial University of Newfoundland, St. John's, Newfoundland, Canada

**Eddy J. Smid** NIZO Food Research, Ede, The Netherlands

**Barry G. Swanson** Food and Nutrition Department, Washington State University, Pullman, Washington

**P.J. Torley** School of Land and Food Sciences, The University of Queensland, St Lucia, Queensland, Australia

**Humberto Vega-Mercado** Washington State University, Pullman, Washington

**Jorge F. Velez-Ruiz** Chemical and Food Engineering Department, Universidad de las Americas-Puebla, Cholula, Puebla, Mexico



## **Part 1**

# **Preservation of Fresh Food Products**





# 1

---

## *Food Preservation: Overview*

---

**Mohammad Shafiur Rahman**

### **CONTENTS**

1.1	Introduction .....	3
1.2	What Are Foods? .....	4
1.3	Food Preservation .....	4
1.3.1	Why Preservation? .....	4
1.3.2	How Long to Preserve? .....	5
1.3.3	For Whom to Preserve? .....	5
1.4	Causes of Deterioration .....	6
1.5	Food Preservation Methods.....	8
1.5.1	Inhibition .....	9
1.5.2	Use of Chemicals .....	9
1.5.3	Controls of Water and Structure .....	11
1.5.4	Control of Atmosphere.....	12
1.5.5	Inactivation.....	12
1.5.5.1	Use of Heat Energy.....	12
1.5.5.2	Use of High Pressure and Ultrasound.....	13
1.5.5.3	Use of Electricity .....	13
1.5.5.4	Use of Radiation .....	13
1.5.5.5	Use of Magnetic Field .....	14
1.5.6	Avoid Recontamination (Indirect Approach).....	14
1.6	Other Preservation Factors .....	15
	References .....	17

---

### **1.1 Introduction**

Food preservation involves the action taken to maintain foods with the desired properties or nature for as long as possible. The process is now moving from an art to a highly interdisciplinary science. This chapter provides an overview of food preservation methods with emphasis on inactivation, inhibition, and methods of avoiding recontamination. The final section is a discussion of the factors that need to be considered to satisfy present and future demands of the consumers and law-enforcing authorities.

In most countries, innovation, sustainability, and safety have become the main foci of modern industry and economy. The United Nations World Commission on Environment and Development defined sustainable development as “meeting the needs of the present generation without compromising the ability of future generations to meet their own needs.” A sustainable way of designing and developing food products stands to appeal to consumers, and provides a point of differentiation from competitors and a perfect platform for a range of positive public relations activities [6]. Innovation is vital to maintain progress in technology and engineering. Food safety is now the first priority of the food production and preservation industry, incorporating innovation and sustainability. The industry can compromise with some quantities such as color to some extent, but not with safety.

The preservation and processing of food is not as simple or straightforward as it was in the past. A number of new preservation techniques are being developed to satisfy current demands of economic preservation and consumer satisfaction in nutritional and sensory aspects, convenience, safety, absence of chemical preservatives, price, and environmental safety. Understanding the effects of each preservation method on food has therefore become critical in all aspects. This chapter provides overviews of the new technology, identifying the changing demands of food quality, convenience, and safety.

---

## 1.2 What Are Foods?

Foods are materials, raw, processed, or formulated, that are consumed orally by humans or animals for growth, health, satisfaction, pleasure, and satisfying social needs. Generally, there is no limitation on the amount of food that may be consumed (as there is for a drug in the form of dosage) [10]. This does not mean that we can eat any food item as much as we want. Excessive amounts could be lethal, for example, salt, fat, and sugar. Chemically, foods are mainly composed of water, lipids, fat, and carbohydrate with small proportions of minerals and organic compounds. Minerals include salts and organic substances include vitamins, emulsifiers, acids, antioxidants, pigments, polyphenols, and flavor-producing compounds [19]. The different classes of foods are perishable, nonperishable, harvested, fresh, minimally processed, preserved, manufactured, formulated, primary, secondary derivatives, synthetic, functional, and medical foods [21]. The preservation method is mainly based on the types of food that need to be prepared or formulated.

---

## 1.3 Food Preservation

Preservation methods start with the complete analysis and understanding of the whole food chain, including growing, harvesting, processing, packaging, and distribution; thus an integrated approach needs to be applied. It lies at the heart of food science and technology, and it is the main purpose of food processing. First, it is important to identify the properties or characteristics that need to be preserved. One property may be important for one product, but detrimental for others. For example, collapse and pore formation occur during the drying of foods. This can be desirable or undesirable depending on the desired quality of the dried product, for example, crust formation is desirable for long bowl life in the case of breakfast cereal ingredients, and quick rehydration is necessary (i.e., no crust and more open pores) for instant soup ingredients. In another instance, the consumer expects apple juice to be clear whereas orange juice could be cloudy.

### 1.3.1 Why Preservation?

Another important question is *why* food needs to be preserved. The main reasons for food preservation are to overcome inappropriate planning in agriculture, produce value-added products, and provide variation in diet [20]. The agricultural industry produces raw food materials in different sectors. Inadequate management or improper planning in agricultural production can be overcome by avoiding inappropriate areas, times, and amounts of raw food materials as well as by increasing storage life using simple methods of preservation. Value-added food products can give better-quality foods in terms of improved nutritional, functional, convenience, and sensory properties. Consumer demand for healthier and more convenient foods also affects the way food is preserved. Eating should be pleasurable to the consumer, and not boring. People like to eat wide varieties of foods with different tastes and flavors. Variation in the diet is important, particularly in underdeveloped countries to reduce reliance on a specific type of grain (i.e., rice or wheat). In food preservation, the important points that need to be considered are

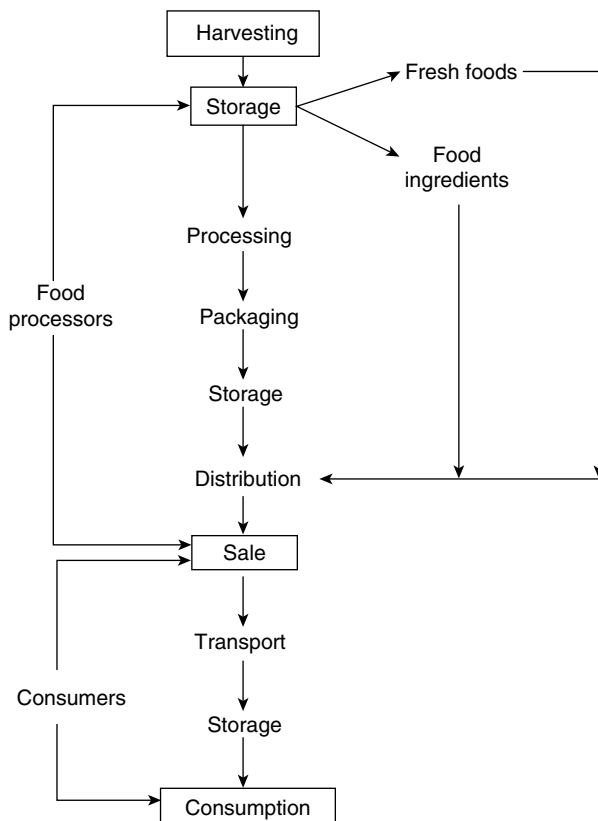
- The desired level of quality
- The preservation length
- The group for whom the products are preserved

After storage of a preserved food for a certain period, one or more of its quality attributes may reach an undesirable state. Quality is an illusive, ever-changing concept. In general, it is defined as the degree

of fitness for use or the condition indicated by the satisfaction level of consumers. When food has deteriorated to such an extent that it is considered unsuitable for consumption, it is said to have reached the end of its shelf life. In studying the shelf life of foods, it is important to measure the rate of change of a given quality attribute [25]. In all cases, safety is the first attribute, followed by other quality. The product quality attributes can be quite varied, such as appearance, sensory, or microbial characteristics. Loss of quality is highly dependent on types of food and composition, formulation (for manufactured foods), packaging, and storage conditions [25]. Quality loss can be minimized at any stage of food harvesting, processing, distribution, and storage. When preservation fails, the consequences range broadly from minor deterioration, such as color loss, to food becoming extremely hazardous [8].

### 1.3.2 How Long to Preserve?

After storage for a certain period, one or more quality attributes of a food may reach an undesirable state. At that time, the food is considered unsuitable for consumption and is said to have reached the end of its shelf life. This level is defined by the manufacturer according to criteria when the product is saleable. Best-before date is set shorter than the shelf life with a good margin. Hence, it is usually safe and palatable to consume a product a long time after the best-before date, provided the product has been stored at the recommended conditions. Products may be marketed with the production date “pack date” and “best-before date.” Alternative markings are use-by date or expiration date, which may be closer to shelf life than best-before date [1]. In studying the shelf life of foods, it is important to measure the rate of change of a given quality attribute [25]. The product quality can be defined using many factors, including appearance, yield, eating characteristics, and microbial characteristics, but ultimately the final use must provide a pleasurable experience for the consumer [23]. The various stages of food production, manufacture, storage, distribution,



**FIGURE 1.1** Various stages of food production, manufacture, storage, distribution, and sale.

and sale are shown in Figure 1.1. Quality loss can be minimized at any stage and thus quality depends on the overall control of the processing chain. The major quality-loss mechanisms and consequences are shown in Table 1.1 and Figure 1.2. The required length of preservation depends on the purpose. In many cases, very prolonged storage or shelf life is not needed, which simplifies both the transport and marketing of the foodstuff. For example, the meals prepared for lunch need a shelf life of only one or even half a day. In this case, there is no point in ensuring preservation of the product for weeks or months. In other cases, very long shelf life up to 3–5 years may be required, for example, foods for space travelers and food storage during wars.

### 1.3.3 For Whom to Preserve?

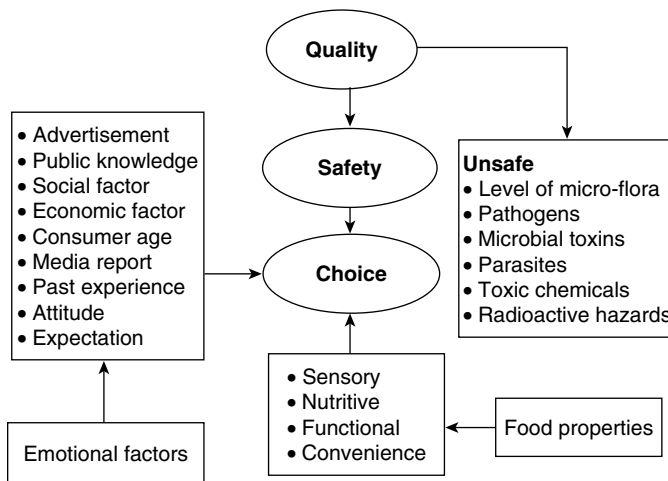
It is important to know for whom the preserved food is being produced. Nutritional requirements and food restrictions apply differently to different population groups. Food poisoning can be fatal, especially in infants, pregnant women, the elderly, and those with depressed immune systems. The legal aspects of food preservation are different

**TABLE 1.1**

Major Quality-Loss Mechanisms

Microbiological	Enzymatic	Chemical	Physical	Mechanical
Microorganism growth	Browning	Color loss	Collapse	Bruising due to vibration
Off-flavor	Color change	Flavor loss	Controlled release	Cracking
Toxin production	Off-flavor	Nonenzymatic browning Nutrient loss Oxidation–reduction Rancidity	Crystallization Flavor encapsulation Phase changes Recrystallization Shrinkage Transport of component	Damage due to pressure

Source: Gould, G. W. 1989. In: *Mechanisms of Action of Food Preservation Procedures*. Gould, G. W., Ed. Elsevier Applied Science, London; Gould, G. W. 1995. In: *New Methods of Food Preservation*. Gould, G. W., Ed. Blackie Academic and Professional, Glasgow.



**FIGURE 1.2** Factors affecting food quality, safety, and choice.

in case of foods produced for human and for animal consumption. Thus, it is necessary to consider the group for whom the products are being manufactured.

### 1.4 Causes of Deterioration

Mechanical, physical, chemical, and microbial effects are the leading causes of food deterioration and spoilage. Damage can start at the initial point by mishandling of foods during harvesting, processing, and distribution; this may lead to ultimate reduction of shelf life. Other examples of deterioration can be listed as follows: (i) bruising of fruits and vegetables during harvesting and postharvest handling, leading to the development of rot, (ii) tuberous and leafy vegetables lose water when kept in atmospheres with low humidity and, subsequently, wilt, and (iii) dried foods kept in high humidity may pick up moisture and become soggy. The four sources of microbial contaminants are soil, water, air, and animals (insects, rodents, and humans) (Table 1.2). The major causes of quality loss are shown in Table 1.1. In preservation, each

**TABLE 1.2**

## Organisms That Spoil Foods

- 
1. Microorganisms
    - a. Fungi: mold and yeast
    - b. Bacteria
    - c. Phages
    - d. Protozoa
  2. Insects and mites
    - a. Directly by eating (infestation)
    - b. Indirectly by spreading diseases (fruitfly, housefly)
  3. Rodents
    - a. Directly by consuming food
    - b. Indirectly by spreading diseases
- 

Source: Borgstrom, G. 1968. *Principles of Food Science*. Macmillan, London.

**TABLE 1.3**

## Storage Life of Some Fresh Foods at Normal Atmospheric Conditions

---

Food	Terminology	Storage Life
Meat, fish, and milk	Perishable	1–2 days
Fruits and vegetables	Semiperishable	1–2 weeks
Root crops	Semiperishable	3–4 weeks
Grains, pulses, seeds, and nuts	Nonperishable	12 Months

---

Source: Rahman, M. S. 1999. In: *Handbook of Food Preservation*. Rahman, M. S., Ed. Marcel Dekker, New York. pp. 1–9.

thawing or refreezing foods. Similarly, phase changes involving melting and solidifying of fats are detrimental to the quality of candies and other lipid-containing confectionary items. Shriveling occurs due to the loss of water from harvested fruits and vegetables.

Each microorganism has (i) an optimum temperature at which it grows best, (ii) a minimum temperature below which growth no longer takes place, and (iii) a maximum temperature above which all development is suppressed. Bacteria that grow particularly well at low temperatures are called *psychophilic* (*cryophilic*) or low-temperature organisms. Bacteria with an optimum temperature of 20°C–45°C are *mesophilic*, and those with an optimum temperature above 45°C are *thermophilic* [3]. Microbial growth in foods results in food spoilage with the development of undesirable sensory characteristics, and in certain cases the food may become unsafe for consumption. Microorganisms have the ability to multiply at high rates when favorable conditions are present. Prior to harvest, fruits and vegetables generally have good defense mechanisms against microbial attack; however, after separation from the plant, they can easily succumb to microbial proliferation. Similarly, meat upon slaughter is unable to resist rapidly growing microbes [25]. The pathogenicity of certain microorganisms is a major safety concern in the processing and handling of foods in that they produce chemicals in foods that are toxic to humans. Their growth on foods may also result in undesirable appearances and off-flavors. Microbial or chemical contaminants are also of concern in food deterioration. Chemicals from packaging materials may also be a source of food contamination.

Several chemical changes occur during the processing and storage of foods. These changes may cause food to deteriorate by reducing its sensory and nutritional quality. Many enzymatic reactions change the quality of foods. For example, fruits when cut tend to brown rapidly at room temperature due to the reaction of phenolase with cell constituents released in the presence of oxygen. Enzymes such as lipooxygenase, if not denatured during the blanching process, can influence food quality even at subfreezing

factor needs to be controlled or maintained to a desired level. Foods are perishable or deteriorative by nature. The storage life of fresh foods under normal atmospheric conditions is presented in Table 1.3.

During storage and distribution, foods are exposed to a wide range of environmental conditions. Environmental factors such as pressure, temperature, humidity, oxygen, and light can trigger several reactions that may lead to food degradation. As a consequence of these mechanisms, foods may be altered to such an extent that they are either rejected by or harmful to the consumer [25]. Condensation of moisture on foods or a damp atmosphere favors microbial growth, occasionally promotes insects development, and may indirectly lead to deterioration, resulting in destructive self-heating [3]. Mechanical damage (e.g., bruises and wounds) is conducive to spoilage, and it frequently causes further chemical and microbial deterioration. Peels, skins, and shells constitute natural protection against this kind of spoilage [3]. In case of frozen foods, fluctuating temperatures are often destructive, for example, fluctuating temperatures cause recrystallization of ice cream, leading to an undesirable sandy texture. Freezer burn is a major quality defect in frozen foods that is caused by the exposure of frozen foods to fluctuating temperatures. These large fluctuations may cause a phase change by

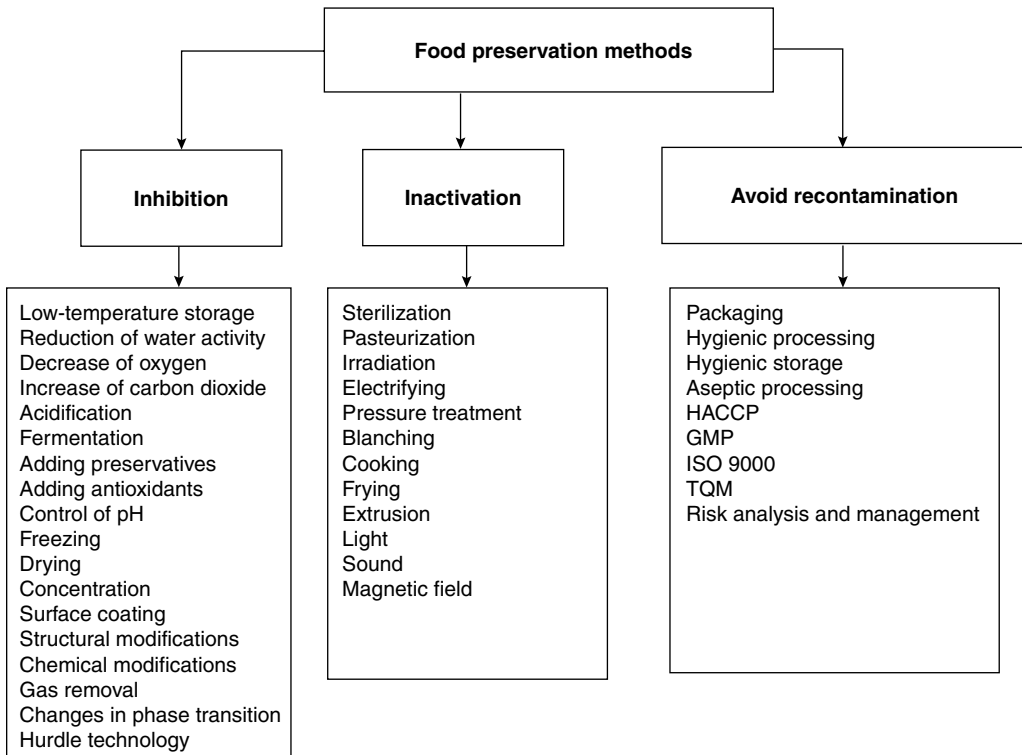
temperatures. In addition to temperature, other environmental factors such as oxygen, water, and pH induce deleterious changes in foods that are catalyzed by enzymes [25].

The presence of unsaturated fatty acids in foods is a prime reason for the development of rancidity during storage as long as oxygen is available. While development of off-flavors is markedly noticeable in rancid foods, the generation of free radicals during the autocatalytic process leads to other undesirable reactions, for example, loss of vitamins, alteration of color, and degradation of proteins. The presence of oxygen in the immediate vicinity of food leads to increased rates of oxidation. Similarly, water plays an important role; lipid oxidation occurs at high rates at very low water activities.

Some chemical reactions are induced by light, such as loss of vitamins and browning of meats. Nonenzymatic browning is a major cause of quality change and degradation of the nutritional content of many foods. This type of browning reaction occurs due to the interaction between reducing sugars and amino acids, resulting in the loss of protein solubility, darkening of lightly colored dried products, and development of bitter flavors. Environmental factors such as temperature, water activity, and pH have an influence on nonenzymatic browning [25].

## 1.5 Food Preservation Methods

Based on the mode of action, the major food preservation techniques can be categorized as (1) slowing down or inhibiting chemical deterioration and microbial growth, (2) directly inactivating bacteria, yeasts, molds, or enzymes, and (3) avoiding recontamination before and after processing [8,9]. A number of techniques or methods from the above categories are shown in Figure 1.3. While the currently used traditional preservation procedures continue in one or more of these three ways, there have recently been great efforts to improve the quality of food products principally to meet the requirements of consumers through the



**FIGURE 1.3** Major food preservation techniques. (From Gould, G. W. 1989. In: *Mechanisms of Action of Food Preservation Procedures*. Gould, G. W., Ed. Elsevier Applied Science, London; Gould, G. W. 1995. In: *New Methods of Food Preservation*. Gould, G. W., Ed. Blackie Academic and Professional, Glasgow.)

avoidance of extreme use of any single technique. Preservation starts when the harvested foods are separated from the medium of immediate growth (plant, soil, or water) or meat from the animal after slaughter, or milk from normal secretion of mammalian glands. Raw foods are those in the earliest or primary state after harvesting, milking, or slaughter; they have not been subjected to any treatment apart from cleaning and size grading in the case of foods of plant origin. Postharvest technology is concerned with handling, preservation, and storage of harvested foods, and maintaining its original integrity, freshness, and quality. The methods of preservation depend on the origin of foods—particularly whether they are of plant or animal origin. Postharvest handling of foods of plant origin includes efficient control of environmental atmosphere, such as humidity, gas composition, and temperature, and implementing an adequate packing, storage, and transport system. Physical treatments usually used are curing, precooling, temperature treatments, cleaning, and waxing, whereas chemical treatments are disinfection, fumigation, and dipping. Meat is the edible flesh of a number of species of mammal or bird, both wild and domesticated. Postharvest quality is affected by slaughter conditions or stress before death.

In the case of fish, preservation methods include chilling, electrical stimulation, and decontamination methods, for example, hot water rinsing with or without chlorination, decontamination with phosphate, hydrogen peroxide, chlorine, chlorine dioxide and ozone, and surface treatment by organic acids. Pretreatments, such as blanching, sulfiting, and other physical and chemical pretreatments are used before applying major preservations methods. The main purpose of pretreatment is to improve product quality and process efficiency. In recent years, altering processing strategy and pretreatment has gained much attention in the food industry.

The steps of cleaning and sanitization are important in food preservation. Chemical disinfectants vary in their ability to kill microorganisms. Effectiveness depends on the types of microorganisms, their attachment mechanisms, and physical characteristics of the produce. Some disinfectants are appropriate for use in direct-contact washes; others only for processing water, processing equipment or containers and facilities. It is important to know the effectiveness of the mechanisms of action of disinfectants, as well as the relevant microbial biochemistry. Several chemicals are utilized, such as chlorine, chlorine dioxide, hydrogen peroxide, ozone, peroxyacetic acid, bromine, iodine, trisodium phosphate, and quaternary ammonium compounds [5]. Although fumigants are not strictly preservatives, they are used for insect control. Methyl bromide is one of the fumigants used, but it has the potential to damage atmospheric ozone and is being phased out. There is a need for development of new environmentally safe methods of fumigation.

### 1.5.1 Inhibition

The methods based on inhibition include those that rely on control of the environment (e.g., temperature control), those that result from particular methods of processing (e.g., microstructural control), and those that depend on the intrinsic properties built into particular foods (e.g., control by the adjustment of water activity or pH value [9]). The danger zone for microbial growth is considered to be between 5°C and 60°C; thus chilling and storing at a temperature below 5°C is one of the most popular methods of food preservation.

### 1.5.2 Use of Chemicals

The use of chemicals in foods is a well-known method of food preservation. Wide varieties of chemicals or additives are used in food preservations to control pH, as antimicrobes and antioxidants, and to provide food functionality as well as preservation action. Some additives are entirely synthetic (not found in nature), such as phenolic antioxidant tertiary butylhydroquinone (TBHQ), and others are extracted from natural sources, such as vitamin E. Irrespective of origin, food additives must accomplish some desired function in the food to which they are added, and they must be safe to consume under the intended conditions of use.

Many legally permitted preservatives in foods are organic acids and esters, including sulfites, nitrites, acetic acid, citric acid, lactic acid, sorbic acid, benzoic acid, sodium diacetate, sodium benzoate, methyl paraben, ethyl paraben, propyl paraben, and sodium propionate [24]. When a weak acid is dissolved in water, equilibrium is established between undissociated acid molecules and charged anions, the proportion of undissociated acid increasing with decreasing pH. The currently accepted theory of preservative action



suggests inhibition via depression of internal pH. Undissociated acid molecules are lipophilic and pass readily through the plasma membrane by diffusion. In the cytoplasm, approximately at pH 7.0, acid molecules dissociate into charged anions and protons. These cannot pass across the lipid bilayer and accumulate in cytoplasm, thus lowering pH and inhibiting metabolism [14]. There are several limitations to the value of organic acids as microbial inhibitors in foods:

- They are usually ineffective when initial levels of microorganisms are high.
- Many microorganisms use organic acids as metabolizable carbon sources.
- There is inherent variability in resistance of individual strains.
- The degree of resistance may also depend on the conditions [24].

Nitrides and nitrates are used in many foods as preservatives and functional ingredients. These are critical components used to cure meat, and they are known to be multifunctional food additives and potent antioxidants. Many plants contain compounds that have some antimicrobial activity, collectively referred to as “green chemicals” or “biopreservatives” [26]. Interest in naturally occurring antimicrobial systems has expanded in recent years in response to consumers’ requirements for fresher, more natural additive-free foods [9]. A range of herbs and spices are known to possess antibacterial activity as a consequence of their chemical composition. Antimicrobial agents can occur in foods of both animal and vegetable origin. Herbs and spices have been used for centuries by many cultures to improve the flavor and aroma of foods. Essential oils show antimicrobial properties, and are defined by Hargreaves as a group of odorous principles, soluble in alcohol and to a limited extent in water, consisting of a mixture of esters, aldehydes, ketones, and terpenes. They not only provide flavor to the product, but also preservation activity. Scientific studies have identified the active antimicrobial agents of many herbs and spices. These include eugenol in cloves, allicin in garlic, cinnamic aldehyde and eugenol in cinnamon, allyl isothiocyanate in mustard, eugenol and thymol in sage, and isothymol and thymol in oregano [15].

Rancidity is an objectionable defect in food quality. Fats, oils, or fatty foods are deemed rancid if a significant deterioration of the sensory quality is perceived, particularly aroma or flavor, but appearance and texture may also be affected. Antioxidants are used to control oxidation in foods, and they also have health functionality by reducing risk of cardiovascular diseases and cancer, and slowing down the aging process. The use of wood smoke to preserve foods is nearly as old as open-air drying. Although not primarily used to reduce the moisture content of food, the heat associated with the generation of smoke also gives a drying effect. Smoking has been mainly used with meat and fish. Smoking not only imparts desirable flavor and color to some foods, but some of the compounds formed during smoking also have a preservative effect (bactericidal and antioxidant).

Hydrogen ion concentration, measured as pH, is a controlling factor in regulating many chemical, biochemical, and microbiological reactions. Foods having a pH < 4.5 are considered as low-risk foods; they need less severity in heat treatment. Microorganisms require water, nutrients, appropriate temperature, and pH levels for growth. Below an approximate pH of 4.2 most other food-poisoning microorganisms are well controlled, but microorganisms such as lactic acid bacteria and many species of yeast and molds grow at pH values well below this. Many weak lipophilic organic acids act synergistically at low pH to inhibit microbial growth. Thus, propionic, sorbic, and benzoic acids are very useful food preservatives. The efficacy of acids depends to a large extent on their ability to equilibrate, in their undissociated forms, across the microbial cell membrane and in doing so, interferes with the pH gradient that is normally maintained between the inside (cytoplasm) of the cell and the food matrix surrounding it. In addition to weak lipophilic acids, other preservatives widely used in foods include esters of benzoic acid, which are effective at higher pH values than organic acids. Inorganic acids, such as sulfate and nitrite, are most effective at reduced pH values, like organic acids. While these preservatives are employed at ppm levels of hundreds to thousands, the acids used principally as acidulants are often employed at percentage levels. The three regimes of pH actions are [2]

- Strong acids do not themselves penetrate the cell membrane. These acids may exert their influence by the denaturing effect of low pH on enzymes present on the cell surface and by lowering of the cytoplasmic pH due to increased proton permeability when the pH gradient is very large.

- Weak acids are lipophilic and penetrate the membrane. The primary effect of such acids is to lower cytoplasmic pH and undissociated acids may have specific effects on metabolism that amplify the effects of the weak acid.
- Acid-potentiated ions, such as carbonate, sulfate, and nitrate, which are inhibitors at lower pH.

The pH affects not only the growth of microorganism but also other components and processes, such as enzyme stability, gel formation, and stability of proteins and vitamins [20]. Antimicrobial enzymes also have current applications and further future potential in the food industry. They play a significant role in the defense mechanisms of living organisms against infection by bacteria and fungi. Many lytic enzymes now used in the food industry to degrade unwanted polysaccharides have potential for use as novel and natural food preservatives. One such enzyme, lysozyme from hen egg whites, has been known for many years and is used against clostridial spoilage in hard cooked cheese in France [22]. When enzymes are used, it is very important to maintain its activity for its effect in preservation. Hydrolytic antimicrobial enzymes function by degrading key structural components of the cell walls of bacteria and fungi, whereas antimicrobial oxidoreductases exert their effects by the *in situ* generation of reactive molecules. Fuglsang et al. [7] pointed that the potential of these enzymes in food preservation is still far from realized at present.

Antibiotics could be medical and nonmedical. Nonmedical antibiotics, such as natamycin and nisin, produced either by microbes or synthetically, inhibit microbes at very low concentration. Organisms present in food can become resistant to antibiotics and colonize the gut of animals and man. Antibiotics used therapeutically may then become ineffective. Also, antibiotics are used in growth enhancement and disease control in healthy animals. However, the increasing incidence of antibiotic resistance is of great concern and is becoming a complicated issue.

When a chemical is used in preservation, the main question is *how safe is it?* There should be a risk–benefit analysis. Antimicrobial agents or preservatives are diverse in nature, but legal, toxicological, marketing, and consumer considerations have created a trend such that both the number and amount of preservatives in use are diminishing rather than increasing [7].

### 1.5.3 Controls of Water and Structure

Many physical modifications are made in ingredients or foods during preservation. Such modifications can also improve the sensory, nutritional, and functional properties of foods. Changes experienced by foods during processing include glass formation, crystallization, caking, cracking, stickiness, oxidation, gelatinization, pore formation, and collapse. Through precise knowledge and understanding of such modifications, one can develop safe, high-quality foods for consumption [20].

Water is an important constituent of all foods. Scott in 1953 clearly identified that the activity of water as a medium is clearly correlated with the deterioration of food stability due to the growth of microorganisms and for stability this is more important than the total amount of water. This concept helps us to develop generalized rules or limits for stability of foods using water activity. This was the main reason why food scientists started to emphasize water activity rather than water content. Since then the scientific community has explored the great significance of water activity in determining the physical characteristics, processes, shelf life, and sensory properties of foods. The minimum water activity is the limit below which a microorganism or group of microorganisms can no longer reproduce. For most foods, this is in the water activity range of 0.6–0.7. Pathogenic bacteria cannot grow below a water activity of 0.85–0.86, whereas yeast and molds are more tolerant of a reduced water activity of 0.80, but usually no growth occurs below a water activity of about 0.62. The critical limits of water activity may also be shifted to higher or lower levels by other factors, such as pH, salt, antimicrobial agents, heat treatment, and temperature to some extent. Removing water, adding solutes, or change of solute–water interactions can reduce the water activity of a food.

Drying is one of the oldest methods of food preservation, where water activity is reduced by separating out water. Drying in earlier times was done under the sunlight, but today many types of sophisticated equipment and methods are being used to dehydrate foods—huge varieties of drying methods are now available. Drying is a method of water removal to form final products as solids, while concentration means the removal of water while retaining the liquid condition. The loss of flavor, aroma, or functional

compounds is the main problem with drying, in terms of quality. The cost of processing, packaging, transportation, and storage is less for dried products than canned and frozen foods. The concentration of liquid foods is mainly carried out by thermal evaporation, freeze concentration, and membrane separation. Each method has its advantages and disadvantages.

Freezing changes the physical state of a substance by changing water into ice when energy is removed in the form of cooling below freezing temperature. Usually, the temperature is further reduced to storage level at  $-18^{\circ}\text{C}$ . Microbial growth is completely stopped below  $-18^{\circ}\text{C}$ , and both enzymatic and nonenzymatic changes continue at much slower rates during frozen storage. There is a slow progressive change in organoleptic quality during storage. Freezing is more popular than drying due to its ability to retain more fresh-like qualities in the food.

Foods can be considered very stable in the glassy state since below glass temperature compounds involved in deterioration reactions take months or even years to diffuse over molecular distances and approach each other to react. The hypothesis has recently been stated that this transition greatly influences food stability, as the water in the concentrated phase becomes kinetically immobilized and therefore does not support or participate in reactions. Formation of a glassy state results in a significant arrest of translational molecular motion, and chemical reactions become very slow. Many attempts are being made to relate the glass concept to physicochemical changes in foods.

Edible coatings serve many purposes in food systems. Coatings are used to improve appearance or texture and reduce water loss. Examples include the waxing of apples and oranges to add gloss, waxing of frozen fish to add gloss and reduce shrinkage due to water loss, or coating of candies to reduce stickiness. Other surface treatments for foods include application of antioxidants, acidulants (or other pH-control agents), fungicides, preservatives, and mineral salts. The formulation of edible coatings depends on the purpose and type of products. Encapsulation has been used by the food industry for more than 60 years. In a broad sense, encapsulation technology in food processing includes the coating of minute particles of ingredients (e.g., acidulants, fats, and flavors) as well as whole ingredients (e.g., raisins, nuts, and confectionery products), which may be accomplished by microencapsulation and macrocoating techniques.

Gums and gels, such as casein, guar gum, agar, carrageenan, and pectin, are also used in food products to provide desired structure and functionality to the products. These are extremely important for the textural attributes, such as creaminess and oiliness of formulated products, and fat-mimic foods.

#### **1.5.4 Control of Atmosphere**

Packaging techniques based on altered gas compositions have a long history. The respiratory activity of the various plant products generates a low-oxygen and high-carbon dioxide atmosphere, which retards the ripening of fruit. Modified-atmosphere packaging is a preservation technique that may further minimize the physiological and microbial decay of perishable produce by keeping them in an atmosphere that is different from the normal composition of air. The gas composition and method of this technique depends on the types of produce and purposes. There are different ways of maintaining a modified atmosphere. In modified-atmosphere packaging (termed "passive atmosphere"), the gas composition within the package is not monitored or adjusted. In "controlled atmosphere packaging," the altered gas composition inside the packaging is monitored and maintained at a preset level by means of scrubbers and the inlet of gases. Active packaging can provide a solution by adding materials that absorb or release a specific compound in the gas phase. Compounds that can be absorbed are carbon dioxide, oxygen, water vapor, ethylene, or volatiles that influence taste and aroma. Vacuum and modified-humidity packaging contain a changed atmosphere around the product. Although this technique was initially developed to extend the shelf life of fresh products, it is now extended to minimally processed foods from plant and animal sources, and also to dried foods.

#### **1.5.5 Inactivation**

##### **1.5.5.1 Use of Heat Energy**

Earlier, mostly heat was used for inactivation. Thermal inactivation is still the most widely used process of food preservation. The advantages of using heat for food preservation are

- Heat is safe and chemical-free
- It provides tender cooked flavors and taste
- The majority of spoilage microorganisms are heat labile
- Thermally processed foods, when packed in sterile containers, have a very long shelf life

The main disadvantages of using heat are (i) overcooking may lead to textural disintegration and an undesirable cooked flavor, and (ii) nutritional deterioration results from high temperature processing. Heat treatment processes include mainly pasteurization, sterilization, cooking, extrusion, and frying. Recently, more electrotechnologies have been used and this will expand further in the future.

#### **1.5.5.2 Use of High Pressure and Ultrasound**

High-quality fresh foods are very popular, so consequently there is a demand for less extreme treatments and fewer additives. High-pressure hydrostatic technology gained attention for its novelty and nonthermal preservation effect. Studies examining the effects of high pressure on food date back to the end of the nineteenth century, but renewed research and commercialization efforts worldwide could soon bring high-pressure-treated foods back to several markets. The basis of high hydrostatic pressure is the Le Chatelier's principle, according to which any reaction, conformational change, or phase transition that is accompanied by a decrease in volume will be favored at high pressures, while reactions involving an increase in volume will be inhibited. Predictions of the effects of high-pressure treatments on foods are difficult to generalize due to the complexity of foods and the different changes and reactions that can occur. However, a tremendous amount of information is being developed on microbial, chemical, biochemical, and enzymatic reactions, development of functional and sensory properties, gel formation, gelatinization, and freezing process.

Ultrasound is sound energy with a frequency range that covers the region from the upper limit of human hearing, which is generally considered to be 20 kHz. The two applications of ultrasound in foods are (i) characterizing a food material or process, such as estimation of chemical composition, measurements of physical properties, nondestructive testing of quality attributes, and monitoring food processing, and (ii) direct use in food preservation or processing. The beneficial or deteriorative use of ultrasound depends on its chemical, mechanical, or physical effects on the process or products.

#### **1.5.5.3 Use of Electricity**

Many different forms of electrical energy are used in food preservation, e.g., ohmic heating, microwave heating, low electric field stimulation, high-voltage arc discharge, and high-intensity pulsed electric field. *Ohmic heating* is one of the earliest forms of electricity applied to food pasteurization. This method relies on the heat generated in food products as a result of electrical resistance when an electric current is passed through them. In conventional heating methods, heating travels from a heated surface to the product interior by means of both convection and conduction, which is time consuming, especially with longer convection or conduction paths. Electroresistive or ohmic heating is volumetric by nature and thus has potential to reduce overprocessing. It provides rapid and even or uniform heating, providing less thermal damage and increased energy efficiency. *Microwave heating* has been extensively applied in everyday households and the food industry, but the low penetration depth of microwaves into solid food causes thermal nonuniformity. *Low electric field* stimulation has been explored as a method of bacterial control in meat. The mechanism of microbial inactivation by electric field was first proposed by Pareilleux and Sicard [16]. The plasma membranes of cells become permeable to small molecules after being exposed to an electric field; permeation then causes swelling and the eventual rupture of the cell membrane. The reversible or irreversible rupture (or electroporation) of a cell wall membrane depends on factors such as intensity of the electric field, number of pulses, and duration of pulses. This new electroheating could be used to develop new products with diversified functionality.

#### **1.5.5.4 Use of Radiation**

Ionization radiation interacts with an irradiated material by transferring energy to electrons and ionizing molecules by creating positive and negative ions. The irradiation process involves exposing the foods, either prepackaged or in bulk, to a predetermined level of ionization radiation. The radiation effects on biological

materials are direct and indirect. In direct action, the chemical events occur as a result of energy deposition by the radiation in the target molecule, and the indirect effects occur as a consequence of reactive diffusible free radicals formed from the radiolysis of water, such as the hydroxyl radical ( $\text{OH}^\cdot$ ), a hydrated electron ( $\text{e}_{\text{aq}}^-$ ), a hydrogen atom, hydrogen peroxide, and hydrogen. Hydrogen peroxide is a strong oxidizing agent and a poison to biological systems, while the hydroxyl radical is a strong oxidizing agent and the hydrogen radical a strong reducing agent. Irradiation has wide scope in food disinfection, shelf life extension, decontamination, and product quality improvement. Although it has high potential, there is concern on legal aspects and safety issues, and consumer attitude toward this technology.

Ultraviolet (UV) radiation has long been known to be the major factor in the antibacterial action of sunlight. It is mainly used in sterilizing air and thin liquid films due to its low penetration depth. When used at high dosage, there is a marked tendency toward flavor and odor deterioration before satisfactory sterilization is achieved. UV irradiation is safe, environment friendly, and more cost-effective to install and operate than conventional chlorination. Visible light and photoreactivation are also used in food processing. If microorganisms are treated with dyes, they may become sensitive to damage by visible light. This effect is known as photoreactivation. Some food ingredients could induce the same reaction. Such dyes are said to possess photodynamic action. White and UV light are also used to inactivate bacteria, fungi, spores, viruses, protozoa, and cysts. Pulsed light is a sterilization method in applications where light can access all the important volume and surfaces. Examples include packaging materials, surfaces, transmissive materials (such as air, water, and many solutions), and many pharmaceuticals or medical products. The white light pulse is generated by electrically ionizing a xenon gas-filled lamp for a few hundred millionths of a second with a high-power, high-voltage pulse.

In many cases, it would be very difficult to make a clear distinction between inhibition and inactivation. Take, for example, preservation by drying and freezing. Although the main purpose of freezing and drying is to control the growth of microorganisms, there is also some destruction of microorganisms. Freezing causes the apparent death of 10%–60% of the viable microbial population and this gradually increases during storage.

#### **1.5.5.5 Use of Magnetic Field**

Magnetism is a phenomenon by which materials exert an attractive or repulsive force on other materials. The origin of magnetism lies in the orbital and spin motions of electrons and how the electrons interact with each other. Magnetic fields have potential in pasteurization, sterilization, and enhancing other factors beneficial to processing in food preservation.

#### **1.5.6 Avoid Recontamination (Indirect Approach)**

In addition to the direct approach, other measures such as packaging and quality management tools need to be implemented in the preservation process to avoid contamination or recontamination. Although these measures are not preservation techniques, they play an important role in producing high-quality safe food. With respect to the procedures that restrict the access of microorganisms to foods, the employment of aseptic packaging techniques for thermally processed foods has expanded greatly in recent years both in the numbers of applications and in the numbers of alternative techniques that are commonly available [9].

From skins, leaves, and bark, tremendous progress has been made in the development of diversified packaging materials and equipments. Packaging performs three main functions. The first is to control the local environmental conditions to enhance storage life. The second is the display, i.e., preservation of the product in an attractive manner to the potential buyer. The third function is to protect the product during transit to the consumer. The new concept of active or life packaging materials allows one-way transfer of gases away from the product or the absorption of gases detrimental to the product, antimicrobials in packaging, release of preservatives from controlled-release surfaces, oxygen scavengers, carbon dioxide generators, absorbers or scavengers of odors, absorption of selected wavelengths of light, and there are capabilities for controlled automatic switching. Another concept of edible or biodegradable packaging has also been evolved for environmental reasons. Processing and packaging can be integrated to improve efficiency.

Food safety has been of concern since the Middle Ages, and regulatory measures have been enforced to prevent the sale of adulterated or contaminated food. Food safety is now the highest priority. Recently, the

concepts of Hazard Analysis and Critical Control Point (HACCP), ISO 9000, Good Manufacturing Practices (GMP), Standard Operating Procedures (SOP), Hazard and Operability Studies (HAZOP), and Total Quality Management (TQM) have gained attention. HACCP is a state-of-the-art prevention approach to safe food production based on prevention and documentation, and is thus cost-effective. It is a proactive approach based on science. Most of the food industry around the globe is now targeting the implementation of HACCP programs for their processes to ensure safety. HACCP is a scientific, rational, and systematic approach to identification, assessment, and control of hazards during production, processing, manufacturing, preparation, and use of food to ensure that it is safe when consumed. This concept is based on the application of prevention and documentation. The HACCP system provides a preventive and thus a cost-effective approach to food safety. It is important to understand the concept of safety and quality first before planning to implement HACCP in the branch of the food industry or the products being targeted. The concepts of HACCP were initiated in the 1950s by the National Aeronautics and Space Administration (NASA) and the Natick Laboratories for use in aerospace manufacturing. This rational approach to process control for food products was developed jointly by the Pillsbury Company, NASA, and US Army Natick Laboratories in 1971 to apply a zero-defects program to the food process industry [14,17]. The World Health Organization (WHO) has recognized the importance of the HACCP system for the prevention of food-borne diseases for over 20 years and has played an important role in its development and promotion. One of the highlights in the history of the HACCP system was in 1993 when the Codex guidelines for the application of the HACCP system were adopted by the FAO/WHO Codex Alimentarius Commission, requiring them for international trade.

ISO 9000 is the generic standard that specifies minimum requirements to be fulfilled by organizations to meet a customer's needs. It does not specifically address the issue of food safety, but it addresses the need to identify and comply with regulatory requirements that are applicable to the product and process. ISO 9000 standard and HACCP techniques are complementary. HACCP techniques should therefore be used as a tool to support the quality management system ISO 9000.

To meet the requirements of GMP, regulatory bodies provided well-defined guidelines for food processing operations. GMP could be considered as the building blocks and cornerstones of the HACCP. TQM is a management philosophy that seeks continuous improvement in the quality of performance of all processes, products, and services of an organization. HAZOP is a systematic structured approach to questioning the sequential stages of a proposed operation to optimize the efficiency and the management of risk. Food regulatory authorities around the world are now very active in implementing these tools in the food industry. A quality management system does not guarantee food safety unless the hazards are identified and controlled.

Recently, the concept of hurdle technology or combined methods of preservation has gained attention. The microbial stability and safety of most traditional and novel foods is based on a combination of several preservative factors (called hurdles), which microorganisms present in the food are unable to overcome. This is illustrated by the so-called hurdle effect, first introduced by Leistner and his coworkers. He acknowledged that the hurdle concept illustrates only the well-known fact that complex interactions of temperature, water activity, pH, and redox potential are significant for the microbial stability of foods. With respect to procedures that slow down or prevent the growth of microorganisms in foods, major successes have been seen and new applications are steadily being made in the use of *combination preservation techniques* or *hurdle technology*. This has been supported by a greatly improved understanding of the principles underlying the stability and safety of an enormous number of combination-preserved foods that are traditional and indigenous to different parts of the world. Modified-atmosphere packaging has grown rapidly, particularly for the extension of the high-quality shelf life of certain chill-stored foods.

---

## 1.6 Other Preservation Factors

Applications of modern biotechnology with genetic modification will play a more important role in the future for more value-added products, and easy and efficient methods of preservation. Biotechnology is a general term for several techniques that use living organisms to make or modify products for a specific purpose. The techniques of biotechnology offer opportunities to address consumer issues of food quality and environmental safety. Biotechnology can be used to make fruits more flavorful; to improve nutritional and functional quality of fruits, vegetables, grains, and muscle foods; to grow foods in a wider

climate zone; and to grow foods in a more environmentally benign fashion [4]. The biggest application of biotechnology will be rapid and sensitive diagnostic kits for the detection of pathogens and unwanted xenobiotic compounds in foods. Another application of biotechnology will be on-package sensors that could indicate when a food is spoiled, or when a pathogen or its toxic by-product is present at some level of concern [13].

The major driving forces in the development and modification of food processing are the desire to reduce the extent of processing, i.e., the demand for *lightly processed* or *fresh-like*, organic, and natural foods; the desire to maximize automation, control, and efficiency; and the desire to minimize cost, and the need to respond to an ever-increasing strict regulations concerning environmental impact of various processes [11]. Nonthermal preservation technology is used to maintain nutrition and quality. There is a tendency to reduce intake of animal products, and to consume more cereal and cereal-based products, fruits, and vegetables. Other technologies being developed to meet the consumer desire for minimally processed foods is the shift from heat treatment for pasteurization and cooking, to use of electromagnetic waves, such as electron-beam and gamma radiation and microwave radiation. Microwave applications are easily accepted by the consumer but have never made major changes at the processing level. One of the major problems of this technology is to permit appropriate textures for the products while using intensities high enough to kill all pathogens despite their rapid time-temperature history [13]. Other potential electromagnetic processing techniques that can be used to minimize adverse heat changes due to cooking include pulsed light at high intensity, pulsed magnetic fields, direct current in a particulate stream (ohmic heating), pulsed electric discharge, and radio frequencies such as infrared. Food processing is very energy-intensive, and reducing energy use by using efficient electrotechnology can increase profit as well as reduce environmental impact. In many cases, fast or rapid heating by electrotechnology may not provide enough time to develop desired textures and flavors.

Food habits have been a very important component of human society since its inception. Changing trends and lifestyles demand more specific attributes. These include convenience in preparation and consumption, changing taste preferences, attitudes and perceptions about diet and health, more nutritional and functional advances in technology that influence food quality and availability, economic factors, ethnic and geographic regional factors, age, and suitability and convenience for lifestyle [4]. Eating away from home no longer means just sitting down in a restaurant. It can be done while sitting in a car, a train, a park bench, or at an office desk. New types of fast foods are emerging to meet the demand, and safety and innovation are needed. Taste, nutrition, and convenience are the driving forces in today's market. There is also a great emphasis on simple meal preparation at home, especially with microwave cooking.

Antinutritional factors in many raw materials need to be considered and adequate pretreatments should be used before major preservation steps. It is important to reduce pesticide residues in the final products and these must be used as little as possible. There is increasing utilization of integrated pest management (IPM) as a part of growing and processing. Usually pesticide residues decrease, often dramatically, during processing and preparation. The process of washing and peeling fruits and vegetables generally results in significant declines in the amount of pesticide detected in the food. This is especially true for pesticide residues that are found only on the surface of the commodity [18]. The amount of residue depends largely on the pesticide, the commodity, and the process used. Exceptions may also occur when processing causes degradation of the chemical, creating a chemical that is more toxic than the parent chemical. A stewardship program is used for control of pesticide residues. There is great consumer concern regarding potentially harmful chemicals in the food supply, such as hydrocarbons, dioxin, and heavy metals.

The factors that should be considered before selecting a preservation process are the desired quality of the products, the economics of the process, and the environmental impact of the methods. Food industry waste is now also of concern to law-enforcing authorities and consumers. Food waste is not only an economic loss, but it also has an impact on the environment. It is important to make every effort to minimize waste, set up effective recycling systems, and implement suitable systems for value-added products. The ultimate success of the food industry lies in the timely adoption and efficient implementation of the emerging new technologies to satisfy the present and the future demands of the consumer.

---

## References

1. Bengtsson, G. 2003. Keeping quality of fresh foods. Workshop on Food Safety and Quality, 13–14 December, Sultan Qaboos University, Muscat.
2. Booth, I. R., Kroll, R. G. 1989. The preservation of foods by low pH. In: *Mechanisms of Action of Food Preservation Procedures*. Gould, G. W., Ed. Elsevier Applied Science, London. p. 119.
3. Borgstrom, G. 1968. *Principles of Food Science*. Macmillan, London.
4. Bruhn, C. M. 1998. Consumer attitudes and perceptions. In: *Food Storage Stability*. Taub, I. A., Singh, R. P., Eds. CRC Press, Boca Raton, FL. pp. 507–517.
5. Cherry, J. P. 1999. Improving the safety of fresh produced with anti-microbials. *Food Technol.* 53(11): 54–59.
6. French, S. 2004. What does sustainability mean to the food industry? *Food Technol.* 58(9): 160.
7. Fuglsang, C. C., Johansen, C., Christgau, S., Adler-Nissen, J. 1995. Anti-microbial enzymes: applications and future potential in the food industry. *Trends. Food Sci. Technol.* 6: 390–396.
8. Gould, G. W. 1989. Introduction. In: *Mechanisms of Action of Food Preservation Procedures*. Gould, G. W., Ed. Elsevier Applied Science, London. pp. 1–10.
9. Gould, G. W. 1995. Overview. In: *New Methods of Food Preservation*. Gould, G. W., Ed. Blackie Academic and Professional, Glasgow.
10. James, G. 1995. The therapeutic goods authority (TGA) perspective on functional foods. In: *Foods of the Future Conference*, 18–19 September. Sydney.
11. Karel, M. 1991. Advances in science and engineering—a challenge to food technology. *Food Aust.* 43(10): 459–463.
12. Krebs, H. A., Wiggins, D., Stubs, M., Sols, A., Bedoya, F. 1983. Studies on the mechanism of the anti-fungal action of benzoate. *Biochem. J.* 214: 657–663.
13. Labuza, T. P. 1994. Shifting food research paradigms for the 21st century. *Food Technol.* 48(12): 50–56.
14. Marriott, N. G. 1999. *Principles of Food Sanitation*. 4th ed. Aspen Publishers, Maryland.
15. Mothershaw, A. S., Al-Ruzeiki, M. 2001. Anti-microbial activity of natural inhibitors against *Salmonella typhimurium*. *Agric. Sci.* 6(1–2): 47–51.
16. Pareilleux, A., Sicard, N. 1970. Lethal effects of electric current on *Escherichia coli*. *Appl. Microbiol.* 19: 42.
17. Perera, A., De Silva, T. 1999. Hazard Analysis and Critical Control Point (HACCP). In: *Handbook of Food Preservation*. Rahman, M. S., Ed. Marcel Dekker, New York. pp. 735–768.
18. Petersen, B., Tomerlin, J. R., Barraj, L. 1996. Pesticide degradation: exceptions to the rule. *Food Technol.* 50(5): 221–223.
19. Raemy, A., Lambelet, P. 1991. Thermal behaviour of foods. *Thermochim. Acta.* 93: 417.
20. Rahman, M. S. 1999. Purpose of food preservation and processing. In: *Handbook of Food Preservation*. Rahman, M. S., Ed. Marcel Dekker, New York. pp. 1–9.
21. Rahman, M. S. 2006. *Food Properties: Users' Handbook*. ORK, Dhaka.
22. Roller, S. 1995. The quest for natural anti-microbials as novel means of food preservation: status report on a European research project. *Int. Biodeter. Biodegrad.* 36(3/4): 333–345.
23. Sebranek, J. G. 1996. Poultry and poultry products. In: *Freezing Effects on Food Quality*. Jeremiah, L. E., Ed. Marcel Dekker, New York. p. 85.
24. Silliker, J. H., Elliott, R. P., Baird-Parker, A. C., Bryan, F. L., Christian, J. H. B., Clark, D. S., Olson, J. C., Roberts, T. A., Eds. 1980. *Microbial Ecology of Foods. Volume 1: Factors Affecting Life and Death of Microorganisms*. Academic Press, New York.
25. Singh, R. P. 1994. Scientific principles of shelf life evaluation. In: *Shelf Life Evaluation of Foods*. Man, C. M. D., Jones, A. A., Eds. Blackie Academic and Professional, Glasgow. pp. 3–24.
26. Smid, E. J., Gorris, G. M. 1999. Natural anti-microbials for food preservation. In: *Handbook of Food Preservation*. Rahman, M. S., Ed. Marcel Dekker, New York. pp. 285–308.





# 2

## *Postharvest Physiology of Fruit and Vegetables*

Vijay Kumar Mishra and T.V. Gamage

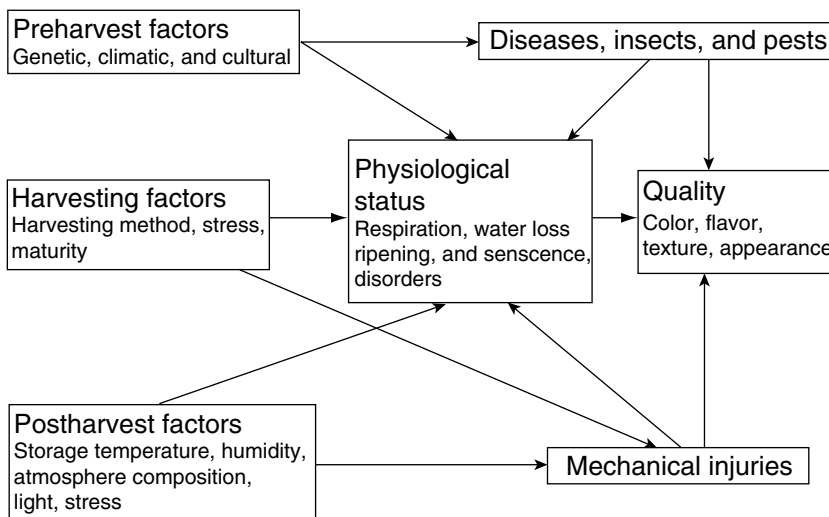
### CONTENTS

2.1	Postharvest Quality .....	19
2.1.1	Factors Affecting Quality .....	20
2.1.1.1	Preharvest Factors .....	20
2.1.1.2	Harvesting Factors .....	21
2.1.1.3	Postharvest Factors .....	24
2.2	Postharvest Physiological Processes .....	26
2.2.1	Ontogeny .....	26
2.2.2	Respiration .....	27
2.2.3	Transpiration and Water Stress .....	30
2.2.4	Ripening and Senescence .....	32
2.2.5	Phytohormone Effects .....	34
2.2.6	Physiological Disorders and Breakdowns .....	36
2.2.6.1	Disorders due to Mineral Deficiencies .....	38
2.2.6.2	Disorders due to Environmental Factors .....	38
2.2.7	Other Biochemical Changes .....	40
	References .....	43

### 2.1 Postharvest Quality

Postharvest period begins at the separation of plant organ used as food from the medium of its immediate growth or production, and ends when it enters the process of preparation for final consumption or further preservation [46]. Fruit and vegetables are live tissues harvested at various stages of growth and development, have tender texture, contain high moisture content (60%–95%) and water activity, lose water to the surrounding atmosphere, and continue respiration, which produces heat and water at the expense of food reserves, carbohydrates, proteins, lipids, etc., which were otherwise replaced by photosynthates and nutrients supplied by the plant before harvest.

Fruits and vegetables are consumed in fresh, minimally processed, and processed forms (canned, frozen, dried, preserves, and fermented products). Raw material quality influences the quality of processed fruit and vegetable products as quality can only at best be maintained and not improved by processing [4]. Kader [48] defined quality as “a combination of characteristics, attributes, or properties that give the commodity value as a human food.” Specific quality requirements in terms of raw material vary with the nature of the product and processing applied on it. Quality attributes normally used for raw materials are physical (size, firmness, presence or absence of seeds, etc.), compositional (natural sugars and volatiles), nutritional (vitamins, antioxidants, and functional components), and sensory (color, texture, taste, flavor, and odor) [19,44,87,96]. Quality evaluation consists of measurement of appearance, texture, flavor, nutritive value, and safety of the produce. Safety aspects need to be considered first before all other quality attributes. High shelf life of fruits and vegetables before processing is an additional criterion used by processors to assess their suitability as a raw material as



**FIGURE 2.1** Schematic representation of factors affecting postharvest quality of fruits and vegetables.

it increases the processing season. Minimization of deterioration of postharvest quality of plant produce used for processing is the main aim of suppliers of raw materials. Being live, quality of fruits and vegetables is directly related to the physiological status and a host of other factors such as diseases and pests, mechanical injuries, and exposure during postharvest handling (Figure 2.1). Knowledge of postharvest physiology is therefore fundamental to understand the process of deterioration of quality before reaching the processor.

## 2.1.1 Factors Affecting Quality

### 2.1.1.1 Preharvest Factors

#### 2.1.1.1.1 Genetic

Genetic makeup has a profound effect on the selection of a raw material for a given processing application. Cultivar and rootstock selection influence the composition, quality, storage potential, and response to processing characteristics that may be inherited. In many cases, fruit cultivars grown for fresh market sale are not suited for processing and vice versa. For example, grape varieties used for wine-making are different from those used for fresh food market. Several criteria are used by breeders in the development of new varieties, such as higher yield, resistance to disease and disorders, improved compositional and nutritional values, reduction in undesired toxic compounds, and improved processing characteristics. Out of the pool of several varieties, there have been studies to identify those that suit a particular processing method [12,33,43,61,103,117]. Modern processors usually contract out growers who grow a particular variety or cultivar that suits the raw material specifications for a given type of processing.

Recently, there has been a significant amount of work reported on the modification of genetic makeup to improve the postharvest performance of fruits and vegetables [33,108,118]. Transgenic fruits and vegetables have been released that have reduced browning and softening tendencies, and increased shelf life [33], and uniformity of flavor and color. Table 2.1 lists the transgenic fruits and vegetables released and traits targeted.

#### 2.1.1.1.2 Climatic

The growing region and environmental conditions specific to each region, such as temperature, humidity, light, wind, soil texture, elevation, and rainfall, significantly influence the quality of fruits and vegetables [49,85,94]. The duration, intensity, and quality of light during cultivation affect the quality at harvest. In tomatoes, leaf shading of fruits is known to result in a deeper red color during the ripening and when

**TABLE 2.1**

Transgenic Fruits and Vegetables Released with Improved Quality Claims

Produce	Traits
Apple	Reduction in the incidence of bitter pit
Banana	Delayed ripening, increased bruise resistance
Melon	Altered ripening
Eggplant	Seedless
Cucumber	Seedless
Pepper	Altered ripening and improved flavor
Potato	Reduced bruise sensitivity, increased amylopectin
Strawberries	Delayed softening and ripening
Tomato	Increased solid content, delayed ripening, increased shelf life

grown in full sunlight contain more sugar and dry matter [121]. Exposure to sun tends to make citrus fruits lighter in weight, with thinner rind, low amounts of juice and acids, and high solid content compared to those that were shaded or those inside a canopy. The differences in day length and light quality affect the product physiology; for example, onion varieties developed for short-day climates will not produce large bulbs [112]. In purple cabbage and eggplants, formation of anthocyanin pigments is controlled by short wavelengths of light in the blue and violet regions [75]. Thiamine synthesis in plants is stimulated by light and generally occurs in the leaves and increases in concentration until the plant matures. Turnips harvested in the morning contain more riboflavin than those harvested at other times of the day [85]. Among leafy vegetables, leaves are larger and thinner under a

condition of low light intensity [75]. Fruits grown in cold climate usually are more acidic than those grown in warmer regions [100].

#### 2.1.1.1.3 Cultural Practices

Soil type, soil nutrient and water supply, pruning, thinning, pest control or chemical spray, and density of planting influence the quality of plant produce [25,49,75,86]. Fertilizer addition affects the mineral content of fruits, while other cultural practices such as pruning and thinning may influence nutritional composition by changing fruit crop load and size [49]. The closer the planting, the less will be the sweetness of fruits. Many physiological disorders have been linked to the nutrient status of the soil [86]. Potatoes grown in sandy, gravelly or light loamy soils, and low-water or fertility soils have consistently produced higher dry matter than those grown in peat or low-moisture soils. A high N/K ratio and phosphorus deficiency in soil increases the tendency of potato to darken after cooking. Pineapple plants receiving undue amounts of nitrogen produce tart, white, and opaque fruits of poor flavor characteristics [86]. Pesticide residues may give rise to flavor taints in fresh and processed products, and excessive use of pesticides may even produce harmful metabolites and toxicity that may not be necessarily destroyed during processing or heat treatment [86].

### 2.1.1.2 Harvesting Factors

#### 2.1.1.2.1 Maturity at Harvest

Maturity at harvest is the most important quality criterion for a processor as it directly affects composition, quality, losses, and the storage potential of plant produce. The optimum harvest maturity is vital to achieve maximum postharvest life of the fresh produce [49,52]. Although most fruits reach peak eating quality when harvested fully ripe, they are usually picked mature, but not ripe, to decrease mechanical injury during postharvest handling. Immature fruits are more subject to shriveling and mechanical damage, and are of inferior quality when ripened. Overripe fruits are likely to become soft and mealy with insipid flavor soon after harvest. Fruits picked either too early or too late in the season are more susceptible to physiological disorders and have a shorter storage life than those picked at mid-season [49]. Harvesting fruits either immature or overripe can cause extensive loss of the produce; thus maturity indices are important criteria used for arriving at a correct harvesting stage. The optimum maturity of produce for fresh consumption and processing is determined by the purpose for which it will be used. The maturity stage considered best for canning may not be best for dehydration, freezing, or making jams or preserves. For example, fully ripened fruits should be used for drying and making concentrated products (tomato sauce) to achieve the best flavor, but for fresh marketing these may not be suitable for its susceptibility to damage.

Several indices are used to identify and evaluate the maturity for harvest and for assessing suitability for a processing application. Maturity indices vary among types, cultivars of the produce, and intended processing. The indices used are based on (i) measurable change in visual appearance (size and shape, overall color, skin color, flesh color, presence of dried outer mature leaves, drying of plant body, development of abscission layer, surface morphology and structure, and fullness of fruit); (ii) elapsed days from full bloom to harvest, and mean heat units during development; (iii) physical changes (ease of separation or abscission, flesh firmness, tenderness, specific gravity or density); (iv) chemical changes (soluble solids, starch, acidity, sugar/acid ratio, juice content, oil content, tannin content); and (v) measurable physiological changes (respiration and internal ethylene concentration). Both objective and subjective methods are used in measurement of indices. Tables 2.2 and 2.3 show commonly used indices for assessing maturity for harvesting and for assessing suitability for processing for selected vegetables

**TABLE 2.2**

Harvest Maturity Indices for Vegetables and Specifications for Processing

Vegetable	Harvest	Specifications for Processing
Broccoli	Compact bud cluster	
Cabbage	Compact head	Sauerkraut (mild flavored, sweet, solid white head, sugar >2%, ascorbic acid 30–60 mg/100 g)
Carrot	Crispy and long enough	Canning (tender texture) Juicing (juice yield and sugars >6 °B)
Cauliflower	Compact curd	
Cucumber	Size and tenderness	Pickles (ripe with sugar content of 1.5%–2.5%)
Eggplant	Desirable size and tenderness	
Lettuce	Desirable size before flowering	
Okra	Desirable size and tips snap off easily	Canning (small, young, and tender)
Olives	Straw yellow to cherry red	Pickling (slightly less mature, size, color)
Onion	Tops beginning to dry	Drying (high solids content)
Peas	Well-filled pods that snap easily	Canning (13.4% AIS, tenderometer reading of 115–125) Freezing (13.4% AIS, tenderometer reading of 95–105) Drying (9%–11% AIS, tenderometer reading of 85–95)
Potato	Tops beginning to dry	Chips (dry matter of 21%–24%, specific gravity (>1.075), <1.5% sugar) French fries (specific gravity of 1.08–1.12, <0.3% reducing sugar), frozen chips (total solids 20–22%, <0.2%) Canning (whole tubers of 19–38 mm size, specific gravity of <1.08) Dehydrated diced potatoes (specific gravity of 1.1) Starch manufacture (minimum of 15% starch)
Sweet corn	Milky sap oozing upon pressing	Canning (slightly immature kernels)
Tomato	Seeds slip upon cutting the fruit	Most processed products (SS > 5%)

Source: Data from M. E. Dauthy. *Fruit and Vegetable Processing*, FAO Agricultural Bulletin No. 119, FAO of the United Nations, Rome, 1995 ([www.fao.org/documents/show\\_cdr.asp?url\\_file=/docrep/V5030E/V5030E0s.htm](http://www.fao.org/documents/show_cdr.asp?url_file=/docrep/V5030E/V5030E0s.htm)); S. D. Holdsworth. *The Preservation of Foods and Vegetable Food Products*, Macmillan, London, 1983; A. A. Kader. *Acta Hort.*, 485:203, 1999; L. Kitinaja and A. A. Kader. *Small-Scale Postharvest Handling Practices: A Manual for Horticultural Crops*, 3rd ed., University of California, Davis, 1995; G. Lisinska and W. Leszczynski. *Potato Science and Technology*, Elsevier Applied Science, London, 1989; A. Maestrelli. In *Managing Frozen Foods* (C. J. Kennedy, Ed.), Woodhead Publishing, Cambridge, 2000, p. 27; S. Ranganna. *Handbook of Analysis and Quality Control for Fruit and Vegetable Products*, 2nd ed., Tata McGraw-Hill Publishing Co., New Delhi, 2004; R. Rodriguez, B. L. Raina, E. B. Pantastico, and M. B. Bhatti. Quality of raw materials for processing. In *Postharvest Physiology, Handling, and Utilization of Tropical and Subtropical Fruits and Vegetables* (E. B. Pantastico, Ed.), AVI Publishing, Westport, CT, 1975, p. 467.

TABLE 2.3

Maturity Indices for Fruits Harvesting and Specifications for Processing

Fruit	Harvest	Specifications for Processing
Apple	140–150 days from the bloom, starch content	Sauce and canned products (maximum shear press values of 3.1–3.3 kN for slices, minimum SS of 10% for sauce)
Apricot	¾ of the area of the fruit should have yellowish green or ½ yellow	Canning (full flavor) Drying (full flavor and ripening)
Banana	Pulp-to-peel ratio of 1.35–1.4, or disappearances of angularity, color	Banana puree (complete disappearance of angularity and full flavor, and flesh appears translucent)
Grapes	14%–17.5% SS, or SS/A of 20 or higher	White wine fermentation (pH 3.1–3.3, TA 0.7–0.9, Brix 19–22 °B), red wine fermentation (pH 3.3–3.6, TA 0.6–0.8, Brix 21–23.5°B)
Orange	SS/A of 8	Minimum juice content of 30%–35%, frozen juice concentrate (12.5–19.5 SS/A)
Pear	>13% SS and yellowish-green color	Canning (full flavor and firmness measured to 66.7–75.6 N)
Mango	Change of peel color from green to yellow	Canning (full flavor and total sugar/soluble solids ratio close to 1)
Strawberries	>2/3 of fruit surface has pink or red color	Freezing (firmness equivalent to 10–15 N force)

Source: Data from L. Bedford. In *Chilled Foods—A Comprehensive Guide*, 2nd ed. (M. Stringer and C. Dennis, Eds), CRC Press, Boca Raton, FL, 2000, p. 19; A. A. Kader. *Acta Hort.*, 485:203, 1999; A. Maestrelli. In *Managing Frozen Foods* (C. J. Kennedy, Ed.), Woodhead Publishing, Cambridge, 2000, p. 27; Y. Margalit. *Winery Technology and Operations*, Wine Appreciation Guild, San Francisco, 1996; A. K. Mattoo et al. In *Postharvest Physiology, Handling, and Utilization of Tropical and Subtropical Fruits and Vegetables* (E. B. Pantastico, Ed.), AVI Publishing, Westport, CT, 1975, p. 103; R. F. Matthews. *Frozen Concentrated Orange Juice from Florida Oranges*, University of Florida, Fact sheet FS 8, April 1994 (reviewed on April 1, 2003) T. Nilsson. In *Fruit and Vegetable Quality, An Integrated View* (R. L. Shewfelt and B. Bruckner, Eds), Technomic Publishing Co., Pennsylvania, 2000, p. 96; S. Ranganna. *Handbook of Analysis and Quality Control for Fruit and Vegetable Products*, 2nd ed., Tata McGraw-Hill Publishing Co., New Delhi, 2004; R. Rodriguez, B. L. Raina, E. B. Pantastico, and M. B. Bhatti. Quality of raw materials for processing. In *Postharvest Physiology, Handling, and Utilization of Tropical and Subtropical Fruits and Vegetables* (E. B. Pantastico, Ed.), AVI Publishing, Westport, CT, 1975, p. 467; A. L. Ryall, and W. J. Lipton. *Handling, Transportation and Storage of Fruits and Vegetables, Vol. 1, Vegetables and Melons*, AVI Publishing, Westport, CT, 1972; M. B. Springett, Ed., *Raw Ingredient Quality in Processed Foods—The Influence of Agricultural Principles and Practices*, Aspen Publishers Inc., Gaithersburg, MD, 2001, p. 125; R. C. Wiley and C. R. Binkley. In *Processed Apple Products*, (D. L. Downing, Ed.), Van Nostrand Reinhold, New York, 1989, p. 215.

and fruits, respectively. Each method has its own limitations and advantages and accurate assessment can only be done using a combination of indices [49,56,86].

#### 2.1.1.2.2 Harvesting Methods

Harvesting can be done manually or mechanically. The advantages of manual harvesting are (i) accurate selection and grading according to maturity, (ii) minimum damage to commodity, (iii) minimum capital investment, and (iv) mechanical devices can be used as aids to manual harvesting. The disadvantages are (i) it needs management of labor force and (ii) it is slow. The advantages of mechanical harvesting are (i) it is fast and (ii) it requires low labor and easy management. The disadvantages are (i) it may cause mechanical damage to the produce by skin abrasion and tissue bruising and (ii) it requires trained personnel and a special field lay out, and cropping patterns. The use of improper machinery and equipment in mechanical harvesting may cause serious food losses [86]. The harvesting system used and its management has a direct effect on incidence and severity of mechanical injuries. Thus, for best results, management procedures should include the following: (i) selection of optimum time to harvest regarding fruit maturity and climatic

conditions, (ii) training and supervision of workers, and (iii) effective quality control procedure [46]. Pickers can be trained in methods of identifying the produce that is ready for harvest [56].

Harvested vegetables other than root crops should not be placed directly on the soil or be exposed to sunlight, heat, and rain. Exposure to sun can lead to a high internal temperature, which is detrimental to the quality [82]. A simple shade or grass coverage can provide protection to the harvested products. Some root crops can benefit by brief exposure to the sun to dry off the surface or facilitate removal of adhering soil [86]. Picking during the day- or nighttime, and weather conditions also affect the quality. Harvesting during or immediately after rains should be avoided and preferably carried out during the cooler part of the day (usually early morning) to avoid shriveling and wilting.

### 2.1.1.3 Postharvest Factors

#### 2.1.1.3.1 Humidity

Fresh fruits and vegetables contain sizable amounts of water, for example, watermelons may contain water more than 95% of its fresh weight. Since most of the water is free water, the produce will continue to lose water to the surrounding atmosphere. The loss in water manifests into symptoms of shriveling, wilting, and loss of crispness. The tissue may also become tough or mushy and unacceptable to the consumer. The reduction of saleable weight and loss of sensory characteristics lower the marketing value. Weight loss by even 5% makes certain produces unsaleable [86]. The surface area/volume ratio, nature of surface, presence/absence of cuticle, number of stomata (leaves) and lenticels (fruits), periderm (tubers and roots), and injury to the plant tissues affect both the rate and the extent of water loss. This is the reason why leafy vegetables such as lettuce lose water at higher rates than potatoes and apples.

Water loss can be prevented by maintaining high atmospheric relative humidity (RH), low temperature, reduced air movement, and increased pressure; avoiding product injury; and using suitable packaging during storage and transportation. Optimum RH is 85%–90% for most fruits and 90%–98% for most vegetables except dry onions and pumpkins (70%–75%). Some roots may require almost 100% RH [32,46]. Maintaining high RH, in certain situations, may induce decay, surface mold development, and physiological disorders, including impaired fruit ripening; however, surface condensation of moisture (sweating) over long periods is probably more of significance in enhancing decay than high humidity.

#### 2.1.1.3.2 Temperature

Temperature management is the most important tool in postharvest handling of plant produce to control both physiological and pathological deteriorations. Provided exposures to temperatures leading to chilling and freezing injuries are avoided, lowering temperature during handling, transportation, and storage is the most effective means of extending the shelf life and reducing the loss of quality by lowering the metabolic processes such as respiration and transpiration. Figure 2.2 shows the effect of temperature on shelf life of selected fruits and vegetables. The difference in the effect of temperature on the shelf life varies due to differences in physicochemical properties of different types of fruits and vegetables. For example, the most pronounced effect in increasing the shelf life by reducing the temperature is expected for lettuce and green onion than for strawberry and raspberry.

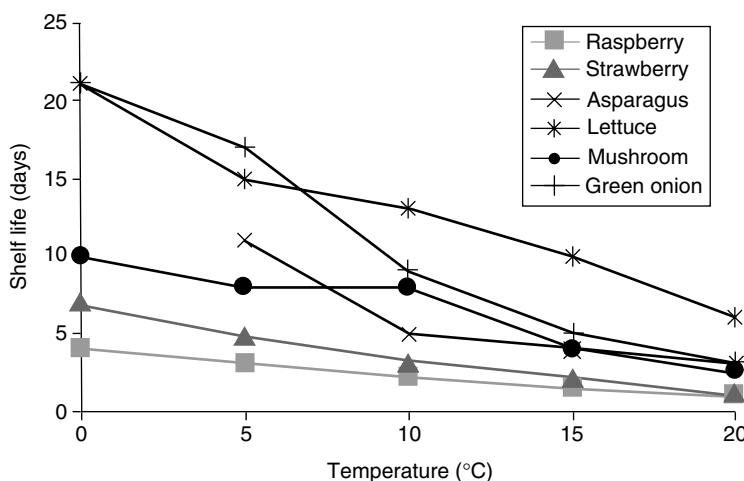
The effect of temperature on quality is expressed by a temperature quotient  $Q_{10}$ , which is defined as

$$Q_{10} = \left( \frac{q_2}{q_1} \right)^{\left( \frac{10}{T_2 - T_1} \right)} \quad (2.1)$$

where  $q_2$  and  $q_1$  are the rates of quality function at two temperatures,  $T_2$  and  $T_1$ , respectively. The  $Q_{10}$  values have been used to describe the effect of temperature on a particular quality attribute, such as color, texture, flavor, etc. For example,  $Q_{10}$  values for quality deterioration in asparagus when expressed as appearance, sugar loss, and fiber increase are 2.7, 5.8, and 10, respectively, in a temperature range of 0°C to 10°C [53,56].

#### 2.1.1.3.3 Atmospheric Gas Composition

Atmospheric gas composition, such as oxygen, carbon dioxide, and ethylene, influences the microbial decay and physiological processes such as respiration. Reduction of oxygen and elevation of carbon dioxide through modified or controlled atmosphere storage complements the effects of maintaining



**FIGURE 2.2** Effect of temperature on shelf life of selected fruits and vegetables. (Data taken from J. K. Brecht and P. E. Brecht, *Effect of Small Temperature Differences on Quality of Horticultural Commodities*, PEB Commodities Inc., 2002.)

low temperature through the postharvest value chain. For example, banana transported under 3% O<sub>2</sub> and 5% CO<sub>2</sub> reduces premature ripening and crown rot development by high carbon dioxide/oxygen ratio [15,41]. The beneficial or harmful effects of varying gas composition, however, depend upon commodity, cultivar, physiological age, oxygen and carbon dioxide levels used, temperature, and duration of storage [46,120]. The principles underlying the technology of manipulation of atmosphere and recommended level of gases for extending postharvest life of fruits and vegetables have been covered elsewhere [45,46,54,104,105] and in the chapter on modified atmosphere packaging (chapter 14).

#### 2.1.1.3.4 Light

Light may influence the quality of fruits and vegetables by controlling the synthesis/degradation of pigments responsible for color (chlorophyll and carotenoids), flavor by catalyzing oxidation of lipids, sprouting, reducing nutritive value by degrading vitamins such as ascorbic acid and riboflavin, and production of toxins. The exposure of potatoes to light during storage may produce green tissues that contain solanine, a toxin [86]. Thus, light intensity should be minimized. Adverse effects of light are prevented by storage in dark and using packaging materials that prevent the transmission of light.

#### 2.1.1.3.5 Mechanical Injury

Mechanical injuries expose internal tissue to contamination, increase respiration rate, promote chemical and enzymatic reactions (i.e., browning), allow the spread of decay microorganisms, and induce an overall quality decline. The resistance to cracking in tomatoes is correlated with flatness of the epidermal cells [32,74,84,86,120]. The surface cracks, cuts, punctures, which develop during growth or as a result of mechanical injuries, either remove or weaken the protective outer layers causing water loss. At early stages of maturity, some commodities have the ability to repair and seal off the damaged area. The capacity of wound healing diminishes in most cases as the plant organs mature except some tuber and root crops.

A bruise is a simple and irreversible injury, but defining all the ways in which bruising is caused can become quite complex. Impact bruising results when the dynamic failure stress or strain level for the produce tissue is exceeded above tolerance. The factors affecting impact are drop height, velocity just before impact, mass of each produce item, radius of curvature of the impacting surfaces at the point of contact, stiffness of tissue beneath each surface, area of contact for each surface, and failure stress or strain level for each tissue [5,102].

#### 2.1.1.3.6 Postharvest Diseases or Infections

The postharvest diseases are initiated by the following ways: (i) at the early stage of development when attached to the plant, (ii) by direct penetration of certain fungi or bacteria through the intact cuticle or



through wounds or natural openings in the surface, and (iii) through injuries in cut stems or damage to the surface. While most of the microorganisms can invade only the damaged produce, a few are able to penetrate the skin of healthy produce. Initially, only one or a few pathogens may invade and break down the tissues, followed by a broad-spectrum attack of several weak pathogens, resulting in complete loss of commodity due to the magnified damage. The postharvest diseases can be controlled based on (i) prevention of infection, (ii) eradication of incipient infections, and (iii) retardation of the progress of pathogen in the produce by fungicide or bactericides [85,86].

The pH of fruits is the major factor that influences the composition and therefore the microflora present. Yeasts and molds are often the predominant microorganisms in fruits and fruit products as they grow well under acidic conditions [100]. Only a few species of yeast pathogenic to man and other animals are common contaminants of fruits and fruit products [100]. Mold-infected raw fruit may become soft during or after processing because pectinases present in molds may not be inactivated by ordinary thermal treatment [72]. Moreover, over 100 different mycotoxins are produced by some 200 mold species [57]. For example, patulin is a common mycotoxin in processed fruits, particularly in apples [100].

In general, the bacteria that cause diseases in humans are not associated with fruit products due to poor tolerance to low pH of fruits. There are four groups of human pathogens that may also be present in fresh fruits and vegetables [35]. They are soil-inhabiting bacteria (*Clostridium botulinum*, *Listeria monocytogenes*), enteric bacteria (*Salmonella* spp., *Shigella* spp., *Escherichia coli* O157:H7, etc.), parasites (*Cyrtosporidium*, *Cyclospora*), and viruses (hepatitis, Norwalk virus, etc.). Following good agricultural and good manufacturing practices, such as GMP and Hazard Analysis and Critical Control Point (HACCP), can prevent the outbreaks associated with human pathogens.

## 2.2 Postharvest Physiological Processes

### 2.2.1 Ontogeny

The origin and development (ontogeny) of plants influences various physiological aspects of fruits and vegetables. From initiation or conception to death, plants or parts thereof undergo different stages of development having significant differences in their metabolism impacting on quality. Fruits and vegetables pass through five distinct developmental phases from initiation to (i) development (morphological and chemical completion of tissue), (ii) young or premature (developmental period before the onset of maturation), (iii) mature (completion or fullness of growth and edible quality, most of the maturation processes must be completed while the produce is still attached to the plant), (iv) ripe (maximum esthetic and edible quality), and (v) senescence (leading to death and set the produce worthless and inedible). The duration and the rate of these stages vary with type and variety of the product and stage of development [75,85,86].

Table 2.4 provides examples of plant parts used as fresh or in processed forms. The morphology and the stage of development at which these are harvested vary substantially. When harvested, sprouts and seedlings are in very early stages of development, followed by stems and leaves, partially developed fruits (cucumber), fully developed fruits (apples), roots and tubers, and seeds (dry beans, peas). Tissues that are in early stage of development have relatively short shelf life as compared to those that are primed for dormancy (e.g., potatoes).

The unwanted sprouting in vegetables, such as onions, ginger, garlic, and potato, is related to dormancy and rest. Dormancy is a condition of quiescence due to some internal or external factors, and rest is a phenomenon in which sprouting does not occur in spite of a favorable environment (e.g., potatoes have no period of rest) [74,86]. Rooting in roots

**TABLE 2.4**

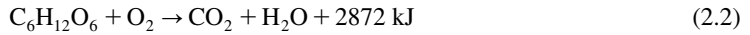
Types of Plant Parts Consumed in Fresh or Processed Form

Plant Parts	Examples
Seeds and pods	Peas, chickpea, corn, baby corn, beans, okra
Bulbs, roots, tubers, and corms	Potato, beet, carrot, onions, garlic, lotus root, cassava
Flowers	Cauliflower, broccoli, banana flower
Fruits	Tomato, pears, peach, pineapple, olive, eggplant, mango, lychee
Buds	Bamboo shoot
Stems	Asparagus
Leaves	Lettuce, spinach
Seedlings	Bean, alfalfa, onion, radish sprouts

and tubers is initiated by high humidity in the environment and may result in a rapid decay, shriveling, and depletion of food reserves [74,86]. Seed germination of mature fruits during storage, such as chayote, tomatoes, and papaya, and pod-bearing vegetables is also a serious problem. Green beans and sweet corn may toughen due to the development of spongy tissues when the storage is unduly prolonged [86]. Elongation of existing structure as in asparagus, carrot, beet, and kohlrabi, and bending of tissues in response to gravity and light reduce the market life.

### 2.2.2 Respiration

All living organisms convert matter into energy through a fundamental process of life called respiration, which primarily constitutes enzymatic oxidation of substrates such as carbohydrates, proteins, lipids, organic acids, etc. in the presence of atmospheric oxygen to carbon dioxide and water, and accompanied by a release of energy as follows:



The reaction brings about changes in the chemical composition as carbohydrates, proteins, lipids, and organic acids are used as substrates. The respiratory quotient (RQ), which is defined as the ratio of  $\text{CO}_2$  produced to  $\text{O}_2$  consumed, can indicate the type of substrate being oxidized during respiration. The RQ values for carbohydrates, organic acids, and lipids are 1,  $>1$ , and  $<1$ , respectively. Prevalence of anaerobic respiration corresponds to high RQ values. The respiration reaction is exothermic as a significant part (about 57%) of the energy produced is dissipated as heat, called as vital heat or heat of respiration, which contributes to an increase in the temperature of the commodity further. There are three distinct phases of respiratory pathway: (i) breaking down of polysaccharides into simple sugars by hydrolysis, (ii) oxidation of sugars to pyruvic acid by glycolysis, and (iii) aerobic transformation of pyruvate and other organic acids into carbon dioxide, water, and energy by citric acid cycle and mitochondrial electron transport chain. Respiratory pathways have been described in several publications [38,39,120]. It has been proved that the production of ATP by normal respiratory pathway in postharvest fruits and vegetables is less efficient, and up to 90% of the potential energy of glucose may be dissipated as heat. An alternate mitochondrial electron transport chain may be responsible for thermogenic or cyanide-insensitive respiration, leading to a rapid loss of storage polysaccharides, electron transport without the loss of reducing power, and generation of heat [39]. Alternate electron transport chain has been found responsible for increasing the internal temperature of ripening mangoes by  $10^\circ\text{C}$  [58].

Respiration is an indicator of metabolic activity of all living produce and plays a significant role in the postharvest physiology and deterioration of quality of plant foods. The rate of deterioration is generally proportional to their respiration rate, which is often a good index to the storage potential of a crop. Higher the respiration rate, shorter the shelf life and vice versa. Respiration rate can be used as a criterion to compare perishability of fruits and vegetables. Kader and Barrett [49] classified fruits and vegetables into five groups based on their respiration rate as shown in Table 2.5, which also illustrates the relationship between the relative perishability to their respiration rates. Commodities such as mushrooms, which respire at a rate three times that of the dried fruits, are more perishable and have shorter shelf life than nuts and dried fruits. The effect of respiration on perishability can be explained by (i) coupling of the resultant reducing power and formation of ATP due to respiration with biosynthetic reactions leading to loss of quality, (ii) loss of food reserves, (iii) toxic effects of accumulation of carbon dioxide, and (iv) increase in product temperature due to respiratory heat, which also has implications in dictating the cooling load during storage [38,39]. The respiration increases significantly as the storage temperature increases (Table 2.5).

Useful data on experimental respiration rates for different fruits and vegetables are given in Refs. [6,37,40,73]. Experimental data on the production of  $\text{CO}_2$  are correlated to temperature by relationships such as

$$\dot{m}_{\text{CO}_2} = f \left[ \frac{9T_m}{5} + 32 \right]^g \quad (2.3)$$

where  $\dot{m}_{\text{CO}_2}$  is the rate of carbon dioxide production per unit mass of the product,  $T_m$  the mass average temperature of the product ( $^\circ\text{C}$ ), and  $f$  and  $g$  are the respiration coefficients for a given product.

**TABLE 2.5**

Classification of Fruits and Vegetables Based on Respiration Rate

Class	Respiration Rate (mg carbon dioxide/kg h)		Examples
	10°C	20°C	
I. Very low	<10	<40	Nuts, dates, dried fruits
II. Low	10	40	Potatoes, onions, cucumbers, apple, pear, kiwi fruit, pomegranate, Chinese date
III. Moderate	10–20	40–80	Peppers, carrots, tomatoes, eggplant, citrus fruits, banana
IV. High	20–40	80–120	Peas, radish, apricot, fig, ripe avocado, cherimoya, papaya
V. Very high	>40	>120	Mushrooms, green onions, cauliflower, dill, parsley, melons, okra, strawberry, blackberry, raspberry

Source: Data from I. Burzo. *Acta Hortic.* 116:61, 1980; A. A. Kader and D. M. Barrett. In *Processing Fruits: Science and Technology, Vol. 1, Biology, Principles, and Applications*. (L. P. Somogyi, H. S. Ramaswamy, and Y. H. Hui, Eds), Technomic Publishing Co., Pennsylvania, 2003, p. 1.

The coefficients obtained by least square fit of the experimental data are given in Table 2.6 [11]. Similarly, the relationship between the heat of respiration and temperature can be derived from the reaction stoichiometry involving glucose oxidation. Within the physiological range of temperature (0°C–30°C), the rate of respiration increases exponentially (Figure 2.3), and a large amount of heat is produced as heat of respiration (Figure 2.4).

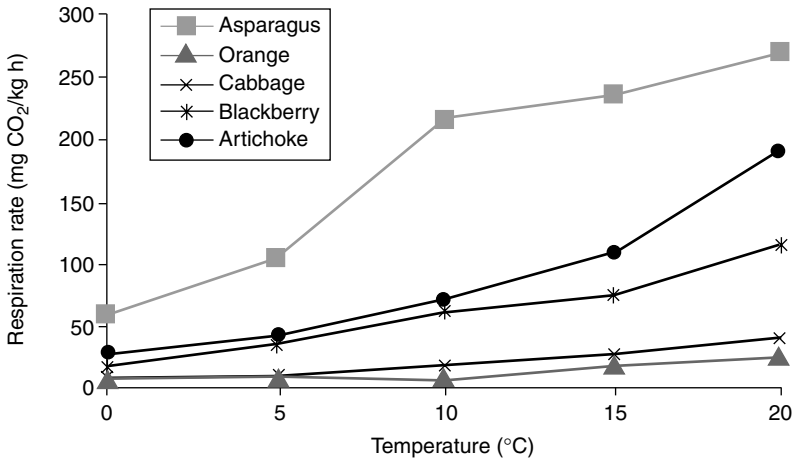
The respiration rate depends on a host of internal and external factors. The internal factors include (i) the quantity of substrate (predominantly sugars); (ii) size, shape, cell morphology, and maturity; (iii) structure of peel; (iv) volume of intercellular spaces; and (v) chemical composition of tissue that affects solubility of oxygen and carbon dioxide. The external factors are (i) temperature; (ii) availability of ethylene, oxygen, and carbon dioxide; (iii) light; (iv) water stress; (v) biological activity, and (vi) growth regulators. Out of these external factors, temperature, atmospheric composition, and physical stress have the most profound effect on respiratory activity, and postharvest management of respiration involves controlling these factors to reduce the deterioration of quality.

As the produce approaches maturity, the rate of respiration declines and those commodities that are harvested while in the period of active growth (e.g., most vegetables and immature fruits) have high respiration rates. However, fruits show two distinctive respiratory patterns during ripening and are grouped into (i) nonclimacteric and (ii) climacteric. Climacteric fruits show a dramatic increase in the rate of respiration during ripening. The climacteric peak can be prolonged or delayed by reducing the rate of respiration to increase the shelf life. Climacteric fruits can be harvested mature and ripened off the plant. These produce much larger quantities of ethylene in association with their ripening, and exposure to ethylene treatment will result in faster and more uniform ripening [49]. The respiration rate is minimum at maturity and remains rather constant, even after the harvest. The rate will rise up abruptly to the climacteric peak only when ripening is about to take place, and then it will slowly

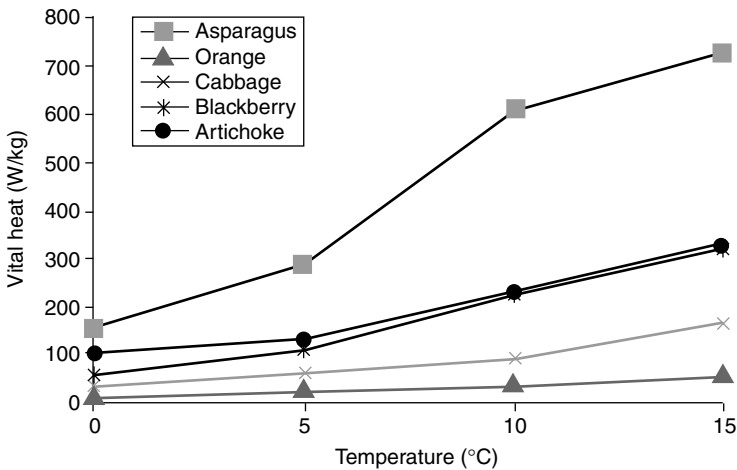
**TABLE 2.6**Respiration Coefficients (*f* and *g*) for Equation 2.3 for Selected Fruits and Vegetables

Fruits or Vegetables	<i>f</i>	<i>g</i>
Apples	$5.687 \times 10^{-4}$	2.598
Blueberries	0.002724	2.573
Cabbage	$6.080 \times 10^{-4}$	2.618
Carrots	0.05002	1.793
Grapes	$7.056 \times 10^{-5}$	3.033
Limes	$2.983 \times 10^{-8}$	4.733
Onion	$3.668 \times 10^{-4}$	2.538
Oranges	$2.805 \times 10^{-4}$	2.684
Peaches	$6.361 \times 10^{-5}$	3.204
Pears	$6.361 \times 10^{-5}$	3.204
Potatoes	0.01709	1.769
Strawberries	$3.668 \times 10^{-4}$	3.033
Tomatoes	$2.007 \times 10^{-4}$	2.835

Source: Adapted from B. R. Becker and B. A. Fricke. In *New Developments in Refrigeration for Food Safety and Quality*. Int. Inst. Ref., Paris, France and ASAE, St Joseph, Michigan, 1996, p. 160.



**FIGURE 2.3** Effect of temperature on the respiration rates of some fruits and vegetables. (Data taken from K. C. Gross et al. *The Commercial Storage of Fruits, Vegetables, and Florist and Nursery Stocks—A Draft Version of the Revision to USDA Agricultural Handbook Number 66* (2002) (revised in 2004) ([www.ba.ars.usda.gov/hb66/index.html](http://www.ba.ars.usda.gov/hb66/index.html)).



**FIGURE 2.4** Effect of temperature on the evolution of vital heat by some fruits and vegetables. (Data taken from *ASHRAE Handbook of Refrigeration Systems and Applications*, American Society of Heating, Refrigeration and Air-conditioning Engineers, Atlanta, GA, 1998.)

decline [78]. The nonclimacteric fruits ripen on the tree and are not capable of continuing their ripening process once removed from the plant. These produce very small quantities of ethylene and do not respond to ethylene treatment for ripening, except in terms of degreening (degradation of chlorophyll) in citrus fruits and pineapples [49]. Examples of nonclimacteric and climacteric fruits and vegetables are given in Table 2.7.

Respiration rate depends on temperature and the temperature dependence varies among and within commodities. The relationship between temperature and respiration rate can be expressed in the form of  $Q_{10}$  values, which allow estimation of the rate of respiration at an unknown temperature provided the rate of respiration at a known temperature is available. The temperature quotient  $Q_{10}$  for respiration may be defined by replacing  $q_2$  and  $q_1$  by  $R_2$  and  $R_1$ , respectively, in Equation (2.1).  $R_2$  and  $R_1$  are the rates of respiration at two temperatures,  $T_2$  and  $T_1$ , respectively.  $Q_{10}$  values for respiration rates are not constant and vary between 2 and 2.5 for a temperature range of 5°C–25°C [53,89]. As the temperature increases  $Q_{10}$  values decrease. As the thermal death point of the tissue approaches,  $Q_{10}$  tends to reduce to  $<1$  [53,89]. At temperatures  $>25^\circ\text{C}$ ,  $Q_{10}$  decreases to  $<2$  due to reduced diffusion of  $\text{O}_2$  from atmosphere to the cell and denaturation of enzymes [70]. Chilling and heat stress can also influence the respiration of commodities [89].

TABLE 2.7

Examples of Nonclimacteric and Climacteric Fruits and Vegetables

Nonclimacteric	Climacteric
Berries (cherry, strawberry, blueberry, cranberry, raspberry), citrus fruits (orange, grapefruit, lemon, lime, mandarin), pineapple, lychee, tamarillo, loquat, cucumber, fig, melon, and pomegranate	Apple, pear, quince, persimmon, apricots, nectarine, peach, plum, kiwi, avocado, banana, plantain, mango, papaya, cherimoya, sapodilla, guava, passion fruit, pawpaw, tomatoes

Source: A. A. Kader and D. M. Barrett. In *Processing Fruits: Science and Technology, Vol. 1, Biology, Principles, and Applications* (L. P. Somogyi, H. S. Ramaswamy, and Y. H. Hui, Eds), Technomic Publishing Co., Pennsylvania, 2003, p. 1; D. K. Salunkhe et al. *Storage, Processing, and Nutritional Quality of Fruits and Vegetables, Vol. 1: Fresh Fruits and Vegetables*, CRC Press, Boca Raton, FL, 1991.

Reduction in the O<sub>2</sub> concentration and increasing concentration of CO<sub>2</sub> in the atmosphere surrounding fresh fruits and vegetables reduce the rate of respiration. The extent of the effect depends on factors such as temperature, produce, cultivar, age, and level of maturity at the harvest. A 3%–5% reduction of oxygen concentration does not have an adverse effect on produce, but a comparable increase in carbon dioxide may suffocate and ruin certain fruits and vegetables. There is a considerable variation in the injury threshold of various fruits and vegetables to O<sub>2</sub>. Reduction of O<sub>2</sub> concentration below 2%–3% gives beneficial reduction in rates of respiration and other metabolic processes for most produce. However, complete removal of O<sub>2</sub> is not recommended as anaerobic environment is detrimental to the quality of the produce as it leads to fermentation, decay and development of off flavor, and change in color and texture.

The stage of development of produce also influences the rate of respiration. Actively growing vegetables, such as asparagus (floral meristem), have a very high respiratory rate than the storage organs such as potatoes and mature fruits (see Figure 2.3). This is the reason why potatoes can be stored for a longer period than asparagus. The rate of respiration declines with maturity; immature fruits respire at a higher rate than those that have attained full maturity.

Physical stress during cultivation, harvesting, and postharvest handling influences respiratory behavior significantly. Tissue injury increases the rate of respiration and induces ethylene production, which may further catalyze an increase in respiration with consequent loss of quality. While assessing relationship among respiration, bruising susceptibility, and temperature in sweet cherries, Crisosto et al. [24] found that the impact-bruising damage was greatest in the tested cultivars when fruit flesh was below 10°C. Approximately threefold increase in the rate of respiration has also been shown as a result of impact bruising when fruits were kept at 20°C for 2 days [65].

### 2.2.3 Transpiration and Water Stress

Transpiration is mainly responsible for water loss, which leads to a loss of: salable weight; appearance (wilting and shriveling); textural quality (softening, flaccidity, limpness, crispness, and juiciness); and nutritional quality [49]. In most fruits and vegetables, 5%–10% loss in moisture content produces visible symptoms of shrivelling and wilting due to cellular plasmolysis [86], and the signs become objectionable when weight loss reaches about 5% of the harvested weight [74,86].

Transpiration is a process of mass transfer in which the water vapors move from the surface of the produce to the surrounding atmosphere. The rate is directly proportional to the partial pressure gradient across the transfer surface and surface area and inversely proportional to the sum of the resistances such as the type of the surface and presence of waxes on the surface. The simplest mathematic model of transpiration process used in the literature is of the following type [91]:

$$\dot{M} = k_t(p_s - p_a) \quad (2.4)$$

where  $\dot{M}$  is the transpiration rate,  $k_t$  the transpiration coefficient, and  $p_a$  and  $p_s$  are the ambient and evaporating surface vapor pressures, respectively. Transpiration coefficient represents the reciprocal of resistances to moisture transfer. The experimental data on transpiration coefficients have been compiled by Sastry et al. [91] and are given in Table 2.8. Transpiration coefficient may be used to compare the difference in the water loss behavior of different fruits or vegetables [13]; however, Sastry et al. [91] have discussed the limitations

**TABLE 2.8**

Transpiration Coefficients of Selected Fruits and Vegetables

Product	Mean Transpiration Coefficient (mg/kg s mPa)	Range of Transpiration Coefficient (mg/kg s mPa) Reported in the Literature
Apples	42	16–100
Brussels sprouts	6150	3250–9770
Cabbage	223	40–667
Carrots	1207	106–3250
Celery	1760	104–3313
Grapefruit	81	29–167
Grapes	123	21–254
Leeks	790	530–1042
Lemons	186	139–229
Lettuce	7400	680–8750
Onions	60	13–123
Orange	117	25–227
Parsnips	1930	1097–2771
Peaches	572	142–2089
Pears	69	10–144
Plums	136	110–221
Potatoes	25	15–40
Tomatoes	140	71–365

Source: S.K. Sastry et al., *ASHRAE Trans.*, 84(1):237, 1978.

of such coefficients in describing the true transpiration process. Further improvements of the transpiration model were suggested by Sastry and Buffington [92] and Becker and Fricke [11]. It may be possible to group fruits and vegetables into three broad ranges of transpiration rates under refrigerated storage conditions: high (500–850 mg/kg h mmHg; carrots and parsnips); intermediate (100–250; cabbage and rutabaga); and low (10–80; potatoes and onions) [109]. The rate of transpiration depends on both product and environmental factors. These factors include [91,92] (i) skin structure; (ii) size, shape, and surface area; (iii) water vapor pressure difference; (iv) air movement; (v) heat of respiration; (vi) the level of maturity; (vii) endothermic effects of evaporation; and (viii) amount of solutes present in the produce.

The outer protective coverings (dermal system) govern the regulation of water loss. The main sites of transpiration in plants are the hydathodes, stomata, epidermal cells, lenticels, trichomes (hairs), and cuticle. The number of stomata in the epidermis, type of surface, tissues under the skin, and structure and thickness of wax coating on the surface (cuticle) determine the loss of water. The cuticle is composed of surface wax, cutin embedded in wax, and carbohydrate polymers. The type of product and the stage of physiological development influence the thickness, structure, and chemical composition of the cuticle.

The stem scars and lenticels provide important routes for water loss in tomatoes and potatoes, respectively. A hydrophobic waxy coating consisting of a complex and well-ordered structure of overlapping platelets provides greater protection against water loss than a thick structure with less coating. The epidermal cells underneath the waxy layer are also structured compactly with minimal space between adjacent cells. In case of leafy vegetables, small openings located at intervals in the epidermis called stomata allow water loss and gas exchange. Transpiration is faster in plants with greater number of hairs and very fine hairs may not modify the transpiring potential of a plant surface.

The higher the ratio of surface area to volume, the greater the loss of water by evaporation. Thus, at the same conditions the expected rate of transpiration will be in the order: leaf (spinach) > fruit (tomato) > a root or a tuber (potato). Immature fruits tend to encounter higher transpiration rates than mature fruits due to permeability of the skin to water vapors. Since the solute depresses the water activity of solutions, higher solute concentration in the tissue binds water and reduces water loss.

The temperature, RH, and air movement are the three most significant environmental factors that affect water loss by transpiration. In general, high surface temperature and low RH increase the rate of transpiration. As indicated by Equation 2.4, the vapor pressure difference, the driving force for water

movement, has a direct relationship with the transpiration rate and therefore the difference can be used to determine the transpiration rate. Sastry and Buffington [92] reported the following regression equation (Equation 2.5) for the best fit ( $R^2 = 0.99$ ) curve between the transpiration rate and apparent vapor pressure difference for tomatoes:

$$\dot{m} = 0.038557 (p_{sa} - p_{\infty})^{0.9536} \quad (2.5)$$

where  $\dot{m}$  is the rate of transpiration ( $\text{mg}/\text{cm}^2 \text{ s}$ ),  $p_{sa}$  the apparent water vapor pressure at the evaporating surface, and  $p_{\infty}$  the atmospheric vapor pressure in mmHg. The relationship for tomatoes has been almost linear. While atmospheric vapor pressure is dependent on both temperature and air RH, the apparent vapor pressure depends mainly on temperature due to saturation conditions prevailing in the tissue. Thus, one practical way to minimize transpiration is to cool the produce quickly under high humidity conditions (hydrocooling). Respiratory activity produces heat that contributes to higher evaporation of water even under prevailing saturation conditions by increasing the vapor pressure deficit. It is expected that fruits and vegetables that have higher respiratory activity will also have higher water loss. The effect of maturation and ripening on transpiration varies significantly among fruits. Fruits such as mango and banana show increased transpiration after reaching climacteric period [13]. The dissolved solutes, particularly simple sugars at higher concentrations, reduce the vapor pressure of water in the solution more and hence reduce the rate of transpiration. Air circulation or velocity increases the moisture evaporation from the surface, particularly in situations where temperature fluctuations persist. Attempts have been made to include the effect of air circulation on the transpiration processes [11].

For a given produce, the rate of water loss is primarily determined by the difference in the vapor pressure between the air in tissue and the surrounding atmosphere. This difference may be given as vapor pressure deficit (VPD), which is influenced by psychrometric properties of the air (temperature and humidity) and the produce (temperature and equilibrium humidity). For a given product, higher the deficit, higher will be the water loss. Psychrometric chart can be used to evaluate the effect of changing air conditions on the VPD and hence the water loss during storage, precooling, and other handling operations related to water vapor transport.

Water loss can be minimized by maintaining higher pressure than atmosphere, maintaining low temperature and humidity during storage, choice of suitable packaging material, and loading density and depth [60], application of waxes and other water-resistant coatings to the surface or by appropriate packaging with plastic films [9,13,74,86,120].

#### 2.2.4 Ripening and Senescence

Ripening refers to a stage in tissue development when a fruit reaches an optimal eating quality as evidenced by favorable change in composition, color, texture, and other sensory attributes [115]. Many fruits (climacteric) require ripening to be carried out by the processor as fruits have been shipped to processors in immature stage to avoid tissue injury during transportation and handling. Ripening in fruits follows the physiological maturity and precedes senescence, which leads to the death of the tissue. Senescence is genetically programmed and can be induced by common stressors, such as tissue injury, deficiency of nutrients and water during production, exposure to insects, pests and diseases, and adverse environmental conditions. Senescence may manifest into ripening of fruits, abscission and yellowing of leaves, and softening of tissues. An understanding of the biochemistry of senescence, therefore, provides clues to delay the loss of postharvest quality of fruits and vegetables. King and O'Donoghue [55] identified three main areas of research conducted to unravel senescence, role of ethylene, structural changes in the cell wall, and metabolic changes when immature after harvest.

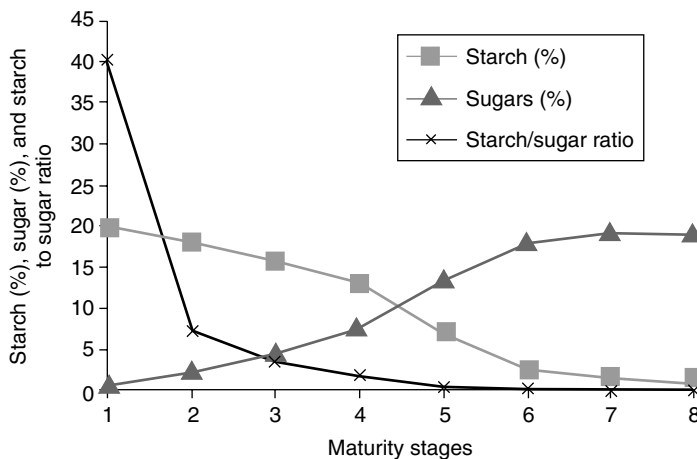
Ripening induces changes that are structural, physical, chemical, nutritional, biochemical, or enzymatic. These changes are (i) degradative, such as chlorophyll breakdown, starch hydrolysis, and cell wall degradation; and (ii) synthetic, such as formation of carotenoids and anthocyanins, aroma volatiles, and ethylene formation [16].

The changes occurring during ripening are (i) thickening of cell wall and adhesion, (ii) increased permeability of plasmalemma, (iii) increased intercellular spaces contributing to softening, (iv) changes in plastids, (v) transformation of chloroplasts into chromoplasts, (vi) changes in color, (vii) loss of

texture, (viii) formation of a visible and distinctive structure from epicuticular wax, (ix) thickening of cuticle, (x) loss of epidermal hairs, and (xi) lignification of endocarp [10,74,86].

The details of compositional and morphological changes during ripening and senescence are given in Refs. [7,49,68,85]. Carbohydrates, organic acids, amino acids and proteins, lipids, pigments, pectic substances, and volatile components are mostly affected and directly contribute to the pleasant color, aroma and flavor, texture, and appearance of fruits. Unripe fruits contain little sugar such as sucrose, glucose, and fructose. The flesh cells enlarge and sugar content increases at the expense of starch, acid, and phenolic compounds as the fruits approach ripening. In addition, certain volatile compounds develop, giving the fruit its characteristic aroma and flavor [8]. Chlorophyll degradation (loss of green color) and synthesis of carotenoids (yellow and orange colors) and anthocyanins (red and blue colors) take place both in the skin and in the flesh. All fruits soften as they ripen due to changes in cell wall composition and structure. The pulp weight increases with gradual decrease in peel weight upon ripening. Figure 2.5 shows changes in starch, sugars concentrations, and a ratio of starch and sugar as a function of stages of maturity in banana. At the onset of maturity there was little sugar in the fruit, and as maturity increased sweetness of the fruit progressively increased due to hydrolysis of starch into sugars, particularly after stage 2, and starch practically disappears at stage 6.

Each type of fruit has its unique assemblage of volatile compounds, and an increase in volatiles contributes to the flavor, taste, and aroma of the fruits. The main volatile compounds are acids, alcohols, esters, carbonyls, aldehydes, ketones, and hydrocarbons [49,71,77]. These volatiles are present in extremely small quantities ( $<100 \mu\text{g/g}$  fresh weight), and the total amount of carbon involved in their synthesis is less than 1% of that expelled as carbon dioxide [49]. Although ethylene does not have strong aroma and does not contribute to typical fruit aroma, it does influence the formation of volatiles in climacteric fruits. In both climacteric and nonclimacteric fruits, the most important aroma volatiles that increase during ripening are the esters. The characteristic or optimum flavor develops at a specific stage of ripening process. Feijoa is a very aromatic fruit with the best aroma and flavor after natural abscission, but loses the flavor during storage [95]. In the case of tomatoes, while the color changes from green to red stage during ripening, the volatile concentration reaches a peak from pink to red stages of maturity. In mango, the characteristic flavor appears to develop only after half-ripe stage (climacteric stage), and the extent of flavor generation depends on the temperature conditions during storage [34]. There is also a dramatic increase in aroma volatiles in nonclimacteric fruits. Esters, acetals, alcohols, and aldehydes are formed in strawberry. In pineapple, there is a dramatic increase in ester production during ripening [36], while in citrus there are no changes in volatile production during storage. In grapefruit and pomelo, the changes in volatiles are very minor during storage, except for the important increase in nootkatone, which contributes significantly to pleasant grapefruit flavor [79,93].



**FIGURE 2.5** Relationship between the stages of maturity of banana and starch, sugar and starch/sugar ratio. (Data taken from R. H. H. Wills et al. *Postharvest: An Introduction to the Physiology and Handling of Fruit Vegetables and Ornamentals*, New South Wales University Press, Sydney, 1998.)



**TABLE 2.9**

Cell Wall Changes Responsible for Loss of Texture During Ripening

Cell Wall Change	Absent	Low	Moderate	High
Loss of arabinan	Watermelon	Pepper	Avocado	Pear
	Apricot	Tomato	Peach	Blueberry
	Plum		Kiwifruit	
Loss of galactan	Cucumber	Apricot	Peach	Muskmelon
	Plum	Blueberry	Apple	Pepper
			Melon	Tomato
Solubilization of pectin	Watermelon	Apple	Plum	Avocado
	Apple	Strawberry	Kiwifruit	
			Tomato	Blackberry
			Banana	
Depolymerization of pectin	Banana	Melon	Peach	Avocado
	Strawberry	Papaya	Tomato	
	Apple	Watermelon		
	Pepper			

Source: Adapted from D. A. Brummell. *Func. Plant Biol.*, 33:103, 2006.

Nonethylene, nonrespiratory organic volatiles, such as terpenes, carboxylic acids, alcohols, aldehydes, sulfur compounds, ammonia, and jasmonates, have physiological and quality impact on fresh produce, particularly as antimicrobial or insecticidal agents [107]. Stress and injury, disease, cultivar, and atmospheric composition strongly influence their accumulation.

Fruits become softer upon ripening due to a series of changes at the cellular level. The composition, water content or turgor pressure, and cell wall constituents undergo transformation upon maturity [1–3,90]. The primary cell wall consists of a network of several polysaccharides, proteins, and phenolic substances. The cellular structure weakens as a result of modification to the polysaccharides such as cellulose, hemicellulose, and pectins present in the cell wall and middle lamella by the action of several enzymes such as polygalacturonase and glycosidases. Polyuronide depolymerization, loss of galactan and arabinan, pectin demethylesterification and solubilization, depolymerization of matrix glycan, and cellulose depolymerization are responsible for degradative changes in the cell wall [20]. Considerable variations exist among different fruits as shown in Table 2.9, which lists the extent of changes in arabinan, galactan, pectin solubilization; and depolymerization in the cell wall during ripening for some fruits [20]. These changes have an impact on gel-formation ability (required for fruit preserves), juice yield and cloudiness of fruit juices, and tissue collapse during thermal processing. Research into transgenic lines has underlined the influence of genetics in determination of texture of fruits; however, the role of environmental and cultural factors has also been found to be significant [90].

### 2.2.5 Phytohormone Effects

Phytohormones play an important role in plant metabolism by controlling the growth and development processes of plant organs used as food or raw material for processing. Physiological processes influenced by hormones are ripening, rest, dormancy, rooting, sprouting, abscission, and floral induction [38,39,62,76]. Besides ethylene, the key hormones responsible for these processes are auxins, gibberellin, cytokinins, and abscisic acid (Table 2.10). Ethylene has been studied most by postharvest physiologists. Ethylene is a natural product of plant metabolism and is produced by all tissues of higher plants and by some microorganisms [49] and is also present in the atmosphere as a pollutant. Ethylene regulates many aspects of growth and development even at concentrations <0.1 ppm. The production of ethylene by fruits and vegetables varies substantially from <0.1 to >100 mL/kg h (Table 2.11). Climacteric fruits, generally, produce a higher amount of ethylene than nonclimacteric fruits.

Ethylene is synthesized in plants from methionine, an amino acid, by a series of reactions by a highly regulated pathway (Figure 2.6). Key steps in this pathway are (i) conversion of methionine into

**TABLE 2.10**

Physiological Changes Induced by Phytohormones Other Than Ethylene

Physiological Changes	Phytohormone	Produce Affected
Sprouting	Abscisic acid, gibberellin, cytokinins, auxins	Onion
Senescence	Increased levels of gibberellin and low levels of auxins and cytokinins	Brussels sprouts, lettuce
Elongation of flower peduncle	Gibberellins	Cauliflower
Rooting	High levels of cytokinins and low levels of gibberellins	Carrot
Pithiness of petiole	Abscisic acid	Celery
Ripening	Abscisic acid stimulates, auxins, gibberellins and cytokinins delay ripening	Tomato

Source: Adapted from N. E. Haard. In *Food Storage and Stability* (I. A. Taub and R. P. Singh, Eds), CRC Press, Boca Raton, FL, 1998, p. 39; D. K. Salunkhe et al. *Storage, Processing, and Nutritional Quality of Fruits and Vegetables, Vol. 1: Fresh Fruits and Vegetables*, CRC Press, Boca Raton, FL, 1991.

**TABLE 2.11**

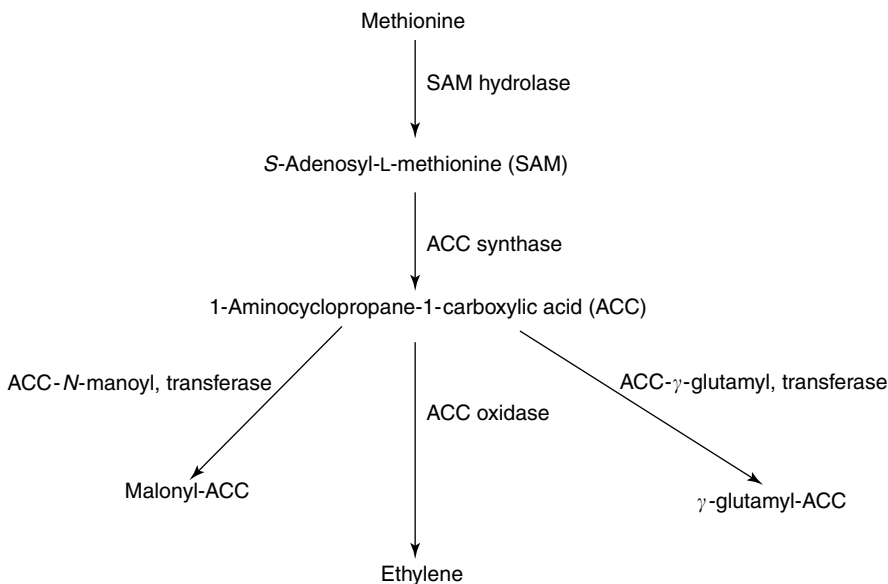
Classification of Fruits and Vegetables according to Ethylene Production Rates at 20°C

Class	Rate ( $\mu\text{L}/\text{kg h}$ )	Examples
I. Very low	<0.1	Artichoke, asparagus, cauliflower, cherry, strawberry, pomegranate, leafy vegetable, potatoes
II. Low	0.1–1.0	Blueberry, cranberry, cucumber, eggplant, okra, olive, pepper, persimmon, pineapple, pumpkin, raspberry, tamarillo, watermelon
III. Moderate	1.0–10.0	Banana, fig, guava, melon, honeydew, mango, plantain, tomatoes
IV. High	10.0–100.0	Apple, apricot, avocado, cantaloupe, feijoa, kiwi, nectarine, papaya, peach, pear, plum
V. Very high	>100.0	Cherimoya, passionfruit, sapota

Source: Adapted from A. A. Kader et al. *Postharvest Technology of Horticultural Crops*, University of California, Davis, 1985.

S-adenosyl-L-methionine (SAM) by SAM hydrolase, (ii) SAM into 1-aminocyclopropane-1-carboxylic acid (ACC) by ACC synthase, and (iii) ACC into ethylene by ACC oxidase [62,76,88]. Oxygen is required for ethylene biosynthesis while both  $\text{O}_2$  and  $\text{CO}_2$  are needed for its bioactivity [88]. ACC can also be converted into two conjugates, malonyl-ACC and  $\gamma$ -glutamyl-ACC by ACC-N-malonyltransferase and ACC- $\gamma$ -glutamyltransferase enzymes, respectively. Synthesis of these conjugates reduces availability of ACC for conversion into ethylene. ACC synthase is the key enzyme in the pathway leading to the production of ethylene in plants. Only one of the many genes controlling this enzyme may be responsible for the ripening action of ethylene. It may, therefore, be possible to control ethylene biosynthesis without influencing the other physiological processes. Genetic manipulation of these three key enzymes could be the key to controlling generation of ethylene [33,39,55,76,118].

Ethylene stimulates ripening of climacteric and some nonclimacteric fruits, synthesis of anthocyanins, degradation of chlorophyll (degreening), germination of seeds, formation of adventitious roots, abscission and senescence, flower initiation, and respiratory and phenyl propanoid metabolism [88]. It is also known to accelerate its own synthesis in ripening climacteric fruits. Ethylene is commercially used as a “ripening hormone” for climacteric fruits such as banana and mango and as a “degreening hormone” for citrus fruits. The beneficial and adverse effects of ethylene depend on several factors such as type of produce, cultivar, maturity at the time of harvest, temperature, and activity of other hormones [39]. Table 2.12 lists the adverse effects of ethylene on selected fruits and vegetables. Controlling the



**FIGURE 2.6** Biosynthetic pathway of ethylene production. (Adapted from J. Pech et al. In *Postharvest Physiology and Pathology of Vegetables*), (J. A. Bartz and J. K. Brecht, Eds), Marcel Dekker, New York, 2003, p. 247; G. A. King and E. M. O'Donoghue, *Trends Food Sci. Technol.*, 6:385, 1995.)

action of ethylene is of great commercial significance in fruits and vegetables as the adverse effects can lead to serious economic losses. Ethylene production rates by fresh fruits can be reduced by storage at low temperature, by reduced oxygen (less than 8%, and elevated carbon dioxide above 1%); by avoiding stressors such as fruit injury, diseases incidence, and water stress; and cooling to reduce rate of respiration [49,78,86]. Saltveit [88] describes three main ways to control the action of ethylene by preventing tissue exposure, its perception, and its response to ethylene. Tissue exposure can be avoided by excluding ethylene from the surrounding environment by scrubbing, inhibiting synthesis, and proper ventilation. Methods that work by blocking the perception of ethylene are the use of  $\text{CO}_2$ , silver, and 1-methyl cyclopropene (1-MCP); reduction in temperature; and using ethylene-insensitive cultivars. MCP is actively researched [14,116] and has been approved for use in some fruits in the United States [52]. Ethylene response by plant can be reduced by reduction in temperature, controlled or modified atmosphere storage, using genetic engineering techniques or chemicals to inhibit enzymes, and to change the protein synthesis.

**TABLE 2.12**

Adverse Effects of Ethylene in Fruits and Vegetables

Produce	Symptoms
Asparagus	Woodiness
Carrots	Bitterness due to isocoumarin formation
Potatoes	Sprouting
Lettuce	Russet spotting
Broccoli	Yellowing, abscission, off flavors
Eggplant	Browning of flesh and seeds, decay induction
Cucumber	Yellowing, softening
Sweet potatoes	Browning of pulp, off flavor, failure to soften upon cooking

### 2.2.6 Physiological Disorders and Breakdowns

Physiological disorders result from metabolic disturbances caused by a host of internal (nutritional imbalance) and external (temperature and surrounding atmosphere) factors. Table 2.13 lists some of the common disorders associated with common fruits and vegetables. Besides inducing serious loss of quality in terms of color, flavor, texture, and appearance, physiological disorders can predispose produce to deterioration by enzymes and decay microorganisms. When only superficial tissues are affected by the disorder, fruits may still be able to be processed without seriously impacting the quality of processed products. Maturity at

TABLE 2.13

## Physiological Disorders of Selected Fruits and Vegetables

Fruits	Disorder	Common Symptoms	Cause
Apples	Sunscald or sunburn	White or yellow spots on the fruit facing the sun followed by drying out and sunken areas	Heat stress to the tissue
	Storage scald	Irregular brown patches of dead skin developing during warming after cold storage	Chilling injury involving oxidation of $\alpha$ -farnesene to conjugated trienes
	Internal breakdown (brown heart)	Brown discoloration of flesh	CO <sub>2</sub> injury during storage
	Bitter pit	Brown lesion in flesh, dark and corky tissue below the skin	Low levels of calcium and high concentrations of potassium and magnesium, dissolution of middle lamellae by oxalic and succinic acid, changes in proton secretion and potassium permeability
	Water core	Water-soaked regions in flesh and core	Inability of fruit to convert sorbitol into fructose and hence accumulation of sorbitol
Pear	Core breakdown	Brown, soft breakdown of core and surrounding tissues	Storing fruits beyond normal storage life
	Flesh spot decay	Partial browning of spots and development of cavities	Unknown
	Internal breakdown	Brown to dark brown water-soaked areas in core and flesh	Unknown
	Watery breakdown	Soft, watery deterioration	Slow cooling or exposure to warm temperatures
	Senescent scald	Brown to black discoloration of skin, loss of ripening capacity, adverse taste and odor	End of postharvest life and setting of fermentation
Pomegranates	Husk scald	Discoloration of husk	Oxidation of phenolics
	Chilling injury	Brown discoloration of skin, pitting, loss of red color of arils	Oxidation of phenolics in response to exposure to temperature <5°C
Stone fruits (apricots, peach, nectarine, plum, and prune)	Internal breakdown	Flesh browning, lack of juiciness due to meakiness or leatheryness, accumulation of red pigmentation, black pit cavity, loss of flavor	Placing fruit at room temperature after cold storage during ripening Meakiness could be genetically controlled
	Inking, black stain	Brown and black spots on the skin	Abrasion damage in association with contamination with metals (iron, copper, aluminum)
	Surface pitting and bruising	Small sunken areas on skin and large flattened areas	Mechanical impact or compression
Tomatoes	Blossom drop	Fruit set failure	Prevalence of extreme temperature during pollination
	Blossom end rot	Brown to black spot on the blossom end	Calcium deficiency, excessive nitrogen fertilization
	Sun scald	Shiny white or yellow spots on the fruit facing sun followed by drying out and sunken areas	Fruit exposure to sun under extreme heat
	Fruit cracks	Radial and concentric cracks the stem end	Heavy rainfall or irrigation after at long dry period
	Catfacing	Puckering and scarring of the blossom end	Cloudy and cool weather during blooming
	Puffiness	Hollow inside and empty cavity	Defective pollination due to seed extremes of temperature, excessive nitrogen fertilization and heavy rains

Source: Adapted from C. H. Crisosto. *Physiological Disorder Fact Sheets*. Postharvest Technology Information Centre, University of California, Davis, (updated in June 2002), 2002 (<http://postharvest.ucdavis.edu/produce/disorders/>); R. H. H. Wills et al. *Postharvest: An Introduction to the Physiology and Handling of Fruit Vegetables and Ornamentals*, New South Wales University Press, Sydney, 1998.

harvest, cultural practices, climate during growing season, produce size, and harvesting and handling practices can be involved in inducing disorders [86]. Preharvest factors that affect the incidence of postharvest disorders are type of the produce, variety, nutritional status of produce and soil, level of maturity, temperature, fruit size and color, moisture content of soil, and position of fruit on the tree. Crop load and fruiting position are linked with bitter pit [28–30] in apples, and mealiness and browning of stone fruits [25]. Detailed information about the physiological disorders and diseases are covered in Refs. [98,99].

### 2.2.6.1 Disorders due to Mineral Deficiencies

Plants require a balanced mineral intake from soil and favorable environment for proper development, which leads to desired quality attributes. Nutrient transport, water relations, and fruit growth dictate the susceptibility of the tissue to a disorder [28]. Ferguson et al. [28] discussed a range of preharvest factors that influence the physiology of disorders during storage and ripening. They divided these disorders into those predetermined on the tree and those induced by storage factors. Predetermined disorders are closely associated with later stages of fruit development and do not require specific postharvest conditions to express during storage. Bitter pit in apples, characterized by brown lesions in flesh, dark, and corky tissue below the skin and slight bitter taste, develops due to preharvest low fruit Calcium (Ca) and high levels of Potassium and Magnesium. Pre- and postharvest application of Ca controls this disorder. Calcium nutrition together with maturity influences the early development of water core in apples [17]. Preharvest factors associated with bitter pit in apple, such as low crop loads, large fruit volume-to-weight ratio, poor pollination and low seed numbers, lowspur, bourse leaf area, age of the fruiting wood, and position of the fruit on the tree directly or indirectly relate to calcium nutrition of the fruit [27–31,111]. Fruit softening in papaya [80] and blossom end rotting of tomato have also been linked to low Ca levels [42].

### 2.2.6.2 Disorders due to Environmental Factors

#### 2.2.6.2.1 Low-Temperature Injuries or Disorders

Chilling and freezing injuries result from exposure of plant tissues to low temperature. Both types of defects are prevalent in fruits and vegetables of tropical and subtropical origin, which lack the ability to adapt to low-temperature environments [22]. Table 2.14 classifies fruits according to climate area of growth and can indicate fruits susceptible for low-temperature injuries. The susceptible produce tend to have low storage potential as very low temperatures cannot be used during storage, transport, and handling. Lowest safe storage temperature has to be well above the chilling injury (CI) threshold of susceptible product. The CI manifests into symptoms such as pitting, browning, scald appearance, darkening of the skin, changes in the flavor and texture, and the loss of ripening ability. The severity of the symptoms depends on the type of the produce, and time and temperature of the exposure. The mechanism of development of CI is complex. Changes in the membrane lipids and dissociation of enzymes and other proteins have been proposed to be the two likely causes of development of CI [64,120]. Most tropical and subtropical produce show CI upon exposure to chilling temperatures below 10°C–15°C [113]. Table 2.15 shows CI symptoms and temperature at which injury symptoms appear for selected fruits and vegetables.

**TABLE 2.14**

Classification of Fruits according to Their Climate Area of Growth

Climate Zone	Examples
Temperate	Pome fruits (apple, pear, quince), stone fruits (apricot, cherry, nectarine, peach, plum), small fruits and berries (grape, strawberry, raspberry, blueberry, blackberry, cranberry)
Subtropical	Citrus fruits (grapefruit, lemon, lime, orange, pummelo, tangerine, mandarin), noncitrus fruits (avocado, cherimoya, fig, kiwifruit, olive, pomegranate)
Tropical	Banana, mango, papaya, pineapple, carambola, cashew apple, durian, guava, longan, lychee, mangosteen, passion fruit, rambutan, sapota, tamarind

Source: Adapted from A. A. Kader and D. M. Barrett. In *Processing Fruits: Science and Technology, Vol. 1, Biology, Principles, and Applications* (L. P. Somogyi, H. S. Ramaswamy, and Y. H. Hui, Eds), Technomic Publishing Co., Pennsylvania, 2003, p. 1.

TABLE 2.15

Chilling Injury of Fruits and Vegetables Stored above Freezing Temperatures

Class	Produce	$T_{inj}$ (°C) <sup>a</sup>	Symptoms
A (0°C–5°C)	Apple (some cultivars)	2–3	Internal browning, brown core, soggy tissues, and soft scald
	Asparagus	0–2	Dull, gray-green, limp tips
	Avocado	4.5–13	Grayish-brown discoloration of flash
	Lima bean	1–4.5	Rusty brown specs, spots or areas
	Cranberry	2	Rubbery texture, red flash
	Guava	4.5	Pulp injury, decay
	Cantaloupe	2–5	Pitting, surface decay
	Watermelon	4.5	Pitting, objectionable flavor
	Orange	3	Pitting and brown stain
	Pomegranate	4.5	Pitting, external and internal browning
	Potato	3	Mahogany browning, sweetening
	Tamarillo	3–4	Surface pitting and discoloration
	B (6°C–10°C)	Snap bean	7
Cucumber		7	Pitting, water-soaked spots, and decay
Eggplant		7	Surface scald, <i>Alternaria</i> rot, blackening of seeds
Lime		7–9	Pitting, turning tan with time
Honeydew melon		7–10	Reddish-tan discoloration, pitting, surface decay, failure to ripen
Casaba, Crenshaw and Persian melon		7–10	Pitting, surface decay, failure to ripen
Okra		7	Discoloration, water soaked areas, pitting, decay
Fresh olive		7	Internal browning
Papaya		7	Pitting, failure to ripen, off flavor, decay
Sweet pepper		7	Sheet pitting, <i>Alternaria</i> rot on pods and calyxes, darkening of seeds
Pineapple		7–10	Dull green when ripened
Pumpkin (hardshell and squashed)		10	Decay, especially <i>Alternaria</i> rot
Tomatoes (ripe)		7–10	Water soaking
C (11°C–20°C)	Banana (green or ripe)	11.5–13	Dull color when ripened
	Grapefruits	10	Scald, pitting, watery breakdown
	Jicama	13–18	Pitting, membranous staining, red blotch
	Mango	10–13	Grayish scald-like discoloration of skin, uneven ripening
	Sweet potato	13	Decay, pitting, internal discoloration, hard core when cooked
	Tomato	13	Poor color when ripe, <i>Alternaria</i> rot

<sup>a</sup>Approximate lowest safe temperature.Source: R. E. Harderburg et al. *The Commercial Storage of Fruits, Vegetables, and Florist and Nursery Stocks*, USDA, Agricultural Handbook No. 66, 1986.

Internal discoloration, water-soaked appearance, and increased susceptibility to plant pathogens result in the loss of quality for both fresh and processed markets. Besides, avoiding exposures to injury temperature, CI can be minimized by reducing the exposure time to injury temperatures, precooling produce in stages to build adaptation, selection of resistant varieties, selecting fruits at appropriate level of ripening, intermittent warming [63] and cooling treatments, controlled atmosphere storage (>2% CO<sub>2</sub> and <5% O<sub>2</sub>), maintaining high storage RH, and improving calcium nutrition [97,104,105,113,120].

Freezing injury (FI) results from exposure of plant tissues to freezing temperatures (<0°C) and formation of ice crystals, which damages the cells, mostly irreversibly. The injury initiates osmotic stress and damage to the cell membrane responsible for water loss and death of cells. The factors that affect FI are type of produce, variety, nature of solutes, and field temperature. [51,113,120]. Susceptibility of fruits and vegetables to FI varies between the produce (Table 2.16). Light freezing damages the most susceptible crops, while least susceptible products can be frozen several times before injury occurs. Moderately susceptible produce can recover from one or two episodes of freezing. Susceptibility to FI, however, does not depend on the freezing point, which may vary between –0.1 and –1.8°C [51,113]. Warm-season crops are highly susceptible to FI than those that are grown in the cold season. The symptoms of the FI include discoloration of the tissue, water-soaking appearance,

TABLE 2.16

Relative Susceptibility of Fruits and Vegetables to Freezing Injury

	Highly Susceptible	Moderately Susceptible	Slightly Susceptible
Vegetables	Artichoke	Cabbage	Beetroots
	Asparagus	Carrot	Brussels sprouts
	Beet	Cauliflower	Celeriac
	Broccoli	Chives	Collard
	Celery	Endive	Horseradish
	Cucumber	Leek	Kale
	Eggplant	Onion (bulb)	Kohlrabi
	Sweet corn	Onion (green)	Parsnip
	Lettuce	Parsley	Rutabagas
	Okra	Shelled peas	Salsify roots
	Sweet pepper	Peas (pod)	Turnip roots
	Potatoes	Radish	
	Summer squash	Spinach	
	Sweet potatoes	Winter squash	
	Tomatoes		
Fruits	Apricot	Apple	Dates
	Avocado	Cranberry	
	Banana	Grape	
	Berries (except cranberries)	Orange	
	Lemon	Pear	
	Limes		
	Peaches		
	Plums		

Source: Adapted from A. A. Kader et al. *HortSci.*, 9(6):523, 1974 ([www.ba.ars.usda.gov/hb66/index.html](http://www.ba.ars.usda.gov/hb66/index.html)); C. Y. Wang and H. A. Wallace. In *The Commercial Storage of Fruits, Vegetables, and Florist and Nursery Stocks—A Draft Version of the Revision to USDA Agricultural Handbook Number 66* (K. C. Gross, C. Y. Wang, and M. Saltveit, Eds), 2002 (revised in 2004).

blistering, and pitting. The damaged tissues are prone to further decay by microorganisms and mechanical injuries, particularly bruising.

#### 2.2.6.2.2 High-Temperature Injuries or Disorders

Exposure of tissues to high temperature during production or postharvest results in injuries or disorders, which may cause the loss of ability to ripen normally, burnt or scorched peel, and darkening of the pulp. Examples of such disorders are scald in apples and tomatoes and blossom drop in tomatoes. Besides avoiding long exposure to sun, superficial scald in apples can be controlled by postharvest spray with ethoxiquin or diphenylamine. The latter is more effective.

#### 2.2.6.2.3 Injuries/Disorders due to Exposure to Adverse Atmosphere

Exposure to low levels of O<sub>2</sub> and high levels of CO<sub>2</sub> may lead to tissue injuries such as internal browning in apples and pears when the tissue tolerance is exceeded. The factors that influence the susceptibility are variety, low crop load, exposure to higher concentration of CO<sub>2</sub> at the time of harvest, and presence of coatings that restrict the diffusion of gases [59].

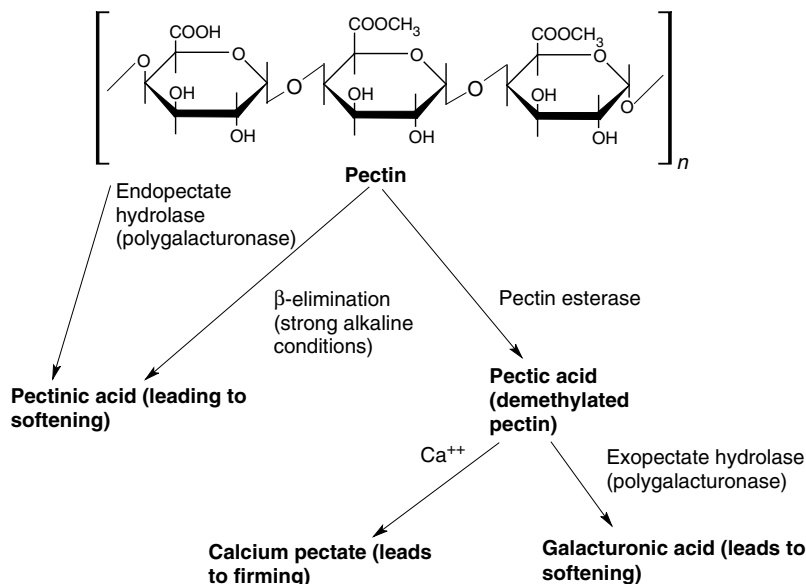
### 2.2.7 Other Biochemical Changes

Chemical and enzymatic changes cause tissue softening, off flavors, pigment loss and off colors, and overall decline in nutritional value and taste [2,3,32]. The enzymes that catalyze biochemical reactions responsible for these changes are given in Table 2.17. Softening of the tissues can be due to hydrolysis of starch and cellulose by amylases and cellulose enzymes, respectively, degradation of pectin by pectinases. There are three key enzymes involved in the degradation of pectins (Figure 2.7), endo- and exopectate hydrolases

TABLE 2.17

Enzymes Responsible for Key Reactions Associated with Ripening and Senescence in Fruits and Vegetables

Enzymes	Reaction	Result
Polyphenoloxidase, catalase, peroxidase	Oxidation of phenolics	Formation of precursors to colored and polymers leading to undesirable browning
Polygalacturonase	Hydrolysis of glycosidic bonds between adjacent polygalacturonic acid residues in pectin	Tissue softening
Pectin esterase	Hydrolysis of ester bonds of galacturonans in pectin	Tissue firming
Lipoxygenase	Oxidation of lipids	Production of off flavor and off odors
Ascorbic acid oxidase	Oxidation of ascorbic acid	Loss of nutrition quality
Chlorophyllase	Cleavage of phytol ring from chlorophyll	Loss of green color
Amylases	Hydrolysis of amylose and amylopectin	Loss of texture and increase in sweetness due to production of sugars
Cellulase and hemicellulases	Hydrolysis of cell wall	Loss of texture
Proteases	Hydrolysis of proteins	Loss of nutritional value and increase or decrease in digestibility
Lipase	Hydrolysis of lipids	Hydrolytic rancidity
Phytase	Hydrolysis of phytic acid	Liberation of phosphates
Glucose oxidase	Oxidation of glucose	Formation of hydrogen peroxide

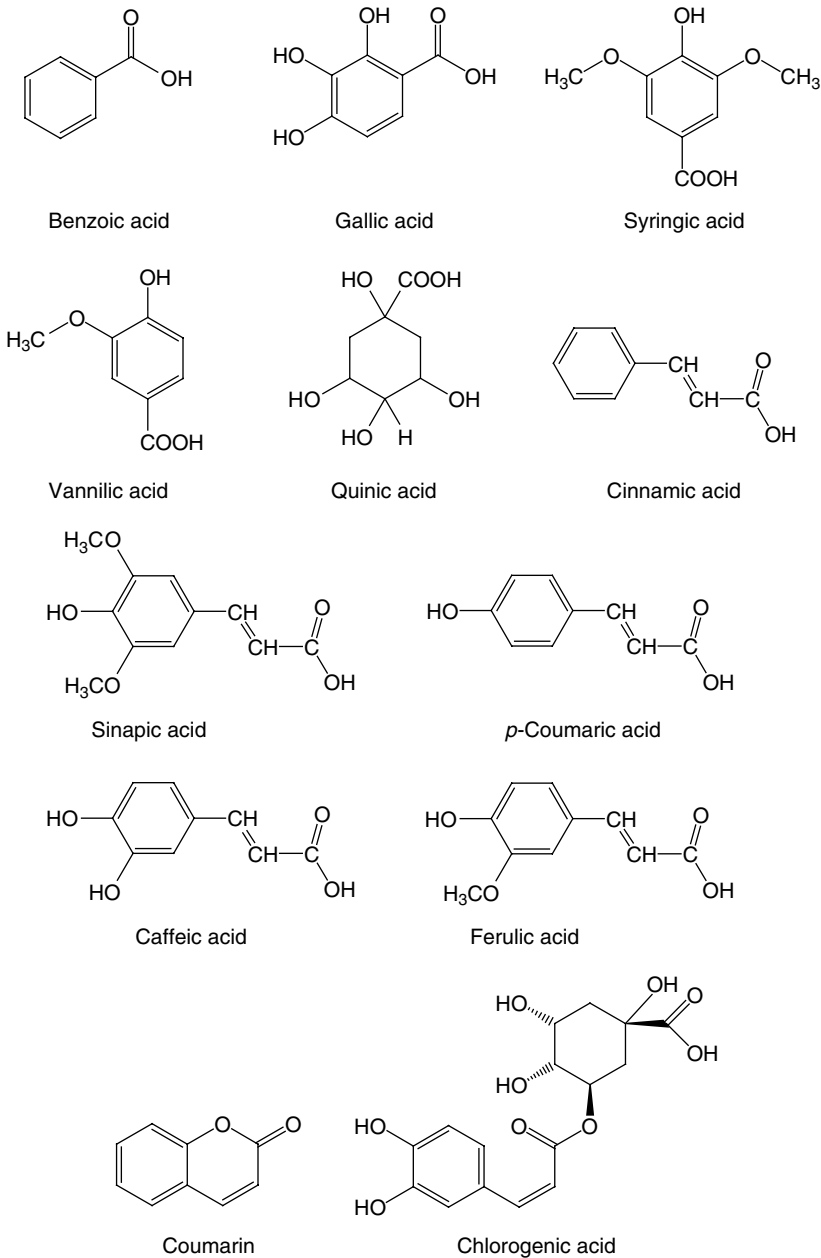


**FIGURE 2.7** Reactions leading to firming and softening effect by pectin degradation. (From J. B. Adams. In *Raw Ingredient Quality in Processed Foods—The Influence of Agricultural Principles and Practices* (M. B. Springett, Ed.), Aspen Publishers Inc., Gaithersburg, MD, 2001, p. 57; C. Zapsalis and R. A. Beck, *Food Chemistry and Nutritional Biochemistry*, John Wiley & Sons, New York, 1985, p. 371.)



and pectin esterase. Endopectate hydrolase yields methyl galacturonide oligomer and exopectate hydrolase acts on demethylated pectin produced by pectin esterase to produce galacturonic acid. Formation of galacturonide oligomer and galacturonic acid leads to softening of plant tissues. However, the formation of calcium pectate as a result of addition of calcium has a firming effect on the tissue. The activity of pectin-degrading enzymes seriously impacts gel-forming ability of fruits required for production of fruit preserves. Under strong alkaline conditions pectin could also be converted to pectinic acid leading to softening.

Fruits and vegetables contain varieties of phenolic compounds (Figure 2.8) that participate in browning reactions catalyzed by enzymes and other quality changes [106]. Cutting or injuring plant tissue results in



**FIGURE 2.8** Phenolic compounds found in fruits and vegetables.

browning of the cut surface due to enzymatic oxidation of phenolic compounds present due to cell compartmentation of substrate and enzymes. In the presence of O<sub>2</sub>, phenolases oxidize phenols to benzoquinones, which, although colorless, further get converted into brown pigments in fruits and vegetables (potato, mushroom, apple, and banana). The physiological role of these enzymes in plant cell is not very well understood. The factors influencing enzymatic browning are type and content of phenolic substances, enzymes, temperature, and presence of inhibitors. Chlorogenic acid, a phenol found in potatoes, is also responsible for after-cooking blackening of potatoes and greening of cooked potatoes [2]. The after-cooking blackening reaction involves formation of ferric dichlorogenate from chlorogenic acid and ferrous ions [3] and favored by conditions leading to higher ratio of chlorogenic acid to citric acid. Postharvest sweetening of potatoes is a serious problem in cold-stored potatoes due to conversion of starch into sugars. The production of reducing sugars can lead to nonenzymatic browning in potato chips and can be avoided by warming the produce before use [110]. Injuries can also lead to formation of stress metabolites through linoleic/linolenic acid cascade-producing traumatin and jasmonic acid, which have a role in forming a defense system against insects and microorganisms [39]. Degradation of lipids by lipase and lipoxygenase enzymes can lead to the formation of off flavors in fruits and vegetables (e.g., beans and peas), and can be avoided by inactivating these enzymes or by knocking the genes responsible for their expression.

---

## References

1. J. A. Abbott and F. Roger Harker. Texture. In *The Commercial Storage of Fruits, Vegetables, and Florist and Nursery Stocks—A Draft Version of the Revision to USDA Agricultural Handbook Number 66* (K. C. Gross, C. Y. Wang, and M. Saltveit, Eds), 2002 (revised in 2004) ([www.ba.ars.usda.gov/hb66/index.html](http://www.ba.ars.usda.gov/hb66/index.html)).
2. J. B. Adams. The influence of raw materials on the quality of processed vegetables. In *Raw Ingredient Quality in Processed Foods—The Influence of Agricultural Principles and Practices* (M. B. Springett, Ed.), Aspen Publishers, Gaithersburg, MD, 2001, p. 57.
3. J. B. Adams. Raw materials quality and the texture of processed vegetables. In *Texture in Food, Vol. 2 Solid Foods* (D. Kilcast, Ed.), Woodhead Publishing, Cambridge and CRC Press, Boca Raton, FL, 2004, p. 342.
4. J. Aked. Maintaining the post-harvest quality of fruits and vegetables. In *Fruit and Vegetable Processing Improving Quality* (W. Jongen, Ed.), Woodhead Publishing and CRC Press, Boca Raton, FL, 2004, p. 119.
5. P. R. Armstrong, G. K. Brown, and E. J. Timm. Cushioning choices can avoid produce bruising during handling. In *Harvest and Postharvest Technologies for Fresh Fruits and Vegetables* (L. Kushwaha, R. Serwatowski, and R. Brook, Eds), American Society of Agricultural Engineers, Michigan, 1995, p. 183.
6. *ASHRAE Handbook of Refrigeration Systems and Applications*, American Society of Heating, Refrigeration and Air-conditioning Engineers, Atlanta, GA, 1998.
7. J. E. Baker. Morphological changes during maturation and senescence. In *Postharvest Physiology, Handling, and Utilization of Tropical and Subtropical Fruits and Vegetables* (E. B. Pantastico, Ed.), AVI Publishing, Westport, CT, 1975, p. 128.
8. E. A. Baldwin. Flavor. In *The Commercial Storage of Fruits, Vegetables, and Florist and Nursery Stocks—A Draft Version of the Revision to USDA Agricultural Handbook Number 66* (K.C. Gross, C.Y. Wang, and M. Saltveit, Eds), 2002 (revised in 2004) ([www.ba.ars.usda.gov/hb66/index.html](http://www.ba.ars.usda.gov/hb66/index.html)).
9. E. A. Baldwin. Coatings and other supplemental treatments to maintain vegetable quality. In *Postharvest Physiology and Pathology of Vegetables* (J. A. Bartz and J. K. Brecht, Eds), Marcel Dekker, New York, 2003, p. 413.
10. B. Beattie and N. Wade. Storage, ripening, and handling of fruit. In *Fruit Processing*, 2nd ed. (D. Arthey and P. R. Ashurst, Eds) Aspen Publishers, Maryland, 2001, p. 53.
11. B. R. Becker and B. A. Fricke. Transpiration and respiration of fruits and vegetables. In *New Developments in Refrigeration for Food Safety and Quality*. Int. Inst. Ref., Paris, France and ASAE, St Joseph, Michigan, 1996, p. 160.
12. L. Bedford. Raw material selection—fruits and vegetables. In *Chilled Foods—A Comprehensive Guide*, 2nd ed. (M. Stringer and C. Dennis, Eds), CRC Press, Boca Raton, FL, 2000, p. 19.
13. S. Ben-Yehoshua and V. Rodov. Transpiration and water stress. In *Postharvest Physiology and Pathology of Vegetables* (J. A. Bartz and J. K. Brecht, Eds), Marcel Dekker, New York, 2003, p. 111.

14. R. Beudry and C. Watkins. Use of 1-MCP on apples. *Perishable Handling Q.*, 108:12, 2001.
15. S. R. Bhowmik and J. C. Pan. Shelf life of mature green tomatoes stored in controlled atmosphere and high humidity. *J. Food Sci.*, 57:948, 1992.
16. J. B. Biale and R. E. Young. Respiration and ripening in fruits-retrospect and prospect. In *Recent Advances in the Biochemistry of Fruits and Vegetables* (J. Friend and M. J. C. Rhodes, Eds), Academic Press, London, 1981, p. 1.
17. J. H. Bowen and C. B. Watkins. Fruit maturity, carbohydrate and mineral content relationships with water core in 'Fuji' apples. *Postharvest Biol. Technol.*, 11:31, 1997.
18. J. K. Brecht and P. E. Brecht. *Effect of Small Temperature Differences on Quality of Horticultural Commodities*, PEB Commodities Inc., 2002.
19. R. M. Brennan and R. E. Harrison. Factors affecting processing of red fruits. In *Raw Ingredient Quality in Processed Foods—The Influence of Agricultural Principles and Practices* (M. B. Springett, Ed.), Aspen Publishers, Gaithersburg, MD, 2001, p. 97.
20. D. A. Brummell. Cell wall disassembly in ripening fruit. *Functional Plant Biol.*, 33:103, 2006.
21. I. Burzo. Influence of temperature level on respiratory intensity in the main vegetable varieties, Proceedings of the Symposium on Postharvest Handling of Vegetables. *Acta Hort.*, 116:61, 1980.
22. H. M. Couey. Chilling injury of crops of tropical and subtropical origin. *HortSci.*, 17:162, 1982.
23. C. H. Crisosto. *Physiological Disorder Fact Sheets*. Postharvest Technology Information Centre, University of California, Davis, updated in June 2002, 2002 (<http://postharvest.ucdavis.edu/produce/disorders/>).
24. C. H. Crisosto, D. Garner, J. Doyle, and K. R. Day. Relationship between fruit respiration, bruising susceptibility, and temperature in sweet cherries. *HortSci.*, 28:132, 1993.
25. C. H. Crisosto, R. S. Johnson, T. DeJong, and K. R. Day. Orchard factors affecting postharvest stone fruit quality. *HortSci.*, 32:820, 1997.
26. M. E. Dauthy. *Fruit and Vegetable Processing*, FAO Agricultural Bulletin No. 119, FAO of the United Nations, Rome, 1995 ([www.fao.org/documents/show\\_cdr.asp?url\\_file=/docrep/V5030E/V5030E0s.htm](http://www.fao.org/documents/show_cdr.asp?url_file=/docrep/V5030E/V5030E0s.htm)).
27. B. Ferguson. Calcium nutrition and cell response. In *Calcium in Plant Growth and Development* (R. T. Leonard and P. K. Helper, Eds), American Society of Plant Physiologists Symposium Series, Vol. 4, 1990, pp. 1–8.
28. I. Ferguson, R. Volz, and A. Woolf. Preharvest factors affecting physiological disorders of fruit. *Postharvest Biol. Technol.*, 1:255, 1999.
29. I. Ferguson and C. B. Watkins. Bitter pit in apple fruit. *Hortic. Rev.*, 11:289, 1989.
30. I. Ferguson and C. B. Watkins. Crop load affects mineral concentrations and incidence of bitter pit in 'Cox's Orange Pippin' apple fruit. *J. Am. Soc. Hortic. Sci.*, 117:373, 1992.
31. I. B. Ferguson. Calcium in plant senescence and fruit ripening. *Plant Cell Environ.*, 7:477, 1984.
32. J. D. Floros. The shelf life of fruits and vegetables. In *Shelf Life Studies of Foods and Beverages: Chemical, Biological, Physical, and Nutritional Aspects* (G. Charalambous, Ed.), Elsevier Science Publishers B. V., Amsterdam, 1993, p. 195.
33. L. C. Garratt, J. B. Power, and M. R. Davey. Improving the shelf life of vegetables by genetic modification. In *Fruit and Vegetable Processing Improving Quality* (W. Jongen, Ed.), Woodhead Publishing, Cambridge and CRC Press, Boca Raton, FL, 2002, p. 267.
34. A. S. Gholap, C. Bandyopadhyay, and G. B. Nadkarni. Aroma development in mango fruit. *J. Food Biochem.*, 10:217, 1986.
35. J. R. Gorny and D. Zagory. Food safety. In *The Commercial Storage of Fruits, Vegetables, and Florist and Nursery Stocks—A Draft Version of the Revision to USDA Agricultural Handbook Number 66* (K. C. Gross, C. Y. Wang, and M. Saltveit, Eds) (2002) (revised in 2004) ([www.ba.ars.usda.gov/hb66/index.html](http://www.ba.ars.usda.gov/hb66/index.html)).
36. W. A. Gortner, G. G. Dull, and B. H. Kraus. Fruit development, maturation, ripening, and senescence: Biochemical basis for horticultural terminology. *Hortic. Sci.*, 2:141, 1967.
37. K. C. Gross, C. Y. Wang, and M. Saltveit. *The Commercial Storage of Fruits, Vegetables, and Florist and Nursery Stocks—A Draft Version of the Revision to USDA Agricultural Handbook Number 66* (2002) (revised in 2004) ([www.ba.ars.usda.gov/hb66/index.html](http://www.ba.ars.usda.gov/hb66/index.html)).
38. N. E. Haard. Foods as cellular systems: impact on quality and preservation. A review. *J. Food Biochem.*, 19:191, 1995.
39. N. E. Haard. Foods as cellular systems: impact on quality and preservation. In *Food Storage and Stability* (I. A. Taub and R. P. Singh, Eds), CRC Press, Boca Raton, FL, 1998, p. 39.

40. R. E. Harderburg, A. E. Watada, and C. Y. Wang. *The Commercial Storage of Fruits, Vegetables, and Florist and Nursery Stocks*, USDA, Agricultural Handbook No. 66, 1986.
41. M. Herregods. Storage of tomatoes. *Acta Hort.*, 20:137, 1971.
42. L. C. Ho, R. Belda, M. Brown, H. Andrews, and P. Adams. Uptake and transport of calcium and the possible caused of blossom end rot in tomato. *J. Exp. Bot.*, 44:509, 1993.
43. S. D. Holdsworth. *The Preservation of Foods and Vegetable Food Products*, Macmillan, London, 1983.
44. D. S. Johnson and M. S. Ridout. Effects on the quality of stored apples fruit. In *Fruit and Vegetable Quality, An Integrated View* (R. L. Shewfelt and B. Bruckner, Eds), Technomic Publishing Co., Pennsylvania, 2000, p. 67.
45. A. A. Kader. Biochemical and physiological basis for effects of controlled and modified atmospheres on fruits and vegetables. *Food Technol.*, 40(5):99, 1986.
46. A. A. Kader. *Postharvest Technology of Horticultural Crops*, University of California, Publication 3311, 1992.
47. A. A. Kader. Fruit maturity, ripening and quality relationship. *Acta Hort.*, 485:203, 1999.
48. A. A. Kader. Quality parameters of fresh-cut fruit and vegetables products. In *Fresh-Cut Fruit and Vegetables: Science Technology and Market* (O. Lamikara, Ed.), CRC Press, Boca Raton, FL, 2002, p. 11.
49. A. A. Kader and D. M. Barrett. Classification, composition of fruits, and postharvest maintenance of quality. In *Processing Fruits: Science and Technology, Vol. 1, Biology, Principles, and Applications* (L. P. Somogyi, H. S. Ramaswamy, and Y. H. Hui, Eds), Technomic Publishing Co., Pennsylvania, 2003, p. 1.
50. A. A. Kader, R. F. Kasmire, F. G. Mitchell, M. S. Reid, N. F. Sommer, and J. F. Thompson. *Postharvest Technology of Horticultural Crops*, University of California, Davis, 1985.
51. A. A. Kader, J. M. Lyons, and L. L. Morris. Postharvest response of vegetables to preharvest field temperature. *HortSci.*, 9(6):523, 1974.
52. A. A. Kader and R. S. Rolle. *The Role of Post-Harvest Management in Assuring the Quality and Safety of Horticultural Produce*, FAO Agricultural Services Bulletin 152, FAO of the UN, Rome, 2004.
53. A. A. Kader and M. E. Salveit. Respiration and gas exchange. In *Postharvest Physiology and Pathology of Vegetables* (J. A. Bartz and J. K. Brecht, Eds), Marcel Dekker, New York, 2003, p. 22.
54. A. A. Kader, D. Zagory, and E. L. Kerbel. Modified atmosphere packaging of fruits and vegetables. *Crit. Rev. Food Sci. Nutr.*, 28(1):1–30, 1989.
55. G. A. King and E. M. O'Donoghue. Unraveling senescence: new opportunities for delaying the inevitable in harvested fruit and vegetables. *Trends Food Sci. Technol.*, 6:385, 1995.
56. L. Kitinoja and A. A. Kader. *Small-Scale Postharvest Handling Practices: A Manual for Horticultural Crops*, 3rd ed., University of California, Davis, 1995.
57. P. Krogh. The role of mycotoxins in disease of animals and man. *J. Appl. Bacteriol. Symp. Suppl.*, 18:99S, 1989.
58. S. Kumar, B. C. Patil, and S. K. Sinha. Cyanide respiration is involved in temperature rise in ripening mangoes. *Biochem. Biophys. Res. Comm.*, 168:818, 1990.
59. E. Kupferman. *Minimizing Internal Browning in Apples and Pears*. Washington State University—Tree Fruit Research and Extension Center, September 2002 (<http://postharvest.tfrec.wsu.edu/EMK2002D.pdf>).
60. C. P. Lenz, L. van den Berg, and R. S. McCullough. Study of factors affecting temperature relative humidity and moisture loss in fresh fruit and vegetable storage. *Can. Inst. Food Technol.*, 4:146, 1971.
61. G. Lisinska and W. Leszczynski. *Potato Science and Technology*, Elsevier Applied Science, London, 1989.
62. P. M. Ludford. Hormonal changes during postharvest. In *Postharvest Physiology and Pathology of Vegetables* (J. A. Bartz and J. K. Brecht, Eds), Marcel Dekker, New York, 2003, p. 31.
63. S. Lurie. Post harvest heat treatment. *Postharvest Biol. Technol.*, 14:257, 1998.
64. S. Lurie and C. H. Crisosto. Chilling injury in peach and nectarine. *Postharvest Biol. Technol.*, 37:195, 2005.
65. R. F. MacLeod, A. A. Kader, and L. L. Morris. Stimulation of ethylene and CO<sub>2</sub> production of mature green tomatoes by impact bruising. *HortSci.*, 11:604, 1976.
66. A. Maestrelli. Fruit and vegetables: the quality of raw material in relation to freezing. In *Managing Frozen Foods* (C. J. Kennedy, Ed.), Woodhead Publishing, Cambridge, 2000, p. 27.
67. Y. Margalit. *Winery Technology and Operations*, Wine Appreciation Guild, San Francisco, 1996.
68. A. K. Mattoo, T. Murata, E. B. Pantastico, K. Chachin, K. Ogata, and C. T. Phan. Chemical changes during ripening and senescence. In *Postharvest Physiology, Handling, and Utilization of Tropical and Subtropical Fruits and Vegetables* (E. B. Pantastico, Ed.), AVI Publishing, Westport, CT, 1975, p. 103.

69. R. F. Matthews. *Frozen Concentrated Orange Juice from Florida Oranges*, University of Florida, Fact sheet FS 8, April 1994 (reviewed April 1, 2003) (<http://edis.ifas.ufl.edu/pdf/files/CH/CH09500.pdf>).
70. T. Nilsson. Postharvest handling and storage of vegetables. In *Fruit and Vegetable Quality, An Integrated View* (R. L. Shewfelt and B. Bruckner, Eds), Technomic Publishing Co., Pennsylvania, 2000, p. 96.
71. H. E. Nursten. Volatile compounds: the aroma of fruits. *The Biochemistry of Fruits and Their Products* (A. C. Hulme, Ed.), Academic Press, New York, 1970, p. 239.
72. J. M. Ogawa, J. Rumsey, B. T. Manji, G. Tate, J. Toyoda, E. Bose, and L. Dugger. Implications and chemical testing of two rhizopus fungi in softening of canned apricots. *Calif. Agric.* 28:6, 1974.
73. Optimal fresh-Horticultural Storage and Handling Database, 2005 ([www.postharvest.com.au/Produce\\_Information.htm](http://www.postharvest.com.au/Produce_Information.htm)).
74. E. B. Pantastico. General introduction: structure of fruits and vegetables. In *Postharvest Physiology, Handling, and Utilization of Tropical and Subtropical Fruits and Vegetables* (E. B. Pantastico, Ed.), AVI Publishing, Westport, CT, 1975, p. 1.
75. E. B. Pantastico. Preharvest factors affecting quality and physiology after harvest. *Postharvest Physiology, Handling, and Utilization of Tropical and Subtropical Fruits and Vegetables* (E. B. Pantastico, Ed.), AVI Publishing, Westport, CT, 1975, p. 25.
76. J. Pech, M. Bouzayen, A. Latche, M. Sanmartin, A. Aggelis, and A. K. Kanellis. Physiological, biochemical and molecular aspects of ethylene biosynthesis and action. In *Postharvest Physiology and Pathology of Vegetables* (J. A. Bartz and J. K. Brecht, Eds), Marcel Dekker, New York, 2003, p. 247.
77. E. Pesis. Introduction of fruit aroma and quality by post-harvest application of natural metabolites or anaerobic conditions:1. Biosynthesis and degradation of aroma volatile during post-harvest life. *Modern Methods Plant Anal.*, 18:19, 1996.
78. C. T. Phan, E. B. Pantastico, K. Ogata, and K. Chachin. Respiration and respiratory climacteric. In *Postharvest Physiology, Handling, and Utilization of Tropical and Subtropical Fruits and Vegetables* (E. B. Pantastico, Ed.), AVI Publishing, Westport, CT, 1975, p. 86.
79. J. Pino, R. Torricella, and F. Orsi. Correlation between sensory and gas chromatographic measurements on grapefruit juice volatiles. *Nahrung*, 30:783, 1986.
80. Y. Qiu, M. S. Nishina, and R. E. Paull. Papaya fruit growth, calcium uptake, and fruit ripening. *J. Am. Soc. Hortic. Sci.*, 120:246, 1995.
81. S. Ranganna. *Handbook of Analysis and Quality Control for Fruit and Vegetable Products*, 2nd ed., Tata McGraw-Hill Publishing Co., New Delhi, 2004.
82. J. E. Rickard, O. J. Burden, and D. G. Coursey. Studies on the insulation of tropical horticultural produce. *Acta Hortic.*, 84:115, 1978.
83. R. Rodriguez, B. L. Raina, E. B. Pantastico, and M. B. Bhatti. Quality of raw materials for processing. In *Postharvest Physiology, Handling, and Utilization of Tropical and Subtropical Fruits and Vegetables* (E. B. Pantastico, Ed.), AVI Publishing, Westport, CT, 1975, p. 467.
84. A. L. Ryall and W. J. Lipton. Handling, *Transportation and Storage of Fruits and Vegetables, Vol. 1, Vegetables and Melons*, AVI Publishing, Westport, CT, 1972.
85. D. K. Salunkhe, H. R. Bolin, and N. R. Reddy. *Storage, Processing, and Nutritional Quality of Fruits and Vegetables, Vol. 1: Fresh Fruits and Vegetables*, CRC Press, Boca Raton, FL, 1991.
86. D. K. Salunkhe and B. B. Desai. *Postharvest Biotechnology of Vegetables*, CRC Press, Boca Raton, FL, 1984.
87. D. K. Salunkhe, B. B. Desai, and J. K. Chavan. Potatoes. In *Quality and Preservation of Vegetables* (N. A. M. Eskin, Ed.), CRC Press, Boca Raton, FL, 1989, p. 1.
88. M. E. Saltveit. Ethylene effects. In *The Commercial Storage of Fruits, Vegetables, and Florist and Nursery Stocks—A Draft Version of the Revision to USDA Agricultural Handbook Number 66* (K. C. Gross, C. Y. Wang, and M. Saltveit, Eds), 2002 (revised in 2004) ([www.ba.ars.usda.gov/hb66/index.html](http://www.ba.ars.usda.gov/hb66/index.html))
89. M. E. Saltveit. Respiratory metabolism. In *The Commercial Storage of Fruits, Vegetables, and Florist and Nursery Stocks—A Draft Version of the Revision to USDA Agricultural Handbook Number 66* (K. C. Gross, C. Y. Wang, and M. Saltveit, Eds), 2002 (revised in 2004) ([www.ba.ars.usda.gov/hb66/index.html](http://www.ba.ars.usda.gov/hb66/index.html)).
90. C. E. Sams. Preharvest factors affecting postharvest texture. *Postharvest Biol. Technol.*, 15:249, 1999.
91. S. K. Sastry, C. Baird, and D. E. Buffington. Transpiration rates of certain fruits and vegetables. *ASHRAE Trans.*, 84(1):237, 1978.

92. S. K. Sastry and D. K. Buffington. Transpiration rates of stored perishable commodities: mathematical model and experiments on tomatoes. *ASHRAE Trans.*, 88(1):159, 1982.
93. M. Sawamura, T. Tsuji, and S. Kuwahara. Changes in the volatile constituents of Pummelo during storage. *Agric. Biol. Chem.*, 53:243, 1989.
94. M. Schreiner, S. Huyskens-Keil, A. Krumbein, and M. Linke. Environmental effect on product quality. In *Fruit and Vegetable Quality, An Integrated View* (R. L. Shewfelt and B. Bruckner, Eds), Technomic Publishing Co., Pennsylvania, 2000, p. 85.
95. G. J. Shaw, P. J. Ellingham, and E. J. Birch. Volatile constituents of feijoa headspace analysis of intact fruit. *J. Sci. Food Agric.*, 34:743, 1983.
96. R. L. Shewfelt and B. Bruckner. Eds. *Fruit and Vegetable Quality, An Integrated View*, Technomic Publishing Co., Pennsylvania, 2000.
97. L. J. Skog. Chilling injury of horticultural crops. Ontario Ministry of Agriculture, Food and Rural Affairs Fact Sheet No. 98-021, 1998 (<http://www.omafra.gov.on.ca/english/crops/facts/98-021.htm>).
98. A. L. Snowdon. *A Color Atlas of Post-Harvest Diseases and Disorders of Fruits and Vegetables, Vol. 1: General Introduction and Fruits*, Wolfe Scientific, Barcelona, 1990.
99. A. L. Snowdon. *A Color Atlas of Post-Harvest Diseases and Disorders of Fruits and Vegetables, Vol. 2, Vegetables*, Wolfe Scientific, Barcelona, 1991.
100. D. F. Splittstoesser. Microbiology of fruit products. In *Processing Fruits: Science and Technology, Vol. 1, Biology, Principles, and Applications* (L. P. Somogyi, H. S. Ramaswamy, and Y. H. Hui, Eds), Technomic Publishing Co., Pennsylvania, 1996, p. 261.
101. M. B. Springett. Ed. Effect of agronomic factors on grape quality for wine production. *Raw Ingredient Quality in Processed Foods—The Influence of Agricultural Principles and Practices*, Aspen Publishers Inc., Gaithersburg, MD, 2001, p. 125.
102. L. G. Tabil and S. Sokhansanj. Mechanical and temperature effects on shelf life stability of fruits and vegetables. In *Food Shelf life Stability* (N. A. M. Eskin and D. S. Robinson, Eds), CRC Press, Boca Raton, FL, 2001, p. 37.
103. R. B. Taylor. Introduction to fruit processing. In *Fruit Processing* (D. Arthey and P. R. Ashurst, Eds), Aspen Publishers, Maryland, 2001, p. 1.
104. A. K. Thompson. *Postharvest Technology of Fruits and Vegetables*, Blackwell, Oxford, 1996.
105. A. K. Thompson. *Controlled Atmosphere Storage of Fruits and Vegetables*, CAB International, Wallingford, 1998.
106. F. A. Tomas-Barberan and J. C. Espin. Phenolic compounds and related enzymes as determinants of quality in fruits and vegetables. *J. Sci. Food Agric.*, 81:853–876, 2001.
107. P. M. A. Toivonen. Non-ethylene, non-respiratory volatiles in harvested fruits and vegetables: their occurrence, biological activity and control. *Postharvest Biol. Technol.*, 12:109, 1997.
108. V. Valpuesta. *Fruit and Vegetable Biotechnology*. Woodhead Publishing, Cambridge, England, 2002.
109. L. Van den Berg and C. P. Lenz. Moisture loss of vegetables under refrigerated storage conditions. *Can. Inst. Food Technol.*, 4:143, 1971.
110. L. H. W. van der Plas. Potato tuber storage: biochemical and physiological changes. In *Potato. Biotechnology in Agriculture and Forestry* (Y. P. Bajaj, Ed.), Berlin, Springer, 1987, p. 109.
111. R. K. Volz, I. B. Ferguson, J. H. Bowen, and C. B. Watkins. Crop load effects on mineral nutrition, maturity, fruiting and tree growth of ‘Cox’s Orange Pippin’ apple. *J. Am. Soc. Hortic. Sci.*, 68:127, 1993.
112. D. H. Wallace. Genetics, environment and plant resources. In *Vegetable Training Manual* (R. L. Villareal and D. H. Wallace, Eds), Coll. Agric. Coll Laguna, 1969, p. 80.
113. C. Y. Wang and H. A. Wallace. Chilling and freezing injury. In *The Commercial Storage of Fruits, Vegetables, and Florist and Nursery Stocks—A Draft Version of the Revision to USDA Agricultural Handbook Number 66* (K. C. Gross, C. Y. Wang, and M. Saltveit, Eds), 2002 (revised in 2004) ([www.ba.ars.usda.gov/hb66/index.html](http://www.ba.ars.usda.gov/hb66/index.html)).
114. A. E. Watada. Effect of ethylene on the quality of fruits and vegetables. *Food Technol.*, 40(5):82, 1986.
115. A. E. Watada, R. C. Hermer, A. A. Kader, R. J. Romani, and G. L. Staby. Terminology for the description of developmental stages of horticultural crops. *HortSci.*, 19(1):20, 1984.
116. C. B. Watkins and W. B. Miller. A summary of physiological processes or disorders in fruits, vegetables and ornamental products that are delayed or decreased, increased or unaffected by application of 1-methylcyclopropene (1-MCP). ([www.hort.cornell.edu/department/faculty/watkins/ethylene](http://www.hort.cornell.edu/department/faculty/watkins/ethylene)).

117. R. D. Way and M. R. McLellan. Apple cultivars for processing. In *Processed Apple Products* (D. L. Downing, Ed.), Van Nostrand Reinhold, New York, 1989, p. 1.
118. P. Wehling. Quality and breeding-cultivars, genetic engineering. In *Fruit and Vegetable Quality, An Integrated View* (R. L. Shewfelt and B. Bruckner, Eds), Technomic Publishing Co., Pennsylvania, 2000, p. 21.
119. R. C. Wiley and C. R. Binkley. Apple sauce and other canned apple products. In *Processed Apple Products* (D. L. Downing, Ed.), Van Nostrand Reinhold, New York, 1989, p. 215.
120. R. H. H. Wills, W. B. McGlasson, D. Graham, and D. Joyce. *Postharvest: An Introduction to the Physiology and Handling of Fruit Vegetables and Ornamentals*, New South Wales University Press, Sydney, 1998.
121. G. W. Winsor. Some factors affecting quality and composition of tomatoes. *Acta Hortic.*, 93:35, 1979.

# 3

## *Postharvest Handling and Treatments of Fruits and Vegetables*

Vijay Kumar Mishra and T.V. Gamage

### CONTENTS

3.1	Introduction .....	49
3.2	Postharvest Handling Operations .....	50
3.2.1	Sorting and Grading .....	50
3.2.2	Packaging .....	51
3.2.2.1	Types of Damage .....	51
3.2.2.2	Cushioning and Other Protections .....	52
3.2.3	Transportation .....	52
3.2.4	Precooling .....	53
3.2.4.1	Methods of Precooling .....	53
3.2.5	Storage and Distribution .....	56
3.3	Postharvest Treatments .....	59
3.3.1	Physical Treatments .....	59
3.3.1.1	Cleaning and Washing .....	59
3.3.1.2	Coating and Waxing .....	59
3.3.1.3	Heat Treatment .....	60
3.3.1.4	Irradiation .....	62
3.3.2	Chemicals Treatments .....	63
3.3.2.1	Disinfestation and Decay Control .....	64
3.3.2.2	Ethylene Removal .....	66
3.3.2.3	Controlled Ripening and Color Development .....	67
3.3.2.4	Delaying Ripening, Senescence, and Sprouting .....	67
3.3.2.5	Treatment with Calcium and Divalent Cations .....	69
3.3.2.6	Treatment with Antioxidants .....	69
	References .....	69

### 3.1 Introduction

The quality of fruits and vegetables deteriorates progressively after harvest within short time owing to a series of physical, physiological, and pathological agents the produce is exposed to before reaching a consumer or a processor. Normally, quality at harvest can only be maintained and not improved down the value chain except for climacteric fruits, which can be ripened after harvest to achieve ideal eating quality. Handling operations vary according to the produce. Figure 3.1 depicts a generic postharvest value chain with common handling operations. Both quantitative (reduction in weight and wastage due to biotic factors) and qualitative (reduction in color, flavor, and texture) losses anywhere along the chain occur in field, during packaging, storage, distribution, and transportation. Postharvest management practices facilitate continuous supply of fruits and vegetables to fresh, minimally processed, and processed markets. Given the distance between the sites of production and consumption these perishable commodities need to travel,



the maintenance of quality over the entire value chain is an onerous task. Generally, fruits and vegetables processing is very seasonal in nature, and the harvested produce must be quickly processed to avoid losses. Processor must assure that all the quality attributes at the time of harvest are maintained before processing.

A good-quality processed product can only be possible when good-quality raw materials are used in their manufacture. Only those cultivars that are suitable for a particular process application are procured. Cultivars suitable for table-fresh markets are very different from those that are suited for processing. Generally, the produce is harvested at the stage when the eating quality is at its peak as this commands maximum market revenue. Quality specifications vary according to the raw material required for a given processing application and often include optimum color, texture, and flavor; freedom from pathogens and spoilage microorganisms, including their metabolic products; freedom from toxic residues such as pesticides; reasonable storage life; high nutritive value; and extended availability. Table 3.1 lists the quality specification requirements for various fruits and vegetables processed into various products.

## 3.2 Postharvest Handling Operations

### 3.2.1 Sorting and Grading

Most fruits and vegetables are sorted and graded for marketing and have a role in protecting and enhancing product quality. These are generally an important part of field or packinghouse operations and help in reducing cross contamination of healthy stock destined for storage, transport, distribution, marketing, and processing. Immediately after harvest, the produce is sorted according to size, shape, color, and appearance. The damaged and immature fruits must be removed, as these might become sources of ethylene gas, which will increase the rate of respiration, ripening, and senescence of healthy produce. Many products are sorted according to color, mass, profile, and size after passing the minimum requirements of quality.

Grading determines whether the product meets a specific quality standard prescribed by local or international market, separates products into different quality grades to determine the price paid to the farmers or to determine the sale value, and enables removal of off-grade products, which include damaged,

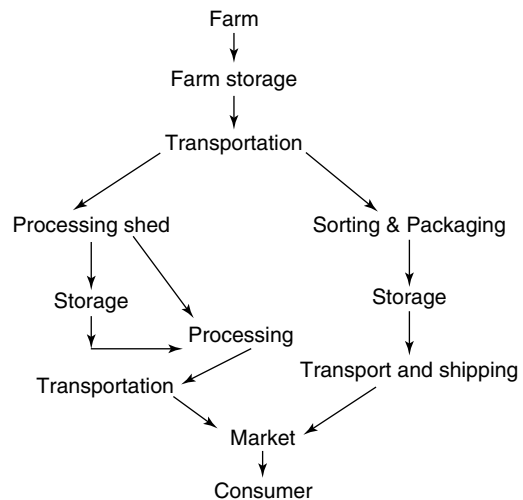


FIGURE 3.1 Postharvest value chain for fruits and vegetables.

TABLE 3.1

Raw Material Quality Specifications for Processed Fruits and Vegetables

Processed Products	Raw Materials	Quality Specifications
Fruit juices	Citrus, apple, tomato	Acidity, sugar content, flavor
Chips and fries	Potato, banana, taro	Texture, starch content, and reducing sugars
Canned products	Apple, peach, pear	Color, texture, flavor
Preserves	Various fruits: apple, peach	Sugar, pectin content, acidity
Pickles	Cucumber, olive, cabbage	Composition, sugar content, texture
Concentrates: sauce, puree	Tomato, apple	Total solids
Alcoholic beverages	Grape, apple	Fermentable sugar, acidity
Dried products	Mango, apricot	Composition, solid content
Frozen products	Pea, carrot, onion	Composition, color, texture, flavor

undersized, immature, and diseased produce. Grade standards vary between and within countries, and local authorities should be consulted for updates. Minimum requirements for sale of apples in Australia for purposes other than processing specify that the product must be intact, sound, mature (except for green varieties marked “Cooker”), and clean and free from foreign taste or smell for all three classes of apples marketed [48]. Optimal maturity, color, sugar, solids, moisture content, size, and absence of defects are some of the factors considered for various fresh market products. The domestic marketing orders of the USDA specify mandatory grades for avocados, Irish potatoes, limes, filberts, raisins, onions, table grapes, walnuts, kiwifruit, dates, prunes, canned ripe olives, grapefruits, tomatoes, and oranges [49].

Traditionally, sorting and grading are done by hand, which is extremely labor-intensive. Labor shortages and a lack of overall consistency have driven the search for automation of this operation. Color is a key sorting parameter used in the implementation of many automated vision systems that involve image acquisition and processing. Optical methods used in grading and sorting have been described by Thomson [74]. Optical sorting is currently being used for apples destined for canning in Australia. Magnetic resonance spectroscopy and imaging, near-infrared spectroscopy, acoustic response, and impact response are being investigated for their utility in automated sorting and grading of produce. Equipment used in dumping, conveying, and grasping during sorting and grading should have smooth and properly cushioned surface to avoid injury.

### 3.2.2 Packaging

Packaging contributes greatly to efficient marketing of fruits and vegetables as it (i) serves as an efficient handling unit; (ii) provides convenient warehouse or home storage unit; (iii) protects quality and reduces waste by avoiding mechanical damage, reducing moisture loss, providing beneficial modified atmosphere, providing clean or sanitary produce, and preventing pilferage; (iv) provides service and sales motivation; (v) reduces cost of transport and marketing; and (vi) and facilitates use of new modes of transportation [28].

Two types of packaging are common in fresh produce trade. Large-sized containers are used for transport and wholesale, and small-sized packagers for retail trade. The use of properly designed containers for transporting and marketing can maintain the produce’s freshness, succulence, and quality by significantly reducing mechanical damage during handling, transport, and storage.

Proper packaging can protect fresh produce from the environment, such as sunshine, moisture, and light. The main purpose of packaging is to provide protection from mechanical damage. The container must be strong enough to withstand stacking and impact of loading and unloading, without bruising or scarring the produce. Thus, containers may require use of liners, pads, trays, or tissue wraps to prevent damage from contact with rough surfaces or adjacent produce.

The produce can be packed in a box (wooden or paper) with absorbent, lining, or padding materials or in bags. The choice of packaging material is based on the requirements of stacking height, duration of storage, pretreatments, cooling, and cost. Lug and pallet boxes are also used. Pallet boxes are used for bulk handling, which saves loading and unloading time and manual labor [62].

#### 3.2.2.1 Types of Damage

The fresh produce is mechanically or manually handled several times on packing lines before they arrive at the point of consumer purchase. Mechanical damage occurs in the postharvest handling system primarily by impact forces and compressive forces. The compressive forces act on the product when it is handled in bulk and are normally static loads (in bins and stacks) or dynamic compressive loads (bin handling and transport). The excessive impacts occur during harvesting, grading, handling, and transportation, and excessive compression loads occur during bulk handling and package handling. In terms of severity of impacts, handling systems may be classified into two broad categories: low-energy systems (<0.9 J) such as for apples and stone fruits, and high-energy systems (~1.5 J) such as for potatoes.

Bruising results from fruits hitting each other during transportation and handling, and from contact with hard surface of machinery, container, or other handling equipment. Bruising causes enzymatic browning in apples, pears, peaches, apricots, grapes, and bananas. Campbell et al. [19] determined that up to 40% of the tomato crop sustained mechanical damage during handling system. They also found that one-third of the damage occurred at harvest and was related to bin design and filling techniques.

The bins were found to be too deep and overfilled, both of which resulted in compression damage to the fruit. In case of apples, most bruising occurred due to excessive compressive forces. This was exacerbated by transportation on short-tined forks, at the rear of the trailers and on heavy-duty leaf-sprung trucks traveling on unsealed roads [18]. Bollen et al. [16] found that rejection-level bruising occurred at locations near the bin edge and center bottom, and was highly dependent on bin condition and transport duration. The fruits in the middle of the bin experience bruising to a nonreject level in both transport and bin condition regimes. Bruising was considerable at the top of the bin near the sides and was likely to be due to impact damage, since bin condition and transport duration have little influence on damage levels.

Compression damage is the primary cause of damage to fruit while it is handled in bulk. The force on the product is transferred from the vehicle transporting the bin to the produce. The energy is dissipated through movement of the product and absorption by the produce. The severity of the levels of bruising resulting from bulk handling has been reported in various studies. The forces vary considerably within bins according to the load paths owing to produce-stacking pattern. This loading pattern is also influenced by the bin design and the transport method [55].

### 3.2.2.2 *Cushioning and Other Protections*

Packing line equipment and other harvesting and postharvest handling equipment are traditionally designed and installed using many transfers from one operation to the next. During this handling, the produce hits (impacts) hard surfaces or other produce. Cushioning and velocity control devices can be chosen that will avoid bruising in handling systems. A cushioning material must provide effective energy absorption and dissipation and not create the critical stress/strain level in the produce tissue that will initiate bruising. Bruising can be caused by intermittent shocks, compressive forces, or prolonged low-level vibrations occurring during transportation of produce from the orchard or field to the packing-house, and from the packing-house to the retail store [10]. The packing line should be designed to appropriate drop height or roll velocity. If hard surfaces on the equipment are adequately cushioned, and the roll velocity of each item is controlled to a low-enough level, impact bruises can be avoided.

Immobilization and proper cushioning of the produce help in reducing damage due to cuts, punctures, bruises, abrasion, impact, and friction. This can be done by various types of trays, or by certain volume-fill techniques, such as padding or cushioning [62]. The material used for padding should have the following properties: (i) ability to absorb the impact energy without damaging the produce, (ii) should not impart a high rebound energy to the produce, (iii) durability by internal structure fatigue and surface wear (needs lower thickness), (iv) cushion cleanup, sanitation, and compatibility with water, fungicides, waxes, and cleaning solutions must be excellent, and (v) the cushion physical properties (thickness and stiffness). The materials that can be used are PVC, polyethylene, neoprene, polyurethane, wool carpet, polypropylene, poron, or no bruze. The materials are usually made with porous internal structure and specific surface characteristics [10,15]. The commonly used padding materials are leafs, straw, grass, coconut husk, paper, and plastics.

Plastic films, mesh, or net and plastic-lined paper may also be used to prepackage fresh produce. Individual seal packaging or unipackaging creates a water-saturated atmosphere around the fruit and reduces water loss and shrinkage. The advantages are (i) it may be an alternative to expensive traditional refrigeration and sophisticated controlled atmosphere (CA) storage, (ii) it doubles and sometimes triples the shelf life as measured by appearance, firmness, shrinkage, weight loss, and other keeping qualities, (iii) it also delays physiological deterioration better than when only cooling is used, and (iv) it may reduce chilling injury in some fruits, such as in citrus. Films used in packages may be used as carriers of fungicides to reduce toxic residue in products and ethylene-absorbing substances to delay ripening. Perforated films can be used to allow optimum gas exchange rates and avoid accumulation of ethylene in the enclosed microatmosphere [26,31]. Perforated films are more suited to high O<sub>2</sub> demand produce. The limitation of using seal packaging is the possibility of development of off-flavors caused by poor gas exchange and enhancement of decay and spoilage due to the phytotoxic microatmosphere (low oxygen, excessive carbon dioxide, and ethylene).

### 3.2.3 *Transportation*

The harvested produce is transported to the packing and processing sheds inland via road by trucks in pallet boxes with capabilities of carrying 800–1000 lb. Bulk trucks are used for fruits, such as oranges,

and vegetables. Overseas transportation is normally by sea and rarely by air. Proper management of temperature, humidity, and ventilation is the main requirement. It is advised that bruised, decayed, and overripe products are sorted out before transportation to avoid dissemination of diseases, induction of ethylene gas, increase in respiration and evolution of heat, and loss of water. Severe mechanical injuries in the form of bruises, cuts, impact, compression, and vibration occur during transportation, leading to deterioration of quality and reduced shelf life. Proper packaging of produce helps in avoiding mechanical injuries. When large-sized products, such as watermelons, muskmelons, pumpkins, yams, and cabbages, are transported in bulk using trucks, trolleys, or lorries, products should be carefully stacked and adequately covered to protect from the environment.

Refrigeration during transportation is convenient and the most effective means of reducing losses. Proper insulation and ventilation of trucks help in minimizing loss of quality in the absence of truck without refrigeration. Following measures have been suggested to minimize heat accumulation during transportation of fruits and vegetables [6]: (1) avoiding closed vehicles without refrigeration except for local deliveries, (2) fitting open-sided or half-boarded trucks with roofing and siding to protect produce from direct sun and wind exposures, (3) fitting a second white-painted roof 8–10 cm above the main roof to act as a radiation shield, (4) provision for air intake in conjunction with louvers in unrefrigerated vehicles used in long-distance transport to ensure positive airflow through the load, and (5) equipping transport vehicles such as trucks, railcars, and sea containers with refrigeration for long journeys.

Overfilling of boxes can cause compression bruises, which makes bruised fruits more prone to decay than those affected by impact bruises. Vibrations lead to friction bruises, which lead to browning of pears. The produce must be protected against mechanical injuries using proper packages and suitable padding materials. Another important consideration is to make sure that only compatible fruits and vegetables are transported together. Table 3.2 provides the listing of commodities that are compatible during transportation and storage.

### 3.2.4 Precooling

Good temperature management throughout the postharvest chain is the key to avoiding postharvest losses and preservation of quality. Rapid cooling of the produce to safe storage or transportation temperature is imperative in preservation of quality and to increase the shelf life by arresting the deteriorative changes caused by physiological and pathological agencies. The harvested produce contains substantial amount of heat associated with the product temperature and is known as field heat, a significant part of cooling load. Precooling is the rapid extraction of heat from the produce before transport, storage, and processing. Depending on the temperature, the product will lose its quality in no time unless promptly and appropriately cooled. Precooling assists in maintaining quality by reducing the rates of metabolic activities such as respiration, transpiration, and ethylene production; minimizing growth of decay microorganisms; and easing the load on cooling system downstream [62] for storage. Improved flexibility in marketing is an additional benefit.

The amount of field heat necessary to be removed depends on the produce and the required storage temperatures. At the time of harvest, the produce temperature is same as that of the environment; wherever possible, the produce must be harvested when the ambient temperature is low, during night, morning, or evening, to avoid high cooling loads. The amount of heat to be removed can be estimated by methods described in several publications [4] or from the compositional data [66].

#### 3.2.4.1 Methods of Precooling

Precooling can be accomplished by simply blowing cold ambient air over the produce; however, refrigeration is required for ensuring short cooling time that is so critical in preventing the loss of quality. Cooling rates depend on the type of product, its size, weight, and the surface-to-volume ratio. A small-sized product with a large surface area-to-volume ratio cools at a faster rate. Cooling rates are often expressed in several half-cooling times and can be used for comparing and predicting the effectiveness of different cooling methods for a given cooling time interval irrespective of the temperature of the produce or cooling medium used. Half-time is the time required to reduce the temperature difference between the product and the cooling medium by one half. Figure 3.2 shows a typical cooling curve for

TABLE 3.2

Compatibility Groups for Transport and Storage of Fresh Fruits and Vegetables

Group	Temperature (°C)	RH (%)	Commodity
1	0–2	90–95	Apple, apricot, beets (topped), berries (except cranberries), cashew apple, cherries, coconut, fig (not with apples), grapes (without sulfur dioxide), horseradish, kohlrabi, leek, longan, loquat, lychee, mushrooms, nectarines, orange, <sup>a</sup> parsnip, peach, pear, persimmon, plum, pomegranate, prune, quince, radish, rutabaga, turnip
2	0–2	95–100	Amaranth, <sup>b</sup> anise, <sup>b</sup> artichokes, <sup>b</sup> asparagus, bean sprouts, beets, <sup>b</sup> Belgian endive, berries (except cranberries), bok choy, broccoli, <sup>b</sup> brussels sprout, <sup>b</sup> cabbage, <sup>b</sup> carrot, <sup>b</sup> cauliflower, celeriac, <sup>b</sup> celery, <sup>b</sup> cherries, corn (sweet), <sup>b</sup> daikon, <sup>b</sup> endive, <sup>b</sup> escarole, <sup>b</sup> grapes (without sulfur dioxide), horseradish, Jerusalem artichoke, kiwifruit, kohlrabi, <sup>b</sup> leafy greens, leek <sup>b</sup> (not with figs or grapes), lettuce, lo bok, mushrooms, onions <sup>b</sup> (green not with figs, grapes, mushroom, rhubarb, or corn) parsley, <sup>b</sup> parsnip, <sup>b</sup> peas, <sup>b</sup> pomegranate, raddichio, radish, <sup>b</sup> rhubarb, rutabagas, <sup>b</sup> salsify, scorzonera, snow pea, spinach, turnip, <sup>b</sup> water chestnut, watercress
3	0–2	65–75	Garlic, onion (dry)
4	4.5	90–95	Cactus leaves, cactus pear, caimito, cantaloupe, <sup>b</sup> clementine, cranberries, lemon, <sup>a</sup> lychee, kumquat, mandarin, <sup>a</sup> oranges (California and Arizona), pepino tamarillo, tangelos, <sup>a</sup> tangerines, <sup>a</sup> ugli fruit, <sup>a</sup> yucca root
5	10	85–90	Beans, calamondin, chayote, cucumber, eggplant, haricot vert, kiwano, malanga, okra, olive, peppers, potato, pummelo, squash (summer and soft shell), tamarind, taro root
6	13–15	85–90	Atemoya, avocado, babaco, banana, bitter melon, black sapote, boniato, breadfruit, canistel, carambola, cherimoya, coconut, feijoa, ginger root, granadilla, grapefruit, guava, jaboticaba, jackfruit, langsat, lemon, <sup>a</sup> lime, <sup>a</sup> mammy, mango, mangosteen, melons (except cantaloupes), papaya, passion fruit, pineapple, plaintain, potato (new), pumpkin, rambutan, santol, soursop, sugar apple, squash (winter, hard shell), tomatillo, tomato (ripe)
7	18–21	85–90	Jicama, pear (for ripening), sweet potato, tomato (mature green), watermelon, white sapote, yam

Group 1: Many products produce ethylene.

Group 2: Many products are sensitive to ethylene.

Group 3: Moisture damages these products.

Groups 4, 5 and 6: Many products are sensitive to ethylene and chilling injury.

Group 6: Produce ethylene and sensitive to chilling injury.

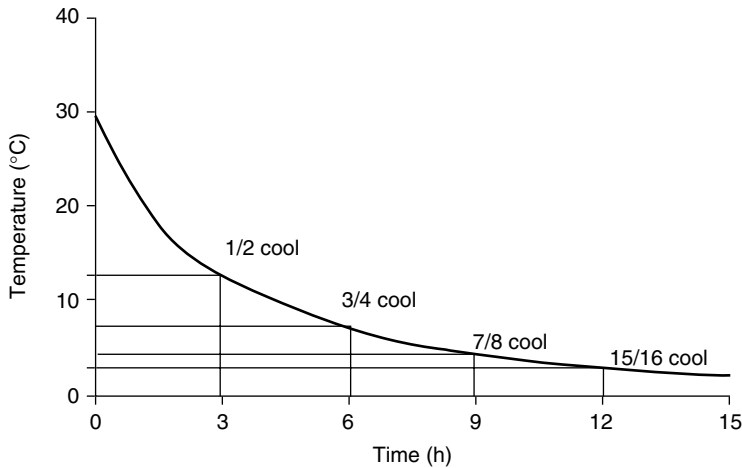
Group 7: Separate sweet potato, white sapote and yam from pears and tomatoes owing to ethylene sensitivity.

<sup>a</sup> Citrus fruits treated with biphenyl may give odors to other products.

<sup>b</sup> Can be top iced.

Source: Adapted from M. McGregor, *Tropical Products Transport Handbook*, USDA Office of Transportation, Agricultural Handbook 668. 1999 (<http://www.ams.usda.gov/tmd/Tropical/index.htm>).

a product being cooled from an initial temperature of 30°C by air maintained at 2°C. As cooling progresses, the rate of cooling slows down. The curve shows several half cooling periods in terms of three half cooling periods corresponding to 1/2, 3/4, and 7/8 cooling. The 7/8 cooling time is generally considered adequate for transport and storage of most commodities. The essential information required for design and operation of coolers has been given in several publications [34,51,52,76,81].



**FIGURE 3.2** Typical cooling curve showing half cooling times for fruits and vegetables.

The most commonly used methods of precooling are described below:

(a) Room cooling

This method involves using cold air as a medium to extract heat from the produce. Air is cooled by a refrigeration system. For efficient heat removal, the produce container should be well vented and stacked so that the container surface is in contact with cold air and the storage space is utilized to the maximum extent. Since the rate of heat removal by still air is slow, it takes longer to cool a produce to a safe transit or storage temperature. High relative humidity (90%–95%) is maintained in the air to avoid desiccation and weight loss during cooling. The method is not recommended for produce packed in bulk.

(b) Forced air or pressure cooling

This is a modification of room cooling where cold air is forced through the produce containers and around the produce to speed up cooling. Fans specially positioned in the room create the pressure differential to circulate air. Cooling time depends on the speed of the airflow, provided sufficient refrigeration capacity is available for a given duty. The problems of moisture condensation on the produce, package, and the wall are eliminated due to air movement. Cooling times can be significantly reduced and cooling accomplished in 10%–25% less time compared to room cooling. Forced air cooling is accomplished by using three systems: cold wall, forced air tunnel, and serpentine cooling.

(c) Package icing

This method of cooling involves keeping a finely crushed, flaked ice, and ice–water mixture in direct contact with the produce for cooling and maintaining low temperatures during short-time storage, transit, and display in superstores. The latent heat of melting of ice (334 kJ/kg) provides the cooling effect. The use is limited for products that can tolerate both weight of the ice and water that wets the product and the package. Use of ice slurry is recommended to avoid mechanical damage due to sharp-end ice. It is commonly used for cooling spinach and broccoli during transport and retail displays.

(d) Hydrocooling

Hydrocooling is a rapid way to cool large batches of product by spraying or flooding the commodity with near-freezing water ( $\sim 0^{\circ}\text{C}$ ). Water, being liquid, is a superior heat transfer medium than air due to its large heat capacity. Near-freezing water cools the product about 15 times faster than air, allowing for greater harvesting and marketing flexibility. There is no desiccation of the product. However, water may be a source of contamination if soil and debris picked up during cooling are not removed before recycling. Water needs to be appropriately filtered and disinfected. Chlorination is the most commonly used method to control infection

due to microorganisms. Maintenance of high level of chlorine (50–200 ppm) and continuous monitoring of the chlorine concentration are highly recommended to avoid contamination. Hydrocooling is best suited for medium- to large-scale cooling of product and the packages that are both water- and chlorine-tolerant.

(e) Vacuum cooling

Cooling effect is generated by partial evaporation of moisture directly from the product, which is placed in a chamber and vacuum is drawn. Evaporation results from reduction in the vapor pressure of water under vacuum. The method does not require any cooling medium as in other methods of precooling, for example, air in forced cooling or water in hydrocooling. The reduction in product temperature for a unit percent weight loss can be determined by the ratio of the latent heat of vaporization and heat capacity of the produce. Wang and Sun [79] calculated a reduction of 6.5°C/1% weight loss for leafy vegetables containing 90% moisture. These researchers also reported an extension of shelf life of 2.5 days at 12°C for head lettuce, which were cooled for 20 min, sealed in polypropylene film and stored for a week at 2°C. This method can be used to precool products that have high surface-to-mass ratio, freely available water, highly porous nature, and whose structure will not be damaged by the removal of water. It is ideally suited for head lettuce and mushrooms [5]. The product may encounter a weight loss of about 3%–4%; however, adding preselected amount of water before or during precooling can prevent weight loss [79].

(f) Evaporative cooling

This is a relatively inexpensive method suitable to precool produce that require relatively warmer storage temperatures, such as tomatoes and cucumber. This method is based on the cooling effect created by evaporation of water when dry air is blown over the wet product. In the process of evaporation, water absorbs latent heat of vaporization (2260 kJ/kg) from dry air to change its phase from liquid to vapor. The method is suited to areas where low ambient humidity (<65% RH) air is readily available.

The choice of an appropriate cooling method is a very important decision that a grower or a packinghouse needs to make. The decision is based on the following factors [35]: (i) nature of the product to be cooled (e.g., chilling sensitivity), (ii) temperature of the produce at the time of harvest, (iii) cooling time required, (iv) product throughput, (v) type of packaging used, (vi) desired storage life, and (vii) other considerations such as comparative energy efficiency, availability, and associated capital and operating costs. Highly perishable fruits such as strawberries, bush berries, and apricots need be cooled to their optimum storage temperature (0°C) in relatively shorter time (within 6 h of harvest) than most other fruits (within 12 h of harvest) [33]. The multiple precooling options may also be feasible for better quality [23]. Thompson [76] has provided a comparison of common methods of precooling based on cooling time, moisture loss, water contact with the product, potential for decay contamination, capital cost, energy efficiency, need of water-resistance packaging, portability, and feasibility of in-line cooling. Precooling methods suitable for selected fruits and vegetables are given in Table 3.3.

**TABLE 3.3**

Recommended Precooling Methods for Selected Fruits and Vegetables

Fruit or Vegetable	Precooling Methods Used
Asparagus	Hydrocooling, package icing
Apple	Room, forced air, and hydrocooling
Apricot	Room and hydrocooling
Beans, snap	Room, forced air, and hydrocooling
Broccoli	Package icing, forced air, and hydrocooling
Brussels sprout	Hydrocooling, vacuum, and package icing
Cabbage	Room, forced air cooling
Cauliflower	Hydrocooling and vacuum cooling
Cherries	Hydro- and forced air cooling
Cucumber	Forced air and hydrocooling
Grapes	Forced air cooling
Lettuce	Hydrocooling and package icing
Pea	Forced air and hydrocooling
Potato	Forced air and hydrocooling
Peach	Forced air and hydrocooling
Pear	Room, forced air and hydrocooling
Spinach	Hydrocooling and package icing
Tomato	Room and forced air cooling

### 3.2.5 Storage and Distribution

Most horticultural produce have short harvesting season, and short- or long-term storage is necessary not only to extend the marketing period for fresh produce but also to regulate the product flow and extend the

TABLE 3.4

Storage Potential of Horticultural Produce in Air at Near-Optimum Storage Temperature and Relative Humidity

Class	Storage Life (Weeks)	Degree of Perishability	Commodity
I	<2	Very high	Apricot, blackberry, blueberry, cherry, fig, raspberry, strawberry, asparagus, bean sprouts, broccoli, cauliflower, green onion, leaf lettuce, mushroom, muskmelon, pea, spinach, sweet corn, tomato (ripe)
II	2–4	High	Avocado, banana, grape, guava, loquat, mandarin, mango, melons, nectarine, papaya, peach, plum, artichoke, green beans, brussels sprouts, cabbage, celery, eggplant, head lettuce, okra, pepper, summer squash, tomato (partially ripe)
III	4–8	Moderate	Apple and pea (some cultivars), grape (sulfur dioxide treated), orange, grapefruit, lime, kiwifruit, persimmon, pomegranate, table beet, carrot, radish
IV	8–16	Low	Apple and pear (some cultivars), lemon, potato, dry onion, garlic, pumpkin, winter squash, sweet potatoes, taro, yam
V	>16	Very low	Tree nuts and dried fruits

Source: Data from A.A. Kader, *Postharvest Technology of Horticultural Crops*, University of California, Publication 3311, Davis, 1992.

processing season [33]. The main objectives of storage are (i) to extend the availability of fresh produce in the market, (ii) to ensure continuous supply of quality raw material to the processors, (iii) to extend the length of the processing season, (iv) to hold raw material obtained during favorable price situations, (v) to condition certain commodities such as potatoes, onions, and garlic, and (vi) to ripen certain fruits such as mangoes and bananas [59].

Storage requirements vary among fruits and vegetables. Based on storage potential, Kader [32] classified them into five groups (Table 3.4) based on the rates of respiration and ethylene generation, and perishability. Storage life of <2 weeks to >16 weeks may be observed depending on the commodity. For example, green onions are highly perishable with <2 weeks of storage life compared with 8–10 weeks for dried onions. Variations do exist between and within fruits and vegetables and their cultivars. The storage potential of onions follows the order: yellow > red > white > Spanish and sweet [1]. Most vegetables, except root and tuber crops, are consumed fresh and do not require storage for sufficient length of time unless used as raw materials for processing. For some vegetables, the time elapsed between harvesting to consumption or processing is the only storage. In contrast, vegetables, such as potato, yam, sweet potato, garlic, and ginger, can be kept *in situ* for several months after they attain maturity and are removed from storage environments before the rainy season to prevent rotting and sprouting. *In situ* storage for these vegetables is easy and economical due to limited expenditure and fabrication for storing. The underground storage in pits and trenches by mounting soil on the surface is most suitable for short-term storage. Hay or straw, and then soil are used to protect the surface from water leakage and freezing. Pits are used for storing beet, potato, carrot, turnip, cabbage, parsnip, etc. The disadvantages of underground storages include expensive labor, variable climatic conditions, and adverse weather such as cold and wet [29,30].

Refrigerated or cold storage has established itself as the most accepted storage method all over the world. Its use is determined by cost and benefit considerations. Scientific storage is based mainly on maintenance of low temperature, high humidity, and hygienic environment. However, the CA storage of apples and pears is now commercial reality and its use is expected to increase in the near future. Very low storage temperatures that induce chilling and freezing injuries, and keeping commodities that do not tolerate each other must be avoided. Storage life of selected fruits and vegetables at given temperature and humidity is



TABLE 3.5

Optimum Storage Temperature and Humidity Conditions for Fresh Fruits and Vegetables

Produce	Optimum Temperature (°C)	Freezing Temperature (°C)	RH (%)	Storage Life
Apple	-1 to 4.4	-1.7	90-95	1-12 months
Asparagus	2.2	-1.1	95-100	2-3 weeks
Blueberries	0.6-1	-2.2	90-95	2-3 weeks
Broccoli	0	-0.6	95-100	2 weeks
Cabbage	0	-1.1	95	2-3 months
Cucumber	7.2-10	-0.6	95	2 weeks
Eggplant	7.8-12.2	-0.6	90-95	1 week
Green beans and field peas	2.8-7.2	-0.6	95	5-10 days
Leafy vegetables	0	-1.1	95	1-2 weeks
Onion	0	-0.6	70	2-3 months
				6-8 months in CA
Peach	0	-0.6	95-98	2-4 weeks
Peppers	7.2-10	-0.6	90-95	2-3 weeks
Potato	3.3-4.4	-0.6	90-95	5-8 months
Strawberry	0	-0.6	90-95	5-7 days
Sweet corn	0	-0.6	90-98	5-7 days
Sweet potato	12.8	-0.6	90	6-12 months
Tomato, pink	8.9-10		85-95	7-14 days
Turnip	0	-1.1	95	4-5 months
Watermelon	10-15.6	-0.6	90	2-3 weeks

Source: Data from L.G. Wilson, M.D. Boyette, and E.A. Estes, Postharvest handling and cooling of fresh fruits, vegetables, and flowers for small farms. Part II Cooling, Horticulture Information Leaflet 801, North Carolina State University, North Carolina A&T State University, 1999 ([www.ces.ncsu.edu/depts/hort/hil/pdf/hil-801.pdf](http://www.ces.ncsu.edu/depts/hort/hil/pdf/hil-801.pdf)).

given in Table 3.5. In general, commodities store well above the chilling injury threshold temperatures for tropical and subtropical fruits and above the freezing point for temperate fruits. Comprehensive compilation of storage information in terms of optimum temperature, humidity, and modified or controlled atmospheres can be found in Refs. [3,4,27,28,32,36,56,60,62,74]. The Optimal Fresh Database developed by the Sydney Postharvest Lab and Food Science Australia [54] presents information on refrigerated container/cold room recommendations, produce properties (freezing point, humidity, storage time at ambient and at optimal temperatures), suitability and conditions for CA storage, respiration and heat transfer, compatibility in mixed storage, and seasonal availability for many fruits and vegetables.

Rooms used for cold storage should be properly designed for a given locality. The design should provide adequate insulation, working space, vapor barrier, and doors that disallow ingress of air from outside. Good air circulation is required to assure uniform temperature and humidity in the room. A minimum clearance of 100 mm should be kept from the walls and floors and between pallets while stacking the produce [13]. An efficient operation of storage system involves acceptance of only high-quality produce for storage; rapid cooling of the produce to the storage temperature; storing only compatible mixed load; maintenance of recommended temperature, humidity, and gaseous atmospheres; precise monitoring and control of temperature and humidity; and efficient product movement to avoid excessive storage [83].

The refrigeration system required for maintaining cold storage conditions requires realistic calculation of refrigeration load for a given situation. The components of refrigeration load include transmission (heat gained through structure), product, internal (lights and motors), infiltration of air, and related equipment. *ASHRAE Handbook* [4] provides details of methods used for the estimation of refrigeration capacity.

Often it is necessary to store or transport several types of produce at once. The problems created by shipping incompatible commodities together may be quite severe. The factors that determine the compatibility of products are (i) temperature, (ii) relative humidity, (iii) production of ethylene, (iv) sensitivity to ethylene, (v) production and absorption of objectionable odors or flavors, and (vi) difficulties in loading shipping containers or stores of different sizes and shapes [20,62]. Compatibility groups for storage of fruits and vegetables are given in Table 3.2.

Starch content of potatoes decreases by 30% in 2–3 months of cold storage at 1°C–3°C due to starch hydrolysis [64]. When the concentration of reducing sugars increases to >0.1% in the tissue, such potatoes are unsuitable for processing into chips due to their tendency to cause browning and blackening during cooking [77]. Warming of such potatoes to room temperature before cooling helps in controlling this problem.

In the CA method, the produce is placed in an airtight room, and gas compositions (O<sub>2</sub> and CO<sub>2</sub>) of room atmosphere are continuously maintained at the desired level for best quality. It is commercially used in Australia for long-term storage of apples and pears. The details of this technique are given in several references [27,75,83].

---

### 3.3 Postharvest Treatments

Postharvest treatments generally aim at preserving and/or enhancing the quality of fruits and vegetables by controlling the physiological, mechanical, and pathological agents responsible for both postharvest losses and degradation of quality. These may be described as physical and chemical treatments.

#### 3.3.1 Physical Treatments

##### 3.3.1.1 Cleaning and Washing

The main goals of cleaning are (i) to eliminate surface dirt and soil particles and contaminants, (ii) to remove residues of pesticides, fertilizers, and chemicals used during production, (iii) to reduce the microbial load, and (iv) to enhance the appearance of the produce. Cleaning can be accomplished using air (dry) or water (washing). Dry brushing with or without air blast may be used to remove loose scales, soil, or dust in products such as onions, garlic, potato, sweet potato, cantaloupes, and melons.

The effectiveness of the washing depends on the amount of water used, characteristics of water (acidity, hardness, mineral content, temperature, and the initial level of contamination), force applied, use of brushing and rubbing aids, etc. Washing is not an effective method for removing fungi from the infected tissues and may even predispose produce to decay organisms and deplete the protective wax layer [2]. Washing may also lead to a water-soaked appearance and moisture penetration, which may aid in pathogen access through the wounds. This is the reason why strawberries, mushrooms, cucumber, and cherries are not generally washed. The water used for cleaning should be of acceptable quality and must be filtered and sanitized before reuse. If the fruit is excessively dirty a detergent may be used prior to sanitizing treatment. The final rinse should be carried out using clean water. Removal of excess surface water by blotting rollers or blowing air over fruits may be necessary to avoid infection and subsequent decay in stone fruits and potatoes [62].

##### 3.3.1.2 Coating and Waxing

Presence of surface wax is a natural defense mechanism in fruits and vegetables against water loss and invasion from pests and disease-causing organisms. Rough handling, approaching senescence, and washing deplete natural waxes. Surface coating using wax or hydrophobic substances has been used since ancient times to improve the appeal and acceptability by the consumer, and the ease of packing and handling; and to extend the shelf life by reducing weight (water) loss. Retention of color, firmness, and flavor and the prevention of loss of weight result from (i) reduction in the rates of respiration and transpiration, (ii) protection from insects, pests, and fungi that cause diseases and deterioration, (iii) generation of a local modified atmosphere, (iv) protection from mechanical injuries, and (v) curing tiny injuries and scratches on the surface [2,62]. Significant economic benefits accrue by waxing owing to resultant water-loss reduction to an extent of 30%–50% in normal commercial handling and storage conditions [83]. However, coating may not be always favorable as modification of the internal atmosphere can reduce the available oxygen leading to fermentation, which can be precluded by only a thin layer of wax to allow gas exchange through it. The literature related to coatings has recently been reviewed by Baldwin [11].

Commercial formulations used in coating consist of long-chain fatty alcohols, synthetic resins, chitosans, and other sugar derivatives as active coating agents, and substances to assist in coating, for example, emulsifying and wetting agents. Commonly used waxes for coatings are Carnauba, Shellac, Candelilia, beeswax, paraffin wax, and vegetable oils. Waxing formulations can be used as carriers of chemicals for preventing

fungal infestation, senescence, and other physiological disorders. Coating formulations are applied by spraying, fogging, brushing on to the produce followed by drying using cold or hot air. Examples of fruits and vegetables normally waxed are apples, pears, banana, citrus fruits, cucumber, pepper, and tomato. The sealing of the stem end of mangoes with molten paraffin or other coatings prevents spoilage due to stem end rot and anthracnose, and increases the shelf life by controlling respiration [72].

### 3.3.1.3 Heat Treatment

Moderate heating has been used since ancient times as a quarantine measure to control insect pests and pathogens, and to increase the shelf life of plant produce. Deregistration of chemicals used to control physiological disorders, insect pests, and pathogens, and consumer demand for produce with no chemical exposures have fueled increased interest in the use of heat in postharvest management of quality. Heat treatment

**TABLE 3.6**

Typical Heat Treatments for Controlling Insects in Selected Fruits and Vegetables

Commodity	Insect	Temperature (°C)/Time	Heating Medium Used
Apple	Codling moth ( <i>Cydia pomonella</i> )	44/120 min followed by 0/4 weeks	Hot air or vapor
	Leafroller ( <i>Cnephasia jactatana</i> )	40/10 h and 45/5 h in reduced O <sub>2</sub>	Hot air and CA
	Light brown applemoth ( <i>Epiphyas postvittana</i> )	40/17–20 h in reduced O <sub>2</sub> and slightly elevated CO <sub>2</sub>	Hot air and CA
	Obscure mealy bug ( <i>Pseudococcus longispinus</i> )	40/10 h and 45/5 h in reduced O <sub>2</sub>	Hot air and CA
	Two spotted spider mite ( <i>Tetranychus urticae</i> )	45/13 min in 50% ethanol	Hot water and ethanol
Avocado	Mediterranean fruit fly ( <i>Ceratitis capitata</i> )	40/24 h	Hot air
	Melon fruit fly ( <i>Dacus cucurbitae</i> )	40/24 h	Hot air
	Queensland fruit fly ( <i>Bactrocera tyroni</i> )	46/3 min followed by 1/7 days	Hot water and benomyl
Citrus fruits	Mexican fruit fly ( <i>Anastrepha ludens</i> )	44/2 h with CA	Hot air and 1% O <sub>2</sub>
	Caribbean fruit fly ( <i>Anastrepha suspense</i> )	51.5/125 min	Hot air
	Fuller's rose beetle ( <i>Asynonychus gomani</i> )	52/8 min	Hot water
Mango	Mediterranean fruit fly ( <i>Ceratitis capitata</i> )	47/15 min	Vapor heat
	Caribbean fruit fly ( <i>Anastrepha suspense</i> )	51.5/125 min	Hot air
	Papaya fruit fly ( <i>Bactrocera payapae</i> )	47/15 min	Vapor heat
	Queensland fruit fly ( <i>Bactrocera tyroni</i> )	46.5/10 min	Vapor heat
Pear	Codling moth ( <i>Cydia pomonella</i> )	44/120 min followed by 0/4 weeks	Hot air and vapor
	Light brown apple moth ( <i>Epiphyas postvittana</i> )	30/30 h in reduced O <sub>2</sub>	Hot air and CA
	Oriental fruit moth ( <i>Grapholita molesta</i> )	30/30 h in reduced O <sub>2</sub>	Hot air and CA

Source: Adapted from S. Lurie, *Postharv. Biol. Technol.* 14:257, 1998; S. Lurie and J.D. Klein. In *The Commercial Storage of Fruits, Vegetables, and Florist and Nursery Stocks—A Draft Version of the Revision to USDA Agricultural Handbook Number 66* (K.C. Gross, C.Y. Wang, and M. Saltveit, Eds.), 2002 ([www.ba.ars.usda.gov/hb66/index.html](http://www.ba.ars.usda.gov/hb66/index.html)).

has a positive effect on maintaining fruit quality by preventing and controlling incipient fungal and insect infestation, reducing the rate of ripening, increasing sweetness and reducing acidity in fruits, and reducing the impact of storage disorders such as superficial scald and chilling injury [21,37–40,42–46,50]. The heating schedules have been specified in terms of temperature and time of heating for each commodity and the purpose for which the treatment is used. Tables 3.6 through 3.8 list the conditions of heat treatment used for insect disinfestations, disinfection, and control of physiological disorders and enhancing quality, respectively. The effectiveness of the treatment depends on the nature of the produce and its sensitivity to heat, temperature and time of heating, the heating method used, and any supplemental treatments such as combinations with antioxidants or CAs. Benefits may also accrue by exposing the produce to temperature-conditioning treatment before storage by incubating the produce at ambient temperature for a certain length of time.

Hot air, vapor heat, and hot water can be used as a source of heat. Hot water treatment has the advantages of low cost and relatively simple application equipment. The vapor heat treatment is relatively expensive due to costs associated with initial investment for equipment and process operation. It requires an airtight and moisture-proof treating room equipped with automatic temperature and humidity controls and a boiler for steam generation [2]. In general, both hot water and vapor heat treatment can cause excessive tissue damage and peel injury than forced hot air.

**TABLE 3.7**

Typical Heat Treatments for Controlling Pathogens

Commodity	Pathogen	Temperature (°C)/Time	Heating Medium Used
Apple	Gray mold ( <i>Botrytis cinerea</i> )	38/4 days	Hot air with CaCl <sub>2</sub> dip
	Blue mold ( <i>Penicillium expansum</i> )	38/4 days	Hot air alone or combination with CaCl <sub>2</sub> dip
Banana	Crown rot ( <i>Chalara paradoxa</i> )	45/20 min or 50/10 min	Hot water
Cactus pear	Blue mold ( <i>Penicillium italicum</i> )	38/24 h or 55/5 min	Hot water or air
Grapefruit	Green mold ( <i>Penicillium digitatum</i> )	46/6 h or 59–62/15 s	Hot water
Lemon	Green mold ( <i>Penicillium digitatum</i> )	45/2.5 min	Hot water with 2% sodium carbonate
		36/3 days	Hot air
Mango	Black spot ( <i>Alternaria alternata</i> )	60–70/15–20 s	Hot water
	Antracnose ( <i>Colletotrichum gloeosporrioides</i> )	46–48/24 s to 8 min	Hot water, vapor
	Stem end rot ( <i>Diplodia natalensis</i> )	51.5/125 min	Air Hot air and water
Orange	Green mold ( <i>Penicillium digitatum</i> )	41–43/1–2 min	Hot water and 6% sodium carbonate
		53/3 min	Hot water
Papaya	Stem and surface rots ( <i>Botryodiplodia theobromae</i> )	49/20 min or 32/33 min first and then 49/20 mins	Hot air
	Stem and surface rots ( <i>Mycospharella</i> spp.)		
Pepper	Gray mold ( <i>Botrytis cinerea</i> )	50/3 min	Hot water
Strawberry	Gray mold ( <i>Botrytis cinerea</i> )	45/15 min	Hot water
Tomato	<i>Rhizopus stolonifer</i>	50/2 min	Hot water

Source: Adapted from S. Lurie and J.D. Klein. In *The Commercial Storage of Fruits, Vegetables, and Florist and Nursery Stocks—A draft version of the revision to USDA Agricultural Handbook Number 66* (K.C. Gross, C.Y. Wang, and M. Saltveit, Eds.), 2002 ([www.ba.ars.usda.gov/hb66/index.html](http://www.ba.ars.usda.gov/hb66/index.html)).

**TABLE 3.8**

Optimum Conditions for Curing Vegetables

Commodities	Temperature (°C)	RH (%)	Days
Cassava	30–40	90–95	2.5
	25–40	80–85	7–14
Potato	15–20	90–95	5–10
Sweet potato	30–32	85–95	4–7
	29–32	80–90	4–7
	30–33	85–95	5–7
Yam	32–40	90–100	1–4

Source: L. Kitinoja and A.A. Kader, *Small-Scale Postharvest Handling Practices: A Manual for Horticultural Crops*, 3rd ed., University of California, Davis, 1995; V. Ravi, J. Aked, and C. Balagopalan, *Crit. Rev. Food Sci. Nutri.* 36:661, 1996.

Since surface injuries are sites for infection by decay organisms, heating the surface of fruits to a few degrees below the tissue injury threshold eradicates or delays the development of incipient infections by pathogenic fungi [62]. Typical heat treatments used for controlling pathogens of selected fruits and vegetables are shown in Table 3.7. Heating may promote lignin formation and accelerate peel injury healing, which may inhibit fruit rot as reported in grapefruit [17]. Curing is a postharvest healing process of the outer tissues of root crops by the development of a wound periderm by application of heat. Periderm acts as an effective barrier against infection and water loss. The purposes of curing are (i) to heal wounds of tubers and bulbs sustained during harvesting, (ii) to strengthen the skin, (iii) to dry superficial leaves, such as onion bulbs to prevent microbial infection during storage and distribution, (iv) to develop desired skin color (onion), (v) to reduce water loss during storage in potatoes, sweet potatoes, cassavas, yams, onions, and garlic [63]. Extension of storage life achieved owing to curing offsets the initial cost of treatment [36]. Curing is carried out at the farm level by subjecting the produce to high temperature and humidity for a given duration. If local weather conditions permit, crops can be undercut in the field, windrowed, and left to dry for 5–10 days. The dried tops of the plants can be arranged to cover and shade the bulbs during curing process, protecting the produce from excess heat and sunburn [36]. The optimum curing conditions for different crops are given in Table 3.8. One day or less at 35°C–45°C and 60%–75% relative humidity is recommended if forced heated air is used for curing onions and other bulbs [36].

Heat treatment can also assist in controlling the postharvest disorders and enhance the shelf life of fruits and vegetables by formation of areas of amorphous wax and fewer surface cracks in apples after heat treatment. Heating apples to 38°C for 3 or 4 days before storage suppressed softening [37], and decreased storage disorders such as superficial scald and bitter pit [46]. The prestorage heating plus calcium dip has shown a synergistic effect in maintaining fruit firmness [44] and decreasing storage disorders. However, the synergistic effect is limited to only when the heat treatment preceded calcium dipping [40]. Prolonged exposure to elevated temperatures must be avoided to reduce weight loss and loss of ripening ability [22]. Heating at 38°C for various holding time has been found to be effective in preventing chilling injury for a produce stored at 2°C for 4 weeks (Table 3.9).

### 3.3.1.4 Irradiation

Irradiating fruits and vegetables with ionization energy such as X-rays, gamma, or electron beam has been investigated to inhibit sprouting in tubers (potato) and bulbs (onion), delay ripening and senescence in tropical fruits such as mango and papaya, control infestation by insects such as fruit fly and seed weevils in mangoes, pasteurize fruit surfaces, and improve technological properties of fruits to improve process efficiency. However, the use of irradiation is limited by the perception of people to radiation, cost of the treatment process, and phytotoxic effects induced in the treated produce that adversely affect quality. It has been found to be very effective in controlling insect disinfestations as a quarantine measure and for sprout inhibition. Table 3.10 lists the principal uses and the dose of irradiation for fruits and vegetable products [8,53]. Only low- to medium-dose irradiation is commonly employed, and the maximum dose takes into consideration the level of deterioration to the quality of the produce irradiated. Irradiation is generally accepted as a quarantine measure by some countries and is gaining popularity as an alternative to chemical fumigation.

**TABLE 3.9**

Typical Heat Treatments for Controlling Physiological Disorders and Enhancing Quality of Selected Fruits and Vegetables

Commodity	Physiological Disorders/Injury	Temperature (°C)/Time	Heating Medium Used
Apple	Scald and improving firmness	38/4 days or 42/2 days	Hot air
Asparagus	Inhibition of curvature	47.5/2–5 min	Hot water
Avocado	Browning	38/3–10 h followed by 40/30 min	Hot air and water
	Pitting	38/60 min	Hot water
Cactus pear	Rind pitting	38/24 h or 55 /5 min	Hot water or air
Citrus fruits	Rind pitting	34–36/48–72 h	Hot air
		50–54/3 min	hot water
Guava	Increased hardness and yellowing	46/35 min	Hot water
Green pepper	Pitting	40/20 h	Hot air
Mango	Pitting	38/2 days or 54/20 min	Hot air
Tomato	Pitting	38/2–3 31 days	Hot air
		48/2 min or 42/1 h	hot water

Source: Adapted from S. Lurie and J.D. Klein. In *The Commercial Storage of Fruits, Vegetables, and Florist and Nursery Stocks—A Draft Version of the Revision to USDA Agricultural Handbook Number 66* (K.C. Gross, C.Y. Wang, and M. Saltveit, Eds.), 2002 ([www.ba.ars.usda.gov/hb66/index.html](http://www.ba.ars.usda.gov/hb66/index.html)).

**TABLE 3.10**

Application of Irradiation for Fruits and Vegetables

Purpose	Products Subjected To	Dose (kGy)
Sprout inhibition	Potatoes, onion, garlic, ginger, yam	0.05–0.15
Insect disinfestations	Fresh and dried fruits	0.15–0.5
Delaying maturity and senescence	Fresh fruits and vegetables	0.25–1.0
Extending shelf life	Strawberries, mushrooms	1.0–3.0
Improving technological properties	Grapes (juice recovery), dehydrated vegetables (reduced cooking time)	2.0–7.0

Source: Anon, Facts about food irradiation, A series of fact sheets for ICGFI, International Atomic Energy Agency, Vienna, Austria, 1999 ([www.iaea.org/programmes/nafa/d5/public/foodirradiation.pdf](http://www.iaea.org/programmes/nafa/d5/public/foodirradiation.pdf)).

It is now accepted and approved by about 60 countries as a quarantine treatment using low-dose irradiation [8]. It has been approved by the FDA of the United States for sprout inhibition of white potatoes, ripening delay in fruits, disinfestations of fruits and vegetables, and as a quarantine measure for mangoes and papaya for the control of fruit fly and stone weevil [8,53]. Normal doses for insect disinfestations have been found to produce no phytotoxicity in apple, cantaloupe, cherry, currants, date, guava, honeydew melon, kiwifruit, lychee, mango, muskmelon, nectarine, papaya, peach, prune, raspberry, strawberry, and tomato [7].

### 3.3.2 Chemicals Treatments

Chemicals have been used in fruits and vegetables to control microorganisms causing decay and diseases, infestations due to pests, physiological disorders, and enhance quality of produce. The methods of application used include spraying and dipping solutions or emulsions, electrostatic spray, dusting, fumigation, thermal fogging, and adsorbent pads. The choice of a particular chemical treatment and the dose depend on intended use, phytotoxicity, residue, and degradation. These compounds should be selected for both

efficacy and minimal interference with the natural color, flavor, and odor of the product. It is necessary to consider toxicity, residue in the product, and legal aspects before applying any chemical treatment.

### 3.3.2.1 Disinfestation and Decay Control

Fruits and vegetables are exposed to deterioration due to insect pests, fungi, and bacteria at any time from production until consumption or processing. Insect pests that cause significant losses worldwide have been described in the literature [9,74,83]. Similarly, pathogens significant to fruits and vegetables have been covered in Refs. [69–72,74,83]. The list of chemicals approved for use as insecticide, fungicide, or bactericide is shrinking due to their environmental impact and toxicity. The general trend is to observe strict hygiene in the production and handling of the produce; use physical methods (heat and modified atmospheres) and chemicals generally regarded as safe (GRAS), or biological agents.

Chemicals are applied as insecticidal dips or fumigants for disinfestation of fruits and vegetables. Gaseous sterilants used as a quarantine treatment include ethylene dibromide, methyl bromide, acrylonitrile, carbon disulfide, carbon tetrachloride, ethylene dioxide, hydrogen cyanide, phosphine, and sulfuranyl fluoride. Out of these, methyl bromide is used for fresh produce and phosphine for dry produce. The use of methyl bromide has been now phased out under the Montreal Protocol due to health risks and impact on environmental pollution. Use of methyl bromide as a fumigant may be permitted only when the importing countries specify it as a quarantine measure for importation. Japan requires fumigation of strawberries by methyl bromide for import from Australia.

Decay due to fungi is more common in fruits than in vegetables due to low pH of fruits. Incipient growth of both fungi and bacteria in fruits and vegetables used as raw material for processed products causes defects in sensory (color, texture, and flavor) and microbial quality of end product. Increased softening upon canning or pickling, acidic or alcoholic flavor in fruit juices are some examples of spoilage symptoms. Fungal spoilage in fruit is more common due to inherently lower pH found in fruits. Fungicides are applied to fruits and vegetables both as pre- and postharvest treatments depending on the nature of produce, the target pathogen, market life, and cost. The local and international laws strictly control the use of fungicides. Table 3.11 lists chemicals used in postharvest control of common pathogens. Chemicals that are most effective in controlling fungi are thiabendazole, dichloran, imazalil, and sulfur and its derivatives [74,82]. However, increased resistance to these fungicides is a problem. Sulfur and its derivatives are effective in controlling fungi and molds in fruits in the form of fumigation, dipping and spraying or using pads. Fumigation of grapes with sulfur dioxide has been a standard practice for controlling decay since the 1930s. Salunkhe et al. [62] fumigated grapes with 1% sulfur dioxide (v/v) for 20 min immediately after harvest to sterilize the surface of the berries and any injuries made during harvest. The initial treatment may be followed by a periodic fumigation with a 0.25% sulfur dioxide at 7–10 day intervals during storage. In some cases, color and texture of fruits are also improved by sulfur dioxide treatment. Two major disadvantages of sulfur dioxide use are corrosion to metal surfaces of the storage

**TABLE 3.11**

Chemicals Used in Postharvest Control of Pathogens in Fruits and Vegetables

Chemical	Pathogen Controlled	Host
Inorganic sulfur as SO <sub>2</sub> gas or salts	<i>Monillia</i> , <i>Botrytis</i>	Grapes
Organic sulfur compounds (e.g., thiram)	<i>Alternaria</i>	Strawberry, banana
Phenols (sodium o-phenylphenate)	<i>Penicillium</i> , bacteria, and fungi	Citrus fruits
Triazoles (imazalil)	<i>Penicillium</i> , <i>Alternaria</i>	Citrus fruits
Hydrocarbons (biphenyl)	<i>Penicillium</i> , <i>Diplodia</i>	Citrus fruits
Organic acids (dehydroascorbic acid, sorbic acid, acetic acid, formic acid)	<i>Botrytis</i> and other fungi	Strawberry
Benzimidaxoles (benomyl)	<i>Penicillium</i> , <i>Collectotrichum</i> , <i>Sclerotinia</i> , <i>Botrytis</i>	Stone fruits, carrots

Source: A.K. Thompson, *Postharvest Technology of Fruits and Vegetables*, Oxford Blackwell Science Pub., 1996; R.H.H. Wills, W.B. McGlasson, D. Graham, and D. Joyce, *Postharvest: An Introduction to the Physiology and Handling of Fruit Vegetables and Ornamentals*, New South Wales University Press, Sydney, 1998.

and treatment chamber, and bleaching the point of attachment of the stem to the berry [62]. Bisulfites can be used as pads in cartons carrying grapes to control molds [36].

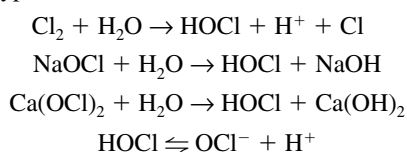
Nitrogen trichloride ( $\text{NCl}_3$ ) fumigation treatment has been used extensively to control sporulation and spread of pathogenic fungi during storage. It is hydrolyzed in a moist environment to  $\text{HOCl}$ , which is probably responsible for decay control and for corrosion [62]. In recent years, its use has declined because of its corrosion problems. The biphenyl may be used after impregnation into fruit wraps or on to the paper sheets placed at the bottom and the top of the fruit container to inhibit fungi. It sublimes into the atmosphere surrounding the fruit and inhibits the development of decays. The main problem with using biphenyl is that it leaves a residue on the surface, which gives off slight hydrocarbon odor [62].

There is a trend to use essential oils and natural substances as fungicides that have low mammalian toxicity. *Trans*-Cinnamaldehyde is more effective as an antifungal agent when applied as an aqueous solution than in gas phase, since it oxidizes to cinnamic acid when exposed to air [67]. The surface treatment of tomatoes with *trans*-cinnamaldehyde has been demonstrated to be effective in reducing the number of potential spoilage bacteria and fungi [68] before storage under modified atmosphere. Similarly, Ryu and Holt [61] demonstrated the effectiveness of an aqueous solution of cinnamon oil for surface disinfection of apples. Addition of Tween 80 (0.05%) and ethanol (3%), which assist in dissolving the wax layer, increased the susceptibility of the cinnamon oil-treated apples toward fungal spoilage.

In addition to following strict hygiene through good agricultural practices at the farm level and Hazard Analysis and Critical Control Point (HACCP) protocols through the distribution channel, the potential alternatives of chemical treatments for control of diseases and pests are (i) low- and high-temperature treatments (Table 3.7), (ii) atmospheres with very low oxygen or very high carbon dioxide, (iii) atmospheres with natural insecticidal volatiles, (iv) irradiation (Table 3.10), (v) using radio frequency for control of insects [78,80], and (vi) using biological control for wound-invading necrotrophic pathogens [29,30,74]. Certain bacteria, for example, *Bacillus subtilis*, *B. licheniformis*, *B. magaterium*, and *B. sterothermophilus*, have been shown to be effective in controlling diseases (anthracnose and stem end rot of mangoes) and yeasts, *Candida guilliermondii* for molds (*Penicillium* sp. in citrus fruits). These biological agents are very useful in combination with chemicals for disease control [74].

Atmospheres with very low oxygen ( $\leq 0.5\%$ ) or very high carbon dioxide ( $\geq 50\%$ ) are insecticidal [75]. High levels of carbon dioxide are more effective as an insecticide than low oxygen. However, not all fresh fruits and vegetables can tolerate such extreme atmospheres. The advantages of using insecticidal atmospheres include (i) absence of toxic residue on the produce, (ii) environmentally safe, and (iii) competitive in cost with chemical fumigants. The disadvantages, however, are that it takes longer to kill insects with insecticidal atmospheres than with fumigants, and may cause anaerobiosis and fermentation in fresh horticultural crops [84]. Insecticidal atmospheres can be used for mango, papaya, and avocado as a quarantine measure.

Water disinfection is required to prevent introduction and spread of postharvest diseases and food-borne infections of human pathogens. The common disinfectants and sanitizers used and their mechanisms of action are given in Table 3.12. Chlorine compounds are used to sanitize water used in cleaning raw produce, fresh and cut fruit and vegetables, and food processing equipment. Chlorine is very reactive and the most acceptable disinfectant used owing to its antimicrobial activity against bacterial cells and spores, reduction in formation of biofilms on the surface of handling equipment, and low residual effect. Use of chlorinated water at 10–200 mg/kg rapidly kills vegetative cells of yeast and bacteria. The recommended levels of chlorine in wash water are 1–3 ppm for rinsing and 50 ppm for sanitizing [26,41]. Chlorine is used as gas or sodium or calcium hypochlorite salts. When added to water the following reactions take place:



The disinfectant activity of chlorine compounds depends on several factors, which include the form of the chlorine, pH, temperature, contact time, and presence of organic matter. Of the many forms of chlorine, hypochlorous acid ( $\text{HOCl}$ ) is the most effective form as a disinfectant. The pH of water should be maintained at 6–6.5 to ensure optimum disinfectant activity and avoid formation of gaseous chlorine, which causes irritation to workers at  $\text{pH} < 6$ . It is necessary to maintain the effective concentration of the acid in the wash water, especially when water is recycled. In commercial operations, 50–100 ppm chlorine at



TABLE 3.12

Sanitizers Used in Disinfection of Wash Water

Sanitizer	Activity	Oxidation Capacity (eV)	Concentration	Effectiveness
Peracetic acid	Oxidant	1.81	Up to 80 ppm	pH 1–8, sensitive to organic matter
Hypochlorites	Oxidant	1.36 (for sodium hypochlorite)	1–3 ppm for rinsing 50 ppm for sanitizing	pH 6–7, sensitive to organic matter
Chlorine dioxide	Oxidant	1.57	Up to 5 ppm	pH 6–10, less sensitive to organic matter in comparison with hypochlorites
Hydrogen peroxide	Oxidant	–	0.5%	Sensitive to organic matter
Ozone	Oxidant	2.07	2 ppm	pH 6–8, sensitive to organic matter, breaks down to O <sub>2</sub> rapidly, corrosive to equipment
UV light	Disruption of genetic material	–	40,000 μw. s/cm <sup>2</sup>	Independent of pH sensitive to organic matter
Iodophore	Oxidant	–	6–13 ppm of free iodine	pH 2–5, sensitive to organic matter, corrosive

pH 7.5–8.5 is frequently employed when the wash water carries a substantial amount of soil and organic matter. Sulfamic acid and other amines are added to water to form *N*-chloramines that tend to stabilize the concentration of active chlorine. Sodium o-phenylphenate (SOPP) is also used occasionally to reduce the number of pathogenic microorganisms in produce treatment water. SOPP is noncorrosive and improves stability of the solution, and compatibility with chemicals that react with chlorine. Further stabilization of chlorine solution is possible by adding 2-aminobutane (phosphate) in addition to SOPP [62].

The alternatives to chlorine as a disinfectant are ultraviolet light (UV), ozone, and organic acid formulations such as peracetic acid. The UV light disrupts the DNA and can be used for sanitation of water and surfaces. Most disinfectants are strong oxidizing agents and their disinfectant power is related to their oxidation capacity. Based on this capacity, ozone is a very effective disinfectant; however, it degrades rapidly to oxygen and loses its activity. Besides wash water, disinfection of storerooms can also be done by spraying with 5% lysol or 2% formalin, painting of walls with antifungal chemicals, and fumigation with paraformaldehyde [56].

Accurate monitoring, control, and recording are key elements of a sound disinfection program. Oxidation–reduction potential (ORP) is widely accepted as a key indicator of water disinfection potential for real-time monitoring and recording of disinfection process in postharvest system. Maintaining an ORP value of 650–700 mV for few seconds can inactivate most spoilage and food-borne bacteria such as *Escherichia coli* and *Salmonella* [73].

### 3.3.2.2 Ethylene Removal

Ethylene, a plant hormone, affects physiological processes of ripening and senescence, which signals cell death. Exposure to ethylene (1 ppm) can reduce the postharvest life of many fruits and vegetables by hastening the onset and increasing the rate of senescence, softening, and loss of green color. Damaged or diseased fruits produce more ethylene and have catalytic effect in stimulating the

following symptoms: softening of tissues, discoloration, bitterness due to production of isocoumarins in carrots, russet spotting in lettuce, browning of tissues in vegetables such as eggplant, sweet potatoes, sprouting of potatoes, development of woodiness in asparagus, shattering of berries such as blackberries and raspberries, loss of green color in vegetables, and stimulation of growth of fungi (*Penicillium italicum* in oranges, *Botrytis cineria* on strawberries).

The ethylene control strategy includes prevention of exposure of plants to biologically active levels of ethylene, reducing the tissue perception of atmospheric ethylene, and preventing the tissue response to perceived ethylene [65]. Ethylene damage can be reduced by (i) adequate ventilation, (ii) reduction of O<sub>2</sub> and increase in CO<sub>2</sub> levels, (iii) reducing temperature, (iv) avoiding storage and transportation of ethylene producers and sensitive produce, and (v) reduction of ethylene by forcing air through filters of activated charcoal (brominated), treatment with silver thiosulfate, potassium permanganate (KMnO<sub>4</sub>) or purafil, 1-methyl cyclopropene (MCP) or EthylBlock, and oxidation by UV light. Potassium permanganate, the most accepted ethylene remover used commercially, oxidizes ethylene into ethylene glycol and often is incorporated into different carrier materials such as activated alumina and silica gel. It is applied in sachets, tubes, and blankets in storage and transportation of fresh fruits and vegetables. When used in conjunction with modified-atmosphere packaging, the use of KMnO<sub>4</sub> increases the shelf life of banana to 21 days from 7 days in air [83]. MCP is an ethylene action inhibitor and blocks the ethylene production and therefore helps in delaying the rise in respiration, preventing tissue softening, and incidence of physiological disorders such as superficial scald in apples. Single application of 0.7 ppm of MCP to apples has been reported to prevent ripening for >30 days even at 25°C [14]. Response of fruit to MCP depends on several factors, which include type of fruit, cultivar, maturity, the application method, and exposure levels of MCP used [12]. MCP has been approved at concentrations up to 1 ppm for use on apples, apricots, avocados, kiwifruit, mangoes, nectarines, papayas, peaches, pears, persimmon, plums, and tomatoes in the United States [34].

### 3.3.2.3 Controlled Ripening and Color Development

Climacteric fruits such as banana and mangoes are harvested well before they are fully ripe to avoid mechanical injury and are ripened during storage or transport under controlled conditions of temperature, relative humidity, and ethylene gas just before consumption or processing. Controlled ripening facilitates uniform development of color, texture, and flavor.

Ethylene is the most active ripening agent. Acetylene, generated by mixing water with calcium carbide salt, can also be used as a ripening agent; however, it is 100 times less effective compared to ethylene. Endogenous or exogenous ethylene is used for controlled ripening of fruits (banana and mangoes) and development of uniform color of the produce (tomatoes and citrus fruits) under controlled conditions. The ripening effect depends on the concentration of ethylene, exposure time, relative humidity, and respiratory behavior of fruits. A batch process for ripening bananas consists of exposing fruits to ethylene concentration of 20–200 µL/L in a sealed chamber for 24 h followed by ventilation to avoid build up of ethylene and carbon dioxide before removing the fruits. The chamber temperature is maintained at 15°C–21°C by controlling an air flow in a forced air system. Initially, RH is maintained first at 85%–90% level to preclude water loss, development of blemishes, and poor color formation, and then reduced to 70%–75% to avoid skin spotting at later stages of maturity [83]. Table 3.13 lists typical ripening conditions used for some fruits [36].

Ethylene is a product of incomplete combustion of fuels such as charcoal. It is highly flammable when pure, and hence it is used in relatively low concentration (<3%). It can be generated by passing ethyl alcohol over a bed of activated column. Ethephon (2-chloroethyl phosphoric acid) may be used as a source of ethylene for ripening of fruits. The amount of ethylene released depends on the fruit pH and relative humidity.

### 3.3.2.4 Delaying Ripening, Senescence, and Sprouting

Ripening is undesired in most vegetables except in the case of tomatoes and signals the onset of senescence in fruits. Various plant growth regulators can be used at various stages of production and postharvest handling for delaying ripening, color degradation, and sprouting. These chemicals can be applied as dip or spray. Table 3.14 lists the chemicals used, their effect, and products for which these are applied.

**TABLE 3.13**

Typical Conditions for Postharvest Ripening and Color Development of Fruits

Fruit	Ethylene		Time (h)	Application
	Concentration (ppm)	Temperature (°C)		
Avocado	10–100	15–18	12–48	Ripening
Banana	100–150	15–18	24	Ripening
Honeydew melon	100–150	20–25	18–24	Ripening
Kiwifruit	10–100	0–20	12–24	Ripening
Mango	100–150	20–22	12–24	Ripening
Orange	1–10	20–22	24–72	Degreening
Tomato	100–150	20–25	24–48	Color development

Source: Adapted from L. Kitinoja and A.A. Kader, *Small-Scale Postharvest Handling Practices: A Manual for Horticultural Crops*, 3rd ed., University of California, Davis, 1995.

**TABLE 3.14**

Chemicals Used for Delaying Ripening, Senescence, and Sprouting

Chemical	Effect	Produce Used
Cytokinin	Delays chlorophyll degradation and senescence	Leafy vegetables (spinach), pepper, bean, cucumber
Benzyladenine	Delays chlorophyll degradation and senescence	Cherry
Benzylaminopurine	Delays chlorophyll degradation and senescence	Sweet cherry, cauliflower, endive, parsley, snapbeans, lettuce, radish, onion, cabbage, brussels sprouts, broccoli, mustard greens, radish tops, celery, asparagus
Kinetin	Delays chlorophyll degradation and senescence	Leafy vegetables (spinach), pepper, bean, cucumber
Gibberellin	Retards maturation, ripening, and senescence; delays chlorophyll degradation; increases peel firmness; delays accumulation of carotenoids	Tomato, banana, kiwifruit, citrus fruits (orange, grapefruit)
Maleic hydrazide and its analogs	Sprout inhibition Delays ripening	Onion, sugar beet, turnip, carrot, potato Mango, tomato, sapota fruit
Alar	Delays deterioration and discoloration Preservation of chlorophyll Inhibition of synthesis of solanine	Mushroom Leaves of beans Potato
Cytocel	Retards senescence and deterioration	Vegetables
IPC	Controls sprouting	Root crops
CIPC	Controls sprouting	Potato
Tecnazene	Controls sprouting and fungi	Root crops
Calcium	Delays chlorophyll degradation and senescence	Vegetables

Source: D.K. Salunkhe, H.R. Bolin, and N.R. Reddy, *Storage, Processing, and Nutritional Quality of Fruits and Vegetables, Vol. 1, Fresh Fruits and Vegetables*, CRC Press, Boca Raton, 1991.

TABLE 3.15

Diseases and Disorders Controlled or Prevented by Calcium and Other Divalent Ions

Disease/Disorder	Produce
Blossom end rot	Tomato, pepper
Tip burn	Lettuce
Internal browning	Potato
Bacterial and fungal decay	Potato, carrot
Bitter pit	Apples
Incidence of molds	Cucumber
Chlorosis	Most vegetables, potato

in tomatoes, tip burn in lettuce, and hollow heart and brown center in potatoes [25,47,57]. Table 3.15 lists the diseases and disorders associated with calcium and other divalent ions. Chlorosis, loss of green color, is induced by deficiency of magnesium. Since soil fertilization with calcium salts is not effective in raising the level of calcium in fruits, orchard sprays or postharvest dips or vacuum and pressure infiltrations are used to increase the levels of calcium in tissues.

Calcium exists as calcium pectate in the middle lamella of the cell wall cementing the structure of the plant cell. The loss of calcium from calcium pectate leads to softening of fruits. Addition of calcium improves texture by reacting with pectic acid to form calcium pectate. Sprays and dips of calcium chloride solutions delay softening and senescence of fruits by cross-linking between polygalacturonide chains and calcium in cell walls, thus resulting in an extension of shelf life. Calcium has not been used in other fruits except in the case of apples to prevent skin injury due to higher calcium uptake and rot development [83].

### 3.3.2.6 Treatment with Antioxidants

Superficial scald may develop due to oxidation of  $\alpha$ -farnesene during cold storage of apples, as natural antioxidants are lost. This disorder can be controlled by application of antioxidants. Diphenylamine (0.1%–0.25%) and ethoxyquin (1,2-dihydro-6-ethoxy-2,2,4-trimethylquinoline (0.2%–0.5%)) are two antioxidants used commercially [3,83]. These may be used as spray or dipping solutions or can be added to formulation used for waxing of fruits.

### 3.3.2.5 Treatment with Calcium and Divalent Cations

Calcium and other divalent ions are useful in delaying senescence and maintaining quality of fruits and vegetables by altering respiration, protein and chlorophyll content, and membrane fluidity [57]. Calcium application also reduces rates of respiration, texture loss, ethylene production, browning, development of bitterness and microbial decay [24–26,57], and increases the concentration of ascorbic acid.

Low calcium levels are strongly related to high incidences of bitter pit in apples, blossom end rot

## References

1. S. Agbor and D. Waterer, Onions—Post harvest handling and storage. A fact sheet, Agri-Food Innovation Funds, University of Saskatchewan, Canada, 2001.
2. E.K. Akamine, H. Kitagawa, H. Subramanyam, and P.G. Long, Packinghouse operations, *Postharvest Physiology, Handling, and Utilization of Tropical and Subtropical Fruits and Vegetables* (E.B. Pantastico, Ed.), AVI Publishing, Westport, CT, 1975, p. 267.
3. J. Aked, Maintaining the post-harvest quality of fruits and vegetables. In *Fruit and Vegetable Processing Improving Quality* (W. Jongen, Ed.), Woodhead Pub Ltd and CRC Press, LLC, Boca Raton, 2002.
4. American Society of Heating, Refrigeration and Air-conditioning Engineers, *ASHRAE Handbook of Refrigeration Systems and Applications*, Atlanta, GA, 1998.
5. Anon, Vacuum cooling for fruits and vegetables, *Food Process. Ind.* 12:24, 1981.
6. Anon, *Prevention of Post-Harvest Food Losses: Fruits, Vegetables and Root Crops, A Training Manual*, FAO Training Series NO. 17/2, 1989.
7. Anon, *Irradiation As a Quarantine Treatment of Fresh Fruits and Vegetables*. Report of a Task Force Convened by the International Consultative Group on Food Irradiation Bethesda, Maryland, 7–11 January, Vienna, 1991.
8. Anon, Facts about Food Irradiation, A series of fact sheets for ICGFI, International Atomic Energy Agency, Vienna, Austria, 1999 ([www.iaea.org/programmes/nafa/d5/public/foodirradiation.pdf](http://www.iaea.org/programmes/nafa/d5/public/foodirradiation.pdf)).
9. Anon, Irradiation for Food Safety, International Atomic Energy Agency, Vienna, Austria, 2003 ([www-tc.iaea.org/tcweb/publications/factsheets/FoodIrradiation.pdf](http://www-tc.iaea.org/tcweb/publications/factsheets/FoodIrradiation.pdf)).

10. P.R. Armstrong, G.K. Brown, and E.J. Timm, Cushioning choices can avoid produce bruising during handling. In *Harvest and Postharvest Technologies for Fresh Fruits and Vegetables* (L. Kushwaha, R. Serwatowski, and R. Brook, Eds.), American Society of Agricultural Engineers, Michigan, 1995, p. 183.
11. E.A. Baldwin, Coatings and other supplemental treatments to maintain vegetable quality. In *Postharvest Physiology and Pathology of Vegetables* (J.A. Bartz and J.K. Brecht, Eds.), Marcel Dekker, New York, 2003, p. 413.
12. B.R. Batters and H. Warner, 1-MCP and fruit quality, *Perish. Handling Quart.* 108:10, 2001.
13. B. Beattie and N. Wade, Storage, ripening, and handling of fruit. In *Fruit Processing*, 2nd ed. (D. Arthey and P.R. Ashurst, Eds.), Aspen Pub., Maryland, 2001, p. 53.
14. R. Beudry and C. Watkins, Use of 1-MCP on apples, *Perish. Handling Quart.* 108:12, 2001.
15. F. Bollen and B.T.D. Rue, Padding materials for handling horticultural products: Development of an evaluation procedure. In *Harvest and Postharvest Technologies for Fresh Fruits and Vegetables* (L. Kushwaha, R. Serwatowski, and R. Brook, Eds.), American Society of Agricultural Engineers, Michigan, 1995, p. 129.
16. F. Bollen, I.M. Woodhead, and B.T.D. Rue, Compression forces and damage in the postharvest handling system. In *Harvest and Postharvest Technologies for Fresh Fruits and Vegetables* (L. Kushwaha, R. Serwatowski, and R. Brook, Eds.), American Society of Agricultural Engineers, Michigan, 1995, p. 168.
17. G.E. Brown, M.A. Ismail, and C.R. Barmore, Lignification of injuries to citrus fruit and susceptibility to green mold, *Proc. Fla. State Hort. Soc.* 91:124, 1978.
18. C.L. Burton, G.K. Brown, N.L. Pason, and E.J. Timm, Apple bruising related to picking and hauling impacts, Paper No. 89-6049, Summer Meeting, Quebec, Canada, 1989.
19. D.T. Campbell, S.E. Prussia, and R.L. Shewfelt, Evaluation of postharvest injury to fresh market tomatoes, *J. Food Distrib. Res.* 17(2):16, 1986.
20. W. Chace and E.B. Pantastico, Principles of transport and commercial transport. In *Postharvest Physiology, Handling, and Utilization of Tropical and Subtropical Fruits and Vegetables* (E.B. Pantastico, Ed.), AVI Publishing, Westport, CT, 1975, p. 444.
21. H.M. Couey, Chilling injury of crops of tropical and subtropical origin, *HortSci.* 17:162, 1982.
22. J. Eaks, Ripening, respiration, and ethylene production of 'Haas' avocado fruits at 30 to 40°C, *J. Am. Soc. Hort. Sci.* 103:576, 1978.
23. E.A. Estes, Feasibility and affordability considerations in precooling fruits and vegetables. In *Harvest and Postharvest Technologies for Fresh Fruits and Vegetables* (L. Kushwaha, R. Serwatowski, and R. Brook, Eds.), American Society of Agricultural Engineers, Michigan, 1995, p. 390.
24. B. Ferguson, Calcium in plant senescence and fruit ripening, *Plant Cell Environ.* 7:477, 1984.
25. B. Ferguson. Calcium nutrition and cell response. In *Calcium in Plant Growth and Development* (R.T. Leonard and P.K. Helper, Eds.), Am. Soc. Plant Physiol. Sym. Series. Vol 4, 1990, pp. 1–8.
26. J.D. Floros, The shelf life of fruits and vegetables. In *Shelf Life Studies of Foods and Beverages: Chemical, Biological, Physical, and Nutritional Aspects* (G. Charalambous, Ed.), Elsevier Science Publishers B.V., Amsterdam, 1993, p. 195.
27. K.C. Gross, C.Y. Wang, and M. Saltveit, *The Commercial Storage of Fruits, Vegetables, and Florist and Nursery Stocks—A Draft Version of the Revision to USDA Agricultural Handbook Number 66*, 2002 ([www.ba.ars.usda.gov/hb66/index.html](http://www.ba.ars.usda.gov/hb66/index.html)).
28. R.E. Harderburg, A.E. Watada, and C.Y. Wang, *The Commercial Storage of Fruits, Vegetables, and Florist and Nursery Stocks*, USDA, Agricultural Handbook No. 66, 1986.
29. W.J. Janisiewicz and L. Korsten, Biological control of postharvest diseases of fruits, *Annu. Rev. Phytopathol.* 40:411, 2002.
30. W.J. Janisiewicz and L. Korsten, Microbial control of postharvest diseases and spoilage. In *Postharvest Physiology and Pathology of Vegetables*, 2nd ed. (J.A. Bartz and J.K. Brecht, Eds.), Marcel Dekker, Inc., New York, 2003, p. 543.
31. J.J. Jen, Postharvest handling and processing of selected fruits and vegetables. In *Trends in Food Processing II* (A.H. Ghee, N. Lodge, and O.K. Lian, Eds.), Singapore Institute of Food Science and Technology, Singapore, 1989, p. 261.
32. A.A. Kader, *Postharvest Technology of Horticultural Crops*, University of California, Publication 3311, Davis, C.A., 1992.
33. A.A. Kader and D.M. Barrett, Classification, composition of fruits, and postharvest maintenance of quality. In *Processing Fruits: Science and Technology, Vol. 1, Biology, Principles, and Applications* (L.P. Somogyi, H.S. Ramaswamy, and Y.H. Hui, Eds.), Technomic Publishing Company, Pennsylvania, 2003, p. 1.

34. A.A. Kader and R.S. Rolle. The role of post-harvest management in assuring the quality and safety of horticultural produce. FAO Agricultural Services Bulletin 152, FAO of the UN, Rome, 2004.
35. R.F. Kashmir and J.F. Thompson, Cooling horticultural commodities III. Selecting a cooling method. In *Postharvest Technology of Horticultural Crops* (A.A. Kader, Ed.), University of California Publication 3311, Davis, C.A., 1992, p. 63.
36. L. Kitinoja and A.A. Kader, *Small-scale Postharvest Handling Practices: A Manual for Horticultural Crops*, 3rd ed., University of California, Davis, C.A., 1995.
37. J.D. Klein and S. Lurie, Prestorage heat treatment as a means of improving poststorage quality of apples, *J. Am. Soc. Hortic. Sci.* 103:584, 1990.
38. J.D. Klein and S. Lurie, Heat treatments for improved postharvest quality of horticultural crops, *HortTechnol.* 2:316, 1992.
39. J.D. Klein and S. Lurie, Time, temperature, and calcium interact in scald reduction and firmness retention in heated apples, *HortSci.* 29:194, 1994.
40. J.D. Klein, S. Lurie, and R. Ben Arie, Quality and cell wall components of 'Anna' and 'Granny Smith' apples treated with heat, calcium, and ethylene, *J. Am. Soc. Hortic. Sci.* 115:954, 1990.
41. S. Luh and J.G. Woodroof, *Commercial Vegetables Processing*, 2nd ed., AVI/Van Nostrand Reinhold, New York, 1989.
42. S. Lurie, Post harvest heat treatment, *Postharv. Biol. Technol.* 14:257, 1998.
43. S. Lurie, E. Fallik, and J.D. Klein, The effect of heat treatment on apple epicuticular wax and calcium uptake, *Postharv. Biol. Technol.* 8:271, 1996.
44. S. Lurie and J.D. Klein, Calcium and heat treatments to improve storability of 'Anna' apples, *HortSci.* 27:36, 1992.
45. S. Lurie and J.D. Klein, Temperature preconditioning. In *The Commercial Storage of Fruits, Vegetables, and Florist and Nursery Stocks—A Draft Version of the Revision to USDA Agricultural Handbook Number 66* (K.C. Gross, C.Y. Wang, and M. Saltveit, Eds.), 2002 ([www.ba.ars.usda.gov/hb66/index.html](http://www.ba.ars.usda.gov/hb66/index.html)).
46. S. Lurie, J.D. Klein, and R. Ben Arie, Postharvest heat treatment as a possible means of reducing superficial scald of apples, *J. Hortic. Sci.* 65:503, 1992.
47. J.L. Mason, Increasing calcium content of calcium sensitive tissues, *Commun. Soil. Sci. Plant Anal.* 10:349, 1979.
48. G. McAlpine, Summary notes from the Western Australian Apple Grading and Packing Code-1993, Farmnote 13/1993 (Reviewed October 2001).
49. M. McGregor, *Tropical Products Transport Handbook*, USDA Office of Transportation, Agricultural Handbook 668. 1999 (<http://www.ams.usda.gov/tmd/Tropical/index.htm>).
50. R.G. McGuire, Market quality of grapefruit after heat quarantine treatments, *HortSci.* 26:1393, 1991.
51. F.G. Mitchell, Cooling horticultural commodities I. The need for cooling. In *Postharvest Technology of Horticultural Crops* (A.A. Kader, Ed.), University of California Publication 3311, Davis, C.A., 1992, p. 53.
52. F.G. Mitchell, Cooling horticultural commodities II. Cooling methods. In *Postharvest Technology of Horticultural Crops* (A.A. Kader, Ed.) University of California Publication 3311, Davis, C.A., 1992, p. 56.
53. D.G. Olson, Irradiation of Foods—Scientific Status Summary, *Food Technol.* 52:56, 1998.
54. Optimal Fresh-Horticultural Storage and Handling Database, 2005 ([www.postharvest.com.au/Produce\\_Information.htm](http://www.postharvest.com.au/Produce_Information.htm)).
55. D.W. Pang, F. Bollen, A. McDougall, and B.D. Rue, Simulation of bulk apple handling to determine bruising levels. In *Harvest and Postharvest Technologies for Fresh Fruits and Vegetables* (L. Kushwaha, R. Serwatowski, and R. Brook, Eds.), American Society of Agricultural Engineers, Michigan, 1995, p. 152.
56. E.B. Pantastico, (Ed.), Preharvest factors affecting quality and physiology after harvest. In *Postharvest Physiology, Handling, and Utilization of Tropical and Subtropical Fruits and Vegetables*, AVI Publishing, Westport, CT, 1975, p. 25.
57. B.W. Poovaiah, Role of calcium in prolonging storage life of fruits and vegetables, *Food Technol.* 40:86, 1986.
58. V. Ravi, J. Aked, and C. Balagopalan, Review on tropical root and tuber crops. I. Storage methods and quality changes, *Crit. Rev. Food Sci. Nutri.* 36:661, 1996.
59. R. Rodriguez, B.L. Raina, E.B. Pantastico, and M.B. Bhatti, Quality of raw materials for processing. In *Postharvest Physiology, Handling, and Utilization of Tropical and Subtropical Fruits and Vegetables* (E.B. Pantastico, Ed.), AVI Publishing, Westport, CT, 1975, p. 467.

60. L. Ryall and W.J. Lipton, *Handling, Transportation and Storage of Fruits and Vegetables, Vol. 1, Vegetables and Melons*, AVI Publishing, Westport, CT, 1972.
61. J. Ryu and D.L. Holt, Growth inhibition of *Penicillium expansum* by several commonly used food ingredients, *J. Food Protect.* 56:862, 1993.
62. D.K. Salunkhe, H.R. Bolin, and N.R. Reddy, *Storage, Processing, and Nutritional Quality of Fruits and Vegetables, Vol. 1, Fresh Fruits and Vegetables*, CRC Press, Boca Raton, 1991.
63. D.K. Salunkhe and B.B. Desai, *Postharvest Biotechnology of Vegetables*, CRC Press, Boca Raton, 1984.
64. D.K. Salunkhe, B.B. Desai, and J.K. Chavan, Potatoes. In *Quality and Preservation of Vegetables* (N.A.M. Eskin, Ed.), CRC Press, Boca Raton, 1989, p. 1.
65. M.E. Salveit, Ethylene effects. In *The Commercial Storage of Fruits, Vegetables, and Florist and Nursery Stocks—A Draft Version of the Revision to USDA Agricultural Handbook Number 66* (K.C. Gross, C.Y. Wang, and M. Saltveit, Eds.), 2002 ([www.ba.ars.usda.gov/hb66/index.html](http://www.ba.ars.usda.gov/hb66/index.html)).
66. R.P. Singh and D. Heldman, *Introduction to Food Engineering*, Academic Press, New York, 2003.
67. J. Smid, Y. De Witte, and L.G.M. Gorris, Secondary plant metabolites as control agents of postharvest *Penicillium* rot on tulip bulbs, *Postharv. Biol. Technol.* 6:303, 1995.
68. E.J. Smid, L. Hendriks, H.A.M. Boerrigter, and L.G.M. Gorris, Surface disinfection of tomatoes using the natural plant compound *trans*-cinnamaldehyde, *Postharv. Biol. Technol.* 9:343, 1996.
69. A.L. Snowdon, *A Color Atlas of Post-Harvest Diseases and Disorders of Fruits and Vegetables, Vol. 1: General Introduction and Fruits*, Wolfe Scientific, Barcelona, 1990.
70. A.L. Snowdon, *A Color Atlas of Post-Harvest Diseases and Disorders of Fruits and Vegetables, Vol. 2: Vegetables*, Wolfe Scientific, Barcelona, 1991.
71. N.F. Sommer, R.J. Forlage, and D.C. Edwards, Postharvest diseases of selected commodities. In *Postharvest Technology of Horticultural Crops* (A.A. Kader, Ed.), University of California, Division of Agriculture and Natural Resources, CA, 1992, p. 117.
72. D.H. Spalding, Resistance of mango pathogens to fungicides used to control post-harvest diseases, *Plant Disease* 66:1185, 1982.
73. T. Suslow, *Using Oxidation Reduction Potential (ORP)*. University of California Good Agricultural Practices, Regents of the University of California, 2005 ([http://groups.ucanr.org/UC\\_GAPs/Using\\_Oxidation\\_Reduction\\_Potential\\_\(ORP\)/](http://groups.ucanr.org/UC_GAPs/Using_Oxidation_Reduction_Potential_(ORP)/)).
74. A.K. Thompson, *Postharvest Technology of Fruits and Vegetables*, Oxford Blackwell Science Pub., 1996.
75. A.K. Thompson, *Controlled Atmosphere Storage of Fruits and Vegetables*, Wallingford, CAB International, 1998.
76. J.F. Thompson, Precooling and storage facilities. In *The Commercial Storage of Fruits, Vegetables, and Florist and Nursery Stocks—A Draft Version of the Revision to USDA Agricultural Handbook Number 66* (K.C. Gross, C.Y. Wang, and M. Saltveit, Eds.), 2002 ([www.ba.ars.usda.gov/hb66/index.html](http://www.ba.ars.usda.gov/hb66/index.html)).
77. L.H.W. van der Plas, Potato tuber storage: Biochemical and physiological changes. In *Potato. Biotechnology in Agriculture and Forestry* (Y.P. Bajaj, Ed.) Springer, Berlin, 1987, p. 109.
78. S. Wang, J.N. Ikediala, J. Tang, J.D. Hansen, E. Mitcham, R. Mao, and B. Swanson, Radio frequency treatments to control codling moth in in-shell walnuts. *Postharv. Biol. Technol.* 22:29, 2001.
79. L. Wang and D. Sun, Rapid cooling of porous and moisture foods by using vacuum cooling technology, *Trends Food Sci. Technol.* 12:174, 2001.
80. S. Wang, J. Tang, J.A. Johnson, E. Mitcham, J.D. Hansen, R.P. Cavalieri, J. Bower, and B. Biasi, Radio frequency treatments to control codling moth in in-shell walnuts. *Postharv. Biol. Technol.* 26:265, 2002.
81. J.B. Watkins, *Forced-Air Cooling*, Queensland Department of Primary Industries, Brisbane, 1990.
82. L.G. Wilson, M.D. Boyette, and E.A. Estes, Postharvest handling and cooling of fresh fruits, vegetables, and flowers for small farms. Part II Cooling, Horticulture Information Leaflet 801, North Carolina State University, North Carolina A&T State University, 1999 ([www.ces.ncsu.edu/depts/hort/hil/pdf/hil-801.pdf](http://www.ces.ncsu.edu/depts/hort/hil/pdf/hil-801.pdf)).
83. R.H.H. Wills, W.B. McGlasson, D. Graham, and D. Joyce, *Postharvest: An Introduction to the Physiology and Handling of Fruit Vegetables and Ornamentals*, New South Wales University Press, Sydney, 1998.
84. E.M. Yahia, Insecticidal atmospheres for tropical fruits. In *Harvest and Postharvest Technologies for Fresh Fruits and Vegetables* (L. Kushwaha, R. Serwatowski, and R. Brook, Eds.), American Society of Agricultural Engineers, Michigan, 1995, p. 282.

# 4

## *Postharvest Handling of Grains and Pulses*

Ajit K. Mahapatra and Yubin Lan

### CONTENTS

4.1	Properties, Grades, Harvesting, and Threshing.....	74
4.1.1	Structure and Composition of Cereal Grains and Legumes .....	74
4.1.1.1	Cereal Grains .....	74
4.1.1.2	Pulses .....	80
4.1.2	Grain-Grading Systems .....	81
4.1.2.1	Recent Progresses in Grain-Grading Technology.....	81
4.1.2.2	Grading Systems .....	82
4.1.2.3	Computer Vision Technology .....	82
4.1.3	Harvesting and Threshing .....	82
4.1.3.1	Combine Harvester .....	84
4.1.3.2	Whole-Crop Harvesting System .....	86
4.1.3.3	Stripper Harvester .....	89
4.2	Drying .....	91
4.2.1	Grain Drying: Basic Principles .....	91
4.2.1.1	Equilibrium Moisture Content .....	91
4.2.1.2	Water Activity and Storage Stability .....	94
4.2.2	Grain-Drying Systems .....	94
4.2.2.1	Natural-Air Drying .....	94
4.2.2.2	Heated-Air Drying .....	95
4.2.2.3	Drying with Supplemental Heat .....	96
4.2.2.4	Grain Dryers .....	96
4.2.3	Commercial Grain Dryers .....	96
4.3	Storage and Handling .....	98
4.3.1	Grain Storage: Perspectives and Problems .....	98
4.3.1.1	Environmental Factors Influencing Grain Quality .....	99
4.3.1.2	Types of Storage Facilities .....	101
4.3.1.3	Insects .....	106
4.3.1.4	Aeration.....	106
4.3.1.5	Grain Inspection .....	109
4.3.1.6	Chemical Methods .....	109
4.3.1.7	Rodents .....	112
4.3.2	Structural Considerations: Warehouse and Silo .....	113
4.3.2.1	Warehouses .....	113
4.3.2.2	Grain Bulk.....	114
4.3.2.3	Storage Structure Design .....	114
4.3.2.4	Grain Handling .....	116
4.3.3	Controlled Atmospheric Storage of Grain .....	117
4.4	Milling.....	118
4.4.1	Grain-Milling Operations.....	118
4.4.2	Specialty Milling .....	119



4.4.3	Rice Milling and Processing .....	121
4.4.4	Dehulling and Splitting of Pulses .....	122
4.4.4.1	Wet Milling of Pulses .....	122
4.4.4.2	Dry Milling of Pulses .....	122
4.4.5	Milling of Pulses .....	123
4.4.5.1	Milling Technologies .....	123
4.4.5.2	Unit Operations .....	124
4.4.5.3	Pulse Flour Milling .....	126
4.4.5.4	Fractionation .....	126
4.4.5.5	Milling Machinery .....	127
4.4.5.6	Pulse Milling .....	129
References	.....	129

## 4.1 Properties, Grades, Harvesting, and Threshing

### 4.1.1 Structure and Composition of Cereal Grains and Legumes

#### 4.1.1.1 Cereal Grains

Cereals have often been considered among the first cultivated crops. They are herbaceous plants belonging to the grass family Gramineae (the only exception being buckwheat) grown mainly for their grain [1]. Cereal grains such as wheat, rice, corn, barley, oat, rye, sorghum, and millet are used primarily for human consumption and animal feed. They are also used in the manufacture of beverages and industrial products (adhesives, starch). Cereal crops are energy-dense, containing 10,000–15,000 kJ/kg, about 10–20 times more energy than most succulent fruits and vegetables [2]. Nutritionally, they are important sources of dietary protein, carbohydrates, the B complex of vitamins, vitamin E, iron, trace minerals, and fiber. Cereal grains contain relatively little protein compared to legume seeds, with an average of about 10%–12% dry weight. Nevertheless, they provide over 200 MT of protein for the nutrition of humans and livestock, which is about three times the amount derived from the more protein-rich (20%–40%) legume seeds [3]. Global cereal consumption directly provides about 50% of protein and energy necessary for the human diet, with cereals providing an additional 25% of protein and energy via livestock intermediaries. In 2004, world cereal production amounted to 1985 million tonnes [4]. Major cereal grains produced worldwide include wheat, rice, corn, and barley. Corn, wheat, and rice together account for three-quarter of the world's grain production [5]. Other globally important cereal crops include sorghum, oats, millet, and rye. Asia, America, and Europe produce more than 80% of the world's cereal grains. Wheat, rice, sorghum, and millet are produced in large quantities in Asia; corn and sorghum are principal crops in America, whereas barley, oats, and rye are major crops in the former United Soviet Socialist Republic (USSR) and Europe.

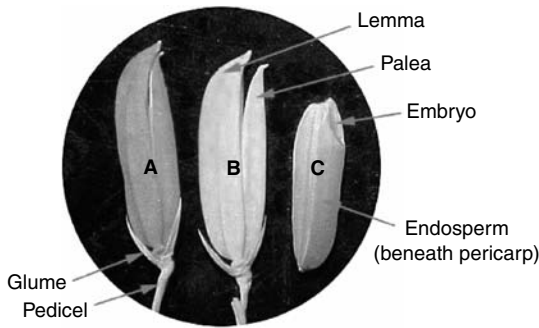
##### 4.1.1.1.1 Rice (*Oryza sativa* L.)

Rice is a member of the family Poaceae, and it is the major food for about one-third of the world population [6,7]. It has been estimated that 1.7 billion people depend on rice [8]. Cultivated in Asia for thousands of years, rice is also grown in many other parts of the world. Wild rice (*Zizania aquatica*) is native to North America where it was originally harvested from the wild by native Americans. Another North American wild rice or Indian rice is *Oryzopsis hymenoides*, native to mountains and valleys of Canada and the western United States. Although wild rice is now cultivated, it is expensive and accounts for less than 1% of the American rice market. The rice is first fermented to develop a nutty flavor and to ease hulling.

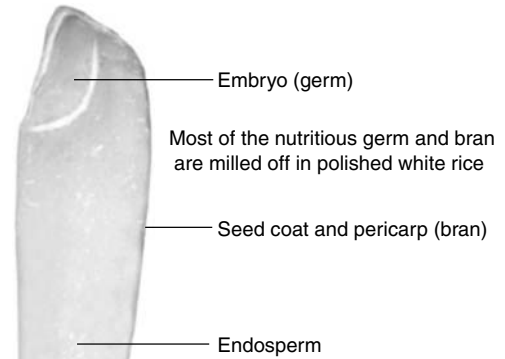
Rice is harvested with an outer hull or hull intact. This is commonly called rough rice or paddy. The hull, which constitutes about 20% of the weight of rough rice, is made up of the floral envelopes, the *lemma* and *palea*. Brown rice (rice after hulls removed) varies from 5 to 8 mm in length. The kernels weigh an average of about 25 mg and are about 2% pericarp, 5% seed coat and aleurone, 2%–3% germ, and 89%–94% endosperm [9]. The aleurone is the outermost layer of the endosperm. When brown rice is polished to form white rice during milling, the aleurone layer is removed along with the seed coat and pericarp to form the bran. The germ, the pericarp, and the aleurone layer are richer in nutrients as compared with endosperm and

they contain proteins and vitamins. A rice grain is shown in Figure 4.1. Figure 4.2 shows the longitudinal section of a rice grain, including the embryo (germ), pericarp (bran), and endosperm.

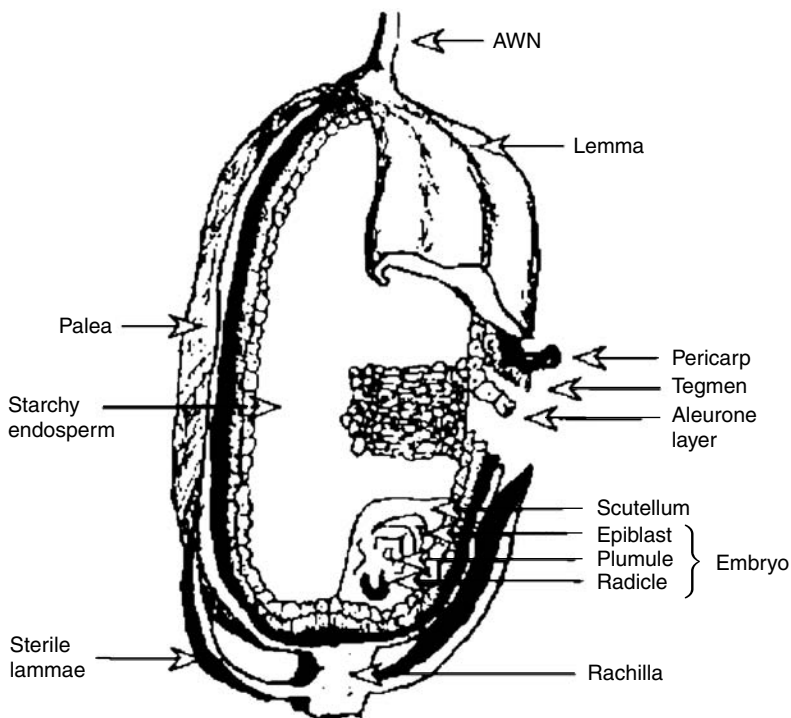
The embryo or germ is at the upper end. Beneath the brownish outer pericarp and seed coat layers (called the bran) is the endosperm tissue. Most of the vitamin B1 is found in the germ and bran portions, which are milled off in polished white rice. The detailed structure of a rice grain is shown in Figure 4.3, and further details can be found in Refs. [3,5,10].



**FIGURE 4.1** Rice grain. (A) Grain-bearing spikelet showing a pair of slender basal bracts (glumes) and the stalk (pedicel). The inflorescence is composed of numerous spikelets, each bearing a rice grain; (B) an empty spikelet with the lemma and palea slightly separated from each other. These two leathery bracts enclosed the grain or caryopsis; and (C) a grain (caryopsis) removed from the spikelet. (From <http://waynesword.palomar.edu/ecoph12.htm#rye>.)



**FIGURE 4.2** Longitudinal section of a rice grain. (From <http://waynesword.palomar.edu/ecoph12.htm#rye>.)



**FIGURE 4.3** Structure of a rice grain. (From N.F. Haard et al. *Fermented cereals: a global perspective*. Service Bulletin # 138. Food and Agricultural Organization, Rome, 1999.)

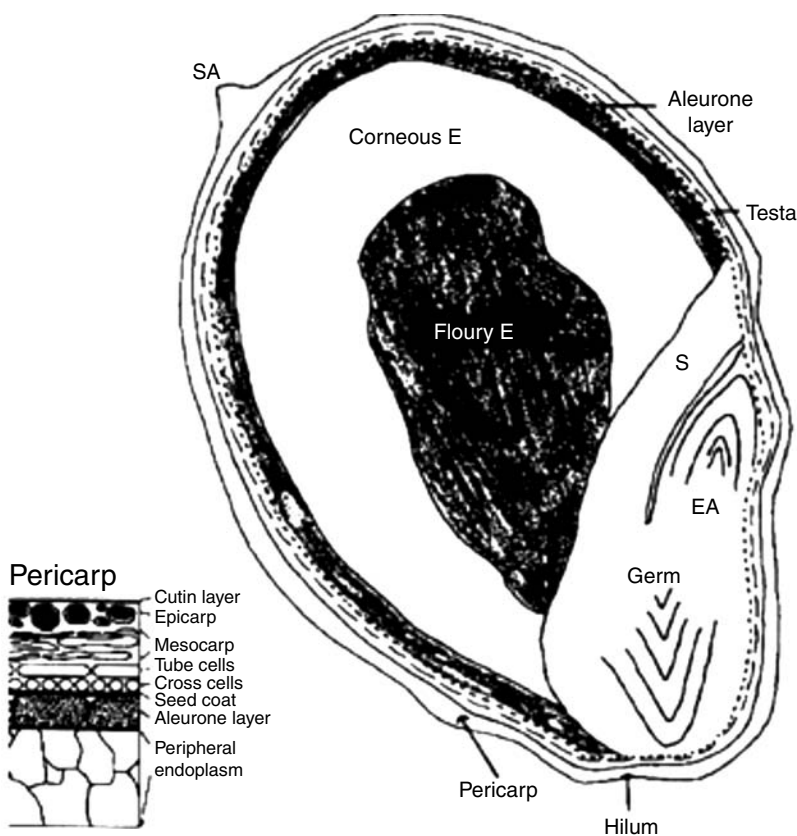
#### 4.1.1.1.2 Sorghum (*Sorghum bicolor* L. Moench)

Sorghum ranks fourth after rice, corn, and wheat in terms of importance for human nutrition [11]. The plant originated from equatorial Africa and is distributed throughout the tropical, semitropical, and arid regions of the world. Today sorghum is an important food crop in Africa [12,13] and Asia. There are four main types of sorghum based primarily on how it is used: (a) grain sorghums (including milo), (b) sweet sorghum or sorgo (used as feed), (c) Sudan grass (a different but related species), and (d) broom-corn. The grain is partially covered with glumes and the most common colors are white, bronze, and brown.

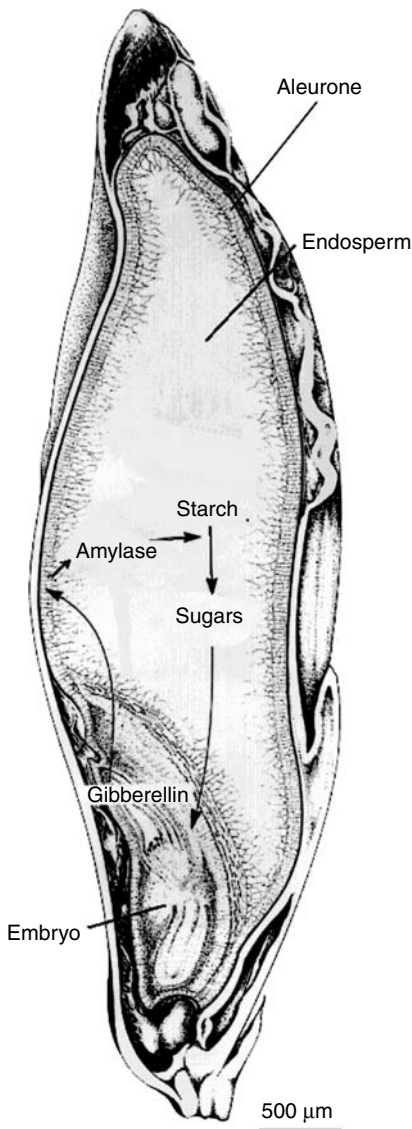
In North America, sorghum is used primarily as livestock feed. Commercial U.S. sorghums are generally 4 mm long, 2 mm wide, and 2.5 mm thick [14]. The kernels are generally spherical; weigh 20–30 mg; and may be white, red, yellow, or brown in color. Hand-dissected kernels are found to be 7.9% pericarp, 9.8% germ, and 82.3% endosperm [15]. The structure of a sorghum grain is shown in Figure 4.4, and further details can be found in Hoseney [15]. The outer thick pericarp of a kernel consists of three layers: the epicarp, the mesocarp, and the endocarp. Like corn kernels, sorghum kernels contain both translucent and opaque endosperm.

#### 4.1.1.1.3 Barley (*Hordeum vulgare* L.)

Barley, like rice and oats, retains its husk (or hull) following harvest. The hull consists of the *lemma* and *palea*. Underneath, the 35 mg kernels have the four basic grain components of pericarp, seed coat, germ, and endosperm. The barley kernel is generally spindle shaped. In commercial varieties grown in the United States, length varies from 7 to 12 mm. A longitudinal section of a barley grain is shown in Figure 4.5. The detailed structure of a barley grain is shown in Figure 4.6. Further details can be found in Ref. [16].



**FIGURE 4.4** Diagram of sorghum caryopsis showing the pericarp (cutin, epicarp, mesocarp, tube cells, cross cells, testa, pedicel, and stylar area [SA]), endosperm (E) (aleurone layer, corneous, and floury), and germ (scutellum [S] and embryonic axis [EA]). (From L.W. Rooney, F.R. Miller. *Proceedings of the International Symposium on Sorghum Grain Quality*. ICRISAT, Patancheru, India, 1981, p. 143.)



**FIGURE 4.5** Longitudinal section of a barley grain. (From <http://www.bio.psu.edu/people/faculty/gilroy/grain.GIF>.)

made up of three principal parts: hull or bran (pericarp and seed coat), germ, and endosperm. In addition, though, corn kernels frequently have the point of attachment of the cob (tip cap) intact.

Although corn's pericarp and seed coat are collectively called the hull, corn hulls are not the same as the true hulls of rice or barley. Approximately, 5%–6% of a corn kernel is made up of this outer covering, while 10%–14% is germ, with the remainder being endosperm [9]. The outer thin covering is made up of two layers, an outer pericarp and an inner testa or true seed coat. The endosperm consists almost entirely of starch, except in sweet corn. Corn is different from wheat in that both translucent and opaque endosperms are found within a single kernel. Corn kernels or seeds vary in size and shape in different kinds and varieties. The embryo is near one side of the kernel in most kinds rather than in the middle, which contains most of the oil in corn. A longitudinal section of a corn kernel is shown in Figure 4.8, and additional details on the grain structure of corn have been documented by Hosney [15].

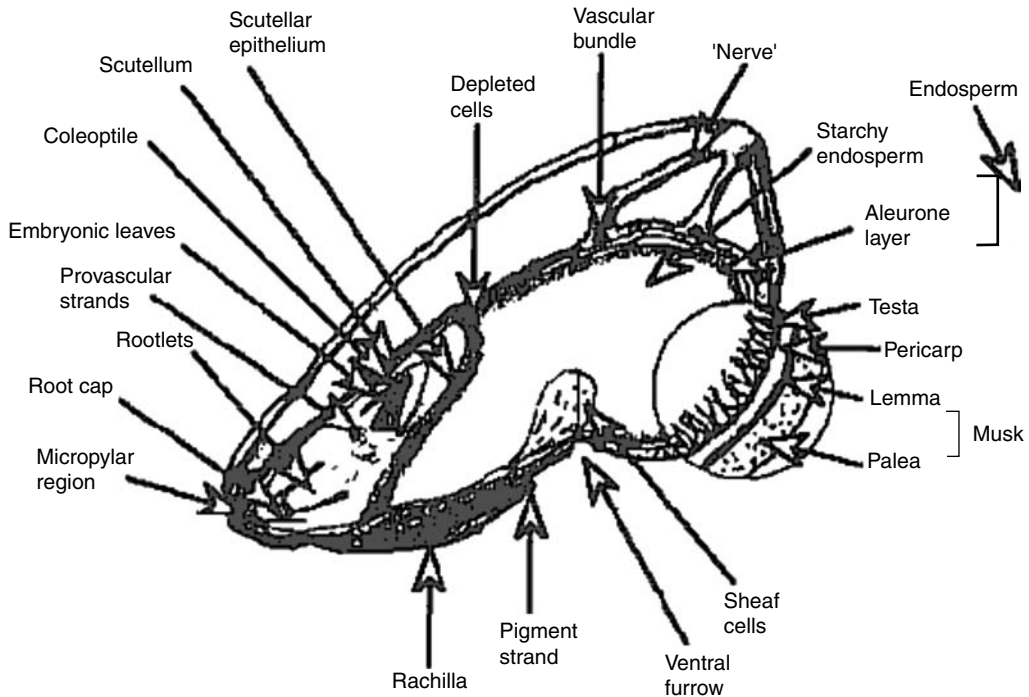
#### 4.1.1.1.4 Wheat (*Triticum aestivum*)

Wheat is native to southwest Asia and the Mediterranean region. Common or bread wheat is widely cultivated in most parts of the world and is the principal staple food of humans. Wheat grains, botanically, are the fruits (caryopsis) of the wheat plant. Mature wheat grain or kernel is roughly ovate or egg shaped. The kernels average about 8 mm in length and weigh about 35 mg [15]. The dorsal surface is generally smooth and rounded, but the ventral surface is creased. At the apex, a brush consisting of short hairs is generally present. Color of the kernel varies from dark red through light brown—classed commercially as red wheat—to white, cream, or yellow—classed commercially as white wheat—or amber, in durum wheat.

The wheat kernel structure is shown in Figure 4.7. The kernel consists of three main parts, namely the bran, the endosperm, and the germ or embryo. The outer covering consists of several distinct cell layers collectively called the bran is separated from the flour during most milling processes. It comprises about 12% of the kernel weight. The aleurone, which forms the outer periphery of the endosperm and the innermost layer of the bran, accounts for 3%–4% of the weight of the kernel; it is usually removed with the bran during milling. The endosperm consists mainly of starch and makes up about 85%–86% of the kernel. It is the portion present in white flour. Approximately 2.5%–3.5% of a wheat kernel is germ [9] and is separated out in most milling processes. Because it provides nourishment for germination, the germ contains high levels of protein, sugar, and oil. The grain structure of wheat has been documented by Laszity [17].

#### 4.1.1.1.5 Corn (*Zea mays L.*)

Corn is the world's most widely grown cereal crop and an essential food source for millions of people in Africa [18], Asia, and Latin America. Corn exists in many varieties and colors, but dent corn is the type used for milling. Corn's flat, broad seeds average around 350 mg, making it the largest of the common cereal seeds. The kernel is



**FIGURE 4.6** Structure of a barley grain. (From N.F. Haard et al. *Fermented cereals: a global perspective*. Service Bulletin # 138. Food and Agricultural Organization, Rome, 1999.)

#### 4.1.1.1.6 Oat

Oats are generally eaten as wholegrain flakes and the processing contains a heating stage to inactivate enzymes [19]. Most oats are covered in a tough, inedible hull, which must be removed prior to human consumption. The hull contributes to about 30% of the total kernel weight. The oats are called groats after the hulls have been removed [20]. The structure of the oat kernel is shown in Figure 4.9.

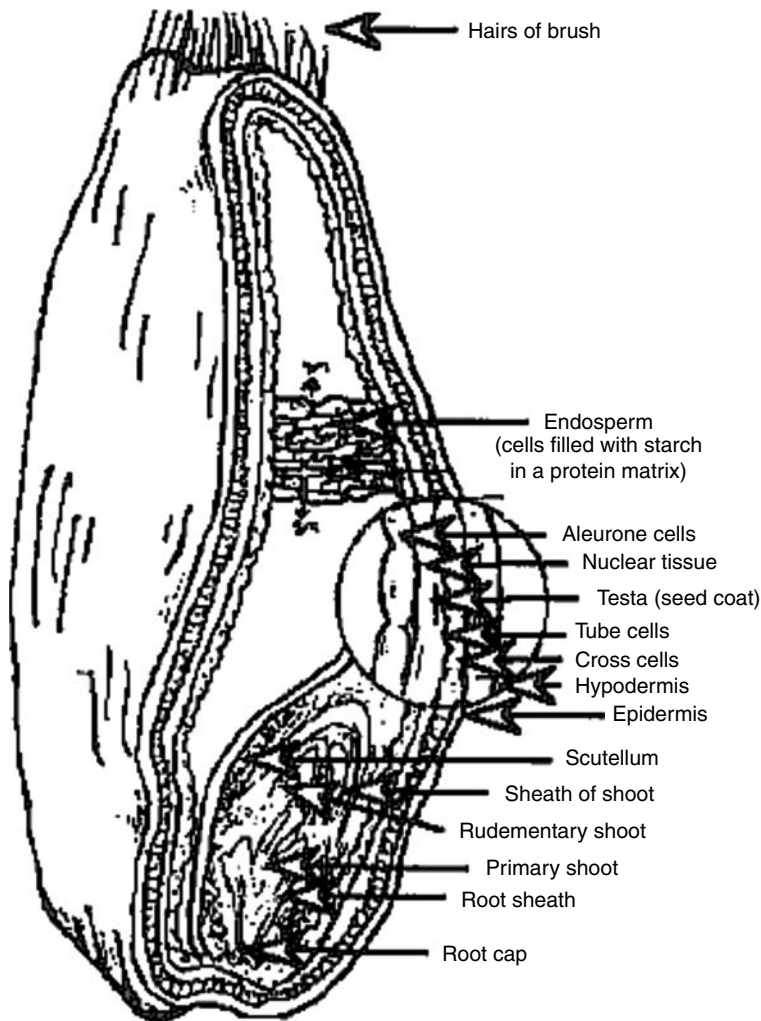
Oats, as with barley and rice, retain the hull formed by a floral envelope. Underneath, the oat kernel (called a groat) is similar to wheat or rye. The germ, however, is much larger and narrower than that of wheat and it extends from 25% to 33% of the length of the groat [9].

The oat groat consists of pericarp, seed coat, hyaline layer, germ, and endosperm. The aleurone makes up the outer layer of the endosperm. Compared with other cereals, oat endosperm contains higher levels of protein and oil. Oat starch is like rice starch in that it exists as compound starch granules, which are large granules made up of many smaller individual granules.

#### 4.1.1.1.7 Rye (*Secale cereale* L.)

Rye is a special kind of European cereal and more than 90% of the world's production is grown in Europe [21]. Rye kernels are harvested hull-free and have the typical grain caryopsis components. The kernels are grayish in color, 6–8 mm in length, and 2–3 mm in width. Like the other cereals, rye consists mainly of pericarp, seed coat, aleurone layer, germ, and endosperm. The endosperm is surrounded by a single layer of aleurone cells. The starch in the endosperm cells has large lenticular and small spherical granules, like wheat and barley. The longitudinal section of a rye grain is shown in Figure 4.10. A microscopic picture of the grain is presented in Figure 4.11.

Before rye grains can be used in food production, the outer part of the grain, the hull, must be removed. After hulling, which generally occurs during threshing, the grains are used whole, cracked or flaked, or they are ground to make flakes or flour. The starchy endosperm constitutes about 80%–85% of the weight of the whole kernel, the germ about 2%–3%, and the outer layers about 10%–15% [23].



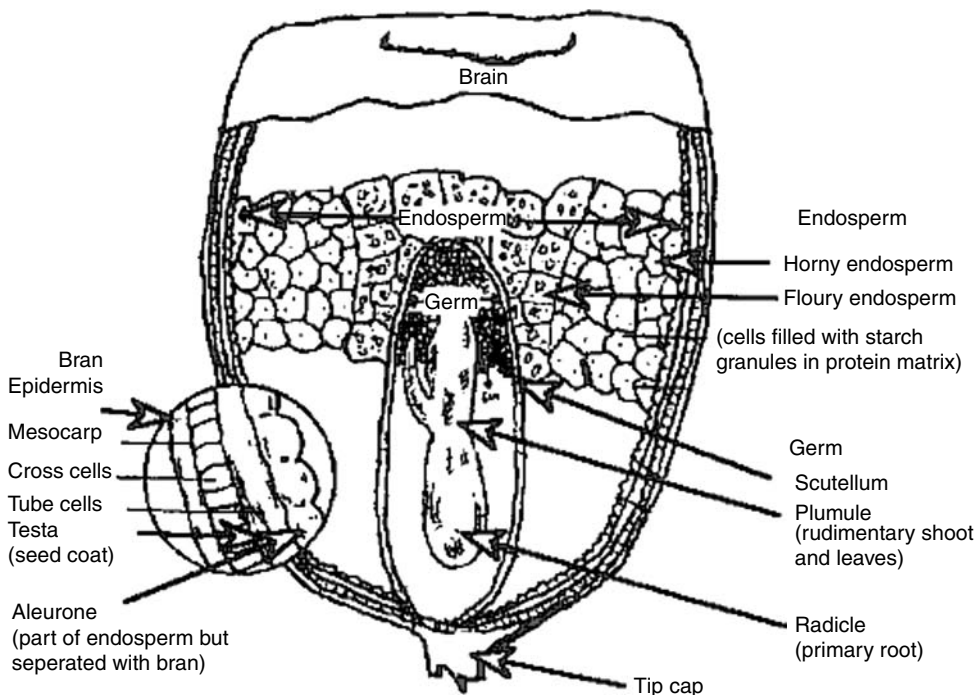
**FIGURE 4.7** Structure of a wheat kernel. (From N.F. Haard et al. *Fermented cereals: a global perspective*. Service Bulletin # 138. Food and Agricultural Organization, Rome, 1999.)

#### 4.1.1.1.8 Pearl Millet (*Pennisetum glaucum*)

Millet and sorghum are often grouped together because their growing conditions, processing, and uses are almost similar. Pearl millet is one of the two major crops grown in the semiarid, low-input dryland agriculture regions of Africa and Southeast Asia [24]. Millet was domesticated in Africa some 3000–5000 years ago, and subsequently spread to southern Asia. Pearl millet consists of small (average about 8.9 mg) tear-shaped kernels that are threshed clean of their hulls [15], and, depending on head size, grain number per head ranges from 500 to 3000 [25]. The caryopsis is very similar to those of other cereal grains. The germ in pearl millet is relatively large (17%) in proportion to the rest of the kernel. Its endosperm has both translucent and opaque endosperm, as those of sorghum and corn. Pearl millet consists of 8.4% pericarp, 75% endosperm, and 6.5% germ [26].

#### 4.1.1.1.9 Chemical Composition

The relative proportions of main grain components for different grains are presented in Table 4.1. The grain is composed of both organic and inorganic substances such as carbohydrates, proteins, vitamins, fats, ash, water, mineral salts, and enzymes. Cereal grains are rich in carbohydrates, whereas legumes are rich in proteins. The composition of some of the cereal grains is shown in Table 4.2.



**FIGURE 4.8** A longitudinal section of a corn kernel. (From N.F. Haard et al. *Fermented cereals: a global perspective*. Service Bulletin # 138. Food and Agricultural Organization, Rome, 1999.)

#### 4.1.1.2 Pulses

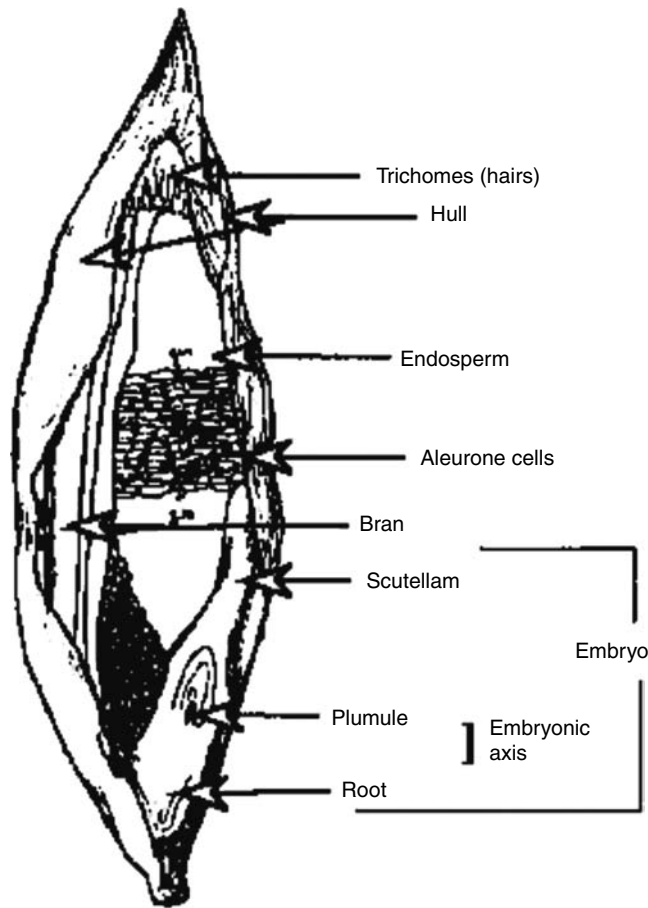
Pulses are annual leguminous crops yielding 1–12 grains or seeds of variable size, shape, and color within a pod. Pulses include dry peas, dry beans, vetches, lupins, dry broad beans, lathyrus, lentil, black gram, mung bean, chickpea, pigeon pea, and cowpea. They are used for both food and feed, and are important foodstuff in most of the tropical and subtropical countries [29]. The term “pulses” is limited to crops harvested for dry product only, excluding therefore crops harvested green for forage, used for grazing, or as green manure, and also crops harvested green for food (green beans, green peas, etc.). They also exclude those used mainly for extraction of oil (soybeans and groundnuts) and crops whose seeds are used exclusively for sowing purposes, such as alfalfa and clover [1].

##### 4.1.1.2.1 Composition

Pulses contain carbohydrates, mainly starches (55%–65% of the total weight); proteins, including essential amino acids (18%–25%, and much higher than cereals); and fat (1%–4%). Pulses are the richest source of vegetarian protein [30–32]. The proportion of seed coat, cotyledon, and embryo in different legumes is presented in Table 4.3.

##### 4.1.1.2.2 Structure

The structure of leguminous food plants is similar. Mature legume seeds have three major components: the seed coat, the cotyledons, and the embryo axis, which constitute 8%, 90%, and 2% of the seed, respectively [5]. The structure of a typical legume seed is shown in Figure 4.12. The outer layer of the seed is the testa or seed coat. Usually, legumes have a moderately thick seed coat. In most legumes, the endosperm is short-lived and, at maturity, it is reduced to a thin layer surrounding the cotyledons or embryo. The cotyledons are the major source of nutrients in pulse grains. Legumes contain an appreciable amount of protein and are good source of minerals. The compositions of some of the Canadian pulses are presented in Table 4.4.



**FIGURE 4.9** Structure of an oat kernel. (From N.F. Haard et al. *Fermented cereals: a global perspective*. Service Bulletin # 138. Food and Agricultural Organization, Rome, 1999.)

#### 4.1.2 Grain-Grading Systems

Grain-grading systems used around the world are similar and depend mainly on visual inspection and comparison of samples [36]. In Canada, grain is graded on the five factors, namely, test weight, varietal purity, soundness, vitreousness, and maximum limit of foreign material (not including dockage). Of these, the latter four factors are determined visually by trained personnel, and thus can be influenced by experience and human fatigue [37]. In Australia, grain is routinely segregated based on moisture and protein contents determined by near-infrared spectroscopy [38]. Despite training, the grading decisions are inherently subjective and are influenced by the individual experience of a grain inspector [36].

The grading factors in European Union countries include moisture, broken kernels, grain besatz (shrunken kernels, other grains, insect-damaged kernels), sprouted kernels, black besatz (wheat seed, ergot, unsound grain, chaff, impurities), and hectoliter weight. In Russia, color, odor, taste, moisture, foreign kernels, and damaged kernels are listed as grading factors [21].

##### 4.1.2.1 Recent Progresses in Grain-Grading Technology

Research has been carried out to replace the tiresome job of visually inspecting grain samples by a machine vision system (MVS). Such an MVS should be capable of identifying and grading the grain on the basis of size and shape [39], color [40,41], and texture [42]. Color and size are important grading factors for certain commodities such as peas and chickpeas.



Several systems have been reported in the literature for inspecting grains using machine vision [43,44]. For classification purposes, shape is the best feature followed by color and length of the kernels [37]. Visual appeal directly influences consumer acceptance and hence value of the grains. The main visual factor is the color of grain, which is directly related to its market value [45]. Some investigations have been carried out using color features [46] for classification of different cereal grains and their varieties and for correlating vitreosity and grain hardness. Liu and Paulsen [47] measured the whiteness of corn quantitatively by computer vision. This is a useful application as the prices of corn depend on color [48].

In recent years, optical, mechanical, and electrical techniques have been applied to rapid grain grading and classification [49]. Delwiche et al. [50], using near-infrared spectroscopy with an artificial neural network, identified hard red winter and hard red spring wheat classes with accuracies of 95%–98%. Steenhoek et al. [51] developed a computer vision system to evaluate blue-eye mold and germ damage in corn grading. Sapirstein et al. [52] employed image processing to identify grains such as wheat, oats, barley, and rye. Gunasekaran et al. [53] detected stress cracks and other damage in corn kernels and soybeans from their images. Shatadal et al. [54] used parameters such as area, length, width, and compactness of grain binary images to recognize wheat, oats, barley, and rye. Zayas et al. [55] determined wheat variety by using the texture characteristics of wheat images. The Canadian Grain Commission (CGC) has developed a grading instrument for assessing the color and size distribution of lentils. Modules for grading other pulse grains such as peas, chickpeas, and beans are under development [56].

Stress fissure detection is one of the most important tasks in rice grain quality inspection. An MVS has been used successfully to reveal fissure lines in rice [57]. Peck damage is another quality factor affecting the grading and marketing of rice. The rice stinkbug, *Oebalus pugnax*, is a key pest that causes peck damage. An objective method has been developed to classify pecky rice kernels [58].

#### 4.1.2.2 Grading Systems

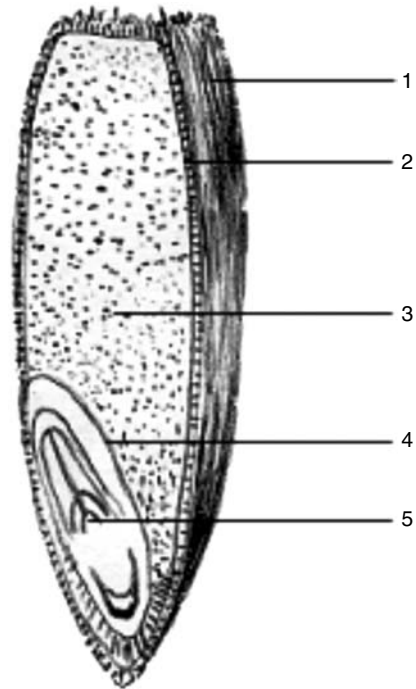
Grading systems are used in the marketing of grains. The grade standing systems are not universal and vary significantly between countries. The US grading system for yellow corn is presented in Table 4.5. The grading systems for wheat in Germany and Italy are presented in Tables 4.6 and 4.7, respectively.

#### 4.1.2.3 Computer Vision Technology

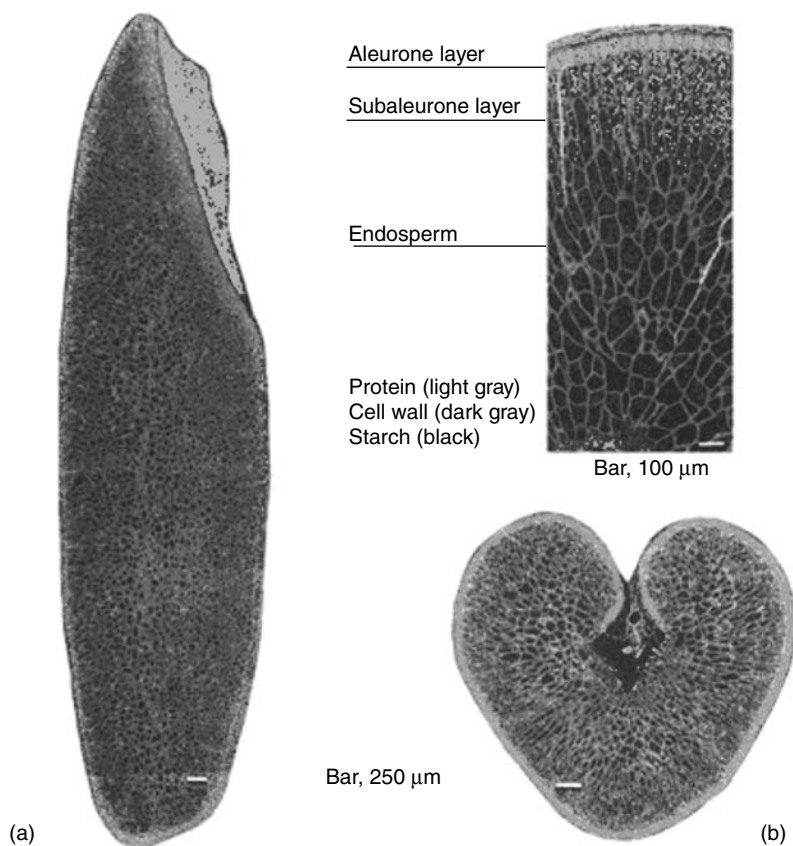
A fast and objective grain grading and classification system would reduce the inaccuracy caused by inspector subjectivity. Grain quality inspection using computer vision is a nondestructive method. However, the application of computer vision technique for objective classification of cereal grains and varieties is still at its infant stage. Further development in both software and hardware is necessary for this technology to be used more widely.

#### 4.1.3 Harvesting and Threshing

Harvesting of cereal grains and pulses refers to the activities performed to obtain the kernels of the plant for grain, or the entire plant for forage and silage uses. These activities are accomplished by machines that cut, thresh, screen, clean, bind, pick, and shell the crops in the field. Harvesting also includes loading harvested crops into trucks and transporting crops in the grain field [60].



**FIGURE 4.10** A longitudinal section through a rye grain. 1, Multilayer husk and seed coat; 2, aleurone layer; 3, endosperm; 4, scutellum; 5, embryo. (From Gesamtverband der Deutschen Versicherungswirtschaft. In: *CHB Container Handbook*. Berlin: German Insurance Association, Transport and Loss Prevention Department, 2005.)



**FIGURE 4.11** Microscopic picture of rye grain. (a) Rye kernel. (b) Transverse section of rye kernel. (From Nordic Rye Group, In: T. Kujala, Ed. *Rye and Health*. Nuijalantie, Finland: The Nordic Rye Group, 1994.)

**TABLE 4.1**

Grain Size and Proportions of the Principal Parts of Mature Kernels

Cereal	Germ (%)	Pericarp (%)		Aleurone (%)	Endosperm (%)
Barley	3.4	18.3		←	79 →
Corn	2.7	7.9		6.7–7.0	81–84
Oat	3.7	28.4–41.4		→	
Pearl millet	17.4	←	7.5	→	75
Rice	3.5	1.5		4–6	89–94
Rye	3.5	12.0		←	85 →
Sorghum	7.8–12.1	←	7.3–7.9	→	80–85
Wheat (bread)	2.7	7.9		6.7–7.0	81–84
Wheat (durum)	1.6	12.0		←	86 →

Source: R.C. Hoseney, J.M. Faubion. In: D.B. Sauer, Ed. *Storage of Cereal Grains and Their Products*, 4th ed. St. Paul, MN: American Association of Cereal Chemists, 1992.

Cereal kernels are cut as close as possible to the inflorescence. This portion is threshed, screened, and cleaned to separate the kernels. The grain is stored in the harvesting machine while the remainder of the plant is discharged back onto the field. Combines perform all the above activities in one operation. Large amounts of abrasion and breakage may occur as a result of threshing, augering, and impaction when harvested by combine, followed by transfer from combines to grain trucks with subsequent transfer to farm storage [61]. Binder machines only cut the grain plants and tie them into bundles, or leave them in a row in the field, called a windrow. The bundles are allowed to dry for threshing later by a combine with a pickup attachment.

**TABLE 4.2**

Proximate Composition of Cereal Grains (% Dry Weight)

Cereals	Crude Protein	Crude Fat	Ash	Crude Fiber	Carbohydrate
Barley	11.0	3.4	1.9	3.7	55.8
Corn	9.8	4.9	1.4	2.0	63.6
Oats	9.3	5.9	2.3	2.3	62.9
Pearl millet	11.5	4.7	1.5	1.5	63.4
Rice, brown	7.3	2.2	1.4	0.8	64.3
Rye	8.7	1.5	1.8	2.2	71.8
Sorghum	8.3	3.9	2.6	4.1	62.9
Wheat	10.6	1.9	1.4	1.0	69.7

Source: C. Alais, G. Linden. *Food Biochemistry*. New York: Ellis Horwood, 1991, p. 222.

**TABLE 4.3**

Proportion of Seed Coat, Cotyledons, and Embryo for Some Selected Legumes

Legume	Seed Coat (%)	Cotyledon (%)	Embryo (%)
Cowpea	10.64	87.23	2.13
French bean	8.64	90.37	0.99
Lentil	8.05	89.97	1.98
Mung bean	12.09	85.61	2.30
Peas	10.00	89.28	1.72
Pigeon pea	15.50	83.00	1.50

Source: G. Leubner. *The Seed Biology Place*, 2003, <http://www.seedbiology.de/>.

Corn is harvested by mechanical pickers, picker/shellers, and combines with corn head attachments. These machines cut and husk the ears from the standing stalk. The sheller unit also removes the kernels from the ear. After husking, a binder is sometimes used to bundle entire plants into piles (called shocks) to dry [60]. For forage and silage, binders, crushers, field choppers, mowers, windrowers, and similar cutting machines are used to harvest grasses, stalks, and cereal grains. These machines cut the plants as close to the ground as possible and leave them in a windrow. The plants are later picked up and tied by a baler. Harvested crops are loaded onto trucks in the field. Grain kernels are loaded through a spout from the combine, and forage and silage bales are manually or mechanically placed in trucks. The harvested crop is then transported from the field to a storage facility [60].

#### 4.1.3.1 Combine Harvester

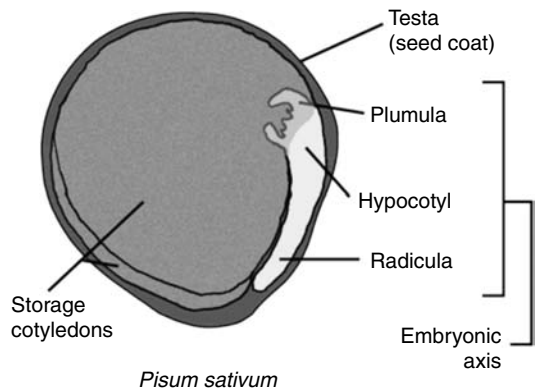
Grain harvesting and handling procedures have undergone dramatic changes, particularly with the development of the combine harvester. The combine harvester has become the standard for harvesting grains in the industrialized countries [62], which can perform labor-intensive operations such as harvesting and

**TABLE 4.4**

Composition of Some of the Canadian Pulses

Pulses	Protein	Fat	Ash	Fiber	Starch
Bean	25.1	1.5	4.3	15.3	38.0
Chickpea (desi)	23.0	5.4	3.2	25.9	36.4
Chickpea (kabuli)	24.4	5.9	3.2	8.7	41.1
Field pea	23.7	1.3	2.8	16.6	45.5
Lentil	26.3	1.1	2.8	13.6	45.0

Source: N. Wang, J.K. Daun. *The Chemical Composition and Nutritive Value of Canadian Pulses*. Winnipeg: Canadian Grain Commission, 2004.



**FIGURE 4.12** Drawing of a mature pea (*Pisum sativum*) seed, a typical nonendospermic seed with storage cotyledons and the testa. (From D.K. Salunkhe et al. *Post-Harvest Biotechnology of Food Legumes*. Boca Raton, FL: CRC Press, 1985, pp. 29–52.)

TABLE 4.5

US Grade Requirements for Yellow Corn

Grade	Minimum Test Weight/ Bu (lb)	Heat-Damaged Kernels, Maximum Limit (%)	Total-Damaged Kernels, Maximum Limit (%)	Broken Corn and Foreign Material
US No. 1	56.0	0.1	3.0	2.0
US No. 2	54.0	0.2	5.0	3.0
US No. 3	52.0	0.5	7.0	4.0
US No. 4	49.0	1.0	10.0	5.0
US No. 5	46.0	3.0	15.0	7.0
US sample grades <sup>a</sup>				

<sup>a</sup>US sample grade is corn that does not meet the requirements for US grade Nos. 1, 2, 3, 4, or 5; contains eight or more stores that have an aggregate weight in excess of 0.20% of its sample weight, or two or more pieces of glass; has a musty, sour, or commercially objectionable foreign order; or is heating otherwise of distinctly low quality.

Source: F.W. Bakker-Arkema, Ed. *CIGR Handbook of Agricultural Handbook*. St. Joseph, MI: ASABE, 1999, pp. 1–11.

TABLE 4.6

Wheat Classification System in Germany

Parameter	Quality Class			
	Elite (E)	High Quality (A)	Normal (B)	Soft (K)
Protein (%) min.	13.8	13.2	12.8	12.4
Sedimentation (mL) min.	47	33	26	19
Flour yield (%) min.	76	74	74	76
Water absorption (%) min.	56.9	55.9	53.7	52.6
Falling number (s) min.	285	255	255	235
Loaf volume (mL/100 g) min.	710	650	590	560

Source: R. Lasztity, A. Salgo. *Periodica Polytechnica Ser. Chem. Eng.*, 46(1–2): 5–13, 2002.

TABLE 4.7

Italian System of Classification of Common Wheat

Class	Alvo-Graph		Protein N5.7 (%)	Farinographs	Falling Number (s)
	W	P/L		Stability (min)	
Improver	300	1	14.5	15	250
High quality	220	0.6	13.5	10	220
Normal bread wheat	160	0.6		5	220
For confectionary products	115	0.5		—	240

Source: R. Lasztity, A. Salgo. *Periodica Polytechnica Ser. Chem. Eng.*, 46(1–2): 5–13, 2002.

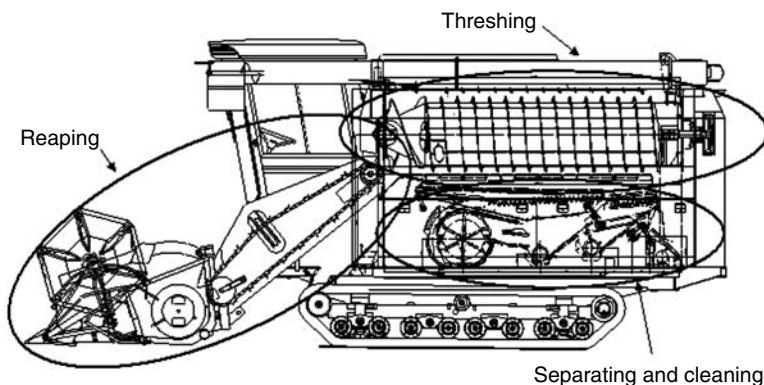
threshing simultaneously at the field level. Combines are able to fill their grain tanks within 12 min and can off-load to a grain cart in as little as 2½ min [63].

#### 4.1.3.1.1 Function of a Combine Harvester

The main process functions of a combine harvester (Figure 4.13) consist of reaping, threshing, separating, and cleaning (Figure 4.14). The threshing function is especially very important because the quality of grain harvested into the tank of the combine harvester depends mainly on the ability of this function [64].



**FIGURE 4.13** Combine harvester. (From M. Miyamoto, H. Murase. Study of threshing function of combine harvester with artificial neural network. Paper No. 033012. St. Joseph, MI: American Society of Agricultural Engineers, 2003.)



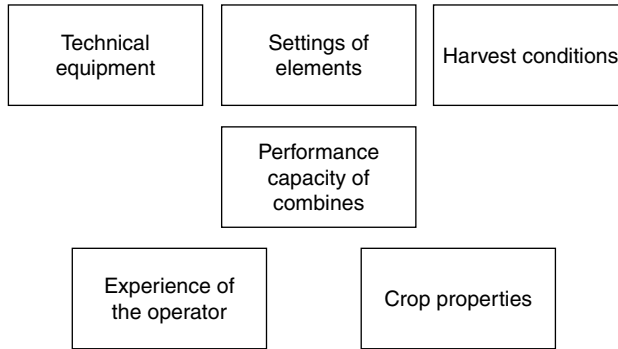
**FIGURE 4.14** Main process functions of combine harvester. (From M. Miyamoto, H. Murase. Study of threshing function of combine harvester with artificial neural network. Paper No. 033012. St. Joseph, MI: American Society of Agricultural Engineers, 2003.)

#### 4.1.3.1.2 Performance of a Combine Harvester

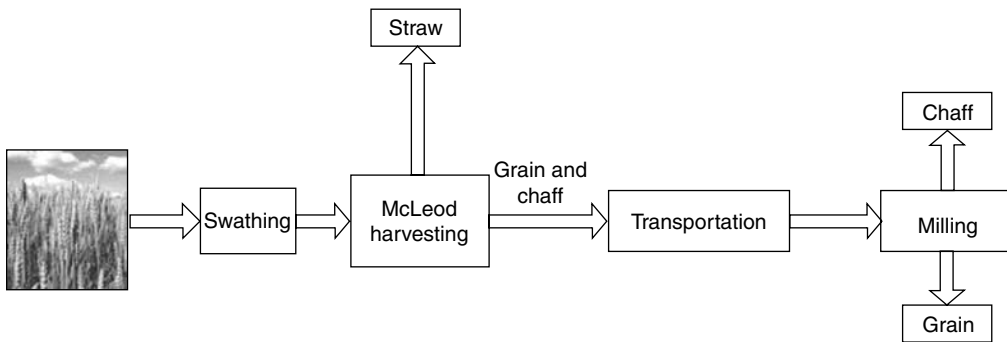
The performance depends on its design, the settings of the individual working elements, the experience of the operator, the harvest conditions, and very strongly on the properties of the harvested materials (Figure 4.15). The technical equipment includes the design of the combine, the threshing and separating system, the dimensions of the individual elements, and engine power. Settings of elements may consist of speed of the working elements and the concave clearance. Harvest conditions are influenced mostly by the weather, topography, soil conditions, and field size. Though operators are supported by various electronic systems, operators' experience helps in reaching a high field performance. Grain properties strongly influence performance capacity and therefore the field performance [62].

#### 4.1.3.2 Whole-Crop Harvesting System

Conventional combine harvesting systems harvest only grains and leave the straw and chaffs on the field. If the crop residues are utilized for bioenergy production it has to be harvested with extra cost. Recently, utilization of crop residues for bioenergy production increased the monetary value of crop residues [65]. Hence, there is a need to harvest both cereal grains as well as crop residues for maximizing profit.



**FIGURE 4.15** Influences on the performance capacity of combines. (From P. Wacker. In: G.R. Quick, Ed. *Proceedings of the International Conference on Crop Harvesting and Processing*, Louisville, KY, 2003.)



**FIGURE 4.16** Sequential operation of McLeod harvesting system. (From S. Sokhansanj et al. Dynamic simulation of McLeod harvesting system for wheat, barley, and canola crops. Paper No. 048010. St. Joseph, MI: American Society of Agricultural Engineers, 2004.)

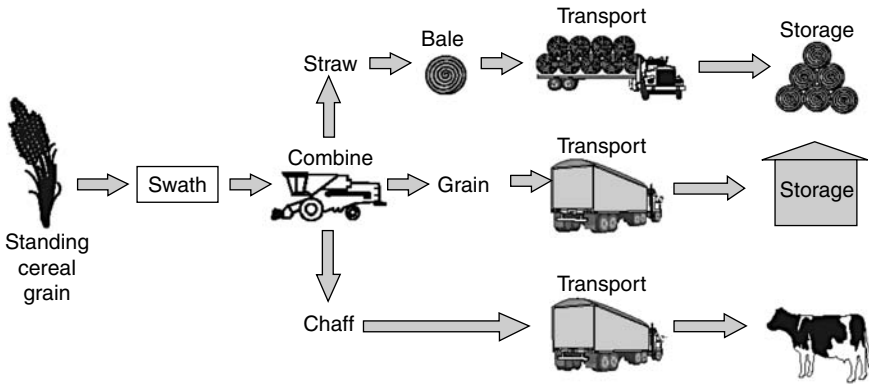
In case of a whole-crop harvesting system, the whole crop is harvested and transported to a centrally located processing unit where the crops are separated into grains, straws/stover, and chaffs. The cereal grains can be supplied to processing and storage facilities, and straws with high moisture content can be processed into different raw materials based on the requirement of biorefineries.

In the McLeod harvest system, developed by Bob McLeod in western Canada, the harvesting unit cuts the whole crop and threshes to separate the graffs (grains, chaffs, and weed seeds) from the straw [65]. The straws are left on the field for further drying and baling operation. The graff is transported to a central location, where it is further processed to separate grains from chaffs and weed seeds by a milling unit. Figure 4.16 shows the sequential operation of the McLeod harvesting system. It has been reported that the McLeod system is more profitable than the conventional combine harvesting system [66].

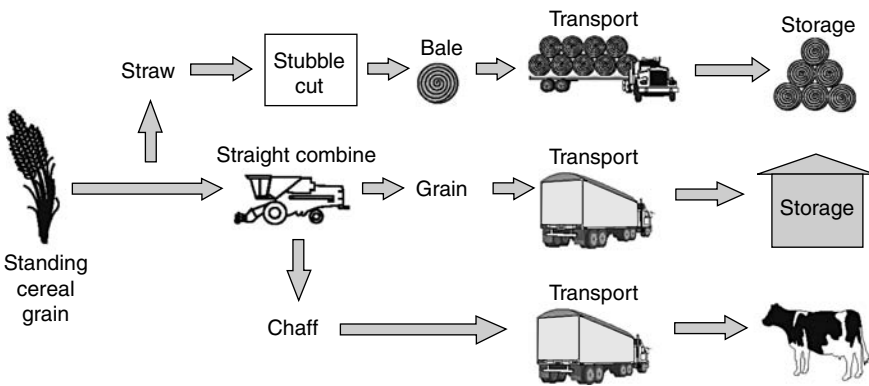
As new markets begin to emerge for straw and chaff, such as ethanol production and strawboard manufacturing, innovative methods of whole-crop harvesting are being proposed. Five methods of harvesting, namely, windrow/combine, straight cut, stripper header, McLeod system, and whole-crop baling, have been modeled and compared by Ragan [67].

#### 4.1.3.2.1 Windrow/Combine

The crop is windrowed (swathed) and then harvested with a standard combine with a pick-up header. Straw and chaff are spread behind the combine or dropped in a windrow for baling later. As the system involves separate cutting and threshing operations, additional power is required to pass the entire crop through the combine. Hence, energy consumption is substantially higher than for other systems, and the combine work rate is slow because it processes nearly all the available plant material [67]. Conventional swath and combine harvesting method is shown in Figure 4.17.



**FIGURE 4.17** Conventional swath and combine harvesting method. (From G. Ragan. Modeling and comparing whole-crop harvesting systems. Agricultural, Food and Rural Development, Government of Alberta, 2005.)



**FIGURE 4.18** Conventional straight-cut harvesting method. (From G. Ragan. Modeling and comparing whole-crop harvesting systems. Agricultural, Food and Rural Development, Government of Alberta, 2005.)

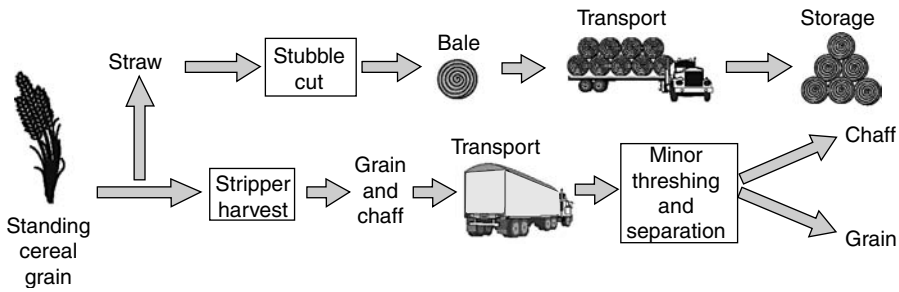
#### 4.1.3.2.2 Straight Cut

The straight-cut system requires one less field operation than the windrow/combine system, resulting in less time in the field and lower energy consumption. However, straight-cutting system cannot be used with crops such as pulses and oil seeds. The longer stubble resulting from the higher cut may reduce efficiency in chaff and straw recovery [67]. Figure 4.18 shows the conventional straight-cut harvesting method.

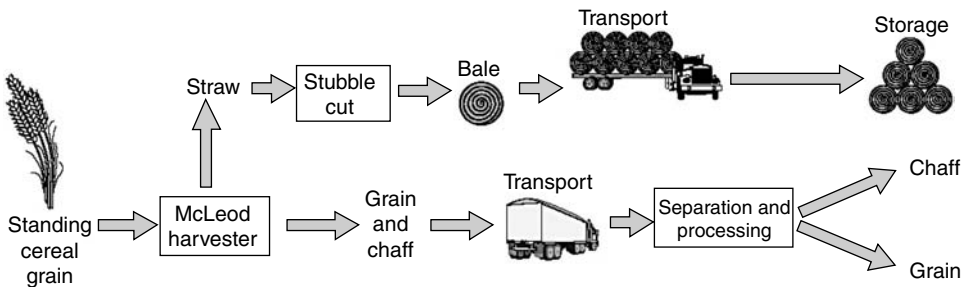
#### 4.1.3.2.3 Stripper Header

Currently, stripper headers are used on conventional combines in place of the straight-cut or pick-up header. Most of the threshing is done by the header, and as a result much of the capacity of the combine itself is not used. A specifically designed harvesting machine would need to be developed to operate with the stripper header to fully capture its inherent advantages.

The stripper header is a very efficient method of collecting grain because of its low energy needs and the short time required for harvesting. In effect, the stripper header removes the heads from the crop and leaves the straw standing. A separate operation is then required to cut the straw, so other field operations such as seeding can be conducted with a minimum of problems. Also, some of the straw is flattened in the harvesting operation, making it more difficult to recover later. A limitation is that the stripper header may only be used efficiently with cereal grains [67]. The stripper header harvesting method is shown in Figure 4.19.



**FIGURE 4.19** Stripper header harvesting method. (From G. Ragan. Modeling and comparing whole-crop harvesting systems. Agricultural, Food and Rural Development, Government of Alberta, 2005.)



**FIGURE 4.20** McLeod harvesting method using straight-cut header. (From G. Ragan. Modeling and comparing whole-crop harvesting systems. Agricultural, Food and Rural Development, Government of Alberta, 2005.)

#### 4.1.3.2.4 The McLeod System

This system is being developed by Bob McLeod of Winnipeg. It consists of a standard combine straight-cut header with a feeder housing and threshing cylinder. The grain and chaff are collected together in a large hopper and the straw passes over a set of straw walkers to collect any free grain. The unit would be pulled by a large two-wheel drive tractor. The grain/chaff mixture would then be transported to the farmyard where it would be processed further by an electric motor-driven unit already developed by McLeod [67]. Figure 4.20 shows the McLeod harvesting method using straight-cut header.

#### 4.1.3.2.5 Whole-Crop Baling

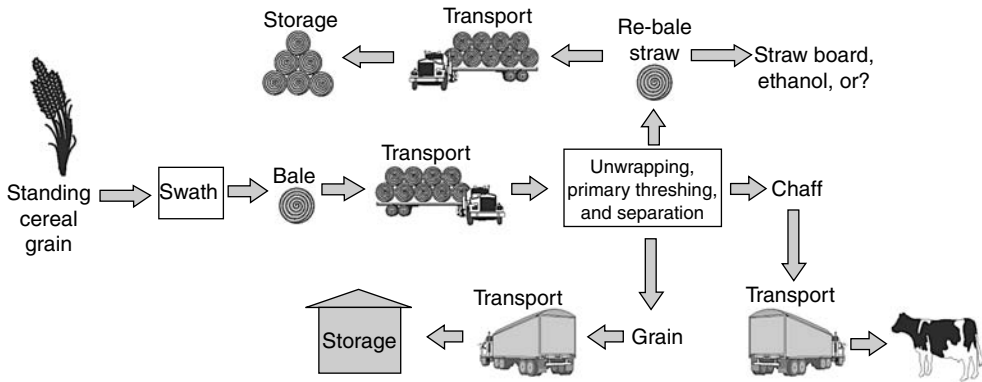
This model does not yet exist as an entire system. It has been based partly on existing machinery—swather and baler—and on assumptions based on previous research done to determine if crops could be baled and then threshed without the loss of grain quality or quantity. First, the crop would be swathed to a stubble height of 8 in. Then the entire unthreshed crop would be baled with a medium-sized round baler and transported to the farmyard. In the yard, the bales would be unwrapped and fed through a stationary processor that would perform all the functions of a normal combine [67]. The whole-crop baling method is shown in Figure 4.21.

#### 4.1.3.3 Stripper Harvester

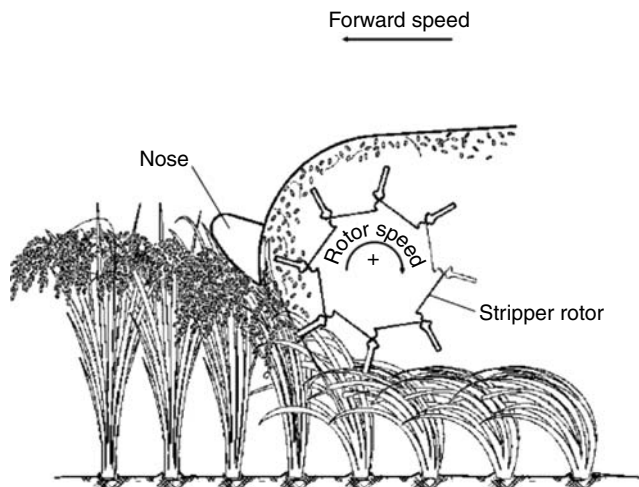
Stripping involves combing the grain from the panicles without cutting the straw. The simplicity of operation and reduced fuel bills make stripper harvesting an attractive alternative method to conventional harvesting methods [68]. The working part of the header is a rotor of flexible teeth with a keyhole access between each pair of teeth. The rotor rotates in the direction opposite to that of a standard reel, and as the crop heads pass through the recesses, the seeds and chaff are stripped from the plant. A conveyor and auger convey the grain and chaff into the combine. It is suitable only for use with grains such as wheat, barley, and oats, and similar types of plants [67].

With the stripper header in operation, the grain and some leaves are the primary parts of the plant that pass through the thresher. The entire stem of the plant is left standing in the field. The amount of biomass left





**FIGURE 4.21** Whole-crop baling method. (From G. Ragan. Modeling and comparing whole-crop harvesting systems. Agricultural, Food and Rural Development, Government of Alberta, 2005.)

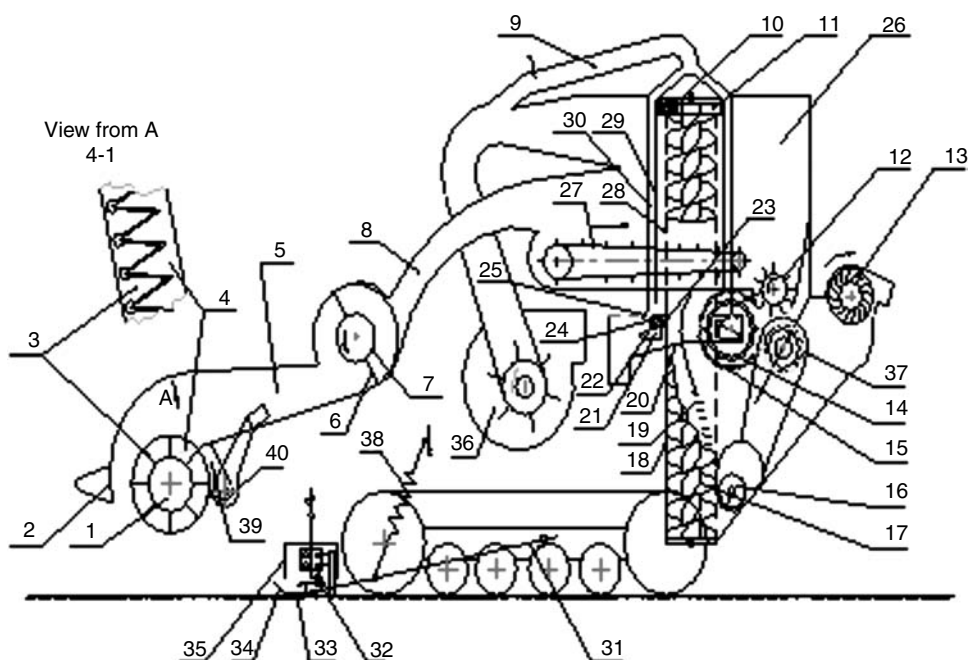


**FIGURE 4.22** Principle of operation of the Silsoe stripper rotor. (From C.J.M. Tado, G.R. Quick. In: G.R. Quick, Ed. *Proceedings of the International Conference on Crop Harvesting and Processing*, Louisville, KY, 2003.)

standing by these headers is greater than that of the conventional combine headers. Harvesting speeds could be as high as 2.3 m/s (5 miles/h) with this type of header, but they do not work efficiently in lodged rice [69].

The most promising stripper system header is developed by the Silsoe Research Institute of UK. The Silsoe stripper rotor (Figure 4.22) combs up through the crop as the machine moves forward removing the grains from the plant in situ. Flexible V-shaped teeth guide the plant into a keyhole-shaped slot at the base of the teeth where stripping occurs. The upward rotation of the stripper teeth with respect to the crop allows the rotor to pick up fallen plants or lodged crop. The rotor is enclosed on the top by a hood that guides the stripped material back for collection or further processing. A nose protrudes forward from the inlet edge of the hood to deflect gently the crop prior to stripping. The stripper rotor simultaneously carries out four functions: crop lifting; harvesting; partial threshing; and crop transport that corresponds to the function of the crop reel, cutterbar, threshing drum, and crop conveyor on a conventional combine harvester [70]. Combines fitted with stripper headers are used in the rice fields of Australia and the United States [71]. Specifically designed equipment to complement the stripper header has not yet been developed [67].

A new combine harvester that is capable of cutting and windrowing straw immediately after stripping has been developed for rice and wheat harvesting [72]. Stripper header, grain collection and cleaning mechanism, and straw cutting and windrowing are the key components of the combine harvester.



**FIGURE 4.23** Schematic arrangement of combine stripper harvester for rice and wheat: 1. stripping rotor; 2. hood; 3. teeth on rotor; 4. stagger-positioned teeth on conduit bottom; 5. conduit; 6,7. tines and drum of raking booster; 8,9. conduit; 10. exit for recycling; 11. blade; 12. discharge rotor; 13. cross-flow fan; 14. major re thresher; 15. concave; 16. horizontal auger; 17. vertical auger; 18. auger case; 19. shutter; 20. container; 21. discharge blade; 22. sheave; 23. ball bearing; 24. blade on ring distributor; 25. conic reflector; 26. depositing chamber; 27. belt conveyor; 28. cylindrical sieve; 29. intermediate cylinder; 30. outer cylinder; 31. pushing rod; 32. crank shaft roller; 33. knife; 34. guard with upward point; 35. rod of revolving rake; 36. fan; 37. detachable axial-flow re thresher; 38. suspension spring; 39. recovery chamber; 40. impeller-blower. (From Y. Jiang et al. In: G.R. Quick, Ed. *Proceedings of the International Conference on Crop Harvesting and Processing*, Louisville, KY, 2003.)

The field-testing results show that the free grain loss is low owing to the use of a pneumatic conveying system and high grain cleaning capacity is achieved by using a vertically cylindrical cleaning system. The schematic diagram of the combine stripper harvester is shown in Figure 4.23.

Stripper headers have become more popular for harvesting rice. The shortcomings of existing strippers include high shatter losses caused by crop disturbance, incomplete grain detachment, failure to collect detached grains, blockages of essential crop aligning or stripping components, and inability to harvest tangled and lodged crops satisfactorily [73].

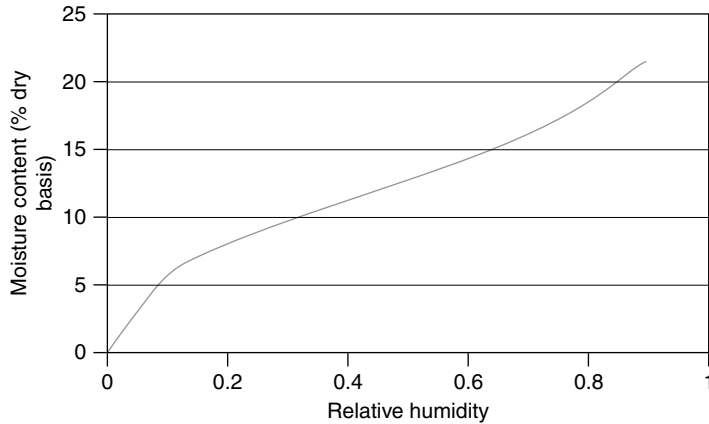
## 4.2 Drying

### 4.2.1 Grain Drying: Basic Principles

The amount of moisture present in cereal grains and pulses greatly affects grain properties such as density, force-deformation characteristics, thermal conductivity, heat capacity, and electrical resistance. Grains and seeds normally have a moisture content of 14% or less. The market value of grains and seeds is also greatly influenced by their moisture content. Moisture is transferred between cereal grains and the surrounding air during drying.

#### 4.2.1.1 Equilibrium Moisture Content

Relatively dry materials such as cereal grains contain significant amounts of water, typically up to 13% of their total weight. The porosity of these grains is often 30% or greater and the internal air spaces



**FIGURE 4.24** Desorption isotherm for sorghum based on Henderson equation. (From S.M. Henderson. *Trans. ASAE*, 13:762–764, 1970.)

contain water vapor. The solids either lose or gain water to the air within and surrounding the particles until equilibrium is reached. The moisture content at which equilibrium occurs is called the equilibrium moisture content (EMC) and the corresponding air relative humidity (RH) is called the equilibrium relative humidity (ERH). Equilibrium moisture content can also be defined as the moisture content at which the internal product vapor pressure is in equilibrium with the vapor pressure of the environment [74]. Conditions at equilibrium depend on several factors, including type of grain, temperature, and whether the moisture content is increasing or decreasing in the grain [75].

#### 4.2.1.1.1 Equilibrium Moisture Content Curve

A plot of grain moisture versus air RH at a constant temperature is called the EMC curve. The equilibrium moisture for a given RH decreases with decreasing temperature. The curves are sigmoidal in shape, and for low and high relative humidities the slope is greater than it is at intermediate relative humidities. Each grain has its own set of temperature-dependent EMC curves. Figure 4.24 shows an example of a desorption isotherm for sorghum constructed from the Henderson equation.

#### 4.2.1.1.2 Moisture Hysteresis

The EMC curve obtained by drying a wet grain (desorption) will be different from the curve obtained by rewetting the dried grain (adsorption or resorption). This phenomenon is known as moisture hysteresis. For a given RH, the moisture content on resorption is always lower than the moisture at desorption. As temperature decreases, the hysteresis effect is diminished. Grain dried at high temperatures (e.g., 140°C or above) will be in equilibrium with a higher RH than grain dried to the same moisture content at temperature near ambient.

#### 4.2.1.1.3 Equilibrium Moisture Content Equations

Two equations are commonly used to predict the equilibrium moisture content of various grains: Henderson (or modified Henderson) equation and the Chung–Pfof equation.

**4.2.1.1.3.1 Modified Henderson Equation** The modified Henderson equation gives the following expression for moisture on a decimal dry basis ( $M_{dd}$ ) as a function of RH (decimal) and temperature in °C:

$$M_{dd} = \frac{1}{100} \left[ \frac{\ln(1 - RH)}{-K(T + C)} \right]^{1/N} \quad (4.1)$$

The equation can be solved for RH as a function of  $M_{dd}$  and  $T$  (°C):

$$RH = 1 - \exp[-K(T + C)(100M_{dd})^N] \quad (4.2)$$

The constants  $K$ ,  $N$ , and  $C$  are different for each type of grain and are given in Table 4.8.

TABLE 4.8

Constants for Modified Henderson Equation

Grain	$K10^{-5}$	$N$	$C$	Standard Error Moisture
Barley	2.2919	2.0123	195.267	0.0080
Beans (edible)	2.0899	1.8812	254.23	0.0138
Corn (yellow dent)	8.6541	1.8634	49.810	0.0127
Rice (rough)	6.6587	2.5362	23.318	0.0303
Sorghum	1.9187	2.4451	51.161	0.0097
Wheat (durum)	30.5327	1.2164	134.136	0.0173
Wheat (hard)	2.5738	2.2110	70.318	0.0068
	2.3007	2.2857	55.815	0.0071
Wheat (soft)	1.2299	2.5558	64.346	0.0122

TABLE 4.9

Constants for Chung Equation

Grain	$A$	$B$	$C$	$E$	$F$	Standard Error Moisture
Barley	761.66	19.889	91.323	0.33363	0.050279	0.0055
Beans (edible)	962.58	15.975	160.629	0.43001	0.062596	0.0136
Corn (yellow dent)	312.30	16.958	30.205	0.33872	0.058970	0.0121
Rice (rough)	594.61	21.732	35.703	0.29394	0.046015	0.0096
Sorghum	1099.67	19.644	102.849	0.35649	0.050907	0.0086
Wheat (durum)	921.65	18.077	112.350	0.37761	0.055318	0.0057
Wheat (hard)	529.43	17.609	50.998	0.35616	0.056788	0.0061
Wheat (soft)	726.49	23.607	35.662	0.27908	0.042360	0.0147

4.2.1.1.3.2 *Chung Equation* The Chung equation gives the following expression for  $M_{dd}$  as a function of  $T$  ( $^{\circ}\text{C}$ ) and RH (decimal):

$$M_{dd} = E - (F \ln[-(T + C)\ln(RH)]) \quad (4.3)$$

The constants  $E$ ,  $F$ , and  $C$  are given in Table 4.9. The form of the equation, which predicts RH from values of  $T$  ( $^{\circ}\text{C}$ ) and  $M_{dd}$ , is

$$\text{RH} = \exp\left[\left(\frac{-A}{(T + C)}\right)\exp(-BM_{dd})\right] \quad (4.4)$$

Values of  $E$ ,  $F$ ,  $C$ ,  $A$ , and  $B$  for various grains and oilseeds are given in Table 4.9.

4.2.1.1.3.3 *Vemuganti and Pfof Equation* Vemuganti and Pfof developed equations for calculating the constants in the Chung equation (4.4) on the basis of the product composition. They give the equation in the following form:

$$\text{RH} = \exp\left[\left(\frac{A_1}{B_1}\right)\exp(C_1M_{dd})\right] \quad (4.5)$$

where  $A_1 = -(6.65596F + 20.146N)$ ,  $B_1 = 1.987(T + 2.339P + 0.8176N)$ ,  $C_1 = -(0.46997F + 0.22625N)$ ,  $M_{dd}$  is the dry-basis moisture content (decimal),  $T$  the temperature ( $^{\circ}\text{C}$ ),  $P$  the percentage of dry matter that is protein,  $F$  the percentage of dry matter that is fat, and  $N$  percentage of dry matter that is nitrogen-free extract (% of carbohydrate without fiber). Equation 4.5 can give an approximate value of the ERH when the constants for Equations 4.2 through 4.4 are not available.

Temperature, RH, previous moisture intake and release, and the physical properties of the product affect water activity. The water activity ( $a_w$ ) usually increases with temperature and pressure. The water activity scale extends from 0 (bone dry) to 1.0 (pure water), but most foods have a water activity level in

the range of 0.2 for very dry foods to 0.99 for moist fresh foods. Water activity is in practice usually measured as ERH. A number of electronic instruments are available for measuring water activity.

#### 4.2.1.2 Water Activity and Storage Stability

Knowledge of the relationship between grain moisture content and water activity at different temperatures is important in understanding the limits of safe storage of grain. For cereal grains,  $a_w$  of 0.65 is considered a safe level for long-term storage [77]. Most microorganisms grow at an  $a_w$  of 0.80 or above in pulses containing 15%–17% moisture content [78]. As the moisture content of grains changes, so does  $a_w$ . Table 4.10 shows data for wheat. Figure 4.25 shows data plotted for Australian barley varieties at 20°C and 30°C [77]. Cereal and legume seeds become brittle and tend to shatter at very low water activities (too dry condition). This not only decreases their quality but also increases their vulnerability to insect infestation [80]. Moisture content and  $a_w$  values for selected grains are presented in Table 4.11 [81]. The minimum water activity values for enzymatic reactions in selected grains/grain materials are presented in Table 4.12 [82].

#### 4.2.2 Grain-Drying Systems

The systems for drying grain can be divided into natural-air and heated-air drying.

##### 4.2.2.1 Natural-Air Drying

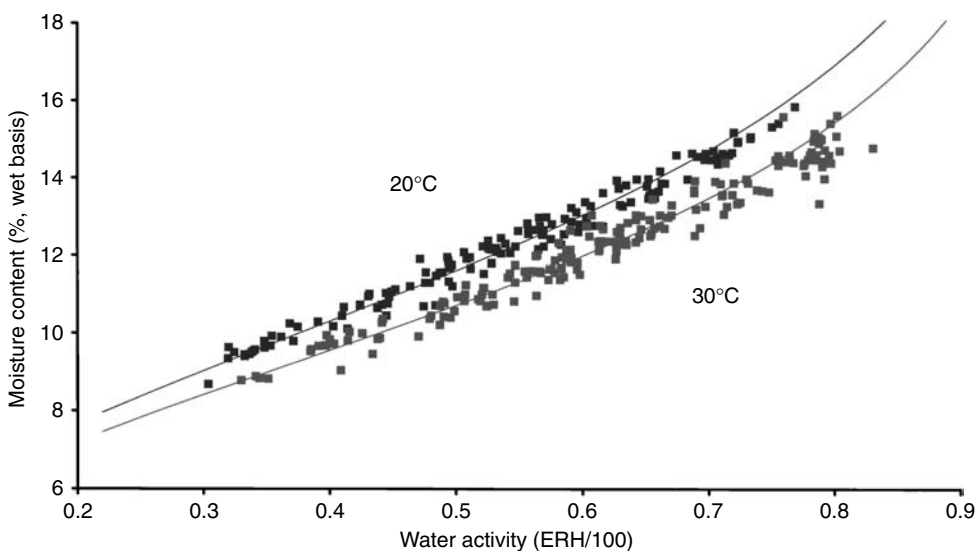
Cereal grains are dried in the field when moisture is transferred from the kernel to the surrounding air. Air temperature, wind speed, and humidity affect the rate of drying. The challenge of natural-air drying is to successfully dry the grain before spoilage takes place. The aeration fans inject ambient air at the bottom of the grain bin. The air picks up moisture as it moves up through the grain to be exhausted out the top of the bin. The speed at which

**TABLE 4.10**

Moisture Contents and Water Activity of Wheat

Moisture Content (g/g)	Water Activity
0.060	0.10
0.080	0.20
0.093	0.30
0.106	0.40
0.120	0.50
0.132	0.60
0.147	0.70
0.163	0.80
0.215	0.90

Source: Application note: seed longevity in storage is enhanced by controlling water activity. Decagon Devices, Inc., Pullman, WA, 2000.



**FIGURE 4.25** Water activity for Australian barley varieties at 20°C and 30°C. (From L. Caddick. *Water Activity and Equilibrium Relative Humidity*. CSIRO Australia: Stored Grain Research Laboratory, 2001.)

**TABLE 4.11**

Moisture Content and Water Activity Values for Selected Grains

Grain/Flour	Moisture Content (%)	Water Activity
Oats	10	0.65
Rice	15–17	0.80
Wheat flour	14.5	0.72

Source: ITDG. *Drying of Foods*. International Technology Development Group Ltd., 2005.

**TABLE 4.12**

Minimum Water Activity Values for Enzymatic Reactions in Selected Grains/Grain Materials

Grain/Grain Material	Enzyme	Temperature (°C)	$a_w$ Threshold
Grains	Phytases	23	0.90
Rye flour	Amylases	30	0.75
Wheat flour dough	Proteases	35	0.96
Wheat germ	Glycoside-hydrolases	20	0.20

Source: R. Dracon. In D. Simato, J.L. Multon, Eds. *Properties of Water in Foods*. Dordrecht, The Netherlands: Martinus Nijhoff Publishers, 1985.

the drying front moves up the bin depends on the airflow rate and the grain moisture content. Airflow is influenced by fan specifications, duct design and layout, type of grain, amount and type of dockage, grain depth, method of filling, and ventilation [83].

#### 4.2.2.2 Heated-Air Drying

When temperatures are below 10°C, the air will not carry much water and the transfer of moisture from the cereal grain to the air is relatively slow. Consequently, drying efficiency is greatly increased when heat is added to ambient air that is colder than 10°C [83]. The colder the ambient air temperature, the more the heat that must be added for effective drying and the more expensive the drying operation becomes. Consequently, it is much cheaper to complete the grain drying operation when ambient air temperatures are warm.

##### 4.2.2.2.1 Types of Heated-Air Dryers

Heated-air dryers use heat, high airflow rates, and grain mixing to speed up the grain drying process. There are three main types of heated-air drying systems [83].

**4.2.2.2.1.1 Nonrecirculating Batch-Type Dryers** The grain is loaded into these types of dryers as a batch and there is no mixing until the heated-air drying phase has been completed.

**4.2.2.2.1.2 Recirculating Batch-Type Dryers** The grain is loaded in a batch and there is mixing during the drying process.

**4.2.2.2.1.3 Continuous Flow-Type Dryers** Grain is loaded and unloaded during the drying process. Grain movement through continuous flow dryers is usually adjusted to accommodate different levels of grain moisture content. Airflow rate and depth of grain have a large influence on the drying rate of heated-air dryers. Bin dryers usually employ lower airflow rates but, because of their larger size and grain depth, the daily output of dry grain may be as great for bin dryers as for high-speed dryers [83].

Dryers with high airflow rates can quickly and efficiently reduce the moisture levels of damp grain. However, dryers with lower airflow rates are usually more energy efficient and, because drying proceeds more slowly, they allow more time for moisture to move from the inside to the outside of the kernel.

### 4.2.2.3 Drying with Supplemental Heat

The drying capacity of air can be greatly improved by increasing the air temperature of natural-air drying systems. As a general rule, the RH can be expected to decrease by one-half for each 10°C increase in air temperature [83]. Consequently, small increases in air temperature can be expected to produce large increases in the effectiveness of natural-air drying systems when the RH of the ambient air is high. As long as the RH of the unheated air is low enough to produce a grain EMC less than 14.6%, there is little to be gained by heating the air. Caution should be exercised to ensure that overdrying does not occur when heated air is used in a system that is designed for natural-air drying. Airflow rates must be adequate to ensure that the moisture content is reduced to a safe storage level before the grain has had time to spoil when heat is added to natural-air drying systems.

### 4.2.2.4 Grain Dryers

Dryers can be categorized in different ways. There are natural-air, low-temperature, and high-temperature dryers batch, automatic batch, and continuous flow dryers; and in-bin and column or self-contained dryers. Dryers can also be classified according to the direction of airflow through the grain; cross-flow, counter-flow, and concurrent-flow [84].

Figure 4.26 shows a cross-flow dryer with forced-air drying and cooling, and Figure 4.27 represents the temperature and moisture zone. Most cross-flow dryers operate at air temperatures of 93°C–99°C (200°F–210°F). At a constant airflow rate, drying efficiency (in terms of energy used per unit of water removed) will be greater for dryers operating at higher temperatures [85]. Relative drying rate as a function of drying air temperature is shown in Table 4.13. It can be seen that drying air temperature has a tremendous effect on drying rate. Figure 4.28 shows a recirculating batch dryer.

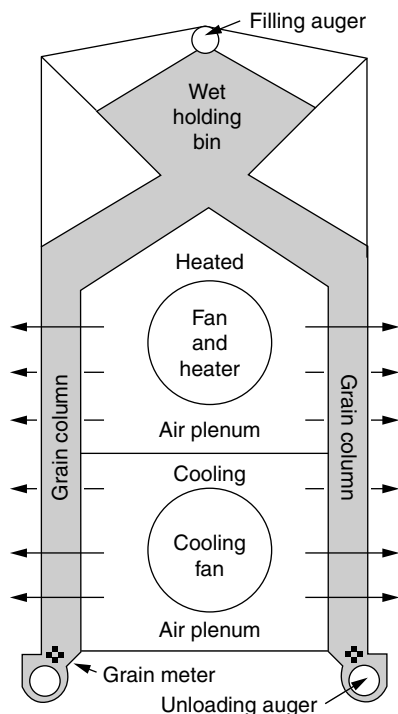
Most self-contained cross-flow dryers operate in the 67–100 m<sup>3</sup>/min-t (60–90 cfm/bu) airflow range. Most in-bin dryers operate in the 5.6–11.1 m<sup>3</sup>/min-t (5–10 cfm/bu) airflow range [85]. Figure 4.29 shows the energy requirement of a conventional cross-flow dryer as a function of drying air temperature and airflow rate.

Table 4.14 presents the estimated energy requirement for drying grain. Table 4.15 provides specific energy consumption for several different drying systems. Specific energy consumption is defined as the total energy in MJ (BTU) of fuel energy plus the electrical energy used by fan motors divided by the quantity of moisture removed. Table 4.16 presents the maximum drying capacity, maximum recommended fan horsepower, and static pressure for in-bin counter-flow corn drying.

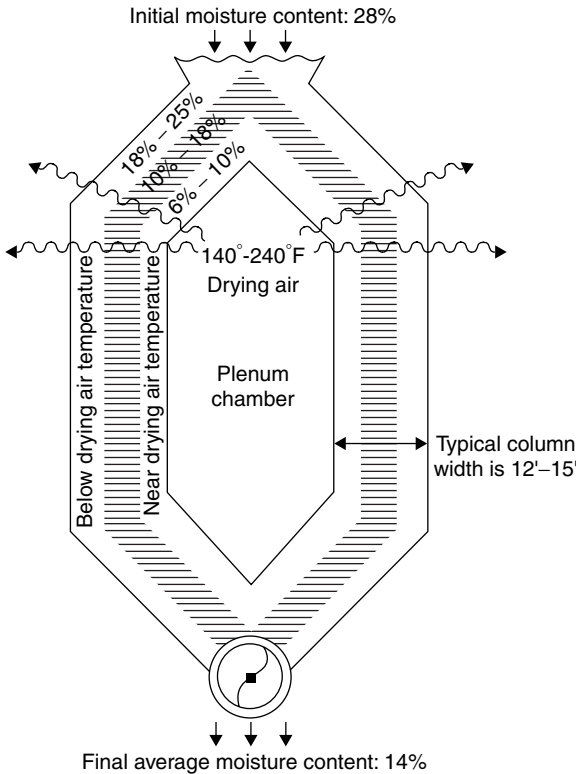
The recommended maximum moisture contents of corn and wheat, and the minimum airflow rates for ambient air-drying under Midwestern U.S. conditions are presented in Table 4.17. The final grain temperatures in the three basic continuous flow-drying methods with different airflow rates are shown in Figure 4.30. Table 4.18 shows the mean airflow rate used for some tropical products at different moisture contents and for mean ambient conditions.

### 4.2.3 Commercial Grain Dryers

In the U.S. rice industry, the cross-flow dryer (Figure 4.31) is the most prevalent high-temperature and continuous flow-type dryer. It requires a smaller pressure drop across the grain column compared to other dryer types such as the concurrent and countercurrent flow [91]. Grain flows by gravity into



**FIGURE 4.26** Cross-flow dryer with forced-air drying and cooling. (From K.J. Hellevang, W.F. Wilcke. *Maintaining corn quality for wet milling*. AE-1119, Extension Service, North Dakota State University, Fargo, ND, 1996.)



**FIGURE 4.27** Temperature and moisture zones in a cross-flow dryer. (From K.J. Hellevang, W.F. Wilcke. *Maintaining corn quality for wet milling*. AE-1119, Extension Service, North Dakota State University, Fargo, ND, 1996.)

**TABLE 4.13**

Effect of Drying Air Temperature on Drying Rate of Corn for Corn Dried from 24% to 14% Moisture Content with 10°C (50°F) and 65% Relative Humidity Ambient Air

Drying Air Temperature, °C (°F)	Drying Rate for Corn, bu/h per 1000 cfm	Relative Drying Rate
10 (50)	0.64	1.0
49 (120)	5.06	8.5
60 (140)	6.59	11.1
71 (160)	8.18	13.8
82 (180)	9.81	16.5

Source: Midwest Plan Service. *Grain Drying, Handling, and Storage Handbook*, 2nd ed. MWPS-13, Ames, IA: Iowa State University, 1987.

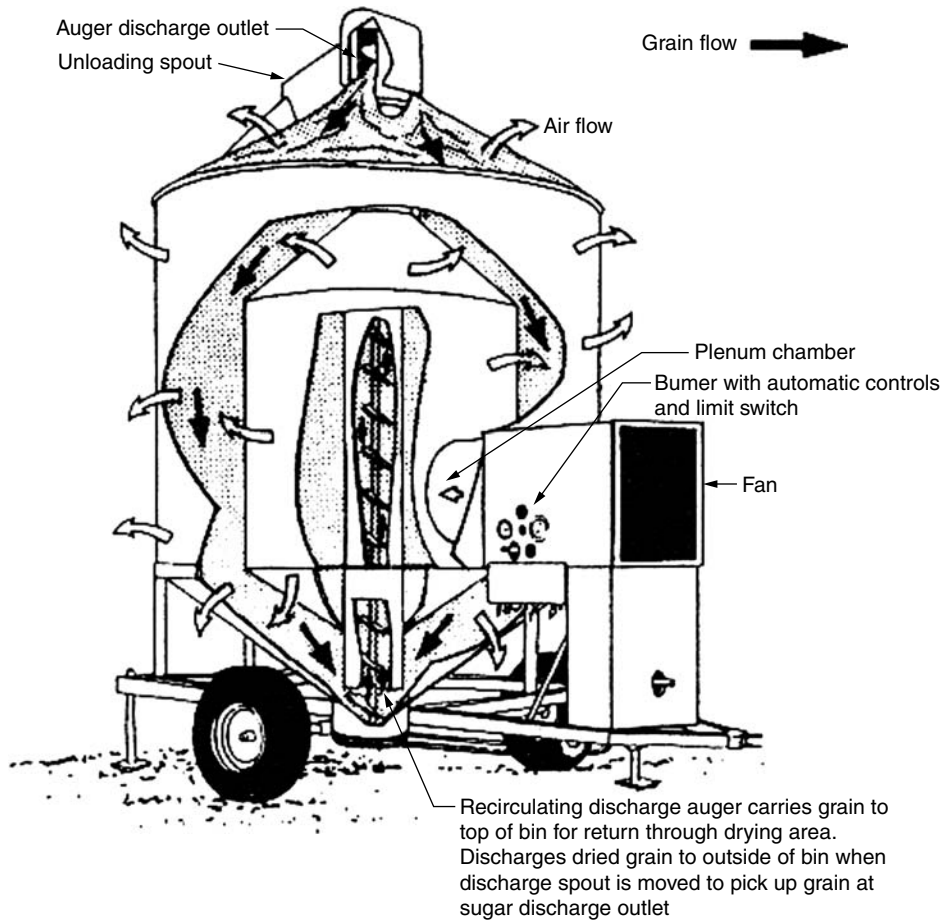
min before the rice is transferred to another drying section by a grain exchanger. Figure 4.32 shows the moisture content profile for rice. Rice entered at a moisture content of 16% (wb) and exited at 14.9%.

one of the two drying columns, whereby it is initially exposed to heated air that passes through the grain columns perpendicular to the flow of the grain. As the grain flows past the heated air section, it is then exposed to a section in which ambient air is typically forced through the grain column. Unloading augers located at the bottom of the dryer control the retention time of the grain in the dryer. Retention time is varied by the dryer operator depending on the moisture content of the grain entering the dryer, the drying air temperature, dimensions of the drying column, and the air-flow rate [92].

A typical commercial grain drier is approximately 21 m tall and 4.5 m wide. Drying air flows through a bed of rice that is 30–40 cm thick, depending upon the manufacturer [93]. The grain column may have several sections. Each section is usually separated by a grain exchanger. Grain exchangers are used to mix and transfer flowing grain from the heated air side to the exhaust side of the column as it passes through the dryer. Grain exchangers are generally placed 6 m apart along the height of the column, but spacing again is dependent on the manufacturer [93]. These grain exchangers cause the rice on one side of the column thickness to switch places with the rice on the opposite side of the column. Air conditions inside cross-flow dryers vary greatly from the air inlet to the outlet side. Grain exchangers have been advocated as a means of alleviating over- and underdrying of grain. It is generally the case that during drying in a cross-flow dryer, particularly without a grain exchanger, grain located next to the hot air plenum (HAP) will tend to be overdried and show reductions in quality [94].

Air temperature and RH are two variables that affect drying of rough rice. In most commercial cross-flow rough rice dryers, the exposure time of rice to surrounding air can range from 6 to 10





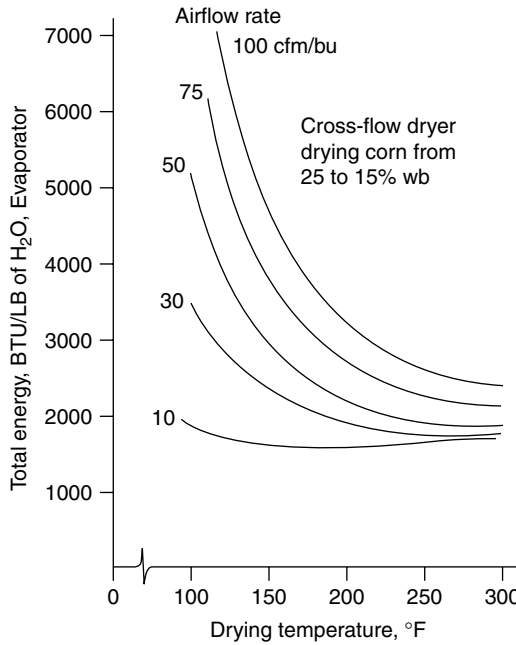
**FIGURE 4.28** Recirculating batch dryer. (From K.J. Hellevang, W.F. Wilcke. Maintaining corn quality for wet milling. AE-1119, Extension Service, North Dakota State University, Fargo, ND, 1996.)

## 4.3 Storage and Handling

### 4.3.1 Grain Storage: Perspectives and Problems

The primary aim of storage is to prevent deterioration of the quality of the grain. This is achieved through control of moisture and air movement, by preventing infestation of microorganisms, and attacks of insects and rodents. Food grains can be stored for relatively longer periods of time under proper storage conditions (low temperature, inert atmosphere, etc.), with little or no detectable loss of quality. The length of time grain can be held in storage depends on the moisture content of the grain, the temperature of the grain, and whether the grain can be kept away from heating by means of aeration [96]. Grain spoilage is the result of microorganisms (bacteria, yeast, and fungi) using grain nutrients for growth and reproductive processes. Microorganisms also produce heat during growth that can increase the temperature of stored grains. Under proper environmental conditions, certain microorganisms can produce toxins or other products that can cause serious illness and even death when consumed by livestock or humans [97].

Safe storage must maintain grain quality and quantity. This means protecting it from weather, molds and other microorganisms, addition of moisture, destructively high temperatures, insects, rodents, birds, objectionable odors, and contamination. High temperature and high moisture are the



**FIGURE 4.29** Energy requirements of a conventional cross-flow dryer as a function of drying air temperature and airflow rate. (From K.J. Hellevang, W.F. Wilcke. Maintaining corn quality for wet milling. AE-1119, Extension Service, North Dakota State University, Fargo, ND, 1996.)

**TABLE 4.14**

Estimated Energy Required for Drying Corn (kWh/bu)

Temperature Increase (°F)	Final Moisture (%)	Airflow Rate (cfm/bu)		
		1	2	3
3	14.9	1.8	2.7	3.7
10	11.9	2.5	4.5	6.0
20	10.0	5.0	7.5	10.4
30	8.0	5.2	7.9	11.1

Source: K.J. Hellevang, W.F. Wilcke. Maintaining corn quality for wet milling. AE-1119, Extension Service, North Dakota State University, Fargo, ND, 1996.

most significant factors affecting grain quality in storage. Each can cause rapid decline in germination, malting quality, baking quality, color, and oil composition. Insects and molds impair the quality of grain directly by their feeding and development, and indirectly through generation of heat and moisture. High temperatures and moistures favor development of insects and molds. Development of insects is limited by temperatures below 15°C and by moistures below 9% in cereal grains, whereas development of molds is limited by temperatures below 10°C and by moistures below 13% in cereal grains. Spraying with insecticides or fumigating minimizes insect problems but leaves chemical residues in grain [98].

**4.3.1.1 Environmental Factors Influencing Grain Quality**

To store grain successfully, grain and the atmosphere in which it is stored must be maintained under conditions that discourage or prevent the growth of microorganisms that cause spoilage. Stored-grain ecosystems are complex due to the large number of abiotic and biotic factors and their interrelationships [99].

**TABLE 4.15**

Specific Energy Consumption for Drying Shelled Corn from 25.5% to 15.5% Moisture Content

Drying System	Gal Propane per 2.54 t (100 bu)	kWh Electricity per 2.54 t (100 bu)	Energy Input, BTU per 2.54 t (100 bu)	BTU/lb Water Evaporated	MJ/kg Water Evaporated
High-temperature dryer with in-dryer cooling	20	10	1,874,130	2828	6.58
Bin drying with stirrer	18	10	1,700,000	2565	5.97
High-temperature dryer (full heat)	17.3	8	1,637,304	2471	5.75
In-bin counter-flow	17	10	1,600,000	2414	5.61
Dryeration (out hot 16.5%–18%, steeped, then cooled)	8	70	1,357,891	2049	4.77
Combination drying (out hot 20–32%, then finished with natural- air drying)	8	70	974,910	1471	3.42
Natural-air or low- temperature drying	0	140	477,820	721	1.68

Source: K.J. Hellevang, R.V. Morey. In: *National Corn Handbook, NCH-14*. Urbana-Champaign, IL: Cooperative Extension Service, University of Illinois, 1986.

**TABLE 4.16**Maximum Average Drying Capacity, Maximum Recommended Fan Horsepower, and Static Pressure for In-Bin Counter-Flow Drying of Corn at a 6-ft Depth from 25% to 16.5% Moisture at 71°C (160°F) Drying Air Temperature Using 10°C (50°F) and 55% Relative Humidity Ambient Air<sup>a</sup>

Bin Diameter, m (ft)	Maximum Drying Capacity, t (bu)/Day	Maximum Recommended Fan Power, kW (hp)	Static Pressure Range, kPa (in. of Water)
5.5 (1.8)	76 (3000)	7.5 (10)	1.12–1.24 (4.5–5.0)
6.4 (21)	89 (3500)	7.5 (10)	1.12–1.24 (4.5–5.0)
7.3 (24)	140 (5500)	15 (20)	1.24–1.49 (5.0–6.0)
8.2 (27)	191 (7500)	22.5 (30)	1.24–1.49 (5.0–6.0)
9.1 (30)	216 (8500)	30 (40)	1.24–1.49 (5.0–6.0)
10.0 (33)	236 (9300)	30 (40)	1.12–1.24 (4.5–5.0)
11.0 (36)	315 (12,400)	45 (60)	1.24–1.49 (5.0–6.0)
12.8 (42)	419 (16,500)	60 (80)	1.24–1.49 (5.0–6.0)

<sup>a</sup>Assumes a Shedd's factor multiplier of 1.5.

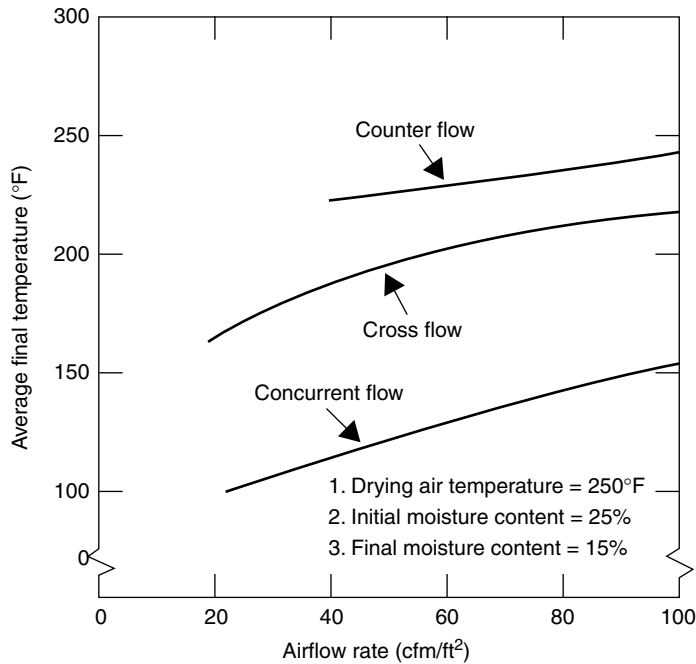
Source: Sukup Airflow and Drying Rates Program. Sheffield, IA: Sukup Manufacturing, 1993.

**TABLE 4.17**

Characteristics of Ambient Air Drying of Grains in Midwestern United States

Grain	Moisture, % (wb)	Airflow, m <sup>3</sup> /m <sup>3</sup> min
Maize	20	2.4
Wheat	18	1.6
	16	0.8

Source: Q. Liu et al. In: F.W. Bakker-Arkema, Ed. *CIGR Handbook of Agricultural Handbook*. St. Joseph, MI: American Society of Agricultural Engineers, 1999, pp. 20–46.



**FIGURE 4.30** Final grain temperature in the three basic continuous flow drying methods. (From K.J. Hellevang, W.F. Wilcke. Maintaining corn quality for wet milling. AE-1119, Extension Service, North Dakota State University, Fargo, ND, 1996.)

**TABLE 4.18**  
Conditions for Low-Temperature Drying (25°C and 65% Relative Humidity) of Some Selected Products in the Tropics

Grains	Maximum Initial MC, % (wb)	Minimum Airflow Rate, m <sup>3</sup> /m <sup>3</sup> min
Beans	18	3.0
Corn	18	3.0
Rice	18	3.0

Source: J.S. Silva, P.A. Berbert. In: F.W. Bakker-Arkema, Ed. *CIGR Handbook of Agricultural Handbook*. St. Joseph, MI: American Society of Agricultural Engineers, 1999, pp. 59–68.

Computer models have been used to simulate abiotic factors such as temperatures, moisture contents, and gas concentrations, and biotic factors such as population dynamics of insects and mites, and fungal growth [100]. Figure 4.33 shows the essential elements of the storage ecosystem, the boundaries of which are the storage container (bag, drum, silo, warehouse, etc.).

**4.3.1.2 Types of Storage Facilities**

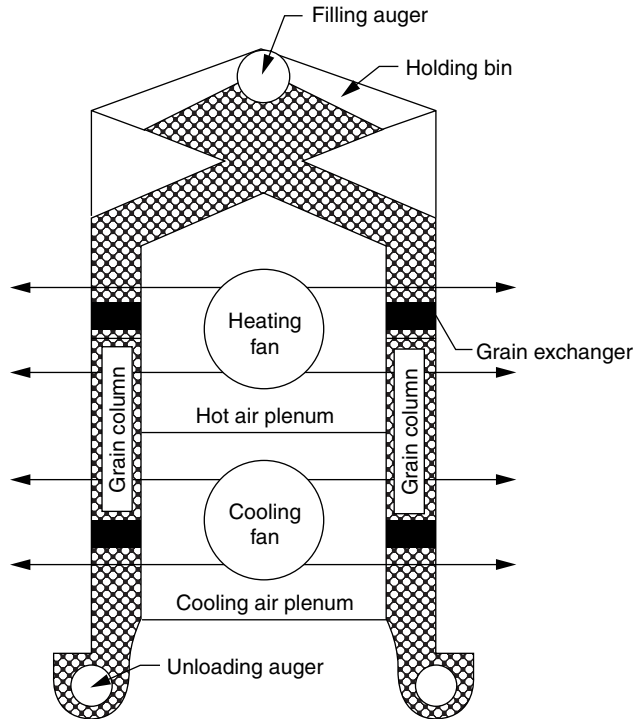
Storage facilities take many forms, ranging from piles of unprotected grains on the ground, underground pits or containers, and

piles of bagged grains, to storage of bins of many sizes, shapes, and types of construction. Some of the storage facilities used in the rural areas of Bangladesh are shown in Figure 4.34.

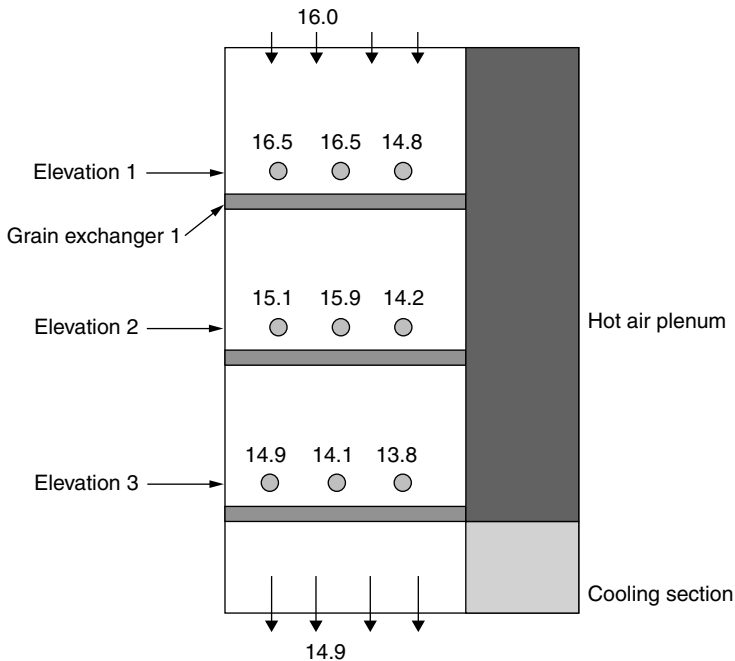
**4.3.1.2.1 On the Ground**

Grain is normally piled on the ground unprotected only between harvest and the availability of transport equipment. Losses are smaller if it is stored for short period of time, but the grain is exposed to rodents, birds, insects, and wind so that losses become severe within a week. The angle of repose, pile radius, and bushels for corn, wheat, and sorghum piled from 50 to 60 ft height for cone-shaped outdoor grain piles are shown in Table 4.19. The ground surface area required for piles that are 15, 20, and 25 ft high for wheat, corn, and grain sorghum is presented in Table 4.20.

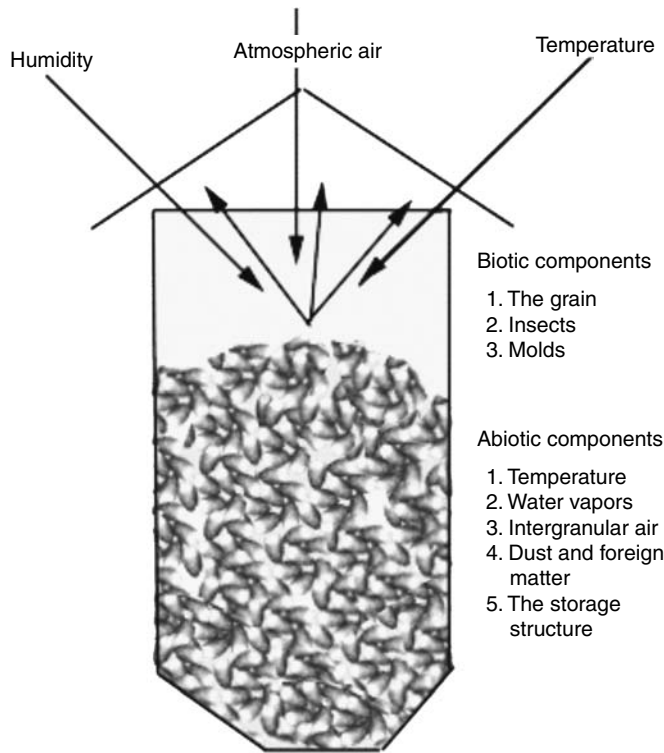
If grain must be piled outside on the ground, drainage is a crucial factor. The pile should be on high ground and the earth crowned under the pile. Placing plastic on the ground is absolutely essential to keep



**FIGURE 4.31** Schematic diagram of a commercial cross-flow dryer. (From D.B. Brooker et al. *Drying and Storage of Grains and Oilseeds*. New York: Van Nostrand Reinhold, 1992.)



**FIGURE 4.32** Moisture content profile for rice. (From G.J. Schluterman, T.J. Siebenmorgen. Temperature, relative humidity, and rice property profiles in a commercial-scale cross-flow dryer. Paper No. 026160. St. Joseph, MI: American Society of Agricultural Engineers, 2002.)



**FIGURE 4.33** Essential elements of storage ecosystem. (From Agricultural Research Station of Israel. Technology and storage of agricultural products. Ministry of Agriculture and Rural Development, Bet-Dagan, 2003.)



**FIGURE 4.34** Rural storage structures in Bangladesh. (From ASB. *Grain Storage*. Dhaka: Asiatic Society of Bangladesh, [http://banglapedia.search.com.bd/HT/G\\_0188.htm](http://banglapedia.search.com.bd/HT/G_0188.htm).)

soil moisture from migrating into the grains. Piles can be covered with plastic or a tarp to reduce wetting by rain and snow, and minimize damage by wind and birds. Air must flow near the plastic cover to reduce condensation and carry the moisture away. If a rectangular pile is made to store grain, the pile must be oriented north and south to allow the sun to dry condensation off the sloping sides of the cover [96]. Average filling angle of some grains is given in Table 4.21. The quantity of grain in piles can be estimated using Table 4.22. Grain piled outdoors is shown in Figure 4.35.

**TABLE 4.19**

Angle of Repose, Pile Radius, and Bushels for Some Selected Grains Piled from 50 to 60 ft Heights

Height (ft)	Grain	Angle of Repose (°)	Pile Radius (ft)	Bushels
50	Corn	22	124	644,004
	Sorghum	27	98	402,251
	Wheat	25	107	479,526
60	Corn	22	148	1,100,000
	Sorghum	27	118	696,272
	Wheat	25	129	832,581

Source: T.J. Herrman et al. Emergency storage of grain: outdoor piling. Publication # MF-2363, Kansas State University Agricultural Experiment Station and Cooperative Extension Service, Manhattan, KS, 1998.

**TABLE 4.20**

Pile Width (ft) and Bushels for 1 ft Length of Elongated Triangular-Shaped Outdoor Grain Piles

Pile Height (ft)	15		20		25	
	Width	bu/ft	Width	bu/ft	Width	bu/ft
Grain						
Corn	74	445	99	792	124	1237
Sorghum	58.9	353	78.5	628	98	981
Wheat	64	386	85.8	686	107	1072

Source: T.J. Herrman et al. Emergency storage of grain: outdoor piling. Publication # MF-2363, Kansas State University Agricultural Experiment Station and Cooperative Extension Service, Manhattan, KS, 1998.

#### 4.3.1.2.2 Underground

Underground pits (Figure 4.36) are an effective, low-cost method of long-term grain storage, which, are most commonly used for storing drought feed reserves on farms. Feed grain has been recovered in good condition after more than 10 years. The main drawback of underground storage is the difficulty of removing grain. Grain moisture content must be less than 12% to keep the risk of spoilage low. Pit should be located on a well-drained site above the water table, with the immediate surroundings graded to prevent rainfall runoff collecting in the pit area. Water seepage through the side walls of the pit is a major concern. Pits should be kept at least 10 m apart to prevent seepage from an empty pit to a full one, and the pit should not be more than 3 m wide. A well-constructed pit storage is airtight and oxygen levels gradually reduce over time.

The low oxygen levels prevent development of damaging numbers of grain insects. Grain protectants can be applied to the grain when it is placed in storage [106]. Underground storage protects the grain from variations in temperature, the construction is relatively simple, and it protects grain from insects and molds because of the low oxygen and high CO<sub>2</sub> content of the interseed air [15].

#### 4.3.1.2.3 Bagged Storage

Bagged grain can be stored in almost any shelter that protects the bags from weather and predators, and bags can be handled without any equipment. The advantages of bagged storage system are the lower capital costs without any need for sophisticated aeration and fumigant circulation facilities [107]. However, both bags and bag storage space become expensive, particularly where manpower costs are high. Dunnage should be used to keep grain bags at least 15 cm off the floor. Stack size should not exceed

**TABLE 4.21**

Average Filling Angle of Some Selected Grains

Grain	Average Filling Angle (°)
Barley	28
Corn (shelled)	23
Oats	28
Sorghum	29
Soybeans	25
Sunflower (nonoil)	28
Sunflower (oil)	27
Wheat (durum)	23
Wheat (HRS)	25

Source: NDSU. Temporary grain storage. Report AE-84, NDSU Extension Service, North Dakota State University, Fargo, ND, 1998.

**TABLE 4.22**

Approximate Capacities of Unconstrained Grain Piles

Pile Height (ft)	Pile Diameter	Total Bushels	Bushels/Additional 1 ft of Pile Length
3	12.9	105	15
4	17.2	250	28
5	21.5	480	43
6	25.7	840	62
7	30.0	1330	85
8	34.3	1980	110
9	38.6	2820	140
10	42.9	3870	170
11	47.2	5150	210
12	51.5	6700	250
13	55.8	8500	290
14	60.0	10,600	340
15	64.3	13,000	390
16	68.6	15,900	440
17	72.9	19,000	500
18	77.2	22,500	560
19	81.5	26,500	620
20	85.8	31,000	690

Source: NDSU. Temporary grain storage. Report AE-84, NDSU Extension Service, North Dakota State University, Fargo, ND, 1998.



**FIGURE 4.35** Grain piled outdoors. (From CRC. Agriculture and Agri-Food Canada. Winnipeg: Cereal Research Center.)

6 × 9 m, and a stack should be divided into six blocks containing 256 bags, with a row of 6 bags lengthwise adjacent to a row of 10 bags widthwise [108]. Another temporary storage option that holds some promise is the use of large plastic silage bags. Grain going into these bags should be dry and cool (under 15% and 60°F). A system specifically designed for handling dry grain is available from the manufacturer that reportedly greatly reduces grain damage [96]. A bagged storage facility is shown in Figure 4.37.

#### 4.3.1.2.4 Bulk Storage

Bulk storage in beans is the most widely used type of storage for cereal grains. Bins are constructed of steel, aluminum, concrete, and even wood or plywood. Round bins are most common, but large, flat storage buildings are used as well. Figures 4.38 through 4.44 show large-scale grain storage facilities. The capacity of a grain bin per unit depth is presented in Table 4.23.



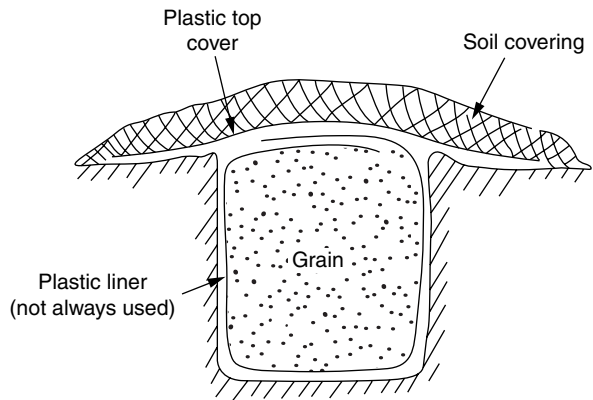
### 4.3.1.3 Insects

Insects are a major problem for the storage grains and seeds. Not only do insects consume part of grain, but they also contaminate the grain. The U.S. Department of Agriculture (USDA) has estimated that storage losses due to insects exceed \$470 million per year [15]. Insects that can live on grain can be divided into those that develop within grain kernels (granary weevils, rice weevils, corn weevils, lesser and larger grain borers, and Angoumois grain moths) and those that develop outside the kernels (red flour and rusty grain beetles, sawtoothed grain beetles, cadelles, khapra beetles, and Indian-meal moths). Some of the insects are shown in Figure 4.45. Grain-damaging insects multiply slowly or not at all below 16°C (60°F), and they cannot survive in temperatures of 42°C (−107°F) or above [112]. Navarro et al. [113] stated that stored-grain insects develop well at 27°C–34°C (81°F–93°F) and thrive best at about 29.5°C (85°F).

Moisture is another important factor in controlling grain infestation. Generally, moisture contents of 9% or lower restrict infestation. Even though the grain is stored at relatively safe storage moisture of 11%–14%, in the presence of insects, the grain often “heats.” The heat is caused by the metabolic heat of the insects. Because of the increased temperature, moisture migration occurs and results in increased moisture in pockets of grain. This leads to the growth of microorganisms. Air movements in grain and development of hotspots due to insect infection during storage are shown in Figures 4.46 and 4.47. Table 4.24 lists some common grain-storage insects and their optimal growth conditions.

### 4.3.1.4 Aeration

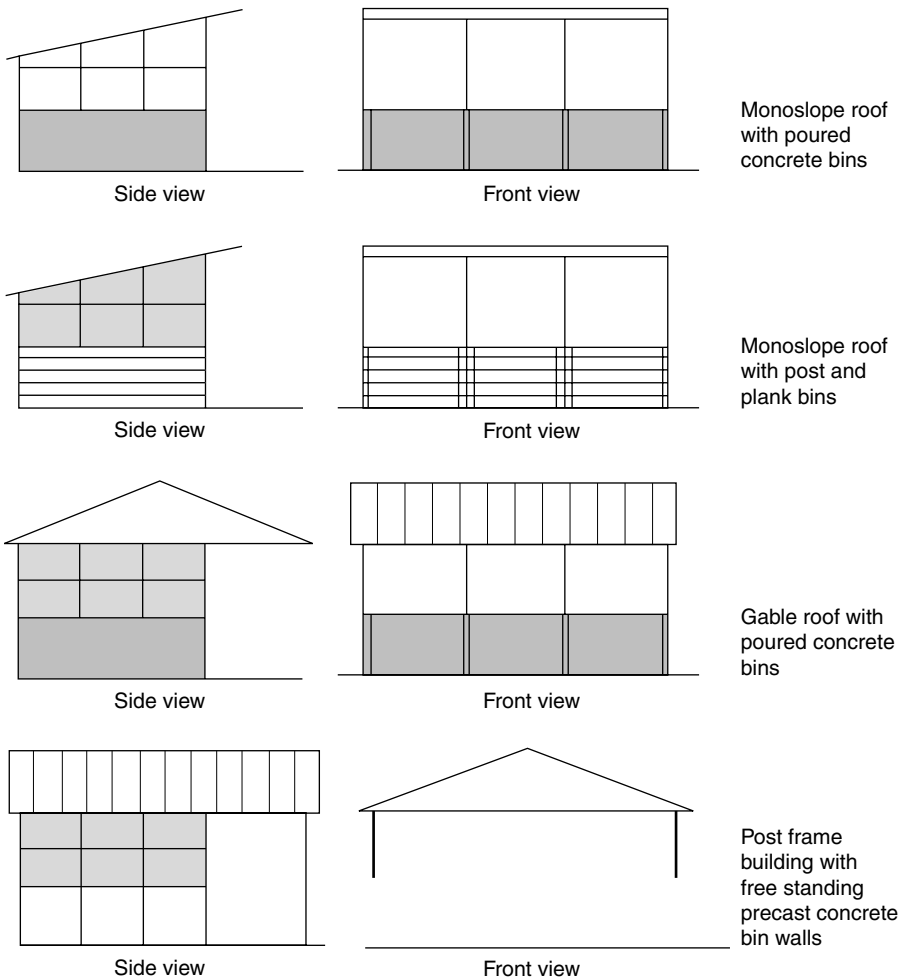
Grain stored for long periods of time is generally aerated to maintain the overall quality and reduce the risk of storage losses due to insects and mold growth. Aeration is the process of blowing ambient air through grain masses for the purpose of cooling and



**FIGURE 4.36** Underground storage pit. (From DPIF. A guide to grain storage and drying in Queensland: underground pit storage of grain. Department of Primary Industries and Fisheries, Queensland Government, Australia, 2004, <http://www.dpi.qld.gov.au/fieldcrops/14983.html>.)



**FIGURE 4.37** A bagged storage facility. (From CRC. Agriculture and Agri-Food Canada. Winnipeg: Cereal Research Center.)

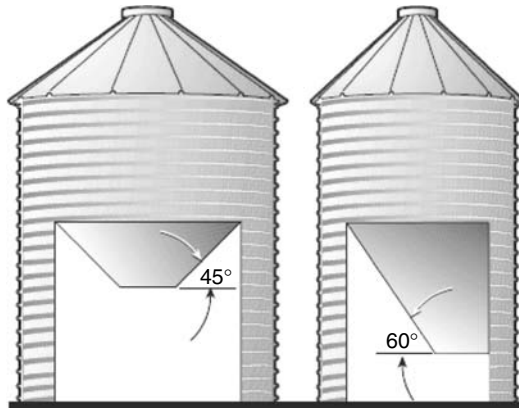


**FIGURE 4.38** Typical bulk storage sheds. (From J.T. Tyson, R.E. Graves. Bulk storage fact sheets # H 75, College of Agricultural Sciences, Cooperative Extension, Pennsylvania State University, University Park, PA, 1996.)

conditioning grain [115]. It is a well-known and proven integrated pest management (IPM) tool for controlling insects and other risks in stored grain. Aeration reduces or inhibits biological activity by cooling the grain and preventing moisture migration by maintaining a relatively uniform temperature throughout the grain mass [116].

Aeration can cause changes in temperature and moisture content of the stored grain as “aeration fronts” pass through the grain. In bins over 2000 bu capacity, the grain bulk or mass is so large that it fails to cool uniformly enough to avoid storage problems as outdoor temperatures change with the seasons [117]. The unequal temperature in the grain mass then causes air current to circulate from warm to cold grain. Since warm air holds more moisture than cold air, the air moving up through the warm grain center picks up a full load of moisture, depositing some as it moves through the cold grain in the top layer. This causes moisture buildup, molding, and crusting. These minute “convection currents” in the grain cause moisture migration and accumulation that can only be prevented by reducing temperature difference in the grain bulk. The aeration process is illustrated in Figure 4.48.

Typically, it is recommended that grain producers maintain the temperature of the stored grain to within +5.5°C (10°F) of the average monthly temperature (depending on location), but not exceeding 15°C (59°F) in the warmer months or less than 0°C (32°F) during the winter [118].



**FIGURE 4.39** Center discharge and side discharge bins. (From J.P. Harner, III, F. Fairchild. Bulk ingredient storage. Publication # MF-2039, Kansas State University Agricultural Experiment Station and Cooperative Extension Service, Manhattan, KS, 1995.)



**FIGURE 4.40** Storage bin complex. (From CRC. Agriculture and Agri-Food Canada. Winnipeg: Cereal Research Center.)

The amount of time required for cooling the grain is a function of the airflow rate (fan size), air temperature, and RH of the air. If drying occurs during aeration, evaporative cooling effects will significantly reduce the amount of time required to cool a bin (119). However, it is not necessary to cool the grain mass below 35°F–40°F because the activity of important storage fungi is very low below these temperatures. The aeration system should not be used to raise the grain temperature above 60°F because mold and insect growth occurs at a much faster rate above this temperature [97]. Power requirements for aeration vary with airflow rate, type of grain, and the distance the air must travel through the grain (Table 4.25). The airflow rate should be adequate to cool the entire grain mass before deterioration begins. Normal aeration airflow rates range from 1 to 2 L of air per second per cubic meter of grain (1–2 L/s-m<sup>3</sup>) (0.08–0.16 cfm/bu). Higher rates should be used (2–6 L/s-m<sup>3</sup>) if grain is stored at higher moisture levels or if a large variance in incoming moisture levels exists [120]. Uniform temperatures through grain mass (Figure 4.49) can be maintained in aerated grain storage if the aeration system has been well designed and is properly operated. Aeration ducts installed in a bin are shown in Figure 4.50. Automatic control of aeration based on ambient temperatures is an inexpensive method to improve the efficiency of aeration systems.



FIGURE 4.41 A bin complex. (From CRC. Agriculture and Agri-Food Canada. Winnipeg: Cereal Research Center.)



FIGURE 4.42 Wooden bins. (From CRC. Agriculture and Agri-Food Canada. Winnipeg: Cereal Research Center.)

#### 4.3.1.5 Grain Inspection

The grain surface should be inspected at least every other week throughout the storage period. Evidences of hot spots, insect infestations, or other problems that start in the grain mass soon migrate to the surface. Hot spots will be seen as damp, warm, and musty areas. Insects and mold growth are more likely to show up where broken corn has accumulated.

#### 4.3.1.6 Chemical Methods

Insect infestation in stored grain and grain products can be controlled effectively by fumigation. Over the past 100 years, fumigation has been the most effective method of pest control in stored rice [122]. Up to nine different chemicals have been used as fumigants, but currently, only chlorpyrifos-methyl (Reldan) and phosphine are considered safe. Historically, malathion and methyl bromide were used extensively to protect stored rice from insect damage, but many stored-product insect species have developed resistance



**FIGURE 4.43** Hopper-bottom bins. (From CRC. Agriculture and Agri-Food Canada. Winnipeg: Cereal Research Center.)



**FIGURE 4.44** Farm bins. (From CRC. Agriculture and Agri-Food Canada. Winnipeg: Cereal Research Center.)

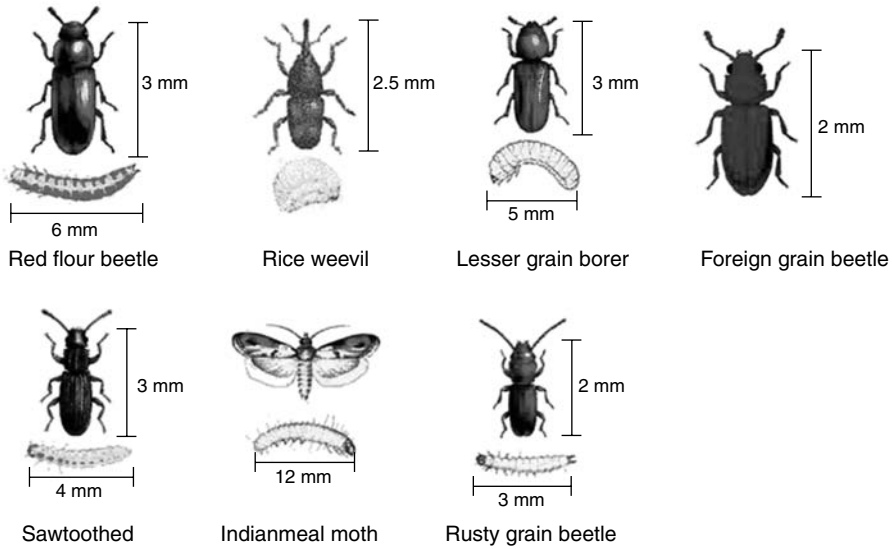
**TABLE 4.23**

Capacity per Unit Depth for Grain Bins of 4.6 m (15 ft) to 14.6 m (48 ft) Diameter

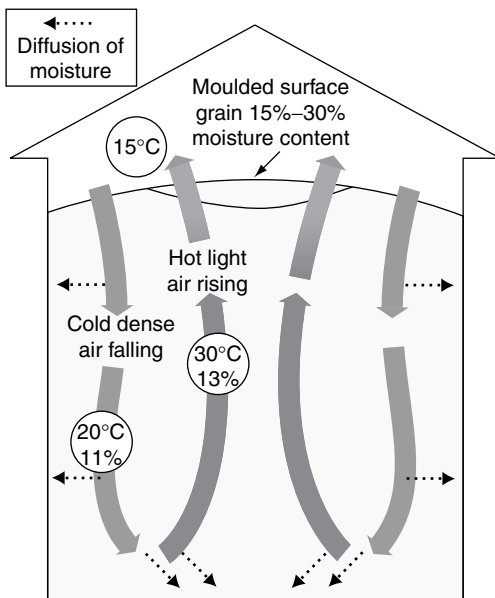
Diameter (ft)	15	18	21	24	27	30	33	36	39	42	48
Diameter (m)	4.6	5.5	6.4	7.3	8.2	9.1	10.1	11.0	11.9	12.8	14.6
Capacity (bu/ft)	141	203	277	362	458	565	684	814	955	1108	1448
Capacity (m <sup>3</sup> /m depth)	16.3	23.5	32.0	41.9	53.0	65.3	79.1	94.1	110.4	128.1	167.4

Source: M.R. Paulsen, W.L. Odekirk. *Appl. Eng. Agric.*, 16(5): 513–525, 2000.

to malathion [123]. Many of the chemical pesticides used to protect rice and other grains from insect activity are threatened by environmental legislation. For example, methyl bromide depletes the ozone layer and has been ordered to be phased out of use by 2005 in developed countries in response to the Montreal Protocol. Other pesticides may be in danger of losing their registration status due to the Food



**FIGURE 4.45** Some of the grain insects and their dimensions. (From CRC. Agriculture and Agri-Food Canada. Winnipeg: Cereal Research Center.)



**FIGURE 4.46** Air movement in grain. (From L. Caddick. *Farming Ahead*, 131: 35–36, 2002.)

Quality Protection Act and other Environmental Protection Agency rulings [124]. Chlorpyrifos-methyl is the only insecticide labeled for direct application to stored rice, but recent published reports have stated that lesser grain borers are developing resistance to chlorpyrifos-methyl [125]. Currently, the main chemical option for controlling insects in stored commodities is the fumigant phosphine. The fumigant phosphine has provided an important replacement to methyl bromide in several situations, but phosphine has one important disadvantage—it requires an exposure period of 5 days or longer, which makes it unsuitable for quarantine fumigation [122].

Other possible methods for the protection of stored products from insect infestations would be through the utilization of diatomaceous earth (DE), an inert dust registered to control insects in stored commodities [126], or through the utilization of radiation. Although the newer formulations of DE are more effective than the formulations of the past, they can still affect the physical properties of the stored grain [127]. It may be possible that DE could be an effective method for prevention

of infestations, but Arthur [128] demonstrated that extreme conditions, which may not be optimum for grain storage, are needed to allow the DE formulation to be the most effective. Radiation could also supply a direct alternative to the fumigation of rice, but there are few facilities available for this work.

Insects are poikilothermic organisms; therefore, their activity is controlled by their surrounding temperature. The optimal temperatures for their growth and development have been proposed to be between 25°C and 33°C, while 13°C and –25°C and 33°C and –35°C are considered suboptimal [129]. At temperatures below 13°C and above 35°C, most insects will eventually die [130].

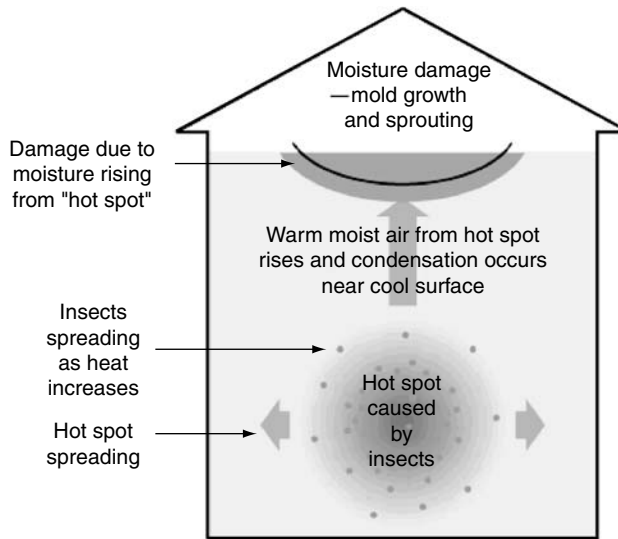


FIGURE 4.47 Development of hotspots due to insect infection. (From L. Caddick. *Farming Ahead*, 131: 35–36, 2002.)

TABLE 4.24

Optimal Development Conditions of Some Common Insect Species Found in Grain Storages

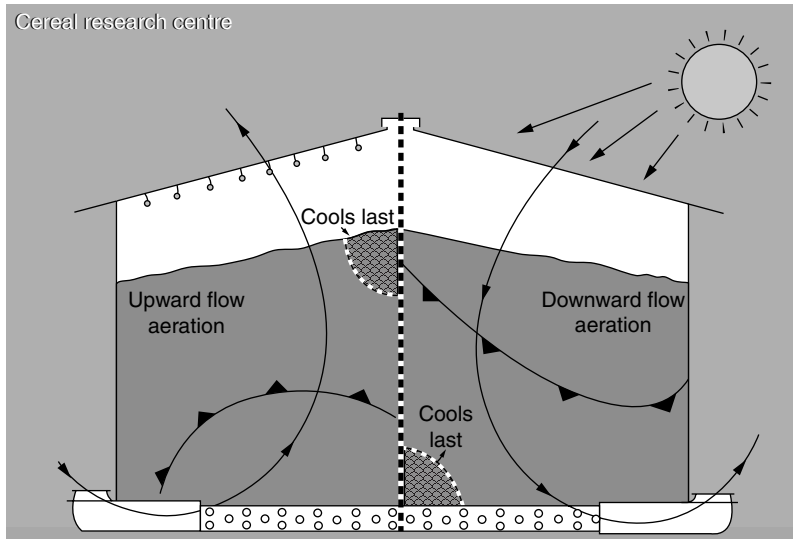
Insects	Temperature (°C)	Relative Humidity (%)
Angoumois grain moth ( <i>Sitotroga cerealella</i> )	26–30	75
Indian meal moth ( <i>Plodia interpunctella</i> )	26–29	70
Khapra beetle ( <i>Trogoderma granarium</i> )	33–37	25
Larger grain borer ( <i>Prostephanus truncates</i> )	25–32	80
Lesser grain borer ( <i>Rhyzopertha dominica</i> )	32–34	50–60
Red flour beetle ( <i>Tribolium castaneum</i> )	32–35	70–75
Rice weevil ( <i>Sitophilus oryzae</i> )	26–31	70
Rusty flour beetle ( <i>Cryptolestes ferrugineus</i> )	33	70–80
Sawtoothed grain beetle ( <i>Oryzaephilus surinamensis</i> )	31–34	90
Maize weevil ( <i>Sitophilus oryzae</i> )	26–31	70

Source: J.E. Montross et al. In: F.W. Bakker-Arkema, Ed. *CIGR Hand Book*, Vol. IV. St. Joseph, MI: American Society of Agricultural and Biological Engineers, 1999.

#### 4.3.1.7 Rodents

Rodents are among the most important global pests [131]. Three common rodents are the house mouse (*Mus musculus*), the brown rat (*Rattus norvegicus*), and the ship rat (*Rattus rattus*), also known as roof rat. The brown rat is also known as the Norway rat, house rat, barn rat, sewer rat, black rat, or wharf rat. Every year, rats in Asia consume food crops that could feed 200 million people for an entire year [132]. Damage due to rodents in Tanzania causes an estimated annual yield loss of 5%–15% of corn, corresponding to about \$45 million, and food that could feed about 2 million people [133]. In parts of South America, native rodents cause crop damage varying between 5% and 90% of the total production [134]. It is estimated that one rat can consume about 10 g of feed per day and destroy 10 times of this amount during feeding by its dropping and urine [135]. Infestation of feed grains by mites can seriously reduce their nutritional quality and acceptance by animals [136]. There is also a possibility of mites causing allergy problems in workers handling contaminated grain and grain products [137].

Rodent killing as a single control measure is expensive and effective for only brief periods of time. It is most effective if carried out during the winter when reproduction is at its lowest level. Two forms of rodent control are normally practiced. Trapping is the most common method of rat killing. Traps may or may not be baited but should always be placed in areas of rodent activity. Bacon, peanut butter, bread,



**FIGURE 4.48** Aeration process illustrations. (From CRC. Agriculture and Agri-Food Canada. Winnipeg: Cereal Research Center.)

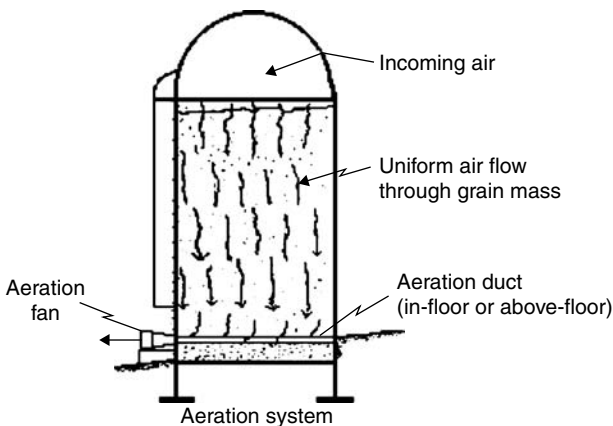
**TABLE 4.25**

Approximate Static Pressure

Rate (cfm/bu) <sup>a</sup>	Airflow Distance through Grain (ft)	Static Pressure (in. of Water)	
		Maize	Wheat
1/20	50	1.0	3.3
1/10	50	1.8	6.9
1/20	100	3.0	13.0
1/10	100	7.3	25.0

<sup>a</sup>ft<sup>3</sup>/min/bu (≈ m<sup>3</sup>/min/tonne).

Source: J.E. Bailey. In: D.B. Sauer, Ed. *Storage of Cereal Grains and Their Products*. St. Paul, MN: American Association of Cereal Chemists, 1992, pp. 157–182.



**FIGURE 4.49** Aeration system. (From Ministry of Agriculture, Food and Rural Affairs, Government of Ontario, Canada, <http://www.omafra.gov.on.ca/english/engineer/facts/88-070.htm>.)

and nutmeats make suitable baits. Mousetraps should be placed at intervals of about 1 m (3–4 ft); ratttraps should be set 4.5–9 m (15–30 ft) apart. Traps are an alternative to rodenticides, especially where chemicals cannot be used; however, the use of traps is more labor intensive than chemicals.

**4.3.2 Structural Considerations: Warehouse and Silo**

**4.3.2.1 Warehouses**

Warehouses are used to store milled rice. Millers normally use bags to store, which may vary in size from 50 lb (22.7 kg) to 1 tonne. Warehouses are much less



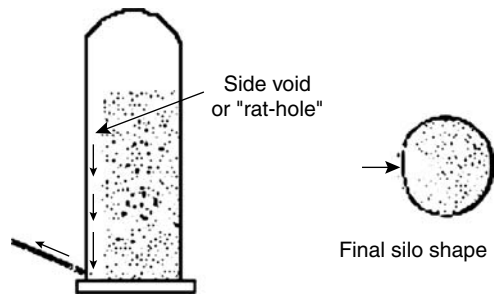


**FIGURE 4.50** Aeration ducts in a bin. (From CRC. Agriculture and Agri-Food Canada. Winnipeg: Cereal Research Center.)

efficient than bins and higher costs associated with storage, but are very useful for higher-valued products such as milled and specialty rice [138].

#### 4.3.2.2 Grain Bulk

The design of bins and silos involves bulk materials, and geometric and structural considerations. The frictional and cohesive properties of bulk grains vary from one grain to another. In addition, a given bulk grain's flow properties can vary dramatically with changes in numerous parameters such as particle size, moisture, temperature, and consolidating pressure. Some of the design techniques that are commonly used take into account grain properties such as specific weight ( $\gamma$ ), angle of internal friction ( $\phi$ ), and grain-to-wall friction coefficient.



**FIGURE 4.51** Rat-holing leads to unbalanced sidewall forces. (From Ministry of Agriculture, Food and Rural Affairs, Government of Ontario, Canada, <http://www.omafra.gov.on.ca/english/engineer/facts/88-070.htm>.)

#### 4.3.2.3 Storage Structure Design

While considering the geometric design of a silo, potential problems include arching across an outlet, rat-holing (Figure 4.51) through the material, and the flow pattern during discharge [139]. The arching or rat-holing is primarily related to grain's cohesiveness, while its flow pattern during discharge depends upon internal friction as well as the friction that develops between the grains and the silo's hopper walls. The goal of geometric design is to maximize the usable capacity of a silo while minimizing its capital cost, overall height, etc. [139].

The silo design procedures include selection of the optimum hopper angles and minimum outlet dimensions. The ideal discharge mode is one where, at steady state, all material flows. The structural design of a silo requires knowledge of the distribution of pressures and shear stresses on its walls (caused by the stored grain) and how that distribution varies during charging, storage at rest, discharging, and recharging [139].

Grain-storage bins are generally designed as thin-walled cylindrical shells and typically loaded and unloaded along the line of their central axis. The loads exerted by grain on silo structures can be grouped into two categories: those because of initial fill and those that are due to flow. When grain is poured into a bin, it forms an angle from the horizontal called the angle of repose. The outflow hopper at the bottom

**TABLE 4.26**

Angle of Repose of Selected Cereal Grains

Grain	Bulk Density (kg/m <sup>3</sup> )	Kernel Density (kg/m <sup>3</sup> )	Porosity (%)	Angle of Repose, Filling	Emptying
Barley (Bedford)	664	1346	44	24	26
Oats (Fidler)	555	1315	52	27	25
Wheat, bread (Columbus)	780	1379	38	26	23
Rye (Gazelle)	760	1406	41	25	21
Wheat, durum (Coulter)	744	1377	41	23	21

Source: W.E. Muir, R.N. Sinha. *Can. Agric. Eng.*, 30(1): 51–55, 1988; M. Rameshbabu et al. *Can. Agric. Eng.*, 38(1): 31–35, 1996.

**TABLE 4.27**

Design Parameters for Selected Grains

Grain	MC (%)	WM	$\mu$	$K$	$W$ (kg/m <sup>3</sup> )
Barley	11.0	Smooth steel	0.10	0.4	620
	11.0	Corrugated steel	0.35	0.6	620
	11.0	Plywood	0.30	0.6	620
	11.0	Concrete	0.35	0.6	620
Corn, shelled	11.0	Smooth steel	0.20	0.4	720
	11.0	Corrugated steel	0.35	0.6	720
	11.0	Plywood	0.30	0.6	720
	1.0	Concrete	0.35	0.6	720
Wheat	11.0	Smooth steel	0.10	0.4	770
	11.0	Corrugated steel	0.35	0.6	770
	11.0	Plywood	0.30	0.6	770
	11.0	Concrete	0.35	0.6	770

WM, wall material;  $\mu$ , coefficient of friction between the grain and bin wall;  $K$ , ratio of lateral-to-vertical pressure;  $W$ , grain bulk density.

Source: Z. Ni. An expert system for analysis of grain bin loads. MS thesis, University of Manitoba, Winnipeg, 1997.

**TABLE 4.28**

Material Properties for EP433

Wall Material	$l$	$K$
Concrete	0.40	0.5
Corrugated steel	0.37	0.5
Steel, smooth	0.30	0.5

Source: Z. Ni. An expert system for analysis of grain bin loads. MS thesis, University of Manitoba, Winnipeg, 1997.

of a bin must be cone shaped and have a slope greater than the angle of repose, or the grain will not flow out. Smaller bins require a steeper slope because of the greater friction on the sides of the hopper. Angle of repose of some cereal grains is presented in Table 4.26. The lateral pressure of the grain on bin walls is about 0.3–0.6 of the vertical pressure, and the vertical pressure increases very little after a depth of about three times the bin diameter [15]. Grain settles or packs during storage. Lightweight grain such as oats may pack to lose as much as 28% of its volume.

Design values for coefficient of friction of grains on various materials are important. However, the coefficient of friction varies not only with each type of grain, but also with the experiment condition such as moisture content. Hence, the selection of the coefficient of friction will depend on the personal experience of individual engineer [142]. Design parameters for some of the grains at different moisture contents are presented in Table 4.27.

Several countries have adopted codes and standards for bin designs to ensure safe and better-quality structures. Those include the Canadian Farm Building Code [143] and EP433 [144]. In EP433, a maximum of 834 kg/m<sup>3</sup> is recommended for the bulk density of any free-flowing grain, and other material properties depend only on wall material [142]. The properties of some of the wall materials are presented in Table 4.28.

**TABLE 4.29**

Recommended Values of the Angle of Internal Friction ( $\phi$ ), Apparent Cohesion ( $C$ ), Dilatancy Angle ( $\psi$ ), and Poisson's Ratio ( $\nu$ ) for Selected Grains at Certain Moisture Content

Grain	$\phi$ (°)	$C$ (kPa)	$\psi$	$\nu$	MC (%)
Barley (krona)	24.8–26.6	0.58–5.19	7.0–18.9	0.33–0.35	12.80
Barley (kym)	21.6–25.4	0–10.72	4.0–4.9	0.35–0.36	11.92
Chickpea (eulalia)	26.8–28.8	0–8.25	27.1–34.4	0.26–0.27	10.51
Wheat (camacho)	20.8–24.6	2.87–13.16	6.0–14.4	0.27–0.37	11.15

Source: M. Moya et al. *Trans. ASAE*, 45(5): 1569–1577, 2002.

**TABLE 4.30**

Recommended Values for Real Specific Weight ( $Y_r$ ), Apparent Specific Weight ( $Y_{ap}$ ), and Modulus of Elasticity ( $E$ ) at Certain Moisture Content

Grain	$Y_r$ (N/m <sup>3</sup> )	$Y_{ap}$ (N/m <sup>3</sup> )	$E$ (kPa)	MC (%)
Barley (krona)	11,707	6451	1267–1372	12.80
Chickpea (eulalia)	13,218	8313	5780–5903	10.51
Oats (prevision)	10,225	4747	413–571	10.00
Wheat (horzal)	12,575	8147	5048–5211	11.03

Source: M. Moya et al. *Trans. ASAE*, 45(5): 1569–1577, 2002.

ASAE Standards [144] give design recommendations for axial symmetric states of stress. However, during the operation of a grain facility, certain loading and unloading conditions can create a nonuniform distribution of pressure within a grain bin. The highest asymmetry of bin load is thought to occur during eccentric unloading. Nonsymmetrical bin loads, which occur during eccentric discharge, are considered a major cause of bin failure [145].

The design of grain silos requires the designer to understand not only the principles of structural design but also the properties of stored grains. Eurocode for bin design has been published to provide guidelines for silo designers [146]. This design standard predicts bin loads using Janssen's equation.

Recently, numerical methods have been used in grain silo design. It has been possible to better model the behavior of grain inside a bin. However, to use these methods, it is necessary to consider additional grain properties such as elastic modulus ( $E$ ), Poisson's ratio ( $\nu$ ), and dilatancy angle ( $\psi$ ). However, very limited information is available on these design parameters [147]. Tables 4.29 and 4.30 present some additional grain properties that can be used in numerical methods of silo design. Storage capacities of grain bins are shown in Table 4.31.

### 4.3.2.4 Grain Handling

#### 4.3.2.4.1 Conveyors

There are various types of grain conveyors, such as en-masse conveyor, and U-trough conveyors and tube augers.

**4.3.2.4.1.1 En-Masse and Shrouded Conveyors** En-masse conveyors (Figure 4.52) can be designed to move grain in any application at any operating angle. However, an en-masse conveyor starts to lose capacity with an operating angle greater than horizontal, and the maximum operating angle is often considered to be 7° [110]. En-masse conveyors do less damage to grain than augers and are often recommended in high-capacity handling situations because of lower power requirements. Once the operating angle exceeds 70°, it is recommended to use a shrouded conveyor. A shrouded conveyor acts more like a drag conveyor, pulling grain along the inside of an enclosed chamber. Shrouded conveyors are typically used with operating angles up to 45° [110].

**TABLE 4.31**

Storage Capacity of Bins

Bin Diameter (m)	Bin Height (m)	Stored Capability (Tonnes)
4.0	3.0	38
4.0	4.0	48
4.0	5.0	58
4.0	6.0	68
4.0	7.0	79
4.0	8.0	89
4.0	9.0	99
4.0	10.0	109
5.0	3.0	61
5.0	4.0	77
5.0	5.0	93
5.0	6.0	110
5.0	7.0	126
5.0	8.0	142
5.0	9.0	158
5.0	10	174
6.0	4.0	115
6.0	5.0	138
6.0	6.0	162
6.0	7.0	185
6.0	8.0	208
6.0	9.0	237
6.0	10	254
7.0	4.0	162
7.0	5.0	194
7.0	6.0	225
7.0	7.0	256
7.0	8.0	288
7.0	9.0	319
7.0	10	351
8.0	4.0	218
8.0	5.0	260
8.0	6.0	301
8.0	7.0	342
8.0	8.0	383
8.0	9.0	424
8.0	10	465

Source: Z. Ni. An expert system for analysis of grain bin loads. MS thesis, University of Manitoba, Winnipeg, 1997.

(12 in.), or 356 mm (14 in.) [110]. The power requirement of a bucket elevator depends on the capacity and product-elevating height (Table 4.35).

### 4.3.3 Controlled Atmospheric Storage of Grain

Controlled atmospheric (CA) storage of grains includes commodity-modified CA storage and artificially modified CA storage [150]. In case of commodity-modified storage, respiration of the grain and the microorganisms reduce the O<sub>2</sub> and increases the CO<sub>2</sub>. The atmosphere in a modified storage is changed by injecting N<sub>2</sub> or CO<sub>2</sub> into the system [108]. Nitrogen-producing exothermic generators are available commercially for altering the intragranular gas composition in a grain storage system. Carbon dioxide (CO<sub>2</sub>) is another gas that can also be used for CA storage of grains.

**4.3.2.4.1.2 U-Troughs and Tube Augers** U-trough conveyors are often used for horizontal applications for reclaim from bins or across the roofs of bins. Both tube augers and U-troughs will do less damage to grain if run full and at low speeds. Both types of augers lose about 40% of their capacity in wet grain [110]. The capacities and power requirements for horizontal screw conveyors (augers) are presented in Tables 4.32 and 4.33, respectively. The auger capacities will vary with grain type, condition, and loading method. The information presented here are to be used as a guide only, and the power requirement will vary with condition and type of grain, loading factor, rpm, use of reduction pulleys, and speed reducers. For high-moisture grain, the power should be multiplied with a factor of 1.5.

**4.3.2.4.1.3 Pneumatic Conveyors** Pneumatic conveyors are used for transporting dry grain away from grain dryers to storage bins. Some advantages of pneumatic conveyors are: they are self-cleaning, they allow transport of different products without contamination; dust is totally enclosed except at discharge; they are safe (no moving parts other than blower and airlock). Their disadvantage [110]: power requirements greater than other methods, noisy to operate; and grain damage can occur if the system is not operated properly, so grain velocities remain around 762–914 m/min (2500–3000 ft/min). Typical pneumatic conveyor characteristics are presented in Table 4.34.

**4.3.2.4.1.4 Bucket Elevators** Bucket elevators provide an effective way to distribute and automate handling of grain. Spouts normally come in diameters of 102 mm (4 in.), 152 mm (6 in.), 203 mm (8 in.), 254 mm (10 in.), 305 mm



FIGURE 4.52 En-masse conveyor. (From GSI Grain Systems, Assumption, IL, 2005.)

TABLE 4.32

Capacities for Horizontal Screw Conveyors with Clean Dry Corn at 90% Loading (Which Is Usually Maximum)

Auger Diameter, mm (in.)	Auger, rpm	Capacity, t/h (bph) per 100 rpm	Capacity, t/h (bph) at Stated rpm	% Loss from Horizontal for 45° Angle of Operation	% Loss from Horizontal for 90° Angle of Operation	% Loss for 25% Moisture Content Corn
102 (4)	312	1.5 (60)	4.7 (187)	20	50	40
102 (4)	875	1.5 (60)	13.3 (525)	20	50	40
152 (6)	276	6.4 (250)	17.5 (690)	20	50	40
152 (6)	510	6.4 (250)	32.4 (1275)	20	50	40
203 (8)	269	12.7 (500)	34.2 (1345)	20	50	40
203 (8)	438	12.7 (500)				
		(1200)	55.7 (2190)	20	50	40
254 (10)	261	30.1 (1200)	79.6 (3132)	20	50	40
254 (10)	350	30.1 (1200)				
		(2000)	106.8 (4200)	20	50	40
305 (12)	285	50.8 (2000)	144.9 (5700)	20	50	40
305 (12)	350	50.8 (2000)	178.0 (7000)	20	50	40
356 (14)	80	101.7 (4000)	81.4 (3200)	20	50	40
356 (14)	200	101.7 (4000)	203.4 (8000)	20	50	40

Source: Hutchinson Manufacturing. In: *Hutchinson Product Catalog*. Clay Center, KS: Hutchinson Manufacturing, 1998.

## 4.4 Milling

### 4.4.1 Grain-Milling Operations

The term milling refers to the size reduction of granular material, but for cereal grains the term has different connotations. Wheat milling means wheat grinding to prepare flour. Rice milling includes operations like dehulling and polishing, whereas pulse milling may involve processing operations such as

**TABLE 4.33**

Length of the Horizontal Auger That Can Be Powered by a Given Motor Horsepower

Motor, kW (hp)	Length of Auger, m (ft)			
	152 mm (6 in.) Diameter	203 mm (8 in.) Diameter	254 mm (10 in.) Diameter	305 mm (12 in.) Diameter
1.1 (1.5)	4.6 (15)	—	—	—
1.5 (2)	7.6 (25)	4.6 (15)	3.0 (10)	—
2.2 (3)	13.7 (45)	7.6 (25)	6.1 (20)	4.6 (15)
3.4 (5)	21.3 (70)	15.2 (50)	10.7 (35)	7.6 (25)
5.6 (7.5)	33.5 (110)	24.4 (80)	15.2 (50)	12.2 (40)
7.5 (10)	—	33.5 (110)	24.4 (80)	15.2 (50)
11.2 (15)	—	—	33.5 (110)	24.4 (80)
Capacity with corn, t/h (bph)	22.9–0.5 (900–1200)	38.1–50.8 (1500–2000)	63.6–89.0 (2500–3500)	101.7–127.1 (4000–5000)

Source: Hutchinson Manufacturing. In: *Hutchinson Product Catalog*. Clay Center, KS: Hutchinson Manufacturing, 1998.

**TABLE 4.34**

Typical Pneumatic-Conveyer Characteristics

Pipe Diameter (cm)	Capacity (m <sup>3</sup> /h)	Power (kW)
7.6	14.1	7.6
10.2	24.7	11.5
12.7	42.3	15.3–22.9
15.2	70.5	30.6–38.2

Source: Midwest Plan Service. *Grain Drying, Handling, and Storage Handbook*, 2nd ed. MWPS-13, Ames, IA: Iowa State University, 1987.

**TABLE 4.35**

Typical Bucket Elevator Data for Maize

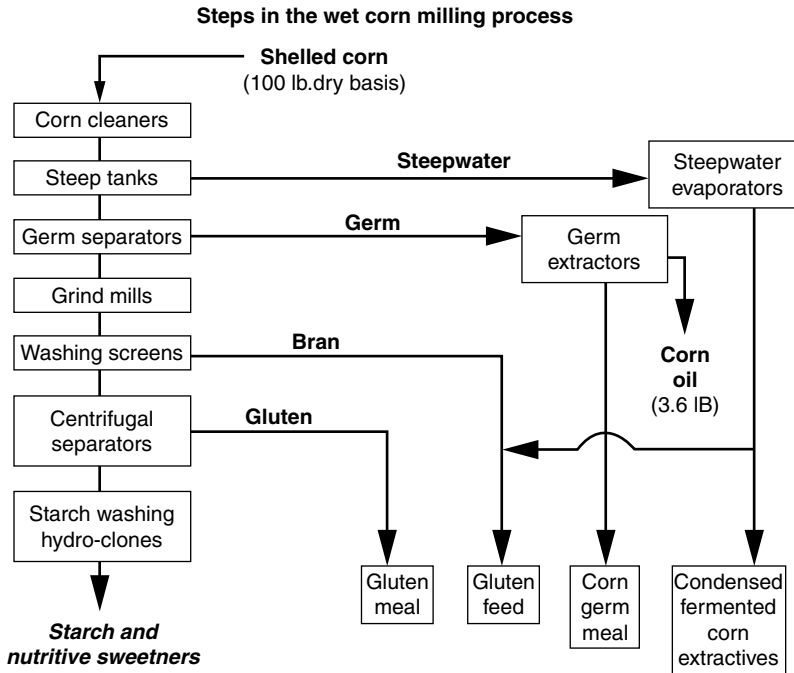
Capacity (m <sup>3</sup> /h)	Belt Speed (m/min)	Bucket Size (cm)	Bucket Spacing (cm)	Power (kW/m)
35	101	22.9 × 12.7	30.5	0.098
53	115	22.9 × 12.7	22.9	0.147
70	101	22.9 × 12.7	15.2	0.196
88	129	22.9 × 12.7	15.2	0.245
106	151	22.9 × 12.7	15.2	0.294
141	151	22.9 × 15.2	16.5	0.392

Source: D.B. Brooker et al. *Drying and Storage of Grains and Oilseeds*. New York: Van Nostrand Reinhold, 1992.

husk separation, splitting of kernels and polishing, or just polishing. The dry milling of cereals consists of grain cleaning, tempering and conditioning, and roller milling. It is primarily concerned with separation of the anatomical parts of grain. Roller mills are considered to be the workhorses of the grain-milling industry. In flour milling, roller mills perform bran separation as well as size reduction. First-break, or the first roller mill operation in the milling process, performs the first bran separation by opening the wheat kernels with minimum bran breakage. Bran coming out in the form of flakes ensures ease of separation from the endosperm in succeeding stages. Mechanical energy is required to impart compressive and shear forces that break wheat kernels and reduce the size of endosperm particles [151].

#### 4.4.2 Specialty Milling

Identity-preserved (IP) grains are referred to as specialty, high-value, premium, or niche market grains. They are produced with a specific end use in mind—perhaps human food, a specific kind of animal feed, cosmetics,



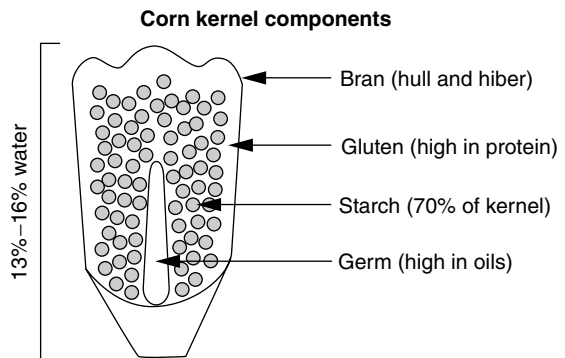
**FIGURE 4.53** Overview of a wet corn milling process. (From J.W. Schroeder. Corn gluten feed: composition, storage, handling, feeding and value. AS-1127, Extension Service, North Dakota State University, Fargo, ND, 1997.)

pharmaceuticals, or industrial use [152]. Example of IP cereal grain is corn, high oil, endosperm/food grade, white, high amylose, waxy, nutritionally dense (low phytase, high lysine, or methionine).

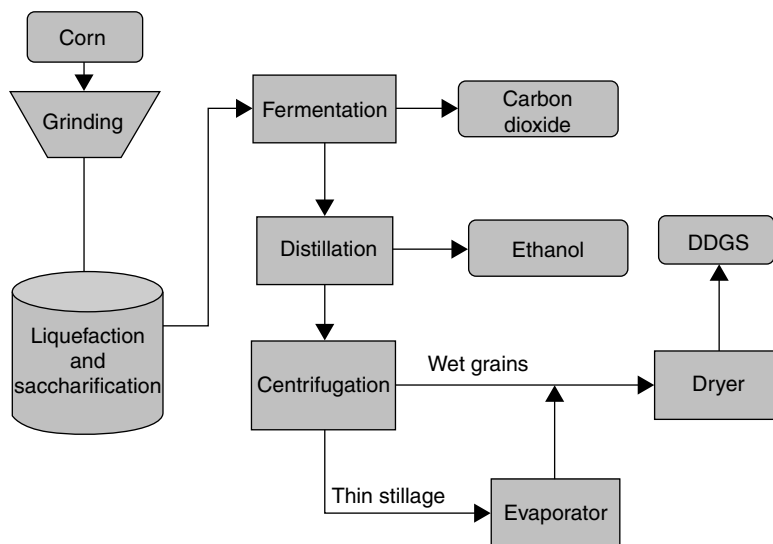
Corn wet milling is a complicated, large-scale, and efficient industrial process designed to separate the chemical components from corn kernels. The success of wet milling, in terms of maximum yields, is largely dependent on the success of the steeping process. Improper steeping, or steeping of corn kernels that have unusual physical or chemical structures, results in lost product and lower profits. Steeping processes however are still based largely on an art that was developed more than 100 years ago [153]. As the market increases for specialty corn, corn genetically bred with unique starch characteristics or, corn with altered chemical composition, a thorough scientific understanding of steeping chemistry and the entire wet milling process will become increasingly important.

The wet milling process goes a step further than cleaning by separating some of those anatomical parts into their chemical constituents, such as starch, protein, oil, and fiber instead of bran, germ, and endosperm [15]. The steps involved in corn wet milling are shown in Figure 4.53. The different components derived from corn wet milling operation are shown in Figure 4.54.

The effectiveness of the dry grind corn process (Figure 4.55) lies in complete conversion of starch into ethanol. It is important that starch is available for digesting enzymes such as  $\alpha$ -amylase and glucoamylase. This is possible only if starch granules are exposed during grinding and cooking processes. It has been observed that starch granule structure differs significantly in hard and soft endosperms. The protein and



**FIGURE 4.54** Components derived from corn in the wet milling process. (From J.W. Schroeder. Corn gluten feed: composition, storage, handling, feeding and value. AS-1127, Extension Service, North Dakota State University, Fargo, ND, 1997.)



**FIGURE 4.55** Dry grind corn process. (From G.S. Murthy et al. Effect of corn endosperm hardness on different stages of dry grind corn process. Paper No. 046063. St. Joseph, MI: American Society of Agricultural Engineers, 2004.)

starch matrix also is different in endosperm fractions. It has been observed that hard and soft endosperm in corn significantly differ in their dry milling characteristics, and these differences may be due to structural differences in the protein–starch matrix and nature of endosperm starch granules. Endosperm hardness might have an effect on starch conversion into glucose and fermentability of glucose into ethanol [155]. Optimization of the dry and wet milling processes requires timely knowledge of the distribution of milled products and their by-products. Although the machinery used in various milling operations is important, control and operation of the machines by the operator are even more critical.

#### 4.4.3 Rice Milling and Processing

An ideal rice mill removes the bran layers and germ from brown rice kernels with minimal kernel breakage and preserving each kernel in its original shape [156]. The quality of milled rice is largely determined by the yield of well-milled, whole kernels, referred to in the rice industry as head rice [157]. Broken rice kernels are sold at a much lower price than head rice.

The most common huller used in milling operations is a rubber-roll sheller (Figure 4.56). They are preferred because of their efficiency in removing hull (>90%). In a modern rice mill, a pair of rubber-lined rollers are mounted in an enclosed chamber and driven at a friction ratio. A typical unit using 254 mm nominal width  $\times$  254 mm outer diameter rollers is run at 1.28:1 friction ratio with the faster roller at 900 rpm [158]. The nip of the rollers is manually adjusted during dehulling to compensate for the gradual abrasion of the rubber surface and its thermal softening. The paddy passing through the rollers nip is subjected to both compressive and shearing forces. When these forces are correctly predetermined for a particular grade of paddy (by rubber hardness, resilience, rollers nip, speed, and friction ratio), the paddy will remain substantially intact after going through, while the husk is broken off. In practice, the dehulling efficiency can be as high as 90% per pass. The products from a rice mill are head rice, broken, rice bran, rice polish, and the hulls. In general, paddy rice yields 20% hulls, about 2% polish. The remaining 70% is broken or head rice [15]. A schematic diagram of rice milling operation is presented in Figure 4.57.

The pearler or milling machine is the most critical machine in a rice mill, in which bran is removed, and also in which most of the breakage occur [153]. Figure 4.58 shows a mill-top one-pass rice pearler combined with husker. The degree of milling can be controlled by varying the pressure and thereby regulating the average residence time in the chamber. Figure 4.59 shows a paddy husker.

Parboiling of rice is considered as a means of reducing broken losses during milling. The idea is based on the attributes of apparent hardness of parboiled rice. Breakage of nonparboiled rice during milling is generally related to various physical properties of the grain and environmental conditions during the



growing season, harvesting, handling, and storage of rice [162]. Rice grains with stress fissures break more readily than sound kernels during handling, milling, and transportation, and thereby reducing the quality and market value of the grain [57]. The value of the broken rice grain is often one-half of that of the whole grain [6]. The major source of broken rice during milling is fissured grains [163].

#### 4.4.4 Dehulling and Splitting of Pulses

In many countries of the world, pulses are initially processed by removing the hull and splitting into dicotyledonous components. Dehulling operation is usually performed in two steps, the first involves loosening the husk from the cotyledons and the second removing the husk from cotyledons and splitting them using a roller machine or stone chakki.

Graded grains are made to pass through a roller machine, which causes a mild abrasion (tempering operation). Tempering operation causes slight scratches on the seeds and enhances their oil- and water-absorbing efficiency leading to the loosening of the testar. Grain is then treated with oil and water, and then spread on drying yards to dry under the sun. For dehulling of conditioned pulses, emery rollers called Gota machines are used. In one pass or single operation about 50% of pulses are dehulled. Dehulled pulses are split into two parts. Dehulled split pulses are separated by sieving and the husk is aspirated off. Unsplit dehulled pulses and tail pulses are again dehulled and milled in a similar way. Till all the pulses are dehulled and split off, the whole process is repeated twice or thrice.

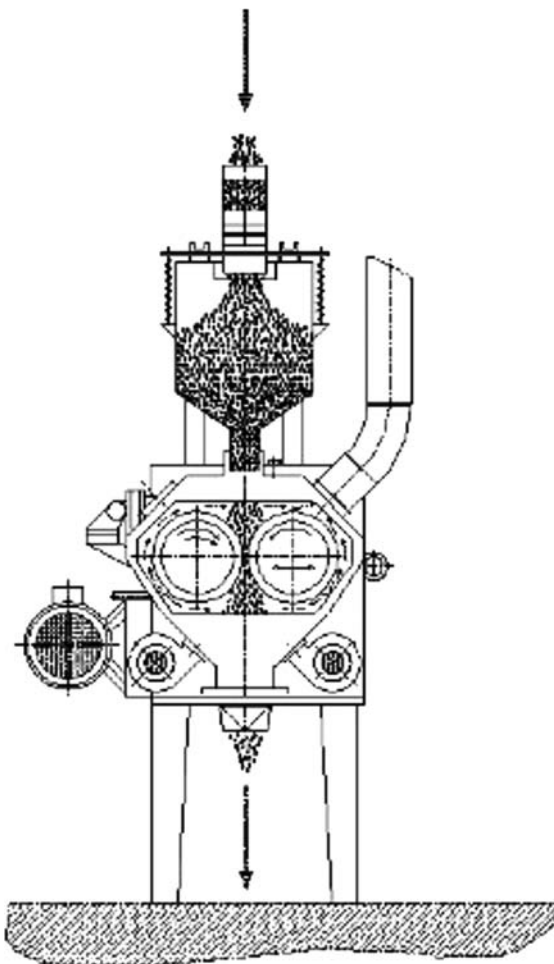


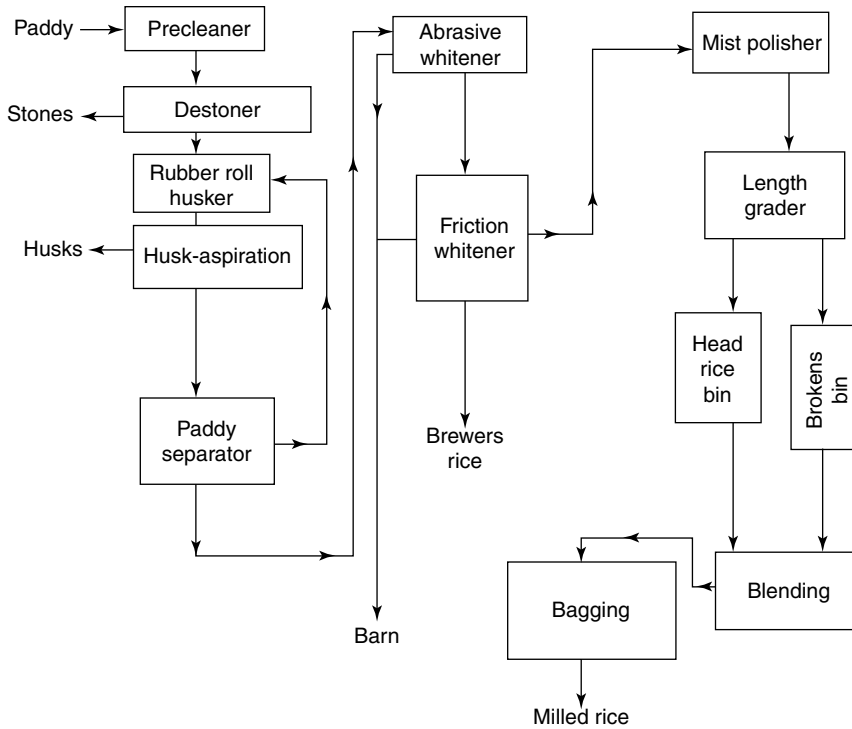
FIGURE 4.56 Rubber-roll sheller. (From Rubber-roll sheller S10 PR. Reinbek, Germany: FH Schule Muhlenbau GmbH.)

##### 4.4.4.1 Wet Milling of Pulses

There are two types of conventional pulse milling methods in India: wet and dry milling methods. The flow diagram of wet milling is given in Figure 4.60.

##### 4.4.4.2 Dry Milling of Pulses

Hulling of legumes on a commercial scale is generally based on dry-processing techniques. Many of the operations, particularly husking and splitting, are mechanized. For all types of pulses there is no common processing method. However, some general operations of dry-milling method such as cleaning and grading, rolling or splitting, soiling and moistening, and drying and milling are considered (Figure 4.61). Removal of the loosened husks from the pulses in the dry-milling technique is done in small machines. Hand- or power-operated under-runner disk shellers or grinders with emery or stone contact surfaces are normally used. A plate mill with a blunt contact surface is sometimes used both to husk and split soaked and dried pulses. After aspirating or winnowing off the husk, the split cotyledons are separated by sieving.



**FIGURE 4.57** Schematic representation of rice milling operation. (From National Bank of Agriculture and Rural Development, Mumbai, India.)

Remaining unsplit whole grains are similarly processed until almost all the grain is husked. In certain parts of India, oil-treated and sun-dried grains are husked in an Engelberg-type rice huller after being mixed with 2%–3% stone powder. Sound kernels are removed by sieving, while the husk, powder, and small brokens remain in the stone powder [165]. Figure 4.62 shows the facility for dehulling and splitting of a variety of pulses at the Canadian International Grains Institute [166].

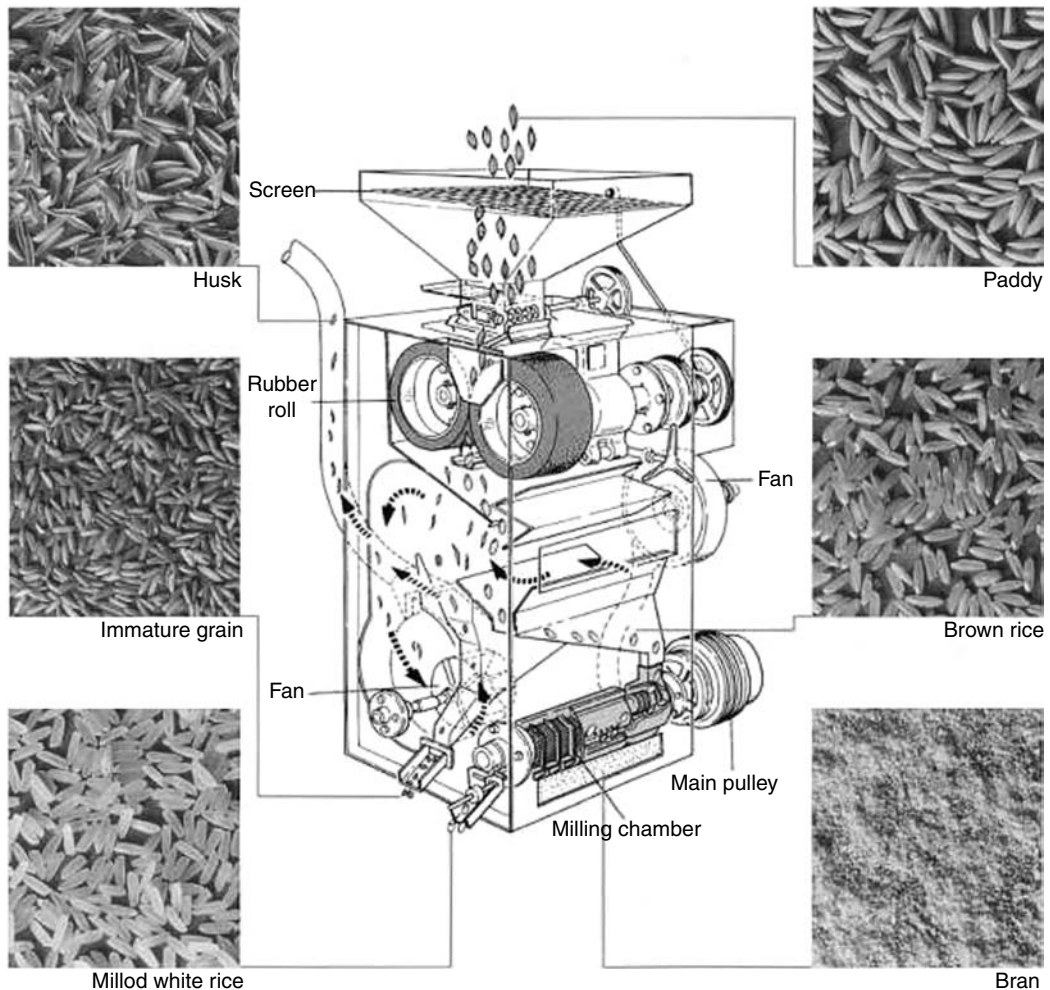
#### 4.4.5 Milling of Pulses

Dry whole seeds of pulses possess a fibrous seed coat or testa (husk, hull, or skin). The seed coat is often indigestible; therefore, pulses are mainly consumed after dehulling to improve their palatability and taste. In most parts of the world, pulses are traditionally consumed either in the whole or in the form of dehulled split pulse. Dehulling, therefore, is an important primary processing activity. Milling provides dehulled cotyledons with better appearance, texture, and cooking qualities [167].

##### 4.4.5.1 Milling Technologies

Milling of pulses involves removal of outer husk and splitting the grain into two equal halves. Generally, the husk is much more tightly held by the kernel of some pulses than most cereals, causing dehulling of pulses a problem. The method of alternate wetting and drying is used to facilitate dehulling and splitting of pulses. In developing countries, the dehulled pulses are produced by traditional milling methods. In traditional milling, the loosening of husk by conditioning is not sufficient. Therefore, a large amount of abrasive force is applied for the complete dehulling of the grains, which result in high losses in the form of broken and powder. Consequently, the yield of split pulses in traditional mills is only 65%–70% in comparison to 82%–85% potential yield [31].

Pulse milling constitutes two major steps: loosening of the husk, followed by removal of the loosened husk by suitable milling machinery. The first step is referred to as premilling, whereas the second is referred



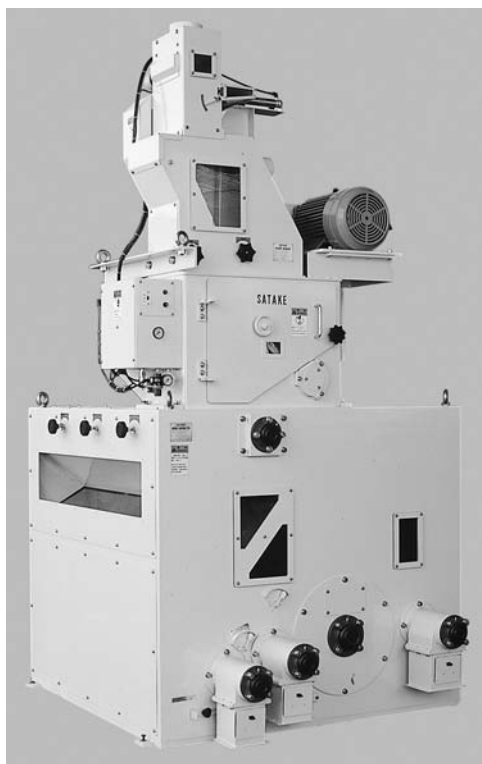
**FIGURE 4.58** One-pass rice pearly combined with husker. (From HR Paddy Husker. Stockport, England: Satake Corporation UK.)

to as milling or dehulling. Loosening of husk is achieved either by a wet or a dry method. In the wet method, the grains are soaked in water for a few hours, drained, left in heaps (usually overnight), and dried in sun. In the dry method, cleaned and size-graded grains are mixed with a small amount of oil, usually after scarification of husk. This scarification of husk is commonly called as pitting and is done to facilitate the oil penetration between the husk and the cotyledons. Oil-treated grains are heaped overnight and then dried in the sun for 2–5 days, with intermittent water spraying and mixing. In both of the premilling treatments, adherence of the husk to the cotyledon weakens and, as a result, its removal becomes easy [167].

There is no common processing method for all types of pulses. However, some general operations of dry milling have been described here. The general operations of dry milling include cleaning and grading, rolling or pitting, oiling, moistening, and drying and milling [29]. In India, traditional dhal milling is the most common processing method used for most of the pulses.

#### 4.4.5.2 Unit Operations

Conventional pulse milling involves many unit operations such as cleaning the raw material, size-grading, scarification of husk (pitting), oil mixing, water mixing, drying, dehulling, splitting, aspiration of husk separation of broken and splits, and finally, polishing [167].



**FIGURE 4.59** HR Paddy Husker. (From HR Paddy Husker. Stockport, England: Satake Corporation UK.)

#### 4.4.5.2.1 *Cleaning and Grading*

The basic step involved in processing of pulse products is the cleaning of the raw material. In cleaning, the main aim is to remove any foreign material, adhering soils, dust, chaff, and fungal spores that are attached to or mixed with the product. A simple cleaning unit may consist of a vibratory inclined sieve, hopper, grain collector, waste collector, and motor. The vibratory sieves are provided with different size openings to match the requirements of the type of final product being processed. Grains can be graded according to size by hand- or power-operated cleaners and graders.

Cleaning facilities also usually grade the pulse seeds, primarily based on size, color, and absence of visible damage or infection [168]. Color and size are important grading factors for certain pulses. The CGC has developed a grading instrument for assessing the color and size distribution of lentils. Modules for grading other pulses such as peas, chickpeas, and beans are under development [169].

#### 4.4.5.2.2 *Color Sorting*

Color sorting is another means of adding value to pulse seeds. The technology uses ultraviolet light to differentiate seed coat color as seeds pass through the machine. However, this advanced technology is very expensive and only a very few pulse processors in some developed countries can possess it.

#### 4.4.5.2.3 *Pitting*

An emery roller machine is used to achieve cracking and scratching of clean pulses passing through it. This leads to the facilitating of water absorption. The clearance between the emery roller and cage (housing) gradually narrows from inlet to outlet. Cracking and scratching of husk take place mainly by friction between pulses and emery as the material is passed through the narrowing clearance. Some of the pulses are dehusked and split during this operation, which are then separated by sieving. Pitting or scratching of grain legumes is done using a roller machine.

#### 4.4.5.2.4 *Pretreatment with Oil*

A screw conveyor allows passing the scratched or pitted material through it and mixing of some edible oil such as linseed oil (1.5–2.5 kg/tonne of pulses). Then they are placed on floors for about 12 h to diffuse the oil.

#### 4.4.5.2.5 *Conditioning*

Pulses are conditioned by alternate wetting and drying. Moisture (3%–5%) is added to the pulses after sun drying for a certain period and then tempering is done for about 8 h. The grain is dried in the sun again. By allowing water to drop from an overhead tank on the pulses, which are passed through a screw conveyor, an addition of moisture to the pulses is achieved. The screw is slowly rotated (50–70 rpm) to achieve proper mixing of oil–water with the grain. The length and width of the conveyors range between 1500–2500 mm and 200–300 mm, respectively [167]. Until all pulses are sufficiently conditioned the whole process of alternate wetting and drying is continued for 2–4 days. Pulses are finally dried to about 10%–12% moisture content. Mechanical hot-air-drying systems can also be used for drying of pulses.

#### 4.4.5.2.6 Dehusking and Splitting

Dehusking is a process that reduces the fiber content and improves appearance, texture, cooking quality, palatability, and digestibility of grains [170]. In one pass or single operation, about 50% of pulses are dehusked. Dehusked pulses are split into two parts. The split pulses are then separated by sieving and the husk is aspirated off. Unsplit dehusked pulses and tail pulses are again dehusked and milled in a similar way. Until the remaining pulses are dehusked and split, the whole process is repeated two or three times. Teckchandani and Mukherjee [171] have reported that recovery of dehusked splits is in the range of 68%–75% in three passes. A simple box-type aspirator with a suction fan or a cyclone-type separating system can be used. Split pulses are often used by processors in stews and soups because they cook much faster than whole pulses [168].

For splitting, various machines similar to under-runner disk shellers, attrition mills, roller machines or impact machines are used. In India, carborundum emery rollers are used for dehusking while burr grinders are used for splitting [172]. Dehusking and splitting can also be achieved in a roller machine through either simultaneous or separate operations. In separate operations, the water-treated and sun-dried seeds are split in sheller machines [32].

#### 4.4.5.2.7 Improved Dehusking Method

A hot air stream of 300°C is passed through the grains to reach a critical point, which makes seed coat brittle. Then the seeds are allowed to pass through the pulse-dehulling machine to remove the seed coat. This action is achieved by stone-coated rollers [173].

#### 4.4.5.2.8 Polishing

Polishing is done to provide luster and improve the consumer appeal, and usually a screw conveyor is used for this operation. Depending on the consumer need, different polishing materials such as water, oil, or soapstone powder are applied to the split surface [167]. Products can then be packaged for consumption.

#### 4.4.5.3 Pulse Flour Milling

Cleaned seed is ground into flour using a hammer, pin, and roller mill. Flours can be made from whole seed; dehulled whole seed; or dehulled, split seed. Consumers usually prefer dehulled pulse flour as the bitter flavor, typical of pulses, is minimized [168]. The flour is then packaged and sold to either the retail or ingredient supply market.

#### 4.4.5.4 Fractionation

A relatively new opportunity in pulse processing is specialized wet and dry milling to fractionate pulses. This method generates products that can be sold as ingredients to food processors and other industrial users [168]. With respect to legume utilization, milling of legumes and fractionation of protein and starch have increased in recent years. Milling of whole seed or dehulled seed followed by fractionation of starch- and protein-rich

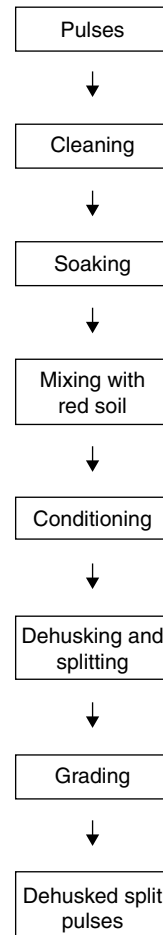
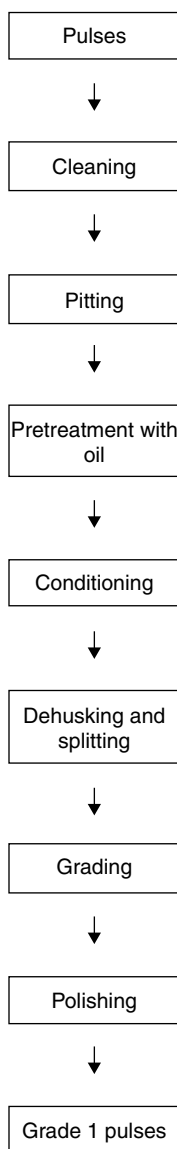


FIGURE 4.60 Flow diagram of pulse wet milling. (From Indiaagronet. Mumbai, India: Agronet Software.)



**FIGURE 4.61** Flow diagram of pulse dry milling. (From Indiaagronet. Mumbai, India: Agronet Software.)

fractions will improve utilization of legumes [174]. The air-classification technology is based on utilization of spiral air stream to differentiate fine fraction (protein) and coarse fraction (starch). In other words, the particles, which differ in density and mass, are separated in a current spiral air stream [175].

#### 4.4.5.5 Milling Machinery

The loosened seed coats of the pretreated pulses are removed in the milling operation. For this purpose, different machines are used depending upon the type of pulse and scale of operation. The machines work on principles of (a) compression, (b) shear, (c) abrasion, and (d) impact [170].

##### 4.4.5.5.1 Hammer Mill

Hammer mills are composed of hammers mounted on a rotating shaft within a peripheral screen. Grain is subjected to impact forces from the hammers until it is milled fine enough to go through the screen openings. Thus, the size of the screen openings primarily controls the fineness of the grind. However, parameters such as hammer tip speed, rotor volume, type and number of hammers, and feed rate also influence the performance of the hammer mill [176].

##### 4.4.5.5.2 Roller Mill

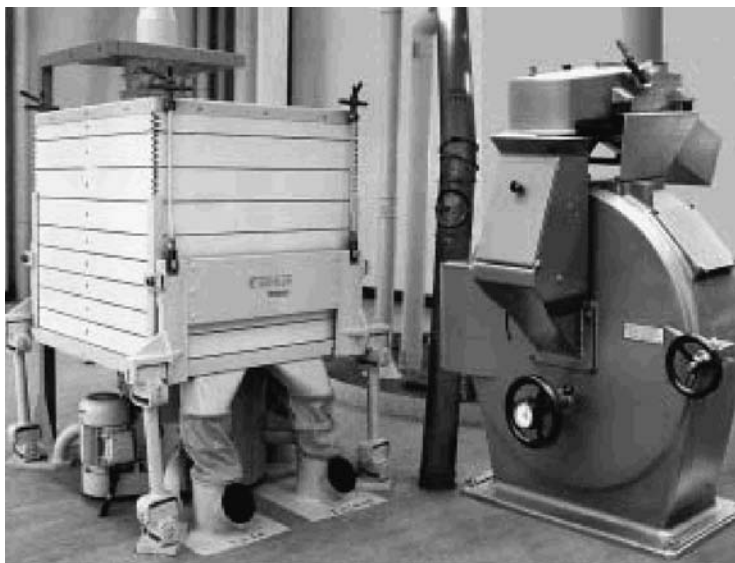
The roller mill consists of rotating corrugated or smooth paired cylindrical rolls oriented horizontally. Feed grain particles are reduced in size between the metal rolls. The grains are subjected to shear and compressive forces caused by the rolls, respectively, when particles are pulled toward the nip [177].

##### 4.4.5.5.3 Huller

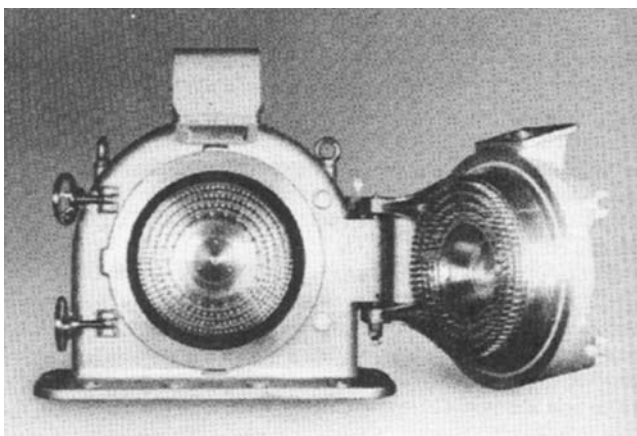
Dehulling can also be achieved by using an impact huller, where grains are fed down the hollow axle of a rapidly rotating disk. The accelerated grains collide with the wall of the huller, which is typically lined with a polymer that reduces breakage compared with a metal surface.

##### 4.4.5.5.4 Pin Mill

Impact disintegration is a kind of milling that can break up cellular materials selectively, without damaging the starch granules [178]. Traditionally, the pin mill, which is a kind of impact mill, is employed to disintegrate starch–protein bond and produce fine flour. The pin mill is also categorized as a disk mill. It employs shearing and impact forces to produce fine flour by breaking up the dehulled seed [179]. The pins in a pin mill are fixed to two disks that rotate opposite of each other at different speeds (Figure 4.63). The radial speed leads to pins pressing the material at high speed through the rows of pins. The resultant impact force grinds the material. The fineness of the final product depends on distribution and shape of pins, the circumferential speed of the rotors, the feed rate, and physical properties of the material



**FIGURE 4.62** Equipment for dehulling and splitting pulses. (From E. Goodman. *PulsePoint*, 3: 8, 2003.)



**FIGURE 4.63** Pinned disk mill. (From S. Emami et al. Determination of particle size distribution of chickpea flour granules. ASABE Paper No. 046006. St. Joseph, MI: ASABE, 2004; P.J. Fellows. *Food Processing Technology—Principles and Practice*. New York: Ellis Horwood, 1990.)

[180]. Pin mills may be used for dry or wet milling [179,180]. Moisture content below 10% (wb) is optimal for milling of legumes [181].

Some pulses may be subjected to pin milling twice for obtaining fine grade flour [173]. The pin-milled flour is air classified in a spiral air stream and fractionated into light and heavy particles. The fine and light particles contain protein, whereas the coarse and heavier particles mostly contain starch granules [32]. The starch granules remain intact during pin milling and the process must avoid damage to the starch granules. Although dry processing (air classification) does not result in as pure protein fraction as wet processing, it is an effluent-free process and separated fractions are suitable as food, food ingredient, and other uses [182]. Since some protein bodies still adhere to the starch granules at the end of pin milling, it is necessary to reprocess the coarse fraction by pin milling and air classification for increased protein yield [173].

#### 4.4.5.6 Pulse Milling

Most pulses are consumed in the dehusked split form. Recovery of dehusked splits from pulses depends on the proportion of the husk to cotyledon and the way it is attached to the cotyledons. Pulse milling, as it practiced today, is quite tedious, involving elaborate premilling treatments for loosening of the husk and also a long processing time. Traditional pulse milling methods require more abrasive force due to improper preconditioning. Conservation of pulses can be achieved mainly through the development of superior milling procedures and equipment.

---

## References

1. ECE. *Agricultural Statistics: Cereals and Cereal Products*. Economic Commission for European Nations, Geneva, United Nations, 1997.
2. N.F. Haard, S.A. Odunfa, C. Lee, R. Quintero-Ramirez. Fermented cereals: a global perspective. Service Bulletin # 138. Food and Agricultural Organization, Rome, 1999.
3. P.R. Shewry, N.G. Halford. Cereal seed storage proteins: structures, properties and role in grain utilization. *J. Exp. Bot.*, 53(370): 947–958, 2001.
4. FAO. *Food Outlook # 3*. Food and Agricultural Organization, Rome, 2004.
5. E. Rihai, H.S. Ramaswamy. Structure and composition of cereal grains and legumes. In: A. Chakraverty et al., Ed. *Handbook of Postharvest Technology—Cereals, Fruits, Vegetables, Tea and Spices*. New York: Marcel Dekker, 2003, pp. 1–16.
6. Y. Lan, C. Nguyen, O.R. Kunze. Fissures in rice kernel from moisture adsorption and desorption. *Curr. Top. Cereal Chem.*, 2: 37–47, 1999.
7. S.M.H. Saif, D.A. Suter, Y. Lan. Effect of processing conditions and environmental exposure on the tensile properties of parboiled rice. *Biosyst. Eng.*, 89(3): 321–330, 2004.
8. B.B. Simpson, M.C. Ogarzaly. *Economic Botany: Plants in Our World*. New York: McGraw-Hill, 1995.
9. S. Hegenbart. *Food Product Design: Grains*. Northbrook, IL: Weeks Publishing, 1994.
10. E.T. Champagne, D.F. Wood, B.O. Juliano, D.B. Bechtel. The rice grain and its gross composition. In: E.T. Champagne, Ed. *Rice Chemistry and Technology*, 3rd ed. St. Paul, MN: American Association of Cereal Chemists, 2004.
11. C. Patrick, A.K. Mahapatra, N. Batisani. A comparative study of threshing qualities of Phofu and other sorghum varieties released in Botswana. *Int. Agric. Eng. J.*, 9(3–4): 201–207, 2000.
12. A.K. Mahapatra, C. Patrick, P. Diau. Effect of moisture content on some physical properties of sorghum seeds. *Int. Agric. Eng. J.*, 11(1): 1–10, 2002.
13. R. Tsheko, A.K. Mahapatra. Agricultural mechanization in Botswana: better agricultural production in the new millennium. *Agric. Mech. Asia, Afr. Latin Am.*, 34(1): 42–46, 2003.
14. L.W. Rooney, F.R. Miller. Variation in the structure and kernel characteristics of sorghum. *Proceedings of the International Symposium on Sorghum Grain Quality*. ICRISAT, Patancheru, India, 1981, p. 143.
15. R.C. Hosney. *Principles of Cereal Science and Technology*, 2nd ed. St. Paul, MN: American Association of Cereal Chemists, 1998.
16. A.W. MacGregor, R.S. Bhatt. *Barley Chemistry and Technology*. St. Paul, MN: American Association of Cereal Chemists, 1993, p. 486.
17. R. Lasztity. *Cereal Chemistry*. Budapest: Akademiai Kiado, 1999, p. 308.
18. A.K. Mahapatra, R. Tsheko, K.L. Kumar, P. Chipasha. Physical energy input for maize production in Zambia. *Agric. Mech. Asia, Afr. Latin Am.*, 34(3): 57–60, 2003.
19. W. Ganbmann, K. Vorwerck. Oat milling, processing and storage. In: R.W. Welch, Ed. *The Oat Crop: Production and Utilization*. London: Chapman & Hall, 1995.
20. F.K. Gates, H. Salovaara, B.J. Dobraszczyk. The effect of processing on the mechanical properties of oat flakes. ASABE Paper No. 026027. St. Joseph, MI: ASABE, 2002.
21. R. Lasztity, A. Salgo. Quality assurance of cereals—past, present, future. *Periodica Polytechnica Ser. Chem. Eng.*, 46(1–2): 5–13, 2002.
22. Gesamtverband der Deutschen Versicherungswirtschaft. Hygroscopic foodstuffs. In: *CHB Container Handbook*. Berlin: German Insurance Association, Transport and Loss Prevention Department, 2005.
23. Nordic Rye Group. In: T. Kujala, Ed. *Rye and Health*. Nuijalantie, Finland: The Nordic Rye Group, 1994.



24. D.D. Baltensperger. Progress with proso, pearl and other millets. In: J. Janick, A. Whipkey, Eds. *Trends in New Crops and New Uses*. Alexandria, VA: ASHS Press, 2002, pp. 100–103.
25. D.J. Andrews, J.F. Rajewski, K.A. Kumar. Pearl millet: new feed grain crop. In: J. Janick, J.E. Simon, Eds. *New Crops*. New York: Wiley, 1993, pp. 198–208.
26. A. Abdelrahman, R.C. Hosene, E. Varriano-Marston. Milling process to produce low-fat grits from pearl millet. *Cereal Chem.*, 60: 189–191, 1983.
27. R.C. Hosene, J.M. Faubion. Physical properties of cereal grains. In: D.B. Sauer, Ed. *Storage of Cereal Grains and Their Products*, 4th ed. St. Paul, MN: American Association of Cereal Chemists, 1992.
28. C. Alais, G. Linden. *Food Biochemistry*. New York: Ellis Horwood, 1991, p. 222.
29. M. Amiruzzaman, M. Shahjahan. Country paper: Bangladesh. In: S. Shanmugasundaram, Ed. *Processing and Utilization of Legumes*. Tokyo: Asian Productivity Organization, 2003.
30. B.L. Mandhyan, S.K. Jain. Optimization of machine conditions for milling of pigeon peas. *J. Food Eng.*, 18: 91–96, 1993.
31. V.V. Sreenarayanan, C.T. Devadas. Status of pulse milling techniques. In: *Pulses Production Strategies in Tamil Nadu*. Coimbatore, India: Center for Plant Breeding and Genetics, Tamil Nadu Agricultural University, 2000.
32. S. Emami, L.G. Tabil. Processing of starch-rich and protein-rich fractions from chickpeas—a review. ASABE Paper No. MBSK 02-212. St. Joseph, MI: ASABE, 2002.
33. G. Leubner. *The Seed Biology Place*, 2003, <http://www.seedbiology.de/>
34. D.K. Salunkhe, S.S. Kadam, J.K. Chawan. *Post-Harvest Biotechnology of Food Legumes*. Boca Raton, FL: CRC Press, 1985, pp. 29–52.
35. N. Wang, J.K. Daun. *The Chemical Composition and Nutritive Value of Canadian Pulses*. Winnipeg: Canadian Grain Commission, 2004.
36. S. Majumdar, D.S. Jayas. Classification of cereal grains using machine vision: I. Morphology models. *Trans. ASABE*, 43(6): 1669–1675, 2000.
37. J. Paliwal, N.S. Shashidhar, D.S. Jayas. Grain kernel identification using kernel signature. *Trans. ASABE*, 42(6): 1921–1924, 1999.
38. R. Reuss. Using real-time quality measurement to maintain and increase value across the grain supply chain. In: *Proceedings of the Australian Postharvest Technology Conference*, Canberra, 2003.
39. H.D. Sapirstein, J.M. Kohler. Physical uniformity of graded railcar and vessel shipments of Canada Western Red Spring wheat determined by digital image analysis. *Can. J. Plant Sci.*, 75: 363–369, 1995.
40. X. Luo, D.S. Jayas, S.J. Symons. Identification of damaged kernels in wheat using color machine vision system. *J. Cereal Sci.*, 30: 49–59, 1999.
41. X. Luo, D.S. Jayas, T.G. Crowe, N.R. Bulley. Evaluation of light sources for machine vision. *Can. Agric. Eng.*, 39(4): 309–315, 1997.
42. S. Majumdar, D.S. Jayas. Classification of cereal grains using machine vision, III: textural models. *Trans. ASABE*, 43(6): 1681–1687, 2000.
43. I. Zayas, H. Converse, J. Steel. Discrimination of whole from broken corn kernels with image analysis. *Trans. ASABE*, 33: 1642–1646, 1990.
44. T.F. Reid, C. Kim, M.R. Paulsen. Computer vision sensing of stress cracks in corn kernels. *Trans. ASABE*, 34(5): 2236–2244, 1991.
45. M.A. Shahin, S.J. Symons. A machine vision system for grading lentils. *Can. Biosyst. Eng.*, 43(7): 7–14, 2001.
46. S. Majumdar, D.S. Jayas, J.L. Hehn, N.R. Bulley. Classification of various grains using optical properties. *Can. Agric. Eng.*, 38(2): 139–144, 1996.
47. J. Liu, M.R. Paulsen. Corn whiteness measurement and classification using machine vision. ASABE Paper No. 97-3045. St. Joseph, MI: ASABE, 1997.
48. L. Wang, S. Da-Wen. Computer vision systems for rapid quality inspection of agricultural and food products. In: ICETS2000—Session 6—Technology Innovation and Sustainable Agriculture, 2000.
49. N. Wang, F.E. Dowell, N. Zhang. Determining wheat vitreousness using image processing and a neural network. *Trans. ASABE*, 46(4): 1143–1150, 2003.
50. S.R. Delwiche, Y. Chen, W.R. Hruschka. Differentiation of hard red wheat by near-infrared analysis of bulk samples. *Cereal Chem.*, 72(3): 243–247, 1995.
51. L.W. Steenhoek, M.K. Misra, C.R. Hurburgh, Jr., C.J. Bern. Implementing a computer vision system for corn kernel damage evaluation. *Appl. Eng. Agric.*, 17(2): 235–240, 2001.

52. H.D. Sapirstein, M. Neuman, E.H. Wright, E. Shwedyk, W. Bushuk. An instrumental system for cereal grain classification using digital image analysis. *J. Cereal Sci.*, 6(1): 3–14, 1987.
53. S. Gunasekaran, T.M. Cooper, A.G. Berlage. Evaluating quality factors of corn and soybeans using a computer vision system. *Trans. ASABE*, 31(4): 1264–1271, 1988.
54. P. Shatadal, D.S. Jayas, N.R. Bulley. Digital image analysis for software separation and classification of touching grains: II. Classification. *Trans. ASABE*, 38(2): 645–649, 1995.
55. I.Y. Zayas, C.R. Martin, J.L. Steele, A. Katsevich. Wheat classification using image analysis and crush-force parameters. *Trans. ASABE*, 39(6): 2199–2204, 1996.
56. M.A. Shahin, S.J. Symons. Instrumental color and size grading of pulse grains. *Proceedings of the World Congress of Computers in Agriculture and Natural Resources*, 2002, pp. 107–113.
57. Y. Lan, Q. Fang, M.F. Kocher, A. Hanna. Detection of fissures in rice grains using imaging enhancement. *Int. J. Food Prop.*, 5(1): 205–215, 2002.
58. D. Wang, F.E. Dowell, Y. Lan, M. Pasikatan. Determining pecky rice kernels using visible and near-infrared spectroscopy. *Int. J. Food Prop.*, 5(3): 629–639, 2002.
59. F.W. Bakker-Arkema, Ed. Grains and grain quality. *CIGR Handbook of Agricultural Handbook*. St. Joseph, MI: ASABE, 1999, pp. 1–11.
60. R.A. Wachten, T.R. Blackwood. Source Assessment: Harvesting of Grains—State of the Art, EPA-600/2-79-107f. Cincinnati, OH: US Environmental Protection Agency, 1977.
61. K.R. Lochte-Watson, C.L. Weller. Wax yield of grain sorghum (*Sorghum bicolor*) as affected by mechanical harvesting, threshing and handling methods. *Appl. Eng. Agric.*, 15(1): 69–72, 1999.
62. P. Wacker. Influence of crop properties on the threshability of cereal crops. In: G.R. Quick, Ed. *Proceedings of the International Conference on Crop Harvesting and Processing*, Louisville, KY, 2003.
63. E.R. Benson, A.C. Hansen, J.F. Reid, B.L. Warman, M.A. Brand. Development of an in-field grain handling simulation in ARENA. Paper No. 023104. St. Joseph, MI: American Society of Agricultural Engineers, 2002.
64. M. Miyamoto, H. Murase. Study of threshing function of combine harvester with artificial neural network. Paper No. 033012. St. Joseph, MI: American Society of Agricultural Engineers, 2003.
65. S. Sokhansanj, S. Mani, X. Bi, A. Bickley. Dynamic simulation of McLeod harvesting system for wheat, barley and canola crops. Paper No. 048010. St. Joseph, MI: American Society of Agricultural Engineers, 2004.
66. B.S. Prentice, S. Stewart, Z. Wang. An economic assessment of the McLeod harvest. Winnipeg: Department of Agricultural Economics, University of Manitoba, 1999.
67. G. Ragan. Modeling and comparing whole crop harvesting systems. Agricultural, Food and Rural Development, Government of Alberta, 2005.
68. C.J.M. Tado, G.R. Quick. Development of pedestrian-controlled stripper harvesters for Southeast Asian ricefields. In: G.R. Quick, Ed. *Proceedings of the International Conference on Crop Harvesting and Processing*, Louisville, KY, 2003.
69. M.W. Yore, M.D. Summers, B.M. Jenkins. Development of a stubble cutting system for a combine harvester. Paper No. 011087. St. Joseph, MI: American Society of Agricultural Engineers, 2001.
70. B. Douthwaite, G.R. Quick, C.J.M. Tado. The stripper gatherer system for small-area rice harvesting. *Int. Agric. Eng. J.*, 2(4): 183–194, 1993.
71. G.R. Quick, G. Hamilton. Recent evaluations of grain harvester combinations in Australia. Paper No. 971066. St. Joseph, MI: American Society of Agricultural Engineers, 1997.
72. Y. Jiang, H. Zhang, J. Xu, C. Tu, E. Chen, J. Wang, M. Nai, B. Han. A new rice combine stripper harvester for simultaneous grain and straw harvesting. In: G.R. Quick, Ed. *Proceedings of the International Conference on Crop Harvesting and Processing*, Louisville, KY, 2003.
73. K.E. Elegbeleye, S.F. Ashaolu. Effect of stripper peripheral speeds on header losses, field capacity and field efficiency in a tractor-driven combine harvester. Paper No. 038011. St. Joseph, MI: American Society of Agricultural Engineers, 2003.
74. Y. Lan. Fissure characteristics related to moisture adsorption stresses in rice. PhD dissertation. Texas A&M, College Station, TX, 1994.
75. S. Pabis, D.S. Jayas, S. Cenkowski. *Grain Drying—Theory and Practice*. New York, NY: Wiley, 1998, p. 300.
76. S.M. Henderson. Equilibrium moisture content of small grain-hysteresis. *Trans. ASAE*, 13: 762–764, 1970.

77. L. Caddick. *Water Activity and Equilibrium Relative Humidity*. CSIRO Australia: Stored Grain Research Laboratory, 2001.
78. Cole-Parmer's FoodTechSource. Cole-Parmer Instrument Company, 2002.
79. Application note: seed longevity in storage is enhanced by controlling water activity. Decagon Devices, Inc., Pullman, WA, 2000.
80. L. Ma, D.C. Davis, L.G. Obaldo, G.V. Barbosa-Canovas. *Engineering Properties of Foods and Other Biological Materials: A Laboratory Manual*. St. Joseph, MI: American Society of Agricultural Engineers, 1998.
81. ITDG. *Drying of Foods*. International Technology Development Group Ltd., 2005.
82. R. Dracon. Enzyme activity as a function of water activity. In: D. Simato, J.L. Multon, Eds. *Properties of Water in Foods*. Dordrecht, The Netherlands: Martinus Nijhoff Publishers, 1985.
83. D.B. Fowler. *Harvesting, Grain Drying, and Storage (Winter Wheat)*. Saskatoon: Crop Development Center, University of Saskatchewan, 2002.
84. K.J. Hellevang. Grain drying. AE-701, Extension Service, North Dakota State University, Fargo, ND, 1994.
85. Midwest Plan Service. *Grain Drying, Handling, and Storage Handbook*, 2nd ed. MWPS-13, Ames, IA: Iowa State University, 1987.
86. K.J. Hellevang, W.F. Wilcke. Maintaining corn quality for wet milling. AE-1119, Extension Service, North Dakota State University, Fargo, ND, 1996.
87. K.J. Hellevang, R.V. Morey. Harvesting, drying and storage. Energy conservation and alternative energy sources for corn drying. In: *National Corn Handbook, NCH-14*. Urbana-Champaign, IL: Cooperative Extension Service, University of Illinois, 1986.
88. Sukup Airflow and Drying Rates Program. Sheffield, IA: Sukup Manufacturing, 1993.
89. Q. Liu, C.W. Cao, F.W. Bakker-Arkema. Grain drying. In: F.W. Bakker-Arkema, Ed. *CIGR Handbook of Agricultural Handbook*. St. Joseph, MI: American Society of Agricultural Engineers, 1999, pp. 20–46.
90. J.S. Silva, P.A. Berbert. Grain drying and storage in tropics. In: F.W. Bakker-Arkema, Ed. *CIGR Handbook of Agricultural Handbook*. St. Joseph, MI: American Society of Agricultural Engineers, 1999, pp. 59–68.
91. M.A. Barrozo, H.M. Henrique, D.J. Sartori, J.T. Freire. Drying of soybean seeds in a crossflow moving bed. *Can. J. Chem. Eng.* 6(77): 1121–1126, 1999.
92. D.B. Brooker, F.W. Bakker-Arkema, C.W. Hall. *Drying and Storage of Grains and Oilseeds*. New York: Van Nostrand Reinhold, 1992.
93. J.W. Fendley, T.J. Siebenmorgen, J. Manski. Laboratory simulation of commercial rice drier grain exchanger operation. Paper No. 026159. St. Joseph, MI: American Society of Agricultural Engineers, 2002.
94. G.J. Schluterman, T.J. Siebenmorgen. Air and rice property profiles within a commercial cross-flow rice dryer. *Appl. Eng. Agric.*, 20(4): 487–494, 2004.
95. G.J. Schluterman, T.J. Siebenmorgen. Temperature, relative humidity, and rice property profiles in a commercial-scale cross-flow dryer. Paper No. 026160. St. Joseph, MI: American Society of Agricultural Engineers, 2002.
96. T.W. Dorn, G.R. Bodman, D.D. Jones. *Temporary/Emergency Grain Storage Options. Cooperative Extension Educational Programs*. Nebraska: University of Nebraska-Lincoln, 1998.
97. O.J. Loewer, T.C. Bridges, R.A. Bucklin. *On Farm Drying and Storage Systems*. St. Joseph, MI: American Society of Agricultural Engineers, 1994.
98. K. Bullen. Grain storage—Basic design principles, 2005, <http://www.dpi.qld.gov.au/fieldcrops/15052.html>
99. S. Mani, P.W. Flinn, W.E. Muir, D.S. Jayas, N.D.G. White. Two models of grain temperatures and insect populations in stored wheat. *Trans. ASABE*, 44(4): 655–660, 2001.
100. D.S. Jayas. Mathematical modeling of heat, moisture, and gas transfer in stored-grain ecosystems. In: D.S. Jayas, N.D.G. White, W.E. Muir, Eds. *Stored Grain Ecosystems*. New York, NY: Marcel Dekker, 1995, pp. 527–567.
101. Agricultural Research Station of Israel. Technology and storage of agricultural products. Ministry of Agriculture and Rural Development, Bet-Dagan, 2003.
102. ASB. *Grain Storage*. Dhaka: Asiatic Society of Bangladesh, [http://banglapedia.search.com.bd/HT/G\\_0188.htm](http://banglapedia.search.com.bd/HT/G_0188.htm)

103. T.J. Herrman, C. Reed, J.P. Harner, A. Heishman. Emergency storage of grain: outdoor piling. Publication # MF-2363, Kansas State University Agricultural Experiment Station and Cooperative Extension Service, Manhattan, KS, 1998.
104. NDSU. Temporary grain storage. Report AE-84, NDSU Extension Service, North Dakota State University, Fargo, ND, 1998.
105. CRC. Agriculture and Agri-Food Canada. Winnipeg: Cereal Research Center.
106. DPIF. A guide to grain storage and drying in Queensland: underground pit storage of grain. Department of Primary Industries and Fisheries, Queensland Government, Australia, 2004, <http://www.dpi.qld.gov.au/fieldcrops/14983.html>
107. S. Rajendran. Grain storage: perspective and problems. In: A. Chakraverty, A.S. Mujumdar, G.S.V. Raghavan, H.S. Ramaswamy, Eds. *Handbook of Postharvest Technology*. New York: Marcel Dekker, 2003.
108. J.E. Montross, M.D. Montross, F.W. Bakker-Arkema. Grain storage. In: F.W. Bakker-Arkema, Ed. *CIGR Hand Book*, Vol. IV. St. Joseph, MI: American Society of Agricultural and Biological Engineers, 1999.
109. J.T. Tyson, R.E. Graves. Bulk storage fact sheets # H 75, College of Agricultural Sciences, Cooperative Extension, Pennsylvania State University, University Park, PA, 1996.
110. M.R. Paulsen, W.L. Odekirk. Guide to planning grain drying, handling, and storage systems. *Appl. Eng. Agric.*, 16(5): 513–525, 2000.
111. J.P. Harner, III, F. Fairchild. Bulk ingredient storage. Publication # MF-2039, Kansas State University Agricultural Experiment Station and Cooperative Extension Service, Manhattan, KS, 1995.
112. J.E. Bailey. Whole grain storage. In: D.B. Sauer, Ed. *Storage of Cereal Grains and Their Products*. St. Paul, MN: American Association of Cereal Chemists, 1992, pp. 157–182.
113. S. Navarro, R. Noyes, D. Armitage, D. Maier. Objectives of aeration. In: S. Navarro, R. Noyes, Eds. *The Mechanics and Physics of Modern Grain Aeration Management*. Boca Raton, FL: CRC Press, 2002, pp. 1–34.
114. L. Caddick. Regular checks reduce moisture risk in stored grain. *Farming Ahead*, 131: 35–36, 2002.
115. B.K. Bala, N.N. Sarker, M.A. Basunia, M.M. Alam. Simulation of temperature changes during storage of wheat and rough rice. *J. Stored Products Res.*, 26: 1–6, 1990.
116. M.E. Casada, F.H. Arthur, H. Akdogan. Temperature monitoring and aeration strategies for stored wheat in the Central Plains. Paper No. 026116. St. Joseph, MI: American Society of Agricultural and Biological Engineers, 2002.
117. G.H. Foster, B.A. McKenzie. Managing grain for year-round storage. Publication # AE-90, Cooperative Extension Service, Purdue University, West Lafayette, IN, 1979.
118. T.C. Bridges, M.D. Montross, S.G. McNeill. Aeration strategies and fan cost comparisons for wheat in mid-south production regions. *Appl. Eng. Agric.*, 21(1): 115–124, 2005.
119. M.D. Montross, S.G. McNeill, T.C. Bridges. Seasonal aeration rates for the eastern United States based on long-term weather pattern. *Appl. Eng. Agric.*, 20(5): 665–669, 2004.
120. D. Hilborn. Factsheet: grain aeration. Ministry of Agriculture, Food and Rural Affairs, Government of Ontario, Canada, 1984.
121. Ministry of Agriculture, Food and Rural Affairs, Government of Ontario, Canada, <http://www.omafra.gov.on.ca/english/engineer/facts/88-070.htm>.
122. RWD Taylor. Methyl bromide – is there any future for this noteworthy fumigant? *J. Stored Products Res.*, 30(4): 253–260, 1994.
123. B.H. Subramanyam, D.W. Hagstrum. Resistance measurement and management. In: B.H. Subramanyam, D.W. Hagstrum, Eds. *Integrated Management of Insects in Stored Products*. New York: Marcel Dekker, 1996, pp. 331–398.
124. T.A. Howell, Jr., J.F. Murdoch, F.H. Arthur, D.R. Gardisser. Controlled aeration during rice storage: effects of geographic location on insect survival. Paper No. 026125. ASAE, 2002.
125. R.N.C. Guedes, B.A. Dover, S. Kambhampati. Resistance to chlorpyrifos-methyl, pirimiphos-methyl, and malathion in Brazilian and U.S. populations of *Rhyzopertha dominica* (Coleoptera: Bostrichidae). *J. Econ. Entomol.*, 89: 27–32, 1996.
126. W. Quarles, P. Winn. Diatomaceous earth and stored product pests. *IPM Practitioner*, 18: 1–10, 1996.
127. Z. Korunic, P.G. Fields, M.I.P. Kovacs, J.S. Noll, O.M. Lukow, C.J. Demiank, K.J. Shibley. The effect of diatomaceous earth on grain quality. *Postharvest Biol. Technol.*, 9: 373–387, 1996.

128. F.H. Arthur. Toxicity of diatomaceous earth to red flour beetles and confused flour beetles (Coleoptera: Tenebrionidae): effects of temperature and relative humidity. *J. Econ. Entomol.*, 93(2): 526–532, 2000.
129. R.P. Ranalli, T.A. Howell, F.H. Arthur, D.R. Gardisser. Controlled ambient aeration during rice storage I: temperature and insect control. Paper No: 016112. Sacramento, CA, ASAE Annual International Meeting, 2001.
130. P.G. Fields. The control of stored-product insects and mites with extreme temperatures. *J. Stored Products Res.*, 28: 89–118, 1992.
131. N.C. Stenseth, H. Leirs, A. Skonhofs, S.A. Davis, R.P. Pech, H.P. Andreassen, G.R. Singleton, M. Lima, R.M. Machangu, R.H. Makundi, Z. Zhang, P.B. Brown, D. Shi, X. Wan. Mice and rats: the dynamics and bioeconomics of agricultural rodents pests. *Front Ecol. Environ.* 1(7): 1–12, 2003.
132. G.R. Singleton. Impacts of rodents on rice production in Asia. IRRI Discussion Paper Series No 45. Los Banos, Philippines: International Rice Research Institute, 2003.
133. H. Leirs. Management of rodents in crops: the Pied Piper and his orchestra. In: G.R. Singleton, L.A. Hinds, C.J. Krebs, D.M. Spratt, Eds. *Rats, Mice and People: Rodent Biology and Management*. Canberra, Australia: ACIAR, 2003, pp. 183–190.
134. J.E. Rodriguez. *Roedores plaga: un problema permanente en America Latina y el Caribe*. Santiago Chile: FAO, Oficina Regional para America Latina y el Caribe, 1993.
135. R. Ali, S.F. Mahdi, M.F. Khan. Estimation of rodent damage on coconut plantations and sugarcane in Sindh. *Pakistan J. Biol. Sci.*, 6(12): 1051–1053, 2003.
136. N.D.G. White. Insects, mites and insecticides in stored grain ecosystems. In: D.S. Jayas, N.D.G. White, W.E. Muir, Eds. *Stored Grain Ecosystems*. New York: Marcel Dekker, 1995, pp. 123–168.
137. A. Armentia, J. Tapias, D. Barber, J. Martin, R. de la Fuente, P. Sanchez, G. Salcedo, J. Carreira. Sensitization to the storage mite *Lepidoglyphus destructor* in wheat flour respiratory allergy. *Annals Allergy*, 68: 398–403, 1992.
138. T.A. Howell, R.R. Cogbun. Rough-rice storage. In: T. Champagne, Ed. *Rice Chemistry and Technology*, 3rd ed. St. Paul, MN: American Association of Cereal Chemists, 2004.
139. J.W. Carson, R.T. Jenkyn. Load development and structural consideration in silo design. Presented at Reliable Flow of Particulate Solids II, Oslo, 1993.
140. W.E. Muir, R.N. Sinha. Physical properties of cereal and oilseed cultivars grown in western Canada. *Can. Agric. Eng.*, 30(1): 51–55, 1988.
141. M. Rameshbabu, D.S. Jayas, W.E. Muir, N.D.G. White, J.T. Mills. Bulk and handling properties of hull-less barley. *Can. Agric. Eng.*, 38(1): 31–35, 1996.
142. Z. Ni. An expert system for analysis of grain bin loads. MS thesis, University of Manitoba, Winnipeg, 1997.
143. National Farm Building Code. Ottawa: National Research Council Canada, 1990.
144. ASAE. Loads exerted by free-flowing grain on bins. In: *ASAE Standards EP433*. St. Joseph, MI: American Society of Agricultural Engineers, 1991.
145. M. Molenda, J. Horabik, S.A. Thompson, I.J. Ross. Bin loads induced by eccentric filling and discharge of grain. *Trans. ASAE*, 45(3): 781–785, 2002.
146. ENV 1991-4. Eurocode 1: Basis of design and actions on structures. Part 4: Actions on silos and tanks. Brussels: European Committee for Standardization, 1994.
147. M. Moya, F. Ayuga, M. Guaita, P. Aguado. Mechanical properties of granular agricultural materials. *Trans. ASAE*, 45(5): 1569–1577, 2002.
148. GSI Grain Systems, Assumption, IL, 2005.
149. Hutchinson Manufacturing. Moves a world of grain the world over. In: *Hutchinson Product Catalog*. Clay Center, KS: Hutchinson Manufacturing, 1998.
150. F.F. Busta, L.B. Smith, C.M. Christenson. Microbiology of controlled atmosphere storage of grains. In: J. Shejbal, Ed. *Controlled Atmosphere Storage of Grains*. New York: Elsevier, 1980.
151. M.C. Pasikatan, G.A. Milliken, J.L. Steele, E. Haque, C.K. Spillman. Modeling the energy requirements of first-break grinding. *Trans. ASAE*, 44(6): 1737–1744, 2001.
152. R.E. Massey. Identity preserved crops. Farm Management Newsletter FM 99-1, University of Missouri, Columbia, 2002.
153. D.S. Jackson, D.L. Shandera. Corn wet milling: separation chemistry and technology. *Adv. Food Nutr. Res.*, 38: 271–300, 1995.

154. J.W. Schroeder. Corn gluten feed: composition, storage, handling, feeding and value. AS-1127, Extension Service, North Dakota State University, Fargo, ND, 1997.
155. G.S. Murthy, K.D. Rausch, M.E. Tumbleson, V. Singh, D.B. Johnston. Effect of corn endosperm hardness on different stages of dry grind corn process. Paper No. 046063. St. Joseph, MI: American Society of Agricultural Engineers, 2004.
156. B.D. Webb. Criteria of rice quality in the United States. In: B.O. Juliano, Ed. *Rice Chemistry and Technology*, 2nd ed. St. Paul, MN: AACCC, 1985.
157. T.J. Siebenmorgen, G. Qin. Relating rice kernel breaking force distributions to milling quality. *Trans. ASAE*, 48(1): 223–228, 2005.
158. International Rubber Products Exhibition Centre, Selangor, Malaysia.
159. Rubber-roll sheller S10 PR. Reinbek, Germany: FH Schule Muhlenbau GmbH.
160. National Bank of Agriculture and Rural Development, Mumbai, India.
161. HR Paddy Husker. Stockport, England: Satake Corporation UK.
162. S.M.H. Saif, Y. Lan, D.A. Sutter. Tensile properties of parboiled rice as affected by processing conditions. *Trans. ASAE*, 47(1): 191–197, 2004.
163. Y. Lan, O.R. Kunze. Fissure resistance of rice varieties. *Appl. Eng. Agric.*, 12(3): 365–368, 1996.
164. Indiaagronet. Mumbai, India: Agronet Software.
165. S. Oxman. Grain legumes: processing and storage problems. *Food Nutr. Bull.*, 1(2): 47, 1979.
166. E. Goodman. Developing processing expertise. *PulsePoint*, 3: 8, 2003.
167. H.V. Narasimha, N. Ramakrishnaiah, V.M. Pratapa. Milling of pulses. In: A Chakraverty et al., Eds. *Handbook of Postharvest Technology—Cereals, Fruits, Vegetables, Tea and Spices*. New York: Marcel Dekker, 2003.
168. CanGlobal. Market Analysis: Consumer-Ready Pulse Products. Final Report, prepared for Saskatchewan Agriculture and Food. Saskatchewan: CanGlobal Management, Inc., 2001.
169. M.A. Shahin, S.J. Symons. Instrumental color and size grading of pulse grains. ASABE Pub No. 701P0301. St. Joseph, MI: ASABE, 2002.
170. J. Singh. Post-harvest technology of legumes. In: S. Shanmugasundaram, Ed. *Processing and Utilization of Legumes*. Tokyo: Asian Productivity Organization, 2003.
171. C.K. Teckchandani, S. Mukherjee. *Survey of Pulse Milling Industries in India: Problems and Prospects*. Jabalpur, India: College of Agricultural Engineering, 1990.
172. P.H. Pandey. *Principles and Practices of Post Harvest Technology*. New Delhi: Kalayani Publishers, 1998.
173. L.G. Tabil, S. Sokhansanj, R.T. Tyler. Processing of pulses. In: *Proceeding of the Pulse Cleaning and Processing Workshop*. Saskatoon, SK: Agricultural and Bioresources Engineering and the Extension Division, University of Saskatchewan, 1995.
174. S. Emami, L.G. Tabil. Physicochemical characteristics of pin-milled and turbo-milled chickpeas. ASABE Paper No. 036142. St. Joseph, MI: ASABE, 2003.
175. R.D. Reichert. Air classification of peas (*Pisum sativum*) varying widely in protein content. *J. Food Sci.*, 47: 1263–1267, 1982.
176. M. Hauhouot-O'Hara, J.B. Solie, R.W. Whitney, T.F. Peeper, G.H. Brusewitz. Effect of hammer mill and roller mill variables on cheat seed germination. *Appl. Eng. Agric.*, 12(2): 139–145, 1999.
177. E. Haque. Three-roll cereal mill using triangular roll configuration. *Trans. ASABE*, 34(5): 2104–2109, 1991.
178. S. Emami, L.G. Tabil, T. Pugsley. Determination of particle size distribution of chickpea flour granules. ASABE Paper No. 046006. St. Joseph, MI: ASABE, 2004.
179. P.J. Fellows. *Food Processing Technology—Principles and Practice*. New York: Ellis Horwood, 1990.
180. B. Caballero, L.C. Trugo, P.M. Finglas. *Encyclopedia of Food Science and Nutrition*. New York: Academic Press, 2003.
181. J. Han, K. Khan. Physicochemical studies of pin-milled and air-classified dry edible bean fractions. *Cereal Chem.*, 67(4): 384–390, 1990.
182. Y.J. Owusu-Ansah, S.M. McCurdy. Pea proteins: a review of chemistry technology of production, and utilization. *Food Rev. Int.*, 7: 103–134, 1991.



# 5

## *Minimal Processing of Fruits and Vegetables*

Conrad O. Perera

### CONTENTS

5.1	Introduction.....	137
5.1.1	What Is Minimal Processing?.....	137
5.2	Physiological Responses and Biochemical Changes .....	138
5.2.1	Ethylene .....	138
5.2.2	Respiration .....	139
5.2.3	Oxidative Browning .....	140
5.2.4	Nutrient Losses: Ascorbic Acid Oxidation .....	140
5.2.5	Water Loss .....	141
5.2.6	Leaf Yellowing in Vegetables .....	141
5.3	Techniques to Extend the Shelf Life .....	142
5.3.1	Sanitation .....	142
5.3.2	1-Methylcyclopropene .....	144
5.3.3	Edible Coating .....	145
5.4	Conclusion .....	146
	References .....	147

### 5.1 Introduction

#### 5.1.1 What Is Minimal Processing?

In recent years, there has been a considerable increase in the demand for high-quality fruits and vegetables, coupled with convenience and safety. High quality usually implies fresh-like quality characteristics of flavor, texture, color, aroma, and overall appearance, and consumers are indicating a strong preference to these fruits and vegetables over their counterparts [1]. Furthermore, changes in consumer lifestyles seem to have led to an increased desire for ready-to-eat or ready-to-use products. Therefore, interest in a new area of food preservation is being promoted, i.e., minimally or lightly processed products. Other terms used to refer to minimally processed products are lightly processed, partially processed, fresh processed, fresh-cut, and preprepared. Minimally processed products are important to food service industry such as restaurants and catering companies as they offer many advantages over traditional products, with respect to convenience, expense, labor, and hygiene. Despite its popularity, the production of minimal processed products is limited due to rapid deterioration and senescence (natural aging leading to death of the tissue). Hence, minimally processed foods are more perishable than its unprocessed raw materials [1].

Minimal processing of fruits and vegetables generally involves washing, peeling, slicing, or shredding before packaging and storage at low temperature. All these steps have an effect on the nutrients, shelf life, and quality of the prepared product [2,3]. Examples of these products already on the market include packaged shredded lettuce/cabbage/carrots, cut fruit and vegetable salads, and peeled/sliced potatoes/carrots, broccoli, and cauliflower florets [4,5].

Minimal processing of raw fruits and vegetables has two purposes. First, it is important to keep the product fresh, but convenient without losing its nutritional quality. Second, the product should have a



shelf life sufficient enough to make distribution feasible within the region of consumption. The microbiological, sensory, and nutritional shelf life of minimally processed vegetables or fruits should be at least 4–7 days, but preferably even longer [6].

---

## 5.2 Physiological Responses and Biochemical Changes

Vegetables and fruits are living organisms that continue to change after harvest. Plant tissues incur damage during processing and in addition remain raw and living after processing. The physiology of minimally processed fruits and vegetables is essentially the physiology of wounded tissue. This type of processing, involving abrasion, peeling, slicing, chopping, or shredding, differs from traditional thermal processing in that the tissue remains viable (or “fresh”) during subsequently handling. Thus, the behavior of the tissue is generally typical of that observed in plant tissues that have been wounded or exposed to stress conditions [7].

Within minutes of undergoing minimal processing of fresh produce, the rate of respiration and ethylene production markedly increase [7], and essentially a “wound response” is initiated. Both respiration and ethylene production will result in shorter shelf life of the product. The ethylene will accelerate ripening, softening, and senescence [8], which leads to membrane damage, while the respiration will use up energy reserves. Other consequences of wounding are chemical and physical in nature, such as oxidative browning reactions and lipid oxidation or enhanced water loss [7].

Injury stresses caused by minimal processing result in mechanical rupture of tissues and cellular compartmentation leading to delocalization and intermixing of enzymes and substrates. One such enzyme system is the ascorbic acid oxidase that oxidizes ascorbic acid to dehydroascorbic acid, which can then further degrade to other compounds leading to browning. Thus nutritional quality such as vitamin C is lost [9]. Therefore, wound-induced physiological and biochemical changes take place more rapidly than in intact raw commodities, and microbial proliferation may be accelerated.

There is little information about the physiology and chemistry affecting minimal processing of tropical fruit and vegetable products. Such information is vital for the extension of both the fresh and minimally processed products. Novel ethylene receptor inhibitors such as 1-methylcyclopropene (1-MCP) that retard  $C_2H_4$  biosynthesis have been tested on temperate fruits to extend the shelf life.

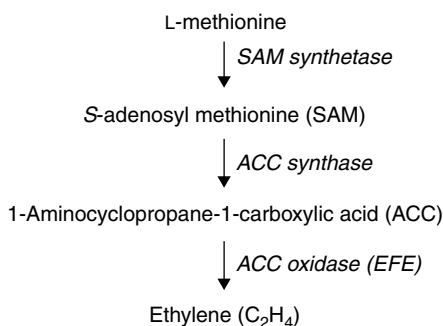
### 5.2.1 Ethylene

Ethylene is a naturally occurring plant growth hormone that has numerous effects on the growth, development, and storage life of many fruits and vegetables, and ornamental crops at very low concentrations ( $\mu\text{L/L}$ ) [10]. It is produced by virtually all parts of the higher plants, including leaves, roots, flowers, fruits, tubers, and also seedlings.

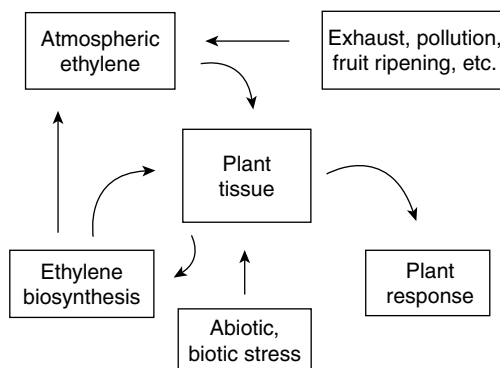
The pathway of ethylene biosynthesis elucidated by Adam and Young [11] is now well documented, and in both wounding and ripening, the pathway is the same. Methionine is first converted to *S*-adenosyl methionine (SAM), which then gives rise to 1-aminocyclopropene-1-carboxylate (ACC), catalyzed by ACC synthase. The final step is catalyzed by ACC oxidase (also known as the ethylene-forming enzyme), in which ACC is converted to ethylene. In most plant tissues, the level of active ACC synthase determines the rate of ethylene production; however, the mechanism(s) underlying the regulation of ACC synthase gene(s) during plant development is unknown. Both ACC synthase and ACC oxidase transcript levels greatly increase due to ripening and wounding [10]. The biosynthesis pathway is illustrated in Figure 5.1.

Harvested fruits and vegetables may be intentionally or unintentionally exposed to biologically active levels of ethylene, and both endogenous and exogenous sources of ethylene contribute to its biological activity [10]. Figure 5.2 is a schematic diagram showing the ethylene interactions between plants and their environment. Endogenous sources of ethylene are internal synthesis within plants and fruits, and exogenous sources are from external sources such as engine exhaust, heaters, or ripening fruits. Ethylene production is promoted by stresses such as chilling injury [12] and wounding [13], and this stress-induced  $C_2H_4$  can enhance fruit ripening.

Cell wall enzymes such as exo- and endo-polygalacturonase,  $\beta$ -galactosidase, and pecti methylesterase, induced by ethylene can digest cell walls, resulting in texture changes [4], and lipoxygenase can degrade membrane lipids [14].



**FIGURE 5.1** Simplified diagram of ethylene production in higher plants. (Adapted from Adams, D.O., and Young, S.F., 1979. *Proc. Natl. Acad. Sci., USA*, 76: 170–174.)



**FIGURE 5.2** Ethylene interactions with the plant and its environment. (Adapted from Saltveit, M., 1999. *Postharvest Biol. Technol.*, 15: 279–292.)

**TABLE 5.1**

**Beneficial Effects of Ethylene on the Quality of Fresh Fruits and Vegetables**

- Promotes color development in fruits
- Stimulates ripening of climacteric fruits
- Promotes de-greening of citrus
- Stimulates dehiscence in nuts
- Alters sex expression in Cucurbitaceae
- Promotes flowering in Bromeliaceae (e.g., pineapple)
- Reduces lodging of cereals by inhibiting stem elongation

Source: Saltveit, M., 1999. *Postharvest Biol. Technol.*, 15: 279–292.

ing of green stem and leafy vegetables [10]. Ethylene from either endogenous production or exogenous applications stimulates chlorophyll loss and the yellowing of harvested broccoli florets [15]. Russet spotting (RS) is a postharvest disorder of lettuce in which small brown sunken lesions appear on the leaf. It is caused by the exposure to hormonal levels of  $C_2H_4$  at storage temperature of around  $5^\circ C$  [16]. Many biotic and abiotic stresses stimulate phenylpropanoid metabolism and the accumulation of phenolic compounds in lettuce [17]. However, even though the level of phenolic compounds is elevated in stressed lettuce, ethylene is still essential for the browning reaction, which is characteristic of RS to occur [18]. The firmness of many ripening fruits and vegetables decreases with  $C_2H_4$  treatment. This is usually beneficial when associated with ripening (e.g., bananas, tomatoes), but if applied for too long, ripening can progress into senescence and the flesh can become too soft. The crisp texture of cucumbers and peppers is lost upon exposure to  $C_2H_4$  [10].

The beneficial effects of  $C_2H_4$  are realized by its application to growing plants in the field and orchards, plants in the greenhouse, and harvested commodities [10]. Table 5.1 illustrates some of the beneficial effects of ethylene on the quality of fresh fruits and vegetables.

## 5.2.2 Respiration

Fruits and vegetables are living organs of plants that undergo biological and biochemical activity even after they are separated from their plants. Respiration is a sequence of reactions whereby sugars and other substrates, for example, organic acids, are oxidized to carbon dioxide and water vapor, and energy is released [19]. The released energy is utilized to synthesize compounds such as proteins and carbohydrates, which together constitute the tissues of the plant. In general, respiration converts the stored energy into usable energy to sustain life. However, harvested or fresh-cut products detached from the plants have

Wounding plant tissues induces elevated ethylene production rates, sometimes within a few minutes, but usually within 1h, with peaks usually within 6–12h [13]. Ethylene produced by the physical action of minimal processing was found sufficient to accelerate softening of banana and kiwifruit, and chlorophyll loss in spinach [9]. Ethylene level increases in proportion to the amount of wounding in several fruits and vegetables [7]. Levels of ACC and ACC synthase activity increase the ethylene in tomato, winter squash, and cantaloupe muskmelon [13].

There are various detrimental effects of ethylene on fruits and vegetables. It can cause yellow-

a limited energy supply. Basically, the rate of deterioration of harvested products is proportional to their rate of respiration. Hence, the higher the rate of respiration, the shorter is the shelf life [5,20].

The respiration rate of peeled and sliced ripe kiwifruit is double of the whole fruit, but ripe bananas were unaffected by peeling and slicing [21]. Wound respiration in some plant tissues may be related to alpha-oxidation of fatty acids [22], which oxidizes fatty acids to CO<sub>2</sub>, and is responsible for the CO<sub>2</sub> released after slicing of potato tubers [20].

Respiration in plants is an oxidative degradation of sugars, organic acids, and lipids to produce carbon dioxide and water with the release of energy. Modifying the atmosphere around the product by lowering the amount of oxygen with an increase in the amount of carbon dioxide may lower the metabolism with decrease in CO<sub>2</sub> production and O<sub>2</sub> consumption. The effects of low O<sub>2</sub> and high CO<sub>2</sub> are additive, but the optimal concentrations of the two gases in the storage atmosphere of fruits and vegetables and even between cultivars of the same species may vary [23]. Owing to the high affinity for O<sub>2</sub> of the terminal oxidase enzymes in the electron transport chain located in the mitochondria, the amount of O<sub>2</sub> in the surrounding air must be reduced to below 10%. On the other hand, a change to anaerobic respiration will take place if the O<sub>2</sub> concentration approaches 2% [24]. Although high CO<sub>2</sub> and low O<sub>2</sub> levels in the microatmosphere of fresh products may extend their shelf life, off-flavor and off-odor developments may be caused by anaerobic respiration [25].

### 5.2.3 Oxidative Browning

Discoloration occurs at the cut surface of fruits and vegetables as a result of the disruption of compartmentation that occurs when cells are broken, allowing substrates and oxidase enzymes to come in contact with each other [7]. Wounding also induces synthesis of some enzymes involved in browning reactions or biosynthesis of their substrates [20]. Thus, browning intensity in diverse tissues and crops can be affected by relative oxidase activities and substrate concentrations [26]. Oxidative browning at the cut surface is the limiting factor in storage of many minimally processed fruits and vegetables [7].

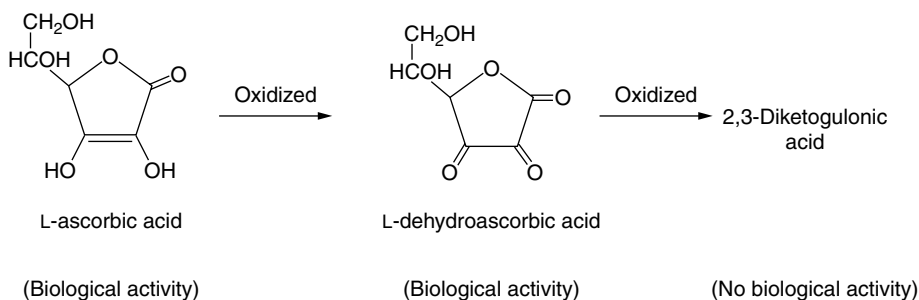
Phenylalanineammonialyase (PAL) is a key enzyme in the synthesis of phenolic compounds. Activity of PAL is increased in lettuce midrib tissue with wounding and storage in the presence or absence of ethylene [27]. PAL catalyzes the first reaction in the biosynthesis of plant phenylpropanoid products. The phenolic compounds can then be oxidized by polyphenoloxidase (PPO), producing brown polymers that can contribute to tissue browning in lettuce [28].

When fruits such as apples and bananas are cut, the cut surfaces usually turn brown within an hour. On the other hand, it takes several hours for the section of cut or shredded vegetables such as lettuce to turn brown. This time lag is considered to be due to the *de novo* biosynthesis of polyphenols [29]. The lettuce tissues with the highest susceptibility to enzymatic browning are the “white” tissue or the so-called midribs. This browning is a major problem that arises during minimal processing and further storage of lettuce midribs [30–32]. Russet spotting of lettuce is characterized by the appearance of small, reddish-brown spots or lesions on the midribs of the leaves [33].

Ethylene increases the activities of PAL, peroxidase (POD), and PPO. Hence, there is a correlation between PAL activity and development of RS in ethylene-treated lettuce midribs. Hyodo et al. [34] found a significant increase in some phenolic compounds such as chlorogenic and isochlorogenic acids in the RS-affected tissue. Increased PAL activity promotes synthesis of cinnamic acid and their derivatives via the shikimic acid pathway. These compounds are then available for lignin synthesis. Ethylene-induced POD activity is correlated with increased lignin formation and cell wall thickening, one of the characteristics of RS. Flavonoids and chlorogenic acid, the other products of the shikimic acid pathway, are oxidized by PPO to form brown compounds [35].

### 5.2.4 Nutrient Losses: Ascorbic Acid Oxidation

Vegetables and fruits, either processed or “fresh,” are major sources of dietary vitamin C for humans. Before fruits and vegetables are consumed, they have to undergo various handling, storage, and processing steps. The vitamin C content of sliced, cut, or bruised fruits and vegetables may diminish rapidly depending on these handling, processing, and storage conditions used.



**FIGURE 5.3** Oxidation of ascorbic acid.

Ascorbic acid is an organic acid found in fruits and vegetables. It is very soluble in water and is sensitive to alkali; oxygen; and presence of copper, iron, and heat. Ascorbic acid is often considered to be equivalent to vitamin C content; however, dehydroascorbic acid (DHAA), the oxidized form of ascorbic acid, also has vitamin C activity [3,36]. Further oxidation of DHAA converts it to 2,3-diketogulonic acid, which is devoid of biological activity [37]. Figure 5.3 illustrates the oxidation process of ascorbic acid. The loss of ascorbic acid provides a useful index of oxidative deterioration in minimally processed fruits and vegetables [3].

There are two aspects of ascorbic acid degradation. First, ascorbic acid can be oxidized due to mechanical damage as a result of cutting. When cells of fresh product are ruptured as occurs during cutting, chemical reactions are initiated, which shorten the storage life of cut product. The enzyme, ascorbic acid oxidase, released when the cell walls are damaged, will oxidize the ascorbic acid to DHAA, which can undergo further degradation to produce products that no longer possess vitamin C activity [38]. Undergoing treatment such as minimal processing can trigger such chemical reactions. Second, ascorbic acid can be oxidized due to the physiological activity that shortens storage life. The auto-oxidation rate of ascorbic acid to DHAA by air is influenced by metal ion concentration and pH. The rate increases in alkaline medium, while acetic acid restrains the influence of  $\text{Fe}^{3+}$  [39,40]. Albrecht [41] reported that the whole lettuce lost ascorbic acid during storage.

Ku and Wills [42] reported that 1-MCP can delay senescence of broccoli. Agar et al. [43] also reported that removal of  $\text{C}_2\text{H}_4$  from the storage atmosphere increased retention of total ascorbic acid in kiwifruit. Tay and Perera [32] found that 1-MCP was effective in reducing the loss of ascorbic acid in lettuce.

### 5.2.5 Water Loss

Plant tissues are in equilibrium with an atmosphere at the same temperature with an RH of 99%–99.5% [44]. Water loss will occur when there is reduction of water vapor pressure in the atmosphere surrounding the tissue. In the whole fruit or vegetable, water in intercellular spaces is not directly exposed to the outside atmosphere. However, cutting or peeling a fruit or a vegetable exposes interior tissues and drastically increases the water evaporation rate [7].

To subsequently maintain the lowest possible water vapor pressure deficit, minimally processed products are routinely handled in semipermeable film packages with low water vapor transmission rates. Condensation within the package is most severe when the product is at a higher temperature than that of the storage atmosphere, which is often the case when the product is first placed in the cold storage room or transport vehicle [7].

### 5.2.6 Leaf Yellowing in Vegetables

Leaf yellowing is a particularly important quality problem during transport and storage of fresh or minimally processed green leafy vegetable products. Over the storage period, the leaves become wrinkled, yellowed, and softened. The decrease in green pigmentation would probably result from the loss of chlorophyll during storage [45]. Tay and Perera [32] found that 1-MCP was effective in retarding storage-induced leaf yellowing in lettuce.

### 5.3 Techniques to Extend the Shelf Life

Various approaches have been used to control the undesirable physiological changes that adversely affect the quality of minimally processed products. Refrigeration, humidity control, and dipping in chemical solutions such as ascorbic acid and calcium have been used successfully to preserve product quality and enhance shelf life. Izumi and Watada [46] reported that exogenous treatments with calcium chloride ( $\text{CaCl}_2$ ) dip reduced browning and retarded flesh softening of vegetables. However,  $\text{CaCl}_2$  may also cause detectable off-flavors when used at levels higher than 0.5% [47].

Minimally processed products should be refrigerated ( $0^\circ\text{C}$ – $5^\circ\text{C}$ ) to prolong their quality and safety [48]. Removal of  $\text{C}_2\text{H}_4$  from the storage environment of minimally processed fruits and vegetables can retard tissue softening [9]. Desirable modified atmospheres can be predicted and created within and around commodities by selecting appropriate packaging. Controlled atmospheres can reduce the effects of  $\text{C}_2\text{H}_4$  on fruit tissues and retard senescence, delay softening, and help to extend the postharvest life [43]. Edible coatings and films have been used successfully with some commodities to provide useful barriers to moisture,  $\text{O}_2$ , and  $\text{CO}_2$ , while improving package recyclability [5,32].

#### 5.3.1 Sanitation

Sanitation is an integral part of minimal processing. Minimally processed fruits and vegetables are essentially damaged tissues. The chances of food pathogens or spoilage organisms growing in these products are very high. There are three factors that are necessary for foodborne illnesses, namely, the host, pathogen, and exposure [49]. There are no absolute guarantees of the absence of all pathogens by the current processing methods and technologies. However, a reduction in one or more of the three factors will have a substantial effect in reducing the chances of foodborne illnesses.

Considering the growing increase in the consumption of minimally processed and fresh fruits and vegetables in the United States, the Food and Drug Administration (FDA) set out clear guidelines to minimize microbial food safety hazards for fresh fruits and vegetables in 1998 [50]. These guidelines span from “farm to fork” and include good agricultural practices (GAP), good manufacturing practices (GMP), and hazard analysis critical control points (HACCP).

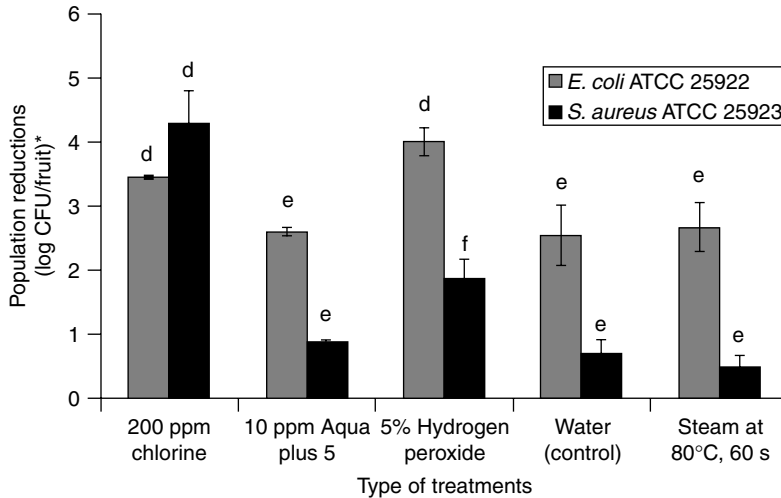
Sanitization is unlikely to totally eliminate all pathogens on the produce. Therefore, it is important to use sanitizing protocols that are efficient. Efficacy of the sanitizers used to reduce microbial populations is usually dependent upon the type of treatment, type and physiology of the target microorganisms, characteristics of produce surfaces (cracks, crevices, texture, hydrophobic tendency), exposure time and concentration of sanitizer, pH, and temperature [51]. Numerous studies have been conducted to evaluate the efficacy and effectiveness of sanitizing treatment on different produce. Researchers have looked into treatments with the use of different sanitizers such as chlorine [52–54], chlorine dioxide [55–57], hydrogen peroxide [58], and heat [59,60] as ways to sanitize whole and fresh-cut fruits. Most of the research was conducted using fruits such as apples, oranges, strawberries, and tomatoes, and very little information is available on tropical fruits.

Working with tropical fruits, Perera and Kiang [61] showed that the efficacy of sanitization treatments depends on the type of produce and characteristics of produce surfaces. The efficacy of sanitizer treatments on guava, star fruit, and pineapple is shown in Figures 5.4 through 5.6.

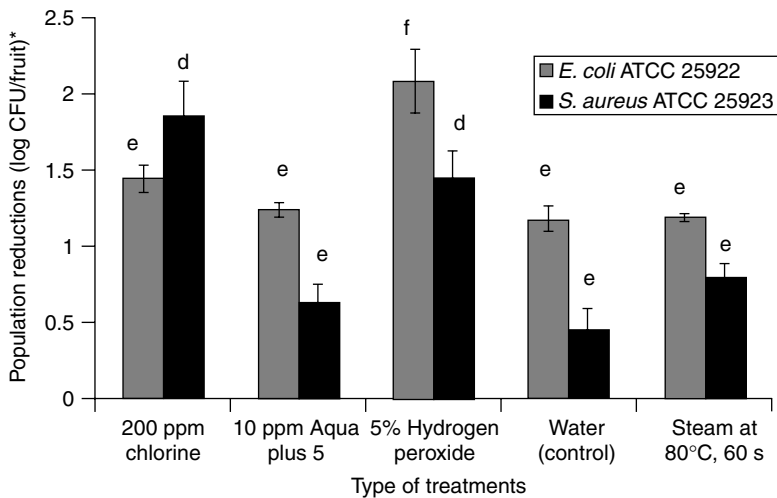
Research has demonstrated that an increase in microbial populations on minimally processed product will have an adverse impact on shelf life [62]. The higher the initial microbial load, the shorter the storage life [63]. While psychrotropic Gram-negative rods are the predominant microorganisms on minimally processed products [64], the primary spoilage organism on prepackaged salads appears to be the fluorescent pectinolytic pseudomonads [65].

Washing of fresh fruits and vegetables before cutting is important to control microbial loads that include mesophilic microflora, lactic acid bacteria, coliforms, fecal coliforms, yeasts, molds, and pectinolytic microflora [5,66]. Minimally processed products are generally rinsed in 50–200 ppm chlorine or 5 ppm of chlorine dioxide, which may also aid in reducing the browning reactions [5,67]. However, product safety, not shelf life, is the critical sanitation issue in minimally processed fruits and vegetables [62].

Chlorination is the primary form of sanitation. Most processors use a concentrated form of liquid bleach (sodium hypochlorite), although solid calcium hypochlorite or chlorine gas may also be used [62].



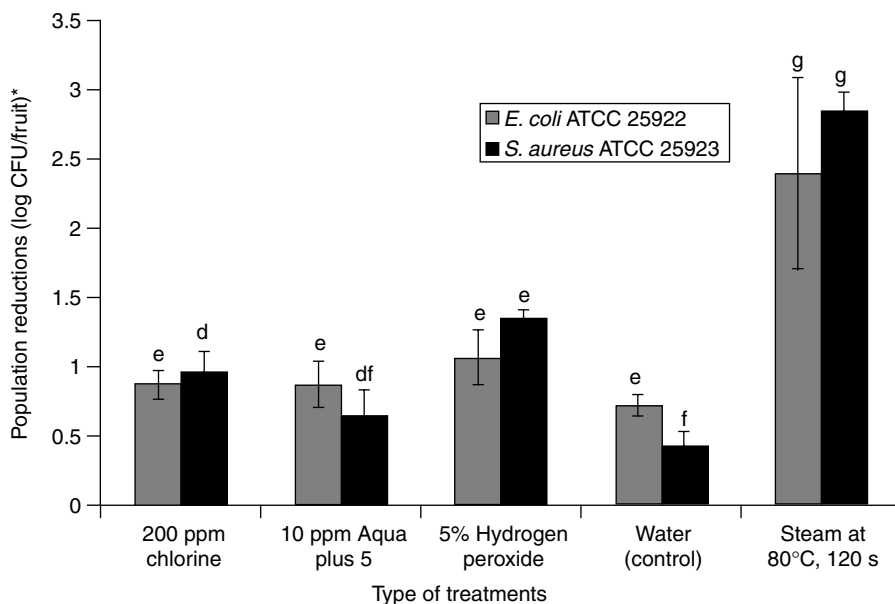
**FIGURE 5.4** Comparison of various treatments in reducing inoculated *Escherichia coli* ATCC 25922 and *Staphylococcus aureus* ATCC 25923 from surface of star fruit. (From Perera, C.O., and Kiang, K.H., 2003. *Proceedings of the International Food Safety Conference*. March 24–26, Muscat, Oman. Vol. 3. pp. 1–5.)



**FIGURE 5.5** Comparison of various treatments in reducing inoculated *E. coli* ATCC 25922 and *S. aureus* ATCC 25923 from surface of guava. (From Perera, C.O., and Kiang, K.H., 2003. *Proceedings of the International Food Safety Conference*. March 24–26, Muscat, Oman. Vol. 3. pp. 1–5.)

However, chlorine gas is difficult to handle, and solid granules of calcium hypochlorite need to be dissolved, which will require additional labor. Free chlorine is an excellent disinfectant; as little as 1 ppm free residual chlorine will sanitize cold process water at a pH 6.5–7.0 [68]. Water pH has a significant impact on chlorine activity. Higher chlorine levels may cause irritation in workers' lungs and skin, and product discolorations, increase equipment corrosion, and form volatile chloramines that may cause health hazards [62]. Also, chlorination of some organics such as phenols not only results in toxic end products such as chlorophenols but can also impart undesirable tastes and odors to the product treated.

There are other methods of sanitation such as the use of ozone and ultraviolet radiation. Ozone has strong oxidizing power and is capable of inactivating microorganisms effectively. To date, there are no indications of adverse human health or environment effects of water ozonization [62]. However, at moderate concentrations, browning reactions may be enhanced in minimally processed products.



**FIGURE 5.6** Comparison of various treatments in reducing inoculated *E. coli* ATCC 25922 and *S. aureus* ATCC 25923 from surface of pineapples. (From Perera, C.O., and Kiang, K.H., 2003. *Proceedings of the International Food Safety Conference*. March 24–26, Muscat, Oman. Vol. 3. pp. 1–5.)

Chlorine dioxide-based sanitizer (Aqua-Plus 5) has strong oxidizing properties and is efficient in killing microorganisms. Owing to its true oxidizing characteristics, there is no residue to affect the quality of the food. It is nontoxic, less corrosive, and pH-independent. Unlike chlorine, it does not combine with organic compounds to form toxic chlorinated compounds and does not react with ammonia. The product formulation comprises biodegradable compounds that break down after the use to form natural substances. It is approved for use in food by the U.S. Environmental Protection Agency (EPA) [69].



1-Methylcyclopropene

**FIGURE 5.7** Structure of 1-MCP.

### 5.3.2 1-Methylcyclopropene

1-MCP is currently formulated as SmartFresh™, a 0.14% powder for postharvest use in fruits and vegetables, and EthylBloc™ for the use in flowers. SmartFresh liberates the active 1-MCP when added to water and is stable in its powder form. The chemical structure of 1-MCP is shown in Figure 5.7.

Acute toxicity, mutagenicity, and product chemistry studies conducted on the SmartFresh formulation indicate a favorable toxicology profile. In addition, 1-MCP has a nontoxic mode of action, is applied at extremely low parts per billion dose levels, and has no exception of measurable residues in food commodities. The EPA has classified 1-MCP as a plant regulator structurally related to plant-containing materials. The EPA registration was granted in flowers in April 1999. In 2003, it was approved for use in apples.

1-MCP is a cyclic olefin, analogous to the photodecomposition product of DACP [70], and to date, is the most useful compound among recently developed inhibitors of ethylene response. 1-MCP is a gas at room temperature, has no obvious odor at required concentration levels, and is nontoxic. It is relatively stable in dilute gas phase for several months [71], but is unstable in the liquid phase, polymerizing even at low refrigerator temperature [72].

Autocatalytic ethylene production requires up-regulation, by ethylene, of ACC synthase and ACC oxidase activity [73]. Lelievre et al. [74] demonstrated that treatment with 1-MCP resulted in reduced accumulation of ACC synthase/oxidase transcripts and ethylene production in pears, during chilling. Presumably, 1-MCP competitively binds to a metal in the ethylene receptors involved in feedback

regulation and consequently blocks the ability of ethylene to up-regulate. However, in the case of wounding whereby ethylene production is not autocatalytic, another mechanism must operate for 1-MCP to reduce ethylene synthesis. 1-MCP is capable of allene-type arrangement, which probably is a crucial factor when binding occurs [75]. Once 1-MCP is bound to the ethylene receptor, ethylene binding is impossible; therefore it fails to elicit its subsequent actions on the tissue.

1-MCP provides protection for a longer period of time than other potential ethylene inhibitor compounds [75]. It acts at concentrations of 0.5nL/L and the effect is prolonged. 1-MCP has been reported to delay or reduce ethylene-induced effects on senescence in a variety of potted flowering plants and cut flowers [76–78]. Effects of 1-MCP on fruits and vegetables include inhibiting the ripening of tomatoes [72,79], delaying senescence of strawberries [80] and broccoli [42], inhibiting the yellowing of cut lettuce [32], extending the firmness and shelf life of minimally processed apples [81], and de-greening of oranges while not suppressing other ethylene-induced effects such as chilling injury [82]. Also, after treatment, tomatoes, bananas, and other plant materials were found to have no response even to very high amounts of ethylene [72].

1-MCP reduces ethylene synthesis and respiration rate and thus decreases the activities of PAL [35], which is a key enzyme in phenolic synthesis. The phenolic compounds can then be oxidized by polyphenoloxidase (PPO) producing brown polymers that can contribute to tissue browning in lettuce [28]. Fan and Mattheis [35] reported that short-term 1-MCP treatment prevents the development of RS and isocoumarin accumulation in iceberg lettuce. 1-MCP-treated lettuce also had lowered levels of RS [32]. This indicates that ethylene is important for the development of RS in lettuce.

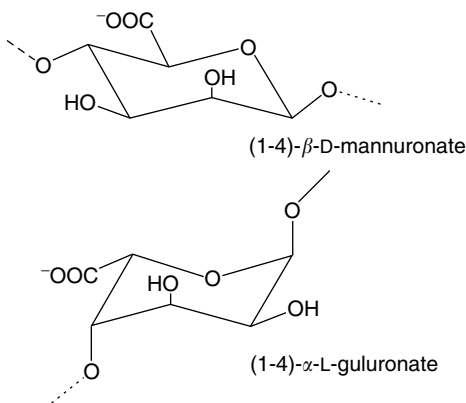
### 5.3.3 Edible Coating

Coatings of fruits and vegetables have been known for many years [83]. Edible coatings are generally made from one or more of four major types of materials: lipids, resins, polysaccharides, and proteins [84]. Coatings made from polysaccharides (cellulose, pectin, starch, alginates, chitosan, carrageenan, gums, etc.) are generally good barriers and adhere well to cut surfaces of fruits or vegetables, but their hydrophilic nature makes them poor barriers to moisture [32,85].

Almost all minimally processed fruits have all or part of the peel or outer protective coating removed. This allows entrance of spoilage organisms and dehydration of the fruit tissues. Dehydration may be partially responsible for some of the softening that is observed in minimally processed fruit products. Use of edible coating or plastic packaging is necessary to retard moisture loss by providing a barrier to water vapor resulting in a relatively high humid environment as well as minimize microbial contamination [5,48,84].

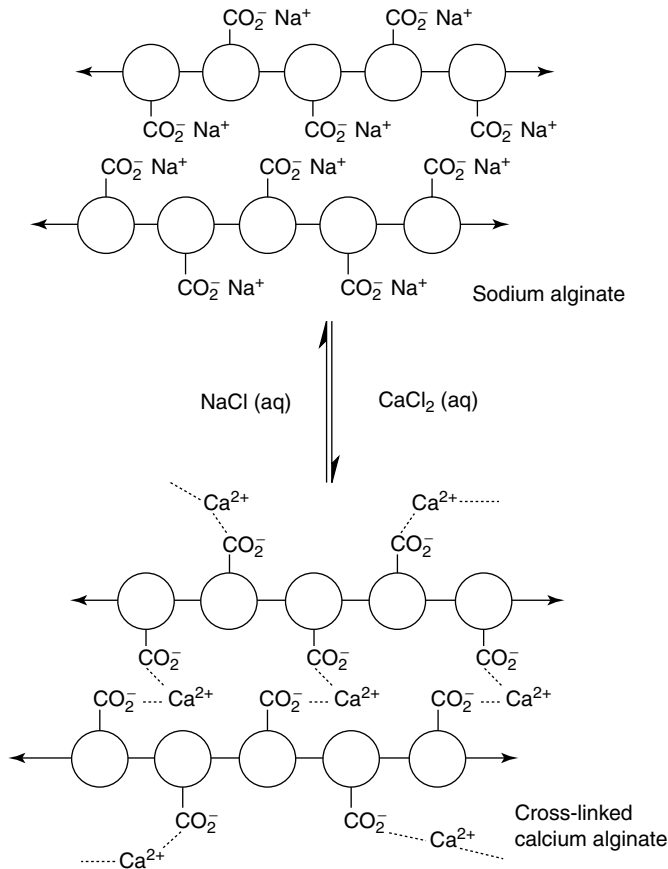
Attempts have been made to control leakage from minimally processed (peeled) grapefruit segments with edible coating of calcium alginate, with varying levels of coating firmness. The coatings effectively enhanced firmness of segments, but the effects on fluid loss were negligible. An 89% increase in tissue firmness was accompanied by only 16% decrease in fluid loss [86].

Alginate is a group of naturally occurring polysaccharide ( $M_r \sim 240,000$ ) isolated from brown seaweed composed of D-mannuronic acid and L-guluronic acid subunits [87]. Figure 5.8 shows the alginate monomer unit. It is a nontoxic and biodegradable polymer that can be used in food [88]. Sodium alginate and polypropylene glycol alginate are commonly used as thickeners in foods such as ice cream and fruit-filled snacks [89]. Alginates form gels with a number of divalent cations [90]. For food purposes, calcium is particularly suitable because of its non-toxicity. Borax can be used to produce gels for non-food applications [91]. Figure 5.9 illustrates water-soluble sodium alginate polymer cross-linked with  $\text{Ca}^{2+}$  (long chains are interconnected) to form



**FIGURE 5.8** The alginate monomer units. (From Nussinovitch, A., 1997. *Hydrocolloid Applications. Alginates*. Chapman and Hall, UK.)





**FIGURE 5.9** Alginate polymer in NaCl or  $\text{CaCl}_2$  solution. (From Waldman, A.S., Schechinger, L., Govindarajoo, G., Nowick, J.S., and Labuza, T., 1998. *J. Chem. Edu.*, 75(11): 1430–1431.)

flexible, translucent gels. The longer the calcium alginate polymer is in contact with the calcium chloride solution, the more rigid the gel will become [87].

Tay and Perera [32] found that calcium alginate-coated lettuce had pronounced improvement on the crispiness. The thin calcium alginate edible coating retards moisture loss and prevents dehydration, that may be partially responsible for the crispiness observed in alginate coated ‘Butterhead’ lettuce. However, the calcium alginate-coated lettuces were more likely to suffer bruises during the coating process. Hence, this may be the reason why the reduction in browning was not so significant. The calcium alginate-coated lettuces were dipped in  $\text{CaCl}_2$  solution for cross-linking reaction. Hence, the  $\text{CaCl}_2$  could also be responsible for the crispness.

## 5.4 Conclusion

Minimal processing is a growing processing trend that offers the consumer, convenience, “freshness” of quality, nutrition, and safety. As it involves removing or reducing the natural barriers to deterioration, it offers scientists an enormous challenge in trying to extend the shelf life of minimally processed fresh produce. However, the consumer demand for minimally processed products, changes in perception of the consumers for “freshness” of quality of fresh produce, and the convenience of such products warrant further research and developments in this area. To do this, a deeper understanding of the physiology and biochemistry of the plant materials used for minimal processing is essential. An outcome of such understanding is the development of 1-MCP as an ethylene block. While this may offer

some hope of extending the shelf life of minimally processed fresh produce, more research is needed for its application to different fruits and vegetables and their diverse cultivars.

---

## References

1. Bolin, H., and Huxsoll, C. (1989). Storage stability of minimally processed fruits. *J. Food Process. Pres.*, 13: 281–292.
2. McCarthy, M.A., and Mathews, R.H. (1994). Nutritional quality of fruits and vegetables subject to minimal processes. In: *Minimal Processed Refrigerated Fruits and Vegetables*. Wiley, R.C., Ed. Chapman and Hall. New York. pp. 313–326.
3. Barry-Ryan, C., and O’Beirne, D. (1999). Ascorbic acid retention in shredded iceberg lettuce as affected by minimal processing. *J. Food Sci.*, 64(3): 498–500.
4. King, A.D., and Bolin, H.R. (1989). Physiological and microbiological storage stability of minimally processed fruits and vegetables. *Food Technol.*, 43: 132–139.
5. Perera, C.O., and Baldwin, E.A. (2001). Biochemistry of fruits and its implications on processing. In: *Fruit Processing: Nutrition, Products & Quality Management*, 2nd ed. Arthey, D., and Ashurst, P.R., Eds. Aspen Publisher, Inc., Garthersburg, MD.
6. Ahvenainen, R. (2000). Ready-to-use fruits and vegetables, Flair-Flow Europe Technical Manual. [http://flairflow4.vscht.cz/fru\\_veget00.pdf](http://flairflow4.vscht.cz/fru_veget00.pdf).
7. Brecht, J. (1995). Physiology of lightly processed fruits and vegetables. *HortScience*, 30(1): 18–22.
8. Philosoph-Hadas, S., Meir, S., and Aharoni, N. (1991). Effects of wounding on ethylene biosynthesis and senescence of detached spinach leaves. *Physiologia Plantarum*, 83: 341–246.
9. Abe, K., and Watada, A.E. (1991). Ethylene absorbent to maintain quality of lightly processed fruits and vegetables. *J. Food Sci.*, 56: 1589–1592.
10. Saltveit, M. (1999). Effect of ethylene on quality of fresh fruits and vegetables. *Postharvest Biol. Technol.*, 15: 279–292.
11. Adams, D.O., and Young, S.F. (1979). Ethylene biosynthesis: Identification of 1-aminocyclopropene-1-carboxylic acid as an intermediate in the conversion of methionine to ethylene. *Proc. Natl. Acad. Sci., USA*, 76: 170–174.
12. Wang, W.C. (1990). *Chilling Injury in Horticulture Crops*. CRC Press. Boca Raton, FL.
13. Abeles, F.B., Morgan, P.W., and Saltveit, M.E. (1992). *Ethylene in Plant Biology*. 2nd ed. Academic, San Diego.
14. Siedow, J.N. (1991). Plant lipoxygenase: Structure & function. *Annu. Rev. Plant Physiol.*, 42: 145–188.
15. Tian, M.S., Downs, C.G., Lill, R.E., and King, G.A. (1994). A role for ethylene in the yellowing of broccoli after harvest. *J. Am. Soc. Hort. Sci.*, 119: 276–281.
16. Ke, D., and Saltveit, M.E. (1988). Plant hormone interaction and phenolic metabolism in the regulation of russet spotting in iceberg lettuce. *Plant Physiol.*, 88: 1136–1140.
17. Ke, D., and Saltveit, M.E. (1989). Wound-induced ethylene production, phenolic metabolism, and susceptibility to russet spotting in ice-berg lettuce. *Physiologia Plantarum*, 76: 412–418.
18. Ke, D., and Saltveit, M.E. (1989). Regulation of russet spotting, phenolic metabolism, and IAA oxidase by low oxygen in iceberg lettuce. *J. Am. Soc. Hort. Sci.*, 114: 638–642.
19. Ryle, G. (1984). Respiration and plant growth. In: *The Physiology and Biochemistry of Plant Respiration*. Palmer, J., Ed. Cambridge University Press, Cambridge.
20. Rolle, R.S., and Chism III, G.W. (1987). Physiological consequences of minimally processed fruits and vegetables. *J. Food Qual.*, 10: 157–177.
21. Watada, A.E., Abe, K., and Yamauchi, N. (1990). Physiological activities of partially processed fruits and vegetables. *Food Technol.*, 44(5):116–122.
22. Shine, W.E., and Stumpf, P.K. (1974). Fat metabolism in higher plants. Recent studies on plant oxidation systems. *Arch. Biochem. Biophys.*, 162: 147–157.
23. Saltveit Jr., M.E. (1989). A summary of requirement and recommendations for the controlled and modified atmosphere storage of harvested vegetables. *Proceedings of the 5th International Controlled Atmosphere Conference*, Vol. 2. June 14–16. Wenatchee, Washington.
24. Nilsson, T. (2000). In: *Fruit and Vegetable Quality. Postharvest Handling and Storage of Vegetables*. Shewfet, R.L., and Bruckner, B., Eds. Technomic Publishing, Lancaster.

25. Carlin, F., Nguyen-The, C., Hilbert, G., and Chambroy, Y. (1990). Modified atmosphere packaging of fresh ready-to-eat grated carrots in polymeric films. *J. Food Sci.*, 55: 1033–1038.
26. Hansche, P.E., and Boynton, B. (1986). Heritability of enzymatic browning in peaches. *HortScience*, 21: 1195–1197.
27. López-Gálvez, G., Daltveit, M., and Cantwell, M. (1996). Wound-induced phenylalanine ammonia lyase activity: Factors affecting its induction and correlation with the quality of minimally processed lettuces. *Postharvest Biol. Technol.*, 9: 223–233.
28. Ke, D., and Saltveit, M.E. (1989). Carbon dioxide-induced brown stain development as related to phenolic metabolism in iceberg lettuce. *J. Am. Soc. Hort.*, 114: 789–794.
29. Hisaminato, H., Murata, M., and Homma, S. (2001). Relationship between the enzymatic browning and phenylalanine ammonia-lyase activity of cut lettuce, and the prevention of browning by inhibitors of polyphenol biosynthesis. *Biosci. Biotechnol. Biochem.*, 65(5): 1016–1021.
30. Cantos, E., Carlos, E., and Tomas-Barberan, F.A. (2001). Effect of wounding on phenolic enzymes in six minimally processed lettuce cultivars upon storage. *J. Agric. Food Chem.*, 49: 322–330.
31. Loaiza-Velarde, J.G., and Tomas-Barberan, F.A. (1997). Effect of intensity and duration of heat shock treatment on wound induced phenolic metabolism in ice-berg lettuce. *J. Am. Soc. Hort. Sci.*, 122: 873–877.
32. Tay, S.L., and Perera, C.O. (2004). The effect of 1-MCP and edible coatings on quality of minimally processed Baby Butterhead lettuce. *J. Food Sci.*, 69(2): FTC131–135.
33. Link, G.K.K., and Gardner, M.W. (1919). Market pathology and market diseases of vegetables. *Phytopathology*, 9: 497–520.
34. Hyodo, H., Kuroda, H., and Yang, S.F. (1978). Induction of phenylalanine ammonia lyase and increase in phenolics in lettuce leaves in relation to the development of russet spotting caused by ethylene. *Plant Physiol.*, 62: 31–35.
35. Fan, X., and Mattheis, J.P. (2000). Reduction of ethylene-induced physiological disorders of carrots and iceberg lettuce by 1-methylcyclopropene. *HortScience*, 35(7): 1312–1314.
36. Petersen, M.A., and Berends, H. (1993). Ascorbic acid and dehydroascorbic acid content of blanched sweet green pepper during chilled storage in modified atmosphere. *Z. Lebensmittl. Unters. Forsch.*, 197: 546–549.
37. Lee, H.S., and Coates, G.A. (1999). Measurement of the total vitamin C activity in citrus products by HPLC: A review. *J. Liq. Chromatogr. Relat. Technol.*, 22(15): 2367–2387.
38. Cooke, J.R. (1974). Chemical estimation of Vitamin C. In: *Vitamin C: Recent aspects of its physiological and technological importance*. Birch, G.G and Parker, K.J., Eds. Halstead Press, John Wiley and Sons Publishers, New York, N.Y. Chap. 3. pp. 31–39.
39. Anon (1990). *Standard Methods of Analysis for Hygienic Chemists—With Commentary*, Yamane, Y. and Takeshita, R. Eds. Pharmaceutical Society of Japan, Tokyo. p. 368.
40. Furusawa, N. (2001). Rapid high-performance liquid chromatographic identification/quantification of total vitamin C in fruit drinks. *Food Contr.*, 12: 27–29.
41. Albrecht, J.A. (1993). Ascorbic acid and retention in lettuce. *J. Food Qual.*, 16: 311–316.
42. Ku, V.V.V., and Wills, R.B.H. (1999). Effect of 1-methylcyclopropene on the storage life of broccoli. *Postharvest Biol. Technol.*, 17: 127–132.
43. Agar, I.T., Massantini, R., Hess-Pierce, B., and Kader, A.A. (1999). Postharvest CO<sub>2</sub> and ethylene production and quality maintenance of fresh-cut kiwifruit slices. *J. Food Sci.*, 64(3): 433–440.
44. Burton, W.G. (1982). *Post-Harvest Physiology of Food Crops*. Longman, London.
45. Bolin, H., and Huxsoll, C.C. (1991). Effect of preparation procedures and storage parameters on quality retention of salad-cut lettuce. *J. Food Sci.*, 56: 60–67.
46. Izumi, H., and Wantada, A.E. (1995). Calcium treatment to maintain quality of zucchini squash slices. *J. Food Sci.*, 60: 789–793.
47. Guzman, I.L. (1996). Use of calcium and heat treatments to maintain the quality of fresh-cut cantaloupe melons. M.S. thesis, University of California, Davis.
48. Watada, A.E., Ko, N.P., and Minott, D.A. (1996). Factors affecting quality of fresh-cut horticultural products. *Postharvest Biol. Technol.*, 9: 115–125.
49. IFT (2002). Expert report on emerging microbial food safety issues. Released on February 20. [www.ift.org/govtrelations/microfs/](http://www.ift.org/govtrelations/microfs/)
50. Food and Drug Administration, Center for Food Safety and Applied Nutrition. (1998). October 26. Guide to minimize microbial food safety hazards for fresh fruits and vegetables. <http://www.food-safety.gov/~dms/prodguid.html> (last accessed 27/10/2004).

51. Food and Drug Administration, Center for Food Safety and Applied Nutrition. (2001). September 30. Methods to reduce/eliminate pathogens from fresh and fresh-cut produce. <http://www.cfsan.fda.gov/~comm/ift3-5.html> (last accessed 27/10/2004).
52. Murdock, D.J., and Brokaw, C.H. (1958). Sanitary control in processing citrus concentrates: Some specific sources of microbial contamination from fruit bins to extractors. *Food Technol.*, 12: 573–576.
53. Adam, M.R., Hartley, A.D., and Cox, L.J. (1989). Factors affecting the efficacy of washing procedures used in the production of prepared salads. *Food Microbiol.*, 6: 69–77.
54. Li, Y., Brackett, R.E., Chen, J., and Beuchat, L.R. (2002). Survival and growth of *Escherichia coli* O157:H7 inoculated onto cut lettuce before or after heating in chlorinated water, followed by storage at 5°C or 15°C. *J. Food Prot.*, 64: 305–309.
55. Spotts, R.A., and Peters, B.B. (1980). Chlorine and chlorine dioxide for control of d'Anjou pear decay. *Plant Dis.*, 64: 1095–1097.
56. Robert, R.G., and Reymond, S.T. (1994). Chlorine dioxide for reduction of post-harvest pathogen inoculum during handling of tree fruits. *Appl. Environ. Microbiol.*, 60: 2864–2868.
57. Reina, L.D., Fleming, H.P., and Humphries, E.G. (1995). Microbiological control of cucumber hydro-cooling water with chlorine dioxide. *J. Food Prot.*, 58: 541–546.
58. Sapers, G.M., and Simmons, G.F. (1998). Hydrogen peroxide disinfection of minimally processed fruits and vegetables. *Food Technol.*, 52: 48–53.
59. Pao, S., and Davis, C.L. (1999). Enhancing microbiological safety of fresh orange juice by fruit immersion in hot water and chemical sanitizers. *J. Food Prot.*, 62: 756–760.
60. Breidt, R., Hayes, J.S., and Fleming, H.P. (2000). Reduction of microflora on whole pickling cucumbers by blanching. *J. Food Sci.*, 65: 1354–1358.
61. Perera, C.O., and Kiang, K.H. (2003). Microbiological safety of minimally processed fruits. *Proceedings of the International Food Safety Conference*. March 24–26, Muscat, Oman. Vol. 3. pp. 1–5.
62. Hurst, W.C. (1995). Sanitation of lightly processed fruits and vegetables. *HortScience*, 31(1): 22–24.
63. Bolin H.R., Stofford, A.E., King Jr., A.D., and Huxoll, C.C. (1977). Factors affecting the storage stability of shredded lettuce. *J. Food Sci.*, 42: 1319–1321.
64. Neelima, G., Chivey, J.J., and Splittstoesser, D.F. (1990). Effect of processing conditions on the microflora of fresh-cut vegetables. *J. Food Prot.*, 53: 701–703.
65. Nguyen-the, C., and Prunier, J.P. (1989). Involvement of pseudomonads in deterioration of 'ready-to-use' salads. *Int. J. Food Sci. Technol.*, 24: 47–58.
66. Nguyen-the, C., and Carline, F. (1994). The microbiology of minimally-processed fresh fruits and vegetables. *CRC Crit. Rev. Food Sci. Nutr.*, 34: 371–401.
67. Breidt, F., and Fleming, H.P. (1997). Using lactic acid bacteria to improve the safety of minimally processed fruits and vegetables. *Food Technol.*, 51(9): 44–51.
68. Paulin, A.T. (1983). *Chemistry and Control of Modern Chlorination*. LaMotte Chemical Products Co., Chestertown, MD.
69. Mitrol (2001). Mitrol Technology group of companies. Aqua-Plus 5. Technical report.
70. Tian, M., Bowen, J., Bauchot, A., Gong, Y., and Lallu, N. (1997). Recovery of ethylene biosynthesis in DACP-treated tomato fruit. *Plant Growth Regul.*, 22: 73–78.
71. Hopf, H., Wachholz, G., and Walsh, R. (1995). Gas phase kinetics of pyrolysis of 1-methyl-1-cyclopropene. *Chem. Ber.*, 118: 3579–3587.
72. Sisler, E.C., Dupille, E., and Serek, M. (1996). Comparison of cyclopropene, 1-methylcyclopropene and 3,3-dimethylcyclopropene as ethylene antagonists in plants. *Plant Growth Regul.*, 18: 169–174.
73. Lelievre, J., Latche, A., Jones, B., Bouzayen, M., and Pech, J. (1997). Ethylene and fruits ripening. *Physiologia Plantarum*, 101: 727–739.
74. Lelievre, J., Tichit, L., Dao, P., Fillion, L., Nam, Y., Pech, J., and Latche, A. (1997). Effects of chilling on the expression of ethylene biosynthetic genes in Passe-Crassane pear fruits. *Plant Mol. Biol.*, 33(5): 847–855.
75. Sisler, E., and Serek, M. (1997). Inhibitors of ethylene responses in plants at the receptor level: Recent developments. *Physiologia Plantarum*, 100: 577–582.
76. Serek, M., Sisler, E.C., and Reid, M.S. (1994). Novel gaseous ethylene binding inhibitor prevents ethylene effects in potted flowering plants. *J. Am. Soc. Hort. Sci.*, 199: 1230–1233.
77. Serek, M., Sisler, E.C., and Reid, M.S. (1995). Effects of 1-MCP on the vase life and ethylene response of cut flowers. *Plant Growth Regul.*, 16: 93–97.

78. Serek, M., Sisler, E.C., and Reid, M.S. (1996). Ethylene and postharvest performance of miniature roses. *Acta Hort.*, 424: 145–149.
79. Serek, M., Sisler, E.C., and Reid, M.S. (1995). 1-Methylcyclopropene, a novel gaseous inhibitor of ethylene action improves the life of fruits, cut flowers and potted plants. *Acta Hort.*, 394: 337–345.
80. Ku, V.V.V., Wills, R.B.H., and Ben-Yehoshua, S. (1999). 1-Methylcyclopropene can differentially affect the postharvest life of strawberries exposed to ethylene. *HortScience*, 34: 119–120.
81. Perera, C.O., Belchin, L., Baldwin, E.A., Stanlly, R., and Tian, M.S. (2003). Effect of 1-methylcyclopropene on the quality of fresh-cut apple slices. *J. Food Sci.*, 68(6): 1910–1914.
82. Porat, R., Weiss, B., Cohen, L., Daus, A., Goren, R., and Droby, S. (1999). Effects of ethylene and 1-methylcyclopropene on the postharvest qualities of “Shamouti” oranges. *Postharvest Biol. Technol.*, 15: 155–163.
83. Hershko, V., and Nussinovitch, A. (1998). The behavior of hydrocolloid coatings and vegetative materials. *Biotechnol. Prog.*, 14: 756–765.
84. Baldwin, E.A., Nisperos-Carriedo, M.O., and Baker, R.A. (1995). Use of edible coating to preserve quality of lightly (or slightly) processed products. *Crit. Rev. Food Sci. Nutr.*, 35: 509–524.
85. Kester, J.J., and Fernnera, O.R. (1988). Edible films and coatings: A review. *Food Technol.*, 42: 47–59.
86. Baker, R.A., and Bruemmer, J.H. (1989). Quality and stability of enzymically peeled and sectioned citrus fruits. In: *Quality Factors of Fruits and Vegetables: Chemistry and Technology*. Jen, J.J., Ed. CS Symposium Series 405, American Chemical Society, Washington, DC. Chap. 12. pp. 140–148.
87. Waldman, A.S., Schechinger, L., Govindarajoo, G., Nowick, J.S., and Labuza, T. (1998). The alginate demonstration: Polymers, food science, and ion exchange. *J. Chem. Edu.*, 75(11): 1430–1431.
88. Pavlath, A.E., Gossett, C., Camirand, W., and Robertson, G.H. (1999). Ionomeric films of alginic acid. *J. Food Sci.*, 64(1): 61–63.
89. Dziezak, J.D. (1991). A focus on gum. *Food Technol.*, 45: 116.
90. McDowell, R.H. (1960). Applications of alginates. *Rev. Pure Appl. Chem.*, 10(1): 1–15.
91. Nussinovitch, A. (1997). *Hydrocolloid Applications. Alginates*. Chapman and Hall, UK.

# 6

## *Postharvest Handling and Preservation of Fresh Fish and Seafood*

Linus U. Opara, Saud M. Al-Jufaili, and Mohammad Shafiur Rahman

### CONTENTS

6.1	General Overview .....	152
6.1.1	Introduction .....	152
6.1.2	Objectives and Scope .....	152
6.1.3	Economic Importance—Fish Production, Trade, and Utilization .....	152
6.1.3.1	Global Fish Production .....	152
6.1.3.2	Global Fish Trade .....	153
6.1.3.3	Fish Utilization .....	153
6.1.3.4	Contribution of Fish to Human Nutrition .....	154
6.1.3.5	Fish and Seafood in Functional Foods .....	155
6.1.4	The Problem of Postharvest Losses in Fish and Seafood .....	156
6.2	Mechanisms and Manifestations of Spoilage in Fish and Seafood .....	157
6.2.1	Biochemical Aspects of Fresh Fish and Seafood Spoilage .....	157
6.2.2	Characterization and Quantification of Fish Spoilage .....	158
6.2.3	Abiotic, Biotic, and Physiological Causes of Fish and Seafood Spoilage .....	159
6.2.3.1	Mechanical Handling Damage .....	159
6.2.3.2	Environmental Factors .....	159
6.2.3.3	Biotic (Bacterial) Factors .....	159
6.2.3.4	Physiological (Internal) Factors: Lipid Oxidation and Hydrolysis .....	160
6.2.4	Physicochemical Manifestations of Spoilage in Fish and Seafood .....	161
6.2.4.1	Color Changes .....	161
6.2.4.2	Texture Changes .....	162
6.2.4.3	Odor Changes .....	164
6.2.4.4	Protein Changes .....	164
6.3	Postharvest Treatments and Preservation of Fish and Seafood .....	165
6.3.1	Introduction .....	165
6.3.2	Improvement of Harvesting and Postharvest Handling Systems .....	165
6.3.3	Prestorage Treatments .....	166
6.3.4	Cold/Cool Chain Technology .....	166
6.3.5	Chemical Treatments and Use of Biopreservatives .....	167
6.3.5.1	Chlorine and Chlorine Dioxide .....	167
6.3.5.2	Hydrogen Peroxide .....	167
6.3.5.3	Lactic Acid Bacteria .....	167
6.3.6	Enzyme Inhibitors .....	168
6.3.7	The Role of Packaging Technology .....	168
6.3.8	Irradiation Treatment .....	168
6.4	Future Prospects for Fresh Fish and Seafood Preservation .....	169
	References .....	170

---

## **6.1 General Overview**

### **6.1.1 Introduction**

The fisheries sector plays an important role toward food security, food industries development, and poverty alleviation in many parts of the world. Fisheries exports now generate more foreign exchange (either through export earnings or licence receipts) than the revenues earned from any other traded food commodity such as rice, cocoa, coffee, or tea. Worldwide, more than 38 million people are directly engaged in fishing and fish farming as a full-time or, more frequently, part-time occupation, and fishery products account for 15%–16% of global animal protein intake. Seventy percent of the fish for human consumption is presently supplied by developing countries, and the fisheries sector is particularly important for 44 countries (mainly small island developing states, plus countries in Africa, Asia, Latin America, and countries undergoing transition economies). The fisheries sector in these countries is considered to be significant because the contribution of fisheries to agricultural export trade and daily animal protein intake is greater than 10% [1–4].

Over the last few years, the consumption of fish and fishery products has been strongly influenced by improvements in postharvest handling, packaging, storage, transportation, and marketing, which have led to significant improvements in postproduction efficiency, lower costs, wider product choice, and safer and improved products. Advances in marine and fisheries science and engineering as well as food product development have resulted in technological innovations for fish capture, postharvest handling, processing, marketing, and distribution. The extent and range of these changes have varied among regions; however, the increasing recognition of the importance of fish and other seafoods in the economy of many producing regions as well as the supply of food proteins to many parts of the developing world has raised awareness on the role of fish and other marine foods in enhancing food security and alleviating malnutrition and poverty. In general, there has been a growth in fish and fishery products marketed in fresh form and in the production of ready-to-cook or ready-to-eat products, particularly in wealthy economies and owing partly to increasing understanding of fish functionality to health. The development and application of efficient and cost-effective postharvest technologies for handling and preservation of fresh fish and other seafood is therefore important to ensure product safety and maintenance of quality throughout the supply chain from sea to plate.

### **6.1.2 Objectives and Scope**

The aim of this chapter is to outline and discuss the techniques and procedures for postharvest handling and preservation of fresh fish and other seafood products. Beginning with an overview of the global fisheries industry, the emphasis in this chapter is on the application of postharvest technologies to deliver whole or minimally processed fresh fish and seafood products to the end user. A wide range of marine organisms (fish, crustaceans, and molluscs) are consumed directly by humans as food or utilized as industrial raw materials such as animal feed. Each fish species may respond slightly differently to particular handling procedures and preservation techniques; however, this chapter will focus on the major technologies that are applicable for the handling and preservation of a wide range of fresh fish and seafood materials. Where appropriate, specific mention will be made about the response of a known type of fish or seafood to specific technological innovations for improved handling, quality maintenance, and preservation.

### **6.1.3 Economic Importance—Fish Production, Trade, and Utilization**

#### **6.1.3.1 Global Fish Production**

Fish is an important source of protein, and the economic activities associated with its harvest, handling, processing, and distribution provide a means of livelihood for millions of people as well as providing valuable foreign-exchange earnings to many countries. Fish is a highly perishable food product, requiring proper handling, processing, and distribution if it is to be utilized in a cost-effective and efficient way with limited risk to human health and safety. Global demand for fish is growing, and reductions in postharvest losses and maintenance of product quality and safety can make a major contribution to satisfying this demand as well as increasing financial returns to fishers and marketers.

After increasing from around 79 million tonnes in 1998 to 87 million tonnes in 2000, world marine capture fisheries production decreased to around 84 million tonnes in 2001 and remained at that level in 2002. The decrease of around 2.5% in global catches between 2000 and 2002 is mostly due to the declines by 12% and 7%, respectively, in production from the Southeast Pacific and the Northwest Pacific [1]. Current estimates on available fisheries resources confirm the estimates made by FAO in the early 1970s that the global potential for marine capture fisheries is about 100 million tonnes, of which only 80 million tonnes are probably achievable. It also confirms that, despite local differences, overall, this limit has been reached. These conclusions lend support to the call for more rigorous stock recovery plans to rebuild stocks that have been depleted by overfishing and to prevent the decline of those being exploited at or close to their maximum potential. This situation underscores the critical importance of the improved postharvest handling techniques and procedures to reduce the incidence of losses (quantity and quality) of captured fish as part of an integrated approach to stock management as well as delivery of good-quality and safe fish products to the consumer.

### **6.1.3.2 Global Fish Trade**

In 2002, the total world trade of fish and fish products increased to US\$ 58.2 billion (export value), representing a 5% increase relative to 2000 and a 45% increase since 1992 [5]. In terms of quantity, exports were reported to be 50 million tonnes (live weight equivalent), having grown by 40.7% since 1992, but showing a slight decline (1.0%) compared with 2000 levels. The quantity of fish traded has remained stagnant over the last few years following decades of strong increases. Many of the economic factors responsible for the high growth in world fishery trade in the previous decade have now diminished in importance or are not strong enough to sustain past performance levels. While preliminary estimates for 2003 indicate a slight increase in the value of fishery exports, it is unlikely that the trends of pre-2000 years will be repeated in the short term, especially given setbacks resulting from geopolitical tensions.

### **6.1.3.3 Fish Utilization**

In 2002, about 76% (100.7 million tonnes) of estimated world fish production was used for direct human consumption (Table 6.1). The remaining 24% (32 million tonnes) was destined for nonfood products, in particular the manufacture of fishmeal and oil. If China is excluded, the shares are 74% (65.5 million tonnes) and 26% (23 million tonnes), respectively (Table 6.1 and Figure 6.1). More than 79% (35 million tonnes) of China's reported fish production (44 million tonnes) was apparently used for direct human consumption, the bulk of which was in fresh form (75.5%). The remaining amount (an estimated 9.1 million tonnes) was reduced to fishmeal and other nonfood uses, including direct feed for aquaculture.

In 2002, 70% (62 million tonnes) of the world's fish production, excluding China, underwent some form of processing. Sixty-three percent (39 million tonnes) of this processed fish was used for manufacturing products for direct human consumption and the rest for nonfood uses. The many options for processing fish allow for a wide range of tastes and presentations, making fish one of the most versatile food commodities. Yet, unlike many other food products, processing does not generally increase the price of the final product, and fresh fish is still the most widely accepted product on the market. During the 1990s, the proportion of fish marketed in live/fresh form worldwide increased compared with other products (Figure 6.1). Excluding China, live/fresh fish quantity increased from an estimated 17 million tonnes in 1992 to 26 million tonnes in 2002, representing an increase in its share in total production from 20% to 30%. In Africa and Asia, the share of fish marketed in live or fresh forms was particularly high.

Processed fish for human consumption (frozen, cured, and canned) remained relatively stable at around 39 million tonnes. Freezing represents the main method of processing fish for food use, accounting for 53% of total processed fish for human consumption in 2002, followed by canning (27%) and curing (20%). In developed countries, the proportion of fish that is frozen has been constantly increasing, and it accounted for 42% of production in 2002. By comparison, the share of frozen products was 13% of total production in developing countries, where fish is largely marketed in fresh/chilled form. The high demand for fish as fresh produce (Figure 6.1) is partly explained by increasing consumer interest and understanding of the fish and fish products as functional food. The high demand for fresh fish also underlines the increasing need to



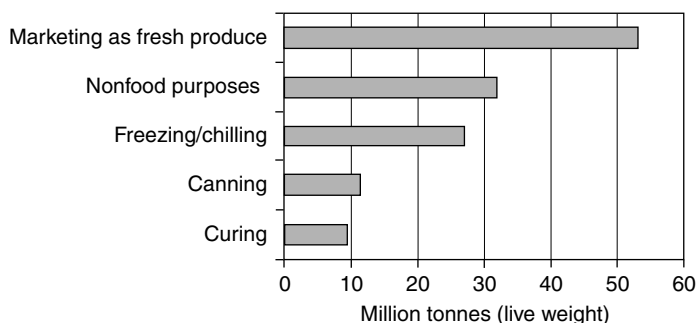
**TABLE 6.1**

Total and Per Capita Food Fish Supply by Continent and Economic Grouping in 2001

	Total Food Supply (Million Tonnes Live Weight Equivalent)	Per Capita Food Supply (kg/year)
World	100.2	16.3
World excluding China	67.9	13.9
Africa	6.3	7.8
North and Central America	8.5	17.3
South America	3.1	8.8
China	32.3	25.6
Asia (excluding China)	34.8	14.1
Europe	14.4	19.8
Oceania	0.7	23.0
Industrialized countries	26.0	28.6
Economies in transition	4.7	11.4
LIFDCs (excluding China)	22.5	8.5
Developing countries excluding LIFDCs	14.9	14.8

*Note:* Based on data available to FAO in December 2003. Some discrepancy may occur with other sections that quote data made available to FAO more recently.

*Source:* C.L. Delgado et al., *The Future of Fish. Issues and Trends to 2020*. IFPRI, 2003, 6pp.



**FIGURE 6.1** Utilization of world fisheries production (breakdown by quantity), 2002. (Adapted from C.L. Delgado et al., *The Future of Fish. Issues and Trends to 2020*. IFPRI, 2003, 6pp.)

develop and apply appropriate innovative postharvest handling systems for maintenance of fish freshness and product safety.

In 2002, average apparent per capita consumption of fish, crustaceans, and molluscs worldwide was estimated to be about 16.2 kg, 21% higher than in 1992 (13.1 kg). This growth is largely attributable to China, whose estimated share of world fish production increased from 16% in 1992 to 33% in 2002. If China is excluded, the per capita fish supply would be 13.2 kg, almost the same as in 1992. Following a peak of 14.6 kg in 1987, world per capita fish supply, excluding China, showed a declining trend from the late 1980s to the early 1990s but has stabilized since then [1]. The declining trend was mainly caused by population growth outpacing that of food fish supply during the 1987–2002 period (1.3% per annum compared with 0.6%, respectively). For China, the corresponding annual increase since 1987 was 1.1% for population growth and 8.9% for food fish supply. In 2002, per capita fish supply in China was about 27.7 kg.

#### 6.1.3.4 Contribution of Fish to Human Nutrition

Fish represents a valuable source of micronutrients, minerals, essential fatty acids, and proteins in the diet of many countries. The meat of fish and seafood products contains about 80% (w/w) water, 8%–25% proteins, 0.5%–30% fat, and 0.6%–1.5% mineral compounds [6,7]. Fish meat contains abundant amounts of water-soluble vitamins, and fish oil (particularly from the liver) is rich in vitamins A and D. Also, it is commonly noted that one serving of seafood may meet the daily human requirement for B vitamins, and

the biological value of seafood protein exceeds that of red meat proteins owing to the low proportion of collagen [6]. Lipids contained in fish are rich in essential polyenoic fatty acids, and particularly valuable nutritionally are the *n*-3 polyenoic acids, which may reach up to 40% in the oil content of some fish. The nutritional value of fish differs considerably depending on the species, maturity and health status, type of the muscle or body part, processing technique, and duration after harvest.

It is estimated that fish contributes up to 754 kJ per capita per day, but reaches such high levels only in a few countries where there is a lack of alternative protein foods, and where a preference for fish has been developed and maintained (e.g., in Iceland, Japan, and some small island developing states). More commonly, fish provides about 84–125 kJ per capita per day. Fish proteins are a crucial dietary component in some densely populated countries, where the total protein intake level may be low, and are significant in the diets of many other countries. For instance, fish contributes to or exceeds 50% of total animal proteins in some small island developing states and in Bangladesh, Cambodia, the Congo, the Gambia, Ghana, Equatorial Guinea, Indonesia, Japan, Sierra Leone, and Sri Lanka.

Overall, fish provides more than 2.6 billion people with at least 20% of their average per capita intake of animal protein. The share of fish proteins in total world animal protein supplies rose from 14.9% in 1992 to a peak of 16.0% in 1996, before declining slightly to 15.9% in 2001. Corresponding figures for the world, excluding China, show an increase from 14.3% to 14.7% in 2001 during the same period [1,5].

In industrialized countries (Table 6.1), apparent fish consumption rose from 24 million tonnes (live weight equivalent) in 1992 to 26 million tonnes in 2001, with a rise in per capita consumption from 28.0 to 28.6 kg. The contribution of fish to total protein intake declined slightly from 8.0% in 1992 to 7.7% in 2001. In these countries, the share of fish in total protein intake rose consistently until 1989 (by between 6.5% and 8.5%), when it began a gradual decline as the consumption of other animal proteins began to increase; by 2001, its contribution was back at the levels prevailing in the mid-1980s. Since the early 1990s, consumption of fish protein has remained relatively stable at around 8.1–8.3 g per capita per day, while the intake of other animal proteins has continued to rise. Notwithstanding the relatively low fish consumption by weight in low-income food deficit countries (LIFDCs), the contribution of fish to total animal protein intake in 2001 was significant at more than 20%, and may be higher than that indicated by official statistics in view of the unrecorded contribution of subsistence fisheries.

In 2002 [1,5], over 60% of the world food fish supplies originated from capture fisheries production; the remaining amount came from aquaculture. The contribution of inland and marine capture fisheries to per capita food supply declined slightly in the last decade and in particular since 1997, with a decrease of the per capita supply from almost 10.8 kg in 1997 to 9.8 kg in 2002. Worldwide, excluding China, per capita food fish supply from capture fisheries declined from 11.5 kg in 1997 to 10.8 kg in 2002. In contrast, excluding China, the average contribution of aquaculture to per capita supply grew from 13.0% in 1992 to 18.4% in 2002, corresponding to an increase from 1.7 kg per capita in 1992 to 2.4 kg in 2002 (average annual growth of 3.5%).

#### **6.1.3.5 Fish and Seafood in Functional Foods**

Increasing realization of the positive link between fish consumption and good health has led to an upsurge in research and commercial exploitation of seafood biotechnologies to produce innovative functional marine food and medicinal products. The particularly low incidence of heart disease in fish-eating populations has been attributed to high ingested levels of the so-called omega-3 (called eicosapentaenoic acid (EPA) and docosahexaenoic acid (DHA)) polyunsaturated fatty acids (PUFAs) in fish oil. For instance, in a recent EU project [8], researchers successfully incorporated omega-3s into a range of products including bread, biscuits, soup, and an infant formula using a spray-drying process (patent application pending). According to the authors, the products had good quality and stability, the latter in the context of off-flavor development. In addition, threshold levels of omega-3s giving a lowering in plasma triacylglycerol (TAG) concentrations and a reduced clotting tendency of the blood were obtained via human feeding trials. TAG concentrations were reduced by 0.9g/day of omega-3s, and while platelet phospholipid EPA and DHA levels were reduced in a time- and dose-dependent manner with 0.9–0.3 g/day of omega-3s, and similarly for the ratio of platelet phospholipid omega-3 to omega-6 PUFA. This range in concentration (i.e., 0.9–0.3 g/day) also raised the plasma total high-density lipoprotein (HDL) cholesterol (the so-called good cholesterol). These results indicated positive health benefits of fish oil consumption (via ingestion of

foods supplemented with omega-3s) with implications for heart disease, especially in the case of women. Positive results were also obtained with omega-3s in relation to certain cancer-causing genes at cell level.

#### 6.1.4 The Problem of Postharvest Losses in Fish and Seafood

Harvested fish and seafood materials undergo series of handling operations from catch sites until the product is delivered to the end user. Fish are highly perishable starting from the point of harvest. Several factors predispose fresh fish to rapid quality degradation once they are harvested, and these include alteration of the surrounding environment due to removal from the marine or aquatic environment, high moisture content of fish, activities of microorganisms inside the gut and intestine, and physical damage resulting from the use of improper harvesting tools and procedures and rough handling practices. Apart from being a cosmetic defect, which results in downgrading of fresh fish quality, the presence of physical damage due to rough handling also predisposes fresh fish to accelerated water loss as well as opportunistic microbial infection during subsequent handling operations.

Postharvest losses in fish may occur quantitatively or qualitatively. Quantity losses (wastage) occur when fish disappears or is removed from the food chain, and this may occur due to spillage or discard when the product is considered completely unacceptable for utilization as food and as an industrial raw material. Quantity loss may also be referred to as physical loss. Quality loss in fresh fish occurs when the product value to the end user is compromised and downgraded due to a reduction in the attributes that are important to the end user. Quality loss often results in lower unit market price of fish product and a concomitant reduction in profits to the producer. Given the high volume of globally traded fresh fish produce, quality loss is a major contributor to total economic loss in the fresh fish and seafood industry.

The availability of reliable data on the magnitude and sources of postharvest losses is important in the efforts to reduce the incidence of physical and quality losses in the fish and seafood industry. Exact data on losses of fish and other seafood materials are not readily available due to a myriad of factors, including variations in species, geographical location, and season, as well as differences in harvesting, postharvest handling, and marketing systems. Nonetheless, several researchers have reported the incidence of fish losses based on surveys at various steps in the handling and marketing chain [9–12]. Others have developed empirical models of postharvest fish losses based on a consideration of the physical and monetary losses associated with various steps in fish handling from landing sites to export [13].

Global levels of fish losses are often estimated to be 20%–40%. Published annual estimations of global fish losses include 3 million tonnes [11], 4.2 million tonnes [14], and 10–12 million tonnes [15]; however, most authors do not provide detailed information on the method of data acquisition and the specific type of losses reported. Nevertheless, these figures are expected to be much higher in many producing regions in developing countries where fish harvesting and postharvest handling technologies are not adequate to meet the needs for modern integrated long-supply chains and marketing systems. In the Lake Victoria fishing community in Kenya with an annual catch of about 180,143 tonnes in 2000 and worth over 9 billion Kenya shillings, it has been estimated that postharvest losses ranged from 20% to 25% [12]. These losses could double to 50% in some seasons or specific locations when large catches are made [16]. Further studies on three major fish species at seven beaches in the area reported quality losses of 13.9% for *Clarias* fishery, 6.4% for Nile perch, and 6.2% for *Protoperus* [12]. The authors identified the lack of basic cooling and preservation facilities at landing sites as major causes of quality loss.

Application of the generalized fish postharvest loss model by Cheke and Ward [11] to the Nile Perch fisheries in the Tanzania area of Lake Victoria showed that the total value of losses (US\$) per 100 kg ranged from 4.20 to 7.55, depending on the type of fishing gear and method of transportation. The value of physical loss alone ranged from US\$ 3.14 per 100 kg for fish caught by beach seine nets and transported by air to US\$ 4.62 per 100 kg for fish caught by gill nets and transported by rail. According to Cheke and Ward, these model predictions supported the common knowledge among fishers and marketers that fish from beach seine nets are usually much fresher and of better quality when landed than those caught by gill nets or long lines.

In the Sultanate of Oman, high incidence of postharvest losses has been recognized as an economic problem mitigating economic development of the fisheries sector. The annual loss due to downgrading of fish was estimated at nearly US\$ 62 million [17]. On fish type basis, the loss in quantity ranged

between 40% and 70% for demersal fishes, 5% for the pelagics, and 10% for the entire traditional fisheries sector. Recent studies at major fish landing and marketing sites in the Muscat Governorate in the Sultanate of Oman [9,18] showed that fresh fish losses was a common problem. Fishers and marketers reported high incidence of losses, resulting in loss of potential revenue ranging from 12.5% to 20%. The authors also found that for the large pelagics, downgrading due to loss in freshness (value) could reach between 10%–25% after the first day of landing and 19.0%–43.8% after the second day at the market.

---

## 6.2 Mechanisms and Manifestations of Spoilage in Fish and Seafood

Fresh fish and other seafoods undergo many chemical and biological changes immediately after capture, which can ultimately result in spoilage. Several factors contribute to such spoilage in fish, including interactions between the products and handling equipment, interactions between the product and the surrounding environment and atmosphere, and the inherent self-destructive biochemical changes that take place inside the fish once it is harvested. The occurrence of spoilage in fish is manifested and perceived by the end user through changes in several sensory perceptions, including odor, color, shape, texture, and composition. In this section, we describe the biochemical mechanisms of fish and seafood spoilage, the factors contributing to the incidence of spoilage, and conclude with a synthesis of the various manifestations of spoilage in fresh fish and seafood products.

### 6.2.1 Biochemical Aspects of Fresh Fish and Seafood Spoilage

Prior to harvest, fish are protected by a skin that secretes antimicrobial compounds, such as lysozyme, and by antibodies in the blood. This self-protecting and self-regulating property is indicative of the biochemical composition of fish. For instance, lean fish contain 20% protein, less than 5% lipid, with little carbohydrate, whereas fatty fish contain 10%–30% lipid. The pH of fish flesh is neutral, and the flesh is highly buffered due to the presence of phosphates and creatine in the muscle and has a low oxidation–reduction potential [19].

Harvesting of marine, freshwater, or aquaculture fish and other seafoods is an essential step in the delivery of desired products to the consumer. However, harvesting results in death of fish with the following consequences [19]:

1. Cessation of energy supply for normal body function.
2. Cell membranes are no longer energized, and molecules and ions can freely diffuse.
3. Antimicrobials are no longer produced or distributed.
4. Microflora penetrates the skin from the outside surface and the flesh from the intestines and gills.

During this period, the contractile mechanism can still operate, permitting the muscle to contract and relax [20]. To remain relaxed, the muscle consumes adenosine triphosphate (ATP); thus, when ATP is no longer sufficient the muscle will contract, resulting in a phenomenon called rigor mortis. In broad terms, rigor mortis is the change that occurs in muscle following death, and its development is influenced by several factors, including (a) the prevailing environmental conditions, notably temperature (increasing temperature accelerates it), (b) the health status of the fish prior to harvest, and (c) any reduction in muscle glycogen during life. The physical and physiological symptoms of rigor mortis include (a) stiffening, hardening, and shortening of the muscle, (b) loss of transparency, and (c) loss of elasticity. In iced fish, this condition usually lasts for one day or more, followed by the resolution of rigor.

All muscle contracts in rigor mortis, either because ATP is exhausted or because the pH has fallen sufficiently below critical level. Suzuki [21] studied the linewidths of NMR spectra of water in flat fish in prerigor, rigor, and postrigor stages. The results showed that linewidth in rigor stages is broader than in the prerigor and postrigor stages, but in the postrigor stage it became narrower than in the prerigor stage. The same results were also observed in sea bass, but only in the case of starved carp where rigor mortis was obscure and the change in the width of lines was not clear [19]. Blanshard and Derbyshire [22] investigated the state of water in muscles as a function of time after death by spin-lattice relaxation. They found

that during rigor there was a net transfer of water from the free phase of the region, giving rise to a more rapidly relaxing signal.

Marine fish contain trimethylamine oxide (TMAO) as an osmoregulator. Some bacteria or endogenous enzymes can reduce TMAO to trimethylamine (TMA, which has the odor of stale fish) and formaldehyde. The bacteria can obtain energy from this reaction and use it as an electron acceptor in the absence of oxygen. Freshwater fish containing TMAO usually have a longer shelf life, even if the level of TMAO is low. Thus, the level of TMAO-reducing bacteria is important to preserve marine fish. There is little fermentation activity in the microflora due to the low carbohydrate content of most fish [19]. The initial quality of seafood is related to the species, the growing area conditions, the fishing or harvesting techniques, the seasonal biological changes in muscle and other organs, and the postharvest storage and processing conditions [23]. The ultimate quality is linked to the biochemical changes in the major constituents and microbial load and type in the fish or seafood and water from which they are harvested. Bacteria cause the organoleptic changes. The active bacteria are psychrotrophic or cold loving and well adapted to growth under chill conditions [19].

## 6.2.2 Characterization and Quantification of Fish Spoilage

The most distinct stages of fish spoilage are shown in Table 6.2, based on results obtained from cod fish stored in ice over an extended period of time [24]. In summary, a combination of visible signs of degradation and odor production may be used to characterize different phases of spoilage after harvest.

Cooked flavor without added condiments is the most precise objective method of assessing fish spoilage and quality changes. For practical purposes, however, this destructive approach is time consuming and not suitable for rapid assessment during postharvest handling and marketing operations. For nondestructive measurement, changes in gill color, gill odor, eye color, skin color, skin rubberiness, and odor production may be used alone or in combination, to assess the quality status of fresh fish. Among the various nondestructive testing approaches, gill odor has been considered the most reliable and reproducible characteristic [19].

Several biochemical changes have been successfully used to quantify the level of spoilage in fresh fish and seafoods. The concentration of TMA is used as an index of spoilage either alone or as a component of the total volatiles containing ammonia and other amines. An alternative chemical index of fish spoilage is hypoxanthine, which is derived from the breakdown of ATP. After the death of a fish, ATP in the meat decomposes to uric acid by a series of catabolic enzymes [25]. Hypoxanthine is an intermediate of these reactions and accumulates as storage time increases. Another more complex measurement is the potassium value, which is based on ATP, adenosine diphosphate (ADP), adenosine monophosphate (AMP), and hypoxanthine [19]. Changes in the dielectric properties of whole fish and skin-on portions occur during spoilage, and these changes can be measured in a nondestructive manner [19].

Drip loss is a quality problem in fish and seafood products. Once the water-holding capacity falls below the water content of the muscle, excess water will be lost, either immediately or later during processing or cooking [20]. Reducing drip loss during postharvest handling and marketing is therefore an important value-chain management of fish and other fresh foods. The amount of drip loss from muscle depends largely on changes in the water-holding capacity of the muscle protein after death. Magnitude of drip loss is influenced by a combination of time and temperature of the immediate postmortem period [20]; therefore, adequate cold-chain management is critical in reducing the incidence of drip loss.

**TABLE 6.2**

Characteristics of Phase Changes during Spoilage of Cod Fish Stored in Ice

Phase	Storage (Days)	Characteristic Changes
I	0–6	No marked sign of spoilage
II	7–10	No odor production
III	11–14	Production of some odor, slightly sweet to fruity odors
IV	>14	Production of hydrogen sulfite and other sulfide compounds, fecal, and strong ammonia odors

Source: J.M. Shewan, *J. Appl. Bacteriol.* 34:299, 1970.

In summary, postharvest fish muscle quality can be maintained and spoilage reduced by a delay in the onset of rigor mortis (associated with low stress) or the use of rapid killing methods [26]. In addition, Jerret et al. [26] have noted that a combination of behavioral conditioning, conservative handling practices, and chemical anesthesia can be used to minimize the extent of premortem exercise and thereby provide rested fish. The authors also recommended the importance of reducing preharvest exercise in the production of high-quality fish muscle.

### **6.2.3 Abiotic, Biotic, and Physiological Causes of Fish and Seafood Spoilage**

Spoilage of fish and seafood is caused by a myriad of factors that are related to the harvesting and handling practices and equipment, postharvest handling environmental conditions, the presence of decay-causing microbiological agents, and internal physiological changes or biochemical reactions that are associated with normal processes of aging and death. Like other fresh produce and irrespective of the primary causative agent, the rate of spoilage and quality degradation of fresh fish and seafood products is highly accelerated at elevated temperatures. Conversely, the deleterious effects of spoilage-causing agents can be significantly reduced through a synergistic effect of adequate temperature management in combination with other specific measures.

#### **6.2.3.1 Mechanical Handling Damage**

Wholesomeness and freedom from physical damage is an important quality attribute in fish trade, especially for fresh fish destined to the consumer. During harvesting and postharvest handling operations, fish may be subjected to excessive forces, which result in physical injury and blemish. Such damage may occur through several mechanisms, including impact, compression, friction/abrasion, and cuts. Impact damage occurs when the fish falls from an excessive height to generate sufficient absorbed impact energy that causes damage to the skin alone or in combination with the underlying flesh. Compression damage occurs due to excessive stationary forces acting on the produce (such as cartons of produce stacked too high). Mechanical handling of fish affects the degradation of nucleotides in fish. Moreover, handling of and mechanical damage to muscle tissue may increase degradation of inosine monophosphate and inosine by making their substrates more accessible due to enzyme compartmentalization [27]. Furthermore, the presence of physical injury such as bruise, cuts, and abrasion provides favorable sites for opportunistic infection and contamination of produce by decay-causing microorganisms.

#### **6.2.3.2 Environmental Factors**

Undesirable environmental conditions around fresh produce, such as the degree of hotness or coldness (temperature), water vapor content in the air (relative humidity), as well as direct exposure to sunlight and airflow contribute to the onset and rate of quality deterioration and spoilage. By far, temperature is the most influential factor affecting spoilage of fresh produce such as fish and seafood. In addition to its effects in accelerating physiological and biochemical processes associated with tissue degradation and eventual spoilage, temperature also accelerates the action of microbial agents (such as bacteria), which cause spoilage and food safety hazards. Freshness of high-water-content foods such as fish and seafood is maintained better under high relative humidity conditions; thus, storing such produce at low relative humidity contributed to rapid spoilage and development of undesirable attributes. Airflow around fresh fish and seafoods must be closely monitored to avoid excessive loss of surface moisture and undesirable changes in skin and flesh quality.

#### **6.2.3.3 Biotic (Bacterial) Factors**

The deterioration of fresh fish is primarily due to bacterial action. It is recognized that only some of the bacteria present is responsible for producing the off-odors, off-flavors, appearance, and textural changes that constitute spoiled fish [19]. The composition of the microflora is dependent on difference factors, such as environment and season. Spoilage bacteria affect the degradation of nucleotides in fish. In cod fillets, the presence of spoilage bacteria increased the rate of degradation of inosine to hypoxanthine. This indicates that bacterial enzymes play an active role in contributing to the degradative process. The synthesis of proteases depends on the nutrient source, and secretion of proteases increases with

the decrease in available nutrients, reaching a maximum concentration by late log or early stationary phase of the bacterial growth. The level of protease secretion is low during the initial stage of bacterial spoilage, that is,  $10^6$  CFU/g of flesh. Above  $10^6$  CFU/g there is high protease secretion [27].

Bacterial spoilage is evident in fish even at 0 to  $-4^\circ\text{C}$ , but spoilage can be prevented below  $-10^\circ\text{C}$  [24]. For cod stored in ice, there is a 2- to 3-day lag period with a logarithmic increase by day 10 in the bacterial flora, generally with counts up to  $10^8$  per  $\text{cm}^2$  skin or  $10^8$  per gram muscle. *Pseudomonas* species dominate up to 90% by day 12. They produce spoilage odors, such as ammonia, and volatile sulfur compounds such as mercaptans and hydrogen sulfide [28].

Consumption of contaminated fish and seafood is a potential source of health and safety hazard to humans. The main hazards of fish and seafood are pathogenic bacteria (aquatic environment, from humans or animals, biogenic amine producers, and spoilage bacteria), parasites, biotoxins, and viruses [29]. All aquatic environments can harbor spores of *Clostridium botulinum*, which can contaminate fish both in marine and freshwater environments. *Vibrio parahaemolyticus* is the leading cause of food poisoning in Japan where much fish is eaten raw. It does not grow below  $10^\circ\text{C}$  and dies out at chill temperatures and is heat labile. As it is halophilic, it survives salting and smoking. Control is therefore achieved by proper chill storage. There has been a global increase in the presence of algal toxins in shellfish. More toxins are being identified. One of the major concerns in recent years to the fish processing industry has been *Listeria monocytogenes*. This organism can grow at chill temperatures and is not inhibited by the levels of salt in smoked products [19].

The bacterial flora of water reflects the flora of fish harvested from the area. The flora of cold-water fish is predominantly Gram-negative, while flora in tropical fish are predominantly mesophilic Gram-positive microorganisms [27]. The dominant microflora of cold-water fish species are *Pseudomonas*, *Alteromonas*, *Moraxella*, *Acinetobacter*, *Vibrio*, *Flavobacterium*, and *Cytophaga* [30]. Gram-positive organisms found on warm fish species are predominantly *Micrococcus* and *Bacillus* [27]. Psychrotrophic bacteria are found in almost all types of refrigerated and frozen foods. The outgrowth of pseudomonads in spoiling fish is due to their efficient use of free amino acids (especially methionine and cysteine) and peptides in nonprotein fraction during the early stage of spoilage, and their secretion of potent proteases, thus promoting proteolysis after low-molecular-weight components have been exhausted. The primary use of all nitrogenous compounds is through oxidative deamination, which results in the accumulation of ammonia, volatile fatty acids, and sulfur-containing compounds [30]. Volatile sulfur-containing compounds are believed to produce spoilage odors. These compounds have extremely low thresholds, and their origin is usually traced to nonprotein nitrogenous compounds in the skin and flesh.

Change in *K* value index (ratio of inosine and hypoxanthine to the quantity of ATP, ADP, AMP, and IMP [inosine monophosphate]) is an objective measure of fish muscle quality during postharvest handling and storage. In their study of storage temperature effects on histamine production and fish freshness, Guizani et al. [31] found that although yellowfin tuna maintained an acceptable shelf life based on *K* value for 12, 5, and 1 day at  $0^\circ\text{C}$ ,  $8^\circ\text{C}$ , and  $20^\circ\text{C}$ , respectively, fish were rejected earlier by panelists than their *K* value indicated. The authors found that fish stored at  $8^\circ\text{C}$  and  $20^\circ\text{C}$  became unsafe for human consumption, reaching unacceptable histamine levels after 4 and 1 day, respectively [31].

Some volatile compounds that have been isolated from spoiling fish muscle are ethyl mercaptan, methyl mercaptan, dimethyl sulfide, hydrogen sulfide, acetaldehyde, propionaldehyde, diacetyl ethanol, methanol, acetone, acetoin, butanal, methyl butanal, and ethanal [30]. Selected volatile compounds in spoiling fish and their probable sources are compiled in Table 6.3.

#### 6.2.3.4 Physiological (Internal) Factors: Lipid Oxidation and Hydrolysis

Lipid oxidation is a major cause of quality deterioration in fish and seafood due to lipid content and the extent of polyunsaturation [30,32]. Catalysts for lipid oxidation are molecular and singlet oxygen, metals

**TABLE 6.3**

Selected Volatile Compounds and Their Probable Source in Spoiling Fish

Compound	Probable Source
Hydrogen sulfide	Cysteine
Dimethyl sulfide	Methionine
Methyl mercaptan	Methionine
Acidic, propionic, butyric, and hexanoic acid esters	Glycine, leucine, serine
Trimethylamine	Trimethylamine oxide
Dimethylamine	Triethylamine oxide
Ammonia	Urea, various amino acids

Source: J. Liston, *Chemistry and Biochemistry of Marine Food Products* (R. E. Martin et al., Eds.), AVI Publishing, Westport, CT, 1982, p. 27.

such as iron and copper, and enzymes such as lipoxygenase [23]. The postmortem changes in fish muscle related to lipid oxidation are [32]

1. Decrease in ATP
2. Increase in ATP breakdown products, e.g., hypoxanthine
3. Changes in xanthine dehydrogenase to xanthine oxidase
4. Loss of reducing compounds, e.g., ascorbate and glutathione
5. Increase in content of low-molecular-weight transition metals
6. Conversion of heme (Fe (II)) pigments into oxidized form (Fe (III))
7. Loss of structural integrity of membranes
8. Loss of antioxidants in membranes, e.g., tocopherols
9. Inability of the muscle cell to maintain calcium gradients

These changes make the tissue more susceptible to oxidation, especially through changes in membranes. In addition, size reduction, such as fillets and minces, can enhance lipid oxidation by exposing more lipid to oxygen. The destruction of antioxidants such as tocopherols by heat, enzymes, and salts also plays an important role in lipid oxidation [23]. The glutathione peroxidase activity is located in various fish muscles and presumably protects the muscle from oxidative deterioration of lipid during storage and processing [33]. Nakano et al. [34] reported that glutathione peroxidase increased significantly during storage, which suggested that the increase in enzyme activity could protect fish muscles from oxidative deterioration during storage and processing. Watanabe et al. [33] reported that total glutathione peroxidase activity in Japanese jack mackerel and skipjack tuna fish muscles decreased gradually during storage at 4°C.

Technological approaches to minimizing lipid oxidation that are applicable to fish and seafoods include [23]

1. Reducing oxygen access to the product through controlled-atmosphere (CA) storage and modified-atmosphere (MA) packaging (e.g., vacuum packaging, edible coating)
2. Maintaining natural antioxidants or adding antioxidants
3. Minimizing increases of pro-oxidants (e.g., iron)
4. Maintaining low temperatures through cool- and cold-chain management
5. Minimizing salt constituents
6. Removing unstable lipids (e.g., subcutaneous fat) and dark muscle, which contains more fat

## 6.2.4 Physicochemical Manifestations of Spoilage in Fish and Seafood

When fresh fish and seafood products undergo improper handling and spoilage, certain changes occur in both the appearance and chemical composition, which can be readily quantified. Proper understanding of these changes is important for early detection and isolation of affected produce. These manifestations of spoilage are largely sensory in nature.

### 6.2.4.1 Color Changes

Quality loss of fish muscle after harvest may take the form of color (appearance) changes. Fresh fish has a translucent appearance due to even scattering of incident light. With an increase in spoilage, there is a gradual disintegration of myofibrils, resulting in their wider and more random intracellular distribution. The fish surface then appears opaque because the incident light is unevenly scattered [27,35].

Changes in fish flesh color occur during low-temperature and freezing storage. The flesh becomes yellow due to oxidation of carotenoid pigments and lipids in tissues. Other factors that may result in yellowing are lipid oxidation and reactions with carbonyl amines. The red color changes in Whole Orange Roughy during ice storage are shown in Table 6.4 [27].



**TABLE 6.4**

Color Changes Appearance of Gills in Whole Orange Roughy Stored in Ice

Storage (Days)	Color Changes	Appearance of Gills
0	Red/Orange	Dark red
4	Red/Orange	Dark red
6	Orange on fins, head, and tail	Dark red
9	Slightly blotched, body faded	Dark red, slightly milky slime
11	Blue steel-gray with tinges of orange	Brown/red or bleached, sticky, creamy, slime
13	Bleached pale gray or blue tail with head pale orange	Brown/red or bleached with brown slime on gills
16	Washed-out gray/blue with pale head	Brown or bleached with brown slime

Source: N. Scott et al., *J. Food Sci.* 57:79, 1986.

The factors affecting pigment loss are as follows:

1. Myeloperoxidase from fish leukocytes causes rapid discoloration of  $\beta$ -carotene in the presence of hydrogen peroxide and iodide or bromide ions due to the breakage of double bonds.
2. Free radicals addition, free radical abstraction, or singlet oxygen addition to the double bonds of  $\beta$ -carotene.
3. Temperature and concentration of storage oxygen.
4. Progressive increase in pH from 7 to 8 during storage: potassium  $\beta$ -oxyacrolein, the enolic salt of malondialdehyde, formed self-condensation reactions and polymerized at pH 7–8 to form fluorescing compounds [27]. The appearance of surface slime on Whole Orange Roughy as a function of storage duration in ice is shown in Table 6.5.

**TABLE 6.5**

Appearance of Surface Slime on Whole Orange Roughy Stored in Ice

Storage (Days)	Color and Consistency of Surface Slime
0	No slime
4	Clear slime
6	Clear or slightly cloudy slime
9	Clear or slightly cloudy slime
11	Clear or slightly cloudy slime
13	Brown slime on body
16	Thick yellow slime

Source: N. Scott et al., *J. Food Sci.* 57:79, 1986.

### 6.2.4.2 Texture Changes

Fresh fish has characteristic firmness, which can be rapidly assessed subjectively by handfeel, and objectively by instrumental test and sensory panel taste. During postharvest handling and storage, the texture of fresh fish changes from “firm” and “moist” to “mushy” and “runny.” These textural changes occur due to tissue softening as a result of myofibrillar disintegration and weakening of connective tissue. During storage, the spoiling intracellular and extracellular proteases degrade myofibrillar proteins [27]. The loss of firmness and resilience and development of unpleasant odors and flavors are some of the quality changes that occur in fish and seafood after harvest. The changes in texture and odor of Whole Orange Roughy stored in ice for 16 days are shown in Table 6.6. The sensory changes of white fish are presented in Table 6.7. Manifestations of quality degradation and spoilage of stored fish muscle may take the form of excessively soft tissue, loss of liquid-holding capacity, and development of a dry or rough texture upon cooking [36].

Postmortem tenderization of fish muscle is one of the major problems related to fish freshness and its quality [37]. The causes of postmortem tenderization postulated so far are as follows [1]:

1. A weakening of rigor between myosin and actin as seen by the decrease of  $Mg^{+}$ -ATPase activity
2. Breaking down of Z-disk structure of myofibrils
3. Degradation of titin [37]

Ando et al. [38] also suggested that postmortem tenderization of fish muscle is closely related to the gradual disintegration of the extracellular matrix structure after death. The weakening of the Z-line

**TABLE 6.6**

Changes in Odor and Texture of Whole Orange Roughy Stored in Ice

Storage (Days)	Odor Changes in Gills	Texture Changes in Flesh
0	Slightly seaweedy	Firm and resilient
4	Slightly seaweedy	Firm and resilient
6	Mild and sweet	Firm and resilient
9	Fish meal, sweet, salty, briny	Firm and resilient
11	Sweet, salty, mussel, soapy, oily	Retains finger indentation, no gaping, slightly soft
13	Metallic, stale, seaweedy, and slightly rotting odors	Retains finger indentation, soft
16	Strong rotting and putrid	Retains finger indentation, no gaping, soft

Source: N. Scott et al., *J. Food Sci.* 57:79, 1986.

**TABLE 6.7**

Sensory Changes in White Fish

Quality	Score	Raw		Cooked	
		Gill Odor	General Appearance	Odor or Flavor	Texture
Fresh	10	Seaweedy, sharp metallic	Convex eyes, shiny red blood, flesh translucent	Slight sweet/meaty	Dry
Spoiling	7	Bland, loss of tanginess	Eyes flat, dull skin, no translucence	Bland/neutral	Firm/succulent
Stale	5	Milky, mousy, yeasty	Sunken eyes, browning of gills, opaque mucus, waxy flesh	Some amines	Softening
Putrid	3	Acetic acid, old boots odor, sour sink	Eyes sunken, yellow flesh, brown blood, yellow bacterial lime	Bitter, sulfites	Mushy

Source: M. Gibson, *Shelf Life Evaluation of Foods* (C. M. D. Man and A. A. Jones, Eds.), Blackie Academic & Professional, London, 1994, p. 72.

depends on a proteolytic mechanism, which removes  $\alpha$ -actinin from this structure by the action of a calcium-dependent neutral proteinase: calpain [37]. In addition, other myofibrillar proteins such as titin and nebulin are also implicated in postmortem weakening of fish [39] and meat muscle [40]. Papa et al. [37] studied  $\alpha$ -actinin release and its degradation from myofibril Z-line in postmortem white dorsal muscle from bass and sea trout stored at 4°C and 10°C. Using  $\alpha$ -actinin-specific antibodies, they showed that this protein is rapidly released within the first 24h for the two specific species and reaches a plateau within 4 days. The release and proteolysis of  $\alpha$ -actinin are time- and temperature-dependent processes that take place at the early stages of fish storage. The proteolysis of  $\alpha$ -actinin seems to be dependent on fish species.

In fish intramuscular connective tissue, type I and V collagens are present. Sato et al. [41] demonstrated that type V collagen was solubilized specifically in softened rainbow trout muscle. Similarly, type V collagen became solubilized in softened sardine muscle after 1 day of chilled storage, whereas tiger puffer muscle did not show significant softening, changes in structure of connective tissues, or biochemical properties of collagens [41]. This was due to the presence of more type I collagen in tiger puffer muscle than in sardine, carp, and mackerel [41]. Thus, degradation of type V collagen caused disintegration of the tin collagen fibrils in pericellular connective tissue, weakening pericellular connective tissue, resulting in postharvest softening. Similarly, Tachiban et al. [42] reported that the degradation of Z-disks of ordinary muscle was faster in culture red sea bream than in the wild counterpart.

This liquid-holding capacity of muscle is highly influenced by fibril swelling/contraction and the distribution of fluid between intra- and extracellular locations [43]. Moreover, changes in muscle structure are an important factor. Changes in muscle structure are strongly influenced by temperature, ionic

strength, and chemical composition due to season, and maturation of muscle and pH. Ofstad et al. [36] concluded that the liquid-holding capacity of raw fish seemed to be dependent on two main factors: genetic differences in muscle protein and the postmortem muscle pH and subsequent time-dependent muscle degradation. They found that salmon muscle possessed much better liquid-holding properties than the cod muscle, as did wild cod better than fed cod regardless of the storage time. The myofibrils of the salmon muscle were denser, and fat and a granulated amorphous material filled the intra- and extracellular spaces. The denaturation characteristics of myosin, actin, and a sarcoplasmic protein differed between salmon and cod, indicating the stability of the myosin–actomyosin complex. Postmortem degradation of the endomysial layer and the sarcolemma may further facilitate the release of liquid. Thus, the release was related to species-specific structural features and better stability of the muscle proteins. The severe liquid loss of fed cod was due to a low pH-induced denaturation and shrinkage of the myofibrils [36].

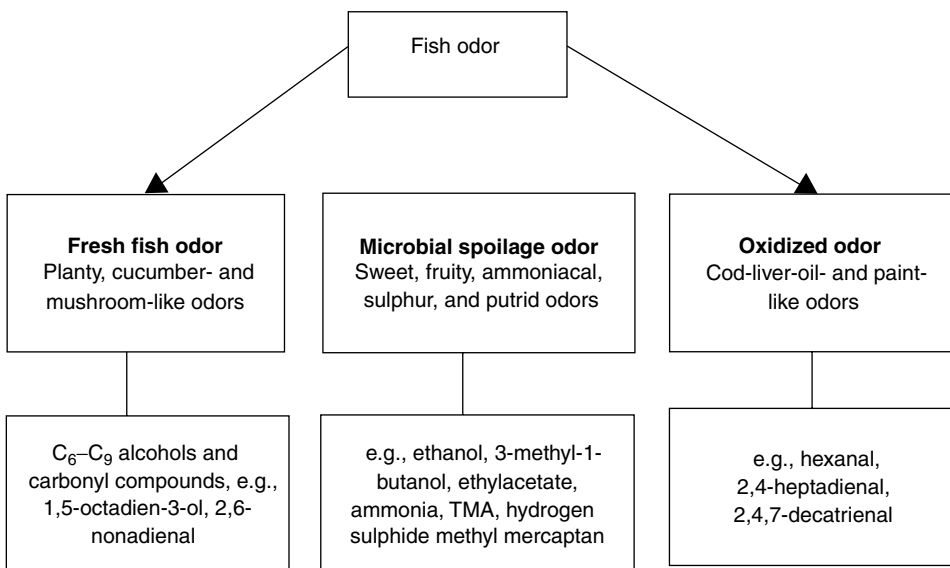
Holes and slits appear between the myotomes (muscle segments) because of breakage of the minute tubes of connective tissue from the myocommata (connective tissue sheets) and run between and around the muscle cells. This phenomenon is known as gaping in the musculature of fish [44]. Love and Haq [44] found that a low pH leads to much gaping and vice versa. At a given temperature, the gaping increased with time, and subsequent freezing increased it further.

### 6.2.4.3 Odor Changes

As indicated earlier, the release of volatile compounds is one of the important indicators of freshness and spoilage of fish and seafood. Olafsdottir et al. [7] classified the volatile compounds contributing to fish odor into three groups based on origin, as shown in Figure 6.2. There is increasing interest on the importance of rapid measurement of volatile compounds in fresh fish and seafood as objective indicators of freshness. Several authors have reported the traditional methods that rely on classical chemical analysis for the study of total volatile bases and TMA in fish [27,40,45–48]. Future measurement innovations in this area appear to focus on the development of electronic noses [49,50].

### 6.2.4.4 Protein Changes

Proteins in fish and seafood are subjected to significant changes during postharvest handling, storage (both ice and uniced), and processing. The proteinases are responsible for changes, such as hydrolysis,



**FIGURE 6.2** Categorization of fish odors and the volatile compounds that contribute to the characteristic odor of fresh, spoiled, and oxidized fish. TMA, trimethylamine. (From G. Olafsdottir et al., Methods to evaluate fish freshness in research and industry, *Trends Food Sci. Technol.*, 8:258–265, 1997.)

**TABLE 6.8**

Types of Proteases and Their Inhibitors

Protease	Inhibitor
Serine protease	Phenylmethyl sulfonyl fluoride Diisopropyl fluorophosphate
Thiol protease	Heavy metal iodoacetamide <i>N</i> -ethyl maleimide Anipain Leupetin
Metalloprotease	EDTA <i>O</i> -Phenanthroline 8-Hydroxyquinoline
Acid protease	Pepstain Diazoacetyl norleucine methyl ester Epoxy ( <i>p</i> -nitrophenoxy) propane

Source: V. Venugopal, *J. Food Protect.* 53:341, 1990.

which can result from animal or from spoilage microflora especially during later stages of spoilage [35]. The types of proteases and their inhibitors are shown in Table 6.8. The solubility of proteins during washing increased when fish were held for a longer time and at higher temperatures. This is because the degradation of myosin heavy chain and actin increased rapidly at longer storage times and/or elevated temperatures, resulting in a higher loss of total protein during washing. Lin and Park [51] studied the effect of postharvest storage temperatures and duration on proteolysis of Pacific whiting. Myosin heavy chain degraded rapidly during postharvest storage at low temperatures (0°C–5°C), and greater degradation occurred at elevated temperatures. Actin degradation was similar to that of myosin heavy chain, but

to a lesser degree. Degradation of both was highly correlated to protein solubility. Low temperatures reduced, but did not completely inhibit proteolysis [51].

It is well established that the myofibrillar proteins differ in stability depending on the habitat temperature of the species [52]. During iced and frozen storage, the thermal characteristics of myosin subunits deteriorate faster in cold- than in warm-water fish [53,54]. Venugopal [55] studied the sites of attack by proteases on protein and found that the points of cleavage for carboxypeptidase, aminopeptidase, endoprotease, and proteinase were carboxyl-terminal, amino-terminal, and internal peptide bonds, respectively.

Large amounts of glycogen in mammalian muscle can result in a low final pH. The higher the post-mortem temperature, the quicker is the onset of rigor, the shorter its duration, and the more severe the contraction. However, if meat is chilled below about 13°C soon after death, severe contraction takes place almost immediately, resulting in permanent toughening of the meat. This is cold shortening [20].

## 6.3 Postharvest Treatments and Preservation of Fish and Seafood

### 6.3.1 Introduction

Maximum freshness of harvested fresh produce such as fish and seafood occurs immediately after harvest [56]. Beyond harvest, the adoption of improved handling systems, maintenance of cold/cool chain, and application of appropriate physical and biochemical treatments are necessary to reduce the incidence of losses, preserve/maintain quality, and extend storage and shelf life. Warm- and cold-water fish do not always respond in the same way to postharvest handling practices and may often need different treatments to achieve the desired results [20]. Unlike meat, global fish harvest destined for marketing is still largely hunted traditionally, although the contribution of farmed fish (aquaculture) is increasing rapidly, particularly in Asia [1]. This approach gives limited scope for manipulating the immediate pre- and postmortem conditions. In the case of cold-water fish, higher temperatures accelerate the onset and resolution of rigor as in meat, but without resulting in cold shortening. This may be due to the fact that fish function normally at temperatures below 5°C. Another difference between the handling and preservation techniques of fish and animal meat is that fish never seem to attain such low pH values as are sometimes encountered in meat.

### 6.3.2 Improvement of Harvesting and Postharvest Handling Systems

Fish and seafood quality is affected by harvesting and postharvest handling techniques and equipment used. Improper harvesting and containerization may result in physical injuries such as bruising, cuts, and abrasion. It is also important that steps are taken to land the catch as soon as possible after harvest

because the physiological processes that result in spoilage commence immediately. To reduce the incidence of physical damage, harvesting equipment and containers must be checked regularly to avoid the presence of sharp edges. Avoiding excessive loading of fish on top of each other or overfilled boxes of fish, particularly the large fish species such as tuna and kingfish, can reduce compression damage. During transportation from catch to landing sites, fish and seafood products need protection against direct sunlight and heat, particularly in tropical and subtropical environments where rapid increases in air temperature can occur in short time. Throwing fish into containers or onto heaps should be avoided due to increased susceptibility to handling damage and subsequent spoilage.

Hanpongkittikun et al. [57] demonstrated the importance of good harvesting practices on seafood quality. The authors identified *Staphylococcus aureus*, *Salmonella*, and *Vibrio parahaemolyticus* from shrimp sample during ice storage. Using sample taken from controlled harvesting and open market, the authors found that controlled-harvested shrimp had a shelf life of 8 days, while samples from the open market had only 4 days of shelf life.

### 6.3.3 Prestorage Treatments

Pretreatment of fish and seafoods immediately after harvest and landing is necessary to improve sanitation and remove the inedible portions that would otherwise contribute to accelerated aging and spoilage. Pretreatments such as washing and cleaning also reduce contamination of physical debris and microbial organisms, which pose health and safety hazards to the consumer. Furthermore, gutting and bleeding are typical primary preprocessing treatments that are commonly carried out on fresh fish and some seafood.

Fish may be bled and gutted (i.e., their intestines removed) prior to subsequent handling storage. Depending on the end use and market requirements, fish head may also be removed. Gutting is essential for some specifics, as otherwise the digestive enzymes and the bacteria in the gut would soon attack the flesh. In some species, this may not be necessary owing to the anatomical location of the gut cavity relative to the edible parts [19]. It is customary to wash fish to remove blood and any remnants of guts. However, washing can remove some of the natural antimicrobial secretions and may not be advantageous to the storage life [19].

The limited efficacy of heat treatments directly applied to whole fish by hot water immersion or wash is probably due to slow heat penetration and changes in microflora interactions [58]. Vaz-Pires and Kirby [78] took 80 bacterial isolates from sea scad to study their heat stability and found *Shewanella colwellinia* to be more heat resistant. The main target site of damage of the heat treatment tested in their experiments was the cell wall. Good hygiene practices are also needed to reduce the possibility of contamination of fish and seafood products. This is achievable on land but is more difficult onboard fishing vessels [19].

### 6.3.4 Cold/Cool Chain Technology

Rapid removal of field heat after harvest and maintenance of the cold/cool chain is the effective strategy for fish and seafood preservation and quality maintenance. Most fish are chilled with ice soon after harvest unless they are destined only to nearby local markets. Researchers have demonstrated that the importance of rapid chilling cannot be overemphasized [19]. Chilling reduces the rate of chemical and biochemical changes as well as microbial growth. The temperature at which fish and seafood materials live is relatively low, thus chilling does not have a great effect on the chilling of meat from warm-blooded animals [19]. Ice is a very good coolant. It is also cheap, and it must be made from clean, unpolluted, and bacteria-free water. Chilling generally reduces the temperature of fish to 0°C [19]. Chilling to 0°C in ice or refrigerated compartments is an essential requirement for quality retention in most fish and seafood products. For longer storage period, fish and seafood may also be frozen. From a microbial standpoint, storage at -2°C to -4°C is better than at 0°C or 2°C-5°C; however, this is not necessarily the case from a quality perspective due to toughening and autolytic changes which occur at the lower temperatures such as lipid hydrolysis. Shelf life may be extended further through the use of sorbate or sulfite [23]. The shelf life of selected types of raw fish as a function of temperature is shown in Table 6.9.

In experiments with fish during ice storage, the penetration of microorganisms occurred primarily from the intestines, the skin flora being found in the flesh only during the later stages of spoilage (8-17 days depending on species) [59,60]. It was also observed that the quality and keeping time of the trout was

**TABLE 6.9**

Approximate Shelf Life of Selected Types of Raw Fish at Different Temperatures

Fish	Temperature (°C)	Shelf Life (Days)
Cod	0	16
	5	7
	10	4
	16	1
Herring	0	10
	5	4
Salmon	0	2
	10	5
Plaice	0	18
	10	8

Source: M. Gibson, *Shelf Life Evaluation of Foods* (C. M. D. Man and A. A. Jones, Eds.), Blackie Academic & Professional, London, 1994, p. 72.

reduced when the fish was exposed to physical stress. The infection level in the fish muscle increased with increasing physical stress and was higher for feeding than for starving trout [61]. When getting the fish, it was observed that the intestines appeared pale and bloodless in the treated samples. This could be the result of a stress condition, which increased the production of adrenalin, thus forcing the blood into muscles and gills. There are good correlations between the log count and the organoleptic score when the bacteria count was higher than 100 per gram. Herborg and Villadsen [61] mentioned that the lack of correlation at lower bacterial counts may be expected, since autolytic spoilage processes will be more active in the earlier storage period and will be the dominant factor influencing organoleptic assessment.

### 6.3.5 Chemical Treatments and Use of Biopreservatives

A wide range of chemical treatments and living cultures of bacteria have been used in commercial practice or proposed by researchers for mitigating the deleterious effects of abiotic, biotic, and physiological factors that cause spoilage in fish and seafood. The principal chemical agents used are chlorine and hydrogen peroxide.

#### 6.3.5.1 Chlorine and Chlorine Dioxide

Lin et al. [62] found that a commercial chlorine dioxide killed *Escherichia coli*, *Listeria monocytogenes*, and its streptomycin-resistant strain at 15, 10, and 7.5 ppm. The authors also reported that aqueous chlorine dioxide was more effective than aqueous chlorine in killing *L. monocytogenes* on fish cubes and in washed-off solutions. Fish cubes treated with aqueous chlorine showed no visual changes in color. Treated solutions became lightly milky. A light brown color occurred on fish cubes treated with aqueous chlorine dioxide at 400 ppm. The treated solutions had a light pink (40 and 100 ppm) to light yellow (200 and 400 ppm) color, with some turbidity. The fish cubes treated with aqueous chlorine or chlorine dioxide contained no detectable chlorine residues, but commercial chlorine dioxide solution showed chlorite and some free and combined chlorine, especially at 200 and 400 ppm.

#### 6.3.5.2 Hydrogen Peroxide

Dipping in hydrogen peroxide solution can increase the shelf life of fish. Hydrogen peroxide acts as a preservative as well as a bleaching agent, thus yielding a higher quality product with an extended shelf life. A major point of concern had been that hydrogen peroxide treatments could lead to excessive oxidative rancidity, thereby causing a marked decrease in the overall quality of product [63]. Sims et al. [63] reported that hydrogen peroxide was entirely dissipated in the flesh within 0.5 h when raw herring were immersed in dip solutions containing up to 600 ppm hydrogen peroxide. The color observations carried out on samples from the treatments indicated that the fillets with hydrogen peroxide were considerably whiter than those of untreated fillets.

#### 6.3.5.3 Lactic Acid Bacteria

The addition of living cultures of lactic acid bacteria is used to control pathogen growth in fish. *L. monocytogenes* is difficult to control in lightly salted (<6% NaCl in aqueous phase) fish products, pH >5, and storage temperature ~5°C. Wessels and Huss [64] noted that *L. monocytogenes* in lightly preserved fish products can be controlled using food-grade lactic bacteria. The effect was not due to lactic acid inhibition, but because of the production of the natural preservative nisin by the lactic acid bacteria. Sodium

chloride solution up to 4% allowed for efficient growth and nisin production, while 5% sodium chloride resulted in very slow growth and no detectable nisin.

### 6.3.6 Enzyme Inhibitors

The tenderization or flesh softening of seafood has generally been attributed to the activity of endogenous muscle proteases in the postmortem animal. The undesirable postmortem activities of these enzymes have been controlled by low-temperature and chemical treatments [65]. The use of plasma glycoprotein and  $\alpha_2$ -macroglobulin (the active component in egg white plasma hydrolysates) can be used to inhibit several endogenous proteases [66].  $\alpha_2$ -Macroglobulin noncompetitively inhibited the proteases in decreasing order: cathepsin D > trypsin > chymotrypsin > collagenase. The inhibitor's activity depended on the size of the substrate molecule, the size of the enzyme, and the relative specificity of the enzyme. Thus, it could control desirable proteolytic activities. In intact fish and other muscle foods, it may be restricted to tissue penetration due to membrane barriers and the relatively large molecular size of the inhibitor. Proteases in surimi and other minced muscle foods should be readily inhibited by it. The activity did not seem to be adversely affected by low temperatures (4°C–7°C) [65].

Prawns develop blackspot (melanosis) in chilled and frozen storage, and sulfite is a reducing agent used to prevent this discoloration. The presence of sulfite reverses the formation of colored compounds (quinones) and in addition acts as a competitive inhibitor of polyphenol oxidase, the enzyme that causes the production of the pigment melanin [67,68]. Recently, it was reported that 4-hexylresorcinol binds irreversibly to polyphenol oxidase, inhibiting its action [69]. The likelihood of adverse reactions in humans from the low levels found in prawns was considered slight [70]. Sensory panel assessment found no effect on the taste, texture, visual appearance, and development of normal colors after cooking by treating prawns with 4-hexylresorcinol. Slattery et al. [70] used Everfresh® (which contains 4-hexylresorcinol) to inhibit polyphenol oxidase in trawled and farmed prawns. In comparison with sodium metabisulfite treatment, Everfresh (0.2% 4-hexylresorcinol) provided greater protection against blackspot, particularly on the body of the prawn during storage in ice, in refrigerated seawater, and in ice after frozen storage. When Everfresh was used according to the manufacturer's recommendations, residues of 4-hexylresorcinol were less than 2 µg/g in prawn flesh.

### 6.3.7 The Role of Packaging Technology

Proper packaging plays a crucial role in preservation of quality and delivery of safe, wholesome fish, and seafood products to the end user. Packaging performs three main functions, namely containment, protection, and information. With regard to fresh fish and seafood, packaging must be carefully selected to cope with the presence of water on fish skin, a condition that could contribute to breakdown of paper-based packaging as well as rapid microbial contamination. Packaging must also be selected to protect against adverse environmental and atmospheric condition as well as penetration of physical and chemical hazards. To facilitate supply chain management and marketing operations, adequate labeling of the package is essential to inform and educate the end user about the content and utility. Given the high perishability of fish and seafoods, only blemish-free and top-quality produce should be contained in the package.

Innovative packaging technologies based on manipulating the gas-exchange characteristics of packaging material to control the oxido-reduction potential have been developed and applied to preserve and extend the storage stability of fish and seafood products. The application of vacuum packaging, CA or MA packaging around fresh fish is based on the following premise: some spoilage bacteria and lipid oxidation require oxygen—thus, reducing the oxygen around the fish will increase storage and shelf life. Depending on the fish species and intended end use, specific combinations of O<sub>2</sub>, CO<sub>2</sub>, and N<sub>2</sub> determine the level of CA or MA. In practice, vacuum packaging, CA storage, and MA packaging are used in combination with refrigerated storage for preservation of fish and seafood products. The combination of methods must be optimized and closely evaluated to match specific requirements.

### 6.3.8 Irradiation Treatment

Gamma radiation is considered an innovative and interesting method to preserve chilled, stored fish and also reduce microbial populations in fresh fish and fish products [71–75]. Several researchers

have reported increases in storage times of 1–3 weeks for fresh and cooked product and doubling of storage times for frozen products [76]. Several authors [77,79] have noted that irradiation doses of 2–7 kGy can reduce important pathogens in food such as *Salmonella*, *Listeria*, and *Vibrio* spp., including many of the fish-specific pathogens like Pseudomonaceae and Enterobacteriaceae, which can be significantly reduced in number.

The application of irradiation treatment in fish and seafood must be viewed as part of an integrated quality and safety management, incorporating good manufacturing practice (GMP) and hazard analysis and critical control points (HACCP). Thus, the fish destined for irradiation must be in good quality, free from defects, and handled properly prior to and after irradiation. It is only under these conditions, with good irradiation practices, that most pathogenic microorganisms can be eliminated, and spoilage bacteria can be sufficiently reduced so that significant increases in storage time can be achieved.

Irradiation doses between 0.75 and 1.5 kGy for fresh products and cooked products and between 2 and 5 kGy for frozen foods have been recommended [76]. Marcotte [76] did not consider these doses to be sufficient enough to control spore-forming bacteria such as *C. botulinum* type E. Furthermore, it was noted that irradiation does not eliminate the toxins produced by *S. aureus* and others, and consequently, the author cautioned that whether irradiated or not, fish and shellfish must be properly processed and stored cold (<3°C) or in ice, or frozen. Other researchers have reported that fish may be irradiated at doses of 3–4 kGy, without appreciable increase in temperature during irradiation [72], and without affecting odor and taste, thus increasing the storage life of the product by two to threefold [75].

In a recent study to determine the effect of <sup>60</sup>Co gamma irradiation on Atlantic horse mackerel—a highly perishable fish species abundant off the coasts of Portugal and Spain and an important component of diet in these countries—Mendes et al. [71] applied two levels of irradiation (1 and 3 kGy). Irradiated and unirradiated (control) fish were stored in ice for 23 days after which a series of chemical tests of spoilage were carried out. The authors found that a dose of 1 kGy appeared adequate to extend the shelf life of the fish by 4 days, and increasing the dose to 3 kGy did not give appreciable additional benefits in terms of quality attributes. No detrimental effect on the quality of fish by irradiation was evident.

---

## 6.4 Future Prospects for Fresh Fish and Seafood Preservation

Fish and other marine products are important sources of food throughout the world and in particular for over 1 billion people as the main source of protein. Global consumption of fish is rising steadily and has doubled since 1973 [1]. Current estimates project that the demand for fish will continue due to increasing population growth and increasing purchase as a result of further realization of the health and nutritional benefits of fish diet. However, serious concerns have been raised about the ecological effects of industrialized fishing and the resultant rapid worldwide depletion of predatory fish communities [80]. This scenario has propelled aquaculture (the farming of fish, shellfish, and seaweeds) as the fastest growing sector in global food production.

Despite the growing demand and importance of fish and seafood in the human food system, the incidence of postharvest losses, quantitatively and qualitatively, remains high, especially among many rural fishing communities. Reducing fish losses and preserving its quality over extended storage period will contribute toward improved food security and income without the need for additional catches to meet growing demand. Unlike the situation for red meat and poultry, the fact that majority of food fish and seafood are “hunted” in the oceans and seas presents additional technical challenges to adequately control quality deterioration and preserve the produce. Thus, improved harvesting techniques and procedures are needed that reduce the time lag between catch and landing to avoid unacceptable losses in quality (and quantity) prior to handling and processing.

High consumer preference for fish in fresh form (as opposed to processed product) assures future demand for innovative treatments and preservation techniques that maintain freshness and optimum eating quality over extended period of time. Continuing research is also needed to develop low-cost, portable, nondestructive devices for rapid measurement of freshness. Such a device will be useful for research as well as use by quality control personnel responsible for enforcing relevant regulations and directives on fish quality standards and marketing.



---

## References

1. C.L. Delgado, N. Wada, M.W. Rosegrant, S. Meijer, and M. Ahmed, The Future of Fish. Issues and Trends to 2020. IFPRI, 2003, 6pp.
2. C.L. Delgado and C. Courbois, Changing fish trade and demand patterns in developing countries and their significance for policy research. MSSD Discussion Paper No. 18, IPFRI, Washington, DC, 1997, 23pp.
3. C.L. Delgado and A. McKenna, Demand for fish in Sub-Saharan Africa: The past and future. Naga, *The ICLARM Quarterly XX* (July–December):8–11, 1997.
4. Food and Agriculture of the United Nations, The State of World Fisheries and Aquaculture 1996, Rome, 1997.
5. C.L. Delgado, N. Wada, M.W. Rosegrant, S. Meijer, and M. Ahmed, Fish to 2020. Supply and Demand in Changing Global Markets. IFPRI and World Fish Centre, 2003, 226pp.
6. Z.E. Sikorski, 2005. Fish. <http://greenplanet.colss.net> (accessed 23 May, 2005).
7. G. Olafsdottir, E. Martinsdottir, J. Oehlenschlager, P. Dalgaard, B. Jensen, I. Undeland, I.M. Mackie, G. Henehan, J. Nielsen, and H. Nilsen, Methods to evaluate fish freshness in research and industry, *Trends Food Sci. Technol.* 8:258–265, 1997.
8. J. Codd, Fish Oils in Functional Foods, F-FE 363/00. <http://www.flair-flow.com/industry-docs/ffe36300.htm> (accessed 12 September, 2005).
9. L.U. Opara and S.M. Al-Jufaili, Quantification of fresh fish losses during postharvest handling in the Sultanate of Oman. In *Proceedings of the International Conference on Postharvest Technology and Quality Management in Arid Tropics* (Opara et al., Ed.), 31 January–2 February, Sultan Qaboos University, 2005, pp. 123–130.
10. T.W. Bostock, Marine fisheries of Gujarat: Postharvest losses and possibilities for development. Report of the Tropical Development and Research Institute, London, 1987.
11. J. Esser, Remedial measures reduce losses, *Seafood Int.* Sept. issue, 18:105–109, 1991.
12. A.W. Sifuna and O. Makogola, Levels and causes of fish postharvest losses: A case study of Nyakach Bay in the months of August and September 2000. Fisheries Department Kisumu, Kenya, 2000.
13. R.A. Cheke and A.R. Ward, A model for evaluating interventions designed to reduce postharvest fish losses, *Fisheries Res.* 35:219–227, 1998.
14. D.G. James, The prospects for fish for the malnourished, *Food Nutr.* 12:20–30, 1986.
15. L. Ababouch, Postharvest changes in fish. Fish Utilization and Marketing Service, FAO, Rome, 2005.
16. Lake Victoria Environment Management Program, LVEMP Final Report. Lake Victoria, Kenya, 1996.
17. MNE. 2001. Development of the Economic Diversification Sectors. Vol. III, December (Shawwal 1422 AH). Ministry of National Economy, Muscat, pp. 1–174.
18. S.M. Al-Jufaili and L.U. Opara, Modelling quality loss of fresh fish in the Sultanate of Oman. ASEAN Symp, KMUTT, 2005.
19. M. Gibson, Preservation technology and shelf life of fish and fish products. In *Shelf Life Evaluation of Foods* (C.M.D. Man and A.A. Jones, Eds.), Blackie Academic & Professional, London, 1994, p. 72.
20. G. Poulter, R.W.H. Parry, and E.C. Blake, Recent advances on the effect of immediate post mortem handling on the quality and yield of tropical fish. In *Food Science and Technology in Industrial Development* (S. Maneepun, P. Varangoon, and B. Phithakpol, Eds.), Institute of Food Research and Product Development, Bangkok, 1988, p. 1001.
21. T. Suzuki, State of water in sea food. In *Water Activity: Influences on Food Quality* (L.B. Rockland and G.F. Stewart, Eds.), Academic Press, London, 1981, p. 743.
22. M.V. Blanshard and W. Derbyshire, In *Water Relations of Food* (R.B. Duckworth, Ed.), Academic Press, London, 1974, p. 568.
23. K.A. Buckle, Postharvest technology of seafood products. In *Postharvest Technology for Agricultural Products in Vietnam* (B. Champ and E. Highley, Eds.), ACIAR Proceedings No. 60, Australian Centre for International Agricultural Research, Canberra, 1995, p. 128.
24. J.M. Shewan, The microbiology of fish and fishery products – a progress report, *J. Appl. Bacteriol.* 34:299, 1970.
25. T. Saito, K. Arai, and M. Matsuyoshi, A new method for estimating the freshness of fish, *Bull. Jpn. Soc. Sci. Fish.* 24:749, 1959.
26. R. Jerret, J. Stevens, and A.J. Holland, Tensile properties of white muscle in rested and exhausted chinook salmon (*Oncorhynchus tshawytscha*), *J. Food Sci.* 61:527, 1996.

27. J.W. Colby, L.G. Enriquez-Ibarra, and G.J. Flick, Shelf life of fish and shellfish. In *Shelf Life Studies of Foods and Beverages* (G. Charalambous, Ed.), Elsevier Science Publishers B. V., Amsterdam, 1993, p. 85.
28. L. Gram, G. Trolle, and H. Huss, Detection of specific spoilage bacteria from fish stored at low (0°C) and high (20°C) temperatures, *Int. J. Food Microbiol.* 4:65, 1987.
29. H. Huss, Development and use of the HACCP concept in fish processing, *Int. J. Food Microbiol.* 75:33, 1992.
30. J. Liston, Recent advances in the chemistry of iced fish spoilage, In *Chemistry and Biochemistry of Marine Food Products* (R.E. Martin, G.J. Flick, and D.R. Ward, Eds.), AVI Publishing, Westport, CT, 1982, pp. 27–38.
31. N. Guizani, M.A. Al-Busaidy, I.M. Al-Belushi, A. Mothershaw, and M.S. Rahman, The effect of storage temperature on histamine production and the freshness of yellowfin tuna (*Thunnus albacares*), *Food Res. Int.* 38:215–222, 2005.
32. O. Hultin, Oxidation of lipids in seafoods. In *Seafoods: Chemistry, Processing Technology and Quality* (F. Shahidi and J.R. Botta, Eds.), Blackie Academic, London, 1994, p. 49.
33. F. Watanabe, M. Goto, K. Abe, and Y. Nakano, Glutathione peroxidase activity during storage of fish muscle, *J. Food Sci.* 61:734, 1996.
34. T. Nakano, M. Sato, and M. Takeuchi, Glutathione peroxidase of fish, *J. Food Sci.* 57:1116, 1992.
35. F. Haard, *Advances in Seafood Chemistry: Composition and Quality* (G.J. Flick and R.E. Martin, Eds.), Technomic Publishing, PA, 1992, p. 1992.
36. R. Ofstad, S. Kidman, and A. Hermansson, Ultramicroscopical structures and liquid loss in heated cod (*Gadus morhua* L) and salmon (*Salmo salar*) muscle, *J. Sci. Food Agric.* 72:337, 1996.
37. I. Papa, C. Alvarez, V. Verrez-Bagnis, J. Fleurence, and Y. Benyamin, Post mortem release of fish white muscle  $\alpha$ -actinin as a marker of disorganisation, *J. Sci. Food Agric.* 72:63, 1996.
38. M. Ando, H. Toyohara, Y. Shimizu, and M. Sakagushi, Post mortem tenderisation of rainbow trout (*Oncorhynchus mykiss*) muscle caused by gradual disintegration of the extracellular matrix structure, *J. Sci. Food Agric.* 55:589, 1991.
39. F.J.M.S. Eikelenboom and H. Ruderus, The effect of high and low voltage electrical stimulation on beef quality, *Meat Sci.* 75:247, 1985.
40. J. Anderson and F.C. Parrish, Post mortem degradation of titin and nebulin of beef steaks varying in tenderness, *J. Food Sci.* 54:743, 1989.
41. K. Sato, M. Ando, S. Kubota, K. Origasa, H. Kawase, H. Toyohara, M. Sakaguchi, T. Nakagawa, Y. Makinodan, K. Ohtsuki, and M. Kawabata, Involvement of type V collagen in softening of fish muscle during short-term chilled storage, *J. Agric. Food Chem.* 45:343, 1997.
42. K. Tachibana, T. Misima, and M. Tsuchimoto, Changes of ultrastructure and cytochemical Mg<sup>2+</sup> ATPase activity in ordinary muscle of cultured and wild red sea bream during storage in ice, *Nippon Suisan Gakkaishi* 59:721, 1993.
43. G. Offer and J. Trinick, On the mechanism of water holding in meat; the swelling and shrinkage of myofibrils, *Meat Sci.* 5:245, 1983.
44. R.M. Love and M.A. Haq, The connective tissues of fish. III. The effect of pH on gaping in cod entering rigor mortis at different temperatures, *J. Food Technol.* 5:241, 1970.
45. B. Chrystall, Electrical stimulation, refrigeration and subsequent meat quality. Paper E7.3, Proceedings 24th European, Meat Research Workers Conference, Kulmbach, Germany, 1978.
46. B. Chrystall and C.E. Devine, Electrical stimulation, muscle tension, and glycolysis in bovine sterno-mandibularis, *Meat Sci.* 2:49, 1978.
47. C. Ching and J.M. Goepfert, Growth of *Salmonella* at low pH, *J. Food Sci.* 35:326, 1970.
48. R.N. Costilow, M.A. Uebersax, and P. J. Ward, Use of chlorine dioxide for controlling microorganisms during the handling and storage of fresh cucumbers, *J. Food Sci.* 49:396, 1984.
49. P. Melle, "Electronic Noses": Towards the objective instrumental characterization of food aroma, *Trends Food Sci. Technol.* 7:432–438, 1996.
50. G. Olafsdottir, E. Martinsdottir, and E.H. Jonsson, Rapid gas sensor measurements to determine spoilage of capelin (*Mallotus villosus*), *J. Agric. Food Chem.* 45:2654–2659, 1997.
51. T.M. Lin and J.W. Park, Protein solubility in Pacific whiting affected by proteolysis during storage, *J. Food Sci.* 61:536, 1996.
52. R. Hastings, G.W. Rodger, R. Park, A.D. Matthe, and E.M. Anderson, Differential scanning calorimetry of fish muscle: the effect of processing and species variation, *J. Food Sci.* 50:503, 1985.
53. R. Davies, D.A. Ledward, R.G. Bardsley, and G. Poulter, Species dependence of fish myofibrillar stability to heat and frozen storage, *Int. J. Food Sci. Technol.* 29:2S7, 1994.

54. K. Howell, A.D. Matthews, and A. P. Donnelly, Thermal stability of fish myofibrils: A differential scanning calorimetric study, *Int. J. Food Sci. Technol.* 26:283, 1991.
55. V. Venugopal, Extracellular proteases of contaminant bacteria in fish spoilage: A review, *J. Food Protect.* 53:341, 1990.
56. L.U. Opara, Postharvest technology of root and tuber crops. In *Crop Management and Postharvest Handling of Horticultural Products* (R. Dris, R. Niskanen, and S.M. Jain, Eds.), Volume II—Fruits and Vegetables, Chap. 15, Science Publishers, Plymouth, UK, 2002, pp. 381–406.
57. A. Hanpongkittikun, S. Siripongvutiko, and D.L. Cohen, Black tiger (*Penaeus monodon*) quality changes during iced storage, *ASEAN Food J.* 10:125, 1995.
58. C.C. Vaz-Pires and R. Kirby, Low-level heat-treatment to extend shelf-life of fresh fish. *Int. J. Food Sci. Technol.* 29:405, 1994.
59. J. Busscher, A.H. Weerkamp, H.C. Van der Met, A.W.J. Van Pelt, H.P. De Jong, and J. Arends, Measurements of the surface free energy of bacterial cell surfaces and its relevance for adhesion, *Appl. Environ. Microbiol.* 45:980, 1984.
60. H. Huss, D. Dalsgaard, L. Hansen, H. Ladefoged, A. Petersen, and L. Zittan, The influence of hygiene in catch handling on the storage life of iced cod and plaice, *J. Food Technol.* 9:213, 1974.
61. L. Herborg and A. Villadsen, Bacterial infection/invasion in fish flesh, *J. Food Technol.* 10:507, 1975.
62. W. Lin, T. Huang, J.A. Cornell, C. Lin, and C. Wei, Bactericidal activity of aqueous chlorine and chlorine dioxide solutions in a fish model system, *J. Food Sci.* 67:1030, 1996.
63. G. Sims, G.E. Cosham, and W.E. Anderson, Hydrogen peroxide bleaching of marinated herring, *J. Food Technol.* 70:497, 1975.
64. S. Wessels and H.H. Huss, Suitability of *Lactococcus lactis* subsp. *lactis* ATCC 11454 as a protective culture for lightly preserved fish products. *Food Microbiol.* 73:323, 1996.
65. A. Ashie and B.K. Simpson,  $\alpha$ -Macroglobulin inhibition of endogenous proteases in fish muscle, *J. Food Sci.* 61:351, 1996.
66. A. Loner and B.L. Aitken, Method for treating fish with  $\alpha$ -2-macroglobulin, U.S. patent 15,013, 568, 1991.
67. F. Madero and G. Finne, Properties of phenoloxidase from gulf shrimp, *Proceedings of the 7th Annual Tropical and Subtropical Fisheries Technological Conference of the Americans*, 1982, p. 328.
68. C.G.B. Zawistowski and N.A. Michael, Polyphenol oxidase. In *Oxidative Enzymes in Foods* (D.S. Robinson and N.A.M. Eskin, Eds.), Elsevier, New York, 1991, p. 217.
69. R.I. McEvily and S. Otweil, Sulphite alternative prevents shrimp melanosis, *Food Technol.* 43:80, 1991.
70. L. Slattery, D.J. Williams, and A. Cusack, A sulphite-free treatment inhibits blackspot formation in prawns, *Food Australia* 47:509, 1995.
71. R. Mendes, H.A. Silva, M.L. Nunes, and J.M.A. Empis, Effect of low-dose irradiation and refrigeration on the microflora, sensory characteristics and biogenic amines of Atlantic horse mackerel (*Trachurus trachurus*). European Food Research and Technology, April, accessed 18 June, 2005.
72. B. Ray, *Fundamental Food Microbiology*, CRC Press, Boca Raton, Florida, 1996.
73. H.M. Abu-Tarboush, H.A. Al-Kahtani, M. Atia, A.A. Abou-Arab, A.S. Bajaber, and M.A. El-Mojaddidi, *J. Food Protect.* 59(10):1041–1048, 1996.
74. A. Laycock and I.W. Regier, In *Preservation of Fish by Irradiation. Panel Proceedings Series*. IAEA, Vienna, 1970, pp. 13–25.
75. G. Hobbs and F.J. Ley, Radiation Preservation of Fish, Proceedings of the Meeting of the Commission C2 & D3. Aptitude a La conservation Des Poissons Et Produits De La Mer Refrigeres, Aberdeen, Compte-Rendu Des Reunions Des Commissions C2 Et D3 De L' Iif. Paris (France), *International Institute of Refrigeration*, Paris, France 60(4):177–186, 1985.
76. M. Marcotte, Fish and shell fish can be irradiated to control pathogenic and spoilage bacteria, and to extend their marketable life, 2004. <http://www.food-irradiation.com/fish.htm> (accessed 12 September, 2005).
77. E.A. Murano, Irradiation of fresh meat, *Food Technol.* 49(12):52–54, 1995.
78. P.G. Vaz-Pires and R.M. Kirby, Effect of heat on microorganisms isolated from freshly caught chilled scad (*Trachurus trachurus*), *Int. J. Food Sci. Technol.* 31:277, 1996.
79. H.R. Rodriguez, J.A. Lasta, R.A. Mallo, and N. Marchevesky, Low-dose gamma irradiation and refrigeration to extend shelf life of aerobically packed fresh beef round, *J. Food Protect.* 56(6):505–509, 1993.
80. R.A. Myers and B. Worm, Rapid worldwide depletion of predatory fish communities, *Nature* 423:280–283, 2003.
81. N. Scott, G.C. Fletcher, M.G. Hogg, and J.M. Ryder, Comparison of whole with headed and gutted orange roughy stored in ice: sensory, microbiology and chemical assessment, *J. Food Sci.* 57:79, 1986.

# 7

## *Postharvest Handling of Red Meat*

Isam T. Kadim and Osman Mahgoub

### CONTENTS

7.1	Introduction.....	173
7.2	Muscle Structure and Physiology.....	174
7.3	Contamination of Carcasses.....	176
7.3.1	Slaughter Conditions.....	176
7.3.2	Equipments.....	176
7.3.3	Slaughtering and Fresh Meat Processing.....	177
7.3.4	Personnel.....	177
7.4	Decontamination of Carcasses.....	177
7.4.1	Water.....	178
7.4.2	Organic Acids.....	179
7.4.3	Inorganic Materials.....	180
7.4.4	Chlorine and Chlorine Dioxide.....	181
7.4.5	Antibiotic.....	181
7.5	Rigor Mortis.....	181
7.5.1	Postmortem Changes: Prerigor.....	182
7.5.1.1	Cold Shortening.....	182
7.5.1.2	Electrical Stimulation.....	182
7.5.1.3	Pale, Soft, and Exudative Meat.....	184
7.5.1.4	Dark Firm and Dry Meat.....	185
7.5.2	Postrigor Postmortem Changes.....	185
7.5.2.1	Meat Color.....	185
7.5.2.2	Role of Mitochondria.....	186
7.5.2.3	Lipid Oxidation.....	187
7.5.2.4	Warm-Over Flavor.....	188
7.6	Meat Storage and Safety.....	188
7.6.1	Refrigeration of Meat.....	189
7.6.2	Aging and Meat Tenderization.....	189
7.6.3	Freezing of Meat.....	190
7.7	Conclusion.....	191
	References.....	192

### 7.1 Introduction

Animals' body mass contains a large proportion of skeletal muscle, which is responsible for contraction. Meat is the edible flesh of animals' skeletal muscles that is used as food and is an excellent source of many nutrients, especially protein, B vitamins, iron, and zinc. Skeletal muscle is made up of thousands of cylindrical muscle fibers often running all the way from origin to insertion (Figure 7.1). The fibers are bound together by connective tissue through which blood vessels and nerves run (Figure 7.2). The conventional instruction for understanding the postharvest of meat is to start with the structure and physiology of living muscle.

Muscle biology is complex due to the various biological functions of muscles, such as their role in movement, deposition of protein, and protection [94]. Muscle metabolism plays a role in the pathogenesis of metabolic disorders in humans and animals, and in the transformation of muscles to meat in animals [39,73]. Muscle characteristics are of prime importance since quality has been recently recognized as one of the most important social and economic challenges for meat producers and retailers around the world. Animal physiology also generally plays an important role in controlling the changes that occur in the postmortem conversion of muscle to meat, thereby affecting meat supply for the human population [13,102].

Regardless of the species, animal death is accompanied by an inability to supply oxygen within the body. When normal life processes stop, many of the biochemical reactions present in the living state retain some degree of activity in the nonliving state. These reactions are responsible for profound quality changes during storage. The rate and extent of muscle postmortem metabolism is dependent on availability of glycogen at slaughter [110,249], the temperature of the medium in which the reactions occur [163,178], and whether or not procedures intended to accelerate metabolic reactions have been applied [26].

Initially, muscles become stiff and hard but gain some softness after hanging and conditioning (aging).

Providing consumers with adequate quantities of quality meat and meat products is the main objective of meat harvesting. Therefore, meat requires proper handling after slaughter. Enhanced meat safety involves the application of measures to delay or prevent microbiological, chemical, and physical changes that make meat less healthy for human consumption. This review aims to summarize the recent advances in the understanding of meat harvesting and its effects on meat quality characteristics. The first part of this review will deal with the relationships between muscle antimortem changes and meat quality traits. The second part will address the development of rigor mortis and the relationships between postrigor changes and meat quality traits. The third part will describe the relationships between chilling and freezing of meat and meat quality traits.

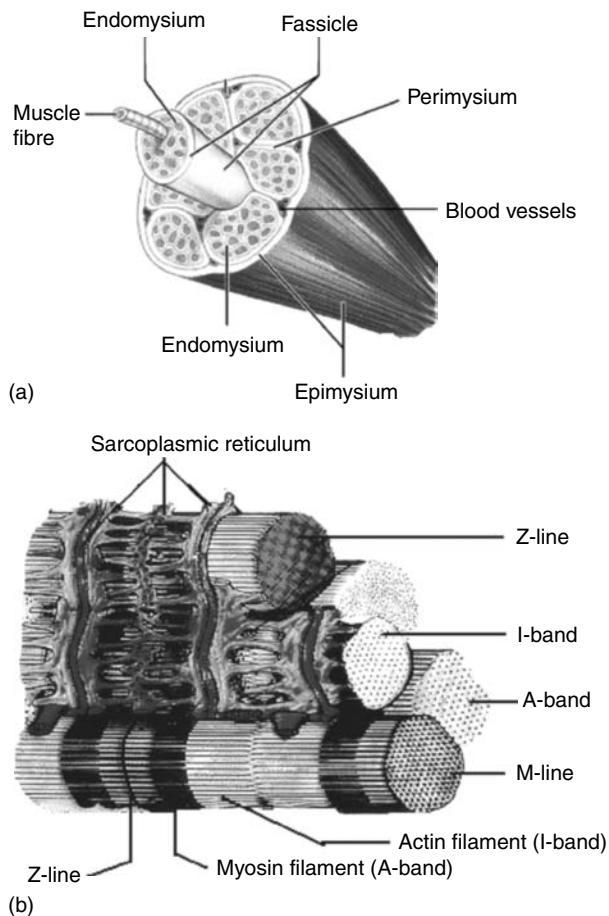
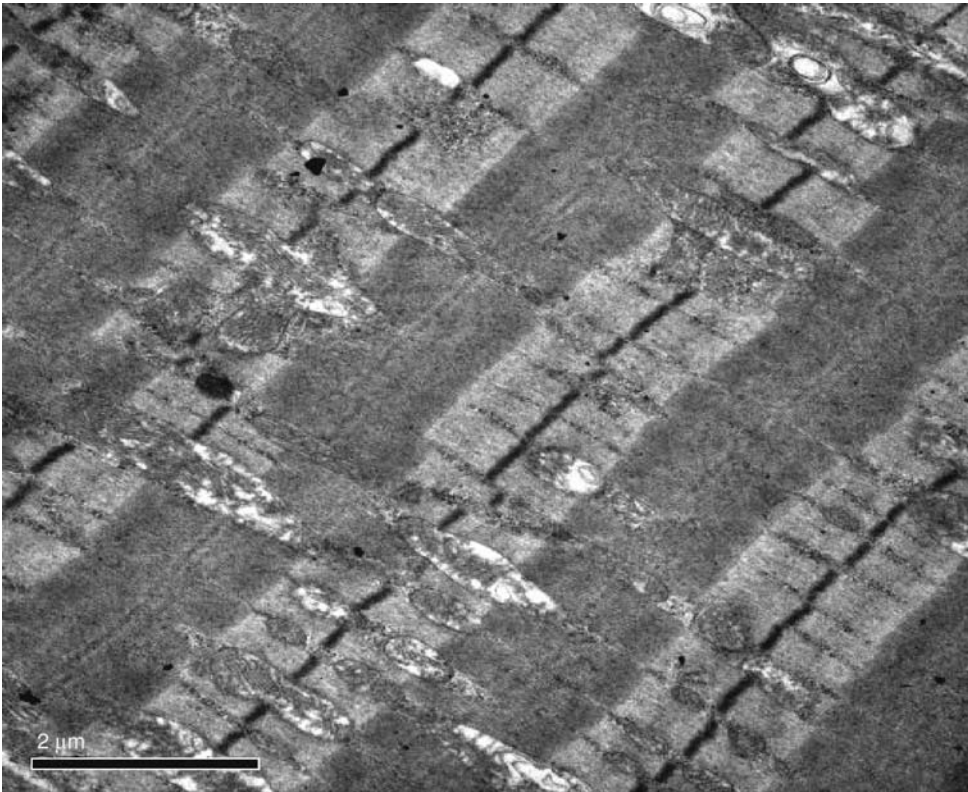


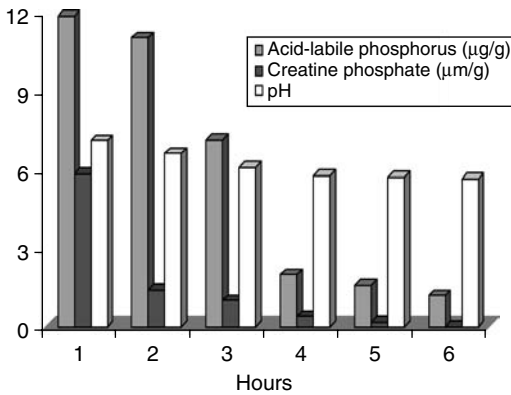
FIGURE 7.1 Microstructure of animal muscle.

## 7.2 Muscle Structure and Physiology

Muscle fibers (myofibers) are the basic cellular units of living muscle and of meat, and are formed by the fusion of individual myofibrils (Figure 7.2). An ordered arrangement of myofibers, myofibrils, and myofilaments creates the characteristic texture of meat [235]. The endoplasmic reticulum is highly specialized for regulating calcium concentrations within the myofiber and, as a result, exerts strong influence on the control of muscle contractions. Following the slaughter of animals, all biochemical



**FIGURE 7.2** Long-section of myofibril showing sarcomeres, Z-lines, A-bands, and I-bands.



**FIGURE 7.3** The changes in biochemical metabolites during the onset of rigor mortis.

components necessary for anaerobic metabolism in cells are present and functional, and consequently glycolysis proceeds. As a result, changes occur in the concentrations of glycolytic substrates and reaction products until a point is reached at which some reaction in the glycolytic process is arrested and metabolism ceases. When this occurs, the ability to produce adenosine triphosphate (ATP) is completely lost and *rigor mortis* is established. The ATP is necessary for muscle contraction and actomyosin cross-bridges. When the ATP concentration decreases toward zero, a greater percentage of myosin heads remain attached to actin. During the prerigor process, several

changes occur in the concentrations of glycolytic substrates and products. The changes in concentrations of hydrogen ion, acid-labile phosphorus, creatine phosphate, and extensibility from the point of death until the onset of rigor mortis are presented in Figure 7.3. The concentrations of these substances can be measured and they are related to the rate and extent of glycolysis. It is important to note that the concentration of ATP does not start decreasing immediately postmortem but rather remains at physiological levels for a brief period before declining. This is due to the regeneration of ATP from creatine phosphate during anaerobic glycolysis.

## 7.3 Contamination of Carcasses

### 7.3.1 Slaughter Conditions

Slaughter conditions have been implicated as important parameters affecting carcass contamination. Meat is subject to contamination from a variety of sources within and outside of the animal. These contaminations can occur during slaughter and processing. The level of microbial contamination of a freshly dressed carcass and the composition of the flora depend on the technical structure of the abattoir and the hygiene conditions during the slaughter dressing procedures [217]. A total of 34 fungal genera, represented by 6 species and 1 variety from air, water, walls, and floors of abattoir surroundings that might also constitute significant sources of mold contamination for carcasses, have been identified [105].

The importance of handling animals during slaughter is clear. Mishandling is one of the main causes of stress, which can affect the immune system of the animal and subsequently the meat quality [38]. The number of calves that shed *Salmonellae* has been shown to increase after stress [37,71]. Interruption of feeding immediately before transport affects the growth of potential pathogens in the rumen [71] and fecal shedding of bacteria [82]. Lairages that do not provide an environment adequate to the needs of the species cause additional stress in the animals and subsequent defects in the meat. The rate of microbial spoilage of meat varies widely depending on (i) initial microbial contamination, (ii) temperature, (iii) pH, (iv) presence of oxygen, (v) presence of nutrients, and (vi) presence of inhibitory substances, including carbon dioxide. The most common forms of spoilage of raw meat take place slowly, and considerable growth of microorganisms can occur without detracting from the eating quality of the meat. When it eventually becomes apparent, spoilage takes the form of souring or slime production on the surfaces, which is readily recognized by the typical consumer before the meat becomes unsuitable for consumption. Alternative less common spoilage takes the form of putrefaction and produces offensive odors and flavors associated with the breakdown of nitrogen-containing substances [90]. The most important factors in handling fresh meat are speed of handling, control of temperature, and good hygiene conditions. Slaughter practices are required to minimize both physical and microbiological contamination of carcasses. Integrated hygiene control along the meat production line could therefore be the processor's most effective approach to increasing the storage life of these products [223].

### 7.3.2 Equipments

Meat from healthy animals is sterile. However, it may be contaminated by skin, hooves, hair, intestinal contents, knives, cutting tools, personnel, polluted water, air, faulty slaughtering procedure, postslaughter handling, and storage [2,70]. Animal skin may become contaminated with many microorganisms such as staphylococci, micrococci, pseudomonads, yeast, and molds [217]. The stress of moving animals, mixing them at markets, insufficient disinfection of transport vehicles, and cross-infection by extended time in lairage would render them as contamination hazard [223].

The equipment, utensils, and slaughter facilities should be properly designed, cleaned, and disinfected. Microbial contamination of equipment in the slaughterhouse was high, the mean total count ( $\log_{10}$  cfu/one side of blade) of knives was between 3.00 and 5.90 and for aprons was between 3.00 and 3.78  $\log_{10}$  cfu/cm<sup>2</sup> [2]. The floor and walls of slaughter facilities should be smooth to allow proper cleaning and disinfecting. The cleanliness during the slaughtering process can be used to reduce microbial contamination of meat [113]. Captive bolts and sticking knives have been recognized as a source of internal contamination of organs as well as for muscle [223]. Knives, steels, and aprons of personnel who handle carcasses before skinning may be an important source of contamination. The frequency of contamination of steel with bacteria varied between 0% and 95%, with 32% of the workers' aprons contaminated with bacteria [220]. The major sources of microbial contamination were fleece > workers' hands > fecal pellets > knife blades [10]. Other cross-contamination sources are protective gloves often used in the dressing and boning line, and surfaces of cutting tables for further breakdown of carcasses into subprimal cuts [224]. Cutting boards have also been indicated as major sources of microbial dissemination during boning, particularly when carcass microbial counts were less than 10<sup>3</sup> cfu/cm<sup>2</sup> [255]. Hygienic practices were found to correlate with carcass contamination levels, especially the

frequency of disinfection. The enforcement of hygienic practices, such as the regular disinfection of working tools, is also important in reducing the microbial contamination of carcasses. Improved sanitation of cutting surfaces in the boning room resulted in a significant reduction in the microbial contamination on the meat surface [255]. The cutting board surface was identified as a major source of contamination [2], where the average mesophilic bacterial count was  $\log_{10}$  5.56 cfu/cm<sup>2</sup> and 50% of samples were positive for *Salmonella* spp. and *Staphylococci* spp. Cutting boards should not be used for more than 4 h without cleaning or turning [57].

### 7.3.3 Slaughtering and Fresh Meat Processing

Bacterial loading of carcasses is greatly influenced by the animal species [3,253]. Generally, the ranking of the loading is cattle < calves < sheep < goat < chicken. This is considered to be due to the way the animals are processed rather than to any inherent species differences. It is hard to prevent rollback of the fleece on long-haired sheep [233]. The count was significantly higher after evisceration in two sites tested on sheep carcasses [2,76]. The increase in bacterial counts after evisceration may be due to spillage of rumen and intestinal fluid when the carcass is open and the viscera removed [71]. The scalding water contaminated with dirt and feces is a major source of bacterial contamination. Carcass contamination with feces during slaughter and dressing processes is an important route for the transmission of a range of enteric pathogens from food animals to humans [148], and there are concerns that such processes may provide a similar route of dissemination of *Cryptosporidium parvum* within the abattoir and related operations. *Cryptosporidium parvum* is a protozoan parasite that can infect a wide range of species, including human and cattle [168], causing a self-limiting disease characterized by diarrhea, abdominal cramps, fever, nausea, and vomiting, with fecal shedding of a large number of environmentally robust and highly infectious oocysts [65]. Immersion of carcasses in scalding water of about 60°C will remove hairs of the pig's epidermis and may reduce bacterial contamination [222]. In fresh meat, size reduction is an important factor. For example, mincing or dicing, with the consequent increase in surface area, increases the opportunity for microbial contamination [57].

### 7.3.4 Personnel

The most important human sources of bacterial infections are the oral and nasal cavity, digestive tract, and the skin. The hazard of these can be reduced by (i) washing, regular cleaning, and disinfection, (ii) improving hygienic working conditions, (iii) lowering initial bacterial loads, (iv) using skilled and careful slaughter personnel, and (v) management's commitment to the control of quality and safety [223]. High frequency (100%) of slaughterhouse workers contaminated with bacteria indicated that they play a major role in the cross-contamination of carcasses [2]. Good personal hygiene measures are necessary for reducing carcass contamination [36]. Hot water (44°C) hand rinse can remove 90% of the microbial contamination from a slaughterhouse worker's hands [10].

---

## 7.4 Decontamination of Carcasses

Decontamination is very important to reduce carcass spoilage and consequently improve meat hygiene. The major cause of spoilage is accumulation of microorganisms, specifically bacteria. Many slaughterhouses perform bacterial counts at an incubation temperature of 20°C as the carcasses are chilled immediately following slaughtering. This may be because both *psychrotrophs* and *mesophiles* can grow at this temperature [233]. Chilled storage at temperatures less than 10°C is the simplest procedure to store meat products. For long storage, the temperature should be as near to the freezing point as practicable (1.5°C), and the relative humidity should be controlled within 85%–95% to prevent drying or condensation on the surface. The main spoilage organisms during aerobic low-temperature storage are *Pseudomonas* species, whereas under vacuum storage, the major spoilage organisms are *Lactobacillus* species and yeasts [57].

Surface sampling of carcasses as an indication of hygiene is important; the presence of pathogenic bacteria due to slaughtering malpractice and fecal contamination can be measured by carcass-surface sampling [191]. The effectiveness of decontamination treatments applied during dressing of carcasses on



microbiological quality was investigated. Microbial contamination of meat starts during processing on the slaughter line [2,76,79,182]. First, the microorganisms reach the carcass surface from where they may penetrate into deeper layers of the meat. Fecal contamination of dressed carcasses can occur as a consequence of either direct contact with fecal material or contact with surfaces that have been in contact with fecal material [2,10]. Reducing this primal surface contamination and avoiding or limiting the microbial growth would improve safety and external shelf life [107]. Different methods of heat treatment of surface layers were suggested and evaluated. These were chemical, physical, and combinations of the two [16,28,189,223]. Removal of bacteria stuck on the carcass surface, followed by spraying antimicrobial hot water, induces releasing and inactivation of bacteria, which is necessary for effective decontamination [219]. The treatment with hot water combines the rinse and partial heat decontamination of the surface of carcasses. The possible heat damage to the appearance of carcass surface reduces the feasibility of such treatment.

Carcasses can be contaminated with physical hazards. Carcasses can be contaminated from the wool, feces, dust, and rust from equipment. Contamination of carcasses with fleece and skin is due to faults in the skinning and evisceration techniques [62]. Procedures for decontamination differ among countries. Dressing procedures to control contamination on carcasses are also commonly modified independent of aspects that affect the levels of microbial contamination [15]. Washing may redistribute bacteria from heavily contaminated sites to less contaminated parts.

#### 7.4.1 Water

Washing with hot water is one of the many potential methods for reducing levels of pathogenic bacteria on the surfaces of carcasses [28,54,80,108,159]. Total viable counts reduced by 2.38 and 2.9 log units, respectively, as a result of washing with hot water [28,54]. Using hot water at 105°C for 6.5 s on the surface of cattle carcasses reduced the log mean number of coliforms and *Escherichia coli* [77]. Washing beef carcasses with hot water (95°) for 10 s resulted in reductions in bacterial numbers [6]. Reductions more than 3 log units are possible in the case of *E. coli*, *Salmonella*, *Aeromonas hydrophila*, *Yersinia enterocolitica*, *Pseudomonas fragi*, and *Listeria monocytogenes* from the surface of beef tissue by applying 80°C water for 10 or 20 s [221]. Similarly, spray washing with hot water at 83.5°C for 10 or 20 s resulted in 2.2 and 3.0 log units reductions of bacterial counts, respectively [43]. A reduction of 95% was possible in total aerobic plate counts of beef sides by treatment with spray washing at 75°C and 300 kPa [189]. However, evaluation of the efficacy of using 130°C failed to reduce the *Salmonella* population of inoculated, chilled cattle carcass adipose tissue, which may be due to too rapid movement of the heat application unit across the surface [5]. Washing was more effective in reducing bacterial counts and visible fecal contamination when pressure and temperature were increased [43,81,107,118]. The bacterial numbers on lamb carcasses decreased from 0.05 to 1.0 log/cm<sup>2</sup> when the temperature of spray washing increased from 57°C to 80°C [118].

Using a combination of knife trimming and spray washing could reduce the temperature of spray washing water [81]. Spraying hot water at 74°C on the surface of beef resulted in a 3 log cfu/cm<sup>2</sup> [81] reduction, while a combination of knife trimming and spray washing with warm water less than 35°C resulted in reductions of 1.4–2.3 log cfu/cm<sup>2</sup> [81]. Spray washing was as effective as trimming in decontamination of beef carcasses [192]. The decontamination of beef carcasses could be achieved by knife trimming followed by spray washing or by spray washing followed by hot water rinsing [44]. However, there are some disadvantages of trimming. These include: (i) the removal of bacteria by hot water was more consistent than that by knife trimming [44,81], (ii) trimming can be highly variable and its efficacy can be affected by skill and diligence of the individual, and (iii) recontamination or cross-contamination may also occur.

Chlorinated water is also used for washing [107]. However, this method is not always accepted. For example, the European Union does not allow the addition of chlorine to process water during poultry and meat processing [16]. The chlorine levels do not normally exceed 50 ppm, which results in a reduction in microbial load only by 1-log cycle. Application of 200 mg/L (20 ppm) chlorine appears to reduce bacteria substantially on poultry, pork, and beef. In some cases, more than 200 mg/L is required, for example, in the case of low initial counts on beef carcasses, and in the case of poultry carcasses a level of 300–400 ppm is required to effectively eradicate *Salmonella* [240]. The effectiveness of chlorine for bacterial reduction can improve by combining it with organic acids such as acetic acid or by raising the

temperature of the solution [49]. Aerobic plate counts were significantly reduced when lamb carcasses were immersed in chlorinated water at 90°C [107].

Steam is one of the more effective and fast (0.1s) methods for reducing the level of pathogenic bacteria on the surface of carcasses [128]. The surface will appear quite rough with many pores. It is difficult to kill bacteria that get into these pores with sanitizing solution because surface tension prevents the liquid from entering the pores. Therefore, steam should be able to enter the pores and kill the bacteria. A thin layer of air plus the entrained moisture surrounds all solid food, and steam cannot pass through these barriers to reach the bacteria.

#### 7.4.2 Organic Acids

The grouping concern about the contamination of carcasses with enteric pathogens has led to extensive investigation of treatments for reducing the number of bacteria on dressed carcasses. The surface treatment with organic acids is a more realistic option to eliminate pathogens without adverse effects on quality. Use of organic acids reduces bacterial counts in the meat surface layer; lactic acid is often used, as it is a natural meat compound produced during postmortem glycolysis [182]. The combination of physical treatment by hot steam with spraying by lactic acid solution is another approach for carcass surface decontamination [51,54,78,117]. Acid washes have been shown to be effective in reducing the total number of microorganisms present on the carcass [50]. Spraying of sheep and goat forequarters with 2% lactic acid and 1.5% acetic plus 1.5% propionic acid combination resulted in a reduction in total viable counts of 0.52 and 1.16 log units, respectively [54]. A similar reduction in total viable counts was noted when sheep carcasses were spray washed with 1.2% lactic acid [167]. The antimicrobial effect of the organic acids is due to the reduction of pH below the growth range and metabolic inhibition by the undissociated molecules [136]. In this respect, acid and heat inactivation of microorganisms follows release of microorganisms from the surface. Moreover, the lactate anion slows down the growth of surviving microbes during storage [127,219]. The application of lactic acid has been used in slaughterhouses to reduce carcass contamination [117,181–183,223,232]. Different combinations of hot water (82°C) and hot air (510°C) and lactic acid can result in continuously decreasing microbial populations on the beef carcasses [117]. However, spraying carcasses with lactic acid alone did not reduce the number of microbial contamination on it [79]. The apparent failure of the lactic acid spray to produce substantial effects of microbiological counts may be due to the poor coverage of the carcasses and by the solutions being diluted by water present on carcasses from washing or condensation of steam, rather than from the resistance of bacteria to the antibacterial effects of lactic acid, which is well established. Lactic acid solution had been effectively applied to some sites that were decontaminated, but the overall effect was trivial because many other sites remained unaffected [78].

The antimicrobial action of organic acids depends on three factors: (i) pH, (ii) extent of dissociation, and (iii) specific effects related to acid molecules. The effective growth inhibition by an acid only occurs when an appropriate amount of the undissociated molecule is present [105]. This amount may be obtained by either applying more acid or by lowering the pH. Most organic acids are therefore effective only at low pH values, i.e., approximately below pH 5.5. However, in some cases, pH level above 6 may also be effective for some acids [223]. The differences in antimicrobial activities of various organic acids are related to (i) the potency to penetrate a cell, (ii) the part of the cell that is attacked, and (iii) the chemical nature of that attack [105]. For example, heteropolar molecules are surfaced actively, thus affecting the bacterial cell surface and its permeability, and the moderate lipophilic part penetrates the cell membranes. The acid, which has penetrated, affects the cell biology. The factors influencing the efficacy of acids treatments are: (i) nature of meat surface and initial level of contamination, (ii) initial bacterial load, (iii) type of acid used, (iv) concentration and temperature of the acid, (v) types of microorganisms present on the surface, and (vi) time after slaughter and duration of acid treatment [223].

Increasing the temperature of the lactic acid solution increases the effect of acid decontamination. Decontamination of beef carcasses by steam and lactic acid immediately reduced the surface microbial counts and retarded microbial growth during storage [182]. They also found that the effect of steam and lactic acid is higher on more contaminated parts of the carcasses. The fat content in meat affects the efficiency of decontamination of meat [48,49,112]. It is easier to reduce microorganism on fat than on lean

beef. The main reason is that the buffering capacity of lean is many times greater than that of fat which allows a much faster initial drop in surface pH [223].

Organic acids may not be able to have proper contact with firmly attached bacteria in animal carcasses [190]. The high degree of contamination of meat surfaces with microorganisms and increasing levels of organic acid will reduce the efficiency of acid treatments and needs higher concentration levels of organic acid [223]. Smulders states [223] that the initial levels of bacterial contamination on meat significantly affect the treatment, and the pattern varied between bacterial species.

After examining 13 acids, it was recommended that acetic and propionic acids are the most effective agents for *Salmonellae* [32]. Mixtures containing various acids may also be used for their synergistic effects on microorganisms, but synergistic effects may not always be observed. Acetic and lactic acids seem to produce the desired microbial reduction and their mixtures may enhance the effectiveness [223]. The concentration of acids usually used is within 1%–4% at temperatures within 15°C–55°C. In general, higher acid concentrations and temperatures produce best antimicrobial effects [223]. Variable sensitivities of different types of microorganisms to acids exist. For example, yeasts and molds are more tolerant to acids than bacteria.

The bacteria are attached to the meat surface by (i) retention, i.e., retained in a liquid surface film, (ii) entrapment, i.e., by the specific microtopography of the surface, (iii) adsorption, i.e., by short-range attractive forces in a solid–liquid interface, and (iv) adhesion, i.e., by intimate contact with polymer bridging or fimbriate or holdfasts [223]. Thus, meat surfaces should be treated quickly after dressing or boning before contaminating organisms have colonized the surface. Attachment is a two-step process: reversible association with a surface followed by irreversible adherence [145]. Washing may be applied to remove attached bacteria associated with the surface water film [120]. Composition and ionic strength of liquid phase are more important than other factors in meat spoilage [184,185]. A sufficient contact time should be allowed to achieve desired acid–microbial interaction [223]. The modes of application, such as spraying, immersion, and electrostatic dispersion, also impact on the efficiency of the process.

Decontamination systems may adversely affect meat qualities that contribute to carcass acceptability, such as color, flavor, odor, and drip loss. An efficient decontamination system should reduce bacterial numbers without any detrimental changes to the appearance of the carcass [54,107]. In general, treatment with lactic, acetic, and citric acids at low concentration does not produce much of an adverse effect on color [54,167,180,181]. However, higher concentrations resulted in bleaching of lean and fat [223]. When many blood spots are present on the meat surface, the coagulation of blood may cause rusty brown black spots. This is more particularly evident at higher acid concentration, but decontamination with acetic or lactic acids at concentrations of 1%–2% hardly affects the sensory quality of meat [223]. The sensory scores are more readily affected by acetic acid than lactic acid, thus mixtures may help to alleviate color problems. Slight visible discoloration forms immediately after application of the acid at low concentrations and usually disappears upon its diffusion. The use of acetic, propionic, lactic, and formic acids for decontamination is considered to be acceptable from a toxicological perspective [61].

### 7.4.3 Inorganic Materials

Inorganic phosphates, hydrogen peroxide, and ozone are also used for carcass decontamination. Trisodium phosphate treatment is officially accepted and widely implemented in the poultry slaughter process [16], and it does not cause undesirable sensory effects detectable by the consumer [95]. A concentration of 10%–12% in alkaline solution could be used [16].

The formation of radicals by hydrogen peroxide damages nucleic acids, proteins, and lipids, thus causing a bactericidal–bacteriostatic effect [116]. Hydrogen peroxide as a poultry carcass decontaminant is used at a minimum effective dose of 0.5% (v/v) in water. At this level, a temporary bleaching and bloating of the carcasses and excessive foaming of chiller water is observed [16], and the application of hydrogen peroxide for decontamination seems to be an effective and safe method to control the spread of pathogens.

The ozonated water is also used for washing the carcasses to eliminate bacterial counts on the product [192]. Ozonated water can be used to decontaminate carcasses without visual defects or sensory off-flavors, although bacterial count reduction is poor (> 1-log cycle) and there is no increase in shelf life [214]. Spraying beef carcass with water followed by spraying with ozonated water is an effective bacteriological sanitation method [81].

#### 7.4.4 Chlorine and Chlorine Dioxide

Aqueous chlorine is widely used in food processing to control microbial growth. Its bactericidal activity decreases in alkaline conditions and at high levels of organic matter. Furthermore, potentially toxic mutagenic reaction products, including trihalomethanes, are formed during chlorine treatment of food components [138,251]. Chlorine dioxide has received much attention due to its advantages over aqueous chlorine: (i) it is seven times more potent than aqueous chlorine in killing bacteria in poultry processing chill water [137], (ii) its bactericidal activity is not affected by alkaline conditions and the presence of high levels of organic matter [40,254], (iii) it is less reactive than aqueous chlorine in interacting with organic compounds such as unsaturated fatty acids, their methyl esters [254], and tryptophan and their derivatives [212]. The Food and Drug Administration of the United States approved a 3 ppm residue of chlorine dioxide for controlling microbial populations in poultry processing water [138].

#### 7.4.5 Antibiotic

It is possible to improve hygiene levels of carcasses by means of antibiotics [8]. The most frequently used and cheap antibiotics are chlorotetracycline and oxytetracycline. The most effective applications of antibiotics are their combinations [122]. However, generally, application of antibiotics to meat faces wide criticism and protest. Many people do not agree with antibiotic application to meat on legal and hygienic grounds as many antibiotics may cause toxic and allergic reactions as well as bacterial resistance with cumulative effects in the human body. A strict control of antibiotic applications in meat should be maintained [8].

In addition to the treatments, packaging is also used in preventing contamination, controlling evaporation of water from the surface, and reabsorbing the drip. The absorbent and refrigerant pads benefit by absorbing and retaining unwanted fluids, and improving the shelf life and helping to maintain humidity levels.

---

### 7.5 Rigor Mortis

Rigor mortis is a temporary process occurring during the time course of postmortem glycolysis and is characterized by progressive stiffening of the muscle [96]. The loss of ATP during postmortem anaerobic glycolysis is the cause of the onset of rigor. When ATP is exhausted, the myosin and actin molecules remain locked together and yield the stiff nature of muscle in rigor. Development of rigor mortis has been determined by several methods, including (1) loss of extensibility [96], (2) muscle shortening [96], (3) tension development [165], (4) resistance to strain [136], and (5) a combination of muscle tension and shortening [172].

The rate of postmortem glycolysis and the extent to which it occurs have significant implications on meat quality. As anaerobic glycolysis proceeds from the point of slaughter to rigor mortis, various changes occur in the muscle. The production of  $H^+$  leads to a more acidic condition, which, in turn, is measured as a decrease in meat pH. Fast glycolyzing muscles yield higher tenderness scores compared with slow glycolyzing muscle [170,201]. Preslaughter stress causes depletion of muscle glycogen and therefore limits postmortem glycolysis resulting in meat with an increased ultimate pH [249].

The rate of biochemical reactions in the muscle is strongly affected by temperature. Interactions between pH and temperature during the onset of rigor directly influence meat quality through effects on proteolysis, protein denaturation, and myofibrillar shrinkage [104,201,243,247]. The calpain system is the most likely cause for myofibril-related tenderization and proteolytic activity and autolytic activity of  $\mu$ -calpain is largely a function of the interaction between pH and temperature [35,101,193]. Muscle temperature at pH 6.2 has been used as an important threshold in meat science, because it could be an indirect indication of cold and heat shortening [178]. A rule of thumb for chemical reactions in general is that an increase of 10°C results in a doubling of the reaction rate. At death, livestock muscle temperature is at the normal physiological level ( $\approx 38^\circ\text{C}$ – $40^\circ\text{C}$ ). Once the animal carcass has been processed, it is placed into a cooler at 4°C or less. Temperature has a greater influence on the degree to which glycolytic reactions are slowed and the time course of rigor onset. Carcass subcutaneous fat will act as insulator and can significantly slow the rate of postmortem temperature decline in the carcass. In turn, a faster rate of postmortem glycolysis may be expected because of the higher temperature of the carcass. It is important to note that, within a given carcass, various muscles will display different cooling rates based on their location.

### 7.5.1 Postmortem Changes: Prerigor

Prerigor meat has a higher water-holding capacity and better fat-emulsifying property than postrigor meat, which makes it more suitable for making processed meat products such as sausages [89]. These properties can be maintained if prerigor meat is frozen quickly to temperatures below  $-20^{\circ}\text{C}$ . However, when the frozen meat is thawed, it thaws shortens and loses its water-holding capacity. Adding 1.8% salt to prerigor meat helps to maintain the prerigor attributes for several days when chilled [17,89]. With prerigor salting, water-holding capacity is maintained due to a strong electrostatic repulsion between adjacent protein molecules caused by an initial combined effect of relatively high ATP concentration, and high pH and ionic strength [88]. Adding salt to prerigor meat inhibits ATP turnover but does not affect the rate of glycogen breakdown [88].

#### 7.5.1.1 Cold Shortening

Cold shortening is a phenomenon that occurs in prerigor muscle and results in less tender meat. “Shortening” refers to short sarcomere length characteristic of highly contracted muscle with protein denaturation and water loss [46,143,172]. A rapid chilling may have a detrimental effect via cold shortening, which results in a drastic decrease in tenderness [144]. The degree of overlap between myosin and actin filaments primarily contributed to meat toughening [241]. In another study, there was no relationship between the strength of actin–myosin overlap and meat tenderness. Changes in angles of crisscross connective tissue lattice and crimp length are responsible in part for the relationship between sarcomere length and meat tenderness [98,203]. The toughness of cold-shortened meat was largely affected by an endogenous enzymatic tenderization mechanism rather than shortened sarcomere length [103]. However, sarcomere shortening alone does not cause meat toughness, since heat-shortened sarcomeres have a limited effect on shear force [92,218]. This suggests that the effect of sarcomere length on meat tenderness is dependent on the cause of muscle shortening. There may be a possibility of a more direct cold shortening/toughening relationship in lean carcasses exposed to rapid chilling early postmortem, a relationship that would seem reasonable for lean carcasses with localized subcutaneous fat deposition [126,141]. The effect of shortening sarcomeres on shear force is significantly detrimental when proteolysis is relatively slow. The “cold” refers to the rapid cooling that must occur to observe the effect [103] (Figure 7.4).

If meat is frozen prior to rigor onset and subsequently thawed, it will shorten dramatically and be extremely tough. This phenomenon is referred to as “thaw shortening.” The process of prerigor freezing can damage the sarcoplasmic reticulum and destroy its ability to regulate calcium concentrations within the myofiber. Both calpains and myosin-ATPase require free calcium ions in the cytoplasm for their activities [29]. It has been shown that calcium-reserving organelles lose their function at abnormal cellular temperature [36]. During thawing, all components necessary for muscle contraction are still present, but controls of the reactions are lost. As a result, anaerobic metabolism is processed at a very rapid rate and is concomitant with severe contraction.

#### 7.5.1.2 Electrical Stimulation

Electrical stimulation is the postslaughter application of an electrical current to the animal carcass to accelerate postmortem glycolysis [41,218,234]. Two general systems of electrical stimulation—high (300–500) and low (70–90) voltages—are currently used [21,45,121,149,186,197,225,244,256]. Electrical stimulation involves passing an electric current through the body or carcass of freshly slaughtered animals in a series

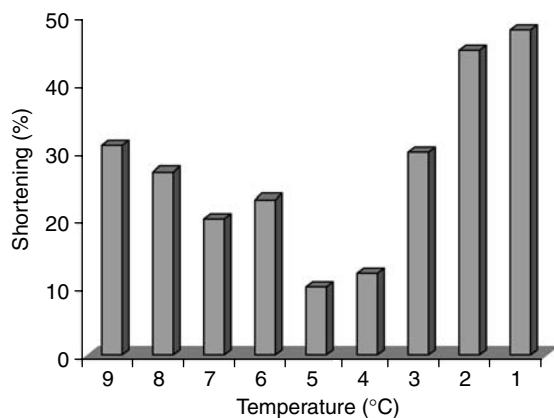


FIGURE 7.4 Relationship between muscle shortening and temperature.

of short pulses, each of which causes the muscles to contract violently, but between pulses, the muscles return to their normal relaxed state [101]. Low-voltage electrical stimulation is less effective for tenderness improvement when compared to high-voltage electrical stimulation. However, low-voltage electrical stimulation application is safer for users and hence offers a more attractive option [59]. The proposed mechanism of electrical stimulation is the prevention of cold shortening by acceleration of rigor mortis onset, while internal muscle temperature remains outside the cold shortening risk zone [234]. Additionally, electrical stimulation causes muscular contraction sufficient to cause physical disruption of tissue [93]. Acceleration of proteolysis could be classified as a secondary effect mediated through time/temperature–pH interaction, affecting factors such as enzyme stability and activity [101]. Because of its simpler mechanism, low-voltage electrical stimulation is most effective where cold shortening is an actual risk due to low chilling temperatures applied in the early postmortem period and where carcasses are sufficiently lean to result in rapid heat dissipation.

#### 7.5.1.2.1 *Acceleration of Postmortem Glycolysis*

Electrical stimulation causes the muscle to undergo continuous contraction–relaxation cycles. The muscle's content of ATP, the compound needed to produce the energy required for muscle contraction, is being depleted thus increasing the rate of glycolysis [101]. The variability in overall ATPase postmortem is primarily responsible for the variability in postmortem pH fall in muscle. This causes the muscle to replenish ATP by accelerating postmortem glycolysis. With the acceleration of postmortem glycolysis, a rapid build-up of lactic acid occurs, and in some cases, the pH of electrically stimulated muscle can reach a pH of 6.0 within a few hours instead of the 12–16 h that may be required for nonstimulated muscles. The high energy of activation means that any cooling of the muscles will markedly increase the time for attainment of rigor mortis with a larger effect in stimulated muscle.

#### 7.5.1.2.2 *Hastening of Rigor Mortis*

The muscle “locks” into rigor mortis when supplies of ATP are depleted, and there is not enough energy to break actomyosin bonds [42]. The physical application of an electric current stimulation mimics this system and results in accelerated muscle metabolism, and serves to hasten the onset of rigor mortis. With the hastening of rigor mortis in the muscle, electrical stimulation can effectively prevent cold-shortening toughness [42] and allow hot boning of carcasses without the need to condition for many hours and without causing detrimental problems with tenderness [92,172]. Thus, for a given time, postmortem anaerobic glycolysis will progress to a more advanced “stage” in carcasses that have experienced electrical stimulation than in those which have not. This allows rigor onset to occur before the musculature reaches low temperatures at which cold shortening take effect.

#### 7.5.1.2.3 *Enhancing of Meat Quality*

Electrical stimulation has been demonstrated to improve most aspects of meat quality, including tenderness, color, and palatability. Chilling for 48 or 72 h would maximize the quality of beef carcasses. However, most beef packers do not have the required facilities to hold carcasses for that length of time before they were graded or shipped. Therefore, electrical stimulation plays an important role for the packer.

There are three theories on the mechanism by which electrical stimulation tenderizes meat. First, because the onset of rigor mortis is hastened by electrical stimulation, muscle fibers do not shorten to the same extent as those from unstimulated carcasses when exposed to cold-shortening temperatures [31,42]. Second, because of the rapid drop in pH caused by the accelerated postmortem glycolysis while muscle temperatures are still high, conditions are favorable for the naturally occurring enzymes responsible for tenderization during the degradation of muscle proteins [56,208]. Third, histological images show the appearance of contracture bands containing predominantly stretched, ill-defined, and disrupted sarcomere from electrically stimulated muscles [55,93,101,226,237,257]. Contractor bands, which may be caused by physical disturbance associated with stimulation-induced contractions, are also observed within some of the electrically stimulated muscle fibers. This structural damage may result in greater fragmentation of the muscle fibers upon chewing or mechanical shearing force, thereby increasing its tenderness [144,209] Formation of contracture bands is dependent on current frequency [74,237] or

interaction between current frequency and voltage [100]. If the time interval between successive stimuli is more than approximately 0.25 s, the muscle titanic shortening is reversible [101]. On the other hand, when a higher frequency of current is applied, muscle may not have enough time for relaxation between successive twitches, and this forms irreversible contracture bands. However, several researchers have disagreed with respect to the importance of structural damage in increasing the tenderness of electrically stimulated meat. In some studies, electron micrographs of electrically stimulated samples revealed protein precipitation, not structural damage. A number of studies have indirectly indicated that physical disruption had less effect on tenderness than did proteolysis [188]. In the light of more recent studies, it is clear that electrical stimulation favors autolysis of calpain rather than proteolytic activity [53,100]. There is also evidence suggesting that both physical disruption and effects on the calpain system arise as a consequence of stimulation.

There is evidence indicating that flavor is significantly improved by applying electrical stimulation [23,206]. This is attributed to the concentration of adenine nucleotides and their derivatives. Another advantage of using electrical stimulation is the reduction in aging time. Electrical stimulation resulted in a substantial decrease in the aging time needed to achieve a specified level of tenderness [207,210].

Meat retailers benefit from the use of electrically stimulated carcasses because of the improved appearance of retail cuts. Meat from electrically stimulated carcasses had brighter color, less surface discoloration, and more desirable overall appearance than nonstimulated carcasses [1,110]. Meat from electrically stimulated sides had a higher percentage of oxymyoglobin (MbO), the pigment responsible for the bright cherry red color of beef, than meat from their nonstimulated counterparts [238]. There is conflict on the persistence of color of electrically stimulated meat. The color-enhancing effect of high-voltage electrical stimulation was reported not to persist beyond 24 h when subjectively scored [238]. Persistent effects of high- and low-voltage electrical stimulation up to 6 days of postmortem were also reported [1,110]. The improved appearance of the meat from electrically stimulated carcasses does not appear to be significantly related to its effects on bacteria [22,75,158].

Findings on the effects of electrical stimulation on water-holding capacity are contradictory. High-voltage electrical stimulation has resulted in a significantly lower drip loss versus nonstimulated control [114]. On the other hand, both high- and low-voltage electrical stimulation significantly increased drip loss [59], while high-voltage electrical stimulation steaks were rated less juicy by taste panel members and showed higher cooking loss [18]. The greater moisture loss results from the physical disruption and reduced water-holding capacity induced by high-voltage electrical stimulation [210]. Denaturation of sarcoplasmic proteins resulting from rapid pH decline may also contribute to moisture loss [60]. However, increased drip loss with the use of electrical stimulation may not be a hazard as the sarcolemma takes a long time to become leaky and exudative despite the disruption of sarcoplasmic proteins [74].

### **7.5.1.3 Pale, Soft, and Exudative Meat**

The pale, soft, and exudative (PSE) condition is most often observed in pork and is a major problem for the meat industry worldwide. PSE meat is described as very soft and tends to sag with meat surfaces that are watery and light colored. When cooked, PSE meat becomes very dry and unpalatable. Its suitability for manufacturing cooked meats is limited due to its poor water-holding capacity. To solve this problem, extensive research on postmortem muscle has been carried out [102,222]. Generally, research on PSE meat is based on two theories of its cause. The two theories may contribute to understanding of what happens to light as it passes along the longitudinal axes of muscle fibers. Shrinkage of myofibrils at a low pH would increase the refractive index differences relative to surrounding sarcoplasm, thus increasing reflectance at the myofibrillar surface [86]. A micrograph obtained by scanning with a confocal light microscopy has been supportive of this theory. On the other hand, light microscopy showed sarcoplasmic proteins precipitated in PSE meat [11]. Porcine myoglobin is more susceptible to acid denaturation than are bovine and ovine myoglobin [205]. Sarcoplasmic proteins are more readily denatured than myofibrillar proteins, especially when high postmortem temperatures created by exothermic glycolysis interact with the low pH caused by glycolysis [68]. Animals that are exposed to stressful conditions prior to slaughter may produce PSE meat.

Animals that yield PSE meat display an abnormally high rate of anaerobic glycolysis immediately following slaughter. The rapid biochemical reactions produce heat so quickly that muscle temperature

immediately after slaughter may exceed the normal physiological level. The elevated glycolytic rate also means that muscle pH decreases rapidly leading to a relatively high-temperature/low-pH condition, which would be sufficient to disrupt some muscle protein structure. Therefore, the ability of muscle protein to bind water is compromised and moisture is expressed on cut surface, yielding a wet appearance. In addition, the surface wetness results in an increased reflectance of light and a paler appearance.

The ultimate pH of meat from PSE carcasses is generally a bit lower than normal carcasses. At 45 min postmortem, the pH of normal meat is generally >6.4–6.5, whereas the pH of PSE sample will be <6.0. Thus, in the PSE condition, postmortem anaerobic metabolism occurs at a faster rate and to a slightly greater extent than in normal carcasses.

Hunter  $L^*$  values can be used as one of the parameters for PSE meat [102,247]. The increased surface lightness for high pH and after-aging is believed to be associated with increased free water at the tissue surface resulting in an increased reflectance and consequently lighter appearance [177].

#### **7.5.1.4 Dark Firm and Dry Meat**

The dark firm and dry (DFD) phenomenon is typically characterized by meat that is darker than normal and would not bloom when exposed to air [58,72]. In this type, meat surfaces appear dry, and the pH of the meat is higher than normal and usually obtained from animals that have been exposed to long-term preslaughter stress. In some cases, even penning with strange animals will result in utilization of a significant portion of their muscle glycogen stores. At slaughter, the glycogen pool (depleted during exposure to stress) has less glucose available for glycolysis. The extent to which anaerobic metabolism can take place is also shortened. This, in turn, results in decreased formation of  $H^+$  and lactate, and the ultimate pH of the meat becomes higher than normal. Therefore, the extent, not the rate of anaerobic metabolism, is shortened, causing rapid rigor onset. Muscle of high ultimate pH has a greater water-holding ability than that of normal pH. Therefore, although DFD meat is undesirable for the retail meat case, it may have a value to meat processors.

The appearance of DFD meat is partly related to mitochondrial activity because mitochondria survive and function better at high-pH conditions than in normal-pH meat. As the relative oxygen-consumption activity of DFD meat is greater, deoxymyoglobin (Mb) predominates, and subsequent oxidation to metmyoglobin (MetMb) is enhanced. The dark appearance of DFD meat may also be related to the hydration state of myofibrillar proteins. The elevated pH is a characteristic of DFD meat and allows for greater hydration of myofibrillar protein in DFD meat than in normal, lower-pH meat. These proteins bind moisture more tightly resulting in less moisture on cut meat surfaces. This results in less reflected light from the meat surface, yielding the dry, dark appearance.

### **7.5.2 Postrigor Postmortem Changes**

The exact point at which conversion of muscle to meat is completed is not easy to determine, although the establishment of rigor mortis is generally accepted to be the point. Although the functional role of skeletal muscle is lost and rigor has been established, metabolic activity of the tissue does not stop. Many biochemical processes, some of which have significant implications for the meat quality characteristics, may still occur.

#### **7.5.2.1 Meat Color**

Meat color is an extremely important sensory characteristic according to which consumers make judgments of meat quality. It is influenced by the pigment content, the chemical form of pigment, and the meat structure [139]. Some residual blood may also be present in meat, but it is generally minimal and is of little practical importance in considerations of meat color. The degree of meat pigmentation is directly related to myoglobin content. In general, myoglobin concentration within a given muscle will differ according to the species or age and is dependent on muscle fiber distribution [132]. Muscle composed predominantly of red fibers contains more myoglobin than muscles with high white fiber content. Meat that does not have the acted cherry red color is discriminated against. This implies that meat color determines the shelf life of meat. Cuts of meat that are darker due to too much MetMb will be viewed as old and undesirable for consumption.



The heme group contains a centrally located iron atom, which has six coordination sites available for chemical bonds. Four of these sites bond the iron atom within the heme structure. The fifth bond links the iron atom to the amino acid chain. The sixth site bonds the iron atom to a chemical group. The oxidation of heme iron and the chemical group bond at the sixth site will determine the meat color. The relative proportions of the three myoglobin forms, Mb, MbO, and MetMb, affect the color of fresh meat [139]. The relative amounts of Mb, MbO, and MetMb in the meat depend on the oxygen availability, the autoxidation rate of myoglobin, and the MetMb-reducing capacity [133]. The oxygen availability depends on the oxygen partial pressure, penetration, and consumption rate of the muscle [133]. The penetration depth of light decreases as an effect of increased light scattering due to an increased amount of water outside the myofibrillar space induced by the pH drop during glycolysis [66]. The meat surface may be more or less translucent depending on the rate of postmortem pH drop, ultimate pH, and the extent of protein denaturation [12,66]. During postmortem glycolysis, the sarcoplasmic proteins denature and precipitate on the myofibrils, resulting in increased light scattering and less light penetration [66]. All these processes occur within the small heme portion of the larger myoglobin protein. When heme iron is in the ferrous form and lacks a ligand at the sixth position, it is referred to as “deoxymyoglobin.” The color of Mb is purplish-red, which is characteristic of fresh meat. Ferrous myoglobin that is exposed to air will bind oxygen at the sixth coordination site and form MbO. MbO is cherry red and typical of fresh meat displayed in retail outlets. The process by which Mb binds oxygen and consequently gets converted to MbO is called “oxygenation.” It is important that this should not be confused with “oxidation.” The process of oxidation occurs in myoglobin when ferrous (+2) iron (Mb or MbO) is converted to ferric (+3) iron and leads to the third form of myoglobin found in fresh meat, MetMb. MetMb is brownish-red in color and is characterized by ferric iron with a water molecule bound at the sixth position. The oxidation of Mb or MbO leads to the formation of MetMb; this process occurs gradually over the surface of meat cuts during storage and display.

The myoglobin form, which predominates in the surface of meat, determines the perceived color. A typical scenario for color expression of the various myoglobin forms can be observed during the cutting of meat. The deep portion of a fresh piece of meat is anoxic, and when sliced, will reveal an interior that is purplish-red in color. Following exposure to air for 20–30 min, Mb will oxygenate to form cherry red MbO. As display time increases, MbO will oxidize to MetMb and the portion of meat displaying undesirable brownish discoloration will increase. The rate of MetMb formation is dependent on several factors, including the specific muscle, display temperature, type and intensity of lighting, and bacterial load. The pH drop during postmortem glycolysis results in increased internal reflectance [12], increased lightness of the meat [115], decreased penetration depth of light, and changes in the selective light absorption through chromospheres like myoglobin and hemoglobin [66].

Color deterioration and lipid oxidation may be linked, although the precise mechanisms are still unclear [195]. Some control over increased susceptibility to oxidation can be attained by feeding higher levels of vitamin E, as an antioxidant active in meat [4]. The delaying of myoglobin oxidation is accomplished in a variety of ways. These include storage and display of meat under refrigerated conditions, hygienic preparation of meat cuts, and selective use of lighting. In addition, the application of antioxidants, such as ascorbic acid (vitamin C), citric acid, or  $\alpha$ -tocopherol (vitamin E), may extend color shelf life.

### **7.5.2.2 Role of Mitochondria**

Mitochondria utilize oxygen in performing their normal role within cells. They have a high affinity for oxygen and may remain active in meat stored at normal refrigeration temperatures. It is generally agreed that mitochondria have an important indirect effect on meat color, particularly in creating conditions likely to affect the oxidation of myoglobin [132]. It appears that meat cuts that possess high mitochondrial activity have a shorter color shelf life than those cuts with lower mitochondrial activity. Mitochondria also might have a direct effect in absorbing light [235].

Prerigor muscle contains a greater proportion of actively respiring mitochondria than postrigor muscle. Therefore, the color of prerigor muscle is more purplish-red than that of postrigor muscle. The consumption of oxygen by mitochondria makes the oxygen unavailable for binding by myoglobin; the Mb form predominates and yields the purplish-red color. One drawback to the predominance of Mb in pre- and postrigor meat is its lower stability relative to its ferrous MbO counterpart. Postrigor meat with

**TABLE 7.1**

Saturated (SFA), Monounsaturated (MUFA), and Polyunsaturated (PUFA) Fatty Acid Percent of Muscle Foods

Species	% SFA	% MUFA	% PUFA
Beef	55.5	52.0	3.0
Pork	44.0	56.5	10.5
Mutton	55.0	41.5	4.0
Poultry	30.5	45.0	18.5
Fish	30.0	33.0	37.0
Goat	51.3	43.5	5.09

concentration of polyunsaturated fatty acids [151]. It has been demonstrated that dietary fat and vitamin E supplementation can influence the antioxidant enzyme activities in meat [9,195]. Fatty acids are chains of carbon atoms with a carboxylic acid group at one end. They vary in length according to the number of carbon atoms that comprise their backbone and may be saturated or unsaturated. Saturated fatty acids are more solid at room temperature and contain no double bonds between carbon atoms. Unsaturated fatty acids may contain one (monounsaturated) or several (polyunsaturated) double bonds between the carbon atoms and are generally liquid at room temperature. It should be noted that proportions of saturated, monounsaturated, and polyunsaturated fatty acids in animal tissues depend on species (Table 7.1). In monogastric species such as pigs and chickens, they may be influenced by diet.

Saturated fatty acids are regarded as harmful to human health in contrast to polyunsaturated fatty acids, which play a favorable role in the prevention of some human artery diseases [151]. Therefore, increasing the proportion of polyunsaturated fatty acids in meat is currently recommended. Meat from monogastric animals contains high levels of unsaturated fatty acids relative to meat from ruminants. Feeding of polyunsaturated fatty acids to monogastric animals to improve the quality of their meat for human nutrition increases this susceptibility to oxidation further [135,175,200]. Microorganisms in the rumen perform extensive hydrogenation of fat and consequently increase the degree of saturation lipids [261]. Meat fatty acid composition is influenced by a number of factors, including muscle type and its oxidation [73,260]. Factors that make muscle lipids susceptible to oxidation are either intrinsic to the products or related to technological process [33,199]. Oxidation of muscle lipids produces primary and secondary products such as hydroperoxides, free radical, endoperoxides, malondialdehyde (MDA), epoxides, alkanes, hydrocarbons, alcohol, thiobarbituric acid reactive substance, and also acids that may be toxic to humans [84]. Oxidation of meat may be reflected in off-odors and flavors detected by sensory panels. It may also result in increased peroxide values or compounds, mainly MDA, giving a red color when reacted with thiobarbituric acid. Increasing aging time from 8 to 15 days produced increased levels of MDA due to normal oxidation processes occurring in refrigerated meat. Differences in MDA between meat samples aged from 8 to 15 days were still detected after 4–8 months of frozen storage. Initial storage conditions may affect subsequent lipid stability of frozen meat regardless of the storage temperature [85]. At a frozen temperature of  $-20^{\circ}\text{C}$ , usually used for domestic storage, MDA content increased with increased storage time [34]. Low level of hydroperoxides in fresh meat increases rapidly to reach a maximum after several months of freezing. The threshold value for rancidity is 1–2 mg MDA/kg of meat [250]. However, consumers are unlikely to detect off-flavor at values below a threshold of about 0.5 mg MDA/kg [83].

The double bonds located within polyunsaturated fatty acids are sites of chemical activity. Oxygen is a key element for lipid oxidation and may react with these sites to form peroxides, which lead to rancidity. Polyunsaturated fatty acids are susceptible to rancidity due to the double bonds. Meat with high concentrations of polyunsaturated fatty acids can develop rancid flavor faster than meat with less polyunsaturated fatty acids. The interaction of oxygen with polyunsaturated fatty acids is a nonenzymatic process. Vacuum packaging of meat products therefore provides longer shelf life by excluding oxygen from the packaging.

Enzymic-based lipid oxidation occurs in meat also known as microsomal lipid oxidation. This process requires certain biochemical cofactors, including reduced forms of nicotine adenine dinucleotide

a higher concentration of mitochondria will have a greater proportion of its ferrous myoglobin in the Mb state and that will be converted to MetMb faster than if MbO had been allowed to form [171].

### 7.5.2.3 Lipid Oxidation

Although lipid in meat contributes significantly to flavor, its oxidation will result in the production of free radicals, which lead to the formation of rancid odors and off-flavor. Oxidation might also play a role in controlling proteolytic activity of enzymes and could be linked to meat tenderness. The oxidative stability of meat depends upon the balance between anti- and prooxidants, including the

phosphate or nicotine adenine dinucleotide, adenosine diphosphate, and iron ions. The enzymatic nature of the process implies involvement of membrane-bound proteins. Cooking of meat provides sufficient heat to denature enzymes, and therefore, enzymic/microsomal lipid oxidation will not occur in cooked meats. During normal physiological functioning, the enzymes found in these subcellular organelle membranes produce chemically reactive substances known as radicals. These are a necessary part of normal cell functioning, and in the "living state" the cell has a variety of mechanisms for protecting itself against the undesirable actions of radicals. In postmortem, many of these protections are lost; therefore, radicals may hasten lipid oxidation and consequently cause rancidity.

#### **7.5.2.4 Warm-Over Flavor**

Usually food contains complex mixtures of volatile compounds that cause a variety of odors, often comprising hundreds of chemical compounds [84,176]. These chemicals produce several primary odors that may result in various sensations due to their interaction with primary receptors. Warm-over flavor (WOF) is used to describe the oxidized flavor that develops in meat following a thermal treatment after a few hours of refrigerated storage [84]. WOF includes odors and tastes commonly described as stale, "cardboard-like," "painty," "rancid," "bitter," "sour" as well as others [142,229]. Processes involving action that disrupts the muscle fiber membrane, such as chopping, restructuring, or heating would enhance meat WOF [152,228]. This particular alteration is the main reason for the slow development of some cooked meat products [91,147].

Development of WOF during chill storage of precooked meat has been of continuing interest in recent years in relation to improving the quality of ready-to-eat meals [20]. It is generally accepted that autoxidation of membrane phospholipids is largely responsible for the development of WOF [104,229]. However, there is evidence suggesting that the degradation of proteins and heteroatomic compounds may also be involved in the development of WOF [227,230]. Metal ions are potent catalysts of nonenzymatic lipid oxidation. Meat is an excellent source of many metals, including iron. In addition to its nutritional benefit, iron can also serve to enhance lipid oxidation in meats. Simply grinding meat through a cast-iron meat grinder can increase the concentrations of nonheme iron. The grinding process provides sufficient heat to denature myoglobin allowing iron, which is bound within the heme molecule to be liberated. During the time period between initial cooking and reheating, the iron acts to catalyze lipid oxidation. This occurs in cooked meat that is stored under refrigerated conditions such as leftovers where warm temperatures of the reheating process may also accelerate lipid oxidation resulting in the development of rancid flavors. The development of WOF in various types of meat through the level of thiobarbituric-acid-reactive substance has been documented [84,228,230]. There is a positive correlation between thiobarbituric-acid-reactive substance values and sensory panel evaluation scores [84,153,231]. The assessment of meat odors is commonly done through human subjective assessment and headspace/direct gas chromatography/mass spectrometry. Trained panels can determine aroma changes due to taints and off-odors and can develop flavor descriptors to better assess a certain product quality [84,176].

---

## **7.6 Meat Storage and Safety**

Meat is an unstable product largely because microorganisms thrive on its rich supply of nutrients. Meat spoilage occurs when undesirable odors and flavors are produced by changes in meat. When meat is not properly preserved, it often spoils and then potentially harmful food-poisoning organisms or their products become present in toxic amounts. Although most people may view spoiled meat as inedible, and therefore these meats are often not consumed, spoilage may serve as a protective or warning system.

Enzymes, the compounds that catalyze chemical reactions within the meat, are able to produce chemical and physical changes that alter the physical and palatability characteristics of the meat. These alterations produce meat spoilage. Many meat enzymes function better and at a faster rate at or near normal body temperature and neutral pH. Low temperature, the presence of high concentrate of ions such as sodium and chloride, low pH, and reduced moisture slow enzyme activity. Cooking and other treatments may permanently inactivate enzymes.

### 7.6.1 Refrigeration of Meat

The development of refrigeration had more impact on meat preservation than any other technological advancement. Proper refrigeration, therefore, not only lowers the temperature of the muscle as such, but also slows down the rate of glycolysis as the temperature is lowered. Chilling is the most energy-expensive aspect of carcass processing [174]. However, the use of blast chilling and rapid air movement at 1–5 m/s for 1–5 h to rapidly cool carcasses, dramatically reduced necessary cooler operation time. Controlling airflow inside industrial meat chillers is of paramount importance because it determines both the efficiency and the homogeneity of carcass chilling [156]. The use of rapid chilling results in lower shrink loss that accompanies a reduced chilling period [19,173,259]. Application of blast chilling to meat may result in cold-induced toughening and therefore compromise meat quality. An impairment of autolytic enzyme system functions may be responsible for this toughening in addition to the expected effects of cold shortening. At a constant rigor temperature of 35°C, almost 80% of the  $\mu$ -calpain activity was lost during rigor development (within 5 h after slaughter), while only about 20% of the activity was lost when meat was exposed to a constant rigor temperature of 15°C (within 27 h after slaughter) [218]. This inactivation process could be the explanation for the differences in tenderness between meats with fast and slow pH time courses when exposed to the same chilling regime [248]. However, ultrarapid chilling of carcasses (–20°C) was reported to produce meat as tender as that from carcasses chilled at 4°C and reduced evaporative weight losses by 0.5%–1% [150,215,216]. Therefore, blast chilling may be best used in conjunction with electrical stimulation to accelerate the onset of rigor mortis to avoid development of cold shortening. There are two approaches to inactivate microorganisms: one is to change the environment and the other is to decrease the tolerance of the microorganisms. In meat sterilization, inactivation of dormant bacterial spores is the main objective. These spores are highly resistant to many physical processes, including heat, drying, radiation, and chemicals such as hydrogen peroxide. As germinated spores are not resistant to these agents, it is effective to germinate dormant spores and then inactivate them.

Rapid chilling of meat may produce negative effects on quality such as a darker lean color than control carcasses [110]. This is due to subtle changes in rate and extent of pH decline during chilling. Vacuum-wrapped cuts, at the proper temperatures, may be displayed for extended time periods during marketing without the occurrence of damaging microbial growth. Many of the organisms that influence meat spoilage require the presence of oxygen to grow. The vacuum-packed meat is also preserved from weight loss and discoloration. Sanitation programs throughout the slaughterhouse, chilling, and packaging operations will maximize the shelf life of chilled cuts. Reducing initial microbial contamination of meat significantly decreases the influence of microbes to change meat odor, appearance, and flavor.

Modern chilling coolers operate at lower relative humidity than in the past to reduce condensation, which is a source of contamination. The lower relative humidity enhances evaporation of water, which is required for the absorption of heat from the carcass surface, speeding up the postslaughter chilling process and minimizing microbial growth. The refrigeration technology will maintain the meat temperature below –18°C, within the “super chill zone” between 0°C and the temperature at which ice crystals form in the product (–2°C), and will further extend the shelf life of chilled fresh meats [160].

### 7.6.2 Aging and Meat Tenderization

Meat has been aged to improve its characteristics since olden times. Aging is necessary as meat is often unacceptably tough immediately following rigor onset. The time required for aging varies with the type of meat. High-temperature conditioning may accelerate the aging process by keeping carcasses at temperatures of 15°C or greater [177]. This type of conditioning may be applied in the pre- or postrigor state and is very effective in improving meat tenderness. It is believed that, during the aging process, tenderization occurs as a result of protein degradation. The aging processes originate within the myofiber and are responsible for degradation of cellular constituents.

Analysis of muscle proteins along with meat quality traits during chiller aging is crucial in understanding the biological basis of changes in meat quality. The proteolytic enzymes in meat that have been most studied are the cathepsins and calpains. Aging between 6°C and 43°C had significant effects on hunter  $L^*$ , shear force values, and drip loss [103]. The most relevant consequence of aging is an improvement in meat

tenderness [110,204]. As aging time increased tenderness improved [34,99,157]. The tenderization process involves complex changes in muscle metabolism in the postslaughter period and is dependent on animal breed, metabolic status, and environmental factors such as rearing system and prior slaughter stress. During aging, the structure of the myofibrillar and other associated proteins undergoes some modifications, and collagen is weakened to a lesser extent [30,52,126]. Degradation of 9 actin and actin-relevant peptides out of 20 identified ones is related to meat quality traits during aging [103]. The proteolytic enzymes in meat play a significant role in improving meat tenderness during aging. Enzymes require specific conditions such as temperature and pH for optimal activity, and these can be determined and maximized in meat to improve meat tenderness. It is possible to breed animals for high-proteolytic-enzyme activities. Genetic engineering might also be used to achieve more tender meat. Cathepsins are located within lysosomes and operate best at pH <5.2 values. Myofibrillar proteins are degraded when incubated with various cathepsins *in vitro*. It is believed that catheptic enzymes are able to act at the pH of meat to produce tender meat by degrading myofibrillar proteins. Cathepsins are effective proteolytic agents that have been identified in meat.

Calpains are proteases that require calcium ions ( $\text{Ca}^{2+}$ ) for activity. There are two types of calpains found in the sarcoplasm: one requires a high concentration of free calcium ( $\approx 300\mu\text{M}$ ) for activation, and the other requires a low concentration of free calcium ( $\approx 5\mu\text{M}$ ). The amount of calcium available in normal muscle cells excludes the high-calcium-requiring calpain as a major contributor to meat tenderization. Both types of calpains require a high pH, <6.6, for optimal activity. This value is substantially higher than pH 5.6 of normal meat; therefore, maximum activity of calpains would most likely occur during the early postmortem condition.

Degradation of cytoskeletal proteins such as desmin, vinculin, titin, and nebulin was considered to be responsible for changes in water-holding capacity during aging [7,129,131]. Formation of drip is generally considered to be a result of denaturation of contractile proteins and shrinkage of myofibrils during rigor development [13,103]. On the other hand, reduced drip loss was related to the "leak-out" effect and aging itself did not improve water-holding capacity. Higher rigor temperature accelerated drip loss during vacuum-packed storage, and drip loss increased at a high pH (6.2) as aging time lengthened [103]. The effect of early postmortem pH and temperature on meat quality is dependent on aging time. In addition, this affected meat color by influencing the surface reflectance [177]. Injection with calcium/sodium chloride after slaughter accelerated postmortem tenderization and increased tenderness in meat sample apparently by enhancing the activity of the endogenous calcium-dependent proteases (m- and  $\mu$ -calpain) [111,162,187,211,213].

Flavor intensity increased with aging time [25,157]. This may be due to postmortem processes such as proteolysis and lipolysis resulting in development of flavor precursors. Many peptides are produced during aging [34]. They can react with other molecules thus producing new flavor compounds [125]. Another source of volatiles in meat with age is the degradation of lipid. During cooking, these compounds may be oxidized further and react with Maillard products to give many other compounds that may contribute to flavor [63]. Therefore, aging meat for the development of flavor, aside from its tenderizing effect, becomes a questionable practice for meat that is to be held in zero storage for more than 6 months. The holding period has a direct effect on the storage life because it permits oxygen absorption by the exposed fat.

### 7.6.3 Freezing of Meat

Freezing is a common practice in preserving meat quality for an extended time and offers several advantages. These indicate insignificant alterations in product dimensions and minimum deterioration in meat color, flavor, and texture. The disadvantages of frozen storage include freezer burn, dehydration, rancidity, drip loss, and product bleaching. Many meat products go directly from the freezer to cooking. Since the cooked appearance of frozen cuts does not differ from fresh cut [166], the consumer is not able to differentiate between the two. The shelf life extension and the purchasing and inventory flexibility offered by frozen meat items are valuable assets in the food service industry.

Drip loss is one of the most important problems in frozen meat [123]. The freezing of meat has been widely studied to enable lowering the amount of drip losses on thawing. The loss of fluid generally reduces the eating quality, binding ability, and the weight of the meat; all these factors contribute to

meat value. The volume of drip produced on thawing has been related to the rate of freezing, which in turn has been related to the size and location of ice crystals in frozen meat. The size of the crystals formed is generally considered responsible for changes in meat quality. The loss of moisture in frozen-thawed meat may reach 85% of the water in muscle tissue. This water is located intracellular in the myofibrils and the remaining 15% is located in the extracellular space [87]. The main part of the water is held by capillary action [169], and a small amount (4%–5%) is restricted in motion because of the proximity of the protein molecules [87,258]. When the muscle is frozen, water associated with protein is replaced with protein [67], which leads to decreased water-holding capacity after thawing. Thawing conditions should aim to minimize drip losses, microbiological growth, evaporation losses, and deterioration reactions. The most critical temperature in thawing meat is between  $-10^{\circ}\text{C}$  and  $-2^{\circ}\text{C}$ ; therefore, meat must rapidly pass this range [24]. It is generally believed that rapid chilling compromises the ability of sarcoplasmic reticulum and mitochondria to retain calcium. Calcium is released into the sarcoplasm in an uncontrolled manner; this causes substantial contraction in the presence of ATP. Therefore, the formation of extracellular ice crystals during freezing that dehydrate the fibers within large-volume products is difficult to avoid. The thermal gradient between the interior and exterior of meat determines the cooling/freezing rate of the meat; this value decreases toward the center of the product, which is practically important in large-volume products. The freezer storage period of meat can be lengthened by omitting the seasoning and then adding the seasoning after the thawing. An antioxidant such as BHA, BHT, or propyl gallat may be added at the second grinding.

Although freezing acts as a preservation method by inactivating the meat enzymes and inhibiting the growth of spoilage organisms, it initiates several physical and physicochemical changes in meat that lead to the deterioration in quality [97]. Some of the quality changes are associated with ice crystal formation: it is believed that at very low temperatures, recrystallization is very slow and equilibrium is approached while the crystals are small. At temperatures near the melting point, recrystallization is rapid. The lower the temperature, the greater the inhibitory action and the longer the period of satisfactory storage. Most of the vitamin loss is caused by heat or light or is lost in the juices that escape. The functionality of meat is adversely affected by long-term frozen storage [154]. Protein denaturation at low temperatures is a mirror image of the denaturation of proteins at higher temperatures, which lead to loss of water [69]. The rate of crystallization and the size of the crystals formed depend upon the temperature [194]. Slow freezing causes the water to separate from the tissue into pools that form large crystals, which may result from greater structural damage associated with larger intercellular ice crystals [64,164]. These stretch and rupture some of the surrounding tissue. Rapid freezing results in very little water separation; therefore, the crystals are small and less expansive. Because there is practically no pool crystallization in very low temperature freezing, the drip is considerably less than from meats frozen at higher temperatures. Fluctuations in temperature that occur during storage cause recrystallization phenomena and may explain the deterioration in meat quality over frozen storage [14]. Recrystallization involves changes in the number, size, shape, orientation, or perfection of crystals following completion of initial solidification. It is the phenomenon of preferential growth of the solid state of large crystals at the expense of smaller ones. It primarily results from surface energy differences in free energy due to internal strains [164]. Recrystallization in meat involves the growth of the ice crystals, which tend to disappear, with the consequent reduction in the total number of crystals and enlargement of the average crystal size. The solubility of myofibrillar proteins is lower in slowly frozen meat compared to fast-frozen ones [64,179]. Drip loss from thawing meat includes proteins, vitamins, and other nutrients, in addition to moisture, and results in decreased cooked yields and juiciness.

---

## 7.7 Conclusion

Meat postharvest handling and storage, ranging from very fundamental to very applied, has been reviewed in this chapter. Much has been learned in recent years about the pre- and post-rigor conditions and their role in the determination of meat quality. The major changes in meat have to do with flavor, texture, and microbial quality. Therefore, the more classic approach of study of muscle anti- and postmortem biochemical and morphological has been pursued with greater refinement. Therefore, the following points can be concluded: (i) the aim of proper meat postharvest is to supply high-quality, safe,

and wholesome meat and meat products to consumers; (ii) muscle is naturally sterilized but meat is readily prone to spoilage and contamination from preslaughter handling, processing, and storage; (iii) to encounter these factors and to provide better postharvest conditions, technology has been developed in the following areas: workplace and tools sanitations, chilling temperatures, blast freezing, decontamination carcasses, and proper packaging.

---

## References

1. Aalhus, J.L., Best, D.R., Costello, F. and Jeremiah, L.E. (1999). A simple on line processing method for improving beef tenderness. *Can. J. Anim. Sci.*, 79: 27.
2. Al-Raisi, A. (2003). An Evaluation of Microbiological Status and Development of Hazard Analysis Critical Control Points (HACCP) Plan for the Central Slaughterhouse, Muscat, Sultanate of Oman. M.Sc. thesis, Department of Food Science and Nutrition, College of Agricultural and Marine Sciences, Muscat, Sultanate of Oman.
3. Armstrong, G.L., Hollingsworth, J. and Morris, J.G. (1996). Emerging foodborne pathogens: *Escherichia coli* O157:H7 as a model of entry of a new pathogen into the food supply of the developed world. *Epidemol. Rev.*, 18: 29.
4. Asghar, A., Gray, J.I., Booren, A.M., Goma, E.A., Abouzied, M.M. and Miller, E.R. (1991). Effects of superan nutritional dietary vitamin E levels on sub cellular deposition of  $\alpha$ -tocopherol in the muscle and on pork quality. *J. Sci. Food Agric.*, 57: 31.
5. Bacon, R., Sofos, J.N., Belk, K.E. and Smith, G.C. (2002). Application of a commercial steam vacuum unit to reduce inoculated *Salmonella* on chilled fresh beef adipose tissue. *Dairy Food Environ. Sanit.*, 22: 184.
6. Barkate, M.L., Acuff, G.R., Lucia, L.M. and Hale, D.S. (1993). Hot water decontamination of beef carcasses for reduction of initial bacterial numbers. *Meat Sci.*, 35: 397.
7. Baron, C.P., Jacobsen, S. and Purslow, P.P. (2004). Cleavage of desmin by cysteine proteases: Calpains and Cathepsin B. *Meat Sci.*, 68:447–456.
8. Basol, M.S. and Gogus, U. (1996). Methods of antibiotic applications as related to microbial quality of lamb by PCA and bioluminescence. *J. Food Sci.*, 61: 348.
9. Batifoulier, F., Mercier, T., Gatellier, P. and Renner, M. (2002). Influence of vitamin E on lipid and protein oxidation induced by H<sub>2</sub>O<sub>2</sub>-activated MetMb in microsomal membranes from turkey muscle. *Meat Sci.*, 61: 389.
10. Bell, M. and Hathaway, S.C. (1996). The hygienic efficiency of conventional and inverted lamb dressing systems. *J. App. Bacteriol.*, 81: 225.
11. Bendall, J.R. and Wismer-pedersen, J. (1962). Some properties of the fibrillar proteins of normal and watery pork muscle. *J. Food Sci.*, 27: 144.
12. Bendall, J.R. and Swatland, H.J. (1988). A review of the relationships of pH with physical aspects of pork quality. *Meat Sci.*, 24: 85.
13. Bertram, H.C., Chafer, A., Rosenvold, K. and Andersen, H.J. (2004). Physical changes of significance of early post mortem water distribution in porcine *M. longissimus*. *Meat Sci.*, 66: 915.
14. Bevilacqua, A.E. and Zaritzky, N.E. (1982). Ice recrystallisation in frozen beef. *J. Food Sci.*, 47: 1410.
15. Biss, M. and Hathawa, S.C. (1996). The effect of different on-line dressing practices on microbiological and visible contamination of lamb carcasses. *NZ Vet. J.*, 44: 55.
16. Bolder, N.M. (1997). Decontamination of meat and poultry carcasses. *Trends Food Sci. Technol.*, 8: 221.
17. Boles, J.A. and Swan, J.E. (1996). Effect of post-slaughter processing and freezing on the functionality of hot-boned meat from young bull. *Meat Sci.*, 44: 11.
18. Bouton, P.E., Ford, A.L., Harris, P.V. and Shaw, F.D. (1980). Electrical stimulation of beef sides. *Meat Sci.*, 4: 145.
19. Bowling, R.A., Dutton, T.R., Smith, G.C. and Savell, J.W. (1987). Effects of cryogenic chilling on beef grade, shrinkage and palatability characteristics. *Meat Sci.*, 21: 67.
20. Brøndum, J., Byrne, D.V., Bak, L.S., Bertelsen, G. and Engelsen, S.B. (2000). Warmed-over flavour in porcine meat—a combined spectroscopic, sensory and chemometric study. *Meat Sci.*, 54: 83.
21. Bruce, H.L., Stark, J.L. and Beilken, S.L. (2004). The effects of finishing diet and postmortem ageing on the eating quality of the *M. longissimus thoracis* of electrically stimulated Brahman steer carcasses. *Meat Sci.*, 67: 261.

22. Butler, J.L., Smith, G.C., Savell, J.W. and Vanderzant, C. (1981). Bacterial growth in ground beef prepared from electrically stimulated and non-stimulated muscles. *Appl. Environ. Microbiol.*, 41: 915.
23. Calkins, C.R., Savell, J.W., Smith, G.C. and Murphey, C.E. (1980). Quality-indicating characteristics of beef muscle as affected by electrical stimulation and postmortem chilling time. *J. Food Sci.*, 45: 1330.
24. Calvelo, A. (1981). Recent studies on meat freezing. *Developments in Meat Science* (Ed. Lawrie, R.A.) New Jersey: Applied Science Publishers, pp. 125–159.
25. Campo, M.M., Sanudo, C., Panea, B., Alberti, P. and Santolaria, P. (1999). Bred type and ageing time effects on sensory characteristics of beef strip loin steaks. *Meat Sci.*, 51: 383–390.
26. Carse, W.A. (1973). Meat quality and the acceleration of postmortem glycolysis by electrical stimulation. *J. Food Technol.*, 8: 1163.
27. Cassens, R.G., Marple, D.N. and Eikelenboom, G. (1975). Animal physiology and meat quality. *Advan. Food Res.*, 21: 71.
28. Castillo, A., Lucia, L.M., Goodson, K.J., Savell, J.W. and Acuff, G.R. (1998). Comparison of water wash, trimming and combined hot water and lactic acid treatments for reducing bacteria of faecal origin. *J. Food Prot.*, 61: 823.
29. Celio, M.R., Pauls, T.L. and Schwaller, B. (1996). *Guidebook to the Calcium-Binding Proteins*. New York: Oxford University Press.
30. Christensen, M., Larsen, L.M., Ertbjerg, P. and Purslow, P.P. (2004). Effect of proteolytic enzyme activity and heating on the mechanical properties of bovine single muscle fibres. *Meat Sci.*, 66: 361.
31. Chrystall, B.B. and Hagyard, C.J. (1976). Electrical stimulation and lamb tenderness. *NZ J. Agric. Res.*, 19: 7.
32. Chung, K.C. and Goepert, J.M. (1970). Growth of *Salmonella* at low pH. *J. Food Sci.*, 35: 326.
33. Cifuni, G.F., Braghieri, A., Napolitano, F., Riviezzi, A.M. and Girolami, A. (2001). Influence of storage conditions and age at slaughter on lipid oxidation and fatty acid profile of Apulian lamb. *Italian J. Food Sci.*, 13: 329.
34. Cifuni, G.F., Napolitano, F., Riviezzi, A.M., Braghieri, A. and Girolami, A. (2004). Fatty acid profile, cholesterol content and tenderness of meat from Podolian young bulls. *Meat Sci.*, 67: 289.
35. Claeys, E., De Smet, S., Demeyer, D., Geers, R. and Buys, N. (2001). Effects of rate of pH decline on muscle enzymes activities in two pig lines. *Meat Sci.*, 57: 257.
36. Cornforth, M.R., Pearson, A.M. and Merkel, R.A. (1980). Relationship of mitochondria and sarcoplasmic reticulum to cold shortening. *Meat Sci.*, 4: 103.
37. Corrier, D.E., Purdy, C.W. and Deloach, J.R. (1990). Effect of marketing stress on fecal excretion of *Salmonella* spp. in feeder calves. *Am. J. Vet. Res.*, 51: 866.
38. Cortesi, M. (1994). Slaughterhouse and human treatment. *Rev. Sci. Off. Int. Epiz.*, 13: 171.
39. Cortright, R.N., Muoio, D.M. and Dohm, G.L. (1997). Skeletal muscle lipid metabolism: A frontier for new insights into fuel homeostasis. *J. Nutr. Biochem.*, 8: 228.
40. Costilow, R.N., Uebersax, M.A. and Ward, P.J. (1984). Use of chlorine dioxide for controlling microorganisms during the handling and storage of fresh cucumbers. *J. Food Sci.*, 49: 396.
41. Cross, H.R. (1979). Effects of electrical stimulation on meat tissue and muscle properties—A review. *J. Food Sci.*, 44: 509.
42. Davey, C.L., Gilbert, K.V. and Carse, W.A. (1976). Carcass electrical stimulation to prevent cold-shortening toughness in beef. *NZ J. Agric. Res.*, 19: 13.
43. Davey, K.R. and Smith, M.G. (1989). A laboratory evaluation of a novel hot water cabinet for the decontamination of sides of beef. *Int. Food Sci. Technol.*, 24: 305.
44. Delmore, L.R.G., Sofos, J.N., Reagan, J.O. and Smith, G.C. (1997). Hot-water rinsing and trimming/washing of beef carcasses to reduce physical and microbiological contamination. *J. Food Sci.*, 62: 373.
45. Den Hertog-Meischke, M.J.A., Smulders, F.J.M., van, Logtestijn, J.G. and van Knapen, F. (1997). The effect of electrical stimulation on the water-holding capacity and protein denaturation of two bovine muscles. *J. Anim. Sci.*, 75: 118.
46. Devine, C.E., Wahlgren, N.M. and Tornberg, E. (1999). Effect of rigor temperature on muscle shortening and tenderization of restrained and unrestrained beef *M. longissimus thoracis et lumborum*. *Meat Sci.*, 51: 61.
47. Dickon, J.D. (1991). Control of *Salmonella typhimurium*, *Listeria monocytogenes* and *Escherichia coli* 0157:H7 on spray chilling system. *J. Food Sci.*, 56: 191.
48. Dickson, J.S. (1992). Acetic acid action on beef tissue surfaces contaminated with *Salmonella typhimurium*. *J. Food Sci.*, 57: 297.



49. Dickson, J.S. and Anderson, M.E. (1992). Microbiological decontamination of food animal carcasses by washing and sanitizing systems: A review. *J. Food Sci.*, 55: 133.
50. Dormedy, E.S., Brashears, M.M., Cutter, C.V. and Burson, D.E. (2000). Validation of acid washes as critical control points in hazard analysis and critical control system. *J. Food Prot.*, 63: 1676–1680.
51. Dorsa, W.J., Cutter, C.N., Siragusa, G.R. and Koohmaraie, M. (1996). Microbial decontamination of beef and sheep carcasses by steam, hot washes and steam-vacuum sanitizer. *J. Food Prot.*, 59: 127.
52. Dransfield, E. (1994). Optimization of tenderization, ageing and tenderness. *Meat Sci.*, 5: 105.
53. Dransfield, E., Etherington, D.J. and Taylor, M.A. (1992). Modelling post-mortem tenderisation – II: Enzyme changes during storage of electrically stimulated and non-stimulated beef. *Meat Sci.*, 31: 75.
54. Dubal, Z.B., Paturkar, A.M., Waskar, V.S., Zende, R.J., Latha, C., Rawool, D.B. and Kadam, M.M. (2004). Effect of food grade organic acids on inoculated *S. aureus*, *L. monocytogenes*, *E. coli* and *S. Typhimurium* in sheep/goat meat stored at refrigeration temperature. *Meat Sci.*, 66: 817.
55. Dutson, T.R., Yates, L.D., Smith, G.C., Carpenter, Z.L. and Hostetler, R.L. (1977). Rigor onset before chilling. *Proceedings of the 30th Annual Reciprocal Meat Conference*. Illinois, Chicago, pp. 79–86.
56. Duston, T.R., Meiners, C.R. and Smith, G.C. (1980). Protein efficiency ratio of beef tenderized by electrical stimulation. *Nutr. Rep. Int.*, 22: 973.
57. Eburne, R.C. and Prentice, G. (1994). In: *Modified Atmosphere-Packed Ready to Cook and Ready to Eat Meat Products. Shelf Life Evaluation of Foods* (Eds. Man, C.M.D. and Jones, A.A.) London: Blackie Academic & Professional, p. 156.
58. Egbert, W.R. and Cornforth, D.P. (1986). Factors influencing color of dark cutting beef muscle. *J. Food Sci.*, 51: 57.
59. Eikelenboom, G., Smulders, F.J.M. and Ruderus, H. (1985). The effects of high and low voltage electrical stimulation on beef quality. *Meat Sci.*, 15: 247.
60. Eikelenboom, G. and Smulders, F.J.M. (1986). Effect of electrical stimulation on veal quality. *Meat Sci.*, 16: 103.
61. Elias, P.S. (1987). In: *Elimination of Pathogenic Organisms from Meat and Poultry* (Ed. Smulders, F.J.M.) Amsterdam: Elsevier, p. 345.
62. Ellerbroek, I. L. (1993). Does spray washing of lamb carcasses alter bacterial surface contamination? *J. Food Prot.*, 56: 432.
63. Elmore, J.S., Mottram, D.S., Enser, M., Wood, J.D. and Novel, J.D. (1997). Thiazoles and 3-thiazolines in cooked beef aroma. *J. Agric. Food Chem.*, 45: 3603.
64. Farouk, M.M., Wielicko, K.J. and Merts, I. (2003). Ultra-fast freezing and low storage temperatures are not necessary to maintain the functional properties of manufacturing beef. *Meat Sci.*, 66: 171.
65. Fayer, R. (1997). In: *Cryptosporidium and Cryptosporidiosis* (Ed. Fayer, R.) New York: CRC Press, pp. 1–251.
66. Feldhusen, F. (1994). Einflüsse auf die postmortale Farbveränderung der Oberfläche von Schweinemuskulatur. *Fleischwirtschaft*, 74: 989.
67. Fennema, O. (1982). Behaviour of proteins at low temperatures. In: *Food Protein Deterioration Mechanisms and Functionality*. ACS symposium series 206 (Ed. Cherry, J.P.) Washington, DC: American Chemical Society, pp. 109–133.
68. Fernandez, X., Forslid, A. and Tornberg, E. (1994). The effect of high post-mortem temperature on the development of pale, soft, exudative pork: Interaction with ultimate pH. *Meat Sci.*, 37: 133.
69. Frank, F. (1995). Protein destabilization at low temperatures. *Adv. Prot. Chem.*, 46: 105.
70. Frazier, W.C. and Westhoff, D.C. (1988). *Food Microbiology*, 4th ed., New Delhi: Tata McGraw-Hill.
71. Galland, J.C. (1997). Risks and prevention of contamination of beef carcasses during the slaughter process in the United States of America. *Rev. Sci. Tech. Off. Int. Epiz.*, 16: 395.
72. Gašperlin, L., Žlender, B. and Abram, V. (2000). Colour of normal and high pH beef heated to different temperatures as related to oxygenation. *Meat Sci.*, 54: 391.
73. Geay, Y., Bauchart, D., Hocquette, J.F. and Culioli, J. (2001). Effect of nutritional factors on biochemical, structural and metabolic characteristics of muscles in ruminants, consequences on dietetic value and sensorial qualities of meat. *Reprod. Nutr. Develop.*, 41: 1.
74. George, A.R., Bendall, J.R. and Jones, R.C.D. (1980). The tenderizing effect of electrical stimulation of beef carcasses. *Meat Sci.*, 4: 51–68.
75. Gill, C.O. (1980). Effect of electrical stimulation on meat spoilage flora. *J. Food Prot.*, 43: 190.
76. Gill, C.O. and Baker, L.P. (1998). Assessment of the hygienic performance of a sheep carcass dressing process. *J. Food Prot.*, 61: 329.

77. Gill, C.O. and Bryant, J. (1997). Decontamination of carcasses by vacuum-hot water cleaning and steam pasteurizing during routine operations as a beef packing point plant. *Meat Sci.*, 47: 267.
78. Gill, C.O. and Landers, C. (2003). Microbiological effects of carcass decontaminating treatments at four beef packing plants. *Meat Sci.*, 65: 1005.
79. Gill, C.O. and Landers, C. (2004). Microbiological conditions of detained beef carcasses before and after removal of visible contamination. *Meat Sci.*, 66: 335.
80. Goksoy, E.O., James, C., Corry, J.E.L. and James, S.J. (2001). The effect of hot water immersions on the appearance and microbiological quality of skin-on chicken-breast pieces. *Int. J. Food Sci. Technol.*, 36: 61.
81. Gorman, B.M., Sofos, J.N., Morgan, J.B., Schmidt, G.R. and Smith, G.C. (1995). Evaluation of hand-trimming various sanitizing agents and hot water spray-washing as decontamination interventions for beef brisket adipose tissue. *J. Food Prot.*, 58: 899.
82. Grau, F.H., Brownlie, L.E. and Roberts, E.A. (1968). Effect of some preslaughter treatments on the *Salmonella* population in the bovine rumen and feces. *J. Appl. Bacteriol.*, 31: 157.
83. Gray, J.I. and Pearson, A.M. (1987). Rancidity and warmed-over flavor. In: *Advances in Meat Research, Vol. 3, Restructured Meat and Poultry Products* (Eds. Pearson, A.M. and Dutson, T.R.) New York: van Nostrand Reinhold, pp. 221–269.
84. Grigioni, G.M., Margaria, C.A., Pensel, N.A., Sánchez, G. and Vaudagna, S.R. (2000). Warmed-over flavour analysis in low temperature-long time processed meat by an “electronic nose.” *Meat Sci.*, 56: 221.
85. Hagyard, C.J., Keiller, A.H., Cummings, T.L. and Chrystall, B.B. (1993). Frozen, storage conditions and rancid flavour development in lambs. *Meat Sci.*, 35: 305.
86. Hamm, R. (1960). Biochemistry of meat hydration. *Adv. Food Res.*, 10: 355–463.
87. Hamm, R. (1975). Water-holding capacity of meat. In: *Meat* (Eds. Cole, D.A.J. and Lawrie, R.A.) London: Butterworths, pp. 321–328.
88. Hamm, R. (1977). Postmortem breakdown of ATP and glycogen in ground muscle: A review. *Meat Sci.*, 1: 15.
89. Hamm, R. (1981). Post-mortem changes in muscle affecting the quality of comminuted meat products. In: *Developments in Meat Science – 2*, Barkung, U.K.: Elsevier Applied Science, p. 93.
90. Hannan, R.S. (1985). Properties of Meat, Lecture note, Leeds University, Leeds.
91. Hansen, T.B., Knochel, S., Juncher, D. and Bertelsen, G. (1995). Storage characterisation of sous vide cooked roast beef. *Int. J. Food Sci. Technol.*, 30: 365.
92. Hertzman, C., Olsson, U. and Tornberg, E. (1993). The influence of high temperature, type of muscle and electrical stimulation on the course of rigor, ageing and tenderness of beef muscle. *Meat Sci.*, 35: 119.
93. Ho, C.Y., Stromer, M.H. and Robson, R.M. (1996). Effect of electrical stimulation on postmortem titin, nebulin, desmin, and troponin T degradation ultrastructural changes in bovine longissimus muscle. *J. Anim. Sci.*, 74: 1563.
94. Hocquette, J.F., Ortigues-Marty, I., Pethick, D.W., Herpin, P. and Fernandez, X. (1988). Nutritional and hormonal regulation of energy metabolism in skeletal muscles of meat-producing animals. *Livest. Prod. Sci.*, 56: 115.
95. Hollender, R., Bender, F.C., Jenkins, R.K. and Black, C.L. (1993). Research note: Consumer evaluation of chicken treated with trisodium phosphate application during processing. *Poultry Sci.*, 72: 755.
96. Honikel, K.O., Roncales, P. and Hamm, R. (1983). The influence of temperature on shortening and rigor onset in beef muscle. *Meat Sci.*, 8: 221.
97. Honikel, K.O., Kim, C.J., Hamm, R. and Roncales, P. (1986). Sarcomere shortening of pre-rigor muscles and its influence on drip loss. *Meat Sci.*, 16: 267.
98. Hopkins, D.L. and Thompson, J.M. (2002). The relationship between post-mortem calcium concentration or pH and indicators of proteolysis in ovine muscle. *Meat Sci.*, 61: 411.
99. Huff, E.J. and Parrish, F.C., Jr. (1993). Bovine longissimus muscle tenderness as affected by post-mortem aging, time, animal age and sex. *J. Food Sci.*, 58: 713.
100. Hwang, I.H. and Thompson, J.M. (2001). The interaction between pH and temperature decline early postmortem on the calpain system and objective tenderness in electrically stimulated beef longissimus dorsi muscle. *Meat Sci.*, 58: 167.
101. Hwang, I.H., Devine, C.E. and Hopkins, D.L. (2003). The biochemical and physical effects of electrical stimulation on beef and sheep meat tenderness. *Meat Sci.*, 65: 677.
102. Hwang, I.H., Park, B.Y., Kim, J.H., Cho, S.H. and Lee, J.M. (2004). Assessment of postmortem proteolysis by gel-based proteome analysis and its relationship to meat quality traits in pig longissimus. *Meat Sci.*, 69: 79.

103. Hwang, I.H., Park, B.Y., Kim, J.H., Cho, S.H. and Lee, J.M. (2004). Effects of muscle shortening and proteolysis on Warner-Bratzler shear force in beef longissimus and semitendinosus. *Meat Sci.*, 68: 497.
104. Ingene, J.O. and Pearson, A.M. (1979). Role of phospholipids and triglycerides in warmed-over flavor development in meat model systems. *J. Food Sci.*, 44: 1285.
105. Ingram, M., Ottoway, F.J.H. and Coppock, J.B.M. (1956). The preservative action of acidic substances in food. *Chem. Indust.*, 42: 1154.
106. Ismail, M.A., Elala, A.H.A., Nassar, A. and Michail, D.G. (1995). Fungal contamination of beef carcasses and the environment in a slaughterhouse. *Food Microbiol.*, 12: 441.
107. James, C., Thornton, J.A., Ketteringham, L. and James, S.L. (2000). Effect of steam condensation, hot water or chlorinated hot water immersion on bacterial numbers and quality of lamb carcasses. *J. Food Engine.* 43: 219.
108. James, S.J., Brown, T., Evans, J.A., James, C., Ketteringham, L. and Schofield, I. (1998). Decontamination of meat, meat products and other foods using steam condensation and organic acids. *Proceedings of the 3rd Karlsruhe Nutrition Symposium. Part 1. Euro. Res. Towards Safer and Better Food*, pp. 175–185.
109. James, O.J., Brewer, R.L., Prucha, J.C., Williams, W.O. and Parham, D.R. (1992). Effects of chlorination of chill water on bacteriologic profile of raw chicken carcasses and giblets. *J. Am. Vet. Med. Assoc.*, 200: 60.
110. Janz, J.A.M., Aalhus, J.L. and Price, M.A. (2001). Blast chilling and low voltage electrical stimulation influences on bison (*Bison bison bison*) meat quality. *Meat Sci.*, 57: 403.
111. Jaturasitha, S., Thirawong, P., Leangwuntha, V. and Kreuzer, M. (2004). Reducing toughness of beef from *Bos indicus* draught steers by injection of calcium chloride: Effect of concentration and time postmortem. *Meat Sci.*, 68: 61.
112. Javis, B. and Burke, C.S. (1977). In: *Inhibition and Inactivation of Vegetative Microbes* (Eds. Skinner, F.A. and Hugo, W.B.) New York: Academic Press, p. 345.
113. Jericho, K.W.F., Ho, J. and Kozub, G. (2000). Aerobiology of a high-line speed cattle abattoir. *J. Food Prot.*, 63: 1523.
114. Jones, S.D.M., Schaefer, A.L. and Tong, A.K.W. (1992). The effects of fasting, electrolyte supplementation and electrical stimulation on carcass yield and meat quality in bulls. *Can. J. Anim. Sci.*, 72: 791.
115. Joo, S.T., Kauffman, R.G., Kim, B.C. and Park, G.B. (1999). The relationship of sarcoplasmic and myofibrillar protein solubility to color and water-holding capacity in porcine longissimus muscle. *Meat Sci.*, 52: 291.
116. Juven, B. and Pierson, M.D. (1996). Antibacterial effects of hydrogen peroxide and methods for its detection and quantitation. *J. Food Prot.*, 59: 1233.
117. Kang, D.H., Koohmaraie, M., Dorsa, W.J. and Siragusa, G.R. (2001). Development of a multiple-step process for the microbial decontamination of beef trim. *J. Food Prot.*, 64: 63.
118. Kelly, C.A., Dempster, J.F. and McLoughlin, A.J. (1981). The effects of temperature and chlorine concentration of spray washing water on numbers of bacteria on lamb carcasses. *J. Appl. Bacteriol.*, 51: 415.
119. Kerth, C.R., Miller, M.F. and Ramsey, C.B. (1995). Improvement of beef tenderness and quality traits with calcium chloride injection of beef loins 48 hours postmortem. *J. Anim. Sci.*, 73: 750.
120. Kim, K.Y., Lillard, H.S., Frank, J.F. and Craven, S.E. (1996). Attachment of *Salmonella typhimurium* to poultry skin as related to cell viability. *J. Food Sci.*, 61: 439.
121. King, D.A., Voges, K.L., Hale, D.S., Waldron, D.F., Taylor, C.A. and Savell, J.W. (2004). High voltage electrical stimulation enhances muscle tenderness, increases aging response, and improve muscle color from cabrito carcasses. *Meat Sci.*, 68: 529.
122. Kramlich, W.E., Pearson, A.M. and Tauber, F.W. (1980). *Processed Meat*, 3rd ed., Avi, Westport, CT, p. 320.
123. Kropf, D.H. and Bowers, J.A. (1992). Meat and meat products. In: *Food Theory and Applications* (Ed. Bowers, J.A.) New York: Macmillan Publishing Company.
124. Koch, R.M., Jung, H.G., Crouse, J.D., Varel, V.H. and Cundiff, L.V. (1995). Digestive capability, carcass and meat characteristics of *Bison bison*, *Bos Taurus* and *Bos x Bison*. *J. Anim. Sci.*, 73: 1271.
125. Koohmarie, M., Babiker, A.S., Merkel, R.A. and Dutson, T.R. (1988). Role of Ca<sup>++</sup> dependant proteases and lysosomal enzymes in postmortem changes in bovine skeletal muscle. *J. Food Sci.*, 53: 1253.
126. Koohmaraie, M. (1996). Biochemical factors regulating the toughening and tenderization processes of meat. *Meat Sci.*, 43 (Suppl S): S193.
127. Kotula, K.L. and Thelappurath, R. (1994). Microbiological and sensory attributes of retail cuts of beef treated with acetic and lactic acid solutions. *J. Food Prot.*, 57: 665.

128. Kozempel, M., Goldberg, N. and Craig, J.C., Jr. (2003). The vacuum/steam/vacuum process. *Food Technol.*, 57: 30.
129. Kristensen, L. and Purslow, P.P. (2001). The effect of ageing on the water-holding capacity of pork: role of cytoskeletal proteins. *Meat Sci.*, 58: 16.
130. Ladikos, D. and Lougovois, V. (1990). Lipid oxidation in muscle foods: A review. *Food Chem.*, 35: 295.
131. Lametsch, R., Roepstorff, P., Møller, H.S. and Bendixen, E. (2004). Identification of myofibrillar substrates for  $\mu$ -calpain. *Meat Sci.*, 68: 515–521.
132. Lawrie, R.A. (1985). *Meat Science*, 4th ed., Oxford: Pergamon Press, pp. 173–175.
133. Ledward, D.A. (1992). Colour of raw and cooked meat. In: *The Chemistry of Muscle Based Foods* (Eds. Johnson, D.E., Knight, M. and Ledward, D.A.) Cambridge, U.K.: Royal Society of Chemistry, pp. 128–144.
134. Lepetit, J., Canistro, J. and Favier, R. (1998). Rigor strength and temperature in rabbit muscle. In: *Very Fast Chilling in Beef. Volume 2: Muscle to Meat*. Bristol, U.K.: Bristol University Press, pp. 95–103.
135. Leskanich, C.O., Mathews, K.R., Warkup, C.C., Noble, R.C. and Hazzledine, M. (1997). The effects of dietary oil containing (n-3) fatty acids on the fatty acid, physicochemical and organoleptic characteristics of pig meat and fat. *J. Anim. Sci.*, 75: 673.
136. Levine, A.S. and Fellers, C.R. (1940). Action of acetic acid on food microbes. *J. Bacteriol.*, 39: 499.
137. Lillard, H.S. (1979). Levels of chlorine and chlorine dioxide of equivalent bactericidal effect in poultry processing water. *J. Food Sci.*, 44: 1594.
138. Lin, W., Cornell, J.A., Lin, C. and Wei, C. (1996). Bactericidal activity of aqueous chlorine and chlorine dioxide solutions in a fish model system. *J. Food Sci.*, 61: 1030.
139. Lindahl, G., Lundström, K. and Tornberg, E. (2001). Contribution of pigment content, myoglobin forms and internal reflectance to the colour of pork loin and ham from pure breed pigs. *Meat Sci.*, 59: 141.
140. Linelov, F. (1978). Reactions in frozen foods; the reactions of myosin and single amino acids with some aldehydes. *Int. J. Refrig.*, 12: 92.
141. Lochner, J.V., Kauffman, R.G. and Marsh, B.B. (1980). Early-post mortem cooling rate and beef tenderness. *Meat Sci.*, 4: 227.
142. Love, J. (1988). Sensory analysis of warmed-over flavor in meat. *Food Technol.*, 42: 140.
143. Mackie, I.M. (1993). The effects of freezing on flesh proteins. *Food Rev. Int.*, 9: 575.
144. Marsh, B.B., Leet, N.G. and Dickson, M.R. (1974). The ultrastructure and tenderness of highly cold-shortened muscle. *J. Food Technol.*, 9: 141.
145. Marshall, K.C., Stout, R. and Michell, R. (1971). Mechanism of the initial events in the adsorption of marine bacteria to surfaces. *J. Gen. Microbiol.*, 68: 337.
146. Martin, A.H., Murray, A.C., Jeremiah, L.E. and Dutson, P.J. (1983). Electrical stimulation and carcass ageing effects on beef carcasses in relation to postmortem glycolysis rates. *J. Anim. Sci.*, 57: 1456.
147. Mason, L.H., Church, I.J., Ledward, D.A. and Parson, A.L. (1990). Review: The sensory quality of food produced by conventional and enhanced cook-chill methods. *Int. J. Food Sci. Technol.*, 25: 247.
148. McEvoy, J.M., Doherty, A.M., Sheridan, J.J., Thomson-Carter, F.M., Garvey, P., McGuire, L., Blair, I.S. and McDowell, D.A. (2001). In: *The Incidence and Spread of Escherichia coli O157:H7 at a Commercial Beef Abattoir. Epidemiology of Verocytotoxigenic E. coli*. Dublin: The National Food Centre, Teagasc, pp. 12–27.
149. McKenna, D.R., Maddock, T.D. and Savell, J.W. (2003). Water-holding and color characteristics of beef from electrically stimulated carcasses. *J. Muscle Foods*, 14: 33.
150. McGeehin, B., Sheridan, J.J. and Butler, F. (1999). Further investigations on the ultra-rapid chilling of lamb carcasses. *J. Muscle Foods*, 10: 1.
151. Mercier, Y., Garellier, P. and Renner, M. (2004). Lipid and protein oxidation in vitro, and antioxidant potential in meat from charolais cows finished on pasture or mixed diet. *Meat Sci.*, 66: 467.
152. Mielche, M.M. (1995). Development of warmed-over flavour in ground turkey, chicken and pork meat during chill storage. A model of the effects of heating temperature and storage time. *Zeitschrift für Lebensmittel-Untersuchung Forschung*, 200: 286.
153. Mielche, M. and Bertelsen, G. (1993). Effects of heat treatment on warmed-over flavour in ground beef during aerobic chill storage. *Zeitschrift für Lebensmittel-Untersuchung Forschung*, 197: 8.
154. Miller, A.J., Ackerman, S.A. and Palumbo, S.A. (1980). Effects of frozen storage on functionality of meat for further processing. *J. Food Sci.*, 45: 1466.

155. Miller, M.F., Kerth, C.R., Wise, J.W., Landsdell, G.L., Stowell, J.E. and Ramsey, C.B. (1997). Slaughter plant location, USDA quality grade, external fat thickness, and ageing time effects on sensory characteristics of beef loin strip steak. *J. Anim. Sci.*, 49: 662.
156. Mirade, P.S. and Picgirard, L. (2001). Assessment of airflow patterns inside six industrial beef carcass chillers. *Int. J. Food Sci. Technol.*, 35: 463.
157. Mitchell, G.E., Giles, J.E., Rogers, S.A., Tan, L.T., Naidoo, R.J. and Ferguson, D.M. (1991). Tenderizing, ageing and thawing effects on sensory, chemical and physical properties of beef steaks. *J. Food Sci.*, 56: 1125.
158. Mrigadat, B., Smith, G.C., Duston, T.R., Hall, L.C., Hanna, M.O. and Vanderzant, C. (1980). Bacteriology of electrically stimulated and non-stimulated rabbit, pork, lamb and beef carcasses. *J. Food Prot.*, 43: 686.
159. Morgan, A.I., Radewonuk, E.R. and Scullen, O.J. (1996). Ultra high temperature ultra short time surface pasteurization of meat. *J. Food Sci.*, 61: 1216.
160. Morris, C.E. (1991). Forging new links in the cold chain. *Food Eng.*, 7: 61.
161. Morris, C.A., Theis, R.L., Miller, R.K., Acuff, G.R. and Savell, J.W. (1997). Improving the flavor of calcium chloride and lactic acid injected mature beef top round steaks. *Meat Sci.*, 45: 5317.
162. Murphy, M.A. and Zerby, H.N. (2004). Prerigor infusion of lamb with sodium chloride, phosphate and dextrose solution to improve tenderness. *Meat Sci.*, 66: 343.
163. Newbold, R.P. (1996). Changes associated with rigor mortis. In: *The Physiology and Biochemistry of Muscle as Food* (Eds. Briskey, E.J., Cassens, R.G. and Trautmann, J.C.) Madison: The University of Wisconsin Press.
164. Ngapo, T.M., Babre, I.H., Reynolds, J. and Mawson, R.F. (1999). A preliminary investigation of the effects of frozen storage on samples of pork. *Meat Sci.*, 53: 169.
165. Nuss, J.I. and Wolfe, H. (1980–1981). Effect of post-mortem storage temperatures on isometric tension, pH, ATP, glycogen and glucose,-6-phosphate for selected bovine muscles. *Meat Sci.*, 5: 201.
166. Obuz, E. and Dikeman, M.E. (2003). Effects of cooking beef muscles from frozen or thawed states on cooking traits and palatability. *Meat Sci.*, 65: 993.
167. Ockerman, H.W., Borton, R.J., Cahill, V.R., Parrett, N.A. and Hoffman, H.D. (1974). Use of acetic acid and lactic acid to control the quality of microorganisms on lamb carcasses. *J. Milk Food Technol.*, 37: 203.
168. O'Donoghue, P. (1995). Cryptosporidium and cryptosporidiosis in man and animals. *Int. J. Parasitol.*, 25: 139.
169. Offer, G. and Trinick, J. (1983). On the mechanism of water holding in meat: The swelling and shrinking of myofibrils. *Meat Sci.*, 8: 245.
170. O'Halloran, G.R., Troy, D.J. and Buckley, D.J. (1997). The relationship between early post-mortem pH and the tenderization of beef muscle. *Meat Sci.*, 45: 239.
171. O'Keefe, M. and Hood, D.E. (1982). Biochemical factors influencing metmyoglobin formation in beef from muscles of different colour stability. *Meat Sci.*, 7: 209.
172. Olsson, U., Hertzman, C. and Tornberg, E. (1994). The influence of low temperature, type of muscle and electrical stimulation on the course of rigor mortis, ageing and tenderness of beef muscle. *Meat Sci.*, 37: 115.
173. Ortner, H. (1989). The effect of chilling on meat quality. *Fleischwirtsch*, 69: 593.
174. Ouellette, R.P., Lord, N.W. and Cheremisinoff, P.N. (1980). *Food Industry Energy Alternatives*. Westport, CT: Food and Nutrition Press.
175. Overland, M., Tangbol, O., Haug, A. and Sundstol, E. (1996). Effect of fish oil on growth performance, carcass characteristics, sensory parameters and fatty acid composition in pigs. *Acta Agric. Scandinavia*, 46: 11.
176. Pearce, T. and Gardner, J. (1998). Predicting organoleptic scores of sub-ppm flavour notes. Part 1: Theoretical and experimental details. Part 2: Computational analysis and results. *Analyst*, 123: 2046.
177. Pearson, A.M. and Dutson, T.R. (1985). Scientific basis for electrical stimulation. In: *Advances in Meat Research – Electrical Stimulation* (Eds. Pearson, D.H. and Dutson, T.R.) Vol. 1, Westport CT: AVI Publishing Company, pp. 185–218.
178. Pearson, A.M. and Young, R.B. (1989). *Muscle and Meat Biochemistry*. San Diego: Academic Press.
179. Petrovic, L., Grujic, R. and Petrovic, M. (1993). Definition of the optimum freezing rate–2. Investigation of the physico-chemical properties of beef *M. longissimus dorsi* frozen at different freezing rates. *Meat Sci.*, 33: 319.

180. Pipek, P., Izumimoto, M., Houska, M., Maly, I. and Jelenikova, J. (2001). Colour changes caused by surface decontamination of meat. *Proceedings of the Academic Congress*, Shinshu University, Ino (Nagano), September 15.
181. Pipek, P., Izumimoto, M. and Jelenikova, J. (2004). Colour changes caused by surface decontamination of meat by lactic acid. *Fleischwirtschaft Int.*, 19: 99.
182. Pipek, P., Houška, M., Jeleniková, J., Kýhos, K., Hoke, K. and Šikulová, M. (2005). Microbial decontamination of beef carcasses by combination of steaming and lactic acid spray. *J. Food Eng.*, 67: 309.
183. Pipek, P., Kadanova, V., Baco, B. and Brezina, P. (1997). The use of organic acids for surface decontamination of poultry. *Czech. J. Food Sci.*, 15: 137.
184. Piette, J.P. and Idziak, E.S. (1991). Adhesion of meat spoilage bacteria to fat and tendon, slices and to glass. *Biofouling*, 5: 3.
185. Piette, J.P. and Idziak, E.S. (1992). A model study of factors involved in adhesion of *Pseudomonas fluorescens* to meat. *Appl. Environ. Microbiol.*, 58: 2783.
186. Polidori, P., Lee, S., Kauffman, R.G. and Marsh, B.B. (1999). Low voltage electrical stimulation of lamb carcasses: Effects on meat quality. *Meat Sci.*, 53: 179.
187. Polidori, P., Marinucci, M.T., Renieri, F.C. and Polidori, F. (2000). Tenderization of weather lambs meat through pre-rigor infusion of calcium ions. *Meat Sci.*, 55: 197.
188. Pommier, S.A., Piostes, L.M. and Butler, G. (1987). Effect of low voltage electrical stimulation on the distribution of Cathepsin D and the palatability of the Longissimus dorsi from Holstein vena calves fed a corn or barley diet. *Meat Sci.*, 21: 203.
189. Powell, V.H. and Cain, B.P. (1987). A hot water decontamination system for beef sides. *CSIRO Food Res. Quarterly*, 47: 79–84.
190. Prasai, R.K., Acuff, G.R., Lucia, L.M., Morgan, J.B., May, S.G. and Savell, W. (1992). Microbiological effects of acid decontamination of pork carcasses at various location in processing. *Meat Sci.*, 32: 413.
191. Rahkio, T.M. and Korkeala, H.J. (1997). Airborne bacteria and carcass contamination in slaughterhouses. *J. Food Prot.*, 60: 38–42.
192. Reagan, J.O., Acuff, G.R., Buege, D.R., Buyck, M.J., Dickson, J.S., Kastner, C.L., Marsden, J.L., Morgan, J.B., Nickelson, R., Smith, G.C. and Sofos, J.N. (1996). Trimming and washing of beef carcasses as a method of improving the microbiological quality of meat. *J. Food Prot.*, 59: 751.
193. Rees, M.P., Trout, G.R. and Warner, R.D. (2002). Tenderness, ageing rate and meat quality of pork M. longissimus thoracis et lumborum after accelerated boning. *Meat Sci.*, 60: 113–124.
194. Reid, D.S. (1999). Factors which influence the freezing process an examination of new insights. Paper presented at the 20th International Congress of Refrigeration, IIR/IIF, Sydney.
195. Renere, M. (1990). Review; factors involved in the discolouration of beef meat. *Int. J. Food Sci. Technol.*, 25: 613.
196. Renere, M., Poncet, K., Mercier, Y., Gatellier, P. and Metro, B. (1999). Influence of dietary fat and vitamin E on antioxidant status of muscles of turkey. *J. Agric. Food Chem.*, 47: 237.
197. Rhee, M.S. and Kim, B.C. (2001). Effect of low voltage electrical stimulation and temperature conditioning on postmortem changes in glycolysis and calpains activities of Korean native cattle (Hanwoo). *Meat Sci.*, 58: 231.
198. Rho, M.J., Vizcaino, J. and Herrera, F. (2001). Monitoring of microbial hazards at farm, slaughterhouses, and processing lines of swine in Korea. *J. Food Prot.*, 64: 1388.
199. Rodriguez-Estrada, M.T., Penazzi, G., Caboni, M.F., Bertacco, G. and Lercker, G. (1997). Effect of different cooking methods on some lipid and protein components of hamburgers. *Meat Sci.*, 6: 67.
200. Romans, J.R., Wulf, D.M., Johnson, R.C., Libal, G.M. and Costello, W.J. (1995). Effects of ground flaxseed in swine diets on pig performance and on physical and sensory characteristics of n-3 fatty acid content of pork. II. Duration of 15% dietary flaxseed. *J. Anim. Sci.*, 73: 1987.
201. Rosenvold, K. and Andersen, H.J. (2003). Factors of significance for pork quality – A review. *Meat Sci.*, 69: 219.
202. Rosenvold, K., Andersen, H.J., Slinde, E. and Hildrum, K.I. (2003). Early postmortem muscle shortening and tension in relation to tenderness in beef M. longissimus. *J. Muscle Foods*, 14: 265.
203. Rowe, R.W.D. (1977). The effect of pre-rigor stretch and contraction on the post-rigor geometry of meat samples in relation to meat toughness. *Meat Sci.*, 1: 205.
204. Ruiz, de Huidobro, F., Miguel, E., Onega, E. and Blazquez, B. (2003). Changes in meat quality characteristics of bovine meat during the first 6 days post mortem. *Meat Sci.*, 65: 1439.

205. Satterlee, L.D. and Zachariah, N.Y. (1972). Porcine and ovine myoglobin: Isolation, purification, characterization and stability. *J. Food Sci.*, 37: 909.
206. Savell, J.W. (1979). Update: Industry acceptance of electrical stimulation. *Proc. Recip. Meat Conf.*, 32: 113.
207. Savell, J.W., McKeith, F.K. and Smith, G.C. (1981). Reducing postmortem aging time of beef with electrical stimulation. *J. Food Sci.*, 46: 1777.
208. Savell, J.W. (1982). Electrical stimulation: An overview of the worldwide science and technology associated with its use to improve meat quality and palatability. Proceedings of the International Symposium on Meat Science and Technology, Lincoln, Nebraska, November 1–4, pp. 78–89.
209. Savell, J.W., Duston, T.R., Smith, G.C. and Carpenter, Z.L. (1978). Structural changes in electrically-stimulated beef muscle. *J. Food Sci.*, 43: 1606.
210. Savell, J.W., Smith, G.C. and Carpenter, Z.L. (1978). Beef quality and palatability as affected by electrical stimulation and cooler aging. *J. Food Sci.*, 43: 1666.
211. Scanga, J.A., Delmore Jr, R.J., Ames, R.P., Belk, K.E., Tatum, J.D. and Smith, G.C. (2000). Palatability of beef steaks marinated with solutions of calcium chloride, phosphate and (or) beef-flavoring. *Meat Sci.*, 55: 397.
212. Sen, A.C., Owusu-Yaw, J., Wheeler, W.B. and Wei, C.I. (1989). Reactions of aqueous chlorine and chlorine dioxide with tryptophan, *N*-methyl tryptophane, and 3-indolelactic acid: kinetic and mutagenicity studies. *J. Food Sci.*, 54: 1057.
213. Sheard, P.R. and Tali, A. (2004). Injection of salt, tripolyphosphate and bicarbonate marinade solutions to improve the yield and tenderness of cooked pork loin. *Meat Sci.*, 68: 305.
214. Sheldon, B.W. and Brown, A.C. (1986). Efficacy of ozone as a disinfectant for poultry carcasses and chill water. *J. Food Sci.*, 51: 305.
215. Sheridan, J.J. (1999). The ultra-rapid chilling of lamb carcasses. *Meat Sci.*, 28: 31.
216. Sheridan, J.J., McGeehin, B. and Butler, F. (1998). Effects of ultra-rapid chilling and electrical stimulation on the tenderness of lamb carcass muscle. *J. Muscle Foods*, 9: 403.
217. Sierra, M., Gonzalez-Fandos, E., Garcia-Lopez, M., Fernandez, M.C.G. and Moreno, B. (1995). Contamination of lamb carcasses at the abattoir. Microflora of freshly dressed lamb carcasses: indicators and spoilage organisms. *Arch. Lebensmittelhyg.*, 46: 135.
218. Simmons, N.J., Cairnet, J.M. and Daly, C.C. (1997). Effect of pre-rigor temperature and muscle restraint on the biophysical properties of meat tenderness development. Proceedings of the 43rd International Congress of Meat Science and Technology, Auckland, New Zealand, pp. 608–609.
219. Siragusa, G.R. (1995). The effectiveness of carcass decontamination systems for controlling the presence of pathogens on the surfaces of meat animal carcasses. *J. Food Safety*, 15: 229.
220. Smeltzer, T., Thomas, R. and Collins, G. (1980). The role of equipment having accidental or indirect contact with the carcass in the spread of *Salmonella* in abattoirs. *Aus. Vet. J.*, 56: 14.
221. Smith, M.G. (1992). Destruction of bacteria on fresh meat by hot water. *Epidemiol. Infect.*, 109: 491.
222. Smijders, J.M.A. (1976). Hygiene Bij Het Slachten Van Varkens, Ph.D. thesis, Utrecht University.
223. Smulders, F.I.M. (1995). Preservation by microbial decontamination: The surface treatment of meats by organic acids. In: *New Methods of Food Preservation* (Ed. Gould, G.W.) Glasgow: Blackie Academic and Professional, p. 253.
224. Smulders, F.J.M. and Eikelenboom, G. (1987). In: *Accelerated Processing of Meat* (Eds. Romita, A., Valin, C. and Taylor, A.A.) London: Elsevier Applied Science, p. 79.
225. Soares, G.J.D. and Areas, J.A.G. (1995). Effect of electrical stimulation on post mortem biochemical characteristics and quality of longissimus dorsi thoracis muscle from buffalo (*Bubalus bubalis*). *Meat Sci.*, 41: 369.
226. Sorinmade, S.O., Cross, H.R., Ono, K. and Wergin, W.P. (1982). Mechanisms of ultrastructural changes in electrically stimulated beef longissimus. *Meat Sci.*, 6: 71.
227. Spanier, A.M., Vincent Edwards, J. and Dupuy, H.P. (1988). The warmed-over flavor process in beef: a study of meat proteins and peptides. *Food Technol.*, 46: 110.
228. St. Angelo, A. J. (1996). Lipid oxidation in foods. *Crit. Rev. Food Sci. Nutr.*, 36: 175.
229. St. Angelo, A.J., Vercellotti, J.R., Legendre, M.G., Vinnett, C.H., Kuan, J.W., James, C. and Dupuy, H.P. (1987). Chemical and instrumental analyses of warmed-over flavour in beef. *J. Food Sci.*, 52: 1163.
230. St. Angelo, A.J., Vercellotti, J.R., Dupuy, H.P. and James, C. (1988). Assessment of beef flavor quality: A multidisciplinary approach. *Food Technol.*, 42: 133.

231. Stapelfeldt, H., Bjorn, H., Skibsted, L.H. and Bertelsen, G. (1993). Effect of packaging and storage conditions on development of warmed-over flavour in sliced, cooked meat. *Zeitschrift fur Lebensmittel Untersuchung Forschung*, 196: 131.
232. Staruch, L., Chalupka, B., Sirotna, Z. and Heriban, L. (2001). Decontamination of surface of slaughter carcasses with application of lactic acid. *XXXII Symposium on New Methods of Production Evaluation of Foods*, 28–30 May, Skalsky Dvur, poster (in Czech).
233. Summer, J. (1998). Microbiological testing for the meat industry. *Meat and Livestock Australia*. Australia, pp. 1–47.
234. Swatland, H.J. (1981). Cellular, heterogeneity in the response of beef to electrical stimulation. *Meat Sci.*, 5: 451.
235. Swatland, H.J. (1984). The structure and properties of meat. In: *Structure and Development of Meat Animals*, Englewood Cliffs, NJ: Prentice-Hall, pp. 153–200.
236. Swatland, H.J. (2004). Absorbance of light by mitochondria in pork muscle fibres differing in myoglobin content. *Meat Sci.*, 67: 371.
237. Takahashi, G., Wang, S.M., Lochner, J.V. and Marsh, B.B. (1987). Effects of 2-Hz and 60-Hz stimulation on the microstructure of beef. *Meat Sci.*, 19: 65.
238. Tang, B.H. and Henrickson, R.L. (1980). Effects of postmortem electrical stimulation on bovine myoglobin and its derivatives. *J. Food Sci.*, 45: 1139.
239. Taylor, R.G., Geesink, G.H., Thompson, V.F., Koochmarai, M. and Goll, D.E. (1995). Is Z-disk degradation responsible for postmortem tenderisation? *J. Anim. Sci.*, 73: 1351.
240. Teotia, J.S. and Miller, B.F. (1975). Destruction of *Salmonellae* on poultry meat with lysozyme, EDTA, X-ray, microwave and chlorine. *Poultry Sci.*, 54: 1388.
241. Tornberg, E. (1996). Biophysical aspects of meat tenderness. *Meat Sci.*, 43: S175.
242. Van Laack, R.L.J.M., Kauffman, R.G., Sybesma, W., Smulders, F.J.M., Eikelenboom, G. and Pinheiro, J.C. (1994). Is colour brightness (L-value) a reliable indicator of water-holding capacity in porcine muscle? *Meat Sci.*, 38: 193.
243. Van Laack, R.L.J.M., Stevens, S.G. and Stalder, K.J. (2001). The influence of ultimate pH and intramuscular fat content on pork tenderness and tenderization. *J. Anim. Sci.*, 79: 392.
244. Vergara, H. and Gallegom, L. (2000). Effect of electrical stunning on meat quality of lamb. *Meat Sci.*, 56: 345.
245. Wagner, J.R. and Anon, M.C. (1985). Effect of freezing rate on the denaturation of myofibrillar proteins. *J. Food Technol.*, 20: 735.
246. Wahlgren, N.M., Devine, C.E. and Tornberg, E. (1997). The influence of different pH-course during rigor development on beef tenderness. *Proceedings of the 34th International Congress of Meat Science and Technology*, G1-37, Auckland, New Zealand, pp. 622–625.
247. Warner, R.D., Kauffman, R.G. and Greaser, M.L. (1997). Muscle protein changes post mortem in relation to pork quality traits. *Meat Sci.*, 45: 339.
248. Warriss, P.D. and Brown, S.N. (1987). The relationship between initial pH, reflectance and exudation in pig muscle. *Meat Sci.*, 20: 65.
249. Warris, P.D., Bevis, E.A. and Ekins, P.J. (1989). The relationships between glycogen stores and muscle ultimate pH in commercially slaughtered pigs. *Br. Vet. J.*, 145: 378.
250. Watts, B.M. (1962). Meat products. In: *Symposium on Food: Lipids and Their Oxidation* (Eds. Day, A. and Simhulber, R.P.R.) Westport: AVI Publ. Co., pp. 202–219.
251. Wei, C.I., Cook, D.L. and Kirk, J.R. (1985). Use of chlorine compounds in the food industry. *Food Tech.*, 39: 107.
252. Wei, C.I., Sen, A.C., Fukayama, M.F., Ghanbari, H.A., Wheeler, W.B. and Kirk, J.R. (1987). Reactions involving HOCl or ClO<sub>2</sub> with fatty acid under aqueous conditions and mutagenicity of reaction products. *Can. Inst. Food Sci. Tech.*, 20: 19.
253. Wells, J.G., Shipman, L.D., Greence, K.D., Sowers, S.M., Green, J.H., Camerson, D.N., Downes, F.P., Martin, M.L., Griffin, P.M., Ostroff, S.M., Potter, M.E., Tauxe, R.V. and Wachsmuth, I.K. (1991). Isolation of *Escherichia coli* O157:H7 and other Shiga-like-toxin-producing *E. coli* from dairy cattle. *J. Clin. Microbiol.*, 29: 985.
254. White, G.C. (1972). *Handbook of Chlorination for Potable Water, Wastewater, Cooling Water, Industrial Processes and Swimming Pools*. New York: Van Nostrand Reinhold.



255. Widders, P.R., Warner, K.J., Beattie, J.C., Morgan, I.R. and Hickey, M.W. (1995). Controlling microbial contamination on beef and lamb meat during dressing processing. *Aus. Vet. J.*, 72: 208.
256. Wiklund, E., Stevenson-Barry, J.M., Duncan, S.J. and Littlejohn, R.P. (2001). Electrical stimulation of red deer (*Cervus elaphus*) carcasses – effects on rate of pH-decline, meat tenderness, colour stability and water-holding capacity. *Meat Sci.*, 59: 211.
257. Will, P.A., Ownby, C.L. and Henrickson, R.L. (1980). Ultrastructural postmortem changes in electrically stimulated bovine muscle. *J. Food Sci.*, 45: 21.
258. Wismer-Pedersen, J. (1971). Chemistry of animal tissues. In: *The Science of Meat and Meat Products*, 2nd ed. (Eds. Price, J.F. and Schweigert, B.S.) San Francisco: W.H. Freeman, pp. 177–207.
259. Woltersdorf, W. (1988). Do quick methods of chilling cause faults in meat? *Fleischwirsch*, 68: 866.
260. Wood, J.D. and Enser, M. (1997). Factors influencing fatty acids in meat and the role of antioxidation in improving meat quality. *Br. J. Nutr.*, 78: S49.
261. Wood, J.D., Enser, M., Fisher, A.V., Nute, G.R., Richardson, R.I. and Sheard, P.R. (1999). Manipulating meat quality and composition. Animal Nutrition and Metabolism Group Symposium on “Improvement meat production for future needs.” *Proc. Nutr. Soc.*, 58: 363.

# 8

## *Postharvest Handling of Milk*

Nejib Guizani

### CONTENTS

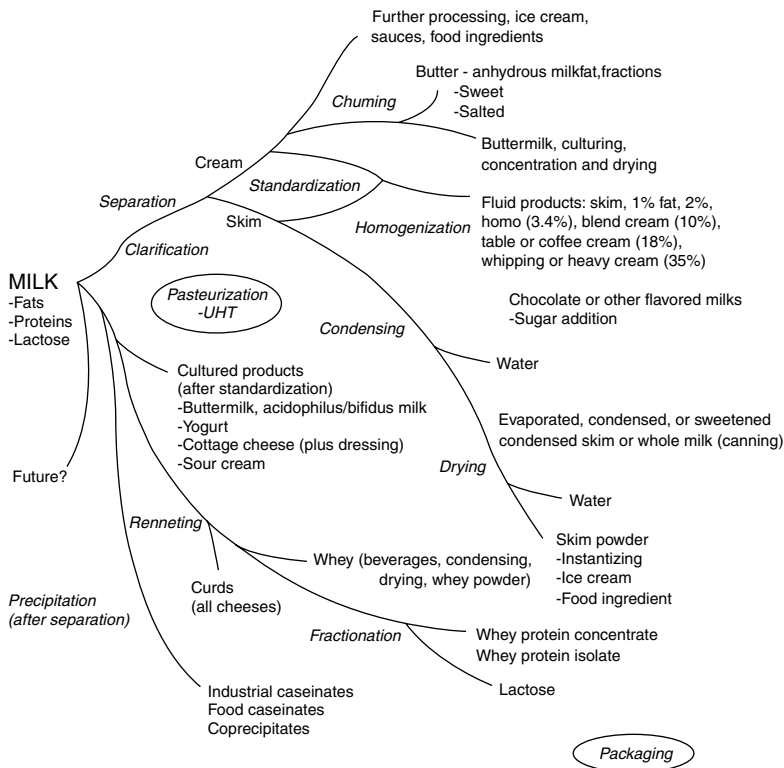
8.1	Introduction .....	203
8.2	Composition and Structure .....	203
8.3	Quality Criteria for Milk .....	205
8.4	Microflora of Raw Milk .....	205
8.5	Control of Microorganisms in Raw Milk .....	208
8.5.1	Cleaning and Sanitizing .....	208
8.5.2	Cooling of Milk .....	208
8.5.3	Antimicrobial Constituents .....	209
8.5.3.1	The Lactoperoxidase System .....	209
8.5.3.2	Hydrogen Peroxide .....	209
8.5.4	Thermization (Thermalization) .....	210
8.5.5	Clarification .....	210
	References .....	210

### 8.1 Introduction

Milk is a normal secretion of the mammary glands of female mammals. The U.S. Public Health Service defines milk as “the lacteal secretion, practically free of colostrum, obtained by the complete milking of one or more healthy cows which contains not less than 8.25% milk-solids-not-fat and not less than 3.25% fat.” The term milk is understood as referring to cow’s milk unless other species are mentioned specifically. For most of the world, particularly the west, milk from cattle accounts for nearly all the milk processed for human consumption [31]. However, other milking animals are very important to some populations because their milk provides an excellent and cheap source of highly valuable animal protein and other constituents. For example, sheep followed by goat make a major contribution to the milk production of the Mediterranean countries and also in large areas of Africa and Asia. Worldwide, the dairy industry produces milk as a fluid product and is processed into a variety of manufactured dairy products using a range of advanced processing technologies. The family of dairy products manufactured from milk is shown in Figure 8.1 [12].

### 8.2 Composition and Structure

Milk is a polyphasic normal secretion of the mammary glands. Milk consists of (i) an oil-in-water emulsion with the fat in the form of droplets or globules dispersed in the continuous milk serum known as whey, (ii) a colloidal suspension of proteins of various sizes in milk serum, consisting mostly of casein micelles, globular proteins, and lipoprotein particles, and (iii) a solution of lactose, soluble proteins, minerals, vitamins, and other components [15]. In addition, milk is a very complex food with over 100,000 different molecular species found, but most have not been identified [27]. The main component of milk



**FIGURE 8.1** The family of dairy products manufactured from milk. (From H.D. Goff and M.E. Sahagian. *Freezing Effects on Food Quality* (L.E. Jeremiah, Ed.), Marcel Dekker, New York, 1996, p. 299.)

is water. The remaining compounds are mainly fat (3.9%), protein (3.3%), lactose (5%), and minerals (0.7%) [38]. Milk also contains vitamins (e.g., vitamins A and C), enzymes (e.g., lactoperoxidases (LP) and acid phosphatase), and somatic cells [27]. The average composition of milk with respect to the major classes of compounds and a range of average values for milks of western breeds are shown in Table 8.1. There can be considerable compositional differences between species and even between breeds of a single species. The lipid content is the most variable fraction. Lipid is present mainly in the form of triglyceride, which makes up about 98% of milk fat. The remaining 2% consists of diglycerides, monoglycerides, cholesterol, phospholipids, free fatty acids, cerebrosides, and gangliosides [27]. The major fatty acids of milk are  $C_{14}$ ,  $C_{16}$ ,  $C_{18}$ , and  $C_{18:1}$  fatty acids [9]. The fat is present in fresh milk mainly in the form of fat globules surrounded by a phospholipid-rich layer known as the milk fat globule membrane. Milk proteins are fractionated into two main groups: the casein fraction and the whey proteins. Caseins precipitate out of solution upon acidification of milk to pH 4.6 at 20°C, while whey proteins remain soluble under these conditions. Caseins can be fractionated into four main proteins  $\alpha_{s1}$ -,  $\alpha_{s2}$ -,  $\beta$ -, and  $\kappa$ -caseins [27]. Whey proteins include mainly  $\beta$ -lactoglobulin,  $\alpha$ -lactalbumin, serum albumin, lactotransferrin, immunoglobulins, and  $\beta_2$ -microglobulin [9]. Lactose is the predominant sugar

**TABLE 8.1**

Composition of Bovine Milk

Component	Average Percentage	Range for Western Breeds <sup>a</sup> (Average Percentage)
Total solids	13.4	12.16–14.42
Fat	4.1	3.54–5.13
Protein	3.6	3.29–3.98
Lactose	5.0	4.68–4.94
Ash	0.7	0.72–0.77

<sup>a</sup>Western breeds include Holstein, Brown Swiss, Ayrshire, Guernsey, Jersey, and Shorthorn.

Source: H.A. Swaisgood, Characteristics of milk. In *Food Chemistry*, 3rd ed. (O.R. Fennema, Ed.), Marcel Dekker, Inc., New York, 1996, p. 841; B.H. Webb, A.H. Johnson, and J.A. Alford. *Fundamentals of Dairy Chemistry*, 2nd ed., AVI Publishing Co., Westport, CT, 1974.

in milk; other carbohydrates are present in trace amounts and are mainly galactose and glucose. The most important function of lactose is as a fermentation substrate for lactic acid bacteria.

### 8.3 Quality Criteria for Milk

Milk is an important raw material for the production of a variety of dairy products. It is therefore important that the milk used for processing has acceptable quality characteristics. Quality characteristics for raw milk include compositional quality, microbial contamination levels, somatic cell count, freedom from inhibitory substances, and reception temperature [33].

The most common grades of raw milk are Grade A and Manufacturing Grade. The dairy farmer must meet state and federal standards to produce Grade A milk. In addition to the state requirements, a few municipal governments also have raw milk regulations. The dairy farmer must have healthy cows, adequate facilities (barn, milk house, and equipments), and must maintain satisfactory sanitation of these facilities. The Food and Drug Administration’s Pasteurized Milk Ordinance (PMO [25]) requires that Grade A milk must not exceed 100,000 cfu/mL standard plate count (SPC) for an individual milk producer, 300,000 cfu/mL SPC as commingled milk and 750,000 cells/mL somatic cell count (SCC). In addition, good-quality milk must not contain pesticides, antibiotics, sanitizers, drug residues, and other abnormalities. The storage temperature should not exceed 7°C within 2 h of milking. It is also important that the milk used for processing have acceptable flavor characteristics. Various weed, feed, and cowy flavors can be transmitted to milk by the cow’s respiratory or digestive system. These are considered normal and acceptable up to a certain level, although excessive amounts can cause off-flavors that are difficult to remove by processing. A salty flavor can arise from cows in late lactation and those infected with mastitis. Milk diluted with water can taste flat and can lack typical flavor [18].

### 8.4 Microflora of Raw Milk

Milk is an excellent medium for the growth of a variety of microorganisms owing to its high water content, neutral pH (6.4–6.6), and ample supply of nutrients. Aseptically collected milk from clean, healthy cows typically has an SPC less than 1000. Higher SPCs indicate that milk was subject to contamination. Microbial contamination generally occurs from three main sources: from within the udder, from the exterior of the udder, and from the surface of milk handling and storage equipment [7]. The contribution of some sources of contamination on the colony count of raw milk is shown in Table 8.2. Bacterial contamination from within the udder is frequently a result of mastitis, an inflammatory disease of the mammary tissue. Many microorganisms can cause mastitis, the most important being *Staphylococcus aureus*, *Escherichia coli*, *Streptococcus agalactiae*, *Streptococcus uberis*, *Pseudomonas aeruginosa*, and *Corynebacterium pyogenes*. The first three of these are all potential human pathogens [1]. Sources of contamination from the exterior of the udder include water, soil, vegetation, and bedding material. In general, contamination with psychrotrophic bacteria has been associated with bedding material, untreated water, soil, and vegetation; coliform contamination with soil; and spore formers with bedding material [8,30]. Therefore, milk is susceptible to contamination by two types of microorganisms: the pathogenic bacteria and the spoilage bacteria. The presence of pathogenic microorganisms in milk may result in infection and threat to the consumer’s health. The growth of the spoilage bacteria is more detrimental to the shelf life of milk than that of the pathogenic flora. The spoilage bacteria degrade the milk through the

**TABLE 8.2**  
Contribution of Some Sources of Contamination on the Colony Count of Raw Milk<sup>a</sup>

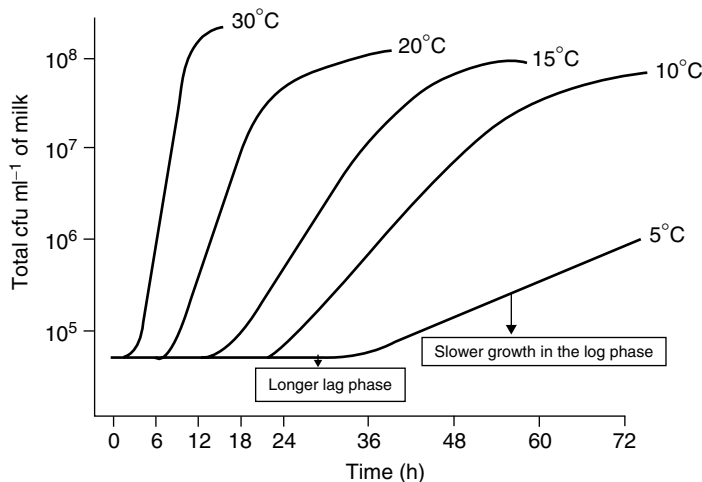
Source of Contamination	Estimate of the Contribution to the Count (mL)
Udder of a healthy cow	Up to several thousand
Water for cleaning, rinsing	Up to several thousand
Udder of a mastitic cow	Up to several million
Dirty cows	A hundred up to several thousand
Dirty equipment	A thousand up to several million

<sup>a</sup>Approximate examples.  
Source: Adapted from P. Walstra, T.J. Geurts, A. Noomen, A. Jellema, and M.A.J.S. van Boekel. *Dairy Technology. Principles of Milk Properties and Processes*. Marcel Dekker, Inc., New York, 1999.

production of enzymes. Four types of enzyme activity are encountered [22]: (i) lactose may be fermented to lactic acid resulting in a soured product, (ii) lipids are hydrolyzed by lipase—both microbial and the native milk enzyme—and, as a result, rancidity develops, (iii) proteinase activity results in the breakdown of milk proteins with both physical and organoleptic effects, principally gelation and the development of intense bitter flavors, and (iv) phospholipases can attack the milk fat globule membrane that stabilizes the native emulsion of milk fat.

Once milk leaves the cow, the retention or preservation of milk quality requires cleanliness, sanitation, and careful handling. Undesirable changes in raw milk are initiated by microbiological growth and metabolism or by chemical or enzymatic reactions. Temperature is critical for dairy food quality and shelf life. Cold temperatures are used to minimize microbial growth in raw milk until it can be processed and extend the shelf life of nonsterile dairy foods. A reduction in temperature below the minimum necessary for microbial growth extends the generation time of microorganisms and in effect prevents or retards reproduction. This is clearly shown in Figure 8.2, which illustrates the likely effect of temperature on milk having an initial SPC of 50,000 cfu/mL. The microorganisms in raw milk just prior to pasteurization may include heat-susceptible pathogens as well as spoilage types [18]. Psychrotrophs became an escalating problem for the dairy industry during the introduction of refrigerated storage of raw milk. Psychrotrophs are of primary concern to the dairy industry since they can grow and cause spoilage in raw and processed dairy products commonly held under refrigeration. Psychrotrophic microorganisms capable of growing in milk at temperatures close to 0°C are represented by both Gram-negative and Gram-positive bacteria. For example, the Gram-negative bacteria are *Pseudomonas*, *Achromobacter*, *Serratia*, *Alcaligenes*, *Chromobacterium*, and *Flavobacterium*; and Gram-positive bacteria are *Bacillus*, *Clostridium*, *Corynebacterium*, *Streptococcus*, *Lactobacillus*, and *Microbacterium* [29,17]. In aerated milk at 4°C, many strains of *Pseudomonas* spp. can produce sufficient proteinases to hydrolyze all the available casein into soluble peptides [21,28]. The enzyme activity from psychrotrophs stimulates the growth of starter lactic acid bacteria in milk [29]. Most psychrotrophs normally would not be a serious problem in milk because they are eliminated by pasteurization or Ultra High Temperature (UHT) treatment. However, psychrotrophs produce thermostable proteolytic enzymes, most of which attack  $\kappa$ -CN, resulting in a destabilization of the casein micelles and coagulation of the milk in a manner that is analogous to chymosin [10]. The quality of milk may be affected by heat-resistant enzymes secreted by psychrotrophs in raw milk before heat treatment or other enzymes and metabolites that are produced by microflora during cold storage. Some of these enzymes are not inactivated by pasteurization or by other heat treatments and may continue to degrade milk products, even when the bacterium is destroyed. The shelf life of various dairy products is given in Table 8.3.

The spoilage of milk and dairy products is characterized by taste and odor changes, such as sour, putrid, bitter, malty, fruity, rancid, and unclean. The type of spoilage may also cause undesirable body,



**FIGURE 8.2** The effect of storage temperature on the bacterial count of raw milk having an initial SPC of 50,000 cfu/mL. (From J.V. Chambers. *Dairy Microbiology Handbook* (R.K. Robinson, Ed.), Wiley, New York, 2002, p. 39.)

TABLE 8.3

## Shelf Life of Dairy Products

Product	Temperature (°C)	Shelf Life (Days)
Marketed milk	<4	12–14
Cottage cheese	2–4	15–30
Yogurt, sour cream, and dairy dip	<4	30–60
Curd cheese	<4	Several months

Source: W.S. Lagrange and E.G. Hammond. *Shelf Life and Studies of Foods and Beverages* (G. Charalambous, Ed.), Elsevier Science Publishers B.V., Amsterdam, 1993, p. 1.

TABLE 8.4

## Some Types of Spoilage of Milk

Type of Spoilage	Microflora
Souring	Lactic acid bacteria
Casein precipitation	Lactic acid bacteria producing enough acid to drop the pH below 4.6
Gas production	<i>Clostridium</i> , <i>Bacillus</i> , yeasts, coliform bacteria, heterofermentative lactics, and propionics
Proteolysis	<i>Psychrotrophic bacteria</i> : <i>Streptococcus faecalis</i> var <i>liquefaciens</i> , <i>Bacillus cereus</i> , <i>Micrococcus</i> , <i>Pseudomonas</i> , <i>Flavobacterium</i> , <i>Acinetobacter</i> , <i>Aeromonas</i> Thermophilic organisms: <i>Streptococcus</i> and <i>Lactobacillus</i> Sporeforming organisms: <i>Bacillus</i>
Lipolysis	Psychrotrophs: <i>Pseudomonas</i> spp., <i>Achromobacter</i> spp., <i>Alcaligenes</i> spp., <i>Acinetobacter</i> spp. Thermophilic organisms: <i>Streptococcus</i> and <i>Lactobacillus</i> . Sporeforming bacteria: <i>Bacillus</i>
Ropiness	<i>Alcaligenes viscolactis</i> , <i>Enterobacter</i> , lactics
Changes in butterfat	<i>Pseudomonas</i> , <i>Proteus</i> , <i>Alcaligenes</i> , <i>Bacillus</i> , <i>Micrococcus</i>
Numerous off-flavors	<i>Pseudomonas</i> , <i>Actinomyces</i> , <i>Flavobacterium</i> , <i>Alcaligenes</i> , <i>Acinetobacter</i> , <i>Proteus</i> , <i>Lactococcus lactis</i> var <i>matigenes</i> , molds, yeasts, coliforms, and mastitis-causing organisms
Color changes	<i>Pseudomonas syncyanera</i> , <i>P. synxantha</i> , <i>Serratia marcescens</i> , <i>P. fluorescens</i>

Source: G.J. Banwart. *Basic Food Microbiology*, 2nd ed., Chapman & Hall, New York, 1989; M.L. Fields. *Fundamentals of Food Microbiology*. AVI Publishing Company, Inc., Westport, CT, 1976; M.C. Hayes and K. Boor. *Applied Dairy Microbiology*, 2nd ed. (J. Steele and E. Marth, Eds.), Marcel Dekker, Inc., New York, 2001, p. 59.

texture, and functional changes [18]. In milk, about 40% of the milk solids is lactose, a major substrate for microbial fermentation in milk. Microorganisms use one of the two following methods to start fermentation: by the lactase enzyme ( $\beta$ -D-galactosidase) or by hydrolyzing the phosphorylated lactose by  $\beta$ -D-phosphogalactoside galactohydrolase. Microorganisms containing the lactase enzyme include *Escherichia coli*, *Streptococcus thermophilus*, *Lactococcus lactis*, *Lactobacillus bulgaricus*, *Lactobacillus plantarum*, and *Bacillus subtilis*. Lactic acid bacteria convert lactose to lactic acid and other by-products. Milk with a detectable acid/sour flavor is considered unacceptable commercially. Cold storage temperatures and sanitary storage and processing conditions for raw milk and cream can prevent the development of high acid/sour flavors [18].

A malty flavor or odor can occur in milk if *Streptococcus lactis* var. *matigenes* grows and metabolizes amino acids in milk to aldehyde and alcohols. The fruity flavors in dairy foods can be caused by the metabolic activity of lactic acid and psychrotrophic bacteria with the formation of esters. Flavor defects in milk described as putrid, bitter, and unclean may be caused by the growth and metabolism of psychrotrophic bacteria. The lipase enzyme is often active at low temperatures, causing lipolyzed flavor. Gram-negative psychrotrophic bacteria have lipolytic activity [18]. Table 8.4 summarizes the most important types of spoilage and the microorganisms responsible.

## **8.5 Control of Microorganisms in Raw Milk**

Microbial growth and contamination can be prevented, slowed, or reduced by many means: (1) cleaning and sanitizing of the milk-handling equipment and the environment, (2) holding milk at low temperature, (3) use of antimicrobial systems, (4) thermization, and (5) clarification.

### **8.5.1 Cleaning and Sanitizing**

Hygienic processing of food requires that the equipment are cleaned frequently and thoroughly to restore them to the desired degree of cleanliness. The degree of cleanliness of the milking system probably influences the total bulk milk bacterial count as much, if not more than any other factor [24]. Since proper cleaning and sanitizing of dairy equipment are important for production of milk with acceptable microbial quality, control of psychrotrophs should begin at the farm level [8]. Psychrotrophic bacteria tend to be present in higher count milk and are often associated with occasional neglect of proper cleaning and sanitizing procedures [24]. Cleaning of dairy facilities involves removing soil from all surfaces that come into contact with milk and using a sanitizer after each processing period. Soil in the dairy industry is mainly minerals, lipids, carbohydrates, proteins, and water. Soil may also contain dust, lubricants, microorganisms, cleaning compounds, and sanitizers [20]. Microbial cleaning, also known as sanitizing or disinfection, is used to reduce the load of microbial contaminants that may be present on milk contact surfaces. Most chemical sanitizers used in the dairy industry kill a broad spectrum of microorganisms provided that they are used properly. Sanitizers commonly used in the dairy industry include chlorine compounds, iodophors, quaternary ammonium compounds (QUATs), acid anionic surfactants, and peroxyacetic acid. All disinfectants are deactivated to some extent by organic matter. This is why they are best used after thorough cleaning has removed most of the soil [1]. Many dairy plants use hot water as a common method of sanitation. This can be achieved by circulating water at 76°C–85°C for at least 5 min, followed by a cooling chemical sanitizer rinse. Hot water sanitation requires careful control to ensure that the required temperature is maintained long enough for it to be effective. This can be achieved by the use of thermostat-controlled tanks, which will circulate the water and maintain the desired temperature [2,6,13]. Hot water will often provide greater kill and longer milk shelf life than can be achieved with chemical sanitizer alone.

### **8.5.2 Cooling of Milk**

Milk leaves the udder at a temperature of about 37°C, which is favorable for the growth of a large number of microorganisms, mainly mesophiles. Milk should therefore be quickly cooled down after leaving the udder. Cooling is the main means of slowing down the growth of bacteria in milk. The maximum storage time of milk is closely related to the storage temperature.

Low-temperature storage can reduce the frequency of raw milk collection from dairy farms to just two or three times a week, and enable further storage of milk in the dairy plant over weekends [29]. Spray and immersion coolers are commonly used on farms, which deliver milk to the dairy in cans. In spray cooling, circulating chilled water is sprayed onto the outsides of the cans to keep the milk cool. The immersion cooler consists of a coil, which is lowered into the can. Chilled water is circulated through the coil to keep the milk at the required temperature [34].

Where milking machines are available, bulk milk tanks, usually ranging from 0.8 to 19 m<sup>3</sup>, are used to receive, cool, and hold the milk. As the cows are mechanically milked, the milk flows through sanitary pipelines to an insulated stainless-steel bulk tank. An electric agitator stirs the milk, and mechanical refrigeration begins to cool it even during milking, from 32.2°C to 10°C within the first hour, and from 10°C to 4.4°C within the next hour. Some large dairy farms and collecting centers may use a plate or tubular heat exchanger to rapidly cool the milk. In these cases, the tank is mainly to maintain the required storage temperature. The temperature of the blended milk must be below 7.2°C during the second and subsequent milkings [3].

Since the milk is picked up from the farm tank daily or every alternate day, cooled milk may be stored in an insulated silo tank. Milk in the farm tank is pumped into a stainless-steel tank on a truck for delivery to the plant or receiving station. The tanks are well insulated, and the temperature rise should not be more

than 1.1 K in 18 h when testing the tank full of water and the average gradient between the water and the atmosphere surrounding the tank is 16.7°C [3].

Most dairy processing plants either receive raw milk in bulk from a producer or arrange for pickup directly from the dairy farms. Storage tanks, from 4 to 230 m<sup>3</sup> made of stainless-steel lining and well insulated, may be required for nonprocessing days and emergencies. The average 18-h temperature change should be no more than 1.6°C in the tank filled with water, and the gradient to the surrounding air 16.7°C. For horizontal storage tanks, the allowable temperature change under the same conditions is 1.1°C. The tank may need cooling depending on the initial milk temperature and holding time. A plate heat exchanger may be connected to the tank surface, around the lining, may be cooled by passing a refrigerant or by circulation of chilled water or glycol solution. Agitation is essential to maintain uniform milk fat distribution. Milk held in large tanks, such as the silo type, is continuously agitated with a slow-speed propeller driven by a gearhead electric motor or with filtered compressed air [3].

### 8.5.3 Antimicrobial Constituents

#### 8.5.3.1 *The Lactoperoxidase System*

There are some naturally occurring antimicrobial systems present in raw milk that might improve its shelf life. The main representative of these systems is LP. The milk enzyme LP catalyzes the oxidation of thiocyanate by hydrogen peroxide to produce antimicrobial substances. The inhibitory substances are claimed to be short-lived intermediary compounds, such as hypothiocyanate, cyanosulfurous acid, and cyanosulfuric acid [26]. Hypothiocyanate can kill Gram-negative bacteria and inhibit Gram-positives, possibly by damaging the bacterial cytoplasmic membrane [1].

The LP system consists of three components: LP, thiocyanate, and hydrogen peroxide. All three components are required for antimicrobial activity. The enzyme is available in milk in abundance; however, the availability of thiocyanate in milk for the proper LP preservation is not sufficient. Certain bacteria in milk produce small quantities of hydrogen peroxide, but the quantity of oxygen that can be provided is too small for the oxidation process in LP system. Stimulation of LP activity through the addition of exogenous thiocyanate and hydrogen peroxide has been investigated as a means of preserving raw milk in developing countries where ambient temperatures are high and refrigeration is not often available. For proper LP preservation, very small quantities of thiocyanate (0.00015%) and hydrogen peroxide (0.00085%) must be added to milk [35]. These quantities are sufficient to preserve milk at tropical temperatures for about 8h, while the preserved milk can be easily kept overnight at temperatures of 15°C–20°C; at temperatures of 4°C, the milk can be kept for a few days without spoilage. Similarly, Bjorck et al. [5] studied the effect of this system on the quality of raw milk in developing countries. Their results showed that the quality of treated milk was significantly improved over that of the untreated control. Furthermore, they demonstrated that the length of bacteriostasis is temperature dependent: 7–8 h at 30°C, 11–12 h at 25°C, 15–16 h at 20°C, and 24–26 h at 15°C. The IDF [16] recommended the addition of hydrogen peroxide and thiocyanate at concentrations of about 10–15 ppm to activate the LP system and extend the shelf life of raw milk.

#### 8.5.3.2 *Hydrogen Peroxide*

Hydrogen peroxide is a preservative that has been used for a long time to preserve raw milk, under conditions where it may be difficult to cool the milk quickly. The concentrations required (300–800 ppm) are much higher than those required to activate the LP system [19]. For milk of reasonably good quality, 0.03%–0.05% of pure hydrogen peroxide may be used to extend the keeping quality by at least 5 h, depending on a number of conditions such as temperature, catalase content of the milk, presence of heavy metals, and type of contaminating microorganisms [35]. In one trial in Africa, addition of hydrogen peroxide increased the proportion of samples passing the 10-min resazurin quality test from 26% to 88% [1]. Treatment levels of 0.115% completely inactivated *Mycobacterium tuberculosis*. Hydrogen peroxide is more effective at increased temperature. A level of 0.8% by weight combined with a temperature of 49°C–55°C for 30 min has been suggested as a substitute for pasteurization [19]. Anaerobic and coliform bacteria are more resistant than lactic acid and aerobic bacteria [35]. Gram-positive bacteria are not inactivated by hydrogen peroxide to the same extent as Gram-negative bacteria [32].



### 8.5.4 Thermization (Thermalization)

Often, the dairy is unable to process all milk supplies within 4 days of milking. Consequently, measures must be taken to keep the raw milk for a longer time. Dairy processors in European countries use a process called thermization to prevent psychrotrophs from growing in milk [6,39]. Thermization is a mild thermal process applied to milk that may need to be stored over a long period prior to use. Thermization has now been defined as a heat treatment that uses temperatures between 57°C and 68°C for 15 s [19]. The purpose of this treatment is to protect against microorganisms that may grow during storage of raw milk, especially Gram-negative psychrotrophic bacteria. These bacteria produce heat-resistant lipases and proteinases that may eventually cause deterioration of milk products [36]. Thermization should be applied soon after milk treatment and it is only effective if thermized milk is kept cool (4°C) [19]. Thermization is not only a far better method of controlling the quality of dairy products than merely cooling the raw milk, but it is also more expensive. Except for the killing of many vegetative microorganisms, thermization causes almost no irreversible changes in milk [36]. Some problems associated with thermization were reported however by Muir [22]. One problem is associated with the contamination of thermized milk with Gram-positive cocci such as *Streptococcus thermophilus* as a result of a build up in the regeneration section of a commercial thermization unit. Thermization may also slightly affect the flavor and texture of cheese, but not the yield.

### 8.5.5 Clarification

Clarification is a commonly employed pretreatment of milk prior to its storage/manufacture into other products. The shelf life of milk can be extended by clarification. Clarification may be as simple as filtration or may include high-speed centrifugation to remove microbial cells and spores. Filtration is usually carried out by pumping milk through specially woven cloth. This results in the removal of debris and all extraneous matter.

Bactofugation refers to a high-speed centrifugation process carried out in a specifically designed separator called a clarifier. The purpose of bactofugation is to separate bacterial cells and spores. The process is particularly important in Europe where it has been used in the cheese industry to remove spores from cheese milk that could cause latent fermentation in some types of cheeses. Bactofugation has also been adapted to processing drinking milks where it succeeds in prolonging the shelf life of fresh, pasteurized milk by 2–5 days as a result of a reduction in the microbial population. In addition, a reduction in the microbial population induces a reduction in the pasteurization temperature and consequently the manufacture of a product with improved flavor.

---

## References

1. M.R. Adams and M.O. Moss. *Food Microbiology*, 2nd ed., The Royal Society of Chemistry, Cambridge, UK, 2000.
2. Anonymous. Code of Federal Regulations. Title 21, Vol. 2, Part 110. U.S. Government Printing Office via GPO Access, Washington, DC, 2002.
3. ASHRAE Handbook. *Refrigeration Systems and Applications*. American Society of Heating, Refrigerating, and Air-Conditioning Engineers, Inc., Atlanta, 1994.
4. G.J. Banwart. *Basic Food Microbiology*, 2nd ed., Chapman & Hall, New York, 1989.
5. L. Bjorck, O. Claesson, and W. Schulthess. The lactoperoxidase/thiocyanate/hydrogen peroxide system as a temporary preservative of raw milk in developing countries. *Milchwissenschaft*. 34: 726, 1979.
6. B. Bjorgum, B. Oterholm, and P. Selberg. Thermization of milk. XX. In *Dairy Congress*, Vol. E: 614, 1979.
7. A.J. Bramley and C.H. McKinnon. The microbiology of raw milk, *Dairy Microbiology*, Vol. 1 (R.K. Robinson, Ed.), Elsevier, London, 1990, p. 163.
8. M.A. Cousin. Presence and activity of psychrotrophic microorganisms in milk and dairy products: a review. *J. Food Prot.* 45: 172, 1982.
9. W.N. Eigel, J.E. Butler, C.A. Ernstrom, H.M. Farrll, V.R. Harlwalker, R. Jennes, and R. McL Whitney. Nomenclature of proteins of cow's milk: fifth revision, *J. Dairy Sci.* 67: 1599, 1984.
10. D.J. Fairbairn and B.A. Law. Proteinases of psychrotrophic bacteria: their production, effects and control. *J. Dairy Res.* 53: 139, 1986.

11. M.L. Fields. *Fundamentals of Food Microbiology*. AVI Publishing Company, Inc., Westport, CT, 1976.
12. H.D. Goff and M.E. Sahagian. Freezing of dairy products. In *Freezing Effects on Food Quality* (L.E. Jeremiah, Ed.), Marcel Dekker, New York, 1996, p. 299.
13. R.K. Guthrie. *Food Sanitation*, 3rd ed., Van Nostrand Reinhold, New York, 1988.
14. M.C. Hayes, and K. Boor. Raw milk and fluid milk products. In *Applied Dairy Microbiology*, 2nd ed. (J. Steele and E. Marth, Eds.), Marcel Dekker, Inc., New York, 2001, p. 59.
15. <http://www.foodsci.uoguelph.ca/dairyedu/chem.html>.
16. IDF Bulletin. Code of practice for the preservation of milk by the lactoperoxidase system, No. 234, 1988.
17. V. Lafarge, J.C. Ogier, V. Girard, V. Maladen, J.Y. Leveau, A. Gruss, and A. Delacroix-Buchet. Raw cow milk bacterial population shifts attributable to refrigeration. *Appl. Environ. Microbiol.* 70: 5644, 2004.
18. W.S. Lagrange and E.G. Hammond. The shelf life of dairy products. In *Shelf Life and Studies of Foods and Beverages* (G. Charalambous, Ed.), Elsevier Science Publishers B.V., Amsterdam, 1993, p. 1.
19. M. Lewis and N. Heppell. *Continuous Thermal Processing of Foods, Pasteurization and UHT Sterilization*. Aspen Publishers, Inc., Gaithersburg, MD, 2000.
20. N.G. Marriott. *Essentials of Food Sanitation*. Chapman & Hall, New York, 1997.
21. R.C. McKellar. *Enzymes and Psychrotrophs in Raw Food*. CRC Press, Boca Raton, FL, 1989.
22. D.D. Muir. The shelf life of dairy products: 1. Factors influencing raw milk and fresh products. *J. Soc. Dairy Technol.* 49: 24, 1996.
23. S.C. Murphy and K.J. Boor. Trouble shooting sources and causes of high bacterial counts in raw milk. *Dairy, Food Environ. Sanit.* 20(8): 606, 2000.
24. J.C. Olson, Jr. and G. Mocquat. Milk and milk products. In *Microbial Ecology of Foods*, Vol. II (J.H. Silliker, R.P. Elliott, A.C. Baird-Parker, F.L. Bryan, J.H. Christian, D.S. Clark, J.C. Olson, and T.A. Roberts, Eds.), Academic Press, New York, 1980, p. 470.
25. PMO. Revision. U.S. Department of Health and Human Services, Public Health Services. Food and Drug Administration (FDA). Washington, DC, 2001.
26. B. Reiter and B.G. Harnulv. The preservation of refrigerated and uncooled milk by its natural lactoperoxidase system. *Dairy Ind. Int.* 47: 13, 1982.
27. J.V. Chambers. The microbiology of raw milk. In *Dairy Microbiology Handbook* (R.K. Robinson, Ed.), Wiley, New York, 2002, p. 39.
28. T. Sorhaug and L. Stepaniak. Microbial enzymes in the spoilage of milk and dairy products. In *Food Enzymology* (P.F. Fox, Ed.), Elsevier Science Publishers B.V., Amsterdam, 1991, p. 169.
29. T. Sorhaug and L. Stepaniak. Psychrotrophs and their enzymes in milk and dairy products: quality aspects. *Trends Food Sci. Technol.* 8: 35, 1997.
30. G. Suhren. Producer microorganisms. In *Enzymes of Psychrotrophs in Raw Food* (R.C. McKellar, Ed.), CRC Press, Boca Raton, FL, 1989, p. 3.
31. H.A. Swaisgood. Characteristics of milk. In *Food Chemistry*, 3rd ed. (O.R. Fennema, Ed.), Marcel Dekker, Inc., New York, 1996, p. 841.
32. G.J. Swart. Other pasteurisation processes. In *Encyclopedia of Food Science, Food Technology and Nutrition* (R. Macrae, R.K. Robinson, and M.J. Sadler, Eds.), Academic Press, New York, 1993, p. 3455.
33. A.Y. Tamine and V.M.E. Marshall. *Microbiology and Biochemistry of Cheese and Fermented Milk*, 2nd ed., Chapman & Hall, New York, 1997.
34. Tetra Pak Processing Systems AB. *Dairy Processing Handbook*, 2nd revised ed., Lund, Sweden, 2003.
35. J.C.T. van den Berg. Dairy technology in the tropics and subtropics. Centre for Agricultural Publishing and Documentation (Pudoc), Wageningen, The Netherlands, 1988.
36. P. Walstra, T.J. Geurts, A. Noomen, A. Jellema, and M.A.J.S. van Boekel. *Dairy Technology. Principles of Milk Properties and Processes*. Marcel Dekker, Inc., New York, 1999.
37. B.H. Webb, A.H. Johnson, and J.A. Alford. *Fundamentals of Dairy Chemistry*, 2nd ed., AVI Publishing Co., Westport, CT, 1974.
38. D.W.S. Wong, W.M. Camirand, and A.E. Pavlath. Structures and functionalities of milk proteins. *Crit. Rev. Food Sci. Nutr.* 36: 807, 1966.
39. R.R. Zall. Can cheesemaking be improved by heat treating milk on a farm? *Dairy Ind. Int.* 45(2): 25, 1980.



## **Part 2**

# **Preservation Using Chemicals and Microbes**



# 9

## *Fermentation as a Method for Food Preservation*

Nejib Guizani and Ann Mothershaw

### CONTENTS

9.1	Introduction .....	216
9.1.1	Fermentation Definition .....	216
9.1.2	History .....	216
9.1.3	Common Fermented Foods .....	216
9.2	Fermentation as a Preservation Method .....	217
9.2.1	Microbial Contamination of Foods .....	217
9.2.2	Benefits of Fermented Foods .....	218
9.3	Microorganisms Used in Food Fermentations .....	218
9.3.1	Lactic Acid Bacteria .....	218
9.3.2	Acetic Acid Bacteria .....	219
9.3.3	Yeasts .....	220
9.3.4	Molds .....	220
9.3.5	Starter Cultures .....	221
9.4	Classification of Fermented Products .....	221
9.5	Fermented Products .....	221
9.5.1	Alcoholic Beverages .....	221
9.5.1.1	Beer .....	221
9.5.1.2	Wine .....	222
9.5.2	Distilled Spirits .....	223
9.5.3	Lactic Acid Products .....	223
9.5.3.1	Dairy Products .....	223
9.5.3.2	Fermented Vegetables .....	225
9.5.3.3	Fermented Animal Products .....	225
9.6	Combined Fermentations .....	228
9.6.1	Bread .....	228
9.6.2	Sourdough .....	228
9.6.3	Vinegar .....	229
9.6.3.1	Traditional Surface Methods .....	230
9.6.3.2	The Trickling Methods .....	230
9.6.3.3	Submerged Fermentation .....	230
9.6.4	Kefir .....	231
9.6.5	Oriental Fermented Products .....	231
9.6.5.1	Soy Sauce .....	231
9.6.5.2	Tempeh .....	231
9.7	Microbial Food Preservatives .....	232
	References .....	232

## 9.1 Introduction

### 9.1.1 Fermentation Definition

Fermentation could be described as a process in which microorganisms change the sensory (flavor, odor, etc.) and functional properties of a food to produce an end product that is desirable to the consumer. In this chapter, particular emphasis is placed on how these changes are also beneficial in terms of extending the shelf life of the product.

### 9.1.2 History

Humans are unable to survive without food and drink; therefore, the supply of these essentials has had a major impact on the development of the human species and continues to do so even today. The rapidly increasing world population necessitates that the amount of food wasted due to spoilage is kept to a minimum. Food production is only one part of the process to ensure continuous, diverse, safe, food supplies to meet the consumer demands. Food must also be stored and preserved to achieve this objective. The requirement to store and preserve foods has long been recognized, from the time well before there was any knowledge of microbiology. Fermentation, along with salting, cooking, smoking, and sun drying, is one of the earliest ancient traditions developed by cultures all around the world to extend the possible storage time of foods. Before the initiation of preservation technology, humans frequently had to choose between starvation and eating spoiled foods and then suffer the possible consequences of this. For thousands of years, raw animal and plant ingredients have been fermented. Fermented fruits were probably among the first fermented foods eaten [1,2]. The methods for fermentations were developed by trial and error and from the experiences of many generations.

### 9.1.3 Common Fermented Foods

A selection of the most common fermented foods that have wide geographical distributions are shown in Table 9.1. The key type of microorganisms associated with these foods are also included.

**TABLE 9.1**  
Examples of the More Common Fermented Foods

Food	Principal Ingredient	Key Microorganisms
Wine	Grapes	Yeasts
Beer	Barley	Yeasts
Cider	Apples	Yeasts
Sake	Rice	Molds
Bread	Wheat	Yeasts
Yogurt	Milk	LAB
Cheese	Milk	LAB
Buttermilk	Milk	LAB
Kefir	Milk	LAB + yeasts
Vinegar	Grapes	Yeasts followed by <i>Acetobacter</i> or <i>Gluconobacter</i>
Tempeh	Soybeans	Molds
Soy sauce	Soybeans	Molds + LAB + yeasts
Pickled cucumbers	Cucumbers	LAB + yeasts
Sauerkraut	Cabbage	LAB
Pickled olives	Olives	LAB + yeasts
Fermented sausages	Meat	LAB + molds

Note: LAB, lactic acid bacteria.

## 9.2 Fermentation as a Preservation Method

As new preservation techniques have been developed, the importance of fermentation processes for food preservation has declined. Yet fermentation can be effective at extending the shelf life of foods and can often be carried out with relatively inexpensive, basic equipment. Therefore, it remains a very appropriate method for use in developing countries and rural communities with limited facilities. In addition, the nondependence of fermentation on the use of chemical additives to the food appeals to the “more aware” consumer market. The chemical composition of most foods is relatively stable; therefore, generally preservation is based on eliminating microorganisms or controlling their growth and the overall composition of the microflora. To reduce or prevent microbial spoilage of food, four basic principles can be applied:

1. Minimize the level of microbial contamination onto the food, particularly from “high-risk” sources (asepsis)
2. Inhibit the growth of the contaminating microflora
3. Kill the contaminating microorganisms
4. Remove the contaminating microorganisms

Fermentations use a combination of the first three principles. Fermentations should not be expected to sterilize substandard raw products, but rather should use high-quality substrates. Microorganisms can improve their own competitiveness by changing the environment so that it becomes inhibitory or lethal to other organisms while stimulating their own growth, and this selection is the basis for preservation by fermentation. A number of different bacteriocidal and bacteriostatic factors that can be produced by lactic acid bacteria (LAB) are shown in Table 9.2. Fermentation improves the safety of foods by decreasing the risks of pathogens and toxins achieving the infective or toxigenic level, and extends the shelf life by inhibiting the growth of spoilage agents, which cause the sensory changes that make the food unacceptable to the consumer.

### 9.2.1 Microbial Contamination of Foods

Foods are derived from other living organisms and during their development and preparation they are continuously exposed to microbial contamination. The resultant contaminating microflora can have different effects on the food. These include negative effects such as spoilage, where the food becomes unfit for human consumption or health risks when infectious or toxigenic microorganisms are present. Negligible effects on the food occur when the microflora does not cause disease or any detectable changes in the food. However, benefits can also be reaped from the action of the microorganisms when their activity brings about improvements in the appeal of the food. In developed countries, the improved

appeal is the major reason for microbial fermentations of foods continuing today.

The nutrient content and intrinsic properties of many raw foods make them ideal environments for microbial replication. The rate at which the microorganisms grow depends not only on the intrinsic properties of the food (pH, redox potential, water activity, etc.) but also on the conditions under which it is being stored, the extrinsic factors, for example, temperature. Therefore, many raw food types need to be consumed soon after production to be of high nutritional value. Without preservation measures, delays lead to the nutrients being degraded and utilized by the contaminating microflora.

**TABLE 9.2**

Factors Produced by the Metabolic Activity of Microorganisms That Can Contribute to the Increased Stability and Safety of Fermented Foods

Low pH
Organic acids, e.g., lactic acid, acetic acid, and formic acid
Low redox potential
Nutrient depletion [10]
Accumulation of inhibitors, e.g., toxins, bacteriocins [117], antibiotics, lactococcins, nisin, natamycin, hydrogen peroxide
Ethanol
Diacetyl
Carbon dioxide

Source: Adams, M.R. and Moss, M.O., *Food Microbiology*, The Royal Society of Chemistry, Cambridge, UK, 2000.



**TABLE 9.3**

Examples of Microbial Metabolic End Products Used in Fermented Foods

Metabolic End Product	Example of Uses
Carbon dioxide	Leavening bread
Ethanol	Alcoholic beverages
Acids	
Acetic	Vinegar
Lactic	Fermented vegetables
Flavor compounds	
Diacetyl	Dairy products
Acetaldehyde	Yogurt

**TABLE 9.4**

Potential Benefits of Fermented Foods

Increased	Lowered
Safety	Toxicity
Health benefits	Cooking time
Retail value	Production costs
Nutritional value	Equipment needs
Digestibility	Levels of antinutritional factors
Suitability for subsequent processing	
Sensory properties	
Ease of storage and transportation	
Shelf life	

A major consideration needs to be that under ideal conditions microorganisms can grow very rapidly, being able to double in number in a short period of time. It must also be noted that there is a variation in the optimum environmental conditions for different types and species of microorganisms, for example, microorganisms can be categorized into broad groups such as aerobes and anaerobes depending on their tolerance and use of oxygen and psychrophiles, mesophiles, and thermophiles based on the temperature range optimum for their growth. In addition, the biochemical activity of different microorganisms varies and may change in response to fluctuations in environmental factors, leading to a range of metabolic end products (Table 9.3). By manipulating the environmental conditions, it is possible to select for specific kinds of microorganisms that impart a particular taste, odor, texture, or appearance to the food. This is the basis of fermentation.

### 9.2.2 Benefits of Fermented Foods

Microorganisms *per se* can be used as food sources, but in many instances it is their effects on other food sources that are of major interest. The acceptability of a food to the consumer is based mainly on its sensory properties. The sought-after sensory properties of fermented foods are brought about by the biochemical activity of microorganisms. Fermented foods were developed simultaneously by many cultures for two main reasons: (i) to preserve harvested or slaughtered products, which were abundant at certain times and scarce at others and (ii) to improve the sensory properties of an abundant or unappealing produce [1,3].

However, a range of benefits can be obtained from food fermentations, some of which are shown in Table 9.4. Consequently, fermented foods and drinks still retain an important role in the human diet. Fermentation has low energy demands and can often be carried out without sophisticated technology and designated plants. The simple techniques mean that the procedures can often be carried out in the home [4]. Also, a number of studies have shown that consumers regard fermented food products as healthy and natural, increasing consumer demands and their profitability [5].

## 9.3 Microorganisms Used in Food Fermentations

A variety of groups of microorganisms are frequently used in fermented foods. The principal groups are shown in Table 9.5.

### 9.3.1 Lactic Acid Bacteria

LAB perform an essential role in the preservation and production of wholesome foods. Examples of lactic acid fermentations include (a) fermented vegetables such as sauerkraut, pickled cucumbers, radishes, carrots, and olives; (b) fermented milks such as yogurt, kefir, and cheeses; (c) fermented/leavened breads such as sourdough breads; and (d) fermented sausages (Table 9.1). LAB have been grouped together as

**TABLE 9.5**

Principal Groups of Microorganisms Used for Food Fermentations

Microbial Group	Product
Lactic acid bacteria (LAB)	Lactic acid
Acetic acid bacteria	Acetic acid
Yeasts	Alcohol and carbon dioxide
Molds	Enzymes

**TABLE 9.6**

Characteristics Common to Lactic Acid Bacteria

Characteristics
Gram positive
Catalase negative
Oxidase negative
Nonspore forming
Fermentative anaerobes that are aerotolerant
Produce most of their cellular energy from the fermentation of sugars
Produce lactic acid from hexoses

**TABLE 9.7**

Genera of Lactic Acid Bacteria Commonly Used in Food Fermentations

Genus	Cell Shape/Grouping	Homofermenter	Heterofermenter
<i>Lactobacillus</i>	Rods—single or chains	+	+
<i>Lactococcus</i>	Oval cocci—pairs or chains	+	—
<i>Leuconostoc</i>	Oval cocci—pairs or chains	—	+
<i>Pediococcus</i>	Cocci—pairs and tetrads	+	—
<i>Streptococcus</i>	Cocci—pairs and chains	+	—
<i>Weissella</i>	Coccoid/short rods—single, pairs, or short chains	—	+
<i>Enterococcus</i>	Cocci—single, pairs, or short chains	+	—

Source: Modified from Axelsson, L. in *Lactic Acid Bacteria: Microbiology and Functional Aspects*, Marcel Dekker, New York, 1998, 1–72; Adams, M.R. and Moss, M.O., *Food Microbiology*, The Royal Society of Chemistry, Cambridge, UK, 2000.

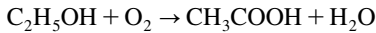
they possess a range of common properties (Table 9.6), and all produce lactic acid that can kill or inhibit many other microorganisms [6]. The primary use of lactic acid in the food industry is as a preservative, an acidulant, or a dough conditioner. The principal genera of LAB are shown in Table 9.7. In general, excluding some streptococci, they are harmless to humans. This makes LAB ideal agents for food preservation. LAB are subdivided based on their products from glucose fermentation. Homofermenters produce lactic acid as the major or sole product from glucose, while heterofermenters produce equimolar amounts of lactate, carbon dioxide, and ethanol. Heterofermenters have an important role in producing aroma components such as acetaldehydes and diacetyl. LAB have a range of methods for outcompeting other microorganisms (Table 9.2). Their most effective mechanism is to grow readily in most foods, producing acid, which lowers the pH rapidly to a point where other competing organisms can no longer grow [3]. Lactobacilli also have the ability to produce hydrogen peroxide [7], which is inhibitory to spoilage organisms [3], while lactobacilli are relatively resistant to hydrogen peroxide [8]. The role of hydrogen peroxide as a preservative is likely to be minor, especially when compared with acid production. Carbon dioxide produced by heterofermenters also has a preservative effect, resulting partially from its contribution to anaerobiosis [3].

Consumers are taking a greater interest in the quality of foods and are creating a demand for chemical-free, “natural health” foods. This has stimulated extensive research into the applications of LAB for both the control of pathogenic and spoilage microorganisms and also for health promotion. A range of potential health benefits has been associated with the consumption of LAB. Some benefits are as a consequence of their growth and activity during food fermentations, and some from the resultant colonization of the gastrointestinal tract (Table 9.8). Many of these health claims are still controversial [9] and are the subject of research to identify and substantiate specific roles [9–11].

### 9.3.2 Acetic Acid Bacteria

A second group of bacteria with importance in food fermentations are the acetic acid producers. Acetic acid is one of the oldest chemicals known; it is named after the Latin word for vinegar “acetum.”

The acetic acid bacteria are acid tolerant, grow well at pH levels below pH 5.0, are Gram-negative, motile rods, and are obligate aerobes. They derive energy from the oxidation of ethanol to acetic acid following the reaction shown below.

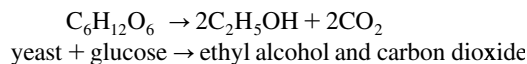


They are found in nature where ethanol is produced from the fermentation of carbohydrates by yeasts, such as in plant nectars and damaged fruits. Other good sources are alcoholic beverages like fresh cider and unpasteurized beer. In liquids, they grow as a surface film because of their demand for oxygen.

The acetic acid bacteria consist of two genera, *Acetobacter* and *Gluconobacter*. *Acetobacter* can eventually oxidize acetic acid to carbon dioxide and water using Krebs cycle enzymes referred to as overoxidation. This is not the case with *Gluconobacter*. The most desirable action of acetic acid bacteria is in the production of vinegar. The same reaction can also occur in wines, when oxygen is available, and here the oxidation of alcohol to acetic acid is an undesirable change, giving the wine a vinegary off-taste.

### 9.3.3 Yeasts

Yeasts are widely distributed in natural habitats that are nutritionally rich and high in carbohydrates, such as fruits and plant nectars [12]. Yeasts are rarely toxic or pathogenic and are generally acceptable to consumers [13]. After extensive study, yeasts have been classified into about 500 species [14]. However, only a small number are regularly used to make alcoholic beverages [12]. *Saccharomyces cerevisiae* is the most frequently used and many variants are available. *Saccharomyces cerevisiae* ferments glucose but does not ferment lactose or starch directly. Yeasts are used to produce ethanol, CO<sub>2</sub>, flavor, and aroma. The reaction can be represented by the following equation:



Other metabolic products include minor amounts of ethyl acetate, fusel alcohols (pentanol, isopentanol, and isobutanol), sulfur compounds, and leakage of amino acids and nucleotides that can all contribute to the sensory changes induced by yeasts [13].

### 9.3.4 Molds

The majority of fungal species have filamentous hyphae and are referred to as molds. They are grouped into four main classes based on the physiology and production methods of their spores. Molds are aerobic and have the greatest array of enzymes. Some molds are used in the food industry to produce specific enzymes such as amylases for use in bread making. They are relatively tolerant to extreme environments and are able to colonize and grow on most foods. Molds are important to the food industry, both as spoilers and preservers of foods and in particular in fermentations for flavor development. Certain molds produce antibiotics [15,16], while mycotoxin production by others is an emerging cause of concern in the food industry.

The *Aspergillus* species are often responsible for undesirable changes in foods, although some species such as *A. oryzae* are used in fermentations of soybeans to make miso and soy sauce. *Mucor* and *Rhizopus* are also used in some traditional food fermentations. *Rhizopus oligosporus* is considered essential in the production of tempeh from soybeans. Molds from the genus *Penicillium* are associated with the ripening and distinctive flavor of cheeses. For example, during ripening of Roquefort and blue cheeses, *P. roqueforti* is grown in air veins throughout the curd, and the distinctive flavors develop as the milk lipids are broken down into methyl ethyl ketone and proteins are structurally altered.

**TABLE 9.8**

Potential Health Benefits from Lactic Acid Bacteria

---

**Benefits**

---

*From foods*

Improved nutritional value, e.g., production of vitamins or essential amino acids  
Reduced toxicity, e.g., by degradation of noxious compounds  
Increased digestibility and assimilability of nutrients [9]

*From colonization*

Control of intestinal infections  
Improved digestion of lactose  
Inhibition of tumor growth  
Lowering of serum cholesterol levels  
Immune stimulation [118]

---

*Source:* Drouault, S. and Corthier, G., *Vet. Res.*, 32(2), 101–117, 2001.

### 9.3.5 Starter Cultures

Fermented foods may be produced by the action of fermentative microorganisms naturally found on the raw materials or in the production environment. However, to improve reliability “starter cultures” are frequently used. Starter cultures may be pure or mixed cultures. Using mixed starter cultures can reduce the risks of bacteriophage infection [17] and improve the quality of the foods when the organisms are mutually beneficial. Food fermentations frequently involve a complex succession of microorganisms induced by dynamic environmental conditions. Fermentative microorganisms must be safe to eat even in high numbers and must produce substantial amounts of the desired end product(s). For practical reasons, the organisms should be easy to handle and should grow well, enabling them to out-compete undesirable microorganisms. The organism also needs to be genetically stable with consistent performance both during and between food batches. In many traditional fermentations, the natural microflora were used for the fermentation. Even so, some form of inoculation was frequently performed using simple techniques such as the use of one batch of food to inoculate the next batch, or the repeated use of the same container [18]. Natural fermentations have a degree of unpredictability, which may be unsatisfactory when a process is industrialized. Starter cultures are increasingly used to improve not only the reliability, but also the reproducibility and the rate at which the fermentation is initiated. Failed, poor-quality, or unsafe products lead to loss of customers and revenue, therefore their incidence must be minimized.

The composition of starter cultures is based on knowledge of food-grade microbial genetics [19,20], metabolism, and physiology as well as their interactions with foods [20]. Starter cultures are now developed mainly by design rather than by screening [21,22]. The overall objective is to exploit the properties of the starter cultures to ensure reproducible standards of safety and quality [23].

---

## 9.4 Classification of Fermented Products

Fermented foods are classified in a number of different ways. They may be grouped based on the microorganisms, the biochemistry, or on the product type [24]. Campbell-Platt (1987) identified seven groups for classification, namely, (1) beverages, (2) cereal products, (3) dairy products, (4) fish products, (5) fruit and vegetable products, (6) legumes, and (7) meat products [25], whereas Steinkraus (1997) classified fermentations according to the type of fermentation, for example, alcoholic wines and beers, and alkaline Nigerian dawadawa [26]. In this chapter, the fermentations are grouped in terms of the biochemical products used to transform the food, for example, production of lactic acid, acetic acid, ethanol, and CO<sub>2</sub>.

---

## 9.5 Fermented Products

### 9.5.1 Alcoholic Beverages

Throughout history alcoholic beverages have had a place in most cultures. They require the alcoholic fermentation of fruits or other high-sugar materials by yeasts. The alcohol content of the beverage acts as a preservative and many of these products have long shelf lives. Over the years, brewing yeasts have evolved by selection and mutations, and have been developed by genetic engineering. Major advances have been made in improving the characteristics of the fermentation strains driven by the high revenue associated with the alcoholic beverage industry.

#### 9.5.1.1 Beer

Beer is produced by the fermentation of partially germinated cereal grains, referred to as malt, by yeasts. Beers have a final ethanol content of about 3%–8%; a huge variety of beers exists and they include ales, lagers, and stouts. Both lagers and ales can be either light or dark in appearance. Ale is produced using *Saccharomyces cerevisiae*, a top fermenter yeast, whereas lagers are produced using pure cultures of *Saccharomyces carlsbergensi*, a bottom fermenter yeast. Ales are produced using warm fermentation temperatures, 12°C–18°C and lager fermentation temperature is generally cold, 8°C–12°C [12]. Most beer produced is of the lager variety.

Several steps are needed to make beer. First, the barley is soaked in water for 5–7 days to make malt [27,28]. During this step, the grains partially germinate and produce enzymes, mainly amylases and proteases that are essential to the brewing process. Amylases degrade starch to glucose, a sugar needed for the yeast fermentation, and proteases solubilize compounds in the grain and hops, which is important for the quality of beer. Following germination, heat is applied to stop further sprouting and to dry the grain. To develop color and aroma, the malt is roasted for 4–5 h at a temperature of 80°C–105°C. Maillard reactions are responsible for the color and aroma formation during kilning. The dried and crushed malt is suspended in water and mixed with boiled malt adjuncts, such as ground rice and corn. Amylase is generally added at this stage to assure complete hydrolysis of starch. The mash is then incubated at 65°C–70°C for a short time to allow the amylase to degrade the starch to glucose. The temperature is subsequently raised to 75°C to inactivate the enzymes and the medium is allowed to settle. Insoluble matter sinks to the bottom and serves as a filter as the liquid, called wort, is taken from the container. Hops or hop extracts are then added to the wort. Hops are an indispensable ingredient as they act as a clarifier causing protein to precipitate; they give a specific aroma and bitter taste. Hops also possess antibiotic properties and together with ethanol and carbon dioxide contribute to the stability of beer [29–31]. In addition, the protein content of hops enhances the foam-building ability of beer. The mixture is boiled for 1.5–2.5 h to obtain the correct delicate hop flavor [32]. The wort/hops mixture is then boiled to concentrate the wort, kill many spoilage microorganisms, inactivate enzymes in the mash, and solubilize important compounds in the hops and mash. The wort is then separated, cooled, and fermented.

Fermentation is initiated by adding the appropriate yeast to the wort. Ale fermentation is completed when the pH is lowered to around 3.8, generally in 7–12 days; lager with pH values of 4.1–4.2 is completed in 5–7 days [33]. During fermentation, the glucose in wort is converted into ethanol and CO<sub>2</sub>. The fermented wort is then aged at 0°C for a period of weeks or months. During this period, the yeast settle to the bottom of the vessel, bitter flavors are mellowed, and other compounds are formed that enhance flavor. The beer is then filtered or centrifuged to remove yeast cells before packing and pasteurization. The beer is finished by addition of CO<sub>2</sub> to a final content of 0.45%–0.52%. Finally, pasteurization of the beer at 60°C or higher may be carried out to destroy spoilage microorganisms [34].

There are a number of factors that protect beer from the growth of contaminating microorganisms. These include low pH, redox potential, and levels of readily available carbon sources, the isohumulones of hops that inhibit Gram-positive bacteria and the alcohol produced by the yeast [35]. The spoilage of beer is caused mainly by acetic acid bacteria, LAB, and wild yeasts. The industrial spoilage of beers is commonly referred to as beer infections [34].

### 9.5.1.2 Wine

Wine can be produced from any fruit juice with sufficient levels of fermentable sugars, in most cases wine is a beverage obtained by full or partial alcoholic fermentation of fresh, crushed grapes or grape juice (must), with an aging process. Wine-type grapes from cultivars of *Vitis vinifera* vines are most commonly used to produce wines [29]. Wine making involves a series of steps. First, grape clusters are cleaned of rotten and dried berries and then separated from the stems. The grapes are subsequently crushed and pressed to release juice, the must. The remaining grape skins and seeds, called pomace, are then removed after a second press. In red wine making, the must is fermented together with the skin to extract the red pigments from the skin, which are released only during fermentation. The extraction of the red pigments is sometimes facilitated by raising the temperature to 50°C prior to fermentation of the mash, or to 30°C after the main fermentation, followed by a short additional fermentation.

The fresh sweet must is treated with sulfur dioxide to suppress the growth of undesirable microorganisms, and prevent enzymatic browning and oxidation thus stabilizing wine color. The must is then inoculated with *Saccharomyces cerevisiae* var. *ellipsoides* or *pastorianus* and allowed to ferment for 3–5 days at temperatures between 21°C and 32°C. During this period, ethanol level may reach 14%–18%. Fermentation of red wine is longer than that of white wine, until the correct amount of color is extracted from the skin. The wine is racked to get rid of the sediments. The wine is drawn-off or decanted into barrels, vats, or tanks for aging, the length of which could vary between 3 and 9 months. During this stage, the wine clears and develops flavors. The wine is then removed from vats and poured into bottles in which aging continues [36]. Following the alcoholic fermentation, a malolactic fermentation can be

initiated to reduce the acidity and mellow the wine. During the malolactic fermentation, malic acid is degraded to lactic acid by many LAB, mainly of the genera *Lactobacillus*, *Leuconostoc* (*L. oenos*), and *Pediococcus* (*P. cerevisiae*) [35]. Lactic acid is not as acidic as malic acid; hence, the acidity of the wine is reduced. Wine can be subjected to some microbial and chemical defects. Microbial spoilage can be caused by molds [37], LAB [38], and acetic acid bacteria [39,40]. Chemical defects lead mainly to the browning of wine as a result of oxidative reactions of phenolic compounds, which in red wines, may result in complete flocculation of the color pigments [41].

### 9.5.2 Distilled Spirits

The fermentations discussed above can only produce a maximum alcohol content of about 17%. Concentrations in excess of this inhibit the metabolism of the yeasts. To obtain higher alcohol concentrations, the fermented product must be subsequently distilled. Whiskey, gin, vodka, rum, and liqueurs are examples of distilled spirits. Although the process for producing most products of these types is quite similar to that for beers, the content of alcohol in the final products is considerably higher.

### 9.5.3 Lactic Acid Products

#### 9.5.3.1 Dairy Products

##### 9.5.3.1.1 Yogurt

Yogurt is a coagulated milk product obtained by lactic acid fermentation through the action of *Streptococcus thermophilus* and *Lb. delbrueckii* subsp. *bulgaricus*. Yogurt is prepared using either whole or skim milk, where the nonfat milk solids are increased to 12%–15% by concentrating the milk, or adding powdered skim milk or condensed milk. The concentrated milk is pasteurized at 82°C–93°C for 30–60 min and cooled to the starter incubation temperature of 40°C–45°C. Yogurt starter is then added at a level of around 2% by volume and incubated for 3–5 h, or until the titratable acidity of the final product reaches 0.85%–0.90% or a pH of 4.4–4.6 [34]. The yogurt is then cooled to 5°C to inhibit further acid production. The symbiotic growth of the two organisms of the yogurt starter culture has been reviewed by many authors [42–44]. The symbiotic growth of the two organisms is better observed when they exist in a 1:1 ratio and this results in lactic acid production and acetaldehyde at a rate greater than that produced by either when growing alone [42]. Streptococci produce lactic acid, formic acid, and carbon dioxide. Formic acid stimulates the growth of lactobacilli. The lactobacilli liberate some amino acids needed for the growth of the streptococci, and produce acetaldehyde and more lactic acid to bring the pH to 4.4–4.6. Acetaldehyde is the compound that contributes mostly to the typical flavor of yogurt, while acetoin, diacetyl, and ethanol are produced in lower concentrations [45]. Yogurt flavor continuously changes during manufacture and storage. Flavor changes may vary depending on the cultures, mix formulation, and incubation and storage conditions [46]. *Lactobacillus acidophilus* may be added with yogurt culture to reduce excessive aldehyde and for health benefits. The type of yogurt starter used can change the physical characteristics of the final yogurt product. For example, ropy cultures used to enhance the viscosity of “stirred” types of yogurt comprise *Streptococcus salivarius* ssp. *thermophilus*, and *Lactobacillus* strains [47]. “Nonropy” starters are used for the manufacture of “set” types of yogurt. Other ways to increase the viscosity of yogurt and subsequently decrease the syneresis of the whey include the addition of stabilizers, increasing nonfat milk solids, extending the time, and increasing the temperature of pasteurization.

##### 9.5.3.1.2 Cheese

Cheese is a concentrated milk product obtained after coagulation and whey separation of milk, cream or partially skimmed milk, buttermilk, or a mixture of these products. Cheese may be consumed fresh or after ripening. Cheese is commonly made from cow, ewe, goat, or buffalo milk. The majority of cheeses are made from pasteurized milk. The use of subpasteurization heat treatment of milk or thermization is also practiced to limit heat-induced changes in milk without compromising microbiological safety. There are over 400 varieties of cheeses representing fewer than 20 distinct types, and these are grouped or classified according to texture or moisture content, whether ripened or unripened, and if ripened, whether by bacteria or molds [34]. Table 9.9 shows the classification of cheeses according to their curing

TABLE 9.9

## Cheese Varieties and Their Classification

Designation	Principal Curing Characteristics and Examples
Uncured or unripened	No curing—must be made from pasteurized milk Cottage, Quark, Cream, Mozzarella
Cured or ripened	Salt-cured or pickled Feta, Domiati
	Ripened by bacteria and surface microorganisms Limburger, Brick, Port du Salut
	Ripened primarily by bacteria, without eyes Provolone, Edam, Gouda, Cheddar, Parmesan, Romano, Grana
	Ripened primarily by bacteria, with eyes Emmental, Gruyère
Mold cured or ripened	Ripened by surface molds Camembert, Brie
	Ripened principally by internal mold growth Roquefort, Stilton, Gorgonzola, Cheshire, Danish Blue

characteristics. The majority of cheeses, with the exception of whey cheeses, are made using variations of the same basic process, as illustrated in Figure 9.1. Slight variations of these and the use of different milks combine to generate the huge range of cheeses available today.

In general, the process of manufacture starts with the preparation of milk. Milk generally receives a treatment equivalent to pasteurization at the start of the processing. The milk is then cooled to the fermentation temperature, which depends on the type of cheese to be manufactured, 29°C–31°C for Cheddar, Stilton, Gouda, Camembert, and Leicester; higher temperatures are employed in the manufacture of high-scalded cheeses such as Emmental, Gruyère, and Italian cheeses. Milk is inoculated with an appropriate lactic starter. The starter culture produces lactic acid, which, with added rennin, gives rise to curd formation. In addition, lactic acid is also responsible for the fresh acidic flavor of unripened cheeses and plays a major role in the suppression of pathogenic and some spoilage microorganisms and in the production of volatile flavor compounds and the synthesis of lipolytic and proteolytic enzymes involved in the ripening process of cheese. The starter organisms most used for cheese production are mesophilic starters, strains of *Lactococcus lactis* and its subspecies. Thermophilic starters such as *Lb. helveticus*, *Lb. casei*, *Lb. lactis*, *Lb. delbrueckii* subsp. *bulgaricus*, and *Streptococcus thermophilus* are used in the production of cheeses where a higher incubation temperature is employed. Propionic bacteria, molds such as *Penicillium camemberti*, *P. candidum*, *P. roqueforti* and red- or yellow-smearing cultures such as *Bacterium linens* are also added, depending on the type of cheese to be manufactured. The time of renneting and the amount added differ with cheese type. After coagulation of the milk, the curd is cut into small cubes for whey expulsion. The curd is further shrunk by heating it and then pressed to expel more whey, followed by salting. Finally, the cheese is ripened under conditions appropriate to the cheese in question.

Cheese ripening involves a complex series of chemical and biochemical reactions. Proteolysis and lipolysis are two primary processes in cheese ripening with a variety of chemical, physical, and microbiological

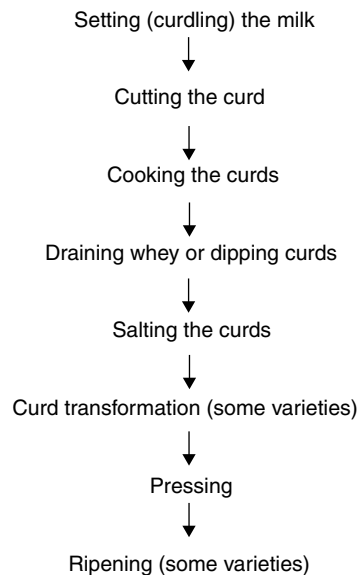


FIGURE 9.1 Basic steps in cheese making.

changes occurring under controlled environmental conditions [48,49]. These reactions are of importance to the flavor and texture development in cheeses [50–52]. Flavor compounds include peptides and amino acids, free fatty acids, methyl ketones, alkanes, lactones, and aliphatic and aromatic esters.

Although most ripened cheeses are the products of metabolic activities of LAB, several known cheeses owe their particular character to other related organisms. In the case of Swiss cheese, *Propionibacterium shermanii* is added to the lactic bacteria *Lb. bulgaricus* and *Streptococcus thermophilus*. Propionibacteria contribute to the typical flavor and texture of Swiss-type cheese [53]. The lipolytic and proteolytic activities of molds play an important role in the maturation of some cheeses. In blue cheese such as Roquefort and Stilton, *Penicillium roqueforti* grows throughout the cheese and imparts the blue-veined appearance characteristic of this type of cheese. *Penicillium camemberti* is associated with surface-ripened soft cheeses such as Camembert and Brie.

### 9.5.3.2 Fermented Vegetables

A large number of vegetables are preserved by lactic acid fermentation around the world. The most important commercially fermented vegetables in the west are cabbage (sauerkraut), cucumbers, and olives. Others include carrots, cauliflower, celery, okra, onions, and peppers. Typically, these fermentations do not involve the use of starter cultures and rely on the natural flora. Brine solutions are prepared in the fermentation of sauerkraut, pickles, and olives. The concentration of salt in the brine ranges from 2.25% for sauerkraut to 10% for olives. The fermentation yields lactic acid as the major product. The salt extracts liquid from the vegetable, which serves as a substrate for the growth of LAB. Growth of undesirable spoilage microorganisms is restricted by the salt. Aerobic conditions should be maintained during fermentation to allow naturally occurring microorganisms to grow and produce enough lactic acid, and to prevent growth of spoilage microorganisms. Olives receive a special treatment before brining in that green olives are treated with a 1.25%–2% lye solution (sodium hydroxide), usually at 21°C–25°C for 4–7 h. This treatment is necessary to remove some of the oleuropein, a bitter compound in olives. In some countries, the fermentation of cucumbers is controlled by the addition of acetic acid to prevent growth of spoilage microorganisms, buffered with sodium acetate or sodium hydroxide, and inoculated with *Lb. plantarum* alone or in association with *Pediococcus cerevisiae*. The controlled fermentation reduces economic losses and leads to a more uniform product over a shorter period of time. Many researches have shown a sequential involvement for different species of LAB [1,54–56]. For sauerkraut production, *Leuconostoc mesenteroides* grows first, producing lactic acid, acetic acid, and CO<sub>2</sub>, followed by *Lb. brevis* and finally *Lb. plantarum* grows producing more acid and lowering the pH to below 4.0, allowing the cabbage to be preserved for long periods of time under anaerobic conditions. The LAB chiefly responsible for production of high-salt pickles are initially *Pediococcus cerevisiae* followed by the more acid-tolerant *Lb. plantarum* and *Lb. brevis*. *Leuconostoc mesenteroides* makes little contribution in the high-salt pickles but is active in the low-salt pickles [57]. The microbiology of the olive lactic acid fermentation is complex with a number of microbial strains being involved. Vaughn et al., [58] have divided the normal olive fermentation into three stages. The initial stage is the most important from the standpoint of potential spoilage if the brines are not acidified. Acidification eliminates the original contaminating population of dangerous Gram-negative and Gram-positive spoilage bacteria and, at the same time, provides an optimum pH for activity of LAB [59]. The natural flora of green olives, consisting of a variety of bacteria, yeasts, and molds, carries out the fermentation with LAB becoming prominent during the intermediate stage. *Leuconostoc mesenteroides* and *Pediococcus cerevisiae* are the first lactics to predominate, followed by lactobacilli, mainly *Lb. plantarum* and *Lb. brevis* [60].

### 9.5.3.3 Fermented Animal Products

The primary reason for developing methods to ferment meats and fish was to extend the shelf life of these highly prized, perishable foods. Gram-positive micrococci have an important role in these fermentations [61]. Several products became popular, including fermented sausages, fish sauces, and fish pastes. Many of the traditional fermentation methods are still used although the primary reason for their use is no longer preservation, but because the products are popular for their enhanced flavors.



### 9.5.3.3.1 Fermented Sausages

A variety of procedures for producing stable, fermented meat sausages have developed around the world. In general, preservation of the meat is achieved by adding salts and the generation of lactic acid by bacteria, which leads to a rapid fall in the pH. Micrococci, staphylococci, and yeasts are responsible for the development of color, taste, and flavor during the fermentation. In addition to fermentation, sausage processing may also include curing, smoking, drying, and aging to improve both the flavor and the shelf life. In addition to the major inhibitory factors of low-water activity achieved by the addition of salt, and in some cases drying and the accumulation of lactic acid, a “hurdle effect” is created by a combination of other inhibitors (Table 9.10), contributing to the preservation of sausages [62].

Sausages can be split into groups based on the extent of drying (Table 9.11). A weight loss of up to 50% can occur in the shelf stable salamis during drying [63]. Bacteria responsible for the fermentation need to be tolerant of both low water activity and salt. These environmental conditions inhibit proteolytic spoilage by Gram-negative bacteria and encourage the generation of LAB resulting in an increase in the proportions of LAB, which may even become dominant [62,64]. Growth of LAB results in a decrease in pH and the amount of available oxygen. These inhibitory factors also contribute to the “hurdle effect” and in combination with other factors control the growth of the Gram-negative and Gram-positive pathogens commonly associated with raw meats.

*Pediococcus cerevisiae*, *Staphylococcus carnosus*, and *Lb. plantarum* are among the most common bacteria involved in meat fermentations [61]. Natural fermentations are still used, but fermentations are increasingly initiated with starter cultures because of their greater reliability. LAB and nitrate-reducing bacteria are important members of starter cultures. Commonly used LAB include *Pediococcus acidilactici* and *Lb. plantarum*. High-salt-tolerant yeasts such as *Debaryomyces hansenii* and molds of the *Penicillium* spp. may also be included [12,65]. Species such as *Micrococcus varians* and *Staphylococcus carnosus* are important when nitrate salts are added instead of nitrites as they convert nitrates into nitrites, which react faster and less is required for compound stabilization [12,29,66].

Fermented sausages are prepared by mixing ground meat with various combinations of spices, flavorings, salt, sugar, additives, and frequently, starter cultures. Common additives include acidulant, ascorbic acid, and colorings [12]. Pork, beef, mutton, or turkey meat can be used, but to achieve good sensory properties and safety, the meat must be fresh and of high quality. The meat is generally used raw, with no heat processing, as this can damage the texture of the sausage product [12]. Frequently fermented sausages are eaten without any cooking stage [1]. The physical properties of the meat, especially the fat content, can affect the efficiency of the drying. To encourage efficient moisture loss, the meat particles must not be too large and the cut edges should not be effectively sealed by being covered in fat. The spices and flavoring agents modify the flavor and odor of the sausages [50]. Spices can also inhibit spoilage agents while stimulating lactic fermentation.

A range of times and temperatures (commonly 15°C–42°C) are used for the fermentation. Generally, the fermentation lasts for several days and the ripening for several weeks. During the fermentation and ripening

**TABLE 9.10**

Factors Contributing to the Stability of Fermented Sausages

Factor
Low pH
High acidity
Accumulation of lactic acid
Various antimicrobial compounds
Hydrogen peroxide from LAB
Phenolic compounds from smoking
Low water activity
Drying
Salting
Spices
Potentially stimulate LAB, inhibit normal spoilage microflora
Low availability of oxygen
Reduced by growth of LAB

**TABLE 9.11**

Examples of Different Sausage Types

Dry Products (Moisture Content Up To 35%)	Semidry Products (Moisture Content About 50%)
Salamis	Cervelats
Pepperoni	Metwursts
	Lebanon bologna (in United States) Thuringer

**TABLE 9.12****Characteristics of Appropriate Sausage-Casing Material**

Permeable to moisture and smoke
Acceptable to the consumer
Shrink as the meat is dried
Retain the sausage mixture
Form the required sausage shape
Edible
No detrimental effects on the sensory attributes of the products

Source: Adams, M.R. and Moss, M.O. in *Food Microbiology*. The Royal Society of Chemistry, Cambridge, UK, 2000.

compounds also have antimicrobial activity and contribute to the safety and stability of the sausages.

Following fermentation, the meat is forced into casings to obtain the typical sausage shape and provide some form of packaging. A range of properties are required for the casing materials and these are shown in Table 9.12. The casings are firmly packed to force out the air, which can cause discoloration of the meat and reduce the shelf life of the sausage.

In addition to microbial growth and the activity of endogenous meat enzymes, lipid autoxidation reactions and the breakdown of proteins to peptides and amino acids by microbial and chemical reactions are also important in generating many flavor compounds [50]. At the end of the ripening period, the flavor of unsmoked sausages can be improved by surface growth of molds, which alter the levels of amino and free fatty acids, and volatile compounds [68]. These fungi should not be toxigenic and should have proteolytic, lipolytic, and antioxidative activity [68].

The primary safety concern during sausage making is to prevent growth of *Clostridium botulinum*. Nitrites can be used to assist this. Outbreaks of disease caused by *Staphylococcus aureus*, *Salmonella*, and verotoxigenic *Escherichia coli* have also been associated with fermented sausages [12]. Although counts of *Salmonella* and other Enterobacteriaceae decline during fermentation and drying, they may not be eliminated [12,69]; indeed, they have been shown to survive during the production of pepperoni [70].

#### 9.5.3.3.2 Fermented Fish

Fermentation of fish is most common in southeast Asia where fish is a major component of the human diet. The carbohydrate content of fish is low, usually less than 1%; therefore, for lactic fermentation an additional source of carbohydrate is required. Ingredients such as rice and garlic may be added as carbohydrate sources; the carbohydrate reserve in garlic is inulin [71,72]. The higher the level of supplemented carbohydrate, the faster the fermentation. The product is often ready after only a few weeks, making the process much more efficient. The supplementation of carbohydrates enables the fish to ferment and an acidic, stable product to be made [12].

The most common products from fish are produced by microbial fermentation and by the degrading activity of autolytic fish enzymes. These products are known as fish sauces and fish pastes. The annual production of these commodities is around 250,000 tonnes [61]. Good-quality fish sauces and pastes provide distinct aromas and flavors. They are used like condiments and are important flavoring ingredients of the diet; they are used to flavor soups, curries, salads, rice, etc.

Sauces and pastes are prepared using whole, eviscerated, or mashed fish. Low-value, abundant small fish are most commonly used, often anchovies or related species. Shrimps may also be used. The fish variety, fermentation conditions, cure duration, and technique all affect the texture, amino acid content, and volatile flavor profile of the finished product. To get a product with a pleasing, fragrant aroma, and taste, very fresh fish must be used.

The fish are washed and salted using approximately three parts fish to one part salt [34]. The salting takes the water activity below 0.75, which prevents normal fish spoilage [12]. Higher concentrations of salt slow the production rate, but extend the shelf life of the final product [65,73]. The fish are sealed into vessels for up to 18 months or more [12]. To shorten the production time, the temperature can be increased; this can be simply achieved by placing the vessels in direct sunshine.

periods, the pH falls, usually into the range pH 4–5. Investigators have demonstrated that the final pH is lower when higher fermentation temperatures are used [67].

Following fermentation, the flavor and odor of the product may be further developed by smoking and drying. Smoking sausages provides distinctive flavors, for example, those of salami and hot dogs, which are developed by the accumulation of phenolic compounds from wood smoke [12]. Different wood types can be used to impart different flavors. The phenolic

The proteins of the fish are broken down by autolytic enzymes producing free amino acids and volatile flavor compounds. The fish become liquefied, the liquid is harvested, and any sediment is removed by filtration. The filtrate is ripened in the sun for a couple of months removing the strong fish odors. Good fish sauce is brown, clear, without sediment, has a pleasant aroma (not too fishy), and is not too salty. Fish sauce is high in protein (up to 10%) and contains all the essential amino acids. Fish sauces are also a rich source of B vitamins, especially B12, pantothenic acid, riboflavin, and niacin. Other beneficial nutrients include calcium, phosphorous, iodine, and iron. Low numbers of streptococci, micrococci, staphylococci, and *Bacillus* spp. have been isolated from fish sauces and are associated with the development of flavor and aroma [34,74]. LAB play an important role in the organoleptic properties and shelf life of these products especially those with a lower salt content.

Fermented fish paste is prepared from salted fish with or without flavoring ingredients. It has a smoother consistency and lower moisture content than sauces. Fat is often added to the final product so that it is spreadable and can be used, for example, as a sandwich spread. The combined effects of salt, acidity, spices, and perhaps fatty acids from the fish oil of fish sauces and pastes usually guarantee microbial safety. However, these products have been implicated in outbreaks of botulism [75,76].

---

## 9.6 Combined Fermentations

The release of carbon dioxide by microorganisms has two major roles in food fermentations: (i) it can act as a leavening agent and (ii) it can be used for carbonation of beverages. One of the most common uses of carbon dioxide is to leaven dough during bread making.

### 9.6.1 Bread

The use of yeasts to produce bread dates back thousands of years [77]. Breads have relatively short shelf lives; therefore, the primary reason for their production was not preservation, but to improve the digestibility and eating appeal of grains. To make leavened bread, flour produced from grains, such as wheat, that contain gluten proteins are used. When the bread is kneaded, the gluten forms a matrix that makes the dough elastic and extensible [77–79]. These properties enable the dough to stretch and retain sufficient amounts of gas to produce loaves with good volume and a fine, soft open structure [80,81]. The gas is a combination of air incorporated during mixing and kneading and CO<sub>2</sub> produced from the fermentation of sugars by yeasts. The yeasts used are normally strains of *Saccharomyces cerevisiae*, commonly known as baker's yeast as they are well adapted for leavening bakery products [81]. The metabolic activity of the yeasts helps to chemically ripen the gluten, enabling the dough to expand evenly and retain the gases during baking. The yeasts contribute to the flavor and provide an appealing aroma. When the loaves are baked the proteins are denatured, fixing the structure, and the low levels of ethanol produced by the yeasts evaporate.

To extend the shelf life of bread, calcium propionate, up to a level of about 3000 ppm, or ascorbic acid is added [82]. Owing to the low water activity of bread, the main spoilage agents are molds, particularly *Rhizopus stolonifer* and *Nerospora sitophila* [83,84], and yeasts, which can cause the defect known as “chalky bread” [85]. In general, baked goods have a good safety record. *Bacillus subtilis* spores may naturally contaminate flour and survive baking and subsequently germinate and grow, degrading the loaf's internal structure producing a sticky slime, which is described as “ropey bread” [86–88]. The sensation of “ropey bread” is not always sufficiently extreme to prevent people eating the bread, and a number of *B. subtilis* outbreaks have been associated with bread [24].

### 9.6.2 Sourdough

Sourdough bakery products have an extended shelf life [89,90]. The fermentation combines the metabolic activity of LAB for souring and yeasts for leavening. Methods for their fermentation date back thousands of years [91]. The sourness of the product depends on many factors, including fermentation temperature and time, type of grain, and the strains of yeast and LAB [92]. The complexity of the bread flavor is based on the lactic and acetic acids produced by LAB and flavor compounds formed by the activity of endogenous cereal enzymes, microbial metabolism, and the baking process [93–95]. The metabolism of LAB and yeasts also provides a range of desirable aroma products.

Traditionally, a natural starter culture that was continuously propagated from one fermentation to the next was used in sourdough fermentations [96]. The dominant yeast strain in sourdough starter cultures was classified as *Saccharomyces exiguous* [97] later reclassified as *Candida milleri*. In San Francisco sourdough cultures, the ratio of yeasts to bacteria is about 1:100. The most common LAB are members of the genus *Lactobacillus*, including strains of *Lb. sanfranciscensis* (also referred to as *Lb. sanfrancisco*) [98], *Lb. reuteri*, *Lb. brevis*, and *Lb. pontis*. To obtain a stable symbiotic relationship, the fermentation conditions must encourage metabolic activity by both the yeasts and LAB. The acid produced by the LAB lowers the pH of sourdoughs into the pH range 3.8–4.5 [34]. *Candida milleri* can tolerate this acid environment [99]. Amylases in the dough provide maltose from starch, which is utilized by the lactobacilli [100]. *Candida milleri* does not metabolize maltose but catabolizes the other sugars present, including glucose released by the lactobacilli [101]. Dead yeast cells can provide a source of fatty acids and amino acids required by the lactobacilli [102,103]. LAB produce various compounds, including organic acids that inhibit a range of mold genera, such as *Fusarium*, *Penicillium*, and *Aspergillus*, that are associated with bread spoilage [104]. The lactobacilli also secrete cycloheximide, which kills many organisms in the dough, but not *Candida milleri*. These act to preserve the bread.

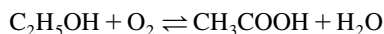
### 9.6.3 Vinegar

Vinegar is one of the oldest known culinary products [105]. It is thought that it was discovered by accident from spoiled wine, in fact it is named after the French term “vin aigre” meaning sour wine. Vinegar is classified as a condiment that contains a minimum of 4% w/v (40 g/L) acetic acid and has a pH value between 2.0 and 3.5 [12,106]. The strength of vinegars may also be quoted in grains, with 10 grains being equivalent to a concentration of 1% acetic acid [35]. Higher strength vinegars may be used for pickling; spirit vinegar is made from an alcoholic solution that has been distilled [24]. Although vinegar has been produced for thousands of years, it remains very popular; it is estimated that the annual worldwide production of vinegars is around 2000 million liters [61].

Vinegar is one of the great successes of the preservation industry, although acetic acid has numerous applications in the food industry. The shelf life of a wide range of foods is extended by storing the product submerged in vinegar; this includes pickled vegetables such as gherkins, olives, and onions. Vinegar is also incorporated into a range of sauces and relishes such as tomato ketchup, Worcester sauce, and a variety of salad dressings and mayonnaise to improve their shelf stability. New applications of vinegars continue to be sought; one such study investigated the feasibility of incorporating acetic acid into a chitosan matrix to prepare a film that could be applied onto processed meat samples so that the acetic acid was slowly released and enhanced bacterial inhibition during vacuum packaging. Inhibition of some bacterial species was observed [107]. In addition, as new food-borne pathogens emerge, research studies focus on the tolerance of these organisms to acetic acid challenges [108,109].

Vinegars are produced from a variety of fermentable substrates [12,110]; fruits, honey, coconut, malt, and cereal grains are among the most common [35], but it may also be produced from alcoholic drinks such as wine or cider. Frequently, the substrate used reflects the common local crops, for example, grapes are used in France, rice in Japan, and malt vinegar is common in the United Kingdom. Vinegars are also important flavoring agents and their potential as “functional foods” is being investigated [24,105,110].

Vinegars are produced from a two-stage fermentation: initially an anaerobic, alcoholic fermentation of sugars by yeasts, followed by oxidation of the ethanol to acetic acid by bacteria; this second reaction is known as acetification. Acetification is also a common cause of spoilage of alcoholic beverages. Acetification can be described by the equation:



Traditionally, vinegar was produced using the indigenous yeasts of the sugar-rich substrates. Now, specific vinegar-making yeast strains, usually *Saccharomyces cerevisiae* var. *ellipsoideus* [61], are often used. The alcoholic fermentation used in the production of malt vinegar essentially follows the same procedures as those used in beer making. In addition to ethanol, the fermentation also yields  $\text{CO}_2$ , some higher acids, and small amounts of glycerol and acetic acid.

In contrast to the alcoholic fermentation, acetification is a highly aerobic process, where bacteria oxidize ethanol to acetic acid. Small quantities of acetaldehyde, ethyl acetate, and acetoin are also produced during this reaction [61]. Commercial acetic acid bacteria are members of the genera *Acetobacter*

and *Gluconobacter*. These bacteria are strict aerobes that are often found naturally in association with yeasts on plants. They are Gram-negative rods that have a high tolerance to acid. Some acetic acid bacteria such as *A. aceti* and *A. pasteurianum* can oxidize acetic acid to  $\text{CO}_2$  and  $\text{H}_2\text{O}$ , a process known as overoxidation [61], and obviously an undesirable reaction in the production of vinegars. Overoxidation is not a problem when *Gluconobacter* species are used [105]. Also, acetic acid concentrations above 6% repress this reaction; therefore, maintaining a minimum level of acetic acid during acetification will reduce the risk of the acetic acid being further metabolized [12,106,111].

The methodology used to convert the alcoholic vinegar stock into vinegar is based around providing a means of effectively combining the alcoholic stock with air and acetic acid bacteria. The rate of vinegar production is dependent on the efficiency of the aeration. More modern techniques have increased the availability of oxygen to the bacteria enhancing the rate of vinegar production. Oxygen is not only desirable to stimulate the metabolism of the bacteria, but it is also essential for their survival. The bacteria utilize oxygen during energy production. Consequently, to avoid product failure the equipment design must ensure a continuous, uninterrupted supply of oxygen [12]. Industrially, three main methodologies are used: (1) the traditional surface methods, (2) the trickle generator process, and (3) the submerged method [12,105,111].

### 9.6.3.1 Traditional Surface Methods

The static surface method is the oldest production method and relies on a layer of acetic acid bacteria forming a bacterial “mat” on the surface of the vinegar stock. The production time is long, as the aeration is poor and the product can be unpredictable, making this method less suitable for mass production. However, small quantities of traditional vinegars are still produced using these techniques for their enhanced aroma and flavor. The technique is simple and requires only basic equipment. The Orleans method, which was developed in France at the end of the fourteenth century [61], attempted to improve the efficiency of the surface technique by making it run semicontinuously. In the Orleans process, a large wooden barrel or vat is partially filled with vinegar stock. Air holes are made just above the surface of the stock. This provides a draft of air across the bacterial film. Inlets to the barrels are covered to prevent insects and debris entering, but with material that does not inhibit airflow. The barrel is left undisturbed until the required acidity is achieved. One acidification cycle usually takes about 14 days [12]. The same barrel may be used continuously for extended time periods by removing volumes of the vinegar slowly from the base of the barrel and then replacing this volume with new stock, requiring acetification, into the bottom of the barrel via a tube that passes through the bacteria. Using this technique the bacterial “mat” remains intact and functioning, thus improving the efficiency of subsequent batches.

### 9.6.3.2 The Trickling Methods

The trickling methods are a further development of the surface technique. These processes have enhanced rates of vinegar production. This is achieved by using larger areas of bacterial film in conjunction with improved aeration. The surface of the bacterial film is greatly increased by including packaging material in the process vat onto which the acetic acid bacteria form a biofilm. The material is usually inert lignocellulosic in nature, for example, birch, vine, rattan, beach wood shavings, or corncobs, and is loosely packed. The stock is sprayed into the vat and slowly trickles down through the packing material across the bacterial film; at the same time air is forced up through the system from below [12]. The distance that the stock travels through the packaging and the time of contact between the bacteria and the vinegar stock can be further increased by using larger sized vats. The process is operated semicontinuously; vinegar collects at the bottom and is recirculated back through the vat until it reaches the required level of acidity. This usually takes about 3–5 days, much quicker than the surface method [12,111]. Between batches, the bacterial film remains more or less intact within the packaging material. As the oxidation of ethanol is exothermic, a cooling system is often incorporated into the vat.

### 9.6.3.3 Submerged Fermentation

In the 1950s, submerged culture technology began and subsequently developed to produce the most rapid rates of vinegar production. Using these systems, the time to convert alcoholic vinegar stock into vinegar

is reduced to around 24–48 h [12,105,106]. The commercially successful processes are frequently based upon the Frings acetator [12,105,106].

Tiny bubbles of air are continuously sparged through the culture volume to improve the efficiency of the aeration to enable the bacteria to grow and metabolize effectively, suspended throughout the culture volume. Specific strains of acetic acid bacteria have been selected for their suitability to growth in suspension. The temperature is controlled, and the system is stirred continuously to maintain homogeneity throughout the culture volume. Submerged cultures are generally run automated to ensure accurate control and monitoring of the environmental parameters to prevent product loss. The systems are run semicontinuously by withdrawing only proportions of product and replacing them with equivalent volumes of fresh stock. The flavors of vinegars produced using these more rapid techniques are improved by allowing a period of maturation. Before bottling, vinegars are pasteurized at 75°C–80°C for 30–40 s [61]. Defects of vinegars include cloudiness resulting from the precipitation of certain metal ions and sliminess following infection with LAB. Entire fermentation batches can fail if the culture becomes infected with bacteriophages.

#### 9.6.4 Kefir

Kefir is produced by an acid/alcohol fermentation of pasteurized milk with a mixture of LAB, yeasts, and other bacteria. The final product is acidic, slightly alcoholic, liquid to semiliquid, and effervescent, and is consumed as a beverage [112,113]. Kefir grains are used to inoculate the milk. Kefir grains comprise proteins, polysaccharides, and a mixture of microorganisms, mainly lactose-fermenting yeasts, and aroma bacteria and LAB [114,120]. The yeasts consist mainly of *Candida kefir* and *Saccharomyces kefir*, while the LAB comprise mainly of *Lactobacillus kefir*, *Leuconostoc* species, and *L. lactis*. The yeasts are responsible for the production of ethanol and carbon dioxide from lactose, the lactococci produce lactate from lactose, and the lactobacilli and *Leuconostoc* species are responsible for the production of lactate, acetate/ethanol, and carbon dioxide [115,116]. Kefir fermentation requires a moderate room temperature (17°C–23°C). The final composition of kefir includes 0.8% lactic acid, 1%–3% alcohol, diacetyl, and acetaldehyde.

#### 9.6.5 Oriental Fermented Products

The production of soy sauce, miso, and saki involves koji fermentation. Koji comprises soybeans or grains on which molds grow to produce enzymes such as proteases, lipases, and amylases. The fungal enzymes produced digest proteins, carbohydrates, and lipids into nutrients that are used by microorganisms in subsequent fermentations. Koji is produced in many varieties depending on the products to be manufactured. Koji differs in terms of the molds, the substrate, the method of preparation, and the stage of harvest.

##### 9.6.5.1 Soy Sauce

Soy sauce is a dark brown liquid produced by the fermentation of soybeans and wheat in a salt brine. The manufacture of soy sauce starts with the treatment of raw material. Soybeans or defatted soybean flakes are moistened and cooked. The cooked beans are then mixed with roasted, cracked wheat in varying ratios for each type of soy sauce. The mixture is inoculated with a pure culture of *Aspergillus oryzae* (*A. soyae*). After 3 days of fermentation, 17%–19% salt solution is added to the koji to produce a mash called moroni. LAB such as *Pediococcus soyae* or *Lb. delbrueckii* are allowed to grow on the moroni to make it acidic enough to prevent spoilage and to make it acidic in taste. Yeasts such as *Saccharomyces rouxii* and *Torulopsis* sp. grow on the moroni to produce alcohol and help the formation of flavor [121]. The moroni is aged, pressed to produce a liquid, soy sauce, which is then pasteurized.

##### 9.6.5.2 Tempeh

Tempeh is a protein-rich food that is considered one of the world's first meat analogs. It is made by growing the mold *R. oligosporus* or related species on soaked, dehulled, partially cooked soybeans, knitting them into a firm cake, which can be sliced and deep-fried or cut into cubes and used in place of meat in

soups [3]. The processing steps of tempeh fermentation are shown in Figure 9.2. Tempeh production is not a means of improving shelf life, but it does improve the acceptability and the nutritional quality of its raw material (soybeans).

## 9.7 Microbial Food Preservatives

As a whole, microorganisms naturally produce an arsenal of antimicrobial agents to improve their competitiveness. A common example is lactic acid, and its use as a food preservative has been discussed extensively in this chapter. The major concern when substances are added to foods as preservatives is any potential risks to the consumer. Consequently, the use of antibiotics as food preservatives has not been pursued due to the health risks posed by bacteria acquiring resistance to antibiotics that are used clinically for controlling infections in humans.

The efficacy of bacteriocins produced by LAB as food additives to inhibit foodborne pathogens is of particular interest as they are produced by food-grade organisms and could therefore be classed as “natural” and are considered to be safe for consumers as they have been consumed in fermented foods for generations. Bacteriocins are bactericidal peptides or proteins that are usually inhibitory to species closely related to the producer. Nisin, lactococcin, and pediocin are bacteriocins that are produced by LAB [12].

Nisin, which is produced by some strains of *L. lactis*, has been accepted for use as a preservative in the food industry. It is a Class I bacteriocin that is active against most Gram-positive bacteria, including spore-formers such as *Clostridium botulinum*, which is a major concern in the food industry. Nisin is especially useful for controlling spoilage of heat-processed foods as it inhibits the outgrowth of spores, including those from *Clostridium* and *Bacillus* spp., the major spoilage agents in these foods. Nisin acts on the outside of the cell. It destroys the integrity of the cell by creating minute holes in the cell membrane. This allows cellular components to leak from the cell and also disrupts the potential across the membrane. Nisin is not active against Gram-negative organisms, yeasts, or fungi.

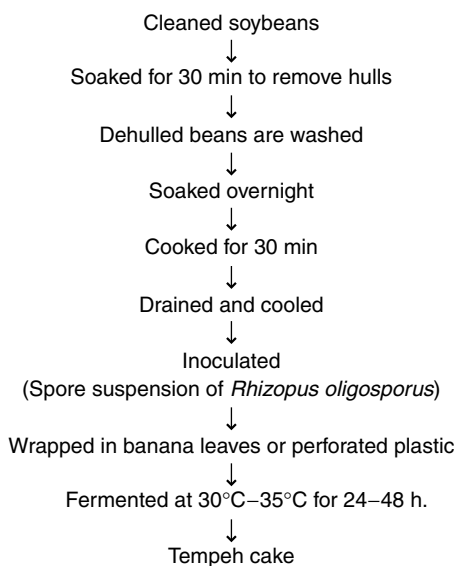


FIGURE 9.2 Flowchart of tempeh fermentation.

## References

1. C.S. Pederson. *Microbiology of Food Fermentations*, 2nd ed. Westport, CT: Avi Publishing Co., 1979.
2. H.A. Dirar. *The Indigenous Fermented Foods of the Sudan*. Wallingford, Oxon: CAB International 1994, p. 552.
3. K.H. Steinkraus. Lactic acid fermentation in the production of foods from vegetables, cereals and legumes. *Antonie van Leeuwenhoek* 49: 337–348, 1983.
4. Y. Motarjemi, M.J. Nout. Food fermentation: a safety and nutritional assessment. Joint FAO/WHO Workshop on Assessment of Fermentation as a Household Technology for Improving Food Safety. *Bull. World Health Organisation* 74(6): 553–559, 1996.
5. A.M. Hamstra. Consumer acceptance of food biotechnology. SWOKA Research Report 137, The Hague, The Netherlands, 1993.
6. L. Axelsson. Lactic acid bacteria: classification and physiology. In: *Lactic Acid Bacteria: Microbiology and Functional Aspects*, S. Salminen, A. von Wight, Eds., New York: Marcel Dekker, 1998, pp. 1–72.
7. A. Hurst, D.L. Collins-Thompson. Food as a bacterial habitat. In: *Advances in Microbial Ecology*, Vol. 3, M. Alexander, Ed., New York: Plenum Publishing Corporation, 1979, pp. 79–134.
8. D.M. Wheater, A. Hirsch, A.T.R. Mattick. Possible identity of “Lactobacillin” with hydrogen peroxide produced by *Lactobacilli*. *Nature (Lond.)* 170: 623–624, 1952.

9. S.L. Gorbach. Lactic acid bacteria and human health. *Ann. Med.* 22(1): 37–41, 1990.
10. W.P. Hammes, P.S. Tichaczek. The potential of lactic acid bacteria for the production of safe and wholesome food. *Z. Lebensm Unters Forsch.* 198(3): 193–201, 1994.
11. S.E. Gilliland. Health and nutritional benefits from lactic acid bacteria. *FEMS Microbiol. Rev.* 7: 175–188, 1990.
12. M.R. Adams, M.O. Moss. *Food Microbiology*, 2nd ed. Cambridge, UK: The Royal Society of Chemistry, 2000.
13. H. Suomalainen, E. Oura. Yeast nutrition and solute uptake. In: *The Yeasts, Vol. 2, Physiology and Biochemistry of Yeasts*, A.H. Rose, J.S. Harrison, Eds., London: Academic Press, 1971, pp. 3–74.
14. N.J.W. Kreger-van Rij. *The Yeasts. A Taxonomic Study*. Elsevier: Amsterdam, 1984.
15. H. Gourama, L.B. Bullerman. Antimycotic and antiaflatoxigenic effect of lactic acid bacteria—a review. *J. Food Protection* 58: 1275–1280, 1995.
16. M.J.R. Nout. Fungal interactions in food fermentations. *Can. J. Bot.* 73:1291–1300, 1995.
17. C. Daly. The use of mesophilic cultures in the dairy industry. *Antonie Van Leeuwenhoek* 49(3): 297–312, 1983.
18. W.H. Holzapfel. Appropriate starter culture technologies for small-scale fermentation in developing countries. *Int. J. Food Microbiol.* 75(3): 197–212, 2002.
19. O.P. Kuipers, G. Buist, J. Kok. Current strategies for improving food bacteria. *Res. Microbiol.* 151(10): 815–822, 2000.
20. R.F. Vogel, M. Ehrmann. Genetics of lactobacilli in food fermentations. *Biotechnol. Annu. Rev.* 2: 123–150, 1996.
21. E.B. Hansen. Commercial bacterial starter cultures for fermented foods of the future. *Int. J. Food Microbiol.* 15; 78(1–2): 119–131, 2002.
22. W.M. de Vos. Advances in genomics for microbial food fermentations and safety. *Curr. Opin. Biotechnol.* 12(5): 493–498, 2001.
23. E. Caplice, G.F. Fitzgerald. Food fermentations: role of microorganisms in food production and preservation. *Int. J. Food Microbiol.* 50(1–2): 131–149, 1999.
24. K.H. Steinkraus. Fermentations in world food processing. *Comprehensive Rev. Food Sci. Food Safety.* 1: 23–32, 2002.
25. G. Campbell-Platt. *Fermented Foods of the World: A Dictionary and Guide*. London, UK: Butterworths, 1987, p. 290.
26. K.H. Steinkraus. Classification of fermented foods: worldwide review of household fermentation techniques. *Food Cont.* 8(5/6): 311–317, 1997.
27. O.P. Hudson. Malting technology. *J. Inst. Brew.* 92: 115–122, 1986.
28. T. Godfrey. Brewing. In: *Industrial Enzymology*, T. Godfrey, J. Eichelt, Eds., London: Macmillan, 1983.
29. H.D. Belitz, W. Grosh. *Food Chemistry*, 2nd ed. Berlin: Springer, 1999.
30. M. Verzele. 100 years of hop chemistry and its relevance to brewing. *J. Inst. Brew.* 92: 32–48, 1986.
31. B.J. Clarke. Hop products. *J. Inst. Brew.* 92: 123–130, 1986.
32. G.K. Buckee, P.T. Malcolm, T.L. Peppart. Evolution of volatile compounds during wort-boiling. *J. Inst. Brew.* 88: 175–181, 1982.
33. S.C. Prescott, C.G. Dunn. *Industrial Microbiology*. New York: McGraw Hill, 1959.
34. J.M. Jay. *Modern Food Microbiology*, 5th ed. Maryland: Chapman & Hall, 1998.
35. G.J. Banwart. *Basic Food Microbiology*, 2nd ed. New York: Chapman & Hall, 1989.
36. M.A. Amerine, H.W. Berg, W.V. Cruess. *The Technology of Wine Making*. 3rd ed. Westport, CT: AVI Publishing Company, 1972.
37. N.M. Daly, T.H. Lee, G.H. Fleet. Growth of fungi on wine corks and its contribution to corky taints in wine. *Food Technol. Aust.* 36: 22–24, 1984.
38. W.D. Edinger, D.F. Splittstoesser. Production by lactic acid bacteria of sorbic alcohol, the precursor of the geranium odor compound. *Am. J. Enol. Vitic.* 37: 34–38, 1986.
39. G.S. Drysdale, G.H. Fleet. Acetic acid bacteria in some Australian wines. *Food Technol. Aust.* 37: 17–20, 1985.
40. A. Joyeux, S. Lafon-Lafoucade, P. Ribéreau-Gayon. Evolution of acetic acid bacteria during fermentation and storage of wine. *Appl. Environ. Microbiol.* 48: 153–156, 1984.
41. T.C. Somers, G. Ziemelis. Flavonol haze in white wines. *Vitis* 24: 43–50, 1985.
42. L. Radke-Mitchell, W.E. Sandine. Associative growth and differential enumeration of *Streptococcus thermophilus* and *Lactobacillus bulgaricus*: a review. *J. Food Prot.* 47: 245–248, 1984.



43. A.Y. Tamime, R.K. Robinson. *Yoghurt. Science and Technology*. Oxford: Pergamon Press, 1983.
44. V. Bottazzi, B. Battistotti, G. Montescani. Influence des souches seules et associées de *L. bulgaricus* et *Str thermophilus* ainsi que des traitements du lait sur la production d'aldéhyde acétique dans le yaourt. *Lait* 53: 295–308, 1973.
45. A. Georgola, E. Tsakalidou, I. Kandarakis, G. Kalantzopoulos. Flavour production in ewe's milk and ewe's milk yoghurt, by single strains and combinations of *Streptococcus thermophilus* and *Lactobacillus delbrueckii* subsp *bulgaricus*, isolated from traditional Greek yoghurt. *Lait* 75: 271–283, 1995.
46. A.Y. Tamime, H.C. Deeth. Yoghurt: technology and biochemistry. *J. Food Prot.* 43: 939–977, 1980.
47. S.M. Schellhaas. Characterization of exo-cellular slime produced by bacterial starter cultures used in the manufacture of fermented dairy products. Ph.D. thesis, University of Minnesota, 1983.
48. Y.K. Jin, Y.W. Park. Effects of aging time and temperature on proteolysis of commercial goat milk cheeses produced in the United States. *J. Dairy Sci.* 78: 2598, 1995.
49. P.F. Fox. Proteolysis during cheese manufacture and ripening. *J. Dairy Sci.* 72: 1379–1400, 1989.
50. J.A. Ordonez, E.M. Hierro, J.M. Bruna, L. de la Hoz. Changes in the components of dry-fermented sausages during ripening. *Crit. Rev. Food Sci. Nutr.* 39(4): 329–367, 1999.
51. M. Rothe, W. Engst, V. Erhardt. Studies on characterization of blue cheese flavour. *Nahrung* 26: 591–595, 1982.
52. A. Cuer. Cheese aromas. *Parfums, Cosmétiques, Aromes.* 44: 88–92, 1982.
53. C. Steffen, P. Eberhard, P.O. Bosset, M. Ruegg. Swiss-type varieties. In: *Cheese: Chemistry, Physics and Microbiology*, P.F. Fox, Ed., Vol. 2, Chap. 3. London: Chapman & Hall, 1993, pp. 83–110.
54. C.S. Pederson, M.N. Albury. The sauerkraut fermentation. New York State Agr. Exptl. Sta. Bull. 824, 1969.
55. J.R. Stamer, B.O. Stoyla, B.A. Dunckel. Growth rates of fermentation patterns of lactic acid bacteria associated with the sauerkraut fermentation. *J. Milk Food Technol.* 34: 521–525, 1971.
56. J.R. Stamer. Recent developments in the fermentation of sauerkraut. In: *Lactic Acid Bacteria in Beverages and Foods*, J.G. Carr, C.V. Cutting, G.S. Whitting, Eds., Fourth Long Ashton Symposium 1973. London: Academic Press, 1975, pp. 267–280.
57. C. Dennis. Microbiology of fruits and vegetables. In: *Essays in Agriculture and Food Microbiology*, R. Norris, G.L. Pettipher, Eds., UK: Wiley, 1987, pp. 227–260.
58. R.H. Vaughn, K.E. Stevenson, B.A. Dave, H.C. Park. Fermenting yeasts associated with softening and gas-pocket formation in olives. *Appl. Microbiol.* 23: 316–320, 1972.
59. J.C.M. Fornachon, H.C. Douhglas, R.H. Vaughn, The pH requirements of some heterofermentative species of *Lactobacillus*. *J. Bacteriol.* 40: 649–655, 1940.
60. R.H. Vaughn. Lactic acid fermentation of olives with special reference to California conditions. In: *Lactic Acid Bacteria in Beverages and Food*, J.R. Carr, C.V. Cutting, G.C. Whitting, Eds., New York: Academic Press, 1975, pp. 307–323.
61. M.J. Waites, N.L. Morgan, J.S. Rockey, G. Higton. *Industrial Microbiology An Introduction*. Blackwell Science Ltd., Oxford, 2001.
62. A.F. Egan. Lactic acid bacteria of meat and meat products. *Antonie Van Leeuwenhoek* 49(3): 327–336, 1983. Review.
63. D.A.A. Mossel, J.E.L. Corry, C.B. Struijk, R.M. Baird. *Essentials of the Microbiology of Foods*. Chichester: Wiley, 1995, pp. 378–378.
64. J.L. Smith, S.A. Palumbo. Microbiology of Lebanon bologna. *Appl. Microbiol.* 26: 489–496, 1973.
65. M.R. Adams, M.J.R. Nout. *Fermentation and Food Safety*. Maryland: Aspen Publishers Inc., 2001.
66. G.J. Nychas, J.S. Arkoudelos. Staphylococci: their role in fermented sausages. *Soc. Appl. Bacteriol. Symp. Ser.* 19: 167S–188S, 1990.
67. J.C. Acton, J.G. Williams, M.G. Johnson. Effect of fermentation temperature on changes in meat properties and flavour of summer sausage. *J. Milk Food Technol.* 35: 264–268, 1972.
68. J.M. Bruna, M. Fernández, E.M. Hierro, J.A. Ordóñez, L. de la Hoz. Improvement of the sensory properties of dry fermented sausages by the superficial inoculation and/or the addition of intracellular extracts of *Mucor racemosus*. *J. Food Sci.* 65(4): 731, 2000.
69. R.A. Holley, A.M. Lammerding, F. Tittiger. Microbiological safety of traditional and starter-mediated processes for the manufacture of Italian dry sausage. *Int. J. Food Microbiol.* 7(1): 49–62, 1988.
70. J.L. Smith, C.N. Huhtanen, J.C. Kissinger, S.A. Palumbo. Survival of salmonellae during pepperoni manufacture. *Appl. Microbiol.* 30(5): 759–763, 1975.

71. C. Paludan-Muller, H.H. Huss, L. Gram. Characterization of lactic acid bacteria isolated from a Thai low-salt fermented fish product and the role of garlic as substrate for fermentation. *Int. J. Food Microbiol.* 18, 46(3): 219–229, 1999.
72. C. Paludan-Muller, R. Valyasevi, H.H. Huss, L. Gram. Genotypic and phenotypic characterization of garlic-fermenting lactic acid bacteria isolated from som-fak, a Thai low-salt fermented fish product. *J. Appl. Microbiol.* 92(2): 307–314, 2002.
73. C. Paludan-Muller, M. Madsen, P. Sophanodora, L. Gram, P.L. Moller. Fermentation and microflora of plaa-som, a Thai fermented fish product prepared with different salt concentrations. *Int. J. Food Microbiol.* 73(1): 61–70, 2002.
74. P. Saisithi, B.O. Kasenmsarn, J. Liston, A.M. Dollar. Microbiology and chemistry of fermented fish. *J. Food Sci.* 31: 105–110, 1966.
75. M. Dawar, L. Moody, J.D. Martin, C. Fung, J. Isaac-Renton, D.M. Patrick. Two outbreaks of botulism associated with fermented salmon roe, British Columbia, August 2001. *Can. Commun. Dis. Rep.* 28(6): 45–49, 2002.
76. A.H. Hauschild, L. Gauvreau. Food-borne botulism in Canada, 1971–84. *CMAJ* 133(11): 1141–1146, 1985.
77. B. Belderok. Developments in bread-making processes. *Plant Foods Hum. Nutr.* 55(1): 1–86, 2000.
78. P.R. Shewry, N.G. Halford, P.S. Belton, A.S. Tatham. The structure and properties of gluten: an elastic protein from wheat grain. *Philos. Trans. R. Soc. Lond. B Biol. Sci.* 28; 357(1418), pp. 133–142, 2002.
79. M. Rohrllich. *Getreide Mehl Brot* 27: 337–342, 1973.
80. S. Dhingra, S. Jood. Physico-chemical and nutritional properties of cereal-pulse blends for bread making. *Nutr. Health* 16(3): 183–194, 2002.
81. T.F. Sugihara. Microbiology of breadmaking. In: *Microbiology of Fermented Foods*, B.J.D. Wood, Ed., Vol. 1. London, UK: Elsevier Applied Sciences Publishers, 1985, pp. 249–262.
82. D.K. O’Leary, R.D. Kralovec. Development of *B. mesenteroides* in bread and control with calcium acid phosphate and calcium propionate. *Cereal Chem.* 18: 730–741, 1941.
83. S. Yassin, A. Wheals. *Neurospora* species in bakeries. *J. Appl. Bacteriol.* 72: 377–380, 1992.
84. G. Spicher. Causes and control of mould contamination of bakeries. *Bakers’ Digest* 41: 30–36, 1967.
85. J.A. Barnett, R.W. Payne, D. Yarrow. *Yeasts: Characterisation and Identification*, 2nd ed. Cambridge: Cambridge University Press, 1990.
86. H. Rosenqvist, Å. Hansen. Contamination profiles and characterisation of *Bacillus* species in wheat bread and raw materials for bread production. *Int. J. Food Microbiol.* 26: 353–363, 1995.
87. P. Kaur. Survival and growth of *Bacillus cereus* in bread. *J. Appl. Bacteriol.* 60: 513–516, 1986.
88. F.J. Farmiloe, S.J. Cornford, J.B.M. Coppock. The survival of *Bacillus subtilis* spores in the baking of bread. *J. Sci. Food Agric.* 5: 292–304, 1954.
89. W.P. Hammes, M.G. Gänzle. Sourdough breads and related products. In: *Microbiology of Fermented Foods*, B.J.B. Wood, Ed. London, UK: Chapman & Hall, 1997, pp. 199–216.
90. P. Stolz, G. Böcker. Technology, properties and applications of sourdough products. *Adv. Food Sci.* 18: 234–236, 1996.
91. W. Röcken, P.A. Voysey. Sour-dough fermentation in bread making. *J. Appl. Bacteriol.* 79: 38S–48S, 1992.
92. H. Salovaara, T. Valjakka. The effect of fermentation temperature, flour type, and starter on the properties of sour wheat bread. *Int. J. Food Sci. Technol.* 22: 591–597, 1987.
93. P. Damiani, M. Gobbetti, L. Cossignani, A. Corsetti, M.S. Simonetti, J. Rossi. The sourdough microflora. Characterization of hetero- and homofermentative lactic acid bacteria, yeasts and their interactions on the basis of the volatile compounds produced. *Lebensm.-Wiss. Technol.* 29: 63–70, 1996.
94. P. Schieberle. Intense aroma compounds—useful tools to monitor the influence of processing and storage on bread aroma. *Adv. Food Sci.* 18: 237–244, 1996.
95. B. Hansen, A. Hansen. Volatile compounds in wheat sourdoughs produced by lactic acid bacteria and sourdough yeasts. *Z. Lebensm.-Unters.-Forsch.* 198: 202–209, 1994.
96. R.F. Vogel, M. Müller, P. Stolz, M. Ehrmann. Ecology in sourdoughs produced by traditional and modern technologies. *Adv. Food Sci.* 18: 152–159, 1996.
97. T.F. Sugihara, L. Kline, M.W. Miller. Microorganisms of the San Francisco sour dough bread process. I. Yeasts responsible for the leavening action. *Appl. Microbiol.* 21: 456–458, 1971.
98. M. Gobbetti, A. Corsetti. *Lactobacillus sanfrancisco*, a key sourdough lactic acid bacterium: a review. *Food Microbiol.* 14: 175–187, 1997.

99. M.L. Suhiko, V. Mäkinen. Tolerance of acetate, propionate and sorbate by *Saccharomyces cerevisiae* and *Torulopsis holmii*. *Food Microbiol.* 1: 105–110, 1984.
100. R.M. Saunders, H. Ng, L. Kline. The sugars of flour and their involvement in the San Francisco sour dough French bread process. *Cereal Chem.* 49: 86–91, 1972.
101. M. Gobbetti, A. Corsetti, J. Rossi. The sourdough microflora. Interactions between lactic acid bacteria and yeasts: metabolism of carbohydrates. *Appl. Microbiol. Biotechnol.* 41: 456–460, 1996.
102. M. Gobbetti. The sourdough microflora: interactions of lactic acid bacteria and yeasts. *Trends Food Sci. Technol.* 9: 267–274, 1998.
103. C. Collar, A.R. Mascaros, C. Benedito de Barber. Amino acid metabolism by yeasts and lactic acid bacteria during bread dough fermentation. *J. Food Sci.* 57: 1423–1427, 1992.
104. A. Corsetti, M. Gobbetti, J. Rossi, P. Damiani. Antimould activity of sourdough lactic acid bacteria: identification of a mixture of organic acids produced by *Lactobacillus sanfrancisco* CB1. *Appl. Microbiol. Biotechnol.* 50(2): 253–256, 1998.
105. L.J. Diggs. *Vinegar*. New York: Universe Incorporated, 2000, pp. 1–317.
106. H. Ebner, H. Follmann, S. Sellmer. Vinegar. In: *Biotechnology, 2nd ed., Enzymes, Biomass, Food and Feed*, H.J. Rehm, T.W. Nagodawithana, Eds., New York: VCH, 1995, pp. 579–591.
107. B. Ouattar, R.E. Simard, G. Pielt, A. Begin, R.A. Holley. Inhibition of surface spoilage bacteria in processed meats by application of antimicrobial films prepared with chitosan. *Int. J. Food Microbiol.* 62(1–2): 139–148, 2000.
108. E.D. Berry, C.N. Cutter. Effects of acid adaptation of *Escherichia coli* O157:H7 on efficacy of acetic acid spray washes to decontaminate beef carcass tissue. *Appl. Environ. Microbiol.* 66: 1493–1498, 2000.
109. Y. Deng, J.H. Ryu, L.R. Beuchat. Tolerance of acid-adapted and non-adapted *Escherichia coli* O157:H7 cells to reduced pH as affected by type of acidulant. *J. Appl. Microbiol.* 86(2): 203–210, 1999.
110. K. Nanda, M. Taniguchi, S. Ujike, N. Ishihara, H. Mori, H. Ono, Y. Urooka. Characterization of acetic acid bacteria in traditional acetic acid fermentation of rice vinegar (komesu) and unpolished rice vinegar (kurosu) produced in Japan. *Appl. Environ. Microbiol.* 67(2): 986–990, 2001.
111. M.R. Adams. Vinegar. In: *Microbiology of Fermented Foods*, B.J.B. Wood, Ed., 2nd ed., Vol. 1. London: Blackie Academic & Professional, 1998.
112. V.M.E. Marshall. The microflora and production of fermented milks. *Prog. Ind. Microbiol.* 23: 1–44, 1986.
113. H. Oberman. Fermented milks. In: *Microbiology of Fermented Foods*, B.J.B. Wood, Ed., Vol. 1. London: Elsevier Applied Science, 1985, pp. 167–195.
114. G. Engel, V. Krusch, M. Teuber. Microbiological composition of kefir. I. Yeasts. *Milchwissenschaft* 41: 418–421, 1986.
115. J.W.M. La Riviere. Studies on the kefir grain. *J. Gen. Microbiol.* 31: V, 1969.
116. J.W.M. La Riviere, P. Kooiman, K. Schmidt. Kefiran, a novel polysaccharide produced in the kefir grain by *Lactobacillus brevis*. *Arch. fur Microbiol.* 59: 269–278, 1967.
117. W.N. Konings, J. Kok, O.P. Kuipers, B. Poolman. Lactic acid bacteria: the bugs of the new millennium. *Curr. Opin. Microbiol.* 3(3): 276–282, 2000.
118. P.D. Schley, C.J. Field. The immune-enhancing effects of dietary fibres and prebiotics. *Br. J. Nutr.* 87 (Suppl 2): S221–S230, 2002.
119. S. Drouault, G. Corthier. Health effects of lactic acid bacteria ingested in fermented milk. *Vet Res.* 32(2): 101–117, 2001.
120. S. Iwasawa, M. Ueda, N. Miyata, T. Hirota, K. Ahiko. Identification and fermentation character of kefir yeast. *Agri. Biol. Chem.* 46: 2631–2636, 1982.
121. F.M. Yong, B.J.B. Wood. Microbiology and Chemistry of soy sauce fermentation. *Adv. Appl. Microbiol.* 17: 157–230, 1974.

# 10

## *Natural Antimicrobials for Food Preservation\**

Eddy J. Smid and Leon G. M. Gorris

### CONTENTS

10.1	Introduction .....	237
10.2	Rationale for the Use of Natural Antimicrobial Compounds .....	238
10.3	Natural Antimicrobials of Plant Origin .....	239
10.3.1	Phytoalexins .....	240
10.3.2	Organic Acids.....	241
10.3.3	Phenolic Compounds .....	241
10.3.4	Essential Oils and Their Components .....	241
10.3.5	Example of Application of Antimicrobials from Plants .....	243
10.4	Natural Antimicrobials of Microbial Origin .....	245
10.4.1	Lactic Acid Bacteria as Protective Cultures .....	245
10.4.1.1	Meat Products .....	246
10.4.1.2	Fish and Seafood.....	247
10.4.1.3	Dairy Products .....	247
10.4.1.4	Vegetable Products .....	248
10.4.2	Bacteriocins Produced by Lactic Acid Bacteria .....	249
10.4.2.1	Nisin .....	249
10.4.2.2	Pediocin.....	250
10.4.2.3	Sakacin .....	250
10.4.2.4	Other Bacteriocins and Combined Treatments .....	251
10.4.3	Natural Occurrence of Bacteriocin Producers .....	251
10.4.4	Application of Bacteriocins and Bacteriocin-Producing Cultures .....	251
10.5	Legislatory Aspects .....	253
10.6	Future Outlook .....	253
	References .....	254

### 10.1 Introduction

The spoilage and poisoning of foods by microorganisms is a problem that is not yet under adequate control despite the range of robust preservation techniques available (e.g., freezing, sterilization, drying, and use of preservatives). In fact, food manufacturers increasingly rely on milder preservation techniques to comply with the consumer demands for foods with a more natural appearance and nutritious quality than can be achieved by the robust techniques. In addition, consumers increasingly refuse foods prepared with preservatives of chemical origin, which still is an everyday practice to achieve sufficiently long shelf life for foods and a high degree of safety with respect to foodborne pathogenic microorganisms. To meet the consumer criteria, food manufacturers are searching for new, more natural alternatives that sufficiently

\*This chapter has not been updated from the first edition.

assure the safety of their products in the retail chain. The search for natural alternatives to chemicals is a logical one, because nature has long been a very generous source of antimicrobial compounds, many of which play an important role in the natural defense or competition systems of living organisms (ranging from microorganisms to insects, animals, and plants). Many plants contain compounds that have some antimicrobial activity, collectively referred to here as *green chemicals*. Spices and herbs, for instance, are well known to inhibit bacteria, yeasts, and molds and have traditionally found wide use in food preservation as well as for medicinal purposes. The use of spices and herbs or their extracts is often less effective than the use of their active ingredients, for which a number of attractive applications have been identified, as will be discussed. With respect to natural antimicrobial activity associated with microorganisms, referred to as *biopreservatives*, a current, mainstream field of study is the use of lactic acid bacteria (LAB). These bacteria have a long and safe tradition in food fermentation, and many potent applications as food preservatives have been established. The bacteriocins produced by LAB are especially promising, which will be discussed in detail. The use of natural antimicrobials in practice is subject to legislative requirements, which can be quite different in various parts of the world, and this needs to be considered when discussing new development in this area of food preservation.

---

## 10.2 Rationale for the Use of Natural Antimicrobial Compounds

In many countries worldwide, there is a rapidly growing demand for environment-friendly, safe preservatives to be used for mild food preservation. Traditional food preservation techniques have undesirable effects on the appeal of fresh food products, and artificial preservatives are increasingly being banned. As a consequence, a variety of fresh or minimally processed, highly perishable vegetables have emerged in the market having undergone milder preservation techniques, such as a combination of refrigeration and modified-atmosphere packaging (see Chapter 14). Mild preservation techniques can control product spoilage caused by microorganisms to some extent, mainly because they are used in adherence with the “hurdle technology” (combined processes) concept [66], as discussed in Chapters 36, 37. However, it is now becoming more evident that potential safety hazards may occur with the mild preservation systems due to the survival and growth of certain foodborne pathogens. Of special concern are cold-tolerant (psychrotrophic) pathogens, like *Listeria monocytogenes*, *Yersinia enterocolitica*, and *Aeromonas hydrophila*, which may grow to levels of concern during the long shelf life of these perishable foods. Mesophilic pathogens (i.e., *Salmonella* spp., *Staphylococcus aureus*, enteropathogenic *Escherichia coli*, and *Bacillus cereus*) pose a health hazard when temperature abuse occurs. Thus, there is an urgent need for the introduction of additional safety factors with these mild preservation techniques.

For a long time, chemical preservatives such as sorbate and benzoate have been used as reliable preservative factors to control a number of microbial hazards. However, such compounds do not satisfy the concept of “natural” and “healthy” food that consumers prefer and that the food industry, consequently, needs to manufacture. The negative reaction to chemical preservatives in our society is strongly increasing, despite the fact that such compounds are as yet indispensable in food processing. As a result, replacement of chemicals by more natural alternatives can only be relevant when necessary (i.e., when the chemical alternatives are no longer acceptable) and possible (i.e., when natural substitutes are indeed [eco-]toxicologically safe to use and effective in practice). The necessity is underlined by many in agro-industry, legislatures, and consumer organizations. The possibility is supported by many studies performed by academics and food industrialists. It is clear that natural alternatives are not always as potent as existing chemicals and that the clever use of combined processes may be a prerequisite for optimal functionality. Also, it is evident that even natural alternatives will have to pass legislative scrutiny and that the label “natural” should not be confused with inherent safety.

Nature is well known to contain many different types of antimicrobial compounds that play an important role in the natural defense or competition systems of all kinds of living organisms, ranging from microorganisms to insects, animals, and plants. In this chapter, only natural antimicrobials from plants and microorganisms will be discussed, since these may be the most feasible substitutes for chemical food preservatives considering practical, legislative, and ethical aspects.

Regarding the development of natural antimicrobial compounds from plants (collectively called green chemicals) for food preservation, research is now focused on the potential use of phytoalexins, organic

acids, and phenols. In addition, promising results have been obtained with essential oils from herbs and aromatic plants. Such essential oils consist of mixtures of esters, aldehydes, ketones, and terpenes with broad-spectrum antimicrobial activity. The toxicological basis of many herbs and spices as well as their active components has been studied [59], and often they are known to be food-grade or even GRAS (generally recognized as safe).

With respect to the natural antimicrobial activity derived from microorganisms (referred to as bio-preservatives), the most promising ongoing development in food preservation is the use of LAB. LAB are GRAS organisms, and have a long and safe tradition in food fermentation practices. The use of these organisms or the antimicrobial compounds they produce has been successfully achieved in many different types of foods. Most prominently, bacteriocins produced by LAB have been under investigation worldwide for food preservation purposes. Bacteriocins are proteins with a rather narrow antimicrobial spectrum, as compared to traditional preservatives. This apparent disadvantage is compensated for by the possibility to use these compounds for targeted control and by the fact that they are not persistent in the environment and are destroyed in the human stomach.

In the rest of this chapter, basic knowledge about the occurrence and antimicrobial properties of those natural antimicrobials of plant and microbial origin will be presented that is relevant and feasible in modern food preservation. In fact, a wealth of knowledge on the topic is available in scientific literature and elsewhere, but only a small sample will be discussed here to illustrate the ongoing quest for useful natural antimicrobials [43,80].

---

### 10.3 Natural Antimicrobials of Plant Origin

For centuries, plants have been appreciated for their antimicrobial or medicinal activity. Some of these plants would be suitable to cultivate instead of lower value crops, thus improving cultivation revenues, which are currently under economic pressure. In many instances, antimicrobials in plants (green chemicals) function in the resistance or defense systems against microbial diseases or pests. Often, they have a particular taste or smell, which has led to them being used in the perfume and fragrance industry. Herbs and spices have been used since ancient times not only as “tastemakers,” but also as preservatives or antioxidants [13,24,71]. A wide selection of literature exists describing the favorable properties and identifying the active components of plants.

The majority of antimicrobial plant compounds are identified as secondary metabolites, mainly being of terpenoid or phenolic biosynthetic origin. The rest are hydrolytic enzymes (glucanases and chitinases) and proteins acting specifically on membranes of invading microorganisms with antimicrobial activity [17,105]. In general, no sharp chemical division can be made between constitutive and induced antimicrobials [44]. Based on the accumulating data on various plant compounds involved in disease resistance, Ingham [58] proposed categorizing the chemical defense systems of plants into pre- and postinfectious factors. Preinfectious factors are constitutive antibiotics, also called *prohibitins*, which are synthesized and stored in specialized tissues where they slow down or arrest *in situ* microbial growth instantly upon infection. Examples of prohibitins are essential oil components with antimicrobial activity. Preinfectious factors that require a postinfectious increase in concentration for an adequate effect are called *inhibitins*. In addition, two types of postinfectious factors can be distinguished: postinhibitins and phytoalexins. Compounds belonging to the first class are toxic metabolites formed after infection by hydrolysis or oxidation of preformed compounds. The second class includes antimicrobial compounds that are synthesized upon invasion of the host plant [106]. In this chapter, a brief overview will be given of natural antimicrobial compounds in plants that belong to one of the four categories: phytoalexins, phenols, organic acids, or essential oil components.

In general, herbs and spices and several of their antimicrobial constituents are GRAS, either because of their traditional use without any documented detrimental impact or because of dedicated toxicological studies. Their application in crop protection and food preservation should be facilitated by this feature, but to date plants still are a poorly exploited source of alternative antimicrobial agents. The enormous potential of plants as a source of antimicrobial compounds is well illustrated in the review of Wilkins and Board [112], who report over 1389 plants as potential green chemical sources, and more specifically by the identification of over 250 new antifungal metabolites in plants between 1982 and 1993 [44]. Obviously, not all

the potential plant sources would qualify to be introduced in our agricultural practices, simply because they would only grow in specific environments. Also, whenever a plant is considered to be exploited as a green chemical source, a thorough evaluation will have to be carried out of its value with respect to the net economy of its cultivation and actual production of the green chemical (be it the whole crop, an extract, or a purified compound), the market value of this antimicrobial preparation, and the costs for going through legislative procedures. Many of the potential sources may not pass this evaluation.

### 10.3.1 Phytoalexins

Phytoalexins are defined as host-synthesized, low-molecular-weight, broad-spectrum antimicrobial compounds whose synthesis from distant precursors is induced in plants in response to microbial infection or treatment of plant tissues with a range of naturally occurring or synthetic, artificial compounds (biotic or abiotic elicitors) [32,46]. By now, more than 200 different phytoalexins have been identified in more than 20 plant families. Phytoalexins are broad-spectrum antibiotics, generally active against phytopathogenic fungi. In contrast to the preformed prohibitins, disease resistance due to phytoalexins is a dynamic process, requiring *de novo* synthesis of secondary metabolites. Also, the enzymes responsible for synthesis of phytoalexins are themselves synthesized in response to exposure to microbes or other effective stimuli [26]. Elicitors, the compounds triggering the synthesis of phytoalexins, range in nature from bacterial proteins [7,51,109] to fungal fatty acids [77] to host plant-derived oligosaccharides [79].

The antimicrobial activity of phytoalexins is often directed against fungi [102], although activity has also been reported toward bacteria [68]. Gram-positive bacteria have been found to be more sensitive than Gram-negative bacteria. Isoflavonoids, characterized by a C<sub>6</sub>-C<sub>3</sub>-C<sub>6</sub> basic skeleton structure, are among the most important chemical classes of phytoalexins [113], and studies on their application outside the natural sources have been undertaken [110]. The leguminosa are known for production of isoflavonoid phytoalexins, for example, pisatin (Figure 10.1 left) from *Pisum sativum*, phaseollin from *Phaseolus vulgaris*, and glyceollin from *Glycine max* [96]. The production of isoflavonoid phytoalexins in plant cell and tissue cultures has aroused much interest [33,34], and this could be a method for large-scale artificial production when a plant itself has no sound commercial potential.

For structurally related compounds in the group of isoflavonoid phytoalexins, it was found that an increase in lipophilicity correlates positively with increased antifungal activity [5]. Terpenoid phytoalexins such as rishitin (Figure 10.1 right) are mainly found in the family of Solanaceae, e.g., in potato tubers. The *in vitro* activity of rishitin against bacteria was found to be inhibited by low levels of the divalent cations Ca<sup>2+</sup> and Mg<sup>2+</sup> [69], indicating that these compounds act on the cytoplasmic membrane of the target microorganisms.

Another major group of phytoalexins, also referred to as disease- or pathogenesis-related proteins, comprises chitinases, thionins, zeamatins, and thaumatins [16,17,100]. Some of these proteins are involved in the synthesis of other phytoalexins or phenolic compounds as constitutive or inducible enzymes. Others reportedly have a direct antimicrobial effect. Because they are proteins, they would be completely digested in the stomach and thus would have no impact on the health of a consumer. Chitinases target chitin, a major component of the cell wall of most phytopathogenic fungi and also of the skeletal structure of most invertebrates, e.g., insects and mites. Healthy plants normally contain low levels of chitinase, but their production is induced following a pathogen attack. The induced chitinase accumulates either intracellularly or in the intercellular space, where their activity is required. Because vertebrates and higher plants do not contain chitin, no adverse impact is known, reinforcing the appeal of chitinases for fungal control. The use of

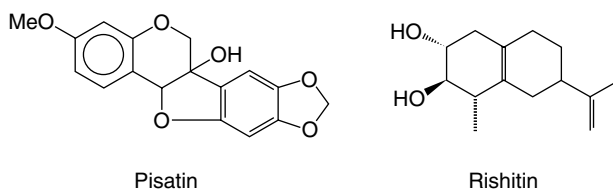


FIGURE 10.1 Phytoalexins from *Pisum sativum* (left) and *Solanum tuberosum* (right).

chitinases as antifungal agents has been studied successfully in the laboratory for almost 10 years [78,88], but the practical application has not yet been realized. The same holds true for thionins, a group of small polypeptides with antifungal and antibacterial activity that occur in cereal endosperm, e.g., in barley, oat, and maize [16]. A closely related compound is viscotoxin from mistletoe. Extracts from this plant have been used against a variety of diseases and are still part of many herbal remedies.

Although the use of phytoalexins in food preservation has been suggested in many reviews [39,43,56,72], there are still very few examples of the actual use of these compounds in food preservation. This is possibly due to the fact that phytoalexins, in general, show adequate antimicrobial effects at relatively high concentrations. In plants, this may not be a problem since these compounds accumulate locally to high concentrations, specifically in wounded plant tissue. The high concentrations necessary in food matrixes when applied from an exogenous source and their occasional cytotoxicity [8] hamper the application of these compounds as food preservative agents. The development of analogs with higher specific activity and reduced toxicity could facilitate the application of these types of compounds.

### 10.3.2 Organic Acids

Citric, succinic, malic, and tartaric acids are commonly found in fruits (e.g., citrus, rhubarb, grapes, and pineapples) and vegetables (e.g., broccoli and carrots). Through their use as acidulants or antioxidants in foods, their antimicrobial properties provide additional benefit. Lactic and propionic acids do not occur naturally in foods other than in trace amounts, although they are readily formed during natural fermentation. The antimicrobial activity of the various acids is extensively documented [60]. They target cell walls, cell membranes, metabolic enzymes, protein synthesis systems, and genetic material. Thus, they are active against a wide range of microorganisms. The organic acids contained in crops may well contribute to the natural crop resistance. Many organic acids or their derivatives are already applied as food preservatives.

### 10.3.3 Phenolic Compounds

At the beginning of the twentieth century, it was believed that plants contained compounds that were toxic toward invading fungi [107]. Initially, the abundant presence of phenolic compounds combined with their apparent *in vitro* activity toward many microorganisms was taken as an indication that these compounds could fulfill the primary role of the chemical defense system of plants. However, the role of plant phenolics in the chemical defense of plants against invading microorganisms is still unclear. Nevertheless, it has been appreciated that a vast range of phenolic compounds contribute to the defense mechanisms of plant tissues as well as to the sensory (taste, odor, and appearance) and nutritional qualities of fresh or processed plants. Phenolics are characterized by an aromatic ring bearing one or, more frequently, several hydroxy substituents, including functional derivatives. Phenolic compounds usually occur conjugated, e.g., to sugars as  $\beta$ -D-glucopyranosides. The phenolic compounds are classified into three groups: simple phenols and phenolic acids (e.g., *p*-cresol, 3-ethylphenol, hydroquinone, protocatechuic, vanillic, gallic, syringic, and ellagic acids), hydroxycinnamic acid derivatives (e.g., *p*-coumaric, caffeic, ferulic, and sinapic acids), and flavonoids [72]. The latter group is the most important single group of phenolics in food, comprising catechins, proanthocyanins, anthocyanidins, and flavons, flavonols, and their glycosides. Finally, tannins, a polymeric form of phenolics, are an important group of plant phenolics, unified by the common ability to precipitate protein from aqueous solution. The antimicrobial activities of the naturally occurring phenolics from olives, tea, and coffee have been studied in more detail than those from other sources, which may in part be due to the high value of the products being processed [72]. Phenolics from spices, such as gingeron, zingerone, and capsaicin, have been found to inhibit germination of bacterial spores. Native plant phenolics are important food preservative factors and have, as a group, an impressive antimicrobial spectrum, although their deliberate use as food preservatives is rarely exploited.

### 10.3.4 Essential Oils and Their Components

Essential oils are mostly derived from spices and herbs but can also be isolated from fruits, roots, and stems of plants. Some oils and isolated plant compounds are used in food as flavoring agents. Derived



from their functionality in plants, these compounds show a wide range of interesting biological activities [71]. Some compounds have been shown to attract flies for pollination, whereas others show a distinct insect-repelling activity. Others attract herbivores for seed distribution or show fungicidal or bactericidal activity to suppress infection by plant-pathogenic microorganisms. Compounds that are approved for use in food and combined antimicrobial activity with low mammalian toxicity have great potential for application as natural food preservatives.

The antimicrobial activities of extracts obtained from spices, herbs, and other aromatic plants or parts thereof using organic solvents or steam distillation have been recognized for many years. Plants and plant extracts have been used since antiquity in folk medicine and food preservation, providing a range of compounds possessing pharmacological activities [28]. Most commonly, the active antimicrobial compounds are found in the essential oil fraction. With many herbs and spices, these compounds contribute to the characteristic aroma and flavor. Essential oils are mostly soluble in alcohol and to a limited extent in water. They consist of mixtures of esters, aldehydes, ketones, and terpenes [47]. Essential oil components with a wide spectrum of antimicrobial effects include thymol from thyme and oregano, cinnamaldehyde from cinnamon, and eugenol from clove.

The impact of essential oils on bacteria, especially on pathogens, has been extensively studied in the laboratory, and significant variations have been noted. For example, *E. coli* was found to be more vulnerable than *Pseudomonas fluorescens* or *Serratia marcescens* to the essential oils of sage, rosemary, cumin, caraway, clove, and thyme [37], whereas *S. typhimurium* was more sensitive to oregano and thyme oils than *P. aeruginosa* [74]. Deans and Ritchie [27] studied the effect of 50 essential oils from plants on 25 genera of bacteria and concluded that both Gram-positive and Gram-negative bacteria are susceptible, but the levels of impact were highly variable. Tassou and Nychas [101] have shown that the essential oil of *Pistacia lentiscus* var. *chia* (mastic gum) inhibits the growth of the food pathogen *Salmonella enteritidis* in skimmed milk. Mold growth on black table olives was found to be suppressed by methyl eugenol and the essential oil from *Echinophora sibthorpiana* [62]. The use of mustard oil in homogenized, canned beef was investigated by Drdak et al. [35]. A concentration of 0.1% allylisothiocyanate, the active antimicrobial compound in mustard oil, did not cause unacceptable sensory effects, allowed sufficient thermosterilization, and resulted in a microbiologically safe product. A recent detailed review by Nychas [72] summarizes findings that essential oil compounds from many different plant sources inhibit many foodborne pathogens (Table 10.1). *Staphylococcus aureus*, *L. monocytogenes*, *A. hydrophila*, *S. typhimurium*, and *Clostridium botulinum* are to some degree sensitive to extracts from linden flower, orange, lemon, grapefruit, mandarin, sage, rosemary, oregano, thyme, cinnamon, cumin, caraway, clove, thyme, allspice, mastic gum, and onion. However, most researchers inevitably came to conclude that the effectiveness of essential oils decreased when experiments were conducted *in vivo*. This could be due to specific components of the food matrix, such as proteins and fats, which immobilize and inactivate the essential oil components.

The antifungal effects of essential oil components from several herbs, spices, and other plant materials have been investigated against important food spoilage or mycotoxigenic species of *Penicillium* and *Aspergillus*, but contradictory results were obtained [2,6,20,74,83]. While some found inhibitory activity, other researchers actually noted stimulating effects. Again, the food matrix may have had a decisive influence here, and it is recommended to standardize the experimental setup accordingly.

Because essential oils contain a variety of compounds from different chemical classes, it is not possible to isolate a single mechanism by which these compounds act on microorganisms. An important common feature of essential oil components is their high degree of hydrophobicity. Therefore, these compounds partition preferentially into biological lipid bilayers as a function of their own lipophilicity and the fluidity of the membrane [73]. Accumulation of lipophilic compounds into biological membranes enhances their availability to the cell, and therefore they may inhibit cell vitality [89,91]. Despite the high degree of ordering of solutes in a lipid bilayer compared with bulk liquid phase [92], a good correlation between the partitioning coefficient of various lipophilic compounds in membrane buffers and octanol–water two-phase systems has been observed [89,90]. Therefore the octanol–water partitioning coefficients, which are known for many different compounds present in essential oils, can be used to assess the potential antimicrobial effect of these compounds [89]. However, the presence of specific reactive groups in compounds, the variability in membrane composition, and the metabolic capacities of the target organisms make a reliable prediction of the toxicity of

**TABLE 10.1**

Antimicrobial Spectrum of Essential Oils from Herbs, Spices, and Plants

<i>Acetobacter</i> sp.	<i>Mycobacterium</i> sp.
<i>Acinetobacter calcoaceticus</i>	<i>M. phlei</i>
<i>Aeromonas hydrophila</i>	<i>Mucor</i> sp.
<i>Alcaligenes</i> sp.	<i>Neisseria</i> sp.
<i>A. faecalis</i>	<i>Neisseria sicca</i>
<i>Arthrobacter</i> sp.	<i>Pediococcus</i> sp.
<i>Aspergillus niger</i>	<i>Penicillium</i> sp.
<i>A. flavus</i>	<i>P. chrysogenum</i>
<i>A. ochraceus</i>	<i>P. citrinum</i>
<i>A. parasiticus</i>	<i>P. patulum</i>
<i>Bacillus</i> sp.	<i>P. roqueforti</i>
<i>B. cereus</i>	<i>Pityrosporum ovale</i>
<i>B. subtilis</i>	<i>Propionibacterium</i>
<i>Beneckeana natriegens</i>	<i>acnes</i>
<i>Brevibacterium ammoniagenes</i>	<i>Proteus vulgaris</i>
<i>B. linens</i>	<i>Pseudomonas</i> sp.
<i>Brochothrix thermosphacta</i>	<i>P. aeruginosa</i>
<i>Campylobacter jejuni</i>	<i>P. clavigerum</i>
<i>Candida albicans</i>	<i>P. fluorescens</i>
<i>Citrobacter freundii</i>	<i>P. fragi</i>
<i>Clostridium botulinum</i>	<i>Rhizopus</i> sp.
<i>C. perfringens</i>	<i>Saccharomyces</i>
<i>C. sporogenes</i>	<i>cerevisiae</i>
<i>Corynebacterium</i> sp.	<i>Salmonella</i> sp.
<i>Edwardsiella</i> sp.	<i>S. enteritidis</i>
<i>Enterobacter aerogenes</i>	<i>S. pullorum</i>
<i>Erwinia carotovora</i>	<i>S. senftenberg</i>
<i>Escherichia coli</i>	<i>S. typhimurium</i>
<i>Flavobacterium suaveolens</i>	<i>Sarcina marcescens</i>
<i>Klebsiella pneumoniae</i>	<i>Staphylococcus aureus</i>
<i>Lactobacillus</i> sp.	<i>Trichophyton</i>
<i>L. minor</i>	<i>mentagrophytes</i>
<i>L. plantarum</i>	<i>Yersinia enterocolitica</i>
<i>Leuconostoc cremoris</i>	<i>Vibrio parahaemolyticus</i>
<i>Listeria monocytogenes</i>	
<i>Micrococcus</i> sp.	
<i>M. luteus</i>	
<i>Moraxella</i> sp.	

Source: Adapted from G. J. E. Nychas, In *New Methods of Food Preservation* (G. W. Gould, Ed.), Blackie Academic, London, 1995, p. 58.

compounds based solely on their hydrophobicity difficult, if not impossible. This is exemplified by carvone and cinnamaldehyde, two compounds with comparable hydrophobicities but different antifungal mechanisms. Both compounds inhibit growth of *Penicillium hirsutum* when administered via the gas phase [93]. Full suppression of growth by carvone was observed only as long as the compound was present in the atmosphere. On the other hand, fungal growth inhibition by *trans*-cinnamaldehyde was found to be strictly irreversible. In conclusion, carvone acts as a fungistatic agent, whereas *trans*-cinnamaldehyde acts as a fungicide. The mechanism behind this difference in antifungal activity was investigated using *Saccharomyces cerevisiae* as a model organism [95]. Cinnamaldehyde was found to cause a (partial) collapse of the integrity of the cytoplasmic membrane, which leads to excessive leakage of metabolites and enzymes from the cell and finally loss of viability. In agreement with its fungistatic rather than fungicidal effect, loss of membrane integrity was not observed with carvone [95].

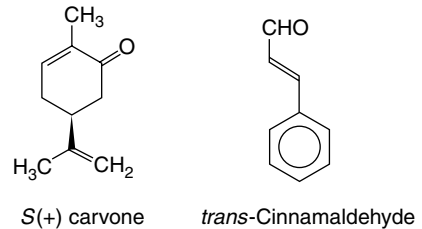
Considering any exploitation of essential oils, it should be stressed that large variations may occur in the yield of active compounds or total oil with the plant genotype and with different extraction methodologies, and also that variations are to be expected in the essential oil composition of the same species according to geographical location and environmental and agronomical conditions, as well as differences in essential oil content with diurnal rhythm. It is clear that essential oils or their active components are by no means a ready-to-use source from a production point of view, and many parameters need to be carefully standardized in detail in that respect.

### 10.3.5 Example of Application of Antimicrobials from Plants

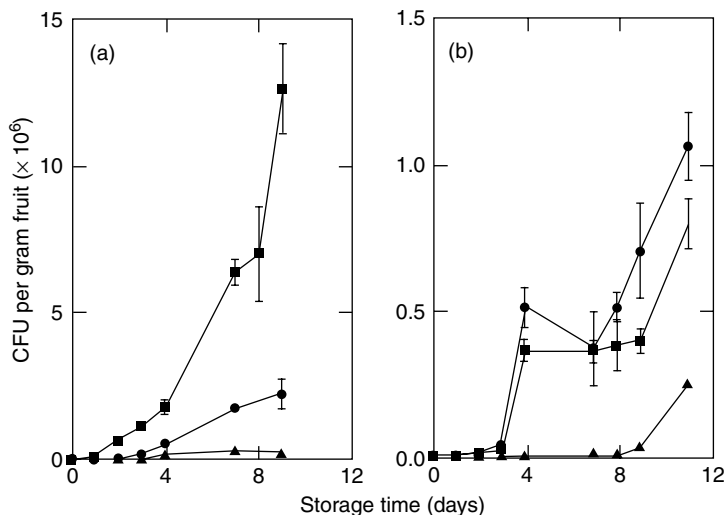
Among the essential oil components, the volatile monoterpenes and aldehydes have attracted recent interest of research and food industries because they can be used as food preservatives that leave a negligible amount of residues. Regarding application in practice, however, the volatile nature of these very potent compounds requires the development of suitable slow-release formulations or tailored packaging systems to maintain their functional activity for a sufficient time. For instance, with carvone, the prime monoterpene in essential oil of caraway (*Carum carvi* L.) seeds (Figure 10.2 left), a powerful antifungal effect has been found, which is already exploited for the protection of potato tubers under storage conditions [50]. However, carvone is gradually lost from the storage environment and has to be administered regularly.

Cinnamaldehyde, the major compound in cassia oil (Figure 10.2 right), shows potent antifungal activity against several food-associated fungi like *Penicillium* sp., *Fusarium* sp., and *Aspergillus* sp. [75]. Cinnamaldehyde also has been shown to possess antiaflatoxigenic properties [70]. When exposed to air, cinnamaldehyde is readily oxidized to cinnamic acid. Therefore, gas-phase application of this

compound is less effective [93]. However, its very potent fungicidal activity and low mammalian toxicity [59] make this natural compound an interesting candidate for application as a surface disinfectant for foods. An example of the use of cinnamaldehyde in food preservation is its potential use as a surface disinfectant for tomatoes [91]. Tomatoes are particularly vulnerable to microbial spoilage at calyces and wound sites on the fruit surface. The major pathogens affecting the postharvest life of tomato fruit are *Alternaria alternata*, *Botrytis cinerea*, and *Rhizopus stolonifer*. Calyces are usually the first part of the tomato on which fungi appear. It has been shown that disinfection of tomatoes with sodium hypochlorite before packaging greatly reduced subsequent microbial spoilage. However, several countries have abandoned the use of hypochlorite for disinfection of foods, and natural plant-derived compounds with sufficient antimicrobial activity and low mammalian toxicity such as cinnamaldehyde could be good alternatives. Smid et al. [91] investigated the reduction of spoilage-associated fungi and bacteria on whole tomatoes packaged under modified-atmosphere conditions. Tomatoes were treated for 30 min with a solution containing 13 mM cinnamaldehyde and stored at 18°C in sealed plastic bags. Under these conditions, the development of the microbial population was recorded on treated and untreated (control) tomatoes. On day 4, visible fungal growth was observed on calyces of untreated fruits. *Penicillium* sp. was found to be the dominant fungal species on the calyx. The calyx of cinnamaldehyde-treated tomatoes remained free from visible fungal growth for at least 9 days. These observations agree with the microbial analysis of the tomatoes (Figure 10.3). After 2 days of storage, pronounced growth of the bacterial population was observed on control tissues treated with 0.85% NaCl. After 4 days of storage, a significant increase in the size of the bacterial population was detected on untreated tomatoes. In contrast, hardly any development of the bacterial population was detectable on cinnamaldehyde-treated tomatoes (Figure 10.3a). As expected, visible fungal growth on calyces of both untreated and NaCl-treated tomatoes appearing at day 4 corresponded with a rapid increase in size of the fungal population. The size of the fungal population on cinnamaldehyde-treated tomatoes remained small under day 11 (Figure 10.3b).



**FIGURE 10.2** Structures of carvone (left) and *trans*-cinnamaldehyde (right), two secondary plant metabolites with antifungal activity.



**FIGURE 10.3** Development of the microbial spoilage organisms on tomatoes stored for 11 days at 18°C in sealed plastic bags. The microbial population on cinnamaldehyde-treated fruits (▲), NaCl-treated fruits (■), and untreated fruits (●) was monitored for 9 (bacteria; panel a) or 11 days (fungi; panel b). The data represent mean values of triplicate measurements, and each data point is calculated from a sample of five tomato fruits. Standard errors of the mean are indicated by error bars. (Modified from E. J. Smid et al., *Postharvest Biol. Technol.*, 9:343, 1996.)

Fungicidal and bactericidal compounds from natural sources, such as cinnamaldehyde, may offer attractive possibilities for disinfection of fresh and minimally processed fruits and vegetables. A bottleneck for practical use of these compounds may be not the efficacy, but rather specific odors associated with such compounds at higher dosages. To overcome this problem, antifungal plant metabolites should be selected for both efficacy and minimal interference with the natural odor of the product.

---

## 10.4 Natural Antimicrobials of Microbial Origin

Microorganisms produce a wide range of components that influence the growth of other microorganisms present in their environment. Often these components increase the competitive edge of the producing organism and as such are an important feature of their survival and proliferation. Regarding food preservation, the most important single group of organisms to be considered as a source of biopreservatives are the LAB. For centuries, these have been used in food fermentation to produce stable food products, including dairy (cheese), meat (sausages), and vegetable (sauerkraut) products. The fact that fermented products, which naturally contain these microorganisms and the antimicrobials they may produce, have been consumed traditionally without a negative health effect, has given LAB GRAS status [42]. LAB may produce both antimicrobial compounds with a relatively broad inhibition spectrum (i.e., organic acids and hydrogen peroxide) as well as compounds with a rather narrow antimicrobial spectrum (i.e., bacteriocins). The use of LAB as biopreservatives is possible via the application of the producing organism as a so-called protective culture to the food product and relying on its proliferation and consequent competition with the microorganisms to be suppressed. Alternatively, preparations of the active antimicrobial compounds may be utilized, with the advantage of an instant and more controllable effect. While the use of protective cultures in most countries needs only to be declared on the product, the use of antimicrobial metabolites such as the bacteriocins is subject to specific rules and regulations in food legislation. Several reviews give more detail on bacteriocins and LAB in relation to their potential for food preservation [1,21,31,55,76,84,85,99].

### 10.4.1 Lactic Acid Bacteria as Protective Cultures

The use of LAB as starter cultures in the production of fermented meats, dairy products, and vegetables is one of the oldest food processing practices utilized and meant to stabilize food products while obtaining specific, desired sensory and organoleptic properties. The success of the fermentation process depends on the competitiveness of starter cultures, and it is exactly for this reason that LAB have been so widely used. The many different antimicrobials they produce are able to counteract a wide range of competitors that would cause problems in the fermentation process. In recent years, some research has been developed to use LAB in food processing applications where the outgrowth of specific problem microorganisms is to be controlled. In this case, the selected LAB are referred to as *protective cultures* and should affect pathogens or spoilage microorganisms without any negative impact on the sensory or organoleptic characteristics of the food product. Production of acids as the main antimicrobial agents is often detrimental to food quality and is not a suitable mechanism of action for protective cultures. LAB that produce a minimum amount of acids but expel bacteriocins in their environment do offer good options as protective cultures.

Although LAB as starter cultures have become widely used and accepted, their use as protective cultures is still under development. Their exploitation depends partly on legislative hurdles relating to the consideration that protective cultures that rely for their activity on bacteriocins are intended for use as preservative agents and function by use of compounds not yet generally recognized as safe in many countries, as discussed elsewhere in this chapter. This is in sharp contrast to the legal status of starter cultures, which are considered to be processing aids or ingredients and not preservatives, and for which the mode of action seems not to be a decisive issue from the legislative point of view. Recently, it has been advocated to employ molecular biology tools to improve the performance of starter and protective cultures with regard to their production or preservation capacity [38]. Since, within the current food legislations, natural strains already have limited access to practice, it is expected that the use of genetically modified strains will not be approved so easily.

The effort to develop protective cultures has been increasing over recent years but has been confined to laboratory studies until now. Some reviews on the topic are available [40,55,56,63,81,85,108,114], although several are published in sources that may not be readily accessible. A number of interesting developments with respect to the use of LAB as protective cultures for several different food categories are discussed below.

#### 10.4.1.1 Meat Products

In a screening exercise involving 221 strains of *Lactobacillus* species evaluated for their ability to inhibit the growth of microorganisms commonly occurring in meat products [87], a wide range of bacteria were found to be affected by individual strains: e.g., *Serratia marcescens* (by 47% of the strains), *Citrobacter freundii* (47%), *Proteus vulgaris* (67%), *S. typhimurium* (9%), and *Brochothrix thermosphacta* (87%). In most cases, the inhibitory activity of the protective culture was attributed to lactic acid formation, although 6 of the 221 LAB isolates (all isolates of *Lactobacillus sake*) formed a bacteriocin contributing to the inhibition of *L. monocytogenes*. Experiments performed by the same researchers on comminuted cured pork (German-type fresh Mettwurst) with pH 5.7 were aimed at control of *L. monocytogenes* and showed that a strain of *Lactobacillus sake* producing a suitable antilisterial bacteriocin was able to reduce the growth potential of the pathogen by about 1 log cycle [86]. A mutant of *Lactobacillus sake* that did not produce the bacteriocin did not affect the number of *Listeria* inoculated into this product. In another study using *Lactobacillus sake* as the protective culture, the control of *L. monocytogenes* in vacuum-packaged sliced Brühwurst (cooked sausages) was emphasized [65]. Sliced sausage samples were inoculated with a mixture of four *L. monocytogenes* serovars, fortified with either one of two bacteriocin-producing strains of *Lactobacillus sake*, isolate Lb706, which produced sakacin A, and isolate Lb674, which produced sakacin 674, or of a nonbacteriocin-producing strain of *Lactobacillus sake* and stored for up to 28 days at 7°C. While the nonbacteriocin-producing LAB reduced counts of *L. monocytogenes* but not to an acceptable extent, both bacteriocin-producing strains of *Lactobacillus sake* were able to control growth of *L. monocytogenes* adequately at the high initial counts tested.

Using bacteriocin-producing and nonbacteriocin-producing strains of *Pediococcus acidilactici* for protection of turkey summer sausages against *L. monocytogenes*, Luchansky [67] found that the pathogen could be reduced by the bacteriocin producer by 3.4 log cycles, but only by 0.9 log cycle when the nonbacteriocin-producing strain was used. In vacuum-packaged wiener and frankfurter sausages, proliferation of *L. monocytogenes* inoculated in the products was suppressed for over 60 days by addition of *P. acidilactici* JD1-23 at 10<sup>7</sup> CFU/g product, whereas the viable count of the pathogen increased from 10<sup>4</sup> to 10<sup>6</sup> in the control [12]. Degnan et al. [29] observed a clear antilisterial effect of yet another bacteriocin-producing strain of *P. acidilactici* in vacuum-packaged wieners stored at abuse temperature (25°C), where the addition of the protective culture resulted in a reduction of *L. monocytogenes* counts by 2.7 log cycles within 8 days while pathogen counts increased by 3.2 log cycles in sausages without added pediococci. In bacon, a pediocin-producing strain of *P. acidilactici* has been used in combination with reduced levels of nitrite to prevent toxin production due to the outgrowth of *C. botulinum* spores. Here, the protective culture would grow during conditions of temperature abuse, producing lactic acid and inhibitory pediocins. Strain *P. acidilactici* H, isolated from fermented sausage, exhibited a broader range of bactericidal activity than any other pediococcal bacteriocin due to the production of a bacteriocin termed pediocin AcH.

Pediocin producers have also been used as protective cultures relying on their lactic acid production, rather than on the production of a bacteriocin. Hutton et al. [57] used the "Wisconsin process" (a combination of lactic acid starter culture and sucrose) to prevent toxigenesis by *C. botulinum* in reduced nitrite bacon. In chicken salads, these authors found that a combination of *P. acidilactici* and glucose prevented botulinum toxigenesis. When the chicken salad was temperature abused, the protective culture catabolized available glucose to lactic acid, which caused a decrease in the pH of the product. Pathogen challenge tests verified that the rate and extent of lactic acid accumulation in the chicken salad during temperature abuse was sufficient to preclude botulinum toxigenesis.

Kotzekidou and Bloukas [64] studied the effect of protective cultures on the shelf life of sliced vacuum-packed cooked ham. They found that cooked ham produced with *Lactobacillus alimentarius* and *Staphylococcus xylosus* as protective cultures was acceptable up to 28 days, while control ham had a

shelf life of 21 days. The activity of the protective cultures was directed toward micrococci, staphylococci, and *B. thermosphacta*. Meat salads with relatively high pH values (pH 6.0–6.5) were studied by Hennlich and Cerny [54] for potential application of LAB as protective cultures in limiting the hygienic risks caused by food salmonellae, staphylococci, or clostridia. The risk of pathogen growth in these foods is most apparent under temperature-abuse conditions, and the research showed that distinct cultures of LAB are indeed able to decrease microbial risks due to foodborne pathogens at elevated temperature. While they do not reduce spoilage by bacilli, yeasts, or fungi, the protective cultures used could reduce the growth of pathogens and actually spoiled the food before the pathogens could grow to hazardous levels.

Andersen [3] recently reported on a commercial protective culture (“FloraCarn L2”) developed for fresh sausages, which can be used as an additional safety and quality factor where contamination during or after processing is a possible hazard. FloraCarn L2 was tested in fresh British sausage mince and was shown to suppress the indigenous microflora and *B. thermosphacta*. In fresh coarse chopped sausages, the protective culture inhibited the possible development of indigenous coliform bacteria during storage.

Research on protective cultures has not always found potential positive applications for bacteriocin-producing LAB. Targeting at the control of *L. monocytogenes* in meats during long-term storage, Buncic et al. [19] tested *Lactobacillus sake* 265 (Lb 265) and *Lactobacillus casei* 52 (Lb 52) isolated from chilled meat products as protective cultures. Although both starter cultures produced bacteriocin at 4°C, they were not able to suppress growth of *L. monocytogenes* inoculated at 10<sup>3</sup> CFU/g on vacuum-packaged, raw beef (pH 5.3–5.4) during 23 days’ storage at 4°C when they were inoculated at the same low level. The protective cultures were equally ineffective when applied on vacuum-packaged emulsion-type sausages (pH 6.4) inoculated with *L. monocytogenes* and stored at 4°C for 23 days. Apparently, the amounts of bacteriocin produced *in situ* by the low initial numbers of protective cultures employed were not sufficient to inhibit or reduce *L. monocytogenes* on chilled meats to any significant extent, and higher initial numbers of LAB are not desirable in chilled meats for product quality reasons.

#### 10.4.1.2 Fish and Seafood

Wessels and Huss [111] studied the use of protective cultures as inhibitors of *L. monocytogenes* in lightly preserved fish products. Coculture of the pathogen with a nisin-producing strain of *Lactococcus lactis* subsp. *lactis* at 30°C resulted in a decline of the pathogen from 5 × 10<sup>5</sup> to <5 CFU/mL within 31 h. However, when the protective culture was inoculated on slices of commercial cold smoked salmon stored at 10°C for 21 days, no net growth was detected. Despite this lack of evidence of *in situ* proliferation of the protective culture on cold smoked salmon slices coinoculated with *L. monocytogenes* (10<sup>4</sup> CFU/g) and the protective culture (3 × 10<sup>6</sup> CFU/g), the population of the pathogen declined by a half log cycle during the first 15 days, then increased at a rate slightly lower than that of the control not inoculated with the lactococcus. Although a complete reduction of the pathogen was not achieved, the experiments proved the point that control of proliferation was feasible under practical conditions.

The use of bacteriocins from LAB for the preservation of brined shrimps, which are usually protected from microbial deterioration by addition of sorbic or benzoic acid, was tested by Einarsson and Lauzon [36]. Three different bacteriocins were evaluated (nisin Z, carnocin U149, and bavaricin A) for their biopreservative potency. With nisin Z, the most effective bacteriocin, a delay in bacterial growth was observed that resulted in an extension of the shelf life by 21 days (from 10 to 31 days). The strongest preservative effect was found with sodium benzoate and potassium sorbate, which completely inhibited microbial growth for 59 days when added to the brined shrimps at levels of 0.05%–0.1% (w/w).

In a recent overview paper, Huss et al. [56] presented an update on biopreservation used with fish products as they discussed a range of relevant topics: biopreservation as a full or partial alternative to salt or chemical additives, protective cultures and their characteristics, selection of protective cultures, and limitations to the application of protective cultures.

#### 10.4.1.3 Dairy Products

To control growth of clostridia in cheese spreads, which cause the so-called late blowing of the product (a combination of gas formation and butyric acid production), Zottola et al. [115] proposed to add

nisin-producing lactococci. Many clostridia are sensitive to nisin, and the use of the protective culture resulted in a significant extension of the shelf life of the product. Specifically, spoilage by *Clostridium sporogenes* was reduced in the nisin-containing cheese spreads.

Contamination by *L. monocytogenes* can also cause problems in the production of cheeses, especially in products such as the Italian cheeses taleggio, gorgonzola, and mozzarella, in which the pH rises during ripening and maturation. Giraffa et al. [41] showed that *Enterococcus faecium* added during the manufacture of taleggio cheese releases a stable, antilisterial bacteriocin. An advantage of the rather narrow activity spectrum of bacteriocins from LAB is apparent from this study. The pathogen was suppressed by the added protective culture, whereas the activity of the thermophilic starter used in the cheese-making process was not affected.

Stecchini et al. [97] investigated the control of postprocess contamination of mozzarella cheeses by bacteriocin-producing strains of *Lactococcus lactis*. They observed that heat-treated cultures of such strains added to mozzarella cheese inoculated with *L. monocytogenes* and packaged in small bags resulted in a decrease in the initial counts of *Listeria*. *Listeria* counts remained significantly below those of the samples prepared without the addition of biopreservatives during a storage period of 2–3 weeks at 5°C.

Giraffa [40] presented a concise state-of-the-art review on the use of biological preservation with dairy products. In this overview, practical applications of protective cultures of LAB to increase the hygienic level of dairy products were reported as well as sensitivity of pathogens during the cheese-making process, survival of pathogens (i.e., *Listeria*) in cheese, cheese made with raw milk, and antimicrobial metabolites of LAB with emphasis on bacteriocins. The author concludes that biological preservation cannot replace good manufacturing practice (GMP) but offers an additional tool for improving the food quality.

#### 10.4.1.4 Vegetable Products

Bacteriocin-producing LAB also show potential for the biopreservation of foods of plant origin, especially minimally processed foods such as prepackaged mixed salads and fermented vegetables. Vescovo et al. [104] observed a reduction of the high initial bacterial loads of ready-to-use mixed salads when bacteriocin-producing LAB were added to the salad mixtures. Furthermore, bacteriocin-producing starter cultures may be useful in the fermentation of sauerkraut [18,49] or olives to prevent the growth of spoilage organisms. In the fermentation of Spanish-style green olives, a bacteriocin-producing strain of *Lactobacillus plantarum* dominated the indigenous LAB without adversely affecting the organoleptic properties of the product [82]. In contrast, a nonbacteriocin-producing variant of this strain was outnumbered by the natural *Lactobacillus* population.

From the studies of Cerny and Hennlich [23] on the use of LAB as protective cultures in potato salad to control food poisoning by salmonellae and toxin-producing staphylococci or clostridia, several prospects became evident. In mayonnaise-based potato salads with pH values of 5.5–6.0 that were exposed to ambient temperatures for up to 1 week, the protective cultures greatly reduced the hygienic risks, although they did not increase the shelf life of those products.

Hennlich [53] reported on the selection and evaluation of LAB isolated from potato salads as protective cultures for chilled delicatessen salads, assuming that they were well adapted ecologically. Important criteria for selection were minimum growth temperature, rate of acidification at refrigeration temperature, and rapid growth and acid formation at abuse temperature (mimicking interruption of the cold chain). These criteria were adequately met by *Lactobacillus casei* ILV 110 and *Lactobacillus plantarum* ILV 3. When used as protective cultures ( $10^4$  CFU/g minimum), these strains inhibited the normal spoilage flora of delicatessen salads and also suppressed growth of *E. coli* and *C. sporogenes* inoculated into meat salads during storage at chill temperature. One of the isolates, *Lactobacillus plantarum* ILV 3, was found to be suitable as a protective culture for weakly acidic delicatessen salads pH 5.0–6.0 as well.

Cerny [22] studied the inhibitory effect of a range of LAB (*Leuconostoc cremoris*, *Lactobacillus lactis* var. *diacetylus*, *Lactobacillus lactis* subsp. *lactis*, *Lactobacillus lactis* subsp. *cremoris*, and *Lactobacillus casei*) on the growth of several indicator microorganisms (*E. coli*, *Staphylococcus saprophyticus*, and *C. sporogenes*) in mayonnaise-based meat and potato salads (pH 5.5–6.5; prepared using pasteurized ingredients to eliminate endogenous LAB). It was found that addition of *Leuconostoc cremoris* as a protective culture to potato salad completely controlled *E. coli* and *C. sporogenes* growth at room temperature. *Lactobacillus lactis* subsp. *lactis* (inoculation level  $10^3$ – $10^6$  CFU/g) suppressed

*E. coli* ( $10^2$ – $10^4$  CFU/g) in meat salad stored at room temperature. Importantly, it was concluded that the best protective effects were observed when the ratio of *Lactobacillus lactis* subsp. *lactis* to *E. coli* was greater than 10:1.

### 10.4.2 Bacteriocins Produced by Lactic Acid Bacteria

Bacteriocins are small proteins produced by many bacterial genera, including LAB. Most of the bacteriocins produced by LAB inhibit the growth of other LAB, but some are bactericidal to a number of food pathogens and food-spoilage bacteria. In all cases, these other bacteria are Gram positive. Thus, the bacteriocins or their producers can probably not be used as a general safety hurdle, but could still be used to form a specific hurdle to suppress the growth of notorious Gram-positive pathogens such as *L. monocytogenes*, *C. botulinum*, and *B. cereus*.

Although many different bacteriocins have currently been identified and their potential use as food preservatives is apparent, the exploitation in current practice is limited to two bacteriocins: nisin and pediocin. The limited exploitation of bacteriocins is mainly due to the rather small bactericidal range of most bacteriocins, their low efficiency of production, their limited stability in the food matrix, and, overall, their disputed regulatory status. In fact, considering the limitations to practical application, only a few of the new bacteriocins have sufficient favorable assets in comparison to nisin and pediocin that would warrant the effort of pursuing implementation in practice. Nevertheless, the increasing doubt about the safety of traditional chemical preservatives such as nitrite and propionate fuels the revival of interest seen in applied research today aimed at the introduction of natural preservative factors such as the bacteriocins.

Ever since the identification of the inhibitory activity of a strain of *Lactococcus lactis* subsp. *lactis* in 1928, LAB have been increasingly scrutinized for bacteriocin production. The inhibitory agent was later termed nisin, the first known and most extensively studied bacteriocin of LAB. Table 10.2 lists some of the potential applications of nisin. Today, more than 30 different bacteriocins produced by some 17 species of LAB have been identified, and much information has been obtained on the biochemistry and range of bactericidal activity. For food preservation, advantageous features of several bacteriocins are their relatively high heat resistance and inhibition of Gram-positive foodborne pathogens and spoilage organisms. Much attention has been given to the inhibition of *L. monocytogenes*. This cold-tolerant bacterium, which can result in a high mortality rate, occurs in many different foods, causing problems specifically in dairy (soft cheeses) and meat (pate, sausages) products. Also, the bactericidal impact of several bacteriocins on spore-forming bacteria, such as *Bacillus* and *Clostridium* species, has been the subject of research for many decades and indicates the greater potential these bacteriocins could have in food preservation. A brief overview of the research on three interesting bacteriocins is presented with data taken from a variety of sources [25,30,31,48,55,61,76,87,99].

**TABLE 10.2**  
Foods and Beverages in Which the Bacteriocin Nisin Has Been Used

Food Product	Function or Use
Swiss-type cheese	Prevention of blowing faults caused by clostridia
Milk	Extension of shelf life
Tomato juice	Allows lower heat-processing requirements
Canned foods	Control of flat sour caused by thermophilic spoilage bacteria
Sauerkraut	Optimizing starter function by improving competitiveness
Beer	Inhibition of spoilage by lactic acid bacteria
Wine	Control of spoilage by lactic acid bacteria

Source: L. G. M. Gorris and M. H. J. Bennis, *Int. Z. Lebensm. Technol. Verfahrenstech. (ZFL)*, 45(11):65, 1994.

#### 10.4.2.1 Nisin

Nisin is a protein consisting of 34 amino acids, which is stable on autoclaving and effectively inhibits growth of important Gram-positive foodborne pathogens like *L. monocytogenes* and *S. aureus*, and prevents outgrowth of spores of many species of *Clostridium* and *Bacillus*. It is especially active in acidic food matrixes. The bacteriocin is produced by some strains of *Lactococcus lactis* subsp. *lactis*, although different strains may produce structural variants deviating slightly in exact amino acid composition. Originally, nisin was considered for use as an



antibiotic, but because its range of inhibition is limited, it was not judged suitable for therapeutic use. However, nisin is completely degraded in the alimentary tract and it therefore can be used safely as a food additive. Its potential use as a food preservative was first demonstrated through the successful employment of nisin-producing cultures in the manufacture of Swiss-type cheeses. Owing to their inhibition of gas-producing clostridia, blowing of the cheeses is prevented. Although vegetative cells of these organisms are killed or reduced in number by normal processing conditions, the heat-resistant spores require an excessive "botulinum cook" or the use of chemical additives to prevent their outgrowth. Nisin may be used as a natural additive to inhibit spore outgrowth or reduce their heat resistance.

Nisin has been used in conjunction with other preservative measures to enhance product safety or quality. In canned foods such as vegetables, soups, and puddings, nisin has been applied in conjunction with heating to successfully counteract heat-resistant spores of flat-sour thermophilic bacteria. Normal heating and nisin may be combined for milk preservation in countries where pasteurization, refrigeration, and transportation facilities are not adequate and where it is difficult to assure the supply of good quality milk to the public. When nisin is used with acetic, lactic, or citric acid, the effectiveness of blanching and pasteurization treatments may be better than with nisin or the organic acids alone. The use of nisin in combination with nitrite in meat products has been reported frequently. Although the combined application may allow for less nitrite to exert an identical degree of inhibition of clostridia compared to nitrite alone, the meat systems seem to influence the effectiveness of nisin strongly. Inhibition of *L. monocytogenes* in raw meat, for instance, may continue for 2 weeks at 5°C, but both the inhibitory effect and the nisin-related activity rapidly diminish at room temperature. Comparable findings hold for clostridia suppression in bacon and sausages. Conceivably, binding of nisin to meat particles and high salt concentration may reduce the amount of nisin in solution where it may be active.

#### 10.4.2.2 *Pediocin*

Pediocins are bacteriocins produced by LAB of the genus *Pediococcus*. The first report on pediocin production dates back to 1975, when it was found that *Pediococcus pentosaceus* inhibited growth and acid production of *Lactobacillus plantarum*, an undesirable competitor in mixed-brine cucumber fermentation. The active agent, designated as pediocin A, inhibited a broad range of LAB as well as several clostridia, *S. aureus*, and *B. cereus*. The finding implied that pediocin production might be a favorable asset of starter cultures in the fermentation of sausages and vegetables, where reported staphylococci and naturally competing LAB are the major concern, respectively.

Several applications of pediocins have been assessed with regard to food safety. Pediocin PA-1, produced by a strain of *Pediococcus acidilactici*, has been shown to inhibit growth of *L. monocytogenes* inoculated into cottage cheese, half-and-half cream, and cheese sauce for 1 week at 4°C, whereas rapid growth to high cell densities was observed in the control samples (no bacteriocin added). The activity of pediocin PA-1 was not affected by fat or proteins present in the foods, while a synergistic action was noted between the effect of the bacteriocin and lactic acid. Extensive tests have shown that this pediocin is nontoxic, nonimmunogenic, and readily hydrolyzed by gastric enzymes. The potent antilisterial activity and the effectiveness of pediocin AcH and other pediocins as biopreservatives have by now been well established experimentally in beef wieners, semidry sausage, frankfurters, and fresh meat.

#### 10.4.2.3 *Sakacin*

Sakacins, a group of bacteriocins produced by *Lactobacillus sake*, owe their discovery to the intensive search for natural antimicrobial compounds capable of increasing the shelf life of raw meat by inhibiting the growth of meat-spoilage microorganisms and controlling *L. monocytogenes*. Several different antimicrobials are known to be produced by strains of *Lactobacillus sake*, which normally reside in meat products. These strains are well adapted to the conditions in meats and conceivably are the best competitors in this food environment.

Lactocin S, produced by the strain *Lactobacillus sake* 45 isolated from naturally fermented sausage, is inhibitory against a range of LAB, including organisms from the same sausages. A similar bacteriocin is produced by a strain of *Lactobacillus sake* isolated from Spanish thy sausages. However, the bactericidal range of this compound is much wider, including LAB and several Gram-positive foodborne pathogens, e.g., *L. monocytogenes*, *S. aureus*, *C. botulinum*, or *C. sporogenes*.

#### 10.4.2.4 Other Bacteriocins and Combined Treatments

Most other bacteriocins identified are interesting mainly from a food-quality point of view, since their bactericidal activity is directed toward closely related LAB only. The impact of this in the quality of starter cultures has been mentioned before. Bacteriocin-producing strains of *Lactobacillus helveticus* (producing helveticins and lactocins), *Lactobacillus acidophilus* (lactacins, acidophilucin), and *Lactobacillus plantarum* (plantaricins, plantacin) have been most extensively studied in this respect. With regard to food safety, the reported inhibition of *C. botulinum* and even the Gram-negative *A. hydrophila* by plantacin BN-producing strains of *L. plantarum* is very noteworthy.

Several members of the genus *Carnobacterium*, a group of LAB that have been found in large numbers in chilled meat products, have been found to produce bacteriocins (carnocins) or bacteriocin-like compounds in relatively high amounts at chill temperatures, which would give them a favorable competitive edge over psychrotrophic foodborne pathogens and spoilage organisms. Again, the bactericidal range is restricted mainly to the closely related LAB, but inhibition of *L. monocytogenes* and *A. hydrophila* has also been reported.

Although Gram-negative bacteria, yeasts, and molds are in general not sensitive to the action of bacteriocins from LAB, the presence of chelating agents, surfactants, or osmotic shock (high salt) may sensitize them. A combined preservation scheme would be advantageous here, as shown by Stevens et al. [98] for several combination treatments with nisin that inactivate *Salmonella* and other Gram-negative species. Other reports highlighted the specific benefits of combining nisin with EDTA [15], citrate [14], lysozyme and citric acid [4], pediocin [45], and siderophores [52] in improving the inhibitory activity of nisin toward Gram-negative bacteria or even in extending its inhibitory spectrum to cover Gram-negative bacteria.

#### 10.4.3 Natural Occurrence of Bacteriocin Producers

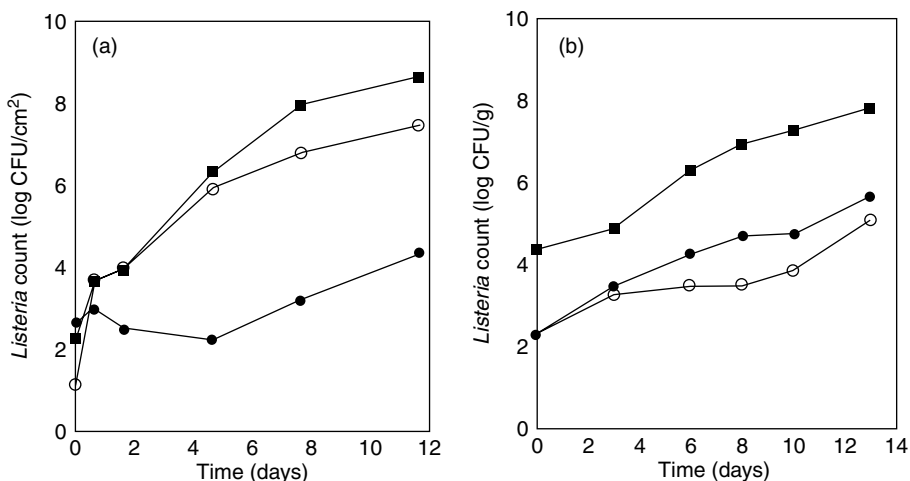
LAB occur naturally in many different foods (e.g., fruits and vegetables) or are often used in their production. Much research in the recent past has been devoted to tracing bacteriocin-producing LAB in fresh and fermented food products. Although the methods used were not always standardized, it is generally accepted that only a very small number of isolates obtained from food products are able to produce bacteriocins and that the spectrum of inhibition is highly variable. Vaughan et al. [103], for instance, evaluated LAB isolated from cheese, milk, meat, fruits, and vegetables for bacteriocin production targeted at a number of spoilage and pathogenic bacteria. Approximately 1000 isolates from each of the food categories were tested to inhibit *Staphylococcus aureus*, *Listeria innocua*, and *Pseudomonas fragi*. LAB isolated from cheese, milk, and meat samples inhibited *L. innocua* rather than the other target strains. LAB isolated from vegetable material generally inhibited *S. aureus*. The majority of active strains was effective against only one of the indicators, but a few were inhibitory to two or three of the target microorganisms. In our own laboratory, only 9 out of 890 isolates taken from fresh and modified-atmosphere-stored vegetables were found to be bacteriocinogenic [9,10]. This indicates that indeed only a small part of the total population of LAB has this ability. Investigations into the capacity of different strains of *L. lactis* subsp. *lactis* present in different culture collections throughout the world to produce nisin have shown that there is drastic difference in this respect even between isolates of the same subspecies.

#### 10.4.4 Application of Bacteriocins and Bacteriocin-Producing Cultures

Bacteriocins can be applied to food systems by three basic methods [42]. First, a pure culture of the viable bacteriocin-producing LAB can be applied, which offers an indirect way to incorporate bacteriocins in a food product. The success of this type of application depends on the ability of the bacteriocin-producing LAB to grow and produce the bacteriocin to the required extent in the food under the prevailing environmental conditions (temperature and pH). Second, a (semi)purified preparation of the bacteriocin can be employed. In this way, the dosage of the bacteriocin can be most accurate and thus its effect most predictable. However, application of (semi)purified preparations is limited by national regulations concerning food additives. Finally, a crude bacteriocin preparation is obtained by growing the bacteriocin-producing LAB on a complex, natural substrate (e.g., milk). This mode avoids

the use of a purified compound while still being able to use a preparation of known and constant activity. This latter method is now employed for the industrial-scale production of nisin preparations. A nisin-producing LAB is grown in milk whey at optimal temperature. During the course of incubation, nisin is expelled into the substrate. At a sufficiently high level, the substrate is pasteurized, which kills the bacteria but does not affect the heat-stable nisin.

A suitable application system for natural antimicrobials of microbial origin was recently developed for the control of *L. monocytogenes* on minimally processed vegetables [9,10]. This study set out with the concept that for a suitable protective culture to grow well and produce sufficient amounts of the bacteriocin, it should be well adapted to the ecosystem it is used in and therefore might best be obtained from the food product considered. LAB occur on most, if not all, minimally processed vegetables, although they generally account for only about 1% of the natural microflora. To identify bacteriocin-producing LAB, 890 LAB isolates were obtained from different fresh and modified-atmosphere-stored vegetables and screened for their ability to produce bacteriocins [9,10]. Only nine isolates were found that could adequately control *L. monocytogenes* on artificial growth media. Three isolates were found to have the required characteristics: one strain of *Enterococcus mundtii* and two strains of *Pediococcus parvulus*. Both types produced a bacteriocin that effectively controlled growth of *L. monocytogenes* in *in vitro* studies [9,10]. Both pediococci, however, only produced significant amounts of bacteriocin at temperatures over 15°C and were not really suited for any application at lower temperature. The bacteriocin produced by both strains was fully identified and characterized and appeared to be identical to pediocin PA-1, formerly only known to be produced by *Pediococcus acidilactici* [9]. *E. mundtii* produced significant amounts of a bacteriocin even at 4°C–10°C [11]. Thus, although it is not a LAB and does not have GRAS status, the organism is very suitable to test whether biopreservation can be the required safety hurdle for certain psychrotrophic pathogens. On laboratory media (sterile vegetable extract in agar), the application of the mundtician producer as a protective culture at 8°C was very promising (Figure 10.4a). However, on fresh, nonsterile produce, no activity was found. Either the production of mundtician on produce at low temperature is not sufficient or the mundtician is inactivated after production (enzymatic inactivation, adsorption to produce). Since the application of partially purified bacteriocin was found to significantly delay the growth of *L. monocytogenes*, the inactivation may not be the most prominent problem.



**FIGURE 10.4** (a) Growth of *L. monocytogenes* (1:1 mix of strain LDCD681 and strain LDCD1087) on vegetable agar medium in the absence of *E. mundtii* (■), cocultured with the bacteriocinogenic *E. mundtii* (●), or cocultured with the non-bacteriocinogenic *E. mundtii* DSM3848 (○), using initial *E. mundtii* levels of  $10^6$  CFU/cm<sup>2</sup>. Incubations were performed at 8°C under a constant flow of 1.5% O<sub>2</sub> and 20% CO<sub>2</sub>, balanced with N<sub>2</sub>. (b) Growth of *L. monocytogenes* on mungbean spouts after treatment with purified bacteriocin of *E. mundtii*. The product was dipped in sterile water (■), dipped in sterile water containing 200 BU/mL of mundtician (○), or coated with an alginate film containing 200 BU/mL mundtician (●). Again, incubations were performed under 1.5% O<sub>2</sub>/20% CO<sub>2</sub>/78.5% N<sub>2</sub> at 8°C. (Modified from M. H. J. Bennik et al., *Let. Appl. Microbiol.*, 28:226, 1999.)

Although the direct application of *E. mundtii* on mungbean sprouts was not effective in reducing the initial viable count of *L. monocytogenes* or its growth potential, a decline of 2 log units in the initial numbers was achieved when the produce was dipped in a solution of mundticin prior to contamination with the pathogen (Figure 10.4b). Identical results were obtained when the product was treated with a mundticin-containing alginate film. The increase of the viable count of the pathogen after 5 days may, again, be attributed to proteolytic degradation and growth of part of the *Listeria* population that was not affected by the intact mundticin. It is worth noting that the counts of the pathogen did not exceed the initial inoculation level for approximately 8 days. Thus, use of food-approved bacteriocins as a dipping solution or as part of an edible coating may have good potential as a biopreservative treatment for minimally processed vegetables.

---

## 10.5 Legislative Aspects

Existing food legislation in most countries would not favor the use of natural compounds purified from their natural source, unless these compounds have genuinely acquired GRAS status. The purification process would bring green chemicals into the same category as synthetic chemical compounds, thus significantly lengthening the procedure for marketing approval and hampering economic implementation in practice. In fact, in most cases the legislative viewpoint on green chemicals or biopreservatives may be that they are new food additives or are applied for new purposes and consequently would require a nontoxicity record, despite their possible GRAS status. A more favorable form of application would thus be the inclusion of the spice or herb that contains the desired active ingredient or of the bacteriocin-producing strain in the food preparation because this still may be regarded as the most natural type of source.

The current regulatory status of bacteriocins and bacteriocin-producing organisms is a clear example of the current controversy between the use of the active compound and the natural source as a whole. In 1969, a joint FAO–WHO expert committee accepted nisin as a legal food additive, although it was not until 1988 that it was approved by the U.S. FDA for use in certain pasteurized cheese spreads. Presently, nisin is permitted in at least 50 countries for the inhibition of clostridia in cheese and canned foods. None of the other bacteriocins known till date has a fully approved legal status as a food additive, although the application of a pediocin-producing strain of *P. acidilactici* has also been approved by the USDA for use in reduced nitrite bacon to aid in the prevention of botulinum toxin production by outgrowth of *C. botulinum* spores. The regulation of bacteriocin preparations from LAB stands in sharp contrast to the common use of these organisms as starter cultures. Moreover, LAB are commonly consumed in high numbers in fermented or cultured products and are often present as indigenous contaminants in many retail products. The general conception would be that the introduction of bacteriocins in foods at levels analogous to those capable of being produced by starter cultures should be as safe as the consumption of the cultured products themselves.

---

## 10.6 Future Outlook

Food preservation by natural means has become a major challenge for food-manufacturing industries of all sizes and is dictated by the changes in consumer attitude in recent years toward chemical preservatives. All foods can be processed to extremes using physical methods that render them sterile and thus microbiologically safe. However, such foods would be unmarketable because consumers favor foods that are “natural” and “as-good-as-fresh” because they associate such products with a healthy diet. Current research trends in food microbiology and food technology focus on mild physical preservation techniques and the use of natural antimicrobial compounds.

Food preservatives of natural origin are generally considered as potential, safe sources of antimicrobials, but their effective use in practice has been established in only a few cases. Any antimicrobial extract or purified compound from a natural source will have to undergo tough toxicological scrutiny whenever its safe use is not guaranteed by well-documented data. Toxicological data for natural antimicrobials are often lacking and are as expensive to assemble as data for chemical compounds. The economy of changing from the range of still available synthetic chemicals to green chemicals will dictate

whether commercialization is feasible at all. In many countries, legislation has been passed to achieve significant reductions—in some cases even a total elimination—of chemical preservatives within the next decade. As may follow from the data briefly reviewed in this chapter, R&D institutions and food industries have identified a good number of possibilities of natural antimicrobials for future food preservation. However, successful marketing relies heavily on proper communication between industries, governments, and consumers. Negotiating marketing with legislative bodies up to now has been mainly on a national level, which poses a major stumbling block to the introduction of natural alternatives. The cost for industries of obtaining legislative approval for marketing is relatively high and to date has not specifically encouraged the search for natural alternatives. This increase in legislative pressure toward nonchemical strategies may favor their economic odds, but it could be even more helpful if the procedures of approval were accelerated on a worldwide scale in favor of natural antimicrobial compounds.

---

## References

1. T. Abee, L. Krockel, and C. Hill, Bacteriocins, modes of action and potentials in food preservation and control of food poisoning, *Int. J. Food Microbiol.* 28:169 (1995).
2. S. E. Aktug and M. Karapinar, Inhibition of foodborne pathogens by thymol, eugenol, menthol and anethole, *Int. J. Food Microbiol.* 4:161 (1987).
3. I. Andersen, Bioprotective culture for fresh sausages, *Fleischwirtschaft* 77:635 (1997).
4. W. Anderson, Compositions having antibacterial properties and use of such compositions in suppressing growth of micro-organisms, European Patent 0466244A1 (1992).
5. A. Arnoldi and L. Merlini, Lipophilicity-antifungal activity relationships for some isoflavonoid phytoalexins, *J. Agr. Food Chem.* 38:834 (1990).
6. M. A. Azzouz and L. B. Bullerman, Comparative antimycotic effects of selected herbs, spice plant components and commercial antifungal agents, *J. Food Prot.* 45:1298 (1982).
7. C. J. Baker, E. W. Orlandi, and N. M. Mock, Harpin, an elicitor of the hypersensitive response in tobacco caused by *Erwinia amylovora*, elicits active oxygen production in suspension cells, *Plant Physiol.* 102:1341 (1993).
8. J. G. Banks, R. G. Board, and N. H. C. Sparks, Natural antimicrobial systems and their potential in food preservation of the future, *Biotechnol. Appl. Biochem.* 8:103 (1986).
9. M. H. J. Bennis, E. J. Smid, and L. G. M. Gorris, Vegetable associated *Pediococcus parvulus* produces pediocin PA-1, *Appl. Environ. Microbiol.* 63:2074 (1997).
10. M. H. J. Bennis, W. Van Overbeek, E. J. Smid, and L. G. M. Gorris, Biopreservation in modified atmosphere stored mungbean sprouts: the use of vegetable-associated bacteriocinogenic lactic acid bacteria to control the growth of *Listeria monocytogenes*, *Lett. Appl. Microbiol.* 28:226 (1999).
11. M. H. J. Bennis, A. Verheul, T. Abee, G. Naaktgeboren-Stoffels, L. G. M. Gorris, and E. J. Smid, Interaction of nisin and pediocin PA-1 with closely related lactic acid bacteria that manifest over 100-fold differences in bacteriocin sensitivity, *Appl. Environ. Microbiol.* 63:3628 (1997).
12. E. D. Berry, R. W. Hutkins, and R. W. Mandigo, The use of a bacteriocin-producing *Pediococcus acidilactici* to control postprocessing *Listeria monocytogenes* contamination of frankfurters, *J. Food Prot.* 54:681 (1991).
13. L. R. Beuchat, Antimicrobial properties of spices and their essential oils, In *Natural Antimicrobial Systems and Food Preservation* (V. M. Dillon and R. G. Board, Eds.), CAB International, Wallingford (1994) p. 167.
14. P. Blackburn, J. Polak, S. A. Gusik, and S. Rubino, Nisin composition for use as enhanced, broad range bactericides, U.S. Patent WO 89/1239 (1989).
15. P. Blackburn, J. Polak, S. A. Gusik, and S. Rubino, Novel bacteriocin compositions for use as enhanced broad range bactericides and methods of prevention and treating microbial infection, U.S. Patent WO 90/09739 (1990).
16. H. Bohlmann and K. Apel, Thionins, *Ann. Rev. Plant Physiol. Plant Mol. Biol.* 42:227 (1991).
17. D. J. Bowles, Defense-related proteins in higher plants, *Ann. Rev. Biochem.* 59:873 (1990).
18. F. Breidt, K. A. Crowley, and H. P. Fleming, Controlling cabbage fermentations with nisin and nisin-resistant *Leuconostoc mesenteroides*, *Food Microbiol.* 12:109 (1995).
19. S. Buncic, S. M. Avery, and S. M. Moorhead, Insufficient antilisterial capacity of low inoculum *Lactobacillus* cultures on long term stored meats at 4°C, *Int. J. Food Microbiol.* 34:157 (1997).

20. D. R. L. Caccioni and M. Guizzardi, Inhibition of germination and growth of fruit and vegetable postharvest pathogenic fungi by essential oil components, *J. Essential Oil Res.* 6:173 (1994).
21. V. Carolissen-Mackay, G. Arendse, and J. W. Hastings, Purification of bacteriocins of lactic acid bacteria: problems and pointers, *Int. J. Food Microbiol.* 34:1 (1997).
22. G. Cerny, Einsatz von Schutzkulturen zur Minderung des Hygienerisikos bei Lebensmitteln, *Lebensmitteltechnik* 23:448–450 (1991).
23. G. Cerny and W. Hennlich, Minderung des Hygienerisikos bei Feinkostsalaten durch Schutzkulturen. Teil II: Kartoffelsalat, *Int. Z. Lebensm. Technol. Verfahrenstech. (ZFL)* 42:1–2, 12 (1991).
24. H. G. Cutler, Natural product flavour compounds as potential antimicrobials, insecticides, and medicinals, *Agro-Food-Industry-Hi-Tech.* 6:19 (1995).
25. M. A. Daeschel, Applications of bacteriocins in food systems, In *Biotechnology and Food Safety* (D. D. Bills and S. D. Kung, Eds.), Butterworth-Heinemann, Boston (1990) p. 91.
26. A. G. Darvill and P. Albersheim, Phytoalexins and their elicitors: a defence against microbial infection in plants, *Ann. Rev. Plant Physiol.* 35:243 (1984).
27. S. G. Deans and G. Ritchie, Antibacterial properties of plant essential oils, *Int. J. Food Microbiol.* 5:165 (1987).
28. S. G. Deans and K. P. Svoboda, Biotechnology and bioactivity of culinary and medicinal plants, *AgBiotechnol. News Inform.* 2:211 (1990).
29. A. J. Degan, A. E. Yousef, and J. B. Luchansky, Use of *Pediococcus acidilactici* to control *Listeria monocytogenes* in temperature-abused vacuum-packaged wieners, *J. Food Prot.* 55:98 (1992).
30. J. Delves-Broughton, P. Blackburn, R. J. Evans, and J. Hugenholtz, Applications of the bacteriocin nisin, *Antonie van Leeuwenhoek* 69:193 (1996).
31. J. Delves-Broughton and M. J. Gasson, Nisin, In *Natural Antimicrobial Systems and Food Preservation* (V. M. Dillon and R. G. Board, Eds.), CAB International, Wallingford (1994) p. 99.
32. R. A. Dixon, P. M. Dey, and C. J. Lamb, Phytoalexins: enzymology and molecular biology, *Adv. Enzymol.* 55:1 (1983).
33. H. Dornenburg and D. Knorr, Elicitation of chitinases and anthraquinones in *Morinda citrifolia* cell cultures, *Food Biotechnol.* 8(1):57 (1994).
34. H. Dornenburg and D. Knorr, Generation of colors and flavors in plant cell and tissue cultures, *Crit. Rev. Plant Sci.* 15(2):141 (1996).
35. M. Drdak, A. Rajniakova, and V. Buchtova, Mustard phytoncides utilization in the process of food preservation, bioavailability '93, nutritional, chemical and food processing implications of nutrient availability, *Fed. Eur. Chem. Soc.:*457 (1993).
36. H. Einarsson and H. Lauzon, Biopreservation of brined shrimp (*Pandalus boreatis*) by bacteriocins from lactic acid bacteria, *Appl. Environ. Microbiol.* 61:669 (1995).
37. R. S. Farag, Z. Y. Daw, F. M. Hewedi, and G. S. A. El-Baroty, Antimicrobial activity of some Egyptian spice essential oils, *J. Food Prot.* 52:665 (1989).
38. R. Geisen and W. H. Holzapfel, Genetically modified starter and protective cultures, *Int. J. Food Microbiol.* 30:315 (1996).
39. J. Giese, K. T. Chung, and C. A. Murdock, Natural systems for preventing contamination and growth of microorganisms in foods, *Food Technol.* 10:361 (1991).
40. G. Giraffa, Lactic and no-lactic acid bacteria as a tool for improving the safety of dairy products, *Ind. Aliment.* 35:244–248, 252 (1996).
41. G. Giraffa, N. Picchioni, E. Neviani, and D. Carminati, Production and stability of an *Enterococcus faecium* bacteriocin during taleggio cheesemaking and ripening, *Food Microbiol.* 12:301 (1995).
42. L. G. M. Gorris and M. H. J. Bennis, Bacteriocins for food preservation, *Int. Z. Lebensm. Technol. Verfahrenstech. (ZFL)* 45(11):65 (1994).
43. G. W. Gould, Industry perspectives on the use of natural antimicrobials and inhibitors for food applications, *J. Food Prot.* 59(suppl.):82–86 (1996).
44. R. J. Grayer and J. B. Harborne, A survey of antifungal compounds from higher plant, 1982–1993, *Phytochemistry* 37:19 (1994).
45. M. B. Hanlin, N. Kachayanand, P. Ray, and B. Ray, Bacteriocins of lactic acid bacteria in combination have greater antibacterial activity, *J. Food Prot.* 56:252 (1993).
46. J. B. Harborne, The role of phytoalexins in natural plant resistance, In *Natural Resistance of Plants to Pests* (M. B. Green and P. A. Hedin, Eds.), American Chemical Society, Washington, DC (1986) p. 22.

47. L. L. Hargreaves, B. Jarvis, A. P. Rawlinson, and J. M. Wood, *The Antimicrobial Effects of Spices, Herbs and Extracts from These and Other Food Plants*, The British Food Manufacturing Industries Research Association, Scientific and Technical Surveys no. 88, 1975.
48. L. J. Harris, H. P. Fleming, and T. R. Klaenhammer, Developments in nisin research, *Food Res. Int.* 25:57 (1992).
49. L. J. Harris, H. P. Fleming, and T. R. Klaenhammer, Novel paired starter culture system for sauerkraut, consisting of a nisin-resistant *Leuconostoc mesenteroides* strain and a nisin-producing *Lactococcus lactis* strain, *Appl. Environ. Microbiol.* 58:1484 (1992).
50. K. J. Hartmans, P. Diepenhorst, W. Bakker, and L. G. M. Gorris, The use of carvone in agriculture: sprout suppression of potatoes and antifungal activity against potato tuber and other plant diseases, *Ind. Crops Prod.* 4:3 (1995).
51. S. Y. He, H. C. Huang, and A. Collmer, *Pseudomonas syringae* pv *syringae* harpin (PSS)—a protein that is secreted via the HRP pathway and elicits the hypersensitive response in plants, *Cell* 73:1255 (1993).
52. I. M. Helander, A. Von Wright, and T. M. Matilla-Sandholm, Potential of lactic acid bacteria and novel antimicrobials against Gram-negative bacteria, *Trends Food Sci. Technol.* 8:146 (1997).
53. W. Hennlich, Sicherer Hygieneschutz. Leistungsanforderungen an Schutzkulturen in Feinkostsalaten. Teil 1, *Lebensmitteltechnik* 27(4):51 (1996).
54. W. Hennlich and G. Cerny, Minderung des Hygienrisikos bei Feinkostsalaten durch Schutzkulturen. Teil I: Fleischsalat, *Int. Z. Lebensm. Technol. Verfahrenstech. (ZFL)* 41:806 (1990).
55. W. H. Holzapfel, R. Geisen, and U. Schillinger, Biological preservation of foods with reference to protective cultures, bacteriocins and food-grade enzymes, *Int. J. Food Microbiol.* 24:343 (1995).
56. H. H. Huss, V. F. Jeppesen, C. Johansen, and L. Gram, Biopreservation of fish products—a review of recent approaches and results, *J. Aquatic Food Prod. Technol.* 4:5, 37 (1995).
57. M. T. Hutton, P. A. Chehak, and J. H. Hanlin, Inhibition of botulinum toxin production by *Pediococcus acidilactici* in temperature abused refrigerated foods, *J. Food Safety* 11:255 (1991).
58. J. L. Ingham, Disease resistance in plants: the concept of pre-infectious and post-infectious resistance, *Phytopathol. Z.* 78:314 (1973).
59. P. M. Jenner, E. C. Hagan, J. M. Taylor, E. L. Cook, and O. G. Fitzhugh, Food flavourings and compounds of related structure. I. Acute oral toxicity, *Food Cosmet. Toxicol.* 2:327 (1964).
60. J. J. Kabara and T. Eklund, Organic acids and esters, In *Food Preservatives* (N. J. Russel and G. W. Gould, Eds.), Blackie Academic, London (1991) p. 200.
61. W. J. Kim, Bacteriocins of lactic acid bacteria—their potentials as food biopreservative, *Food Rev. Int.* 8:299 (1993).
62. M. Kivanc and A. Akgul, Mould growth on black table olives and prevention by sorbic acid, methyl-eugenol and spice essential oil, *Nahrung* 34:369 (1990).
63. H. Knauf, Starterkulturen fuer die Herstellung von Rohwurst und Rohpoekelwaren: Potential, Auswahlkriterien und Beeinflussungsmoeglichkeiten, *Fleischerei* 46:4,6,8 (1995).
64. P. Kotzekidou and J. G. Bloukas, Effect of protective cultures and packaging film permeability on shelf life of slice vacuum packed cook ham, *Meat Sci.* 42:333 (1996).
65. L. Kroeckel and U. Schmidt, Hemmung von *Listeria monocytogenes* in vakuum-verpacktem Bruehwurstaufschnitt durch bacteriocinogene Schutzkulturen, *Mitteilungsbl. Bundesanst. Fleischforsch.* 33:428 (1994).
66. L. Leistner and L. G. M. Gorris, Food preservation by hurdle technology, *Trends Food Sci. Technol.* 6(1):41 (1995).
67. J. Luchansky, Genomic analysis of *Pediococcus* starter cultures used to control *Listeria monocytogenes* in turkey summer sausage, *Appl. Environ. Microbiol.* 58:3053 (1992).
68. B. M. Lund and G. D. Lyon, Detection of inhibitors of *Erwinia carotovora* and *E. herbicola* on thin-layer chromatograms, *J. Chromatogr.* 110:193 (1975).
69. G. D. Lyon, Attenuation by divalent cations of the effect of the phytoalexin rishitin on *Erwinia carotovora* var. *atroseptica*, *J. Gen. Microbiol.* 109:5 (1978).
70. A. L. E. Mahmoud, Antifungal action and antiaflatoxic properties of some essential oil constituents, *Lett. Appl. Microbiol.* 19:110 (1994).
71. N. Nakatani, Antioxidative and antimicrobial constituents of herbs and spices, In *Spices, Herbs and Edible Fungi* (G. Charalambous, Ed.), Elsevier Science, Amsterdam, 1994, p. 251.
72. G. J. E. Nychas, Natural antimicrobials from plants, In *New Methods of Food Preservation* (G. W. Gould, Ed.), Blackie Academic, London, 1995, p. 58.

73. K. Oosterhaven, B. Poolman, and E. J. Smid, S-carvone as a natural potato sprout inhibiting, fungistatic and bacteriostatic compound, *Ind. Crops Prod.* 4:23 (1995).
74. N. Paster, B. J. Juven, and H. Harshemesh, Antimicrobial activity and inhibition of aflatoxin B1 formation by olive plant tissue constituents, *J. Appl. Bacteriol.* 64:293 (1988).
75. A. Pauli and K. Knobloch, Inhibitory effects of essential oil components on growth of food-contaminating fungi, *Z. Lebensm. Unters. Forsch.* 184:10 (1987).
76. B. Ray and M. A. Daeschel, Bacteriocins of starter culture bacteria, In *Natural Antimicrobial Systems and Food Preservation* (V. M. Dillon and R. G. Board, Eds.), CAB International, Wallingford, 1994, p. 99.
77. K. E. Ricker and R. M. Bostock, Evidence for release of the elicitor arachidonic acid and its metabolites from sporangia of *Phytophthora infestans* during infection of potato, *Physiol. Mol. Plant Pathol.* 41:61 (1992).
78. W. K. Roberts and C. P. Selitrechnikoff, Plant and bacterial chitinases differ in antifungal activity, *J. Gen. Microbiol.* 134:169 (1988).
79. A. Roco, P. Castaneda, and L. M. Perez, Oligosaccharides released by pectinase treatment of citrus limon seedlings are elicitors of the plant response, *Phytochemistry* 33:1301 (1993).
80. S. Roller, The quest for natural antimicrobials as novel means of food preservation, *Int. Biodeterior. Biodegrad.* 36:333 (1995).
81. M. Rozbeh, N. Kalchayanand, R. A. Field, M. C. Johnson, and B. Ray, The influence of biopreservatives on the bacterial level of refrigerated vacuum packaged beef, *J. Food Safety* 13:99 (1993).
82. J. L. Ruiz-Barba, D. P. Cathcart, P. L. Warner, and R. Jimenez-Diaz, Use of *Lactobacillus plantarum* LPCO10, a bacteriocin producer, as a starter culture in spanish-style green olive fermentations, *Appl. Environ. Microbiol.* 60:2059 (1994).
83. J. Salmeron, R. Jordano, and R. Pozo, Antimycotic and antiaflatoxic activity of oregano (*Origanum vulgare* L.) and thyme (*Thymus vulgaris* L.), *J. Food Prot.* 53:697 (1990).
84. U. Schillinger, Bacteriocins of lactic acid bacteria, In *Biotechnology and Food Safety* (D. D. Bills and S. D. Kung Eds.), Butterworth-Heinemann, Boston (1990) p. 54.
85. U. Schillinger, R. Geisen, and W. H. Holzapfel, Potential of antagonistic microorganisms and bacteriocins for the biological preservation of foods, *Trends Food Sci. Technol.* 7:158 (1996).
86. U. Schillinger, M. Kaya, and F. K. Luecke, Behaviour of *Listeria monocytogenes* in meat and its control by a bacteriocin-producing strain of *Lactobacillus sake*, *Appl. Bacteriol.* 70:473 (1991).
87. U. Schillinger and F. K. Luecke, Lactic acid bacteria as protective cultures in meat products, *Fleischwirtschaft* 70:1296 (1990).
88. A. Schlumbaum, F. Mauch, U. Vögeli, and T. Boller, Plant chitinases are potent inhibitors of fungal growth, *Nature* 324:365 (1986).
89. J. Sikkema, J. A. M. De Bont, and B. Poolman, Interactions of cyclic hydrocarbons with biological membranes, *J. Biol. Chem.* 269:8022 (1994).
90. J. Sikkema, J. A. M. De Bont, and B. Poolman, Mechanisms of membrane toxicity of hydrocarbons, *Microbiol. Rev.* 59:201 (1995).
91. J. Sikkema, B. Poolman, W. N. Konings, and J. A. M. De Bont, Effects of the membrane action of tetralin on the functional and structural properties of artificial and bacterial membranes, *J. Bacteriol.* 174:2986 (1992).
92. S. A. Simon, W. L. Stone, and P. B. Bennett, Can regular solution theory be applied to lipid bilayer membranes? *Biochim. Biophys. Acta* 550:38 (1979).
93. E. J. Smid, Y. De Witte, and L. G. M. Gorris, Secondary plant metabolites as control agents of postharvest *Penicillium* rot on tulip bulbs, *Postharvest Biol. Technol.* 6:303 (1995).
94. E. J. Smid, L. Hendriks, H. A. M. Boerrigter, and L. G. M. Gorris, Surface disinfection of tomatoes using the natural plant compound *trans*-cinnamaldehyde, *Postharvest Biol. Technol.* 9:343 (1996).
95. E. J. Smid, J. P. G. Koeken, and L. G. M. Gorris, Fungicidal and fungistatic action of the secondary plant metabolites cinnamaldehyde and carvone, In *Modern Fungicides and Antifungal Compounds* (H. Lyr, P. E. Russell, and H. D. Sisler, Eds.), Intercept Ltd., Andover, Hants (1996) p. 173.
96. D. A. Smith and S. W. Banks, Biosynthesis, elicitation and biological activity of isoflavonoid phytoalexins, *Phytochemistry* 25:979 (1986).
97. M. L. Stecchini, V. Aquili, and I. Sarais, Behavior of *Listeria monocytogenes* in mozzarella cheese in presence of *Lactococcus lactis*, *Int. J. Food Microbiol.* 25:301 (1995).
98. K. A. Stevens, B. W. Sheldon, N. A. Klapes, and T. R. Klaenhammer, Nisin treatment for inactivation of *Salmonella* species and other Gram-negative bacteria, *Appl. Environ. Microbiol.* 58:3613 (1991).



99. M. E. Stiles, Biopreservation by lactic acid bacteria, *Antonie van Leeuwenhoek* 70:331 (1996).
100. A. Stintzi, T. Heitz, V. Prasad, S. Wiedemann-Merdinoglu, S. Kauffmann, P. Geoffroy, M. Legrand, and B. Fritig, Plant pathogenesis-related proteins and their role in defense against pathogens, *Biochimie* 75:687 (1993).
101. C. C. Tassou and G. J. E. Nychas, Antimicrobial activity of the essential oil of mastic gum (*Pistacia lentiscus* var. *chia*) on Gram positive and Gram negative bacteria in broth and in model food system, *Int. Biodeterior. Biodegrad.* 36:411 (1995).
102. H. D. Van Etten, Antifungal activity of pterocarpan and other selected isoflavonoids, *Phytochemistry* 15:655 (1976).
103. E. E. Vaughan, E. Caplice, R. Looney, N. O'Rourke, H. Coveney, C. Daly, and G. F. Fitzgerald, Isolation from food sources, of lactic acid bacteria that produced antimicrobials, *J. Appl. Bacteriol.* 76:118 (1994).
104. M. Vescovo, C. Orsi, G. Scolari, and S. Torriani, Inhibitory effect of selected lactic acid bacteria on microflora associated with ready-to-use vegetables, *Lett. Appl. Microbiol.* 21:121 (1995).
105. A. J. Vigers, W. K. Roberts, and C. P. Selitrennikoff, A new family of plant antifungal proteins, *Mol. Plant-Microbe Interact.* 4:315 (1991).
106. J. R. L. Walker, Antimicrobial compounds in food plants, In *Natural Antimicrobial Systems and Food Preservation* (V. M. Dillon and R. G. Board, Eds.), CAB International, Wallingford, 1994, p. 181.
107. H. M. Ward, Recent researches on parasitism of fungi, *Ann. Bot.* 19:1 (1905).
108. H. Weber, Dry sausage manufacture. The importance of protective cultures and their metabolic products, *Fleischwirtschaft* 74:278 (1994).
109. Z. M. Wei, R. J. Laby, C. H. Zumoff, D. W. Bauer, S. Y. He, A. Collmer, and S. V. Beer, Harpin elicitor of the hypersensitive response produced by the plant pathogen, *Erwinia amylovora*, *Science* 257:85 (1992).
110. M. Weidenbörner and H. C. Jha, Antifungal activity of flavonoids and their mixtures against different fungi occurring on grain, *Pesticide Sci.* 38:347 (1993).
111. S. Wessels and H. H. Huss, Suitability of *Lactococcus lactis* subsp. *lactis* ATCC 11454 as a protective culture for lightly preserved fish products, *Food Microbiol.* 13:323 (1996).
112. K. M. Wilkins and R. G. Board, Natural antimicrobial systems, In *Mechanisms of Action of Food Preservation Procedures* (G. W. Gould, Ed.), Elsevier Applied Science, London, 1989, p. 285.
113. C. A. Williams and J. B. Harborne, Isoflavonoids, In *Methods in Plant Biochemistry Vol. I. Plant Phenolics* (J. B. Harborne, Ed.), Academic Press, London (1989) p. 421.
114. L. Wimmer, Natuerliche Haltbarkeit, *Fleischerei* 47:12 (1996).
115. E. A. Zottola, T. L. Yezzi, D. B. Ajao, and R. F. Roberts, Utilization of cheddar cheese containing nisin as an antimicrobial agent in other foods, *Int. J. Food Microbiol.* 24:227 (1994).

# 11

## *Antioxidants in Food Preservation*

Jan Pokorny

### CONTENTS

11.1	Rancidity of Fats, Oils, and Fatty Foods.....	260
11.1.1	Types of Rancidity .....	260
11.1.2	Mechanism of Oxidative Rancidity .....	260
11.1.2.1	Initiation Reactions .....	261
11.1.2.2	Propagation Reactions (Primary Reactions) .....	261
11.1.2.3	Termination Reactions .....	262
11.1.2.4	Metal Catalysis of Peroxidation of Polyunsaturated Lipids .....	262
11.1.2.5	Enzymic Lipid Oxidation .....	262
11.1.2.6	Secondary Reactions .....	262
11.1.3	Measurement of Oxidative Rancidity .....	262
11.1.3.1	Sensory Methods.....	262
11.1.3.2	Chemical Methods .....	262
11.1.3.3	Chromatographic Methods .....	263
11.1.4	Nutritional and Sensory Aspects of Oxidative Rancidity .....	263
11.1.4.1	Effects on Nutritional Value .....	263
11.1.4.2	Effects on Sensory Value .....	263
11.1.5	Influence of Rancidity in Foods .....	263
11.1.6	Sources of Food Oxidants .....	263
11.2	Reduction and Control of Rancidity in Foods .....	264
11.2.1	Why Antioxidants Are Necessary .....	264
11.2.2	Definitions of Antioxidants and Antioxidant Types .....	264
11.2.3	Antioxidants in the Diet and Their Protective Effect against Diseases.....	265
11.2.3.1	Cardiovascular Diseases .....	265
11.2.3.2	Cancer .....	266
11.2.3.3	Aging.....	266
11.2.4	Antioxidants and the Mechanism of Their Action .....	266
11.2.4.1	Mechanism of Action of Antioxidants .....	266
11.2.4.2	Chemical Structures of the Most Important Antioxidants .....	267
11.3	Application of Antioxidants in Foods .....	276
11.3.1	Stabilization of Fats and Oils.....	276
11.3.2	Applications of Antioxidants in Fat Emulsions.....	276
11.3.3	Applications of Antioxidants in Foods .....	277
11.3.4	Applications of Antioxidants in Packaging .....	277
11.3.5	Legally Permitted Levels of Antioxidants .....	278
11.4	Analysis of Antioxidants .....	278
11.4.1	Content of Antioxidants .....	278
11.4.1.1	Isolation of Antioxidants from Fats, Oils, and Foods.....	278
11.4.1.2	Determination of Antioxidants Isolated from the Substrate .....	279
11.4.2	Determination of Antioxidant Activity .....	280
11.4.3	Alternative Methods for Stabilization of Foods .....	281
11.5	Future Trends.....	281
	References .....	281

## 11.1 Rancidity of Fats, Oils, and Fatty Foods

Rancidity is an objectionable defect in food quality. Fats, oils, or fatty foods are deemed rancid if a significant deterioration of the sensory quality is perceived (particularly aroma or flavor, but appearance and texture may also be affected, e.g., in fish). Rancidity includes several types of changes, but most often the degradation due to changes in lipid constituents is considered the main feature of rancidification.

### 11.1.1 Types of Rancidity

Several types of rancidity exist in fats, oils, and fatty foods, not always connected with oxidation reactions. The most important types are listed in Table 11.1. Lipolytic rancidity is mainly due to lipases (triacylglycerol-acyl hydrolases, EC 3.1.1.3), which are enzymes catalyzing the cleavage of triacylglycerols (triglycerides) into free fatty acids and partial glycerol esters—monoacylglycerols (monoglycerides), diacylglycerols (diglycerides), and glycerol. In most fats and oils, the presence of free fatty acids is not perceptible to human senses, therefore, not considered as flavor deterioration. Milk fats [1] are an exception, as they contain esters of butyric acid. Free butyric acid, produced by their hydrolysis, imparts a typical disagreeable off-flavor, resembling rancid butter. In oils obtained from seeds of palms (*Palmaceae*), such as coconut or palm kernel oils, caproic, caprylic, and capric acids are released by lipolysis, which results in a soapy off-flavor. Such deterioration is frequently observed in stored food products containing coconut. The soapy flavor is not only due to soap produced from coconut oil, but also due to all derivatives (free fatty acids, methyl or ethyl esters) having a hydrocarbon chain of 6–10 carbon atoms. The lipolytic rancidity cannot be inhibited by antioxidants. Oxidative rancidity, the most important type of food rancidity, is discussed in Section 11.1.2 in more detail. Chapter 10 discusses the inhibition of oxidative rancidity exclusively.

Flavor reversion is a type of rancidity, typical for soybean oil. It is connected with minute absorption of oxygen by oil. It appears during storage of fully refined, bland soybean oils, and imparts a “beany” off-flavor to the product. It results from specific oxidation products, probably originating from particular oxygen-substituted fatty acids (containing a furan group), present in soybean oil. Ketonic rancidity, with a characteristic floral off-flavor, is sometimes observed during the storage of foods containing short- or medium-chain fatty acids (4–10 carbon atoms), such as those containing milk fat or coconut oil [2]. It is caused by microbial degradation of medium-chain fatty acids into the respective alkan-2-ones or methyl ketones (Figure 11.1, Equation 1). The flavor is objectionable in butter, but it is characteristic for blue cheese aroma.

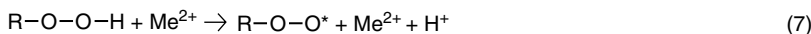
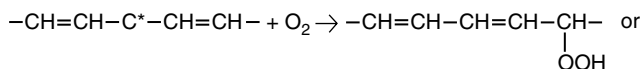
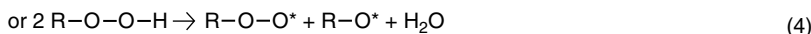
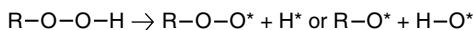
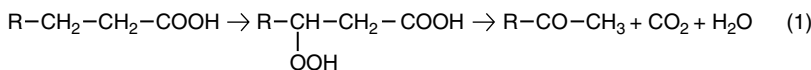
### 11.1.2 Mechanism of Oxidative Rancidity

The sensory perception of rancidity is due to the presence of volatile substances possessing 3–12 carbon atoms; several classes of compounds are active in producing rancidity, such as aldehydes, ketones, alcohols, or even hydrocarbons. Generally, unsaturated derivatives are more sensorically active than the respective

**TABLE 11.1**

Types of Rancidity Occurring in Fats, Oils, and Fatty Acids

Types of Rancidity	Main Substances Producing Rancidity	Types of Chemical Reaction	Materials Subject to the Type of Rancidity
Lipolytic	Low fatty acids, medium-chain fatty acids	Enzymic hydrolysis	Milk fat, palm-seed oils
Oxidative	Lower aldehydes and ketones	Autoxidation, enzymic oxidation	Polyunsaturated edible oils
Flavor reversion	Oxygen-substituted cleavage and rearrangement products	Oxidation, cleavage, and rearrangement	Soybean oil
Ketonic	2-Alkanones (methyl ketones)	$\beta$ -Oxidation and enzymic decarboxylation	Milk fat, palm-seed oils



**FIGURE 11.1** Mechanism of lipid rancidification.

saturated derivatives. The mechanism of their production is not relevant, but usually secondary oxidation products are more active than products formed as a result of other types of reaction [3,4]. Oxidative rancidity (also called autooxidation) is a free radical chain reaction consisting of three main phases: initiation, propagation, and termination [5,6]. During autooxidation, all unsaturated fatty acids bound in lipids are slowly oxidized. Polyunsaturated fatty acids are the least stable components, being easily attacked by air oxygen. At higher temperatures, saturated fatty acids are oxidized as well. The sensitivities of other substances containing a hydrocarbon chain (e.g., higher terpenes, such as carotenoids, sterols; and lower terpenes present in essential oils) are often underestimated in their contribution to the total rancidity.

### 11.1.2.1 Initiation Reactions

During the oxidation of polyenoic (essential) fatty acids, the methylene group adjacent to two double bonds ( $-\text{CH}=\text{CH}-\text{CH}_2-\text{CH}=\text{CH}-$ ), as present in linoleic and linolenic acids, is the primary site of oxygen attack [5]. It is easily converted into the respective free radical:  $\text{R-H} \Rightarrow \text{R}^* + \text{H}^*$ . In monoenoic fatty acids, free radicals are formed by cleavage of a hydrogen atom on either one side of the double bond:  $-\text{CH}_2-\text{CH}=\text{CH}-\text{CH}_2- \Rightarrow -\text{C}^*\text{H}-\text{CH}=\text{CH}-\text{CH}_2-$  or  $-\text{CH}_2-\text{CH}=\text{CH}-\text{C}^*\text{H}-$ , but activation energy of this reaction is higher. Most often, free radicals are formed by cleavage of a hydroperoxide molecule (Figure 11.1, Equation 5). Hydroperoxides are usually present in trace quantities in raw lipid material, where they are produced by singlet oxygen or enzyme-catalyzed oxidation.

### 11.1.2.2 Propagation Reactions (Primary Reactions)

The unsaturated fatty acid radical easily absorbs a molecule of oxygen, forming a peroxy radical (Figure 11.1, Equation 2). The peroxy radical, being very reactive, abstracts a hydrogen atom from another molecule of a polyunsaturated fatty acid, forming a hydroperoxide and an alkyl free radical (Figure 11.1, Equation 3). The hydroperoxide molecule is easily cleaved with formation of a free peroxy or alkoxy radical (Figure 11.1, Equation 4). This reaction sequence can be repeated many times, therefore, it is called a chain reaction. During this reaction, the double-bond system of the original polyunsaturated fatty acid is usually isomerized into a more stable conjugated dienoic system (Figure 11.1, Equation 5).

### 11.1.2.3 Termination Reactions

The chain of the propagation reaction is interrupted by the recombination of two free radicals (Figure 11.1, Equation 6); this last stage of autoxidation is called the termination reaction.

### 11.1.2.4 Metal Catalysis of Peroxidation of Polyunsaturated Lipids

The decomposition of hydroperoxides in autoxidizing lipids is catalyzed [7] by transient-valency metal ions (Figure 11.1, Equation 7). Two free radicals are produced from each hydroperoxide, which initiate further reaction chains. The lower-valency metal ion regenerates by reaction with another molecule of hydroperoxide (Figure 11.1, Equation 8). Therefore, minute traces of copper and iron, to lesser degree manganese and cobalt, are important promoters of oxidation.

### 11.1.2.5 Enzymic Lipid Oxidation

Various enzymes, mainly lipoxygenases (linoleate oxidoreductases, E.C. 1.13.11.12), catalyze the oxidation of linoleic, linolenic, and structurally related essential fatty acids [8]. The products differ from those formed in the course of autoxidation by their stereoselectivity and positional selectivity. Several isoenzymes are usually present [9]. Lipoxygenases are mainly accompanied by the respective lyases, which cleave hydroperoxides into different low molecular weight compounds.

### 11.1.2.6 Secondary Reactions

Hydroperoxides, which are the most important primary reaction products, may decompose, even at room temperature, forming free radicals (Figure 11.1, Equation 4), which initiate a further oxidative reaction chain. Therefore, it is advisable to add substances that will stabilize hydroperoxides in food material. Hydroperoxides of polyunsaturated fatty acids have no particular odor or flavor, but they are easily cleaved at the double bond adjacent to the hydroperoxy group, resulting in the formation of various volatile low molecular weight (3–12 carbon atoms) aldehydes, hydrocarbons, alcohols, or ketones [10]. Only those secondary oxidation products impart the rancid off-flavor to oxidized fats and oils. They are easily oxidized in turn, giving rise to low molecular weight fatty acids and other tertiary reaction products. Lipid polymers, mainly dimers, are produced as well as cleavage products (Figure 11.1, Equation 9), but they do not substantially affect the sensory value. Diperoxides are also formed by secondary oxidation of hydroperoxides, especially in advanced reaction stages of polyunsaturated lipids at sufficient access of oxygen.

## 11.1.3 Measurement of Oxidative Rancidity

Oxidative rancidity is very complex; therefore, a single method is usually not sufficient, and several analytical methods of different reaction products are usually needed to identify and measure the degree of rancidity.

### 11.1.3.1 Sensory Methods

Rancidity is a phenomenon of perception, so that psychometric methods are particularly suitable for its measurement. Therefore, sensory analysis methods are fundamental for analysis [11]. The degree of rancidity is the final goal of analysis, but usually sensory profile methods are used to estimate all flavor descriptors responsible for the final perception of rancidity. Even with expert panels of assessors, the analysis should be repeated 10–20 times to obtain reliable results.

### 11.1.3.2 Chemical Methods

Lipid hydroperoxides, which are the primary reaction products, are easily determined iodometrically, but the peroxide value has no simple relation to the actual rancidity because hydroperoxides are odorless and tasteless [11]. The benzidine or (better) *p*-anisidine value measures the browning reactions of the respective aromatic amines with carbonylic oxidation products; they react with aldehydes or ketones, and the intensity depends not only on the concentration of carbonyl groups, but also on the degree of unsaturation as well as on other factors [12]. The 2-thiobarbituric acid value, determined by measuring the absorbance at 530 nm, is the measure of the condensation products with malonaldehyde or with a hydroperoxide

produced by oxidation of 3-alkenals or 2,4-alkadienals. If the condensation products are measured at 450 nm, the absorbance is correlated with total aldehydic oxidation products, which correlate better with rancidity than the substances reactive with formation of red products [13]. Both these methods are easy, rapid, and cheap; however, their specificity is questionable. Several other spectrophotometric methods were reported in the literature, mostly based on a reaction with aldehydes, e.g., the conversion of aldehydes into 2,4-dinitrophenylhydrazones and the determination of color intensity.

### 11.1.3.3 Chromatographic Methods

The best method for the measurement of rancidity is gas–liquid chromatographic (GLC) analysis of volatiles, isolated by the dynamic headspace analysis or using other analytical techniques [14]. The contents of propane, hexane, hexanal, 2,4-decadienals, and other products are correlated with the degree of rancidity. Nonvolatile products may be determined with reverse-phase high-performance liquid chromatography (HPLC) and polymers either with high-performance size-exclusion chromatography (HPSEC) or high-performance thin layer chromatography (HPTLC–FID).

## 11.1.4 Nutritional and Sensory Aspects of Oxidative Rancidity

### 11.1.4.1 Effects on Nutritional Value

The least resistant components of lipids are essential fatty acids that not only lose their physiological activity by autoxidation, but they may also turn into antinutritive agents when oxidized. Free radicals formed as intermediary products may initiate the development of cardiovascular diseases or cancer *in vivo* (see Section 11.2.3). Lipid hydroperoxides decompose liposoluble vitamins, such as vitamin E, vitamin C, and vitamin A or its provitamins—carotenes [15]. Lipid oxidation products possess direct toxicity as well, cyclic dimers and hydroperoxides of aldehydic oxidation products being particularly toxic. Hydroperoxides and ketones react with primary amine groups of proteins, thus decreasing the biological value [16]. Similarly, they react with amino acids and some vitamins of the B group.

### 11.1.4.2 Effects on Sensory Value

As already stated, rancidity is a process resulting in changes of the sensory value of fats, oils, and other foods. Very minute rancidity is not objectionable to most consumers; on the contrary, it makes the flavor richer and more acceptable. Larger amounts of secondary oxidation products, however, cause negative consumer response that may lead to the rejection of rancid food. Virgin olive oil or fried foods are typical examples of products where minute amounts of oxidation products are desirable but higher amounts are objectionable. Rancidity is a very complex phenomenon, and rancid foods may be described as, for example, old, warmed-over, cardboard, wet dog, or dumpy. Small amounts of oxidation products of polyunsaturated fatty acids impart fried flavor to food [17]. Higher amounts of the same compounds produced the perception of burned flavor.

## 11.1.5 Influence of Rancidity in Foods

Rancidity may be limited by decreasing the storage temperature, the access of oxygen, and the degree of unsaturation of the lipid fraction (see Section 11.1.2.6). When application of the above methods is not possible or satisfactory, the best way to control rancidity is the addition of antioxidants (see below).

## 11.1.6 Sources of Food Oxidants

Fats, oils, and related compounds, which turn rancid on oxidation, are mostly oxidized by air oxygen, which penetrates foods and is dissolved in both aqueous and lipid phases. If the reaction is catalyzed by enzymes, the oxidant is still air oxygen. Other oxidants (Table 11.2) are of minor importance. In the presence of photosensibilizers (such as chlorophylls) and in light, ordinary triplet oxygen is converted into singlet oxygen, which is 100–300 times more reactive [18]. A singlet oxygen molecule is added to a double bond of unsaturated lipids, and the intermediary unstable product is rapidly isomerized into a hydroperoxide. Hydrogen peroxide is easily cleaved, resulting in formation of free radicals, which rapidly oxidize unsaturated fatty acids.

**TABLE 11.2**

Oxidants in Food Products

Oxidant	Importance	Occurrence
Air (triplet) oxygen (autoxidation)	Most important in processed and stored foods	General
Enzymatically catalyzed oxidation	Stored raw materials	Oilseeds, nuts, cereals, legumes
Singlet oxygen	In light and in the presence of photosensitizer	Edible oils, green foods
Ozone	Very low in foods	Essential oils
Quinones	In foods subject to enzymic browning	Fruits, vegetables, potatoes
Metals	Initiation of free radical oxidation	Meat, fruits
Superoxide anion	Mainly in <i>in vivo</i> systems	Meat
Hydrogen peroxide	In presence of ascorbic acid	Fruits, vegetables
Lipid hydroperoxides	In presence of polyunsaturated acids and carotenoids	Fruits, vegetables, fatty foods

## 11.2 Reduction and Control of Rancidity in Foods

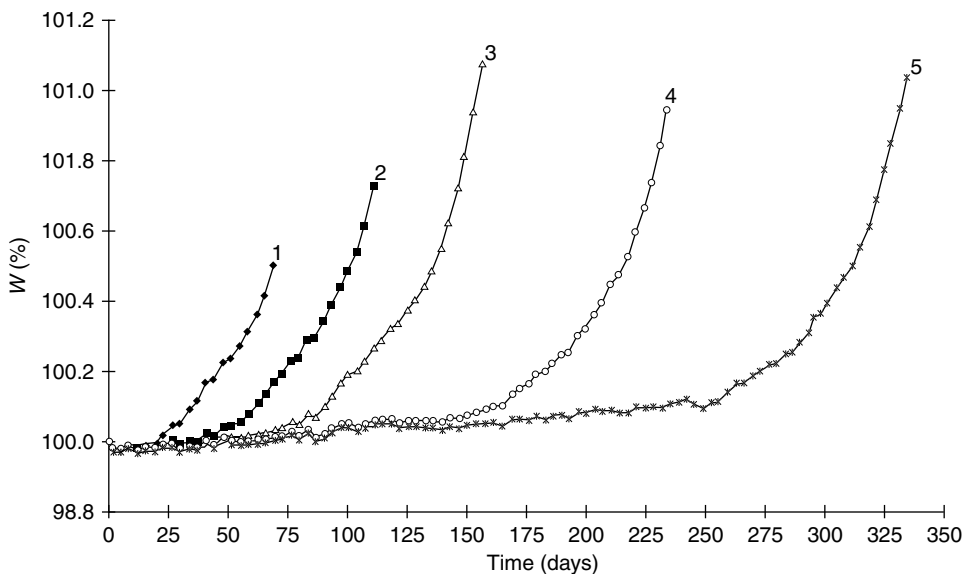
In the preindustrial period, food materials were used for immediate food production, and the products were usually consumed within a few hours or a day. The rancidity of durable products, such as nuts, flour, lard, or olive oil, was considered as normal. The problem of rancidity was less important then than now, when food products are often stored for days or months before their consumption. Therefore, processes deteriorating food during storage are substantially more important.

### 11.2.1 Why Antioxidants Are Necessary

The autoxidation of lipids is initiated by free radicals; hydroperoxides produced by autoxidation are decomposed, producing free radicals, which initiate further oxidation reactions. In the beginning, the concentration of free radicals is very low, and oxidation is slow. Gradually, the concentration of hydroperoxides and other oxidation products increases, the concentration of free radicals formed during their decomposition increases as well, and thus the overall oxidation rate increases exponentially (Figure 11.2). The storage of fat-containing food materials is limited by the period of slow oxidation, where the sensory value is still acceptable. The stage of very slow oxidation in the beginning of storage is called the induction period. The induction period, and thus the shelf life, may be prolonged by addition of antioxidants, which are not able to entirely eliminate the oxidation reactions even when they are active in prolonging the storage time.

### 11.2.2 Definitions of Antioxidants and Antioxidant Types

In a broad sense, antioxidants are all substances that can protect materials (not only foods) against autoxidation, irrespective of the mechanism of action. More exactly, such compounds should be called oxidation inhibitors, and only those substances that inhibit oxidation by reaction with free radicals should be called antioxidants [19]. The free radical scavenging potential is an important method for determination of antioxidant activity. Antioxidant may also inhibit the decomposition of lipid hydroperoxides, which would otherwise form free radicals [20]. The relative effect of oxidative chain breaking on hydroperoxide stabilization may depend on the concentration. In this chapter, the broader sense is applied [21]. The most important types of antioxidants are summarized in Table 11.3. Phenolic antioxidants and their synergists are the most important representatives of these compounds in food applications.



**FIGURE 11.2** Course of oxidation reaction during storage of stabilized rapeseed oil under conditions of the Schaal oven test at 40°C. W, weight increase; Time, storage time; 1, control (without antioxidants), oil with hexane rosemary extract; 2, 0.01% extract; 3, 0.02% extract; 4, 0.05% extracts; 5, 0.10% extract.

**TABLE 11.3**

Types of Oxidation Inhibitors (Antioxidants)

Group of Compounds	Mechanism of Action	Example of Inhibitor
Antioxidants	Reaction with free radicals	Propyl gallate, tocopherols
Hydroperoxide deactivators	Reaction with hydroperoxides	Cysteine, selenometathione
Synergists	Regeneration of an antioxidant	Ascorbyl palmitate
Singlet oxygen quenchers	Transformation of singlet oxygen into triplet oxygen	Carotenes
Chelating agent	Binding heavy metals into inactive complexes	Polyphosphates, citric acid

### 11.2.3 Antioxidants in the Diet and Their Protective Effect against Diseases

Until recently, humans consumed a diet low in polyunsaturated fats, while large amounts of various phenolic substances were regularly consumed. The free radical content of such a diet *in vivo* is low. In the last few decades, the consumption of polyunsaturated fats, especially edible oils, has increased several times, mainly as the prevention against some cardiovascular diseases. Polyunsaturated fatty acids are easily oxidized *in vivo* resulting in formation of free radicals [22]. Therefore, the application of antioxidants in the human diet for the suppression of free radicals is very important [23] in the prevention of several chronic diseases [24], common in affluent countries [25].

#### 11.2.3.1 Cardiovascular Diseases

Numerous papers and reviews have been published on antioxidants and cardiovascular diseases [22]. Free radicals produced by lipid oxidation damage the walls of blood vessels and lipoproteins and other particles circulating in the blood. They are bound firmly into serum lipoproteins, forming physically and covalently bound products. Such modified lipoproteins are attacked by leukocytes as foreign bodies. They absorb those lipoproteins, forming sponge cells. These cells are deposited, preferentially in places on cell walls, damaged by free radicals. The atherosclerotic plaques produced in this way are the cause of atherosclerosis.



Atherosclerosis is a very dangerous disease frequently found in developed societies with relatively large older populations. Therefore, the prevention of atherosclerosis has become very important. The best way of preventing cardiovascular disease is to increase the concentration of antioxidants in the blood to keep the concentration of free radicals at low levels. This is most easily achieved by increasing the antioxidant intake in the diet. Free radicals present in blood are both lipophilic (lipid peroxy radicals) and hydrophilic (produced by decomposition of hydrogen peroxide, superoxide anion, or other active forms of oxygen); therefore, the best way to enrich foods is by adding both lipophilic (tocopherols, carotenes) and hydrophilic antioxidants (ascorbic acid). These three inhibitors may act as synergists [26]. Polyphenols in red wine probably have a favorable effect, similar to polyphenols in fruits [27]. Some drugs also have antioxidant activity *in vitro* [28].

### 11.2.3.2 Cancer

Free radicals may attack nucleic acids, modifying their structure and changing the genetic code of the cell [25]. Therefore, they have mutagenic, teratogenic, and carcinogenic activities. Lipid free radicals may convert other substances into potential carcinogens. The activity of various antioxidants (e.g., tocopherols, sulfur, and selenium compounds) is therefore important in cancer prevention.

### 11.2.3.3 Aging

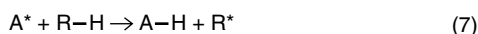
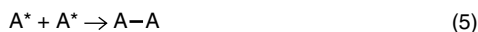
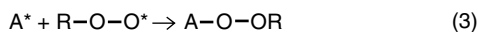
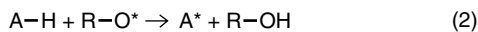
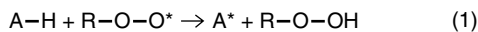
Free radicals induce changes in polypeptide chains of proteins, resulting in cross-linking [29]. Another reaction is the formation of brown macromolecular complexes between oxidized lipids and proteins; they are deposited in the brain and other tissues. The formation of insoluble polymers is the main cause of aging. Therefore, the presence of antioxidants, which inhibit polymerization, in the body may delay the degenerative changes connected with the process of aging.

## 11.2.4 Antioxidants and the Mechanism of Their Action

Natural antioxidants were originally used to protect foods against oxidation, but their activities were generally low and they were unreliable as natural antioxidants consist of mixtures of several compounds with different antioxidant properties as well as inactive impurities. The biological variability also contributed to the unreliable activity of natural preparations. They were soon replaced by pure synthetic compounds, which were cheaper and possessed reproducible activities. Their safety as a food additive has been tested by complicated sophisticated tests.

### 11.2.4.1 Mechanism of Action of Antioxidants

Antioxidants react with peroxy radicals produced in oxidized lipids (Figure 11.3, Equation 1), forming a hydroperoxide molecule and a free radical of the antioxidant [5,6]. Free antioxidant radicals are relatively stable so that the back reaction is extremely slow. They do not initiate a chain autoxidation reaction unless present in excess. They react [30] in a similar way with an alkoxy free radical formed during the decomposition of hydroperoxides (Figure 11.3, Equation 2). Free antioxidant radicals may react with another lipid hydroperoxide with formation of a quinone. Antioxidants form physical bonds with lipid hydroperoxides, inhibiting thus their decomposition into free radicals [31]. Several secondary reactions of free antioxidant radicals were reported; free antioxidant radicals react with a peroxy or an alkoxy radical forming a copolymer (Figure 11.3, Equations 3 and 4) or with another antioxidant free radical (Figure 11.3, Equation 5). Dimers (and even trimers) are formed in this way, which have a modest antioxidant activity of their own. By the action of some synergists, such as ascorbic acid, the original



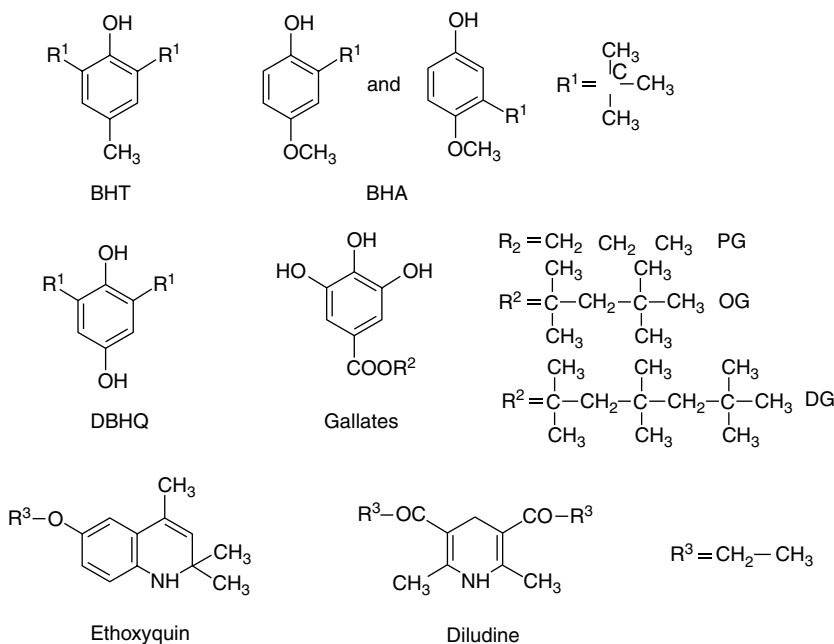
**FIGURE 11.3** Mechanism of reactions of antioxidants with free radicals. (See text for details.)

antioxidant may be regenerated. By reaction with a molecule of oxygen, free antioxidant radical is converted into an antioxidant peroxy radical (Figure 11.3, Equation 6), especially if both antioxidants and oxygen are present in excess. Free antioxidant radical can also react with some labile compounds, such as terpenes, which form free radicals easily (Figure 11.3, Equation 7). Changes of antioxidants occur under conditions of food processing and storage, including the culinary meal preparation [32]. The mechanism of action of natural phenolic antioxidants is essentially the same as that of synthetic phenolic antioxidants. The only difference is that they are usually present in mixtures with related compounds of varying activities and with synergists, such as phospholipids, amino acids, or terpenes. If they are added to food as unprocessed ingredients, the microstructure of the tissue can play a role.

### 11.2.4.2 Chemical Structures of the Most Important Antioxidants

#### 11.2.4.2.1 Synthetic Antioxidants

Many phenolic compounds are active as antioxidants, but only a few are used for food stabilization because of very strict safety regulations. Their chemical structures are shown in Figure 11.4. Most of the approved antioxidants are phenolic derivatives, usually substituted by more than one hydroxyl or methoxy group. Among heterocyclic compounds containing nitrogen, only ethoxyquin is used (2,6-dihydro-2,2,4-trimethylquinoline) [33], but now exclusively in feeds. Diludine (a substituted dihydropyridine derivative) is used for the stabilization of carotene and some pharmaceutical preparations, but not in food in spite of its good activity in fats and oils [34]. Synthetic phenolic antioxidants are mostly *p*-substituted, as their toxicity is lower, while most natural phenolic compounds are *o*-substituted [35]. The *m*-substituted compounds are nearly inactive. Gallates are esters of gallic acid, which is a natural compound, but propyl, octyl, and dodecyl esters are not found in nature. Synthetic phenolic antioxidants are always substituted by alkyls to improve their solubility in fats and oils, and reduce their toxicity. More details can be found in the literature [36]. Mixtures of phenolic antioxidants often show synergistic activities, e.g., *tert*-butylhydroxytoluene (BHT) and *tert*-butylhydroxyanisole (BHA) [37]. In addition to their antioxidant activity, most phenolic substances possess antimicrobial activity in food [38]. It should be mentioned that  $\alpha$ -tocopherol, D-ascorbic acid, and other antioxidants may be synthesized; nevertheless, they are considered as nature-identical compounds. Therefore, they will be discussed under natural antioxidants.



**FIGURE 11.4** Chemical structures of the most important synthetic antioxidants. BHT, di-*tert*-butylhydroxytoluene; BHA, *tert*-butylhydroxyanisole; DBHQ, di-*tert*-butylhydroquinone; PG, propyl gallate; OG, octyl gallate; DG, *tert*-dodecyl gallate.

#### 11.2.4.2.2 Natural Antioxidants

In the last few decades, people have become aware of technology and science, particularly of chemistry, and have turned to natural compounds in the diet [39]. Consumers prefer food products stabilized with various natural antioxidants [40]. Research and development laboratories have shown great interest in exploring natural antioxidants. Such research benefits the manufacturer, as natural compounds are subject to less strict regulations, especially if they are considered as flavorings or natural food components.

Almost all plants, microorganisms, fungi, and even animal tissues contain antioxidants of various types, which for various reasons (e.g., availability, food safety, economical reasons) can be used as sources of antioxidants only in certain cases. For instance, of 147 plants tested, 107 extracts showed measurable antioxidant activity [41]; the majority of natural antioxidants are phenolic compounds. The biosynthesis of antioxidants in plants was reviewed and discussed [42]. In commercial preparations, natural phenolic antioxidants, are usually accompanied by other inhibitors of oxidation such as synergists, singlet oxygen quenchers, and chelating agents.

#### 11.2.4.2.3 Types and Sources of Natural Antioxidants

In higher plants, where phenolic compounds are very common, two series of compounds are of particular interest, derivatives of benzoic acid and cinnamic acid series [43]. The aromatic cycles substituted by two or three phenolic groups in the *ortho*-position are particularly important; some hydroxyl groups may be methoxylated. Gallic acid is a typical representative of the benzoic acid series, while caffeic acid is the most typical derivative of the cinnamic acid series. Catechins and flavones are more complicated compounds (see below), where the antioxidant activity is located in a pyrocatechin or pyrogallol radical bound in the molecule.

The best method of application of natural antioxidants is to use natural food components (e.g., cereals, nuts, fruits, and vegetables) because they are regarded as safe and no special approval for their application is necessary. Another possibility is to use natural food ingredients such as spices. Natural compounds derived from nonfood materials, such as ginkgo leaves [44], should be tested for toxicity before application. A natural antioxidant, nordihydroguaiaretic acid (NDGA), extracted from the creosot bush grown in California was originally used in food stabilization for a long time [45], especially in edible fats, but it is not permitted now because it has not passed more recently introduced safety tests.

**11.2.4.2.3.1 Tocopherols** Tocopherols are the most common antioxidants, as they are present, at least in traces, in nearly all food materials. They are derivatives of chroman with a diterpenic (phytol) side chain; the active configuration is the phenolic group in the benzene cycle, located *para* to the oxygen atom bound in the adjacent dihydropyrone cycle. There are four tocopherols that differ in methyl substitution (Figure 11.5). The most important antioxidant of this group is D- $\alpha$ -tocopherol, which has lower antioxidant activity in edible oils than other tocopherols, but is more easily absorbed in the intestines; therefore, it possesses an *in vivo* antioxidant activity and a vitamin E activity as well. The *in vivo* activity decreases in the order  $\alpha > \beta > \gamma > \delta$  tocopherols [46], while in bulk fats and oils it decreases in the order  $\delta > \gamma > \beta > \alpha$  tocopherols [47]. Tocopherols are present mostly in foods of plant origin. Their content in edible oils is particularly high (Table 11.4). Between 20% and 50% of tocopherols are lost during edible oil refining (especially during deodorization), but they are often replaced by addition of  $\alpha$ -tocopherol acetate or a deodorization concentrate (collected during the deodorization step of oil refining) into refined oils. Tocopherol acetate is added instead of free tocopherol because it is more resistant against oxidation during storage of edible oil. In foods of animal origin, such as butter or meat, tocopherols are present only in negligible amounts.

In oilseeds, cereals, and other products, tocopherols are accompanied by dehydrotocopherols, tocomonoenols, tocodienols, and tocotrienols, which have one, two, and three double bonds in the side chain, respectively [48]. The last group is present in cereal flours and in palm fruits and palm oil. The related plastochromanol-8 has activity similar to  $\alpha$ -tocopherol [49]. Tocopherols added to food products may be either synthetic products or natural concentrates, obtained most often from deodorization sludges from oil refining, wheat or corn germs, or other sources. Natural tocopherols have optical activity unlike synthetic products.

In foods of plant origin, tocopherols act as relatively weak antioxidants because vegetable oils already contain tocopherols in concentrations near the optimum activity. On the contrary, tocopherols are very active in lipids present in vegetable oils, which were stripped of their natural antioxidants [50]. Tocopherols are very active in foods of animal origin, as they contain nearly no natural antioxidants.

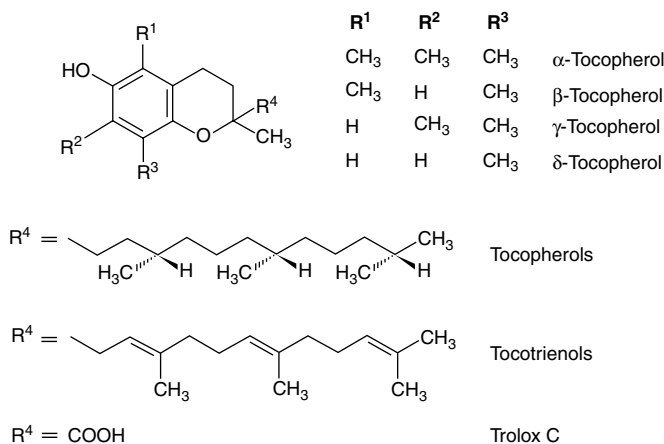


FIGURE 11.5 Chemical structures of tocopherols.

TABLE 11.4

Tocopherol Content in Vegetable Oils

Oil	α-Tocopherol (mg/kg)	β- + γ-Tocopherols (mg/kg)	δ-Tocopherol (mg/kg)	Total Tocopherols (mg/kg)
Soybean	80–150	210–780	60–400	300–1400
Rapeseed	120–300	220–450	5–15	380–750
Sunflower	550–900	25–110	0–5	580–980
Corn germ	120–400	420–780	10–50	680–1250
Peanut	80–320	120–280	5–30	90–550
Olive	80–180	0–5	0	80–180
Cottonseed	550–700	200–280	0–5	800–980
Rice bran	500–650	230–340	0–5	750–950

A mixture of tocopherols, ascorbyl palmitate, and lecithin efficiently stabilized such a polyunsaturated material as fish oil [51]. By reaction with free radicals, tocopherols are converted into quinones, spirodimers, and various other compounds [52], as well as in copolymers with oxidized lipids.

**11.2.4.2.3.2 Antioxidants from Oilseeds** Several important oilseeds are sources of natural antioxidants [53] other than tocopherols (Table 11.5). During the processing of oilseeds or oil-bearing fruits, antioxidants are partially extracted into crude oils. The best-known oxidation inhibitors are those present in olives, which are the fruits of *Olea europaea (oleracea)* L. Virgin olive oil, produced by pressing fruits under low temperature, contain several antioxidants derived from hydroxytyrosol (Figure 11.6), a derivative of tyrosine [54]. The antioxidants are present mostly as glycosides in the pericarp (i.e., they are water soluble) and remain mainly in the residue after pressing (pomace). During ripening, storage, or pressing, glycosides may be hydrolyzed into the respective aglycones; for instance, oleuropein is present with its aglycone in virgin olive oils, but some antioxidants are partially reduced during pressing [55]. The content and properties of antioxidants depend on the degree of ripeness and the processing conditions [56]. In the sterol fraction, olive oil contains Δ<sup>5</sup>-avenasterol, which acts as an antipolymerization agent under conditions of deep frying [54]; the antioxidant activity is due to the extremely high stability of the respective vinyl free radical, formed by reaction of avenasterol with peroxy radicals.

Sesame seeds from *Sesamum indicum* L. contain lignan analogs, which are, together with their decomposition products, present in crude sesame oil and extracted meal [57]. They are only partially eliminated during refining so that they contribute to the well-known stability of sesame oil. The most active compound is sesamol (Figure 11.6), which is accompanied by several structurally related compounds [58]. The antioxidant activity is affected by roasting and steaming of seeds before extraction [59]. Sesame lignans, added in small concentration, were very active in ground pork and sausages [60].

TABLE 11.5

Antioxidants from Oilseeds

Oil Seed	Systematic Name	Type of Substance
All seeds	—	Tocopherols
Palm fruit	<i>Elaeis guineensis</i>	Tocopherols
Olive fruit	<i>Olea europea</i>	Oleouropein aglycone
Sesame seed	<i>Sesamum indicum</i>	Sesamol
Cottonseed	<i>Gossypium hirsutum</i>	Gossypol
Rapeseed	<i>Brassica napus</i>	Sinapic acid
Flaxseed	<i>Linum usitatissimum</i>	Lignans
Rice bran	<i>Oryza sativa</i>	Oryzanol

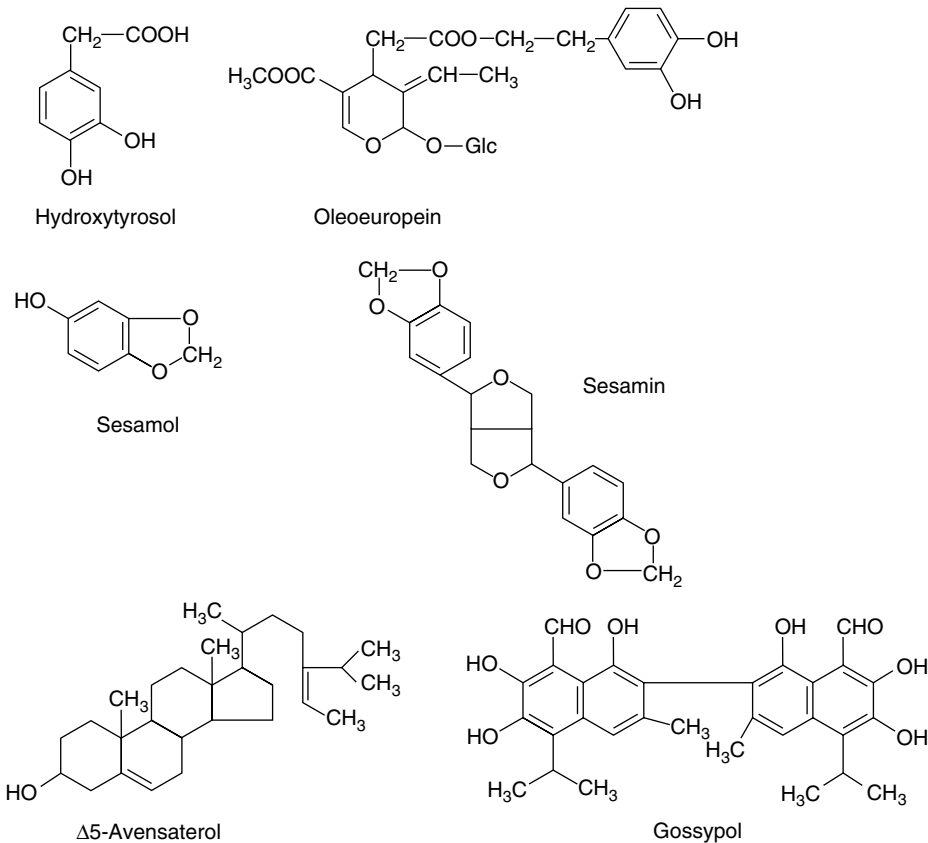


FIGURE 11.6 Chemical structures of some natural antioxidants from seeds.

Sunflower (*Helianthus annuus* L.) seeds are rich in polyphenols; therefore, extracted meals are frequently discolored by interactions of enzymatically oxidized polyphenols with protein. Seeds contain chlorogenic acid and related phenolic derivatives, which are only partially decomposed during processing. Polyphenoloxidases oxidize polyphenols into quinones, which react with amino groups of proteins, imparting brown discoloration to seed meals. Peanuts from the plant *Arachis hypogaea* L. contain flavonoids, tannins, and various other phenolic compounds [61], concentrated in peanut hull [62]. Several papers report the preparation of hull extracts for the stabilization of foods.

Cottonseed (*Gossypium hirsutum* or *G. barbadense*) contains gossypol, a complicated polyphenolic compound with aldehydic groups possessing antioxidant properties. Because of the toxicity of gossypol (it is active as a male contraceptive agent), cottonseed-extracted meal could not be used as feed in

large amounts. Therefore, modern cultivars (glandless cottonseed) of this plant are gossypol-free. Gossypol was a powerful antioxidant, but glandless cottonseed still contains flavonoid antioxidants [61,63] such as quercetin and tocopherols. Soybeans (*Glycine max*) also contain phenolic compounds with antioxidant activity, mostly flavones and isoflavones [64], which may stabilize lipids not only in beans, but also in soy products such as tofu or tempeh [65]. Isoflavones possess a hormone-like activity, which should be accounted for when evaluating the possible applications as inhibitors.

Rapeseed (*Brassica napus*) and the related turnip rapeseed (*Brassica rapa*) are relatively rich in phenolic compounds, among which sinapic acid prevails. It acts as a moderate antioxidant in polyunsaturated oils [64]. In rapeseed, sinapic acid is mostly bound to choline, forming sinapine, which is nearly inactive as an antioxidant in oils. Structurally related tannins are also present in rapeseed. Evening primrose (*Oenothera biennis*) seeds contain high levels of phenolics, mainly derivatives of protocatechuic and gentisic acids [66,67]. Flaxseed also contains several lignans and flavonoids active as antioxidants [68].

**11.2.4.2.3.3 Antioxidants from Cereals and Grain Legumes** Cereals, one of the most important components of the human diet, contain several types of phenolic compounds, especially in bran. Oat is considered relatively efficient from this standpoint [69]; oat extracts were the first natural antioxidants studied in detail before World War II. Extracts were patented and used in oils and other foods. Phenolic compounds present in oat seed are partially bound in lipids, and therefore are liposoluble. Rice bran is used for the production of oil; therefore, it is collected and extracted with solvents. During the process, some phenolic compounds, such as oryzanol [70], pass into crude rice oil. Rice oil is particularly rich in antioxidants (including tocopherols) and low in polyunsaturated fatty acids; therefore, it is very stable during storage, like olive oil. Maillard products formed during the baking or roasting of food originate from sugars and amino acids; they have a stabilizing effect on lipids in foods, especially in baked products.

The content of phenolic substances in grain legumes is mostly low; nevertheless, they might stabilize foods if added in substantial amounts as an ingredient. Phenolic substances (mainly flavanols) are concentrated in legume hulls [71]. These phenolic derivatives may be insoluble (tannins or lignins), but some derivatives are partially soluble in oil. This is why they sometimes become efficient in stabilizing the lipid fraction. Antioxidants from peas were isolated and their antioxidant activities reported [72]. Polar bean extracts showed high activities in lipid emulsions [73]. Lentil seeds are also rich source of antioxidants, mainly phenolic acids [74].

**11.2.4.2.3.4 Compounds from Fruits and Vegetables** The most important group of compounds active as antioxidants in fruits and vegetables [75] consists of various flavones and related compounds. Some substances belonging to this group act as cofactors of vitamin C, increasing its vitamin activity. They protect vitamin C against destruction by free radicals. Ascorbic acid present in fruits increases the antioxidant activity of phenolic components in linoleic acid-carotene system, e.g., in extracts from acerola fruits [76].

Grapes contain both lipophilic and hydrophilic antioxidants; their concentration is substantially higher in red wine than in white wine [77]. In red wine and deep-colored fruit juices, various anthocyanins are present [78], which are important antioxidants active in the aqueous phase. Red wine has been recommended as a source of antioxidants such as resveratrol, to protect humans against the development of cardiovascular diseases, but several other factors may be involved so that the antioxidant activity should be confirmed by further experiments.

In addition to the above compounds, various terpenic derivatives could act as potent inhibitors of lipid oxidation. The effect of terpenes will be discussed in the next section, as terpenes are more important in spices. In the category of fruits, the substances investigated in most detail are those isolated from citrus fruits. Their activity is higher in oil-in-water emulsions than in oils because of the hydrophilic character of flavone glycosides and related compounds. Ethanolic or aqueous extracts (which contain much more hydrophilic substances than hexane or ether extracts) seem to impart higher activities to water-in-oil emulsions. Their solubility also plays a role; therefore, they are more soluble in polar food systems while hexane and ethyl acetate extracts are more soluble in fats and oils. Various nuts (e.g., macademia nuts) contain antioxidants [75]; these substances are extracted into the respective oils by pressing. In peanuts or in almond [79], phenolic antioxidants are concentrated in brown skins. Inhibitors of oxidation have been detected in extracts from hop [80].

TABLE 11.6

Antioxidants in Fruits and Vegetables

Species	Systematic Name	Types of Substance
Citrus	<i>Citrus</i> sp.	Flavonoids, carotenoids
Plums	<i>Prunus</i> sp.	Phenolics
Persimmon, kaki	<i>Diospyros kaki</i>	Procyanins, catechins
Red wine	<i>Vitis vinifera</i>	Anthocyanins
Pineapple	<i>Ananas comosus</i>	Flavanols
Onion	<i>Allium cepa</i>	Sulfur compounds
Garlic	<i>Allium sativum</i> ssp. <i>vulgare</i>	Sulfides, disulfides
Green pepper	<i>Capsicum annuum</i>	Flavonoids
Carrots	<i>Daucus carota</i>	Carotenoids, flavonoids
Betel	<i>Areca catechu</i>	Oleoresins, eugenol, hydroxychavicol
Legume	<i>Leguminosae</i>	Flavonoids
Green olives	<i>Olea europaea</i>	Anthocyanins
Mustard	<i>Sinapis alba</i>	Phenolics, isothiocyanates
Oak (wood)	<i>Quercus ilex</i>	Phenolic acids, lignins

The most important extracts from fruits and vegetables are listed in Table 11.6. Most of them are various pyrocatechol derivatives. Onion and garlic contain efficient inhibitors; because of their pungent flavor, they are suitable only for meat products, snacks, or cheeses [81]. Potent antioxidants can be obtained from various nonfood plant products such as ginkgo leaves, but the substances from such sources (i.e., not used for food purposes) should be tested for safety before application.

**11.2.4.2.3.5 Extracts from Herbs and Spices** Herbs are mostly leaves or stems from various plants used for the preparation of infusions, extracts, or soups. Many species of this group of food materials are active [41,82] mainly because of their content of phenolic compounds. The most important representatives of this group of substances are leaves from tea bush (*Camellia sinensis* or *C. assamica* L.) [83]. Green, oolong, and black teas are produced, depending on the technology of leaves processing [84]. Green tea contains a high percentage (about 20%) of catechins and related compounds [85]. The mixture mainly consists of catechins, epicatechins, gallo catechins, and the respective gallates. Extracts from green tea are, therefore, very active; their activity is comparable to that of synthetic antioxidants. Extracts from leaves of fermented, black tea are less active because a substantial part of the catechins has been converted into less-active tea pigments [84,86]. During the fermentation of tea leaves, catechins are partially enzymatically oxidized into the respective quinones, which dimerize into tea pigments—theaflavins and thearubigins. Wastes left over after the preparation of tea infusions or commercial tea products may be used for the preparation of extracts with antioxidant activity. The antioxidant activity in lard may be ranked in descending order as follows: epigallocatechin gallate > epigallocatechin > epicatechin gallate > epicatechin. Raw materials used for the preparation of herbal teas are less efficient, but various herbs used in China, Japan, and other Far East countries contain efficient antioxidants, too [87]. Algae contain several brominated 3,4-dihydroxybenzene derivatives [88]. Seaweed hydrolyzates were found very active as antioxidants, mainly in various animal foods [89]. Spices are used for conditioning meals and bakery products. Several species possess antioxidant activity [90], some of which are listed in Table 11.7. Wastes left after the distillation of essential oils from spices could be used as raw material for the extraction of antioxidants.

The most active substances are those spices applied to foods as leaves [100]. Extracts produced from rosemary leaves (*Rosmarinus officinalis* L.), which is the only commercially available antioxidant of this group, and sage (*Salvia officinalis* L.), which contain several structurally related antioxidants [104–107] such as carnosic acid, carnosol, or rosmarinic acid [106] (Figure 11.7). Their activity was tested in various foods, and particularly the lipid-soluble fraction was active [108], e.g., in restructured pork steak [108]. Other active spices include thyme [95], juniper, oregano [113,118], ginseng, ginger, nutmeg, etc. (Table 11.7). In most cases, it is sufficient to add spices to the food products before or after the preparation, but extracts may be added instead of spices [93,100]. The addition of pure substances (isolated from spices) is not recommended, as the application of pure compounds would be considered as addition of

TABLE 11.7

Antioxidants from Herbs and Spices

Species	Systematic Name	Substances	References
Rosemary	<i>Rosmarinus officinalis</i>	Carnosic acid, carnosol	[91,92]
Sage	<i>Salvia officinalis</i>	Carnosic acid	[75,92]
Tanshen	<i>Salvia miltiorrhiza</i>	Carnosol	[102,103]
Thyme	<i>Thymus vulgaris</i>	Thymol, quinones	[97–99]
Savory	<i>Satureia hortensis</i>	Flavonoids	[77]
Clove	<i>Eugenia caryophyllata</i>	Eugenol, gallates	[99,109]
Black pepper	<i>Piper nigrum</i>	Ferulic acid	[110]
Ginger	<i>Zingiber officinalis</i>	Cassumarin, ginerol	[94]
Juniper	<i>Juniperus communis</i>	Phenolics, resins	[108,110]
Oregano	<i>Origanum vulgare</i>	<i>o</i> -Substitute phenolic acids	[96,114]
Fennel	<i>Foeniculum vulgare</i>	Dihydrocoumarins	[98,110]
Curcuma	<i>Curcuma longa</i>	Curcumin	[108,111]
Spearmint	<i>Mentha piperita</i>	Flavonoids	[90]
Lavender	<i>Levandula angustifolia</i>	Flavonoids	[108]
Hop	<i>Humulus lupulus</i>	Flavonoids, anthocyanins	[100]
Allspice	<i>Pimenta officinalis</i>	Flavonoids	[101]
Ginseng	<i>Panax ginseng</i>	Phenolic acids	[112]

antioxidants, not flavorings, and would be subject to legal restrictions. Some spices alter the flavor of food products, but deodorized material (i.e., after removal of essential oil by steam distillation) could be used without affecting the flavor. Spices that have antioxidant activity often possess antibacterial activity too. (Detailed information can be obtained from Ref. [90].)

#### 11.2.4.2.4 Other Oxidation Inhibitors

In foods and feeds, phenolic antioxidants are rarely present without other types of inhibitors of oxidation reactions. Other inhibitors are added with extracts of natural antioxidants or may be even added to enhance the antioxidant activity of the system. Even synthetic antioxidants are usually applied in mixtures with synergists and/or chelating agents.

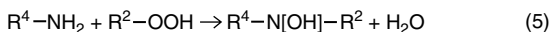
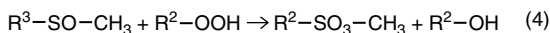
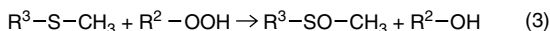
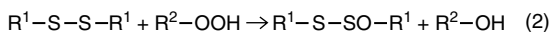
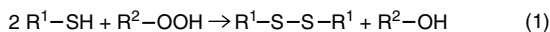
**11.2.4.2.4.1 Substances Decomposing Hydroperoxides in a Nonradical Way** Different substances may convert hydroperoxides into less-reactive hydroxyl derivatives. Sulfur compounds are very active substances, which are mostly bound in proteins. Thiols, such as cysteine, are oxidized into cystine, which belongs to disulfides (Figure 11.8, Equation 1). Cystine may be further oxidized by another molecule of a hydroperoxide into sulfinic acid (Figure 11.8, Equation 2). Similarly, sulfides, such as methionine, react with hydroperoxides, forming sulfoxides (Figure 11.8, Equation 3). The product may react with another molecule of a hydroperoxide, resulting in the respective sulfone (Figure 11.8, Equation 4). Onion and garlic contain sulfur compounds possessing hydroperoxide-decomposing activity [115–118]. Selenium-containing amino acids (selenocysteine or selenomethionine), present in traces in natural proteins, react in a similar way. In the body, they help to retain vitamin E [118]. Selenium has more importance as part of an antioxidative enzyme, selenogluthathione oxidase, inactivating free radicals and other oxidants, particularly hydrogen peroxide.

Hydroperoxides may react with free amine groups of proteins (Figure 11.8, Equation 5); imines are formed from the intermediary products by subsequent dehydration. Various basic groups, such as histamine or indole, can deactivate hydroperoxides following similar mechanisms. Carnosine, a histidine dipeptide, was found to be efficient in decomposing hydroperoxides [119]. Many amino compounds can deactivate free radicals, therefore, these amino derivatives have an anticarcinogenic activity. Free amino acids are present in protein hydrolysates, which are thus active, e.g., in various meat products [120].

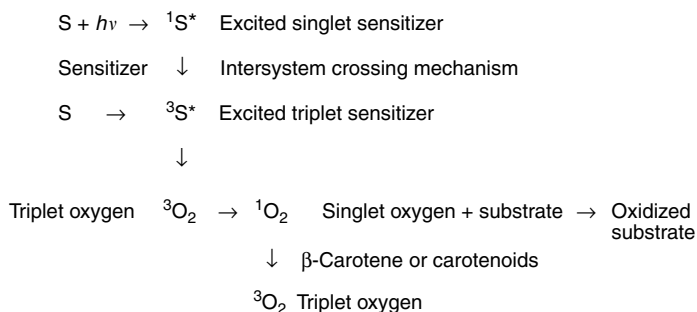
**11.2.4.2.4.2 Synergists** Synergists are substances that have no antioxidant activity of their own, but they can increase the activity of an antioxidant. The most frequently used synergists are polyvalent inorganic (phosphoric acid) or organic acids. Ascorbic acid and its isomer, erythorbic acid (earlier called isoascorbic







**FIGURE 11.8** Deactivation of lipid hydroperoxides by sulfur and nitrogen compounds. (See text for details.)



**FIGURE 11.9** Quenching of singlet oxygen produced during photooxidation.

from the respective free radicals. Most synergists act after several mechanisms. Most natural materials for the application as antioxidants, being complicated mixtures, contain the above synergists in various amounts so that they can be used as sources of both phenolic antioxidants and of synergists, acting in the mixture after several mechanisms.

**11.2.4.2.4.3 Singlet Oxygen Quenchers** As explained in Section 11.1.2, singlet oxygen may be formed from ordinary triplet oxygen by the action of light in the presence of a photosensitizer, such as chlorophylls and pheophytins (Figure 11.9). The singlet form of oxygen is very reactive; therefore, it is extremely important to deactivate it back to the triplet form very rapidly. Various substances are effective from this standpoint, but in food materials, carotene and other carotenoids are the most important singlet oxygen quenchers [128]. Carotenoids, called xanthophylls, have similar deactivating activity, even when they have no provitamin activity like that of carotenes. Tocopherols increase the activity of carotenes in this respect [129]. The structurally related vitamin A has a similar activity, but it is usually present in much smaller quantities in food-stuffs than are carotenoids. Ascorbyl palmitate is an active singlet oxygen quencher too [130].

**11.2.4.2.4.4 Metal-Chelating Agents** Metal ions of transient valency, such as copper, iron, cobalt, chromium, or manganese, are very active prooxidants (see Section 11.1.2.4). They may be active not only in the ionic form, but also in complexes. For instance, iron is an active prooxidant in heme derivatives. Therefore, substances that are able to bind these metals into inactive complexes can inhibit oxidation reactions of lipids.

Many metal-chelating substances are present in foods as natural components, especially in plant materials. Phytates (salts of phytic acid—*myo*-inositol hexaphosphate), phospholipids, and oxalates are the most common representatives of this group. Synergists, such as phosphoric acid, citric, tartaric, malic, or ascorbic acids, also possess pronounced chelating activities. Polyphosphates are added to inactivate iron in food, especially in various meat products [131]. Even some phenolic antioxidants may bind metals into complexes, e.g., quercetin. Silicon oil is often added to frying oils to inhibit degradation by protecting against the diffusion of air oxygen; the activity is, however, at least partially attributed to prevention of dissolution of iron in oil during frying [132].

The chelating activity depends on the pH value, water content, and other factors of the medium. Usually, metals are not completely inactivated by any agent; only their prooxidant activities decrease by at least a partial chelation. We have shown in phosphatidic acids and in pheophytins that the chelating activity is often very high. Nevertheless, it should be kept in mind that even minute traces of free metals (a small fraction not bound in complexes) are sufficient in some cases to efficiently promote autoxidation.

---

### **11.3 Application of Antioxidants in Foods**

Antioxidant activities depend not only on the antioxidant structure, but also on many other factors, such as the composition of the lipid fraction, availability of oxidants, presence of various other inhibitors or promoters of oxidation, presence of nonlipidic components, water, microstructure, temperature, etc. Therefore, the literature data should be always verified by using the specific substrate and processing or storage conditions.

#### **11.3.1 Stabilization of Fats and Oils**

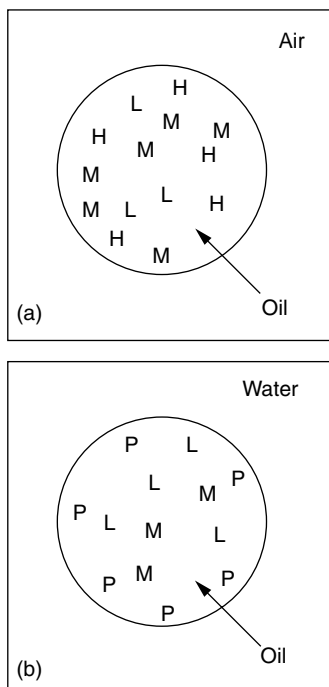
Animal fats, such as pork lard, beef tallow, or milk fat, contain only very low amounts of natural antioxidants; therefore, their stability against oxidation is low in spite of their relatively low degree of unsaturation. Fortunately, both synthetic and natural antioxidants are very active in the stabilization of animal fats. Most often, mixtures of antioxidants and synergists are used for stabilization [133]. Lipid-soluble antioxidants show good results, but polar antioxidants could be used too. When such fats, stabilized with polar antioxidants, are used for the preparation of food, e.g., for cooking or baking, the antioxidant activity is partially lost by extraction of antioxidants into the aqueous phase. Nonpolar antioxidants do not lose their activity under similar conditions, as they remain in the lipidic phase; it is said that they have a good carry-through effect.

Vegetable oils are rather difficult to stabilize because of their high content of polyunsaturated fatty acids. Their advantage is the presence of natural antioxidants, in edible oils, mainly tocopherols. An addition of phenolic antioxidants usually shows limited efficiency, but the addition of synergists is helpful. Ascorbyl palmitate, phospholipids, or organic polyvalent acids are useful as inhibitors in vegetable oils. Most polyunsaturated oils are treated with phosphoric, citric, or other polyvalent acids during processing (they are added in the stage of deodorization) so that some residual synergists are often present in refined oils. Oils containing higher levels of natural antioxidants, such as olive oil, sesame oil, rice oil, etc., are sufficiently stable on storage without additional stabilization. Further addition of tocopherols to most polyunsaturated vegetable oils is inefficient, as their natural content in oils is very close to the optimum [134]. Tocopherol acetate is sometimes added to increase the vitamin activity, not to prolong the shelf life.

Frying oils present a special case, as they are exposed to air oxygen at high temperatures (130°C–200°C) during frying. Many phenolic antioxidants lose their antioxidant activity, observed at storage temperatures, under frying conditions to some extent. Common synthetic antioxidants are distilled off with water vapor released from fried food during frying. Therefore, it is better to use nonvolatile inhibitors. Carotenes and other hydrocarbons were found efficient in frying oils, as they form a monomolecular film on the surface, protecting frying oil against access of oxygen. Frying oils are efficiently stabilized by the addition of minute amounts of silicone oils, particularly siloxanes, which form a thin layer on the interface between oil and air, protecting against the access of air oxygen. Frying oils with low polyunsaturated fatty acid content, such as low-linoleic, high-oleic sunflower oil, high-oleic peanut oil or palmolein, are usually sufficiently stable under frying conditions such that they do not require additional stabilization.

#### **11.3.2 Applications of Antioxidants in Fat Emulsions**

The activity of antioxidants in emulsions is very different from that measured in bulk fats and oils. Water-soluble antioxidants, such as propyl gallate or flavonoids, are extracted into the aqueous phase and only small amount remains in the lipidic phase; they then lose their activity. Nonpolar synthetic antioxidants remain in the fat phase and only very small amount remains in the aqueous phase, but sometimes, they form less efficient micelles. Both polar and nonpolar antioxidants are accumulated at the intermediary layer between the two phases. The consequence of these changes is that polar antioxidants are more active in a nonpolar medium, while nonpolar antioxidants are more active in the polar medium. This paradox was shown in the



**FIGURE 11.10** Distribution of lipo-philic and hydrophilic antioxidants at the oil–water interphase and in oil. (a) System of bulk oil in contact with air. (b) Emulsion of oil in water. L, lipophilic antioxidants; H, hydrophilic antioxidants; M, micelles of lipophilic antioxidants; P, polarized lipophilic antioxidants on the inter-phase.

case of more polar Trolox versus less polar  $\alpha$ -tocopherol on the one hand, and polar ascorbic acid versus less polar ascorbyl palmitate on the other, when tested in bulk oil and in emulsion [135]. Some antioxidants of semipolar nature may accumulate on the water–oil interphase (Figure 11.10) and prevent the diffusion of oxygen into the fat phase. The activity depends on the type of emulsion. Oil-in-water (O/W) emulsions are better protected against oxidation than water-in-oil (W/O) emulsions, as oil droplets are isolated from the access of oxygen by the aqueous phase and the interfacial layer. In the presence of tocopherols, phospholipids are active ingredients in oil–aqueous emulsions used as food [136]. When rosemary extracts are applied as antioxidants, the activity of antioxidants present in the mixture depends on the type of stabilized material. Carnosic and rosmarinic acids are more active than carnosol in oils, but carnosic acid and carnosol are equally active in emulsions, more so than rosmarinic acid [137].

### 11.3.3 Applications of Antioxidants in Foods

The efficiency of antioxidants in foods depends very much on the water content [138]. Generally, dry foods such as dehydrated soups, dried milk [139], dried meat, etc. are very sensitive to oxidation, as air oxygen has free access to the film of lipids on nonlipidic particles. It may enter through tiny channels that are left after removal of water from the original material. The food stabilization is then less effective as the initiation rate of the autoxidation reaction is relatively high and antioxidants are soon decomposed on storage or heating. In water-containing foods, the lipid fraction is relatively stable, as it is usually protected by a layer of hydrated proteins or carbohydrates against the access of air oxygen. The addition of nonpolar antioxidants is effective, while polar antioxidants may lose their activity by passage into the aqueous phase, similarly as in fat emulsions. Proteins and many other components of foods have protective action and act as synergist of other inhibitors, enhancing the effect of antioxidants [140]. Amine groups present in proteins react with lipid peroxides and hence the level of free radicals decreases,

which contributes to longer protection of foods against oxidation. Chelating agents are often present in foodstuffs as natural components, but heavy metals are usually present as well, for instance, heme derivatives in animal products. Because of the complexity of foods, it is necessary to test any addition of antioxidants to stabilize the particular material and to optimize the mixture of inhibitors.

### 11.3.4 Applications of Antioxidants in Packaging

Air oxygen penetrates the food material from outer atmosphere; therefore, it is useful to protect food surfaces. Meat or fish products are often protected by packaging materials, impregnated with antioxidants or by application of suitable antioxidants on the surface of materials, even when they are not packed. Most often, foods are distributed packed; the packaging material is then of great importance [141]. If the material is permeable to oxygen, antioxidants may be added to the packaging to inhibit the diffusion of oxygen. These antioxidants may enter into the packed food [142], especially high-fat foods. Obviously, the only antioxidants that can be used in packaging are those that are allowed in foods, and they should be applied only in such amounts that the content in foods does not exceed the legal limits.

Packaging materials may be protected against oxidation by adding antioxidants already in the factory, even when the producer of foods does not intend to stabilize food in this way. The case is the same as above, but eventual extraction of antioxidants into food should be accounted for. The degree of extraction of antioxidants from packaging should be tested for the respective type of food product.

**TABLE 11.8**

Antioxidants Used in Edible Fats and Oils

Antioxidant	Abbreviation	Applications
Propyl gallate	PG	Fats and oils
Dodecyl gallate	DG	Fats, emulsions
<i>tert</i> -Butylhydroxytoluene	BHT	Fats and oils, foods
<i>tert</i> -Butylhydroxyanisole	BHA	Fats and oils, foods
Di- <i>tert</i> -butylhydroquinone	DBHQ	Vegetable and fish oils, frying oils
Ascorbyl palmitate	AP	Vegetable oils, synergists
Tocopherols	To	General use in fats, oils
Citric acid, esters	CA	Synergists, edible oils
Thiodipropionic acid		Synergist
Lecithin		Synergist
Carotenes		Frying oils, edible oils, emulsified oils
Silicone oil		Frying oils

### 11.3.5 Legally Permitted Levels of Antioxidants

The use of synthetic antioxidants is restricted to a few compounds, which have passed very complicated and expensive tests to prove their safety [143–145]. Such tests include the generation tests and teratogenic and carcinogenic trials using at least six species of animals, among which at least three should be vertebrates and at least one nonrodent. Therefore, no new antioxidants (with a few exceptions) are tested and permitted, and the addition of the antioxidants to food is usually restricted to 0.02% on fat basis. Permitted antioxidants are different in different countries and subject to change [146]; some examples are given in Table 11.8. For practical reasons, it is suitable to add mixtures of antioxidants, which usually have higher activities than a single compound and which guarantee that the limits for single compounds have not been exceeded. Many commercial preparations are mixtures of antioxidants, synergists, and emulsifiers, or other substances facilitating the dissolution of the product in fats and oils. Some natural materials are generally regarded as safe (GRAS); their use is not restricted by legislation (e.g., tocopherols, phospholipids, amino acids, etc.). Some common food ingredients, such as spices, are also not subject to legal restrictions as they are considered as flavoring or coloring substances. For pure compounds isolated from natural materials or extracts from plant materials not used as food, it is necessary to prove that there are no risks involved in their use.

## 11.4 Analysis of Antioxidants

In the analysis of antioxidants, two aspects are important: determination of the content of antioxidants and determination of the antioxidant activity.

### 11.4.1 Content of Antioxidants

The analysis of antioxidants consists of two subsequent operation stages [145]: isolation of antioxidants from the substrate and purification of the extract, and quantification of antioxidants in the extract. Several methods have been standardized and can be found in the respective books of analytical standards [147–149]. Antioxidants are subject to changes during food storage or heating [32] so that it would be correct to isolate and determine not only the original antioxidant, but also potential degradation products. Only in such a way would it be possible to find whether the original content of antioxidants has not exceeded the legal limit.

#### 11.4.1.1 Isolation of Antioxidants from Fats, Oils, and Foods

The analysis of antioxidants is very simple for pure preparations, but it is very difficult to prepare the sample for analysis of fats, oils, and other foods. Two difficulties faced by the analyst are how to achieve quantitative yield during the extraction and purification of extracts and how to prevent the oxidation of antioxidants during the operation. Usually, antioxidants, being semipolar substances, are extracted using

semipolar solvents, and the removal of solvents is performed under nitrogen. The extract may be purified by solid-phase extraction on specific cartridges or using traditional column chromatography. Sometimes, it is possible to use a precolumn for the subsequent chromatographic separation. Antioxidants naturally present or added to foods as natural components or flavorings may be partially converted into degradation products by reaction with oxygen or free radicals. Therefore, the content found by the analysis need not exactly correspond to the amount originally present, similarly as in case of synthetic antioxidants.

### 11.4.1.2 Determination of Antioxidants Isolated from the Substrate

The three important methods that exist for the determination of antioxidants are spectrophotometric, chromatographic, and electrochemical methods (Table 11.9).

#### 11.4.1.2.1 Spectrophotometric Methods

Spectrophotometric methods are very simple and do not require expensive equipment. Usually, the redox capacity of antioxidants is utilized and the sample is treated with a suitable oxidizing agent and a redox indicator. The change of coloration is then recorded. Another method is the reaction with ferric salts, which are reduced into ferrous salts. A compound reacting with either the ferrous or the residual ferric salt is then added, and the coloration of the complex is measured [149]. Determination of tocopherols using the Emmerie–Engel reagent is a typical example.

Another very common method is the reaction of an antioxidant with the phosphomolybdate complex and the measurement of the coloration of molybden blue produced by reduction. This reaction, proposed by Folin and Ciocalteu, is not specific for polyphenolic substances as it is applicable to all phenolic derivatives, not only for *ortho*- or *para*-disubstituted compounds but also for ascorbic acid. Spectrophotometric methods are not sufficiently selective, as all polyphenolic compounds usually react similarly and are determined. Therefore, they are suitable only in cases where a single antioxidant has been used or after previous separation or if the determination of total antioxidants is sufficient.

#### 11.4.1.2.2 Chromatographic Methods

Antioxidant may be determined by gas/liquid chromatography [147], mainly after derivatization (silylation of phenolic hydroxyls). Standard methods for determination are available. Semipolar columns packed with Carbowax 20 M are satisfactory. The method can be combined with identification using a mass spectrometric detector. Analysis using HPLC has been widely used in the last three decades [148]. Antioxidants are best determined with the use of reverse-phase chromatography on octadecylated silica gel with ultraviolet detection. For the determination of very polar substances, such as propyl gallate or ascorbic acid, the direct phase would be acceptable. Thin layer chromatography (TLC) was often used before the development of HPLC, and several standard methods based on TLC are still available [149]. TLC might be used with a sophisticated equipment [150] such as high-performance TLC or TLC-FID.

#### 11.4.1.2.3 Electrochemical Methods

Electrochemical methods are based on the determination of the amount of electric energy necessary to oxidize the substrate. The determination of all the three tocopherols, using pulsed voltammetry, is a typical

**TABLE 11.9**

Methods for Analysis of Antioxidants

Method	Examples	Applications
Spectrophotometric	Redox titration with dichloro-phenolindophenol, Emmerie–Engel, Folin–Ciocalteu	Ascorbyl palmitate, propyl gallate, tocopherols
Chromatographic	GLC after derivatization, reverse-phase HPLC, TLC	Pyrocatechols, BHA, BHT
Electrochemical	Polarography, voltammetry	All antioxidants, gallates, ascorbic acid, tocopherols

example [148]. It is possible to combine a chromatographic method with an electrochemical method, for instance, to use HPLC equipped with an electrochemical detector. The method is very sensitive and selective.

#### 11.4.2 Determination of Antioxidant Activity

During the storage or heating of fats, oils, and foods, the rate of oxidation reactions is rather low in the beginning, as nearly all free radicals produced in the system are inactivated by reaction with antioxidants. This initial period is called the induction period. A typical example is evident from Figure 11.2. When antioxidants present in the substrate are exhausted, free radicals are no longer deactivated; they remain in the system and initiate oxidation chains and the reaction rate increases.

When antioxidants have been added to food substrates, the induction period becomes longer as antioxidants, present in higher amounts than in the original substrate, are exhausted after a longer time than in a nonstabilized substrate. The relative increase of the induction period due to the addition of antioxidants is called the protection factor. Protection factors are often high in case of low-unsaturated substrates, containing no natural antioxidants, such as pork lard (in the order of 20–70). In contrast, they are low (in the order of 2–4) in polyunsaturated substrates such as edible oils containing tocopherols or other natural antioxidants. The antioxidant activity is usually expressed as the induction period or a protection factor.

Many methods have been proposed for measuring the antioxidant activity [151,152]. The best method for the determination of antioxidant activity would be storage (or frying or any other application), but the procedure would be too long and expensive. Usually, it is not possible to wait for a long time to learn the results. Therefore, accelerated methods, using higher temperature or catalysts, are almost exclusively used [153]. The oldest and the most precise method is the Schaal oven test, where the sample is stored at 40°C, 50°C, or 60°C in the dark under free access of oxygen. Changes are monitored either by determining the peroxide value or increase of weight [156]. Analysis lasts several days to several months; therefore, methods using higher temperature are often used. The method of this type is the active oxygen method (AOM) or (earlier) Swift procedure [148], where the sample is aerated at 97.7°C (a boiling water bath) or 110°C (a glycerol bath). These procedures were used for a long time for rapid determination of antioxidant activity. Gases leaving the apparatus during the test are either monitored by sensory analysis or they are collected in water, and changes of the carbonyl content of the water phase or changes of the conductivity are recorded. The increase in conductivity is due to the presence of lower fatty acids, especially formic acid, which originate in later stages of oxidation by secondary reactions. The Rancimat or Oil Stability Index (OSI) method is based on the same principle, but the procedure is automatic [154]. The two last-mentioned methods have been used in great deal than the AOM method due to their simplicity, availability, and reproducibility. The test is usually completed within a working day. Oxidograph (ML Aarhus, Denmark) records changes in the amount of oxygen absorbed by the sample under very similar conditions. The results of accelerated methods do not correspond exactly to the results obtained under storage conditions [155]. Frankel [155] raised objections against methods using high temperatures and recommended use of tests at lower temperatures—in the range of 20°C–60°C.

The American Society of Testing Materials (ASTM), Oxygen Bomb, and the Oxipres (ML Aarhus) methods are based on the recording of pressure changes during oxidation at high oxygen pressure but without aeration, which is closer to actual conditions of food preparation and storage. The temperature is also rather high to shorten the induction period. Various methods operating at lower temperature have been developed; in these cases, the oxidation is catalyzed either by photosensitizers or by addition of copper ions. Their results may not correlate to those obtained during storage in the dark or without the presence of metals. Another method is the oxidation of an emulsion containing linoleic acid and carotene; changes of coloration or the increase of ultraviolet absorption are used for monitoring the reaction course. The antioxidant activity to scavenge free radicals is sometimes used for screening the suitability of antioxidants; various sources of free radicals are used. The method is rapid and simple and does not require any expensive equipment.

The end of the induction period may be measured in different ways, such as on the basis of oxygen absorption or decrease of oxygen pressure, weight increase [157], increase of peroxide value, determination of conjugated dienes, or increase of 2-thiobarbituric acid reactive substances. As was already mentioned, the AOM and Rancimat methods are based on the formation of lower fatty acids. The best method is the determination of changes in the sensory value, but the method requires a great deal of time and trained personnel. For the evaluation of the rancidity degree, the GLC determination of volatile oxidation

products, such as pentane, hexanal, or 2,4-decadienals, which are responsible for off-flavors, could be used instead of the time-consuming and expensive sensory analysis. The HPLC determination of total oxidized products is not sufficiently sensitive for determination of induction period, but may be used in frying tests. The method used for the determination of antioxidant activity should be operated under conditions very similar to those of the real application.

#### 11.4.3 Alternative Methods for Stabilization of Foods

Strong tendencies exist to reduce the concentration of antioxidants in foods. A useful way is to combine primary antioxidants (phenolic substances) with synergists (usually with the GRAS status). The antioxidant effect required by the producer and customers could thus be obtained with lower addition of a primary antioxidant. Many examples have been published, e.g., by Banias et al. [157]. Theoretically, it is possible to prepare stable foods without the addition of antioxidants. The easiest way is to modify the recipe to include components rich in natural antioxidants and to exclude components rich in polyunsaturated lipids. Another method is to prevent the access of oxygen, e.g., by impermeable packaging, often combined with packaging in a vacuum or in an inert gas, such as nitrogen. Oxygen may be removed by addition of oxygen scavengers such as a combination of D-glucose and glucose oxidase. Storage at very low temperatures may be recommended too. Nevertheless, there is a danger that when water freezes, ice crystals are produced and the product becomes dry; under these conditions, the protective layer of hydrated proteins is damaged and the lipid fraction leaks from the natural emulsions or liposomes, so that lipids become exposed to air oxygen. The rapid turnover of foods, possible in computerized food store facilities, effectively eliminates the necessity of longer storage with the addition of antioxidants.

---

### 11.5 Future Trends

In the near future, it is possible that the application of synthetic antioxidants will decrease still further and that of natural antioxidants will increase. In the more remote future, it is possible that consumers will become more willing to accept safe synthetic antioxidants as a rational alternative to natural antioxidants. Eventually the use of antioxidants will be gradually eliminated, at least partially.

---

### References

1. A. Scanlon, L. A. Sather, and E. A. Day, Contribution of free fatty acids to the flavour of rancid milk, *J. Dairy Sci.* 48:1582, 1965.
2. B. Kellard, D. M. Bushfield, and J. L. Kinderlerer, Volatile off-flavour compounds in desiccated coconut, *J. Sci. Food Agric.* 36:415, 1985.
3. J. Pokorný, Fats, oils and other lipids, In *Chemical Changes During Food Processing* (J. Davídek, J. Velíšek, and J. Pokorný, Eds.), Elsevier, Amsterdam, 1990, p. 169.
4. A. Kamal-Eldin, *Lipid Oxidation Pathways*, AOCS Press, Champaign, IL, 2003.
5. N. A. Porter, S. E. Caldwell, and K. A. Mills, Mechanism of free radical oxidation of unsaturated lipids, *Lipids* 30:277, 1995.
6. H. W.-S. Chan, Ed., The mechanism of autoxidation, *Autoxidation of Unsaturated Lipids*, Academic Press, London, 1987, p. 1.
7. J. Pokorný, Major factors affecting the autoxidation of lipids, In *Autoxidation of Unsaturated Lipids* (H. W.-S. Chan, Ed.), Academic Press, London, 1987, p. 141.
8. H. W. Gardner, Lipoxygenase as a versatile biocatalyst, *JAOCs* 73:1347, 1996.
9. G. Piazza, *Lipoxygenase and Lipoxygenase Pathway Enzymes*, AOCS Press, Champaign, IL, 1996.
10. W. Grosch, Reactions of hydroperoxides—products of low molecular weight, In *Autoxidation of Unsaturated Lipids* (H. W.-S. Chan, Ed.), Academic Press, London, 1987, p. 95.
11. K. Warner, Sensory evaluation of oils and fat-containing foods, In *Methods to Assess Quality and Stability of Oils and Fat-Containing Foods* (K. Warner and N. A. M. Eskin, Eds.), AOCS Press, Champaign, IL, 1995, p. 49.
12. P. J. White, Conjugated diene, anisidine value, and carbonyl value analyses, In *Methods to Assess Quality and Stability of Oils and Fat-Containing Foods* (K. Warner and N. A. M. Eskin, Eds.), AOCS Press, Champaign, IL, 1996, p. 159.



13. R. Marcuse and J. Pokorný, Modified TBA test: higher correlation with sensory evaluation of oxidative rancidity by modified TBA test, *Fat Sci. Technol.* 96:185, 1994.
14. R. Przybylski and N. A. M. Eskin, Methods to measure volatile compounds and flavor significance of volatile compounds, In *Methods to Assess Quality and Stability of Oils and Fat-Containing Foods* (K. Warner and N. A. M. Eskin, Eds.), AOCS Press, Champaign, IL, 1995, p. 107.
15. P. B. Addis, Occurrence of lipid oxidation products in foods, *Food Chem. Toxicol.* 24:1021, 1986.
16. H. W. Gardner, Lipid hydroperoxide reactivity with proteins and amino acids, *J. Agric. Food Chem.* 27:220, 1979.
17. J. Pokorný, Flavor chemistry of deep fat frying in oil, In *Flavor Chemistry of Lipid Foods* (D. B. Min and T. H. Smouse, Eds.), AOCS Press, Champaign, IL, 1989, p. 113.
18. D. G. Bradley and D. B. Min, Singlet oxygen oxidation of foods, *Crit. Rev. Food Sci.* 31:211, 1992.
19. J. Pospíšil, Antioxidants and related stabilizers, In *Oxidation Inhibition in Organic Materials* (J. Pospíšil and P. P. Klemchuk, Eds.), CRC Press, Boca Raton, FL, 1989, p. 33.
20. A. Hopia, S.-W. Huang, and E. N. Frankel, Effect of  $\alpha$ -tocopherol and Trolox on the decomposition of methyl linoleate hydroperoxides, *Lipids* 31:357, 1996.
21. M. T. Satue, S.-W. Huang, and E. N. Frankel, Effect of natural antioxidants in virgin olive oils on oxidative stability of refined, bleached and deodorized olive oil, *JAOCS* 72:1617, 1996.
22. B. Freis, *Natural Antioxidants in Human Health and Disease*, Academic Press, San Diego, 1994.
23. L. Packer, M. Hiramatsu, and T. Yoshikawa, *Antioxidant Food Supplementation in Human Health*, Academic Press, San Diego, 1999.
24. L. Packer and A. S. H. Ong, *Biological Oxidants and Antioxidants. Molecular Mechanisms and Health Effects*, AOCS Press, Champaign, IL, 1998.
25. O. I. Aruoma, Assessment of potential prooxidant and antioxidant actions, *JAOCS* 73:1617, 1996.
26. E. Niki, N. Noguchi, H. Tsuchihashi, and N. Gotoh, Interaction among vitamin C, vitamin E and  $\beta$ -carotene, *Am. J. Clin. Nutr.* 62:1322S, 1995.
27. E. N. Frankel, A. L. Waterhouse, and P. L. Teissedre, Principal phenolic phytochemicals in selected California wines and their antioxidant activity in inhibiting oxidation of human low-density lipoproteins, *J. Agric. Food Chem.* 43:890, 1995.
28. O. I. Aruoma, Characterization of drugs as antioxidant prophylactics, *Free Radical Biol. Med.* 20:675, 1996.
29. R. J. O'Brien, Oxidation of lipids in biological membranes and intracellular consequences, In *Autoxidation of Unsaturated Lipids* (H. W.-S. Chan, Ed.), Academic Press, London, 1987, p. 233.
30. K. Kikuyawa, A. Kunugi, and T. Kurechi, Chemistry and implications of degradation of phenolic antioxidants, *Food Antioxidants*, Elsevier, Barking, 1990, p. 65.
31. M. Mäkinen, A. Kamal-Eldin, A.-M. Lampi, and A. Hopia,  $\alpha$ -,  $\gamma$ - and  $\delta$ -Tocopherols as inhibitors of isomerization and decomposition of *cis*, *trans* methyl linoleate hydroperoxides, *Eur. J. Lipid Sci. Technol.* 103:286, 2001.
32. J. Pokorný and Š. Schmidt, In The impact of food processing in phytochemicals: the case of antioxidants, *Phytochemical Functional Foods* (I. Johnson and G. Williamson, Eds.), Woodhead Publishing, Cambridge, UK, 2003, p. 298.
33. S. Therisson, F. Gunstone, and R. Hardy, The antioxidant properties of ethoxyquin and of some of its oxidation products in fish oil and meal, *JAOCS* 69:806, 1992.
34. L. Kouřimská, J. Pokorný, and G. Tirtzitis, The antioxidant activity of 2,6-dimethyl-3,5-diethoxycarbonyl-1,4-dihydropyridine in edible oils, *Nahrung* 37:91, 1993.
35. J. Pokorný, Stabilization of foods, In *Oxidation Inhibition of Organic Materials, Vol. I* (J. Pospíšil and P. Klemchuk, Eds.), CRC Press, Boca Raton, FL, 1989, p. 347.
36. J. F. Hudson, *Food Antioxidants*, Elsevier Applied Science, London, 1990.
37. K. Omura, Antioxidant synergism between butylated hydroxyanisole and butylated hydroxytoluene, *JAOCS* 72:1565, 1993.
38. M. Raccachi, The antimicrobial activity of phenolic antioxidants in foods, *J. Food Safety* 6:141, 1984.
39. J. Pokorný, Natural antioxidants for food use, *Trends Food Sci. Technol.* 2:223, 1991.
40. J. Löliger, Natural antioxidants for the stabilization of foods, In *Flavor Chemistry* (D. B. Min and T. Smouse, Eds.), AOCS, Champaign, IL, 1989, p. 302.
41. A. Kasuga, Y. Ayonagi, and T. Sugahara, Antioxidant activities of edible plants, *Nippon Shokuhin Kogyo Gakkaishi* 35:828, 1988.
42. F. Shahidi, Antioxidants in food and food antioxidants, *Nahrung* 44:158, 2000.
43. K. Herrmann, Hydroxyzimtsäuren und Hydroxybenzoesäuren enthaltende Naturstoffe in Pflanzen, *Forstsch. Chem. Org. Naturst.* 35:73, 1978.

44. J.-G. Shen, B.-L. Zhao, M.-F. Li, Q. Wan, and W.-J. Xin, Inhibitory effect of *Gingko biloba* extract on oxygen free radicals, nitric oxide, and myocardial injury in isolated ischemic-reperfusion hearts, *Proc. Int. Symp. Natural Antioxidants*, AOCS Press, Champaign, IL, 1995, p. 453.
45. E. P. Oliveto, Nordihydroguaiaretic acid. *Chem. Ind.* 2:677, 1972.
46. C. J. Dillard, V. C. Gavino, and A. L. Tappel, Relative antioxidant effectiveness of  $\alpha$ -tocopherol and  $\gamma$ -tocopherol in iron loaded rat, *J. Nutr.* 113:2266, 1983.
47. F. V. Timmermann, Tocopherole-Antioxidative Wirkung bei Fetten und Ölen, *Fat Sci. Technol.* 92:201, 1990.
48. C. Mariani and G. Bellan, Sulla presenza di tocoferoli, diidrotocoferoli, tocodienoli, tocotrienoli negli oli vegetabili, *Riv. Ital. Sost. Grasse* 73:533, 1996.
49. N. Olejnik, M. Gogolewski, and M. Nogala-Kalucka, Isolation and some properties of plastochromanols, *Nahrung* 41:109, 1997.
50. A.-M. Lampi, A. Hopia, and V. Piironen, Antioxidant activity of minor amounts of  $\gamma$ -tocopherol in natural triacylglycerols, *J. Am. Oil Chem. Soc.* 74:549, 1997.
51. R. J. Hamilton, C. Kalu, F. B. Padley, and J. H. Pierce, Effects of tocopherols, ascorbyl palmitate, and lecithin on autoxidation of fish oil, *J. Am. Oil Chem. Soc.* 75:813, 1998.
52. A. Kamal-Eldin and L.-A. Appelqvist, The chemistry and antioxidant properties of tocopherols and tocotrienols, *Lipids* 31:671, 1996.
53. C. Hall III, Sources of natural antioxidants: oilseeds, nuts, cereals, In *Antioxidants in Food: Practical Applications*, (J. Pokorný, N. Yanishlieva, and M. Gordon, Eds.), Woodhead Publishing, Cambridge, 2001, p. 159.
54. D. Boskou, Olive oil composition, In *Olive Oil Chemistry and Technology* (D. Boskou, Ed.), AOCS Press, Champaign, IL, 1996, p. 52.
55. D. M. Colquhoun, B. J. Hieks, and A. W. Reed, Phenolic content of olive oil is reduced in extraction and refining, *J. Clin. Nutr.* 5:105, 1996.
56. N. Cortesi and P. Rovellini, Oxidative status of virgin olive oil: effect of natural antioxidants, *Olivae* 101:27, 2004.
57. A. Kamal-Eldin and L.-A. Appelqvist, Variations in the composition of sterols, tocopherols and lignans in seed oils from *Sesamum* species, *JAOCS* 71:149, 1994.
58. Y. Fukuda and M. Namiki, Recent studies on sesame seed and oil, *Nippon Shokuhin Kogyo Gakkaishi* 35:552, 1988.
59. F. Shahidi, R. Amarowicz, H. A. Abou-Gharbia, and A. A. Y. Shehata, Endogenous antioxidants and stability of sesame oil as affected by pressing and storage, *JAOCS* 74:143, 1997.
60. S. H. Cho, B. Y. Park, J. H. Kim, K. M. Park, S. N. Ryu, and J. M. Lee, Effects of sesame lignan extract on linoleic acid, lipid oxidation, color and textural properties of ground pork, and sausage products, *J. Food Lipids* 11:131, 2004.
61. A. H. Y. Abdel, Flavonoids of cottonseeds and peanuts as antioxidants, *Riv. Ital. Sost. Grasse* 62:147, 1985.
62. P. D. Duh, D.-B. Yeh, and G.-C. Yen, Extraction and identification of an antioxidative component from peanut hulls, *JAOCS* 69:814, 1992.
63. C. C. Whittern, E. E. Miller, and D. E. Pratt, Cottonseed flavonoids as lipid antioxidants, *J. Am. Oil Chem. Soc.* 61:1075, 1984.
64. D. E. Pratt, Natural antioxidants from soybeans and other oilseeds, In *Autoxidation of Food and Biological Systems* (M. C. Simic and M. Karel, Eds.), Plenum Press, New York, 1980, p. 283.
65. K. Murata, Antioxidative stability of tempeh, *J. Am. Oil Chem. Soc.* 65:799, 1988.
66. Š. Schmidt, I. Niklová, J. Pokorný, P. Farkaš, and S. Sekretár, Antioxidant activity of evening primrose phenolics in sunflower and rapeseed oils, *Eur. J. Lipid Sci. Technol.* 105:427, 2003.
67. F. Shahidi, R. Amarowicz, Y. He, and M. Wettasinghe, Antioxidant activity of phenolic extracts of evening primrose, *J. Food Lipids* 4:75, 1997.
68. R. Amarowicz, M. Karamać, J. P. D. Wanasundara, and F. Shahidi, Antioxidant activity of hydrophobic phenolic fractions of flaxseed, *Nahrung* 41:178, 1997.
69. K. J. Duve and P. J. White, Extraction and identification of antioxidants in oats, *J. Am. Oil Chem. Soc.* 68:365, 1991.
70. T. Wang, K. B. Hicks, and R. Moreau, Antioxidant activity of phytosterols, oryzanol, and other phytosterol conjugates, *JAOCS* 79:1201, 2002.
71. A. Troszyńska, A. Bednarska, A. Latos, and H. Kozłowska, Polyphenolic compounds in the seed coat of legume seeds, *Pol. J. Food Nutr. Sci.* 6:37, 1997.
72. T. Tsuda, T. Osawa, T. Nakayama, S. Kawakishi, and K. Ohshima, Antioxidant activity of pea bean extract, *JAOCS* 70:909, 1993.

73. M. Karamać, R. Amarowicz, S. Weidner, and F. Shahidi, Antioxidant activity of phenolic fraction of white bean (*Phaseolus vulgaris*), *J. Lipid Foods* 11:165, 2004.
74. R. Fernández-Orozco, H. Zieliński, and M. K. Piskula, Contribution of low-molecular weight antioxidants to the antioxidant capacity of raw and processed lentil seeds, *Nahrung* 47:291, 2003.
75. N. V. Yanishlieva, and I. M. Heinonen, Sources of natural antioxidants: vegetables, fruits, herbs, spices and teas, In *Antioxidants in Food: Practical Applications* (J. Pokorný, N. Yanishlieva, and M. Gordon, Eds.), Woodhead Publishing, Cambridge, UK, 2001, p. 210.
76. I. Nagamine, H. Sakurai, H. T. T. Nguyen, M. Miyahara, J. Parkányiová, Z. Réblová, and J. Pokorný, Antioxidant activity of acerola extracts, *Czech J. Food Sci.* 22(Special):155, 2004.
77. J. F. Alcolea, A. Cano, M. Acosta, and B. Arnao, Hydrophilic and lipophilic antioxidant activities of grapes, *Nahrung* 46:353, 2002.
78. A. Lugasi and J. Hóvári, Antioxidant properties of commercial alcoholic and nonalcoholic beverages, *Nahrung* 47:79, 2003.
79. S. S. K. W. Siriwardhana and F. Shahidi, Antiradical activity of extracts of almond and its by-products, *JAOCS* 79:903, 2002.
80. M. Oyaizu, H. Ogihara, K. Sekemoto, and U. Naruse, Antioxidant activity of extracts from hop, *Yukagaku* 42:1003, 1993.
81. D. Jurdi-Haldeman, J. H. MacNeil, and D. M. Yared, Antioxidant activity of onion and garlic juices in stored cooked ground lamb, *J. Food Prot.* 50:411, 1987.
82. T. Hirose, M. Matsuzawa, I. Irie, H. Kawai, and Y. Hosogai, On the antioxidative activities of herbs and spices, *Nippon Shokuhin Kogyo Gakkaishi* 35:631, 1988.
83. D. A. Balentine and I. Paetau-Robinson, Tea as a source of dietary antioxidants with potential role in prevention of chronic diseases, In *Herbs, Botanicals, and Teas* (G. Mazza and B. D. Oomah, Eds.), CRC Press, Boca Raton, FL, p. 265.
84. B. Xie, H. Shi, Q. Chen, and C. T. Ho, Antioxidant properties of fractions and polyphenol constituents from green, oolong and black teas, *Life Sci.* 17:77, 1993.
85. Z. Y. Chen, P. T. Chan, H. M. Ma, K. P. Fung, and J. Wang, Antioxidative effect of ethanol tea extracts on oxidation of canola oil, *JAOCS* 73:375, 1996.
86. T. Matsuzaki and Y. Hara, Antioxidative activity of tea leaf catechins, *Nippon Shokuhin Kogyo Gakkaishi* 59:129, 1985.
87. L.-N. Li, Chemical studies of natural antioxidants from traditional Chinese medicines, In *Proceedings of International Symposium on Natural Antioxidants* (L. Packer, M. G. Traber, and W. Xin, Eds.), AOCS Press, Champaign, IL, p. 117.
88. K. Fujimoto, H. Omura, and T. Kaneda, Screening for antioxygenic compounds in marine algae and bromophenols as effective principles in a red alga, *Bull. Japan. Soc. Sci. Fish.* 51:1139, 1985.
89. P.-J. Park, F. Shahidi, and Y.-J. Jeon, Antioxidant activities of enzymatic extracts from an edible seaweed *Sargassum horneri* using ESR spectrometry, *J. Food Lipids* 11:15, 2004.
90. N. Naketani, *Antioxidant and Antimicrobial Constituents of Herbs and Spices*, Elsevier, Amsterdam, 1994.
91. O. I. Aruoma, B. Halliwell, R. Aeschbach, and J. Löliger, Antioxidant and pro-oxidant properties of active rosemary constituents: carnosol and carnosic acid, *Xenobiotica* 22:257, 1992.
92. M. E. Cuvelier, H. Richard, and C. Berset, Antioxidant activity and phenolic composition of pilot plant and commercial extracts of sage and rosemary, *JAOCS* 73:645, 1996.
93. M. Miškusová, Z. Réblová, L. Trojáková, H. T. T. Nguyen, A. Zainuddin, R. Venskutonis, D. Gruzdiené, and J. Pokorný, Applications of plant extracts as antioxidants in fats, oils and emulsions, *Czech J. Food Sci.* 18(Special):148, 2000.
94. I. D. Lee, Y. S. Kim, and C. R. Ashmore, Antioxidant property in ginger rhizome and its application to meat products, *J. Food Sci.* 51(11):20, 1986.
95. M. Takácssová, A. Příbela, and M. Faktorová, Study of antioxidant effects of thyme, sage, juniper and oregano, *Nahrung* 39:241, 1995.
96. H. Kikuzaki and N. Nakatani, Structure of a new antioxidative phenolic acid from oregano, *Agr. Biol. Chem.* 53:519, 1989.
97. N. V. Yanishlieva and E. M. Marinova, Antioxidant activity of selected species of the family *Lamiaceae* grown in Bulgaria, *Nahrung* 39:458, 1995.
98. S. Ivanov, A. Seher, and H. Schiller, Antioxidants in fatty oil of *Foeniculum vulgare* Miller, 2, *Fette, Seifen, Anstrichm.* 81:105, 1979.
99. R. S. Faraq, A. Z. M. A. Badei, and G. S. A. El-Baroty, Influence of thyme and clove essential oils in cottonseed oil oxidation, *J. Am. Oil Chem. Soc.* 66:800, 1989.

100. S. Chevolleau, J. F. Mallet, E. Ucciani, J. Gamisano, and M. Gruber, Antioxidant activity in leaves of some Mediterranean plants, *JAOCS* 69:1269, 1992.
101. N. Nakatani, Antioxidative compounds from spices, *Nippon Nogei Kagaku Kaishi* 62:170, 1987.
102. M. H. Gordon and X. C. Weng, Antioxidant properties of extracts from tanshen, *Food Chem.* 44:119, 1992.
103. X. C. Weng and M. H. Gordon, Antioxidant activity of quinones extracted from tanshen (*Salvia orrhiza* Burge), *J. Agr. Food Chem.* 40:1331, 1992.
104. J. W. Wu, M.-H. Lee, C. T. Ho, and S. S. Chang, Elucidation of the chemical structure of natural antioxidants from rosemary, *J. Am. Oil Chem. Soc.* 59:339, 1982.
105. S. S. Chang, B. Matijasevic, O. A. L. Hsieh, and C. L. Huang, Natural antioxidants from rosemary and sage, *J. Food Sci.* 42:1102, 1978.
106. V. Holzmánová, Kyselina rosmarinová a její biologická aktivita, *Chem. Listy* 90:486, 1995.
107. S. L. Richheimer, M. W. Bernart, G. A. King, M. C. Kent, and D. T. Bailey, Antioxidant activity of lipid-soluble phenolic diterpenes from rosemary, *JAOCS* 73:507, 1996.
108. H. F. Liu, A. M. Booren, J. I. Gray, and R. L. Czechel, Antioxidant efficacy of oleoresin rosemary and sodium tripolyphosphate in restructured pork steaks, *J. Food Sci.* 57:803, 1992.
109. K. D. Ekonomou, V. Oreopoulou, and C. D. Thomopoulos, Antioxidant activity of some plant extracts of the family *Labiatae*, *J. Am. Oil Chem. Soc.* 68:109, 1991.
110. R. E. Kramer, Antioxidants in clove, *J. Am. Oil Chem. Soc.* 62:111, 1985.
111. M. Takácsová and A. Příbela, Antioxidant effect of some phytoncides from spices, *Bull. Potravn. Výsk.* 32:67, 1993.
112. N. Noguchi, E. Komuro, E. Niki, and R. L. Wilson, Action of curcumin as an antioxidant against lipid peroxidation, *Yukagaku* 43:1045, 1994.
113. S. A. Vekari, V. Oreopoulou, C. Tzia, and C. D. Thomopoulos, Oregano flavonoids as lipid antioxidants, *J. Am. Oil Chem. Soc.* 70:483, 1993.
114. Y. H. Kim, H. K. Yoon, and K. S. Chang, The contents of phenolic compounds and antioxidant activities of various year stored red and white ginsengs, *Res. Rep. Agr. Sci. Technol.* 11:295, 1984.
115. S. Phelps and W. S. Harris, Garlic supplementation and lipoprotein oxidation susceptibility, *Lipids* 28:475, 1973.
116. M. Takácsová, M. Drdák, I. Šimek, and P. Szalai, Investigation of antioxidant effects of garlic extract in vegetable oil, *Potravn. Vědy* 8:141, 1990.
117. H. S. Lee and A. S. Scallany, The influence of vitamin E and selenium on lipid peroxidation and aldehyde dehydrogenase activity in rat liver and tissue, *Lipids* 29:345, 1994.
118. C. K. Chow, V. L. Tatum, C. C. Yeh, N. H. Maynard, W. Ibrahim, G. Bruckner, G. A. Boissoneault, and C. B. Hong, Antioxidants function of carnosine, a natural histidine-containing dipeptide, In *Proceedings of International Symposium on Natural Antioxidants* (L. Packer, Ed.), AOCS Press, Champaign, IL, 1996, p. 155.
119. W. Janitz, J. Korczak, and A. Ciepiewska, Ocena właściwości przeciwutleniających i jego pochodnych w mięsie odzyskanym mechanicznie z drobiu, *Roczn. Akad. Roln. Poznaniu* 233:37, 1992.
120. E. M. Marinova and N. V. Yanishlieva, On the activity of ascorbyl palmitate during the autoxidation of two types of lipid systems in the presence of  $\alpha$ -tocopherol, *Fat Sci. Technol.* 94:448, 1992.
121. S. P. Aubourg, F. Pérez-Alonso, and J. M. Gallardo, Studies on rancidity inhibition in frozen horse mackerel (*Trachurus trachurus*) by citric and ascorbic acids, *Eur. J. Lipid Sci. Technol.* 106:232, 2004.
122. Z. Réblová and J. Pokorný, Effect of lecithin on the stabilization of foods, In *Phospholipids: Characterization, Metabolism, and Novel Biological Applications* (G. Cevc and F. Paltauf, Eds.), AOCS Press, Champaign, IL, 1995, p. 378.
123. T. Segawa, S. Hara, and Y. Totani, Synergistic effect of phospholipids for tocopherol, *Yukagaku* 43:515, 1994.
124. Y. Totani, Antioxidant effect of nitrogen-containing phospholipids on autoxidation of polyenoic oil, *Yukagaku* 46:3, 1997.
125. B. J. F. Hudson and J. I. Lewis, Polyhydroxy flavonoid antioxidants for edible oils: phospholipids as synergists, *Food Chem.* 10:111, 1983.
126. E. Flaczyk, R. Amarowicz, and J. Korczak, Antioxidant activity of protein hydrolyzates from by-products of the food industry, *J. Food Lipids* 10:129, 2003.
127. S. H. Lee and D. B. Min, Effects, quenching mechanisms, and kinetics of carotenoids in chlorophyll-sensitized photooxidation of soybean oil, *J. Agr. Food Chem.* 38:1630, 1990.
128. K. Fukuzawa, Y. Inokami, A. Tokumura, J. Terao, and A. Suzuki, Rate constants for quenching singlet oxygen and activities for inhibiting lipid peroxidation of carotenoids and  $\alpha$ -tocopherol in liposomes, *Lipids* 33:751, 1998.

129. K. H. Lee, M. Y. Jung, and S. Y. Kim, Quenching mechanism and kinetics of ascorbyl palmitate for the reduction of photosensitized oxidation of oils, *JAOCS* 74:1053, 1997.
130. C. Y. W. Ang and D. Hamm, Effect of salt and sodium tripolyphosphate on shear, thiobarbituric acid, sodium and phosphorus values of hot-stripped broiler breast meat, *Poultry Sci.* 65:1532, 1986.
131. H. Kusaka, K. Tokue, K. Morino, S. Ohta, and K. Yokomizo, Influence of silicone oil on the dissolution of iron into heated fats and oils, *Yukagaku* 35:1005, 1986.
132. V. Stankova and S. Ivanov, Studies on the efficient complex stabilization of lard, *Meat Ind.* 17:32, 1984.
133. W. Heimann and H. v. Pezold, Über die prooxygene Wirkungen von Antioxygenen, *Fette, Seifen, Anstrichm.* 59:330, 1957.
134. E. N. Frankel, S.-W. Huang, J. Kanner, and J. B. German, Interfacial phenomena in the evaluation of antioxidants, *J. Agr. Food Chem.* 42:1054, 1994.
135. N. Watanabe, S. Hara, and Y. Totani, Antioxidative effects of phospholipids in an emulsifying system, *Yukagaku* 46:21, 1997.
136. E. N. Frankel, S. W. Huang, R. Aeschbach, and E. Prior, Antioxidant activity of rosemary extract and its constituents in bulk oil and oil-in-water emulsions, *J. Agric. Food Chem.* 44:131, 1996.
137. J. Löfliger, The use of antioxidants in foods, In *Free Radicals and Food Additives* (O. I. Aruoma and B. Halliwell, Eds.), Taylor and Francis, London, 1991, p. 121.
138. V. N. Wade, R. El-Tahriri, and R. J. M. Crawford, The autoxidative stability of anhydrous milk fat with and without antioxidants, *Milchwissenschaft* 41:479, 1986.
139. J. Pokorný, J. Davídek, V. Chocholatá, J. Pánek, H. Bulantová, W. Janitz, H. Valentová, and M. Vierecklová, Interactions of oxidizing ethyl linoleate with collagen, *Nahrung* 34:159, 1990.
140. T. P. Labuza and W. M. Breene, Application of active packaging for improvement of shelf life and nutritional quality of fresh and extended shelf-life foods, *J. Food Proc. Pres.* 13:1, 1989.
141. K. Terada and Y. Naito, Migration of BHT through airspace in food package system, *Packag. Technol. Sci.* 2:165, 1989.
142. R. Haigh, Safety and stressivity of antioxidants: EEC approval, *Food Chem. Technol.* 24:1031, 1986.
143. D. L. Madhavi and D. K. Salunkhe, Toxicological aspects of food antioxidants, In *Food Antioxidants* (D. L. Madhavi, S. S. Deshpande, and D. K. Salunkhe, Eds.), Marcel Dekker, New York, 1995, p. 371.
144. K. Roberts and S. Dilli, Analytical chemistry of synthetic food antioxidants, *Analyst* 112:933, 1987.
145. K. Míková, The regulation of antioxidants in food, In *Antioxidants in Food: Practical Applications*, (J. Pokorný, N. Yanishlieva, and M. Gordon, Eds.), Woodhead Publishing, Cambridge, UK, 2001, p. 267.
146. *Official Methods of AOAC International*, 16th ed., 3rd rev., AOAC, Washington, DC, 1997.
147. *AOCS Official Methods and Recommended Practices*, 5th ed., AOCS Press, Champaign, IL, 1997.
148. *IUPAC Standard Methods for the Analysis of Oils, Fats and Derivatives*, Blackwell, Oxford, 1987.
149. C. H. van Petegem and D. A. Kekeyser, Systematic identification of antioxidants in lards, shortenings and vegetable oils by TLC, *J. Ass. Off. Anal. Chem.* 64:1331, 1981.
150. S. S. Atuma, Electrochemical determination of vitamin E in margarine, butter and palm oil, *J. Sci. Food Agr.* 26:393, 1975.
151. M. H. Gordon, Measuring antioxidant activity, In *Antioxidants in Food: Practical Applications*, (J. Pokorný, N. Yanishlieva, and M. Gordon, Eds.), Woodhead Publishing, Cambridge, UK, 2001, p. 71.
152. P. J. Wan, Accelerated stability methods, In *Methods to Assess Quality and Stability of Oils and Fat-Containing Foods* (K. Warner and N. A. M. Eskin, Eds.), AOCS Press, Champaign, IL, 1994, p. 179.
153. W. J. Woestenberg and J. Zaalberg, Determination of the oxidative stability of edible oils—interlaboratory test with the automated Rancimat method, *Fette, Seifen, Anstrichmittel* 88:53, 1986.
154. G. Reynhout, The effect of temperature on the induction time of stabilized oil, *J. Am. Oil Chem. Soc.* 68:483, 1991.
155. E. N. Frankel, In search of better methods to evaluate natural antioxidants and oxidative stability in food lipids, *Trends Food Sci. Technol.* 4:220, 1993.
156. J. A. García-Mesa, M. D. Luque de Castro, and M. Valcárcel, Factors affecting the gravimetric determination of the oxidative stability of oils, *JAOCS* 70:245, 1993.
157. C. Baniás, V. Oreopoulou, and C. D. Thomopoulos, The effect of primary antioxidants and synergists on the activity of plant extracts in lard, *J. Am. Oil Chem. Soc.* 69:520, 1992.

# 12

## *pH in Food Preservation*

Mohammad Shafiur Rahman

### CONTENTS

12.1	Effects of pH on Microorganisms and Enzymes .....	287
12.1.1	pH Values of Foods .....	287
12.1.2	Effects of pH on Microorganisms .....	289
12.1.2.1	pH Limits for Microbial Growth .....	289
12.1.2.2	Mode of Action of pH .....	290
12.1.2.3	Effects of pH on Heat Stability of Microorganisms .....	292
12.1.2.4	Enhancement of the Effects of Preservatives .....	292
12.1.3	pH Effects on Enzymes .....	293
12.2	Effects of pH on Food Components .....	293
12.2.1	Effects of pH on Gel Formation .....	293
12.2.2	Effects of pH on Proteins .....	294
12.2.3	Effects of pH on Vitamin Stability .....	295
12.3	Methods of Controlling pH in Foods .....	295
References	.....	296

## 12.1 Effects of pH on Microorganisms and Enzymes

### 12.1.1 pH Values of Foods

The importance of pH on food stability and food preservation is well documented. The term pH is the symbol for hydrogen ion concentration. The hydrogen ion concentration of a food is a controlling factor in regulating many chemical, biochemical, and microbiological reactions. Hydrogen-ion concentration is expressed in moles and pH is the negative log ion concentration. The pH scale ranges from 0 to 14. A neutral solution has a pH of 7.0. A lower scale reading indicates an acid solution, and a value above 7.0 indicates an alkaline solution. The pH scale is logarithmic rather than linear in character. Therefore, a pH of 3.0 is 10 times as acidic as a pH of 4.0 [28].

The pH values of different food products are given in Tables 12.1 and 12.2. In general, fruits, soft drinks, vinegar, and wine have low pH values at which most bacteria will not grow, and these products have good keeping qualities. Most meats, seafood, and raw milk have pH values greater than 5.6, which make them susceptible to bacterial spoilage and the possible growth of pathogens. Vegetables also have fairly high pH values and are more prone to bacterial spoilage [12]. The pH may vary considerably even within any given product. Some of the most important factors affecting the actual pH values of a product are [28]: variety of cultivar, maturity, seasonal variations owing to growing conditions, geographical areas, handling and holding practices prior to processing, and processing variables.

TABLE 12.1

pH Values of Plant-Origin Foods

Food	pH	Reference	Food	pH	Reference
Apples	2.90–3.30	12	Honey	3.70–3.78	40
	3.33–3.84	40	Lemon juice	1.98–2.40	40
Apple sauce	3.09–3.40	40	Lettuce	5.89–6.09	40
Apricots	4.18–4.67	40	Lime juice	2.00–2.25	40
Apricots (canned)	3.42–3.47	40	Melons	5.50–6.60	40
Asparagus (cooked)	6.03–6.10	40	Olives (green)	3.38–4.00	40
Asparagus (canned)	5.20–5.32	40	Olives (ripe)	6.80	40
Bananas	5.00–5.29	40	Onions	5.32–5.85	40
	4.50–4.70	12	Orange juice	3.60–4.30	12
Beans (cooked)	5.73–6.20	40	Orange juice	3.60–4.30	12
Beans (canned)	4.62–4.72	40	Oranges	3.30–4.30	40
Beets (cooked)	5.23–5.90	40	Peaches	3.30–4.05	40
Beets (canned)	4.92–4.98	40	Peaches (canned)	3.70–3.82	40
Bread (white)	5.29–5.65	40	Pears (Bartlett)	3.49–4.08	40
Bread (wholemeal)	5.47–5.61	40	Pears (canned)	4.00–4.08	40
Brussels sprouts	6.00–6.15	40	Peas (cooked)	6.22–6.88	40
Butter (peanut)	6.28	40	Peas (canned)	5.71–6.00	40
Cabbage	5.40–6.00	12	Pineapple	3.20–3.64	40
Cabbage (green)	5.79–6.29	40	Pineapple (canned)	3.39–3.50	40
Cabbage (cooked)	6.38–6.82	40	Plums (Blue and Damson)	2.78–2.89	40
Cantaloupe	6.17–7.13	40	Plums (red and yellow)	3.62–4.95	40
Carrots	5.88–6.00	40	Potatoes	5.40–5.90	12
	4.90–6.00	12	Quince (stewed)	3.12–3.37	40
Carrots (cooked)	5.58–5.88	40	Raspberries	3.62–3.95	40
Carrots (canned)	5.18–5.22	40	Rhubarb (stewed)	3.24–3.34	40
Cherries (red)	3.29–3.32	40	Spaghetti (cooked)	5.97–6.40	40
Cherries (black, canned)	3.82–3.93	40	Spinach (cooked)	6.60–7.18	40
Coconut	5.90–6.52	40	Strawberries	3.30–3.35	40
Corn (canned)	5.90–6.44	40	Tomatoes	3.99–4.75	40
Cucumber	5.18–5.70	40	Tomatoes (canned)	4.10–4.28	40
Figs (canned)	4.92–5.00	40	Vegetable soup (canned)	5.16	40
Grapefruit	3.22–3.70	40	Vinegar	3.12	40
Grapefruit juice	3.00	12	Watermelon	5.18–5.60	40
Grapes	2.80–3.80	40	Worcestershire sauce	3.63–3.67	40
			Yeast	5.65	40

TABLE 12.2

The pH Values of Animal-Origin Foods

Food	pH	Reference	Food	pH	Reference
Beef (broth)	6.14–6.20	40	Eggs (whole)	6.58	40
Beef (ground)	5.10–6.20	12	Eggs (white)	7.96	40
Beef (raw)	5.60	40	Eggs (yolk)	6.10	40
Buttermilk	4.41–4.83	40	Lobster	7.10–7.43	40
Butter	6.10–6.40	12	Milk	6.30–6.50	12
Cheese (Camembert)	7.44	40	Oysters	5.68–6.17	40
Cheese (cheddar)	5.90	40	Sardines	5.42–5.93	40
Cheese (cottage)	4.75–5.02	40	Shrimp	6.80–7.00	12
Cheese (Roquefort)	5.41–6.10	40	Soda crackers	5.65–7.32	40
Chicken	6.20–6.40	12	Tuna (canned)	5.92–6.10	40
Cream	6.40–6.60	40			

## 12.1.2 Effects of pH on Microorganisms

### 12.1.2.1 pH Limits for Microbial Growth

Microorganisms require water, nutrients, appropriate temperature, and pH levels for growth. Table 12.3 lists pH as single factor limits for growth of some important food spoilage and poisoning microorganisms. Minimum pH values for toxin production by *Clostridium botulinum* types A and B in canned foods are given in Table 12.4. This indicates that minimum pH levels are also dependent on the types of foods. The interaction of water activity and pH on toxin production by *Clostridium botulinum* types A and B in cooked vacuum-packed potatoes is given in Table 12.5. In general, heterotrophic bacteria tend to be least acid tolerant among common food microorganisms [12]. A pH value of 4.5 is specially important because this is the pH below which *Clostridium botulinum* is widely regarded not to grow in foods. McClure et al. [35] reviewed the factors affecting growth and toxin production of *Clostridium botulinum*. They mentioned that growth and toxin production may occur at pH values below 4.6 if there is strict anaerobiosis, a high concentration of protein, and various acidulants used. Below about pH 4.2, most other food poisoning microorganisms are well controlled,

**TABLE 12.3**

Low pH Limits or Growth Range for Microbial Growth

Microorganism	pH Range Value <sup>a</sup>	pH <sub>Inside</sub>	Reference
<i>Acetobacterium</i> sp.	2.8–4.3	4.0–6.0	12
<i>Bacillus acidocaldarius</i>	2.0–5.0	5.9–6.1	12
<i>Bacillus cereus</i>	4.9	–	47, 66
<i>Bacillus coagulans</i>	3.7	–	7
Bacteria	4–9	–	12
<i>Campylobacter jejuni</i>	5.3	–	66
<i>Clostridium botulinum</i>	4.5	–	7
<i>Clostridium botulinum</i> (proteolytic)	4.7	–	47
	4.6	–	66
<i>Clostridium botulinum</i> (nonproteolytic)	4.7	–	47
	5.0	–	66
<i>Clostridium perfringens</i>	4.5	–	7
	5.0	–	47
<i>Clostridium thermoaceticum</i>	5.0–8.0	5.7–7.3	12
<i>Enterococcus faecalis</i>	4.4–9.1	7.2–7.4	12
<i>Escherichia coli</i>	4.0	–	7
	4.4–8.7	7.5–8.2	12
	4.4	–	47
Lactic acid bacteria	3.5	–	7
<i>Listeria monocytogenes</i>	4.3	–	7, 47
<i>Lactobacillus</i> sp.	3.0	–	66
Molds	1.5–11	–	5, 12
Most <i>Bacillus</i> sp.	4.0	–	12
Most yeasts and molds	<2.0–3.0	–	12
<i>Pseudomonas</i> sp.	5.0	–	66
<i>Saccharomyces cerevisiae</i>	2.35–8.6	6.0–7.3	12
<i>Salmonella</i>	3.8	–	47
<i>Salmonella</i> serovars	4.0	–	7
<i>Salmonella</i> sp.	4.0	–	66
<i>Staphylococcus aureus</i>	4.0	–	47
<i>Staphylococcus aureus</i> (growth)	4.0	–	47
<i>Staphylococcus aureus</i> (toxin)	4.5	–	7
<i>Vibrio parahaemolyticus</i>	4.9	–	47
Yeasts	1.5–8.5	–	5
Yeasts	1.5–8	–	12
<i>Yersinia enterocolitica</i>	4.4	–	47
	4.6	–	66

<sup>a</sup> Lowest or growth; values may vary according to particular food substrate and specially in the presence of organic acids.



TABLE 12.4

Minimum pH Values for Toxin Production by *Clostridium botulinum* Types A and B in Canned Foods

Food	Minimum pH for Toxin Production
Prune pudding	5.44
	5.44
Pears	5.42
Pimientos	5.25
Pineapple rice pudding	4.94
Pork and beans	4.93
Zucchini	4.86
Vegetable juice	4.84

Source: C. T. Townsend, L. Yee, and W. A. Mercer, *Food Res.* 19:536, 1954.

TABLE 12.5

Interaction of Water Activity and pH on Toxin Production by *Clostridium botulinum* Types A and B (Proteolytic) in Cooked Vacuum-Packed Potatoes

$a_w$	pH	Days to Toxin Detection
0.980	6.10	7
0.981	5.45	7
0.977	4.83	35
0.972	6.07	7
0.973	5.50	14
0.969	4.96	35
0.959	5.74	35
0.960	5.46	>35
0.964	4.95	>35

Source: I. L. Dodds, *Appl. Environ. Microbiol.* 55:656, 1989.

but those such as lactic acid bacteria and many species of yeasts and molds grow at pH values well below this. Many weak lipophilic organic acids act synergistically with low pH to inhibit microbial growth. Thus, propionic, sorbic, and benzoic acids are most useful food preservatives [27]. *Ichthyophonus hoferi* is an internal parasite of various fish species. Its growth was observed at all pH values 3–7 from 0°C to 25°C and from 0% to 6% sodium chloride [57].

The efficacy of acids depends to a large extent on their ability to equilibrate, in their undissociated forms, across the microbial cell membrane and, in doing so, interfere with the pH gradient that is normally maintained between the inside (cytoplasm) of the cell and the food matrix surrounding it [15,21,27]. In addition to the weak lipophilic acid, other preservatives most widely used in foods include esters of benzoic acid, which are effective at higher pH values than organic acids. The inorganic acids, such as sulfate and nitrite, are most effective at reduced pH values, like the organic acids. While these preservatives are employed at hundreds to thousands of ppm levels, the acids used principally as acidulants are often employed at percentage levels [27].

In many products, such as semidry sausages and cheeses, a combination of pH and water activity is used to preserve foods. The combined inhibitory effects of pH and water activity on survival of microorganisms are clearly additive [65]. In addition to pH, the type of acid is also a factor that influences the extent of inhibition with water activity. Generally, citric and acetic acids tend to be more inhibitory in combination with water activity reduction than do hydrochloric or phosphoric acids [64]. The general effect of water activity and pH on growth of bacteria is shown in Figure 12.1 [65]. FDA's Good Manufacturing Practice Regulations (GMPR) governing the processing requirements and the classification of foods are shown in Figure 12.2. Low-acid foods packaged in hermetically sealed containers must achieve commercially sterile conditions either by retorting or a combined treatment of pasteurization and water activity or a combined treatment of pasteurization and acidification [31].

### 12.1.2.2 Mode of Action of pH

Booth and Kroll [12] from Corlett and Brown [17] summarized three regimes of action as

- Strong acids, which lower the external pH but do not themselves permeate through the cell membrane. These acids may exert their influence by the denaturing effect of low pH on enzymes present on the cell surface and by lowering of the cytoplasmic pH due to increased proton permeability when the pH gradient is very large.
- Weak acids, which are lipophilic and permeate through the membrane. The primary effect of such acids is to lower cytoplasmic pH, and the undissociated acid may have specific effects on the metabolism, which amplify the effects of the weak acid.
- Acid-potentiating ions such as carbonate, sulfate, and nitrate, which are more potent inhibitors at low pH.

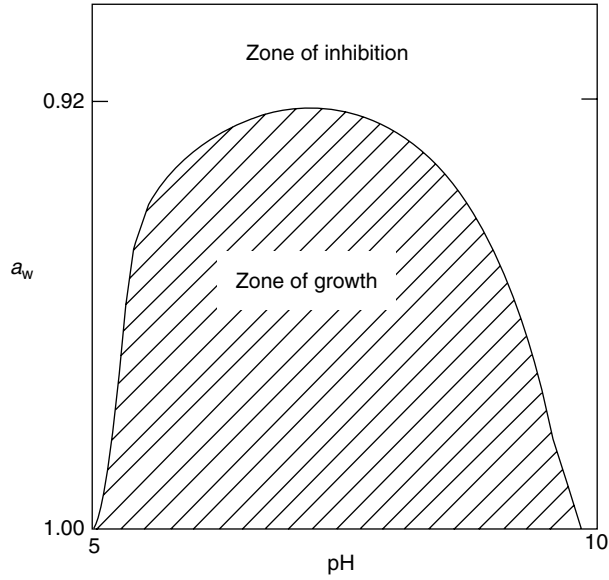


FIGURE 12.1 Interacting effects of pH and water activity on growth of bacteria.

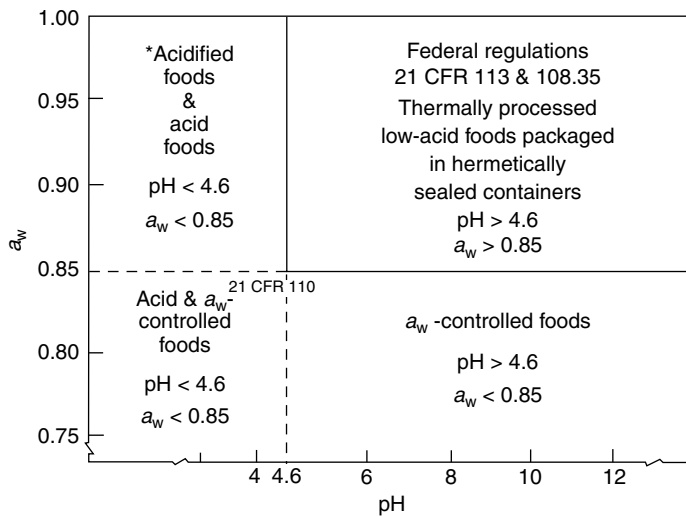


FIGURE 12.2 FDA Good Manufacturing Practice Regulations governing processing requirements and classification of foods. (From I. R. Johnston and R. C. Lin, In *Water Activity: Theory and Applications to Food* (L. B. Rockland and L. R. Beuchat, Eds.), Marcel Dekker, New York, 1987, p. 287.)

As long as the internal pH of the microorganism remains constant, the effect of external pH on growth rate must be due to (i) inactivation of one or more essential enzyme activities that are present on the outer layers of cell, i.e., the outer membrane, the cell wall, the periplasm, and the inner membrane, and (ii) reduction of transport systems for essential ions and nutrients [12].

At low external pH, the passive influx of protons under the influence of the protonmotive force could be a major problem for cells attempting to regulate their cytoplasmic pH [52]. Most bacteria possess membrane-bound proton pumps, which exclude protons from the cytoplasm to generate a transmembrane electrochemical gradient of protons, the protonmotive force. Those microorganisms that are tolerant of very low external pH, acidophilic bacteria and yeasts, have relatively low internal pH values. This may be a specific adaptation to the acidic environment [12].

The external pH is a significant effector of metabolism, often changing the pattern of enzyme synthesis and the nature of end products of metabolism. Booth and Kroll [12] concluded a reasonable generalization that cells produce acidic products when growing at alkaline external pH and neutral or basic products at external acidic pH.

A further counter to acidification of the cytoplasm is the buffering capacity provided by the acidic and basic side chains of the proteins and the phosphate groups of the nucleic acids. In general, buffering capacities in bacteria are approximately 400 nmol H<sup>+</sup>/pH unit/mg protein [11]. Booth and Kroll [12] mentioned that the buffering capacity is finite and can be overcome, for example, in the presence of high concentrations of a weak acid at low external pH.

In most microorganisms, a cytoplasmic pH close to neutrality is essential for growth. In case of some microorganisms, recovery of cells from sublethal acid injury did not require new macromolecular synthesis, in some cases extensive protein denaturation occurs in both bacterial and yeast cells and that protein synthesis is required for recovery [9,41,46]. DNA damage has also been suggested to occur in cells incubated at low pH [56]. Two generalizations can be made about pH homeostasis in microorganisms. First, the optimum cytoplasmic pH is species dependent, i.e., acidophiles in the range 4.5–6.0, neutrophiles 7.5–8.0, and alkalophiles 8.4–4.9. Generally, yeasts and fungi exhibit similar values to the acidophilic bacteria [13]. Second, microorganisms exhibit different capacities to regulate their cytoplasmic pH and possibly also have different tolerances of pH perturbation. For the purpose of pH homeostasis, it can be subdivided into fermentative and respiratory microorganisms [12].

### 12.1.2.3 Effects of pH on Heat Stability of Microorganisms

In the canning of foods, one of the most important factors affecting the sterilization times and temperatures is the actual pH value in the food. The lower the pH values, the lower the degree of heat required for sterilization. The consumer's preference of acidic or nonacidic products also affects the selection of pH values. It is usually considered that a pH of 4.6 is the dividing line between acid and nonacid foods. Foods classified with respect to their pH values are shown in Table 12.6 [28].

Bacterial spores are killed by heat more rapidly at low pH values than at pH values near neutrality [2,10,16]. Anderson and Friesen [2] showed that the rate of destruction of *Bacillus stearothermophilus* spores suspended in acetate buffer was only slightly more rapid at pH 4 than at pH 7, but below pH 4 the rate of death was much more rapid and appeared to be proportional to the proton concentration. At pH values of 7.0 and 6.0, spores of *Bacillus stearothermophilus* survived 60 min exposure unharmed at 100°C in presence of lactic acid and sodium phosphate buffer, whereas at pH 4.3 and 3.0 they died with D<sub>100</sub> (i.e., the decimal reduction times) values of 27 and 2.8 min, respectively. It was suggested that the enhanced death rate was due to toxic effects of undissociated lactic acid [49]. Watier et al. [68] measured the heat resistance of two strains of spoilage bacteria *Megasphaera cerevisiae* at temperatures 50°C–60°C. The values of D<sub>50</sub> were lower at pH 5.2 and 6.0, while at pH 4 the heat resistance was 4.2 times higher; thus at low pH the destruction rate was much higher.

### 12.1.2.4 Enhancement of the Effects of Preservatives

The efficacy of any preservative depends on the pH levels. Michener et al. [37] investigated 650 compounds for the ability to increase the susceptibility of spores to heat at pH 7. *Bacillus stearothermophilus* spores died much more rapidly at 100°C and mean pH 3.5 in the presence of lactic acid than in its absence. At pH 3.5, lactic acid (pK<sub>a</sub>, 3.87) is approximately 70% undissociated, and it can be suggested that the enhanced death rate was due to toxic effects of the undissociated acid [49].

TABLE 12.6

Foods Classified According to Acidity

Group	Group Name	pH Range
I	Nonacid	7.0–5.3
II	Low or medium acid	5.3–4.6
III	Acid I	4.6–3.7
IV	Acid II	3.7–low

Source: W. A. Gould and R. W. Gould, *Total Quality Assurance for the Food Industries*, CTI Publications, Baltimore, 1988.

### 12.1.3 pH Effects on Enzymes

Lipoxygenase catalyzed the oxidation of unsaturated fatty acids resulting in off-flavor. Asbi et al. [4] and Che Man et al. [14] studied inactivation of soybean lipoxygenase by pH adjustment without employing heat treatment. Complete inactivation of lipoxygenase was irreversible when treated at pH 3.0 and below [4,14], and inactivation of (i.e., activity) of urease was reduced to a commercially acceptable level at that pH. No effect on trypsin activity was observed up to pH 2. More than 70% protein dispersibility was retained in the neutralized full-fat soy flour after treatment with acid at about pH 3.0 [14].

Pectinesterase deesterifies pectin, which leads to cloud loss in citrus juice. The thermal inactivation rates of pectinesterase in citrus juices increased at lower pH values [6]. The effect of pH on stability of thermolabile and thermostable pectinesterase was studied by Sun and Wicker [58]. Both isozymes showed stability over a wide pH range. Thermolabile pectinesterase was inactivated irreversibly at pH 2 and 12, whereas thermostable pectinesterase maintained almost the same activity as before pH treatment with slight inactivation at pH 12. Thus, stability and conformation of thermostable pectinesterase were less likely to be changed by low pH treatment, and the conformational change was nearly reversible.

The enzyme lysozyme has antimicrobial potential to prevent or delay microbial growth in a variety of foods such as fresh fruits and vegetables, tofu bean curds, meats, seafoods, cheese, and wines. The relatively high thermal stability of lysozyme also makes it attractive for use in pasteurized and heat-sterilized food products, possibly allowing reduced thermal processes, therefore, minimized nutritional and sensory quality loss [34]. Makki and Durance [34] studied the stability of lysozyme in aqueous buffer solutions at selected temperatures (73°C–100°C), pH values (4.2–9.0), sucrose (0%, 5%, 15%), and sodium chloride (0, 0.1, 1 M). Lysozyme was most stable at pH 5.2, and thermal stability decreased sharply as the pH increased to 9.0. At pH 7.2 and 9.0, sodium chloride had a clear stabilizing effect against heat inactivation of lysozyme. Sucrose stabilized lysozyme against heat inactivation at 75°C, but not at 91°C. Loss of activity followed first-order kinetics, and rate constant correlation was developed in the pH 5.2–7.2 range and temperatures between 73°C and 100°C as follows:

$$\ln k = \frac{32.90 - 1.62 \times 10^4}{T + 1.19 (\text{pH})} \quad (12.1)$$

Ibrahim et al. [30] found that heat denaturation of lysozyme at increasing temperatures (80°C and pH 7.0 or over 90°C at pH 6.0) for 20 min resulted in progressive loss of enzyme activity, while it greatly promotes its bactericidal activity against Gram-negative and Gram-positive bacteria. They also observed that action is independent of catalytic function and kills bacteria through membrane damage mechanism as found from electron microscopy.

---

## 12.2 Effects of pH on Food Components

### 12.2.1 Effects of pH on Gel Formation

The pH also affects many functional properties such as color, flavor, and texture of foods, although the pH of a food is important for microbial growth. Acid fruit pulps form weak gels that collapse under their own weight [43,69]. Texturization of these acid pulps below pH 3.5 involves an important dilution of the pulp, thus the pulp should be neutralized by addition of sodium hydroxide [32,39].

Egg albumen is an important food ingredient because of its ability to incorporate other ingredients through the formation of a three-dimensional gel matrix. Gel properties are dependent upon many variables, including pH and ionic strength as well as the salts present. Savoie and Arntfield [53] studied the gelation of ovalbumin in the presence of salts containing Ca<sup>2+</sup> and Mg<sup>2+</sup> at various pH values. The impact of this binding on gel structure was dependent on pH and the technique used to evaluate structure. At pH 5, proteins tended to coagulate regardless of the type or amount of salt. At pH 7, the highest rigidity values from penetration measurements were obtained at salt levels of 0.005 M. At pH 9, the salt concentration for maximum rigidity varied with type of salt, while the storage moduli from dynamic rheology were highest at 0.01 M.

A significant improvement of functional properties, including foaming, emulsifying, and gelling properties of dried egg white (7.5% water), was observed when egg white was heated in a dry state at 80°C for several days [38]. Mine [38] found that heating of dried egg white proteins in the dry state at alkaline pH (under 9.5) was an effective method to obtain firm and elastic gels. The degree of unfolding of the proteins upon dry heating may play a crucial role in the gelling process of the proteins. The polymerization of the proteins was also enhanced by alkaline dry heating through sulfhydryl–disulfide interchange. Alkaline dry heating resulted in a high molecular weight polymer of partially unfolded egg white proteins, which, in turn contribute to the formation of low molecular weight and narrow molecular distribution of the aggregate.

The sinapic acid and thomasidioic acid bind to canola protein and affect protein functionality, especially gel formation upon heating of protein. Rubino et al. [48] studied the influences of sinapic and thomasidioic acids on the rheological characteristics of canola protein gels. At pH 4.5, there was binding between sinapic acid and the canola protein through electrostatic interactions, while at pH 7 and 8.5, there appeared to be a hydrophobic association between thomasidioic acid and canola protein. The presence of either compound resulted in deterioration of the characteristics of heat-induced gels for the canola protein. Sunflower protein gelation is strongly pH dependent. Sanchez and Burgos [51] found that gelation was only possible in the pH range 7–11 for sunflower protein, the storage modulus reaches its maximum value at pH 8, the gels formed at pH 7 or above pH 9 are very weak, gelation time increased with pH and decreased with protein concentration, and the storage modulus at pH 8 increased exponentially with protein concentration.

## 12.2.2 Effects of pH on Proteins

The behavior of proteins is pH dependent, and each protein has an isoelectric point, where the contributions from positive and negative charges cancel out to give the molecule no net charge. At this pH, proteins tend to coagulate, and therefore it is to be expected that surface rheological parameters of proteins close to their isoelectric point will be maximal [18,29]. At the pI, charge-based contributions to repulsion will be minimal, and steric stabilization will also be minimized since the proteins will be in their least expanded state [18]. The emulsion stability in some systems is greatest at the pI, such as gelatin [42], bovine serum albumin [8], pepsin [8], and soluble muscle protein [59]. This is probably due to the greater surface coverage at the pI with the compacted protein structures. This, together with the tendency of the protein to coagulate at the pI, gives cohesive films their enhanced stabilizing action [18]. Some proteins have been shown to give less stable emulsions at the pI, such as low concentrations (0.004%) of either bovine serum albumin or lysozyme may be due to surface coverage, milk fat/whey proteins that are highly unstable at pH 4.5–5.0, close to isoelectric points [19]. Thus, Dalgleish [18] concluded that the stability of emulsions at the isoelectric point is dependent on protein concentration, the volume–surface area of oil phase, and simply the pH.

At other pH values, proteins may show a distinct dependence on pH [18]. Bovine serum albumin showed increasing emulsifying activity as the pH was increased between 4 and 9, and then decreased sharply as the protein changes conformation [3,45,67]. In the range of pH 3–8,  $\beta$ -lactoglobulin did not change its emulsifying capacity, although it passed conformational transitions [67]. Shimizu et al. [55] found a strong dependence of the emulsifying power with pH, increasing from pH 3 to 9. The hydrophobicities of the different whey proteins vary with pH, but all the proteins behave similarly, i.e., their surfaces become less hydrophobic as the pH is increased [54]. Increasing the ionic strength diminishes the charged-based interactions between proteins and will produce the same type of effects as changing the pH toward the isoelectric point [18].

Agboola and Dalgleish [1] studied the effects of pH and ethanol on the kinetics of destabilization of oil-in-water emulsions containing milk proteins. Under shear, emulsions containing caseinate were stable between pH 3 and 3.5 and also at pH  $\geq$  5.3, while those formed with  $\beta$ -lactoglobulin were stable below pH 4 as well as at pH  $\geq$  5.6. The kinetics of pH-induced aggregation in emulsions could be explained by orthokinetic flocculation, while ethanol-induced association in caseinate emulsions appeared to be a result of Ostwald ripening.

Caseins comprise approximately 80% of the total protein content in milk. Caseins are phosphoproteins precipitated from raw milk at pH 4.6 at 20°C. The  $\alpha_{s1}$ -caseins contain more acidic amino acids than basic

TABLE 12.7

Stability of Vitamins under Acid/Alkaline Conditions

Vitamin	Condition <sup>a</sup>		
	pH 7	Acid Medium	Alkaline Medium
A	S	U	S
D	S	–	U
E	S	S	S
K	S	U	U
C	U	S	U
B <sub>1</sub>	U	S	U
B <sub>2</sub>	S	S	U
B <sub>6</sub>	S	S	S
B <sub>12</sub>	S	S	S
Niacin	S	S	S
Pantothenic acid	S	U	U
Biotin	S	S	S
Folic acid	U	U	S

<sup>a</sup>S: stable; U: unstable.Source: A. Murray, *Food Ind. South Africa* January:25, 1996.

ones, with a negative net charge of 22 at pH 6.5 [70].  $\beta$ -lactoglobulin is remarkably acid-stable resisting denaturation at pH 2.0. The protein assumes the shape of a prolate ellipsoid with an axial ratio of 2:1 and a hydration ratio of 35%–40% [62]. It generally exists as a dimer resulting from the association of the monomer at the respective  $\alpha$ -helical segments at the isoelectric pH of 5.2 and alkaline pH range.  $\beta$ -lactoglobulin A at low temperatures and high concentration, between pH 3.5 and 5.2, tends to form octamers as the predominant species. Below pH 3.5,  $\beta$ -lactoglobulin dissociates into monomers due to electrostatic repulsion between the subunits. Above pH 6.5, the dimers begin to dissociate. A transition in conformation occurs near pH 7.5, which is reversible, and involves only a certain region of the molecule [36,60,61]. This reversible unfolding is followed by slow changes, which become increasingly irreversible with increasing pH [70]. Bovine  $\alpha$ -lactalbumin is insoluble at the isoelectric range between pH 4 and 5. In contrast, goat  $\alpha$ -lactalbumin forms a clear solution over a wide pH range. In the physiological state, it exists in the calcium-bound form. The calcium is tightly bound and is not removed by isoelectric precipitation and dialysis against phosphate buffer [33,44].

### 12.2.3 Effects of pH on Vitamin Stability

The stability of vitamins depends on the pH of the medium and is summarized in Table 12.7 under acid/alkaline conditions. At higher water activity (>0.90), the rate of thiamine hydrochloride (vitamin B<sub>1</sub>) degradation in a buffered solution of glycerol at 85°C–95°C is independent of water activity, but highly dependent on pH [24]. Thiamine hydrochloride was less stable in solutions of univalent ions than in glycerol or divalent ions at the same water activity [50]. Riboflavin is also sensitive to pH.

## 12.3 Methods of Controlling pH in Foods

The pH of foods can be (1) altered by adding acidulants such as acetic, citric, ascorbic, and lactic acids and (2) produced by the action of microorganisms in many foods such as cheese, yogurt, meat, and alcoholic beverages; in this method, growth of spoilage microflora is controlled by the production of lactic or acetic acids.

In fermentation, carbohydrates and other reduced substrates are incompletely oxidized in the absence of an external electron acceptor. The fundamental principle is that all the electrons removed from a fermentable carbon source during its oxidation to release energy must be consumed by the reduction of a carbon metabolite resulting in the formation of a fermentation product [12]. The production of acid by fermentation plays a significant part in the preservation of food. In many dairy

products, the production of lactic and acetic acids, and hydrogen peroxide may also be an important factor. With meat, it is considered that the reduction of pH, and not the production of lactic acid, is primarily responsible for the preserving action [12,25,26]. In dairy fermentations, flavor production is very important. The principal flavor components include acetaldehyde and diacetyl, which are the by-products of the fermentation [12].

Fermentation has been applied to fish for many years and represents a low-level and affordable technology for tropical developing countries [22]. Fagbenro and Jauncey [23] studied the fermented tilapia stored for 180 days. Fagbenro [22] developed a preservation method of raw shrimp heads by fermenting with 5% (w/w) *Lactobacillus plantarum* as inoculum at 30°C using 15% (w/w) cane molasses as a carbohydrate source. After incubation for 7 days, a desirable and stable pH < 4.5 was attained in the anaerobic treatments that lasted until 30 days after the start of fermentation. Addition of trona at 5% prior to fermentation restricted protein hydrolysis by inhibiting the activity of endogenous autolytic enzymes. Addition of onion extract at 5 mL/kg proved effective as an antioxidant as the thiobarbituric acid reactive substances value remained low after 30 days' fermentation.

---

## References

1. S. O. Agboola and D. G. Dalgleish, Effects of pH and ethanol on the kinetics of destabilisation of oil-in-water emulsions containing milk proteins, *J. Sci. Food Agric.* 72:448, 1996.
2. R. A. Anderson and W. T. Friesen, The thermal resistance of *Bacillus stearothermophilus* spores, *Pharmaceutica Acta Helveticae* 49:295, 1974.
3. K. Aoki, M. Murata, and K. Hiramatus, Urea denaturation of bovine serum albumin at pH 9, *Anal. Biochem.* 59:146, 1974.
4. B. A. Asbi, L. S. Wei, and M. P. Steinberg, Kinetics of inactivation of soybean lipoxygenase by acid, In *Food Science and Technology in Industrial Development* (S. Maneepun and B. Phithakpol, Eds.), Institute of Food Research and Product Development, Bangkok, 1988, p. 146.
5. ASHRAE Handbook, *Refrigeration Systems and Applications*, American Society of Heating, Refrigeration, and Air-conditioning Engineers, Atlanta, GA, 1994.
6. C. D. Atkins and A. H. Rouse, Time-temperature relationships for heat inactivation of pectinesterase in citrus juices, *Food Technol.* 8:498, 1954.
7. A. C. Baird-Parker and G. W. Gould, Safety in the food industry: processing, In *Food Safety in the Human Food Chain* (F. A. Miller, Ed.), Centre for Agricultural Strategy, Reading, 1990, p. 45.
8. A. Biswas and D. A. Haydon, *Kolloid Z.* 185:31, 1962.
9. L. C. Blankenship, Some characteristics of acid injury and recovery of *Salmonella bareilly* in a model system, *J. Food Protect.* 44:73, 1981.
10. J. C. Blocher and F. F. Busta, Bacterial spore resistance to acid, *Food Technol.* 37:87, 1983.
11. I. R. Booth, Regulation of cytoplasmic pH in bacteria, *Microbiol. Rev.* 49:359, 1985.
12. I. R. Booth and R. G. Kroll, The preservation of foods by low pH, In *Mechanisms of Action of Food Preservation Procedures* (G. W. Gould, Ed.), Elsevier Applied Science, London, 1989, p. 119.
13. G. W. F. H. Borst-Pauwels, Ion transport in yeast, *Biochim. Biophys. Acta* 650:88, 1981.
14. Y. B. Che Man, L. Wei, and A. I. Nelson, Inactivation of lipoxygenase in whole soybeans by pH adjustment, In *Food Science and Technology in Industrial Development* (S. Maneepun and B. Phithakpol, Eds.), Institute of Food Research and Product Development, Bangkok, 1988, p. 137.
15. M. B. Cole and M. H. J. Keenan, Synergistic effects of weak-acid preservatives and pH on the growth of *Zygosaccharomyces baillii*, *Yeast* 2:93, 1986.
16. S. Condon and F. J. Sala, Heat resistance of *Bacillus subtilis* in buffer and foods different pH, *J. Food Protect.* 55:605, 1992.
17. D. A. Corlett and M. H. Brown, pH and acidity, In *Microbial Ecology of Foods, Vol. 1, Factors Affecting the Life and Death of Microorganisms*, Academic Press, London, 1980.
18. D. G. Dalgleish, Protein-stabilized emulsions and their properties, In *Water and Food Quality* (T. M. Hardman, Ed.), Elsevier Applied Science, London, 1989, p. 211.
19. I. N. De Wit, G. Klarenbeek, and G. A. M. Swinkels, *Zuivelzucht* 68:442, 1976.
20. I. L. Dodds, Combined effect of water activity and pH on inhibition of toxin production by *Clostridium botulinum* in cooked, vacuum packed potatoes, *Appl. Environ. Microbiol.* 55:656, 1989.

21. T. Eklund, The effect of sorbic acid and esters of p-hydroxybenzoic acid on the protonmotive force in *Escherichia coli* membrane vesicles, *J. Gen. Microbiol.* 131:73, 1985.
22. O. A. Fagbenro, Preparation, properties and preservation of lactic acid fermented shrimp heads, *Food Res. Int.* 29:595, 1996.
23. O. A. Fagbenro and K. Jauncey, Chemical and nutritional quality of stored fermented fish (tilapia) silage, *Biores. Technol.* 46:207, 1993.
24. I. Fox, M. Loncin, and M. Weiss, Investigations into the influence of water activity, pH, and heat treatment on the breakdown of thiamine in foods, *J. Food Qual.* 5:161, 1982.
25. C. O. Gill and K. G. Newton, The development of aerobic spoilage flora on meat stored at chill temperatures, *J. Appl. Bacteriol.* 43:189, 1977.
26. S. E. Gilliland and M. L. Speck, Inhibition of psychrotrophic bacteria by lactobacilli and pediococci, *J. Food Sci.* 40:913, 1975.
27. G. W. Gould, Biodeterioration of foods and an overview of preservation in the food and dairy industries, *Int. Biodeterio. Biodegrad.* 36:267, 1995.
28. W. A. Gould and R. W. Gould, *Total Quality Assurance for the Food Industries*, CTI Publications, Baltimore, 1988.
29. P. J. Halling, Protein-stabilized foams and emulsions, *CRC Crit. Rev. Food Sci. Nutr.* 15:155, 1981.
30. H. R. Ibrahim, S. Higashiguchi, M. Koketsu, L. R. Juneja, M. Kim, T. Yamamoto, Y. Sugimoto, and T. Aoki, Partially unfolded lysozyme at neutral pH agglutinates and kills Gram-negative and Gram-positive bacteria through membrane damage mechanism, *J. Agric. Food Chem.* 44:3799, 1996.
31. I. R. Johnston and R. C. Lin, FDA views on the importance of  $a_w$  in good manufacturing practice, In *Water Activity: Theory and Applications to Food* (L. B. Rockland and L. R. Beuchat, Eds.), Marcel Dekker, New York, 1987, p. 287.
32. G. Kaletunc, A. Nussinovitch, and M. Peleg, Alginate texturization of highly acid fruit pulps and juices, *J. Food Sci.* 55:1759, 1990.
33. I. J. Kronman, J. Jeroszko, and G. W. Saga, Inter and intramolecular interactions of  $\alpha$ -lactalbumin. XII. Changes in the environment of aromatic residues in the goat protein, *Biochim. Biophys. Acta* 285:145, 1972.
34. F. Makki and T. D. Durance, Thermal inactivation of lysozyme on influenced by pH, sucrose and sodium chloride and inactivation and preservative effect in beer. *Food Res. Int.* 29:639, 1996.
35. P. J. McClure, M. B. Cole, and J. P. P. M. Smelt, Effects of water activity and pH on growth of *Clostridium botulinum*, *J. Appl. Bacteriol. Symp. Suppl.* 76:105S, 1994.
36. H. A. McKenzie and W. H. Sawyer, Effect of pH on  $\beta$ -lactoglobulin, *Nature* 214:1101, 1967.
37. H. D. Michener, P. A. Tompson, and J. C. Lewis, Search for substances which reduce the heat resistance of bacterial spore, *Appl. Microbiol.* 7:166, 1959.
38. Y. Mine, Effect of pH during the dry heating on the gelling properties of egg white proteins, *Food Res. Int.* 29:155, 1996.
39. C. Mouquet and S. Guilbert, Texturization of pulps allows the fabrication of heat stable mango and passion fruit pieces, Food Ingredients Europe Conference Proceedings, Dusseldorf, 1992, p. 232.
40. A. Murray, From my flow sheet: roll out the kilderkin, *Food Ind. South Africa* January: 25, 1996.
41. A. L. Neal, J. O. Weinstock, and J. O. Lampen, Mechanisms of fatty acid toxicity for yeasts, *J. Bacteriol.* 90:126, 1965.
42. G. E. Nielsen, A. Wall, and G. Adams, *J. Coll. Inter. Sci.* 13:441, 1958.
43. A. Nussinovitch and M. Peleg, Mechanical properties of a raspberry product texturized with alginate, *J. Food Process. Preserv.* 14:267, 1990.
44. I. Parris, J. M. Purcell, and S. M. Ptashkin, Thermal denaturation of whey proteins in skim milk, *J. Agric. Food Chem.* 39:2167, 1991.
45. I. N. Pearce and J. E. Kinsella, Emulsifying properties of proteins: evaluation of a turbidimetric technique, *J. Agric. Food Chem.* 26:716, 1978.
46. I. S. Przybelski and L. D. Witter, Injury and recovery of *Escherichia coli* after sublethal acidification, *Appl. Environ. Microbiol.* 37:261, 1979.
47. T. A. Roberts, Microbial growth and survival: developments in predictive modelling, *Int. Biodeterio. Biodegrad.* 36:297, 1995.
48. I. I. Rubino, S. D. Arntfield, C. A. Nadon, and A. Bernatsky, Phenolic protein interactions in relation to the gelation properties of canola protein, *Food Res. Int.* 29:653, 1996.
49. F. Ruiz-Teran and J. D. Owens, Sterilization of soybean cotyledons by boiling in lactic acid solution, *Lett. Appl. Microbiol.* 22:30, 1996.



50. J. Ryley, The effect of water activity on the stability of vitamins, In *Water and Food Quality* (T. M. Hardman, Ed.), Elsevier Applied Science, London, 1989, p. 325.
51. A. C. Sanchez and J. Burgos, Thermal gelation of trypsin hydrolysates of sunflower proteins: effect of pH, protein concentration, and hydrolysis degree, *J. Agric. Food Chem.* 44:3773, 1996.
52. D. Sanders and C. L. Slayman, Control of intracellular pH: predominant role of oxidative metabolism, not proton transport, in the eukaryotic microorganism *Neurospora*, *J. Gen. Physiol.* 80:377, 1982.
53. V. J. Savoie and S. D. Arntfield, Effect of pH and cations on the thermally induced gelation of ovalbumin, *J. Texture Stud.* 27:287, 1996.
54. I. Shimizu, T. Kamiya, and K. Yamauchi, *Agric. Biol. Chem.* 45:2491, 1981.
55. I. Shimizu, M. Saito, and K. Yamauchi, *Agric. Biol. Chem.* 49:189, 1984.
56. R. P. Sinha, Toxicity of organic acids for repair-deficient strains of *Escherichia coli*, *Appl. Environ. Microbiol.* 51:1364, 1986.
57. I. Spanggaard and H. H. Huss, Growth of the fish parasite *Ichthyophonus hoferi* under food relevant conditions, *Int. J. Food Sci. Technol.* 31:427, 1996.
58. A. Sun and L. Wicker, pH affects Marsh grapefruit pectinesterase stability and conformation, *J. Agric. Food Chem.* 44:3741, 1996.
59. A. E. Swift and W. L. Sulzbacher, *Food Technol.* 17:224, 1963.
60. C. Tanford, L. G. Bunville, and Y. Nozaki, The reversible transformation of  $\beta$ -lactoglobulin at pH 7.5, *J. Am. Chem. Soc.* 81:4032, 1959.
61. S. N. Timasheff, L. Mescanti, J. J. Basch, and R. Townend, Conformational transitions of bovine  $\beta$ -lactoglobulins A, B, and C, *J. Biol. Chem.* 241:2496, 1966.
62. S. N. Timasheff and R. Townend, Structural and genetic implications of the physical and chemical differences between  $\beta$ -lactoglobulins A and B, *J. Dairy Sci.* 45:259, 1962.
63. C. T. Townsend, L. Yee, and W. A. Mercer, Inhibition of the growth of *Clostridium botulinum* by acidification, *Food Res.* 19:536, 1954.
64. J. A. Troller, Effects of  $a_w$  and pH on growth and survival of *Staphylococcus aureus*, In *Properties of Water in Foods* (D. Simatos and J. L. Moulton, Eds.), Martinus Nijhoff Publisher, Dordrecht, 1985.
65. J. A. Troller, Adaptation and growth of microorganisms in environments with reduced water activity, In *Water Activity: Theory and Applications to Food* (L. B. Rockland and L. R. Beuchat, Eds.), Marcel Dekker, New York, 1987, p. 101.
66. S. J. Walker, Chilled foods microbiology, In *Chilled Foods a Comprehensive Guide* (C. Dennis and M. Stringer, Eds.), Ellis Harwood Ltd., West Sussex, 1992, p. 165.
67. R. Waniska, J. Shetty, and J. E. Kinsella, Protein-stabilized emulsions: effect of modification on the emulsifying activity of bovine serum albumin in a model system, *J. Agric. Food Chem.* 29:826, 1981.
68. A. Watier, I. Chowdhury, I. Leguerinel, and J. P. Hornez, Survival of *Megasphaera cerevisiae* heated in laboratory media, wort and beer, *Food Microbiol.* 13:205, 1996.
69. A. Weiner and A. Nussinovitch, Succulent, hydrocolloid-based, texturized grapefruit products, *Food Sci. Technol.* 27:394, 1994.
70. D. W. S. Wong, W. M. Camirand, and A. E. Pavlath, Structures and functionalities and milk proteins, *Crit. Rev. Food Sci. Nutri.* 36:807, 1996.

# 13

## *Nitrites in Food Preservation*

Mohammad Shafiur Rahman

### CONTENTS

13.1 Nitrites .....	299
13.2 Antimicrobial Aspects .....	299
13.2.1 Stage of Inhibition .....	300
13.2.2 Factors Affecting the Efficacy of Nitrites .....	300
13.2.2.1 Effects of pH .....	300
13.2.2.2 Effects of Oxygen .....	301
13.2.2.3 Effects of Other Food Components .....	301
13.2.2.4 Effects of Heating .....	302
13.2.2.5 Effect of Irradiation.....	303
13.2.3 Mode of Action to Microflora .....	303
13.2.3.1 Inhibition of the Phosphoroclastic System .....	304
13.2.3.2 Inhibition of Enzyme Systems .....	304
13.3 Interaction of Nitrites with Food Components .....	305
13.4 Functional and Sensory Properties Improvement .....	306
13.5 Medical or Health Aspects .....	307
References .....	308

### 13.1 Nitrites

Preservatives are compounds used to delay or prevent the chemical and microbiological deterioration of foods. Nitrites and nitrates are used in many foods as preservatives and functional ingredients. Nitrites are critical components used to cure meat and are known to be multifunctional food additives. They are also potent antioxidants. Nitrites are white-to-pale-yellow hygroscopic crystals. Sodium nitrite ( $\text{NaNO}_2$ ) is markedly less hygroscopic than potassium nitrite ( $\text{KNO}_2$ ). Nitrites are quite soluble in water and liquid ammonia but much less soluble in alcohol and other solvents. At room temperature, one part of water dissolves one part sodium nitrite or three parts potassium nitrite [17].

### 13.2 Antimicrobial Aspects

Sodium nitrite plays an important role in inhibiting the growth and toxin production of *Clostridium botulinum* in cured products [31]. Usually, input concentrations in excess of 100 mg/kg are used for protection against microflora [119]. The review of Woods et al. [119] indicates that a concentration of 200 mg/kg at pH 6.0 was capable of inhibiting strains of *Achromobacter*, *Aerobacter*, *Escherichia*, *Flavobacterium*, *Micrococcus*, and *Pseudomonas* species. *Salmonella*, *Lactobacilli*, and *C. perfringens* are more resistant when compared with other clostridia [119]. Tompkin et al. [107] found that the time to first swell was 6.7, 29.8, 82.6, and 94.3 days when 0, 50, 100, and 156  $\mu\text{g/g}$  of sodium nitrite were added to the perishable canned cured meat. The primary effect of nitrite appeared in determining the length of

the lag phase. Once swelling commenced, the rate at which the cans swelled was not significantly different at 50, 100, and 156  $\mu\text{g/g}$  of sodium nitrite. At 50  $\mu\text{g/g}$  nitrite, a 75% probability of toxicity was predicted at 3 months. Hauschild et al. [39] concluded that (i) the degree of safety from *C. botulinum* toxin production can differ by several orders of magnitude depending on the composition of formulation and (ii) the large reductions in the concentrations of nitrite in the products could produce severe consequences.

### 13.2.1 Stage of Inhibition

The germination and outgrowth of bacterial spores include five sequential steps: (i) germination (becoming nonrefractile, stainable, and heat sensitive), (ii) swelling of the germinated spore, (iii) emergence of new vegetative cell, (iv) elongation, and (v) cell division [19]. The inhibitory effect of nitrite on bacterial spore formers is apparently due to inhibition of outgrowth and cell division [15,28,106]. Duncan and Foster [19] identified three points of inhibition in the outgrowth process of anaerobic spores: (i) up to 0.06% at pH 6.0 or between 0.8% and 1% at pH 7.0 nitrite allowed emergence and elongation of vegetative cells but blocked cell division, elongated cells that did not multiply eventually lysed, leaving the empty spore coats; (ii) with more than 0.06% nitrite at pH 6.0 or more than 0.8%–1% at pH 7.0, the spores lost refractility and swelled, but the vegetative cell did not emerge; and (iii) even as much as 4% nitrite failed to prevent germination (complete loss of refractility) and swelling of the spores. Duncan and Foster [20] reported that sodium nitrite induced germination of *C. sporogenes* spores. They found that the process was accelerated by using increased concentrations of sodium nitrite, a low pH, and a high temperature of incubation. The increase in germination rate with increasing temperature and increasing nitrite concentration may be a reflection in the alteration of the tertiary structure of a spore protein, which in turn may be involved in calcium–dipicolinic acid complex [20]. The stimulatory effect of nitrite on germination has a dual role in preservation: (i) induction of spores to germinate, making them susceptible to a heating process and (ii) inhibition of the outgrowth of any surviving spores [20]. Gould [32] also found that lower concentrations inhibited outgrowth of the spore after germination, whereas higher concentrations inhibited germination itself.

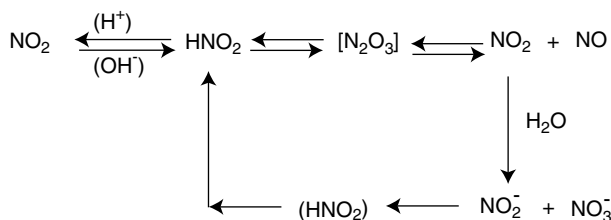
Nitrite exerts a concentration-dependent antimicrobial effect on the outgrowth of spores from *C. botulinum* and other clostridia. The effectiveness of nitrite depends on several environmental factors in a very complex situation, such as foods. Thus, the concentration of nitrite required to prevent outgrowth varies with the type of media or foods, and environmental conditions.

### 13.2.2 Factors Affecting the Efficacy of Nitrites

#### 13.2.2.1 Effects of pH

Nitrite is found to be most inhibitory to bacteria at an acidic pH [17]. Tarr [100–102] showed that the preservative action of nitrite in fish was greatly increased by acidification. In bacteriological medium, the inhibitory action was increased with decreasing pH, particularly at pH 6.0 and below. Grindley [35] suggested that the mode of preservation could be due to the formation of active nitrous acid. Jensen [48] suggested that the increased action of preservation at low pH was due to the undissociated active inhibitor nitrous acid. A 10-fold increase in the inhibitory effect of nitrite against *C. botulinum* was found when the pH was reduced from 7.0 to 6.0 [96]. Similar tenfold increases for one unit decrease in pH were also observed for *Staphylococcus aureus* [14], *Bacillus* [21], and *C. sporogenes* [80].

The pH dependency of nitrite-induced bacterial inhibition also reflects the conversion of nitrite into nitrous acid [8]. Shank et al. [99] mentioned the “nitrite cycle.” The dynamics of nitrous acid production may be visualized in a cyclic reaction where nitrite undergoes a concomitant oxidation–reduction reaction resulting in the formation of nitrate, nitric oxide, and nitrogen dioxide. Nitrogen dioxide, reacting with water, would generate more nitrate and nitrite with the nitrite reentering the cycle again (Figure 13.1). At low pH levels (pH 3–4), the cycle rapidly forms  $\text{NO}_3$  and  $\text{NO}$ . At intermediate pH levels (pH 4.5–5.5), the cycle rotates more slowly. The presence of  $\text{HNO}_2$  is prolonged, thereby increasing its reaction potential. This is the level of maximum bactericidal activity. At higher pH levels (pH 6–7), the equilibrium shifts toward  $\text{NaNO}_2$ , the cycle is prevented from functioning, and no bactericidal effects are observed. Nitrous acid and nitric oxide have two fundamental areas of reaction: (i) with the bacterial cell itself and (ii) with various constituents of the medium making them unavailable for subsequent metabolism. Either or both of these reactions could result in bacteriostasis. Further evidence for bound nitric oxide was presented by



**FIGURE 13.1** The dynamics of nitrous acid production in a cyclic reaction. (Adapted from Shank et al., *Appl. Microbiol.* 10:185, 1962.)

Frouin [24,25], who found that all measurable nitrite in various cured products could be volatilized under a high vacuum. This indicated that in meat system, nitrite was converted into nitric oxide and may produce a complex equilibrium with other components.

At 20°C, *C. perfringens* growth in laboratory medium was inhibited by 200 µg/mL nitrite and 3% salt or 50 µg/mL nitrite and 4% salt at pH 6.2, whereas fecal streptococci showed growth in the same medium with 400 µg/mL and 6% salt [30]. *Salmonella* showed visible growth within 1 week at 20°C in the presence of 400 µg/mL nitrite and 4% salt. Significant inhibition by salt and nitrite was achieved only at lower temperatures (10°C or 15°C) and at pH 5.6 or 6.2. *Escherichia coli* was more resistant than *Salmonella*. The inhibition was demonstrated only at the extremes of pH (5.6), salt (6%), nitrite (400 µg/mL), and temperature (10°C) [29].

The survival of *Listeria monocytogenes* was detected after fermentation and drying, although their number was usually found to be reduced. Surveys of fermented meat products confirmed the presence of *Listeria monocytogenes* in finished products [112]. Junttila et al. [51] concluded that nitrite and nitrate additions to a meat product at officially approved levels did not cause the elimination of *Listeria monocytogenes*. In broth cultures, it was demonstrated that acidity and nitrite increased the inactivation rate of *Listeria monocytogenes* [7]. Whiting and Masana [112] studied the effect of nitrite (0–300 µg/mL) and pH in uncooked fermented meat products. The time to achieve a 4-log decline was greatly affected by pH, ranging from 21 days at pH 5.0 to less than 1.0 day at pH 4.0. Nitrite additions did not affect survival, suggesting that the effective concentration was the rapidly decreasing residual nitrite level. There is potential for production of bacteriocins by the lactic acid bacteria of the starter cultures in the case of fermented meat [112].

### 13.2.2.2 Effects of Oxygen

Nitrite is more inhibitory under anaerobic conditions [8,14,55]. The aerobically cultured *Staphylococcus aureus* were able to grow in the presence of significantly higher concentrations of sodium nitrite than were cultures grown in an aerobic environment [14]. Buchanan and Solberg [8] studied the effect of pH and oxygen pressure on the bacteriostatic accumulation of sodium nitrite toward *Staphylococcus aureus*. They found that the magnitude of inhibition was dependent on the interaction of sodium nitrite concentration, initial pH, and partial pressure of oxygen. Aerobic cultures, after the initial pH decrease, showed a subsequent rise in pH to a level greater than the initial pH, whereas anaerobic cultures remain at the pH level of maximum pH decrease. Injury and cell destruction were most apparent at the lower pH level in the presence of nitrite concentration ≤500 ppm. However, 200 ppm sodium nitrite in cured meats would offer significant protection against growth of *Staphylococcus aureus*, particularly if meat product is vacuum packed. Buchanan and Solberg [8] suggested that nitrite may inhibit the growth of *Staphylococcus aureus* by blocking the sulfhydryl sites of either coenzyme A or α-lipoic acid, thus blocking the normal metabolism of pyruvate.

### 13.2.2.3 Effects of Other Food Components

Temperature, salt concentration, and initial inoculum size also significantly influence the antimicrobial role of nitrite [28,85,88,89,92]. It has been reported that sodium chloride alone at concentrations of 9.0%–10.5% can inhibit growth and toxin production by *C. botulinum*. When nitrite was added in concentrations of 75 and 150 ppm, sodium chloride levels of 5.8% and 4.9% were required to inhibit toxin formation. The usual salt levels added to cured meat range from 2% to 3% of the weight of the

product. This indicates that salt alone is not always a practical inhibitor of growth and toxin formation by *C. botulinum* [81]. Pierson and Smoot [81] mentioned in their review that the inhibitory effects by the interaction of sodium chloride and nitrite on various bacteria have been widely reported. Riemann [84] found significant inhibition of bacteria spores in a canned meat system by interactions of sodium chloride with sodium nitrite or nitrate as well as pH interactions with sodium chloride. Others also found that inhibition was due to the interaction effects of pH, sodium chloride, and sodium nitrite [87,95]. Baird-Parker and Baillie [5] found that most *C. botulinum* type A, and proteolytic type B and F strains would grow in the presence of 150–200 mg/kg of sodium nitrite or 6% sodium chloride at pH 6.0, but under the same conditions, 200 mg/kg of sodium nitrite plus 3% sodium chloride inhibited almost all the strains. These results indicate that a combination of salt, nitrite, and pH can be synergistic to the inhibition [81].

Roberts et al. [90,91] studied the combined effect of the following factors on the growth of *C. botulinum*: sodium chloride (0%–4.5% w/v in water), sodium nitrite (100–300 µg/g), sodium nitrate (0–500 µg/g), sodium isoascorbate (0–1000 µg/g), polyphosphate (0%–0.3% w/v), heat treatment (70–80°C), and storage temperature (15–35°C). Their findings can be summarized as (i) increasing nitrite, salt, or heat treatment; adding isoascorbate, polyphosphate, or nitrate; or storage temperature significantly reduced toxin production, (ii) the relative effect of increasing nitrite became less in the presence of isoascorbate or high salt levels, (iii) increasing salt or heat treatment, and adding nitrate or decreasing storage temperature had less effect if isoascorbate was present, and (iv) the addition of polyphosphate enhanced the effect of adding isoascorbate. Roberts et al. [91] concluded that it should not be used to assess which combinations give a guaranteed risk of toxin production, since minor changes in product formulation or its production, or in experimental conditions might significantly alter the ability to support toxin production and the variability of the system.

The combinations of low nitrite (40 µg/g) plus sorbate/sorbic acid controlled the growth of *C. botulinum* as effectively as the level of nitrite (156 µg/g). The low level of nitrite (40 µg/g) alone had no significant effect on the growth of *C. botulinum*, but was included to ensure acceptable cured color and flavor [93]. The factors that decreased the toxin production of *C. botulinum* were (i) potassium sorbate, (ii) increasing sodium chloride, (iii) decreasing pH, and (iv) decreasing storage temperature. Heat treatment interacted significantly with some other factors. The effect of sorbate (0.26% w/v) was greater at 3.5% sodium chloride than at 2.5%, at pH values below 6.0, and at low storage temperature [93].

Ethylenediaminetetraacetic acetate (EDTA), isoascorbate, and ascorbate enhance the antibotulinal efficacy of nitrite in canned meat. The degree of inhibition was inversely related to the level of iron and directly related to the level in case of EDTA. The use of isoascorbate and ascorbate has both positive and negative attributes depending on their level in meat products. At moderate level, the synergistic effect is due to the sequestering cause of isoascorbate or ascorbate on a cation, iron. On the other hand, excessive levels of ascorbate were shown to decrease the efficacy, because isoascorbate and ascorbate cause more rapid depletion of residual nitrite. EDTA more effectively sequesters iron, thus making iron less available for preventing nitrite inhibition [110]. Tompkin et al. [110] proposed to use a minimum of isoascorbate to hasten the curing reaction and stabilize color and flavor, and supplement with a low level of EDTA for improved botulinal protection. When *Bacillus cereus* was inoculated into uncooked sausage in the presence of 500 mg/kg sodium isoascorbate and 200 mg/kg sodium nitrite and incubated for 48 h at 20°C, no growth was demonstrated. Sodium isoascorbate alone had no inhibitory effects [82].

#### 13.2.2.4 Effects of Heating

In a bacteriological medium, the inhibitory effect of nitrite is enhanced tenfold after heating due to the formation of an extremely inhibitory substance. This is called *Perigo effect* [80]. Perigo et al. [80] confirmed that the effect of unheated sodium nitrite was pH dependent and that 200–400 ppm sodium nitrite was necessary to inhibit the growth of *C. sporogenes* at pH values around neutrality. They showed that as little as 3–5 ppm sodium nitrite heated in the medium for 20 min at 105–115°C could inhibit growth, and this inhibition was slightly dependent on the pH of the medium. The rate at which this unknown substance is produced was maximal at a temperature of about 110°C. At temperatures exceeding 110°C, the unknown substance appeared to break down or react in such a way that its inhibitory activity declines. Perigo and Roberts [79] confirmed this effect in 30 clostridial strains, including *C. botulinum* types A, B, E, and F (14 strains) and *C. welchii* (8 strains). It was reported that a reducing agent such as thioglycolate, ascorbate, or cysteine, and protein hydrolysate were the necessary components of the laboratory medium to produce the effect. Roberts and Gracia [94] showed that the inhibition was enhanced due to Perigo

effect in the case of 9 strains of *Bacillus* when 14 strains were tested. *Streptococcus durans* (*faecium*) was also sensitive to this effect, whereas *Streptococcus faecalis* and *Salmonella* were more resistant.

It has been suggested that one or more new chemical species have been produced [80]. Evidence has been presented, which indicates that the media may contain substances such as Roussin black salt (iron thionitrosyl) [3,4] and nitrosothiols [45,65]. Involvement of sulfhydryl groups as well as a nitroso group is probably important [45,65]. Hansen and Levin [38] mentioned that it may be possible that heat-induced Perigo inhibitors are distinct from these compounds. They suggested that a heat-induced inhibitor presumably of Perigo type was compared with the nitrosothiols of thioglycolate and mercaptoethanol. Phase contrast microscopy revealed that inhibition of morphological events occurred either before germination or during early outgrowth, depending on inhibitor concentration. The inhibitors derived from nitrite act virtually at every stage in the life cycle of *Bacillus*, which suggests that their mode of action is rather general, and that inhibition may be the result of inactivation of several sensitive metabolic systems or steps. A synergistic inhibitory response could help explain the elusive nature of the mode of action of nitrite curing salts as preservatives [38].

An inhibitor of *C. perfringens* was formed when low levels of nitrite were autoclaved with a defined chemical medium. Only amino acids and mineral salts were involved in the production of this inhibitor. The toxic compound was formed at sublethal level from cysteine, ferrous sulfate, and sodium nitrite. *S*-nitrosocysteine, unstable Roussin red salt, and a complex of cysteine, iron, and nitric oxide were detected. Moran et al. [71] concluded that observed inhibition could be due to the combined effects of sublethal concentrations of each compound. The extended heat treatment of the meat may cause decomposition of the proteins with liberation of amino acids, peptides, and possibly, amines. Nitrite reacts with amines and amino acids forming *N*-nitroso compounds, either *N*-nitrosamines or *N*-nitrosamides, which are toxic and carcinogenic to animals and mutagenic to various species of microorganisms [114].

Johnston et al. [50] found Perigo-type effect in minced pork. Johnston and Loynes [49] mentioned that the inhibitory effect of nitrite, can be increased in the media by the addition of reducing agents such as cysteine, thioglycolate, and ascorbate. These agents are known to aid in the reduction of nitrite and may affect the formation of nitroso reductants. These intermediate carriers may transfer the nitroso group directly to components of the bacterial cells or release nitric oxide. Johnston and Loynes [49] mentioned that the addition of reducing agents to meat suspensions decreased the redox potential and increased the inhibitory activity by Perigo factor formation. Ashworth and Spencer [4] studied the role of chemical additives in the formation of this inhibition in minced pork and found similar effect. They added 0.1% of reducing agents in pork slurry containing nitrite and found that its inclusion increased the inhibitory effect of nitrite in case of sodium ascorbate, cysteine (free base), and thioglycolate, but with sodium formaldehyde sulfoxylate and sodium formaldehyde bisulfite there was a marked decrease in the inhibitory activity.

Huhtanen and Wasserman [43] suggested that a potent anticlostridial inhibitor can be produced by addition of iron (ferrous or ferric) without autoclaving nitrite in the medium. They indicated that iron was a limiting factor and sulfhydryl groups were probably necessary for its formation. Similarly, Custer and Hansen [16] found that lactoferrin (an iron-binding glycoprotein) and transferrin reacted with nitrite to an inhibitor effective for spore outgrowth of *Bacillus cereus*. The Perigo inhibitor is formed at 105°C or higher, which exceeds the temperatures normally used in the processing of cured meats. Holley [42] mentioned that Perigo inhibitor is formed in culture medium only when sulfhydryl groups and iron are present. Nitrite reacts with various naturally occurring chemical components in the complex system of meat. The heating conditions normally used in the curing process speed up these reactions, and at the end of the process only about 10%–20% of the originally added nitrite is analytically detectable. The residual nitrite level declines further during storage and distribution [13].

#### 13.2.2.5 Effect of Irradiation

Pierson and Smoot [81] reviewed the effects of irradiation and mentioned that a limited amount of added nitrite was required to successfully produce acceptable irradiated cured meat products.

#### 13.2.3 Mode of Action to Microflora

A target can be selected from biochemical knowledge in the undesired microorganisms, which is absent from or at least different in the human. This target might be an enzyme or a cellular component involved in a process essential to microbial survival or development [113]. The inhibitory action of sodium nitrite

on *C. perfringens* was apparently at the cellular level, since microscopic examination of these organisms indicated no visible difference between inhibited and normal cells. Thus, damage was probably at a submicroscopic level [86]. Yarbrough et al. [122] showed that nitrite has more than one site of attack in the bacterial cell metabolic processes. These are: (i) nitrite interferes with energy conservation by inhibiting oxygen uptake, oxidation phosphorylation, and proton-dependent active transport, (ii) nitrite acts as an uncoupler, causing a collapse of the proton gradient, and (iii) nitrite inhibits certain metabolic enzymes.

### 13.2.3.1 Inhibition of the Phosphoroclastic System

In the cell, oxidation of substrate occurs with concomitant production of adenosine triphosphate (ATP). This can then be used subsequently as an energy source for the synthesis of new cellular material required for growth. In clostridia, an important source of ATP is the oxidation of pyruvate to acetate by phosphoroclastic system [119]. When nitrite is added to a suspension of cells of *C. sporogenes* incubated in a medium containing glucose, there is a large and rapid decrease in the intracellular concentration of ATP and an excretion of pyruvate from the cells [118]. This increase in pyruvate suggested that the phosphoroclastic system is inhibited by nitrite [119]. Iron is a required nutrient for clostridial spore germination and outgrowth, and botulin toxin development. The growth of *C. sporogenes* and *C. botulinum* was inhibited by nitrite through interference with the phosphoroclastic system resulting in an accumulation of pyruvic acid in the medium [117,118]. The inhibition was due to an interaction that occurred between nitrite and intracellular iron-bound protein, i.e., reaction of nitric oxide with the nonheme iron of pyruvate:ferredoxin oxidoreductase [118]. Nitrite was also shown to inhibit the iron-sulfur enzyme, ferredoxin, of *C. botulinum* and *C. pasteurianum* [10]. The addition of iron depleted residual nitrite levels in cured meats.

The phosphoroclastic system consists of two components: ferredoxin and pyruvate:ferredoxin oxidoreductase. Both these contain nonheme iron moieties. Pyruvate:ferredoxin oxidoreductase consists of a single protein molecule containing thiamine pyrophosphate and a nonheme iron. Nitric oxide causes inhibition of the phosphoroclastic system by interacting with these components. Nitric oxide is a potent iron ligand that can form coordination complexes with nonheme iron. Pyruvate:ferredoxin oxidoreductase seemed to be more sensitive to nitric oxide [118,119]. Tompkin et al. [109] also suggested that nitric oxide reacted with iron-containing protein in the cell of *C. botulinum*. Reddy et al. [83] demonstrated the production of iron nitric oxide complexes using electron-spin resonance spectroscopy. The aliphatic and aromatic nitro compounds inhibit the ferredoxin possibly as a result of formation of *S*-nitrosothiols by reaction with cysteine residues [2]. Castellani and Niven [14] suggested that the bacteriostatic action of nitrite might be due to interference with the normal metabolism of hypothetical pyruvate-sulfhydryl complex.

### 13.2.3.2 Inhibition of Enzyme Systems

At acid pH levels, sodium nitrite exists as nitrous acid, an extremely reactive molecule capable of interaction with a wide variety of substances, including myoglobin, ascorbic acid, phenols, secondary amines, amino groups, and thiol groups [75]. Mirna and Hofmann [66] reported that although sodium nitrite reacts with both sulfhydryl (SH) groups and primary amino groups at pH 5.5, the reaction with SH groups is more rapid. Riha and Solberg [86] proposed that nitrite inhibition of *C. perfringens* may be due to a reaction of nitrous acid with SH-containing constituents of the bacterial cell. The nitrite could inhibit enzymes of glucose fermentation such as glyceraldehyde-3-phosphate dehydrogenase and aldolase in *C. perfringens* [75]. Nitrite also inhibited aldolase from *E. coli*, *Pseudomonas aeruginosa*, and *Streptococcus faecalis* [122]. Nitrite inhibited the nitrogenase of *C. pasteurianum*, a system that comprises two nonheme iron-containing proteins. This inhibition was probably due to the reaction of nitric oxide with a component of the nitrogenase system [63].

McMindes and Siedler [62] reported that nitric oxide was the active antimicrobial principle of nitrite and that pyruvate decarboxylase may be an additional target for growth inhibition by nitrite. These observations are substantiated by the fact that the addition of iron to meats containing nitrite reduces the inhibitory effect of the compound [108]. Chelating agents such as sodium ascorbate, ethylenediaminetetraacetate, and polyphosphate enhance the antibotulin action of nitrite. Muscle pigmentation is due to myoglobin and, to a lesser extent, hemoglobin remaining after carcass bleeding. Heart meat showed no inhibition of *C. botulinum* inoculum even with a 156 µg/g of sodium nitrite added to the product. Adding

hemoglobin to the meat formulation reduced nitrite after processing and decreased botulinal inhibition. The degree of pigmentation of the meats is roughly grouped in descending order as follows: heart meat, beef round and turkey thigh meat, pork ham, veal, and turkey breast. Tompkin et al. [109] proposed the hypothesis that nitric oxide, which was formed from residual nitrite via nitrous acid, reacted with extracellular iron of cells, thereby blocking some metabolic step essential for outgrowth. The reaction might involve the iron in ferredoxin or an enzyme in which iron played an essential role [108]. The results of Miller and Menichillo [64] demonstrated that use of blood fractions that increased iron levels in beef above 30 µg/g interfered with the antibotulinal efficacy of sodium nitrite of 156 µg/g. Lucke [56] observed that blood sausages were associated with foodborne botulism in Germany. It is advisable to include additional microbial growth barriers when iron-containing compounds are added to cured meats [64].

Ingram [46] first postulated that nitrite inactivated enzymes associated with respiration. The active inhibitory agent outside the cell was closely correlated with nitrous acid, while the mechanism of action may vary for different physiological types of microorganism [122]. Nitrite was shown to inhibit active transport, oxygen uptake, and oxidative phosphorylation of *P. aeruginosa* by oxidizing ferrous iron of an electron carrier, such as cytochrome oxidase, to the ferric form [97]. Since glucose transport in *Streptococcus faecalis* and *Streptococcus lactis* is not dependent on active transport or cytochromes, nitrite does not inhibit these organisms [97]. Nitrite inhibited the active transport of proline in *E. coli* but not group translocation by the phosphoenolpyruvate:phosphotransferase system [122]. Inhibition of other enzymes, particularly those containing sulfhydryl groups can be achieved, but these effects usually occur at higher concentrations of nitrite [119].

There may be damage to the cell wall or membrane indicated by the graying or browning of *C. perfringens* cells incubated with inhibiting concentrations of sodium nitrite [75]. *Staphylococcus lactis* or *S. lactis* was highly resistant to nitrite, although aldolase was sensitive to nitrite. This suggested that these streptococci are impermeable to nitrite [122].

---

### 13.3 Interaction of Nitrites with Food Components

A water-soluble or low-molecular-weight compound was responsible for a large part of the nitrite depletion [23,105]. Sebranek et al. [98] found that nitrite bound to a hot water soluble and insoluble meat residue. An amino acid or oligopeptide (probably with an SH group) could be involved in the nitrite reduction. Fox and Nicholas [23] examined the effects of various compounds in meat slurries and found that histidine and reductants such as ascorbate and cysteine caused the nitrite depletion. Knowles et al. [52] investigated the interaction of nitrite with bovine serum albumin at gastric pH 2.5, and obtained 3-nitrotyrosine, 3,4-dihydroxyphenylalanine, and 6-hydroxynorleucine. Miwa et al. [69] mentioned that it is well known that primary amino acids react with nitrite to produce alcohol and nitrogen gas (van Slyke reaction). Among endogenous acidic substances tested, cysteic acid showed the highest ability to decompose nitrite, accompanying the production of unidentified N compounds. Woolford et al. [120] studied the reaction of nitrite with isolated myosin and showed that a part of the lost nitrite was bound to the protein and identified 3-nitrotyrosine as a major product of the reaction. The nitric oxide formed from nitrite may partly bind to protein [66] or ferricytochrome [104]. Frouin [25] concluded that nitrite was rapidly broken down to NO in meat products and reacted with unsaturated carbon-carbon bonds [26]. If whole adipose tissue was treated with nitrite, it was bound to connective tissue, extracted lipid, and unsaturated carbon-carbon bonds. The experiments on various fatty acids and glycerides showed a binding, which was apparently related to the degree of unsaturation [33].

Fujimaki et al. [27] studied the fate of nitrite during curing and cooking in the model solutions composed of myoglobin, sodium nitrite, and sodium ascorbate. After curing and cooking, nitrite was recovered as residual nitrite, nitrate, nitrosyl group of denatured nitrosomyoglobin, and gaseous nitrogen compounds. Almost all nitrite was recovered as nitrate whenever greening occurred in the curing period. The gaseous nitrogen compounds were produced under the condition where both sodium nitrite and sodium ascorbate were abundant as compared with myoglobin, and this reaction proceeded not in the curing period, but at the cooking stage. The addition of sodium chloride into the model system increased residual nitrite and nitrosomyoglobin [27]. Emi-Miwa et al. [22] also studied the fate of nitrite added to whole meat, meat fractions, and model systems with added sodium ascorbate. They found the residue as nitrite, nitrate, nitrosothiol,



denatured nitrosomyoglobin, and gaseous nitrogen compounds. Twenty percent of the total nitrite lost was changed to nitrosothiol-*N* when the specific interaction between nitrite and sulfhydryl groups of myosin was studied [54]. Olsman [76] also mentioned that more than half of the free nitrite disappeared on the storage of canned cured meat as bound nitrite, probably as nitrosothiols formed with protein-bound thiol groups. The amount of bound nitrite increased with the addition of ferrous ions. This may be due to the formation of ferric coordination complexes between cysteine residues and nitric oxide [77]. Cassens et al. [12] found typical distribution of nitrite in the proportions: myoglobin, 5%–15%; nitrate, 1%–10%; nitrite, 5%–20%; gas, 1%–5%; sulfhydryl, 5%–15%; lipid, 1%–5%; and protein, 20%–30%.

Namiki and Kada [73] found the formation of ethylnitrolic acid by the reaction of sorbic acid with sodium nitrite by heating at 90°C. The isolated compound ethylnitrolic acid was revealed to have a strong activity in comparison with the original materials. The ethylnitrolic acid, sorbic acid, and sodium nitrite were effective at concentrations of 0.025–0.05, 2–4, and 1.5–3 mg/mL, respectively. They also mentioned that ethylnitrolic acid is necessarily formed in foodstuffs containing sorbic acid and sodium nitrite together [73].

Osawa et al. [78] concluded that the main mutagen formed by the nitrite or sorbic acid reaction was 1,4-dinitro-2-methyl pyrole. The piperine was also the mutagen in nitrite system. Food components such as ascorbic acid, cysteine, and some phenolic compounds were reported to react with nitrite, thus preventing the formation of nitrosamines *in vitro* as well as *in vivo* [34,68]. Ascorbic acid was reported to inhibit bacterial mutations induced by *N*-nitroso compounds [36]. The oxidative desmutagenic action of cabbage peroxidase [47] and mieroperoxidase [121] against the mutagenic principles of tryptophan pyrolysate was also reported. The ascorbic acid, cysteine, and other reducing substances were responsible for the desmutagenic action against the mutagens of sorbic acid or nitrite system.

---

### 13.4 Functional and Sensory Properties Improvement

Taylor and Sumner [103] mentioned that food additives can play an important role in improving health, increasing supply, enhancing appeal, or improving convenience. Among these, health benefits should be given the greatest consideration, while supply benefits are second in importance, and increased convenience and improved appeal are the least important.

Nitrite salts are used for curing of meat, poultry, and fish products. Curing with nitrite results in the development of a characteristic pink color and distinctive flavor [31]. The sequence of color changes during curing of meat is [119]: (i) initial purple red color of myoglobin changes to the brown of metmyoglobin, (ii) in reducing conditions, nitric oxide derived from nitrite converts this into the dark red nitrosylmyoglobin, and (iii) if the meat is heated, e.g., in cooking, this pigment is converted into the stable nitrosylhemochrome, which is pink. Ando et al. [1] described that 5'-inosinic acid, adenosine-5'-monophosphoric acid, reduced glutathione, glutamate, and Fe<sup>2+</sup> influenced the cured color formation.

Nitrite content of 5 mg/kg can produce a satisfactory color for a short time, but it is generally believed that higher concentrations of about 20 mg/kg are necessary for commercial color stability. Nitrite concentrations of at least 50 mg/kg are thought to be necessary for correct flavor development [81,119]. The addition of nitrite at a minimum level of 50 ppm was necessary to achieve reasonably typical thuringer flavor and appearance characteristics in sliced and baked pizza-topping products. At least 100 ppm added nitrite was necessary to produce these effects in fried thuringer. The effect of added nitrite above 100 ppm was negligible for further color development. The fresh, fried, or baked thuringer containing neither nitrite nor nitrate was judged most rancid and of poorest flavor and appearance quality. No nitrosamines were detected in thuringer regardless of initial nitrite (0–150 ppm) or nitrate (0–1500 ppm) concentration, storage condition, or kitchen preparation method [18]. Pierson and Smoot [81] reviewed the minimum level of nitrite in different food products. These are 20 ppm for cured meat and hams, 30 ppm for bacon, 25 for wieners, 70 ppm for pork loins and country-style hams, 52 ppm for frankfurters, 26 ppm for franks, and 40 ppm for turkey frankfurters. The modification of the fresh meat flavor is another change produced in meat by the addition of nitrite. A minimum level of 39–50 ppm nitrite was required to develop the appropriate flavor [81].

Nitrite, upon addition to meat, has been associated with the delay of the development of oxidative rancidity [115]. When nitrite reacts with heme compounds to form cured meat pigments, the ferric iron (oxidized state, Fe<sup>3+</sup>), which is active in lipid oxidation, is reduced to ferrous (Fe<sup>2+</sup>), which is an inactive catalyst [81]. The addition of nitrite to model lipid systems containing Fe<sup>2+</sup> or Fe<sup>2+</sup>-EDTA and aqueous

beef extracts substantially reduced oxidation rates [57]. In bacon formulated without or with 15 ppm of nitrite, off-flavors were found to be high and increase more rapidly [41]. A significant reduction in the formation of rancid off-flavors in pork during storage was observed when nitrite was added in the amount of 50 ppm or greater [58,59].

Nitrites and nitrates inhibit dairy cultures by their effect on the activity of a number of oxido-reduction enzymes, and as a consequence the natural ripening of milk is prevented and undesirable microflora is formed [6]. Lactic acid bacteria culture in yogurt has beneficial effects on health. Korenekova et al. [53] studied the effects of nitrites and nitrates on yogurt culture up to a level of 100 mg/kg. They found that nitrites depending on their concentration were able to exert an inhibitory effect on a yogurt culture and nitrates are not marked inhibitors of lactic bacteria. Thus, nitrates can be used in yogurt to preserve its quality without inhibiting lactic acid bacteria.

---

### 13.5 Medical or Health Aspects

Two types of health benefits may be provided by food additives and food components: (i) those that prevent or reduce the incidence of specific diseases and (ii) those that provide enhanced nutrition [103]. It is a common attempt to develop an agent that inhibits or inactivates the undesired organisms but displays little toxicity toward humans when ingested [113]. NAS [74] concluded that 39% of dietary nitrite intake was from cured meat, 34% from baked goods and cereals, and 16% from vegetables. Cassens [11] mentioned that nitrate is important in the total picture because it is found in substantial quantities in other foods such as green leafy vegetables and root vegetables and sometimes in drinking water. No detectable nitrate in cured meats was observed.

Prolonged ingestion of sodium nitrite or sodium nitrate has shown to cause methemoglobinemia, especially in infants. Methemoglobinemia causes production of abnormal hemoglobin [74]. The major adverse effect of nitrites is the possible induction of cancer. In rats, it increases the incidence of lymphoma when fed with 250–2000 ppm nitrite in their food or water [72]. Nitrite results in the formation of carcinogenic *N*-nitrosamines with secondary amines or with substitute amides to form nitrosamides. Over 65 different nitrosamines detected in a variety of foods, including cheese, meats, mushrooms, and alcoholic beverages, have been found to be carcinogenic [60]. Epidemiological studies have indicated a possible link between exposure to high levels of nitrites and a high incidence of stomach and esophageal cancer [44,74]. Another well-known effect of nitrite is the lowering of oxygen transport by the bloodstream through the mechanism of oxidizing hemoglobin to methemoglobin [81]. Thus, nitrite level should be reduced in cured products. Ascorbates or erythorbates are added to reduce nitrosamine formation [31].

An oral challenge test with 30 mg of sodium nitrite may cause urticaria, intestinal disorders, or headache [40,70]. It may cause cellular anoxia and inhibit the protective enzymatic activities of the intestinal mucosa. This may lead to increased permeability of the mucosa to other antigens. In addition, sodium nitrite may in some way or other enhance the effect of histamine present in many foods [37].

The lethal dose of nitrites in humans is 32 mg/kg body weight or 2 g [9] and 4–6 g [111]. In 1973, the USDA established an expert panel on nitrates, nitrites, and nitrosamine. They concluded that (i) the use of sodium nitrate should be discontinued in all meat and poultry products, (ii) the nitrite level permitted for curing of meat should be limited to 156 µg/g in canned, cured sterile products, (iii) the permitted residual nitrite level should be reduced from 200 to 100 µg/g in cooked sausage products, 125 µg/g in canned and pickle cured products, and 50 µg/g in canned cured sterile products [74], and (iv) sodium nitrite (120 ppm) and potassium nitrite (140 ppm) be added to bacon along with sodium ascorbate or erythorbate (550 ppm) to assist in the prevention of nitrosamine formation [44]. The regulations in 1986 for nitrite in bacon allow one of the following: (i) 120 ppm sodium nitrite or 148 ppm potassium nitrite plus 550 ppm sodium erythorbate or isoascorbate, (ii) 100 ppm sodium nitrite or 123 ppm potassium nitrite plus 550 ppm sodium erythorbate or isoascorbate if a demonstration of adequate process control is met, or (iii) 40–80 ppm sodium nitrite or 49–99 ppm potassium nitrite plus 550 ppm sodium erythorbate or isoascorbate plus 0.7% sucrose and a lactic acid bacterial culture (*Pediococcus*). The level of nitrites allowed is a maximum of 10 ppm in smoked cured tuna fish and 200 ppm (input not to exceed 500 ppm) in smoked cured stable fish, salmon, shad, cod roe, and in home curing mixtures. The level in smoked chub is fixed at 100–200 ppm. The use of nitrite in other products is limited to a maximum residual level of 200 ppm [17].

The product development efforts have resulted in an entire new generation of cured meat products that are low in fat and formulated with ingredients not previously used [61]. White [116] reported an average residual nitrite in cured meats of 52.5 ppm and a range of 0 to 195 ppm residual nitrite in wieners. Recently, Cassens [11] found 5, 10, and 15 ppm residual nitrite on various cured meats in three trails of 164 samples. It is a reasonable conclusion that the current residual nitrite content of cured meats at retail in the United States is approximately 10 ppm. Cassens [11] mentioned that this change has undoubtedly resulted from (i) lowered ingoing nitrite, (ii) increased use of ascorbates, (iii) improved process control, and (iv) altered formulation. The mean value for the residual ascorbates was 209 ppm, which was nearly 40% of the maximum allowable addition of 550 ppm. The ascorbates routinely used are ascorbic acid, sodium ascorbate, erythorbic acid, and sodium erythorbate. Mirvish et al. [67] showed intragastric formation of *N*-nitrosamines in humans with higher doses of nitrate, but ascorbic acid inhibited their formation.

Nitric oxide is synthesized in the human body and is important to several physiological functions [11]. Cassens [11] mentioned that nitrite and its reaction products are important in human physiology. It is known that nitric oxide is formed in human body from nitrite. He reviewed the benefits of nitric oxide, which are: (i) it is a biological messenger important to the physiological functions of neurotransmission, blood clotting, blood pressure control, and immune system function and (ii) generation of salivary nitrite from dietary nitrate may also provide significant protection against gut pathogens in humans.

In some cases, the comparative risks are obvious. The risk of using nitrites and acquiring cancer from exposure to nitrosamines must be balanced against the risk of not using nitrites and acquiring botulism from cured meat. The comparative risks are more obscure or difficult to quantify [103].

---

## References

1. N. Ando, Y. Nagata, and T. Okayama, Proc. 17th Eur. Meeting Meat Res. Workers, Bristol, England, 1971.
2. L. Angermeier and H. Simon, On the reduction of aliphatic and aromatic nitro-compounds by *Clostridia*; the role of ferredoxin and the stabilisation, *Hoppe-Seyler's Z. Physiol. Chem.* 364:961, 1983.
3. J. Ashworth, A. Didcock, L. A. Hargreaves, B. Jarvis, and C. L. Walters, Chemical and microbiological comparisons of inhibitors derived thermally from nitrite with an iron thionitrosyl (Roussin black salt), *J. Gen. Microbiol.* 84:403, 1974.
4. J. Ashworth and R. Spencer, The Perigo effect in pork, *J. Food Technol.* 7:111, 1972.
5. A. C. Baird-Parker and M. A. H. Baillie, The inhibition of *Clostridium botulinum* by nitrite and sodium chloride, Proc. Int. Symp. Nitrite in Meat Prod., Zeist, The Netherlands, 1974, p. 77.
6. M. Baranova, P. Mal' a, and O. Burdova, Prestup duscianov do mlieka dojníc cestou traviaceho traktu, *Veterinarna Medicina* 38:581, 1993.
7. R. L. Buchanan, M. H. Golden, R. C. Whiting, and J. L. Smith, Nonthermal inactivation models for *Listeria monocytogenes*, *J. Food Sci.* 59:179, 1994.
8. R. L. Buchanan and M. Solberg, Interaction of sodium nitrite, oxygen, and pH on growth of *Staphylococcus aureus*, *J. Food Sci.* 37:81, 1972.
9. E. H. W. J. Burden, The toxicology of nitrates and nitrites with particular reference to the potability of water supplies, *Analyst* 86:429, 1961.
10. C. E. Carpenter, D. S. A. Reddy, and D. P. Cornforth, Inactivation of clostridial ferredoxin and pyruvate-ferredoxin oxidoreductase by sodium nitrite, *Appl. Environ. Microbiol.* 53:549, 1987.
11. R. G. Cassens, Use of sodium nitrite in cured meats today, *Food Technol.* 49:72, 1995.
12. R. G. Cassens, Residual nitrite in cured meat, *Food Technol.* 51:53, 1997.
13. R. G. Cassens, G. Woolford, S. H. Lee, and R. Goutefongea, Fate of nitrite in meat, Proc. 2nd Int. Symp. Nitrite Meat Prod., Centre for Agricultural Publishing and Documentation, Wageningen, The Netherlands, 1977, p. 95.
14. A. G. Castellani and C. F. Niven, Factors affecting the bacteriostatic action of sodium nitrite, *Appl. Microbiol.* 3:154, 1955.
15. F. K. Cook and M. D. Pierson, Inhibition of bacterial spores by antimicrobials, *Food Technol.* 37:115, 1983.
16. M. C. Custer and J. N. Hansen, Lactoferrin and transferrin fragments react with nitrite to form an inhibitor of *Bacillus cereus* spore outgrowth, *Appl. Environ. Microbiol.* 45:942, 1983.

17. P. M. Davidson and V. K. Juneja, Antimicrobial agents. In *Food Additives* (A. L. Branen, P. M. Davidson, and S. Salminen, Eds.), Marcel Dekker, New York, 1990, p. 83.
18. A. E. Dethmers, H. Rock, T. Fazio, and R. W. Johnston, Effect of added sodium nitrite and sodium nitrate on sensory quality and nitrosamine formation in thuringer sausage, *J. Food Sci.* 40:491, 1975.
19. C. L. Duncan and E. M. Foster, Effect of sodium nitrite, sodium chloride, and sodium nitrite on germination and outgrowth of anaerobic spores, *Appl. Microbiol.* 16:406, 1968.
20. C. L. Duncan and E. M. Foster, Nitrite-induced germination of putrefactive anaerobe 3679h spores, *Appl. Microbiol.* 16:412, 1968.
21. B. P. Eddy and M. Ingram, A slat-tolerant denitrifying *Bacillus* strain which 'blows' canned bacon, *J. Appl. Bacteriol.* 19:62, 1956.
22. M. Emi-Miwa, A. Okitani, and M. Fujimaki, Comparison of the fate of nitrite added to whole meat, meat fractions, and model systems, *Agric. Biol. Chem.* 40:1387, 1976.
23. J. B. Fox and R. A. Nicholas, Nitrite in meat. Effect of various compounds on loss of nitrite, *Agric. Food Chem.* 22:302, 1974.
24. A. Frouin, Nitrates and nitrites. The need to reconsider our conceptions and methods of analysis, 2nd Int. Symp. Nitrite Meat Prod., Pudoc, Wageningen, 1976.
25. A. Frouin, Nitrates and nitrites: reinterpretation of analytical data by means of bound nitrous oxide, Proc. 2nd Int. Symp. Nitrite Meat Prod., Centre for Agricultural Publishing and Documentation, Wageningen, The Netherlands, 1977, p. 115.
26. A. Frouin, D. Jondeau, and M. Thenot, Studies about the state and availability of nitrite in meat products for nitrosamine formation, Proc. 21st Eur. Meat Res. Workers, Berlin, 1975, p. 200.
27. M. Fujimaki, M. Emi, and A. Okitani, Fate of nitrite in meat-curing model systems composed of myoglobin, nitrite, and ascorbate, *Agric. Biol. Chem.* 39:371, 1975.
28. C. Genigeorgis and H. Riemann, Food processing and hygiene. In *Food-Borne Infections and Intoxications* (H. Riemann and F. L. Bryan, Eds.), Academic Press, New York, 1979, p. 613.
29. A. M. Gibson and T. A. Roberts, The effect of pH, water activity, sodium nitrite and storage temperature on the growth of enteropathogenic *Escherichia coli* and salmonellae in laboratory medium, *Int. J. Food Microbiol.* 3:183, 1986.
30. A. M. Gibson and T. A. Roberts, The effect of pH, sodium chloride, sodium nitrite and storage temperature on the growth of *Clostridium perfringens* and faecal streptococci in laboratory medium, *Int. J. Food Microbiol.* 3:195, 1986.
31. J. Giese, Antimicrobials: assuring food safety, *Food Technol.* 48:102, 1994.
32. G. W. Gould, Effect of food preservatives on the growth of bacteria from spores, 4th Int. Symp. Food Microbiol., *Microbial Inhibitors in Food* (N. M. Almquist and Wiksell, Eds.), Uppsala, 1964, p. 17.
33. R. Goutefongea, R. G. Cassens, and G. Woolford, Distribution of sodium nitrite in adipose tissue during curing, *J. Food Sci.* 42:1637, 1977.
34. J. I. Gray and C. J. Randall, *J. Food Prot.* 42:168, 1979.
35. H. S. Grindley, The influence of potassium nitrate on the action of bacteria and enzymes, *Studies in Nutrition*, University of Illinois, Urbana, 1929, p. 359.
36. J. B. Guttenplan, Inhibition by L-ascorbate of bacterial mutagenesis induced by two N-nitroso compounds, *Nature* 268:368-370, 1977.
37. T. Haahtela and M. Hannuksela, Food additives and hypersensitivity. In *Food Additives* (A. L. Branen, P. M. Davidson, and S. Salminen, Eds.), Marcel Dekker, New York, 1990, p. 617.
38. J. N. Hansen and R. A. Levin, Effect of some inhibitors derived from nitrite on macromolecular synthesis in *Bacillus cereus*, *Appl. Microbiol.* 30:862, 1975.
39. A. H. W. Hauschild, R. Hilsheimer, R. Jarvis, and D. P. Raymond, Contribution of nitrite to the control of *Clostridium botulinum* in liver sausage, *J. Food Prot.* 45:500, 1982.
40. W. R. Henderson and N. H. Raskin, "Hot-dog" headache: individual susceptibility to nitrite, *Lancet* 2:1162, 1972.
41. H. K. Herring, Effect of nitrite and other factors on the physicochemical characteristics and nitrosoamine formation in bacon, Proc. Meat Ind. Res. Conf., American Meat Institute, Chicago, 1973, p. 47.
42. R. A. Holley, Review of the potential hazard from botulism in cured meats, *Can. Inst. Food Sci. Technol. J.* 14:183, 1981.
43. C. N. Huhtanen and A. E. Wasserman, Effect of added iron on the formation of clostridial inhibitors, *Appl. Microbiol.* 30:768, 1975.

44. IFT, Expert panel on food safety and nutrition and committee on public information. Nitrate, nitrite and nitroso compounds in foods, *Food Technol.* 41:127, 1987.
45. K. Incze, J. Farkas, V. Mihalys, and E. Zukal, Antibacterial effect of cysteine-nitrosothiol and possible precursors thereof, *Appl. Microbiol.* 27:202, 1974.
46. M. Ingram, The endogenous respiration of *Bacillus cereus*. II. The effect of salts on the rate of absorption of oxygen, *J. Bacteriol.* 24:489, 1939.
47. T. Inoue, K. Morita, and T. Kada, Purification and properties of a plant desmutagenic factor for the mutagenic principle of tryptophan pyrolysate, *Agric. Biol. Chem.* 45:345, 1981.
48. L. R. Jensen, *Microbiology of Meats*, 2nd ed., Garrard Press, Champaign, IL, 1945.
49. M. A. Johnston and R. Loynes, Inhibition of *Clostridium botulinum* by sodium nitrite as affected by bacteriological media and meat suspensions, *Can. Inst. Food Technol. J.* 4:179, 1971.
50. M. A. Johnston, H. Pivnick, and J. M. Samson, Inhibition of *Clostridium botulinum* by sodium nitrite in a bacteriological medium and in meat, *Can. Inst. Food Technol. J.* 2:52, 1969.
51. J. Junttila, J. Hirn, P. Hill, and E. Nurmi, Effect of different levels of nitrite and nitrate on the survival of *Listeria monocytogenes* during the manufacture of fermented sausage, *J. Food Prot.* 52:158, 1989.
52. M. E. Knowles, D. J. McWeeny, L. Couchman, and M. Thorogood, Interaction of nitrite with proteins at gastric pH, *Nature* 247:288, 1974.
53. B. Korenekova, J. Kottferova, and M. Korenek, Observation of the effects of nitrites and nitrates on yogurt culture, *Food Res. Int.* 30:55, 1997.
54. G. Kubberod, R. G. Cassens, and M. L. Creaser, Reaction of nitrite with sulfhydryl groups of myosin, *J. Food Sci.* 39:1228, 1974.
55. R. V. Lechowich, J. B. Evans, and C. F. Niven, Effect of curing ingredients and procedures on the survival and growth of staphylococci in and on cured meats, *Appl. Microbiol.* 4:360, 1956.
56. F. K. Lucke, Heat inactivation and injury of *Clostridium botulinum* spores in sausage mixtures. In *Fundamental and Applied Aspects of Bacterial Spores* (G. J. Dring, D. J. Ellar, and G. W. Gould, Eds.), Academic Press, London, 1985, p. 409.
57. B. MacDonald, J. I. Gray, and L. N. Gibbins, Role of nitrite in cured meat flavor: antioxidant role of nitrite, *J. Food Sci.* 45:893, 1980.
58. B. MacDonald, J. I. Gray, Y. Kakuda, and M. L. Lee, Role of nitrite in cured meat flavor: chemical analysis, *J. Food Sci.* 45:889, 1980.
59. B. MacDonald, J. I. Gray, D. W. Stanley, and W. R. Osborne, Role of nitrite in cured meat flavor: sensory analysis, *J. Food Sci.* 45:885, 1980.
60. P. N. Magee and J. M. Barnes, Carcinogenic nitroso compounds, *Adv. Cancer Res.* 10:163, 1967.
61. R. W. Mandigo, Problems and solutions for low-fat meat products, Meat Ind. Res. Conf., Am. Meat Inst., Washington, DC, 1991.
62. M. K. McMIndes and A. J. Siedler, Nitrite mode of action: inhibition of yeast pyruvate decarboxylase (E.C. 4.1.1.1) and clostridial pyruvate:ferredoxin oxidoreductase (E.C. 1.2.7.1) by nitric oxide, *J. Food Sci.* 53:917, 1988.
63. J. Meyer, Comparison of carbon monoxide, nitric oxide, and nitrite as inhibitors of the nitrogenase from *Clostridium pasteurianum*, *Arch. Biochem. Biophys.* 210:246, 1981.
64. A. J. Miller and D. A. Menichillo, Blood fraction effects on the antibotulinal efficacy of nitrite in model beef sausages, *J. Food Sci.* 56:1158, 1991.
65. A. Mirna and K. Coretti, Uber den verleich von nitrite in fleischwaren. II. Untersuchungen uber chemische und bakterio-statische eigenschaften verschiedener reaktionsprodukte des nitrites, *Fleischwirtschaft* 54:507, 1974.
66. A. Mirna and K. Hofmann, Uber den verleich von nitrite in fleischwaren. I. Umsertzung von nitrit sulfhydryl verbindungen, *Fleischwirtschaft* 49:1361, 1969.
67. S. S. Mirvish, A. C. Grandjean, K. J. Reimers, B. J. Connelly, S. Chen, J. Gallagher, S. Rosinsky, G. Nie, H. Tuatoo, S. Payne, C. Hinman, and E. I. Ruby, Dosing time with ascorbic acid and nitrate, gum and tobacco chewing, fasting, and other factors affecting *N*-nitrosoproline formation in healthy subjects taking proline with a standard meal, *Cancer Epidem. Biomark. Prevention* 4:775, 1995.
68. M. Mirvish, L. Wallcave, M. Eagen, and P. Shubik, Ascorbate-nitrite reaction: possible means of blocking the formation of carcinogenic *N*-nitroso compounds, *Science* 177:65, 1972.
69. M. Miwa, A. Okitani, H. Kato, M. Fujimaki, and S. Matsuura, Reaction between nitrite and low salt-soluble diffusible fraction of meat. Some compounds influencing nitrite depletion and producing unidentified-N compounds, *Agric. Biol. Chem.* 44:2179, 1980.

70. D. A. Moneret-Vautrin, C. Einhorn, and J. Tisserand, Le role du nitrite de sodium dans les urticaires histaminiques d'origine alimentaire, *Ann. Nutr. Aliment.* 34:1125, 1980.
71. D. M. Moran, S. R. Tannenbaum, and M. C. Archer, Inhibitor of *Clostridium perfringens* formed by heating sodium nitrite in a chemically defined medium, *Appl. Microbiol.* 30:838, 1975.
72. M. Namiki and T. Kada, Formation of ethylnitrolic acid by the reaction of sorbic acid with sodium nitrite, *Agric. Biol. Chem.* 39:1335, 1975.
73. NAS, The health effects of nitrate, nitrite and *N*-nitroso compounds, Committee on Nitrite and Alternative Curing Agents, National Research Council, National Academy Press, Washington, DC, 1981.
74. P. M. Newberne, Nitrite promotes lymphoma incidence in rats, *Science* 204:1079, 1979.
75. V. O'leary and M. Solberg, Effect of sodium nitrite inhibition on intracellular thiol groups and on the activity of certain glycolytic enzymes in *Clostridium perfringens*, *Appl. Environ. Microbiol.* 31:208, 1976.
76. W. J. Olsman, Chemical behaviour of nitrite in meat products. 1. The stability of protein-bound nitrite during storage, Proc. 2nd Int. Symp. Nitrite Meat Prod., Centre for Agricultural Publishing and Documentation, Wageningen, The Netherlands, 1977, p. 101.
77. W. J. Olsman, Chemical behaviour of nitrite in meat products. 2. Effect of iron and ethylenediaminetetraacetate on the stability of protein bound nitrite, Proc. 2nd Int. Symp. Nitrite Meat Prod., Centre for Agricultural Publishing and Documentation, Wageningen, The Netherlands, 1977, p. 111.
78. T. Osawa, H. Ishibashi, M. Namiki, T. Kada, and K. Tsuji, Desmutagenic action of food components on mutagens formed by the sorbic acid/nitrite reaction, *Agric. Biol. Chem.* 50:1971, 1986.
79. J. A. Perigo and T. A. Roberts, Inhibition of clostridia by nitrite, *J. Food Technol.* 3:91, 1968.
80. J. A. Perigo, E. Whiting, and T. E. Bashford, Observations on the inhibition of vegetative cells of *Clostridium sporogenes* by nitrite which has been autoclaved in a laboratory medium, discussed in the context of sub-lethally processed cured meats, *J. Food Technol.* 2:377, 1967.
81. M. D. Pierson and L. A. Smoot, Nitrite alternatives, and the control of *Clostridium botulinum* in cured meats, *CRC Crit. Rev. Food Sci. Nutri.* 17:141, 1982.
82. M. Raevuori, Effect of nitrite and erythrostate on growth of *Bacillus cereus* in cooked sausage and in laboratory media, *Zentralbl. Bakteriol. Hyg. I, Abt. Orig. B* 161:280, 1975.
83. D. Reddy, J. R. Lancaster, and D. P. Cornforth, Nitrite inhibition of *Clostridium botulinum*: electron spin resonance detection of iron-nitric oxide complexes, *Science* 221:769, 1983.
84. H. Riemann, Safe heat processing of canned cured meats with regard to bacterial spores, *Food Technol.* 17:39, 1963.
85. H. Riemann, W. H. Lee, and C. Genigeorgis, Control of *Clostridium botulinum* and *Staphylococcus aureus* in semipreserved meat products, *J. Milk Food Technol.* 35:514, 1972.
86. W. E. Riha and M. Solberg, *Clostridium perfringens* inhibited by sodium nitrite as a function of pH, inoculum size and heat, *J. Food Sci.* 40:439, 1975.
87. T. A. Roberts, Inhibition of bacterial growth in model systems in relation to the stability and safety of cured meats, Proc. Int. Symp. Nitrite in Meat Prod., Zeist, The Netherlands, 1974, p. 91.
88. T. A. Roberts, The microbiological role of nitrite and nitrate, *J. Sci. Food Agric.* 26:1775, 1975.
89. T. A. Roberts, A. M. Gibson, and A. Robinson, Prediction of toxin production by *Clostridium botulinum* in pasteurized pork slurry, *J. Food Technol.* 16:337, 1981.
90. T. A. Roberts, A. M. Gibson, and A. Robinson, Factors controlling the growth of *Clostridium botulinum* types A and B pasteurized, cured meats. II. Growth in pork slurries prepared from 'high' pH meat (range 6.3–6.8), *J. Food Technol.* 16:267, 1981.
91. T. A. Roberts, A. M. Gibson, and A. Robinson, Factors controlling the growth of *Clostridium botulinum* types A and B in pasteurized, cured meats, *J. Food Technol.* 17:307, 1982.
92. T. A. Roberts, R. L. Gilbert, and M. Ingram, The effect of sodium chloride on heat resistance and recovery of heated spores of *C. sporogenes* (PA 3679/52), *J. Appl. Bacteriol.* 29:549, 1966.
93. T. A. Roberts and C. E. Gracia, A note on the resistance of *Bacillus* spp., faecal streptococci and *Salmonella typhimurium* to an inhibitor of *Clostridium* spp. formed by heating sodium nitrite, *J. Food Technol.* 8:463, 1973.
94. T. A. Roberts and M. Ingram, The effect of sodium chloride, potassium nitrate and sodium nitrite on the recovery of heated bacterial spores, *J. Food Technol.* 1:147, 1966.
95. T. A. Roberts and M. Ingram, Inhibition of growth of *C. botulinum* at different pH values by sodium chloride and sodium nitrite, *J. Food Technol.* 8:467, 1973.
96. T. A. Roberts, B. Jarvis, and A. C. Rhodes, Inhibition of *Clostridium botulinum* by curing salts in pasteurized pork slurry, *J. Food Technol.* 11:25, 1976.

97. J. J. Rowe, J. M. Yarbrough, J. B. Rake, and R. G. Eagon, Nitrite inhibition of aerobic bacteria, *Curr. Microbiol.* 2:51, 1979.
98. J. G. Sebranek, R. G. Cassens, W. G. Hoekstra, and W. C. Winder, <sup>15</sup>N tracer studies of nitrite added to a comminuted meat product, *J. Food Sci.* 38:1220, 1973.
99. J. L. Shank, J. H. Silliker, and R. H. Harper, The effect of nitric oxide on bacteria, *Appl. Microbiol.* 10:185, 1962.
100. H. L. A. Tarr, Action of nitrites on bacteria, *J. Fish. Res. Board Can.* 5:265, 1941.
101. H. L. A. Tarr, Bacteriostatic action of nitrites, *Nature* 147:417, 1941.
102. H. L. A. Tarr, The action of nitrites on bacteria: further experiments, *J. Fish. Res. Board Can.* 6:74, 1942.
103. S. L. Taylor and S. S. Sumner, Risks and benefits of foods and food additives. In *Food Additives* (A. L. Branen, P. M. Davidson, and S. Salminen, Eds.), Marcel Dekker, New York, 1990, p. 663.
104. A. M. Taylor and C. L. Walters, Biochemical properties of pork muscle in relation to curing. Part II, *J. Food Sci.* 32:261, 1967.
105. B. J. Tinbergen, Low-molecular meat fraction active in nitrite reduction, Proc. Int. Symp. Nitrite Meat Prod., Wageningen, 1974.
106. R. B. Tompkin, The role and mechanism of the inhibition of *C. botulinum* by nitrite—is a replacement available? Proc. 31st Ann. Reciprocal Meats Conf., Storrs, 1978.
107. R. B. Tompkin, L. N. Christiansen, and A. B. Shaparis, Variation in inhibition *C. botulinum* by nitrite in perishable canned comminuted cured meat, *J. Food Sci.* 42:1046, 1977.
108. R. B. Tompkin, L. N. Christiansen, and A. B. Shaparis, The effect of iron on botulinal inhibition in perishable canned cured meat, *J. Food Technol.* 13:521, 1978.
109. R. B. Tompkin, L. N. Christiansen, and A. B. Shaparis, Causes of variation in botulinal inhibition in perishable canned cured meat, *Appl. Environ. Microbiol.* 35:886, 1978.
110. R. B. Tompkin, L. N. Christiansen, and A. B. Shaparis, Iron and the antibotulinal efficacy of nitrite, *Appl. Environ. Microbiol.* 37:351, 1979.
111. H. J. Wagner, Vergiftung mit pokelsalz, *Arch. Toxikol.* 16:100, 1956.
112. A. E. Wasserman and C. N. Huhtanen, Nitrosamines and the inhibition of *Clostridia* in medium heated with sodium nitrite, *J. Food Sci.* 37:785, 1972.
113. B. M. Watts, Oxidative rancidity and discoloration in meat, *Adv. Food Res.* 5:1, 1954.
114. J. W. White, Relative significance of dietary sources of nitrate and nitrite, *J. Agric. Food Chem.* 23:886, 1975.
115. R. C. Whiting and M. O. Masana, *Listeria monocytogenes* survival model validated in simulated uncooked-fermented meat products for effects of nitrite and pH, *J. Food Sci.* 59:760, 1994.
116. R. Widdus and F. F. Busta, Antibotulinal alternatives to the current use of nitrite in foods, *Food Technol.* 36:105, 1982.
117. L. F. J. Woods and J. M. Woods, The effect of nitrite inhibition on the metabolism of *Clostridium botulinum*, *J. Appl. Bacteriol.* 52:109, 1982.
118. L. F. J. Woods, J. M. Wood, and P. A. Gibbs, The involvement of nitric oxide in the inhibition of the phosphoroclastic system in *Clostridium sporogenes* by sodium nitrite, *J. Gen. Microbiol.* 125:399, 1981.
119. L. F. J. Woods, J. M. Wood, and P. A. Gibbs, Nitrite. In *Mechanisms of Action of Food Preservation Procedures* (G. W. Gould, Ed.), Elsevier Science Publishers, Essex, 1989, p. 225.
120. G. Woolford, R. G. Cassens, M. L. Greaser, and J. G. Sebranek, The fate of nitrite: reaction with proteins, *J. Food Sci.* 41:585, 1976.
121. M. Yamanaka, M. Tsuda, M. Nagao, M. Mori, and T. Sugimura, *Biochem. Biophys. Res. Commun.* 90:769, 1979.
122. J. M. Yarbrough, J. B. Rake, and R. G. Eagon, Bacterial inhibitory effects of nitrite: inhibition of active transport, but not of group translocation, and of intracellular enzymes, *Appl. Environ. Microbiol.* 39: 831, 1980.

## **Part 3**

# **Preservation by Controlling Water, Structure, and Atmosphere**





# 14

## *Modified-Atmosphere Packaging of Produce\**

Leon G. M. Gorris and Herman W. Peppelenbos

### CONTENTS

14.1	Modified-Atmosphere Packaging—Rationale .....	316
14.2	Early Research on Modified-Atmosphere Packaging .....	316
14.3	Effects of Modified Gas Atmospheres .....	317
14.3.1	Reduction of Oxidative Reactions.....	317
14.3.2	Fermentation Reactions.....	317
14.3.3	Selective Impact on Microbial Growth .....	318
14.4	Types of Packages.....	318
14.4.1	Modified-Atmosphere Packaging .....	318
14.4.2	Controlled-Atmosphere Packaging .....	319
14.4.3	Active Packaging.....	320
14.4.4	Vacuum Packaging .....	320
14.4.5	Modified-Humidity Packaging .....	321
14.5	Important Parameters in Package Design.....	321
14.5.1	Product Characteristics .....	321
14.5.2	Package Characteristics.....	322
14.5.3	Modeling .....	322
14.6	Microbial Growth under Modified Atmospheres .....	324
14.6.1	Spoilage Microorganisms .....	324
14.6.2	Pathogenic Microorganisms .....	324
14.6.2.1	<i>Clostridium botulinum</i> .....	324
14.6.2.2	<i>Listeria monocytogenes</i> .....	325
14.6.2.3	<i>Aeromonas hydrophila</i> .....	325
14.6.2.4	<i>Yersinia enterocolitica</i> .....	325
14.6.2.5	<i>Bacillus cereus</i> .....	325
14.6.2.6	<i>Salmonella spp.</i> .....	326
14.6.2.7	<i>Staphylococcus aureus</i> .....	326
14.6.2.8	<i>Escherichia coli</i> .....	326
14.6.2.9	<i>Campylobacter jejuni</i> .....	326
14.6.2.10	<i>Disinfectant Usage</i> .....	326
14.7	Recommended MA Conditions for Produce .....	326
14.8	Future Outlook .....	328
	References .....	329

\* This chapter has not been updated from first edition.

---

## 14.1 Modified-Atmosphere Packaging—Rationale

Immediately after harvest, the sensorial, nutritional, and organoleptic quality of fresh produce will start to decline as a result of altered plant metabolism and microbial growth. This quality deterioration is the result of produce transpiration, senescence, ripening-associated processes, wound-initiated reactions, and the development of postharvest disorders. In addition, microbial proliferation contributes markedly to postharvest quality loss. The relative importance of individual deterioration processes in determining the end of the shelf life will depend upon specific product characteristics as well as upon external factors. Low temperature and proper hygienic handling of the material are the prime factors that control these processes. In addition, modified-atmosphere packaging (MAP) is a preservation technique that may further minimize the physiological and microbial decay of perishable produce by keeping them in an atmosphere that is different from the normal composition of air [2,26,31,47,62,82].

The MAP of respiring food products such as fresh and minimally processed produce requires a different approach than the MAP of nonrespiring foods. With nonrespiring foods, modified atmospheres (MA) without oxygen are used to minimize oxidative deterioration reactions, such as brown discoloration of meat or rancidity of peanuts, or reduce microbial proliferation, e.g., the growth of molds in cheese and bakery products. High gas barrier films or laminates are used to exclude the exchange of gases (especially O<sub>2</sub>) through the package, which would result in a less beneficial in-package gas atmosphere. In contrast, respiring products stay metabolically active after harvest, and this activity is essential for keeping their quality.

Aiming at the extension of the shelf life of respiring products through MAP, a prerequisite for a suitable packaging system will be that the composition of the gas atmosphere allows for a basic level of metabolism, which means that a certain amount of O<sub>2</sub> should be available. The required basic level of metabolism is highly at variance with different commodities (type and maturity) and heavily depends on the storage temperature and the degree of processing (trimming, cutting, slicing, etc.) applied. Owing to the significant respiratory activity of the product, the gas atmosphere inside the package changes during the course of the storage period, and expert knowledge about these changes is necessary to tailor the package design of an individual product to optimize quality shelf life.

The MAP of fresh and minimally processed fruits and vegetables is a preservation system that is non-sterile by design. Fruits and vegetables are characterized by an elaborate microflora, consisting of many different types of bacteria, molds, and yeasts, most of which are involved in the spoilage of the produce but are harmless to the human consumer. Microorganisms that are dangerous to humans (pathogens that are toxic or cause infectious diseases) normally cannot establish a dangerous population density because they have to compete with the spoilage microflora. However, packaging the produce will change the microenvironment perceived by the microorganisms and may well impair this safe balance. Consequently, evaluation of the impact of package design and use in the logistic chain is a mandatory exercise to assure consumer safety.

---

## 14.2 Early Research on Modified-Atmosphere Packaging

Packaging techniques based on altered gas conditions have a long history. Ancient Chinese writings report the transport of fruits in sealed clay pots with fresh leaves and grass added. The respiratory activity of the various plant products generated a low-oxygen and high-carbon dioxide atmosphere, which retarded the ripening of the fruit [42,59]. In the beginning of the nineteenth century, Berard [12] demonstrated that fruit placed in closed containers did not ripen. By the end of the nineteenth century, the first patent was granted covering the use of a CO<sub>2</sub>/CO mixture to extend the shelf life of meat [31]. Extensive research on the use of altered gas conditions for fruits tailed early in the twentieth century, with the work of Kidd and West [66]. Commercial storage under altered gas conditions was undertaken in England in 1929, when apples were stored in 10% CO<sub>2</sub> and ambient O<sub>2</sub> [64]. Reduced O<sub>2</sub> concentrations and increased CO<sub>2</sub> concentrations also proved to be beneficial for harvested products other than apples. Products with a high potential for a successful commercial application in MAP include apple, banana, broccoli, cabbage, cherry, chicory, and brussels sprouts. The first commercial application of MAP did not take place until 1974, when the technique was used for meat [31]. The use of MA for storage and packaging has increased steadily over the years and contributed strongly to extending the postharvest life and

maintaining the quality of fruits and vegetables [60]. In fact, the biggest growth in the use of MA has been for fresh fruits and vegetables, especially for minimally processed salads [31]. The technique of MA is now applied at a range of different sizes, i.e., for bulk storage packages (e.g., red currants), transport packages (e.g., bananas, strawberries), and consumer packages (e.g., apples, broccoli).

---

### 14.3 Effects of Modified Gas Atmospheres

The strategy of packaging produce under MA is to slow down the metabolic activity of the product as well as the growth of microorganisms (both spoilage and pathogenic) present by limiting O<sub>2</sub> supply and by application of an elevated level of CO<sub>2</sub>. Because the same strategy underlies refrigerated storage, MAP of respiring produce is usually combined with this technique. Many commodities, for instance, avocados, mangoes, papayas, and cucumbers, are very sensitive to low-temperature injury and should not be stored below about 13°C. Commodities like apples, broccoli, and pears are not sensitive to chilling and can be stored near 0°C without ill effect [100].

#### 14.3.1 Reduction of Oxidative Reactions

Plant parts such as seeds, fruits, leaves, or roots continue to live after harvest. The energy that plant cells need to stay alive or to proceed with ripening is generated by aerobic respiratory processes. Respiration involves the consumption of O<sub>2</sub> and the production of CO<sub>2</sub>. A reduction of respiration results in a lower energy supply and a reduced rate of changes within the product, like ripening [62]. To extend storage periods, conditions should be created that reduce respiration, for instance, by using low-temperature and low-O<sub>2</sub> concentrations. In general, the reduction of the respiration rate is regarded to be the process that is most strongly affected by altered gas conditions [5,69]. For certain fruits, low O<sub>2</sub> levels inhibit the production and action of the plant hormone ethylene, which results in reduced ripening as well [26]. Because respiration has such an important central position in the overall metabolism of a plant (part), its measurement is often used as a general measure of metabolic rate. Specific metabolic changes, however, may occur without measurable changes in net respiration [64]. Nevertheless, good quantification of the effect of reduced O<sub>2</sub> on respiration rates is essential for MA, as this process helps to generate the modified atmosphere inside MA packages.

With both whole, fresh produce and minimally processed produce, oxidative reactions do not only relate to respiratory activity. In addition, oxygen also has an effect on the activity of certain enzymes present in bruised or wounded tissue. Such enzymes are involved in wound repair reactions and in the defense against intruding microorganisms. Their activity depends on the presence of oxygen and is driven by the metabolic activity of the produce. The most studied enzyme is polyphenol oxidase (PPO), an enzyme that causes browning of plant tissues. In the case of minimally processed product (i.e., chopped, cut, sliced, and peeled), the level of tissue injury is much higher than the whole produce. Consequently, the level of metabolic activity and thus the respiration rate of minimally processed produce is often in orders of magnitude higher than that of the raw material. Also, enzymes such as PPO will be more active and may cause visible browning of cut surfaces. Such responses should be considered and overcome by choosing the correct MAP design. In the case where different types of minimally processed products are included in a MAP, which is often the case in mixed vegetable salads, conflicting levels of O<sub>2</sub> and CO<sub>2</sub> may be optimal for the individual components. A designer's solution for this problem needs to integrate all the different aspects that are important with regard to the quality features of the end product.

#### 14.3.2 Fermentation Reactions

The most optimal MA condition for a product is often considered to be the O<sub>2</sub> concentration, which is as low as possible with regard to product respiration without initiating fermentative reactions [5,26]. Fermentative reactions lead to the production of compounds such as acetaldehyde, ethanol, lactic acid, and ethyl acetate. Alcoholic fermentation is always found in plant tissues exposed to an environment without O<sub>2</sub> [81]. An increased concentration of ethanol and ethyl acetate is often related to quality problems such as off-taste and off-odor [65,67]. A strong correlation was found between ethanol and

ethyl acetate concentrations [65]. A relationship between other fermentative metabolites and off-flavors is less clear. With improved detection techniques, compounds like ethanol and acetaldehyde can even be detected at O<sub>2</sub> concentrations higher than those considered to be optimal for packaging of certain produce [80]. It seems that fermentation cannot be avoided completely and that it is not absolutely necessary to be avoided from the point of view of package design. Rather, it is important at what concentration of ethanol (or ethyl acetate) the consumer experiences off-odors or off-flavors. The package design should allow O<sub>2</sub> concentrations to be high enough to avoid an accumulation to that concentration. A complicating factor is that a relatively short period of too low O<sub>2</sub> concentrations can cause irreversible quality damage, because it has been found that strong off-flavors do not disappear once the favorable O<sub>2</sub> levels have been reestablished.

### 14.3.3 Selective Impact on Microbial Growth

For many minimally processed products, the main factor causing quality loss is not ripening or senescence, but microbial growth. The modified-atmosphere composition has a marked impact on the growth of spoilage microorganisms as well as on pathogens that occasionally occur in minimally processed produce [77]. The very low O<sub>2</sub> (typically 2%–3%) and moderately high CO<sub>2</sub> (5%–20%) levels prevailing inside a package slow down the proliferation of aerobic spoilage microorganisms [20,41,47,55,57–59,82]. The antimicrobial effect of CO<sub>2</sub> on microorganisms has been intensively documented [4,18,34–39,52,76]. However, it has been shown recently that only CO<sub>2</sub> levels well above 20%–50% significantly affect the growth of psychrotrophic pathogens that are relevant to MA-packaged produce [11]. This contradicts the general belief that CO<sub>2</sub> has very pronounced antimicrobial properties. At levels of O<sub>2</sub> and CO<sub>2</sub> that are generally favorable for storage of produce, there is certainly no beneficial effect of CO<sub>2</sub> [11,29].

In *in situ* studies, it was established that the specific conditions of MAP (reduced oxygen, increased carbon dioxide) can lead to marked changes in the epiphytic microflora, especially in chicory endive [10]. Thus, where there may be no direct antimicrobial effect of CO<sub>2</sub>, there is an influence on the composition of the microflora and on the competition that pathogens may experience in this ecosystem. A specific safety hazard is that psychrotrophic, facultative aerobic pathogens such as *Listeria monocytogenes* are not suppressed under MA conditions that are optimal for respiring produce [11,15,28,29]. On the contrary, growth may be enhanced in certain cases [3,10], especially because the MA conditions diminish the growth of spoilage microorganisms that would be the competitors of the pathogens.

---

## 14.4 Types of Packages

With MAP, the gas composition surrounding the produce inside the package is different from that outside the package. Outside, the gas composition is always close to 78.1 kPa nitrogen, 20.95 kPa oxygen, 0.93 kPa argon, and 0.036 kPa carbon dioxide. Several different types of packages and packaging techniques have been developed to accommodate MA around the produce, and these will be explained in detail below. The modification of the atmosphere generally implies a reduction of O<sub>2</sub> content or an increase of the CO<sub>2</sub> concentration, but in some cases changing the level of carbon monoxide (CO), ethylene, ethanol, or other compounds in the atmosphere can also contribute to shelf-life extension. Modified atmospheres can be created passively by the respiration activity of the product inside the package (product-modified MAP) or actively by introducing the desired gas mixture (gas packing). Other active ways of obtaining MA are the use of gas generators and scrubbers (controlled-atmosphere packaging [CAP]), evacuation of air (hypobaric storage, vacuum packaging), or addition of chemical systems that absorb or generate gases or volatile compounds (active packaging) in packages.

### 14.4.1 Modified-Atmosphere Packaging

In MAP, the gas composition within the package is not monitored or adjusted. Therefore, the term passive atmosphere packaging (PAM) is sometimes used in this respect. Depending on the oxygen sensitivity and metabolic activity of the product to be packaged, air or a predetermined gas mixture is used to flush

packages before closing. The use of ambient air as the packaging gas obviously is most economic, but is an option mainly when the respiration activity under the prevailing storage conditions is high enough to reduce the in-pack  $O_2$  level fast enough to lower levels that do not cause physiological or microbial deterioration. With produce highly sensitive to  $O_2$  (e.g., many minimally processed fruits) or those that have a low level of respiratory activity, flushing with a gas mixture composed of low oxygen and moderately high  $CO_2$  is often used to shorten the time needed to reach the desired in-pack gas composition. After closing the package, the respiration of the product will cause a decrease in the oxygen content and an increase in the carbon dioxide content. These altered gas concentrations, however, cause a decrease in the respiration rate. Finally, an equilibrium concentration inside the package is reached, which is the result of a balance between metabolic rates of the packed product and diffusion characteristics of the package materials. This explains the use of another term, equilibrium-modified atmosphere (EMA) packaging. The package is often designed in such a way that the equilibrium concentrations resemble the optimal gas concentrations found in experiments where products are stored under a range of stable gas conditions.

The course of the atmosphere modification is determined by three interacting processes: respiration of the commodity, gas diffusion through the commodity, and gas permeation through the film. Each of these processes is in turn strongly influenced by several commodity- and environment-generated factors. Respiration of a certain commodity depends, among others, on its physiological stage and temperature,  $O_2$  and  $CO_2$  partial pressures, relative humidity (RH), and ethylene concentration. Gas diffusion is affected by temperature, gas gradient across the limiting barrier, and the commodity's mass, volume, respiration rate, membrane permeability, and gas diffusion path. Some of these variables may vary with the maturity stage of the product or even the degree of illumination. Some variables affecting gas permeation through the film are temperature, gas gradient across the film and film structure, water vapor gradient, thickness, and surface area. A change in product amount, free volume, or any of the variables listed above will affect the EMA and the time in which the steady-state conditions are established. Flushing a package with a premixed gas will influence the time needed to attain the EMA.

Strict temperature control in the distribution chain would be a prerequisite for optimal use of MAP in practice, but in most countries the cooling chain between production, distribution, retail, and the consumer has many uncontrolled links. The changes in the permeabilities of most packaging films to gases in response to changes in temperature are generally lower than changes in product respiration. Most of today's existing plastic films do not have the proper  $O_2:CO_2$  permeability ratio to provide the ideal MA for many commodities at a given temperature. In view of all these variables and knowing that any change within or around the package will alter the dynamic equilibrium between the product and its environment, it is clear that knowledge about the limits of tolerance of a certain commodity is even more important for MAP than it is for CAP.

#### 14.4.2 Controlled-Atmosphere Packaging

In CAP, the altered gas composition inside the package is monitored and maintained at a preset level by means of scrubbers and the inlet of gases. This method closely resembles the practices used in large controlled-atmosphere (CA) storage facilities where produce is stored essentially unpacked in bulk, except that CAP is used for storage or transport of smaller quantities of produce.

Additionally, new areas of attention in CA storage today are ultra-low oxygen (ULO) storage and dynamic CA storage. Obviously these techniques can be used in CAP as well. The ULO storage uses  $O_2$  levels close to the minimum level required for maintenance of plant tissues; lower levels will induce disorders such as browning and tissue necrosis. Using ULO storage at  $1^\circ C-2^\circ C$  with preset levels of 0.5%–1%  $O_2$  and 2%–3%  $CO_2$ , for instance, Elstar apples can be stored for almost a whole year without unacceptable quality loss. In the case of dynamic CA storage, sometimes referred to as interactive CA storage, gas levels are not controlled at preset levels but are continuously adapted to the physiological response of the produce [98], for instance, by monitoring fermentation products or cell degradation products. In this way, an optimal match is made between the physiological demand and tolerance of a product and the storage conditions. Although this concept is still in development for CA [87], comparable ideas have been described for packages (see below).

### 14.4.3 Active Packaging

In some cases, a package cannot be designed in such a way that optimal conditions will be reached passively. “Active packaging” can then provide a solution, by adding materials that absorb or release a specific compound in the gas phase. Compounds that can be absorbed are carbon dioxide, oxygen, water vapor, ethylene, or volatiles that influence taste and aroma. For some leafy vegetables, carbon dioxide levels can induce browning of tissues, while for most fruits increased ethylene levels cause an acceleration of ripening. Even at rather low levels, depending on the type of produce, ethylene can induce senescence and maturation processes that reduce the fresh product quality. Inclusion of ethylene scrubbers like potassium permanganate counteracts the effect of ethylene, although the capacity of such scavengers is finite. In transport packages for grapes, pouches are often added that slowly release sulfur-containing chemicals to reduce fungal growth. Recently, research has been directed to replacing chemicals with compounds retrieved from plant tissues (“green chemicals”). How much of the active compounds needs to be added will depend on a range of interacting factors, such as production rates (carbon dioxide, ethylene), concentrations to be reached, how long the package should be functional, etc. Various possibilities exist, although precise control of O<sub>2</sub> in such packages is not possible [26].

Recently, a number of new “intelligent” concepts have been introduced that involve more than only scrubbing or emitting compounds. These types of packages will only become “active” when a specific prerequisite has been met. Most of these packages focus on prevention of problems associated with anaerobic conditions. In one such system, holes are introduced in the package upon exposure to high temperatures for a certain time; originally, the holes are closed by solid hydrocarbons that have melting points between 10 and 30°C [26]. Because respiration of a product often increases at a faster rate than the diffusion of gases with a rise in temperatures, the hole in the package will prevent the depletion of O<sub>2</sub>. Another idea is a sensor for ethanol mounted on a package that informs possible buyers of the history of the package in terms of possible mechanical damage or temperature abuse [26]. Yet another concept, which has seen some use in, for instance, France and the United States, is the “time–temperature indicator” or “time–temperature integrator” (TTI). TTIs used now are in most cases small devices that, attached to the package, will indicate the combined time and temperature history of that product by a gradual change color [92,97]. TTIs integrate the time and temperature by specific enzymatic or chemical reactions that, ideally, have an identical rate constant to the quality or safety feature of the packed product. The consumer can compare the actual color at the time of intended purchase with the indicated sell-by limit color. A TTI is an elegant and user-friendly improvement that informs consumers of the expected shelf life at the point of sale. The concept could well be extended to the home situation.

### 14.4.4 Vacuum Packaging

Whereas MAP and CAP mostly operate at ambient pressure (101 kPa), storage at reduced atmospheric pressures has been experimented with and, in some cases, has been used for bulk storage (e.g., in the so-called hypobaric storage systems designed by Stanley Burg [23,24] almost a quarter of a century ago. In the Burg system, produce is stored under atmospheric pressure in the range of about 1–10 kPa at refrigerated temperatures. At this low pressure, a constant circulation of fresh air, substantially saturated with water (RH 80%–100%), is maintained. Facilities to constantly scrub CO<sub>2</sub> and ethylene could be included as well. Although the system performed rather well, and shelf lives of different horticultural and floricultural products could be extended 3- to 10-fold, it was technically complex and for this reason was never used as widely as CA or MA storage. Vacuum packaging (VP) may be regarded as a special type of MAP, since part of the normal headspace is removed, leaving an altered initial atmosphere that is not controlled after packaging. VP puts quite a pressure strain on produce and is only suitable when the product is sufficiently durable.

Using a VP system—called a moderate VP system because it operates at 40 kPa—a significant prolongation of quality shelf life at 8°C was obtained with a range of minimally processed fruits and vegetables [48]. In this system, the initial gas composition is that of normal air, but because of the reduced partial gas pressure, the amount of O<sub>2</sub> available at the start of storage is about one-third of the normal amount. As with MAP, the lower O<sub>2</sub> content stabilizes the postharvest product quality by slowing down the metabolism of the produce and the growth of spoilage microorganisms. Compared to refrigeration-only

storage, refrigerated storage under moderate vacuum was found to improve microbial quality (e.g., red bell pepper, chicory endive, sliced apple, sliced tomato), sensory quality (e.g., apricot, cucumber), or both (e.g., mung bean sprouts and a mixture of cut vegetables). In some instances, no beneficial effect (mushroom, green bell pepper, and a mixture of cut fruits) or an impeded decrease in sensory quality (strawberries, alfalfa) was noticed. With cut products (vegetables and fruits salad mixes, chicory endive, apple), VP strongly retarded enzymatic browning of the cut surfaces.

#### 14.4.5 Modified-Humidity Packaging

MAP, CAP, and VP all focus on changing the metabolic gases oxygen and carbon dioxide. Modified-humidity packaging (MHP), however, is designed for products where dehydration causes the most important quality losses, and therefore focuses on controlling water vapor levels. When products such as leafy vegetables or bell peppers are not packed, quality losses can be observed very soon (e.g., wilting and shriveling). In most “closed” packages such as MAP, CAP, and VP, the RH is close to saturation due to the water exchange between the product and the headspace. This high humidity increases the probability of condensation and free water accumulating directly on the product, especially when the package is exposed to changing temperatures. Therefore, MHP systems are designed to control not only dehydration but also condensation. The in-pack RH is influenced by the rate of water loss (transpiration) of the product and the transmission rate for water vapor of the package, which are dependent on the prevailing water vapor pressure and temperature of storage. Temperature is one of the most important factors determining the in-pack RH. Weight loss relates more exactly to the vapor pressure deficit than to RH, but at constant temperature weight loss has a linear relationship with relative humidities above 75%–85% [50]. At higher temperatures, the air can contain more water vapor, thereby decreasing the RH value. A package designed to have a high RH at a high temperature will show condensation on the package surface or on the product if the temperature is decreased substantially. To counteract the effect of condensation, films have been developed that are coated with an antifog layer, due to which moisture forms a continuous layer rather than separate droplets on the surface of a film. This allows a clear view of the product and prevents water from forming a pool at the bottom of the package.

For many products, transpiration must be reduced to maintain quality. Products with a large surface area, such as lettuce and endive, are very susceptible to wilting. Bell peppers and tomatoes also benefit from good control of RH [9,88]. Reducing water loss is one of the main aspects related to packaging of minimally processed products, despite the usual emphasis on gas levels [26]. On the other hand, for products such as onions and flower bulbs, humidity should not be too high, as it results in increased sprouting. Like O<sub>2</sub> and CO<sub>2</sub>, water vapor levels can be too high or too low, and an optimum level should be reached. For (Israeli) bell peppers, this level was estimated to be 92% RH at 8°C [83]. A lower RH caused too much weight loss, while a higher RH caused decay. Especially for products where water loss is the predominant cause of quality changes (e.g., bell pepper and tomato), MHP can be effectively used to minimize loss of quality. In such cases, the concentrations of oxygen and carbon dioxide in MHP are often close to that of ambient air.

Many commercially available packaging materials that have favorable gas-permeability characteristics for a certain commodity cannot be used because they have a rather low permeability for water vapor. When the in-pack RH is very high ( $\geq 95\%$ ), a small fluctuation in storage temperature results in condensation, which greatly enhances the proliferation and spread of spoilage microorganisms. Especially for fruits, the high RH conditions cause heavy losses due to microbial decay. Control of the in-package RH may be pursued through the use of packaging materials with high water vapor permeabilities, by inclusion of sachets containing water absorbers like CaCl<sub>2</sub>, sorbitol, or xylitol in the package (“active packaging”) or by use of packaging materials with suitable gas permeabilities onto which such desiccants are coated [6,7,81].

---

## 14.5 Important Parameters in Package Design

### 14.5.1 Product Characteristics

Before a package can be designed, detailed knowledge about the physiological characteristics of the product to be packed and the environmental conditions the package is exposed to after production is essential. Many specific parameters need to be known. Important are not only the optimal O<sub>2</sub>, CO<sub>2</sub>, and



water vapor levels, but also the upper and lower limits of these components beyond which damage can be expected. When low  $O_2$  or high  $CO_2$  is beneficial, it becomes important to quantify the relationship between gas conditions and gas-exchange rates. For good quantification,  $O_2$  uptake and  $CO_2$  production should be measured under a range of  $O_2$  and  $CO_2$  concentrations. Such data sets, however, are still scarce.

Another important product aspect is the influence of light on color changes, for instance, with chicory endive, which changes from the preferred yellow-white to the undesired green color under excess illumination. It is also important to know what mechanical properties of the package should have when delicate products such as berries are to be packaged without any mechanical damage.

### 14.5.2 Package Characteristics

An important aspect of package design is the selection of the packaging material, and this can be a cumbersome exercise. Exama et al. [40] studied the possible application of 20 different types of polymer films and were still not able to find a suitable match with products with a high respiration rate. Using too-high-barrier package film,  $O_2$  will be fully depleted and fermentation will lead to off-odors and off-flavors. Also, the right combination of low  $O_2$  and high  $CO_2$  is crucial. This highlights two decisive aspects in selecting films: (a) the permeability for  $O_2$  and  $CO_2$  at the temperature to be used and (b) the ratio between  $O_2$  and  $CO_2$  permeability. A serious drawback is that gas permeability specifications given by film manufacturers are usually determined under conditions remote from the high-humidity refrigerated storage conditions of respiring produce. Thus, it is impossible to deduce only from the specifications provided by film manufacturers whether a specific film would provide for an in-package gas atmosphere with tolerable  $O_2$  and  $CO_2$  levels when applied in practice. Thus, the suitability of a film must be tested with the product under the correct practical conditions.

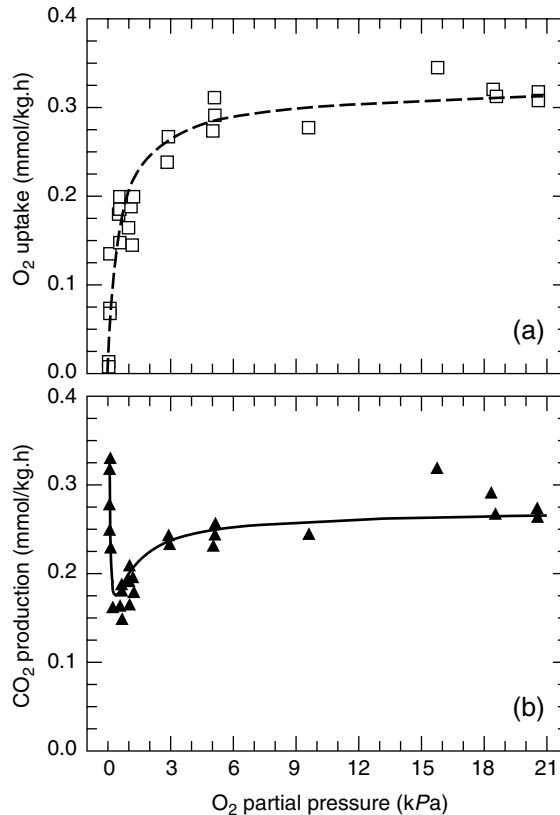
In addition to permeability of the metabolic gases, permeability for water vapor, ethylene, and volatiles can be important. A low permeability for water vapor can increase the risk for condensation. Condensation should always be avoided, since it generates an ideal climate for microbial growth. Also, discoloration of the product can result from condensation.

Currently, polyethylene (PE) and polyvinyl chloride (PVC) films are the most often used polymers. In the past decade, a new type of film was introduced with very small holes (microperforation) as the main pathway for diffusion [95]. The interesting aspect of these films is that diffusion of  $O_2$  and  $CO_2$  through the film is equal. This enables the creation of packages with both low  $O_2$  and high  $CO_2$  concentrations. Such atmospheres are especially suitable for minimally processed products but also for unprocessed products with extremely high respiration rates such as asparagus, broccoli, mushrooms, or mung bean sprouts.

In addition to the selection of the type of film, other important aspects include thickness of the film, the surface area used, the package volume, and for films with microperforation, the number of holes per area. Film thickness, film area, and the number of holes influence the equilibrium gas composition inside the package. Varying package volume and the free volume inside the package influences the rate at which gas concentrations are changing. The final equilibrium concentrations will be equal, but the moment in time at which these concentrations are reached can differ by varying the volume.

### 14.5.3 Modeling

Since there are so many variables to take into account in package design, a trial-and-error type of approach can lead to numerous attempts to find the best package. The risk is that the best package will not be found. Sufficient control of the many different factors interacting in determining the atmosphere change in a MAP can only be achieved with the help of mathematical modeling [101]. Mathematical models may provide a means to determine and predict important packaging specifications. When optimal (equilibrium) gas conditions are known as well as the respiratory response to various  $O_2$  and  $CO_2$  concentrations, the suitable permeability characteristics of the package can be mathematically deduced. The most frequently used models that relate gas conditions to  $O_2$  uptake and  $CO_2$  production are based on Michaelis–Menten kinetics [5,26,68]. Although an inhibition of  $CO_2$  on respiration is not found for all products, Peppelenbos and van't Leven [79] examined which type of inhibition best described the influence of  $CO_2$ . The models of Banks et al. [5] or Peppelenbos et al. [78] can be applied best when not only respiratory  $CO_2$  but also



**FIGURE 14.1** Gas exchange rates of strawberries (*Fragaria ananassa* cv. *Elsanta*) at 4°C. (a) O<sub>2</sub> uptake rates (□) with O<sub>2</sub> uptake model. (b) CO<sub>2</sub> production rates (▲) with CO<sub>2</sub> production model. (From Peppelenbos et al., *Postharv. Biol. Technol.*, 9:283, 1996.)

fermentative CO<sub>2</sub> production needs to be calculated. An example of gas-exchange modeling is given in Figure 14.1, where at low O<sub>2</sub> concentrations CO<sub>2</sub> production increases due to enhanced fermentation.

The description of gas diffusion through packaging materials is mostly done by applying Fick's law [26]. Although all models mentioned above are static, they can be incorporated into dynamic models to be used for the prediction of changing gas conditions inside a package [56]. Packages can be easily designed with such dynamic models by changing variables such as film type, surface area, and amount of product packed. A very useful extension of simulation models would be the incorporation of expected variance of the achieved equilibrium conditions. Using expected variance, not only can optimal packages be designed, but so can (sub)optimal packages that are also safe. A survey of this variance has already been carried out for broccoli by Talasila et al. [91].

Since temperature in the distribution chain often cannot be strictly controlled, another interesting feature of dynamic modeling is the possibility of simulating products passing through the different links of the distribution chain. Using simulation, for instance, the dynamics of the gas composition inside the package can be evaluated to determine whether gas conditions will remain within the limits of tolerance of the commodity. When necessary, the use of different packaging films can be simulated to obtain the most optimal equilibrium modified-atmosphere condition. The end result of the modeling exercise, however, could be that there is no suitable packaging film available commercially that would be suitable for use. Instead of not packing the product, this information could be used to further improve distribution chains or give suggestions to the packaging industry, defining the requirements for new films in terms of their temperature sensitivity, CO<sub>2</sub>:O<sub>2</sub> permeability ratio, etc.

Once proper models have been created and integrated in package design, they should be mandatory in the development of packages that achieve optimal gas conditions at dynamic temperatures encountered

in practical situations and of packages that can overcome fluctuations in temperature, which temporarily cause gas conditions to exceed tolerance limits but do not affect product quality.

---

## 14.6 Microbial Growth under Modified Atmospheres

### 14.6.1 Spoilage Microorganisms

Fresh fruits and vegetables normally have an elaborate spoilage microflora, due to intensive contact with various types of microorganisms during growth and postharvest handling. The high acidity of many fruits (pH < 4.6) limits spoilage to acid-tolerant molds, yeasts, and lactic acid bacteria. Vegetables generally have a pH around 6.0–7.0 and lack this intrinsic protection. Microbial spoilage of undamaged, healthy products can only be effectuated by microorganisms that are able to penetrate through the skin, which requires the presence of specific enzyme systems. In vegetables, pectinolytic Gram-negative bacteria of the genera *Pseudomonas* and *Enterobacter* are often involved in spoilage. The effect of MAP, and in particular carbon dioxide, on spoilage organisms is distinctly selective, but it is possible to make some broad generalizations. Molds exhibit sensitivity, while yeasts are comparatively resistant. Different species of bacteria, on the other hand, vary greatly in sensitivity. For example, aerobic organisms such as *Pseudomonas*, *Micrococcus*, and *Bacillus* are inhibited by CO<sub>2</sub>, while the *Lactobacillus* species are more resistant. On the other hand, facultative anaerobes such as *Escherichia coli* are comparatively less affected by the level of CO<sub>2</sub> and more by the level of O<sub>2</sub>. Most spoilage organisms that pose a quality problem in produce are aerobic, thus a limited supply of O<sub>2</sub> hampers their growth potential. Nitrogen has little inhibitory effect except in displacing oxygen.

Spoilage microorganisms usually pose no safety problem for consumers. The main concern is that applications of MA diminish the competition for oxygen, carbohydrates, other nutrients, and space between spoilage microorganisms and pathogens. This may allow the growth of certain pathogens to hazardous levels, especially during extended shelf life. In addition, the problem of product temperature abuse, either during manufacture, distribution, and retail or by the consumer, must also be considered. In those cases, spoilage microorganisms may be important safety indicators, giving an organoleptic warning signal to consumers that the food product has been mishandled or kept beyond its shelf life and therefore may not be safe to eat. However, when technologies such as MAP are used to extend the product shelf life by suppressing spoilage organisms but not all hazardous pathogens, situations could occur in which the packaged food is organoleptically unspoiled but very unsafe to eat.

### 14.6.2 Pathogenic Microorganisms

Most fruit products have too low a pH to permit growth of pathogenic bacteria—only figs, peaches, and tomatoes, whose pH is potentially in the range 4.6–4.8, may permit pathogenic growth. In the early days of MAP, attention was focused primarily on anaerobic pathogens, especially proteolytic *Clostridium botulinum*, which produces a deadly toxin but does not grow below 10°C. Since nearly all MAP foods are refrigerated, focus has been mainly on the survival and outgrowth of cold-tolerant pathogens such as *Yersinia enterocolitica* and *L. monocytogenes* that can proliferate under low-oxygen conditions [15,82]. An important factor with respect to microbial safety is whether the MAP food is intended for direct consumption or requires heating before consumption. With MAP foods that are cooked before being eaten, vegetative pathogens should all be killed, provided that the cooking instructions are properly followed. However, the majority of MAP produce is sold as “ready-to-eat.” The main potential sources of pathogenic bacteria in fresh and minimally processed produce are the raw material, ingredients, plant workers, as well as the processing equipment and environment. The main pathogens of possible concern to MAP are described below.

#### 14.6.2.1 *Clostridium botulinum*

Because of the potency of their toxin, the potential growth of *Clostridium* sp. in MAP foods has been of especially great concern [90]. The organisms can be present in soils and can thus come into contact with fruits and vegetables easily. *C. botulinum* is not markedly affected by the presence of CO<sub>2</sub>, and growth is encouraged by the anaerobic conditions that may exist in MAP. Most strains of *C. botulinum* do not grow at temperatures below 10°C, although nonproteolytic *C. botulinum* types B, E, and F have been

recorded as growing and producing toxins at temperatures as low as 3.3°C. Botulism has been linked to coleslaw prepared from MA-packaged, shredded cabbage mixed with coleslaw dressing [63,89]. Shredded cabbage onto which spores of *C. botulinum* types A and B were inoculated and that subsequently was MA-packaged and held at room temperature was found organoleptically acceptable after 6 days, yet type A toxin production was apparent on day 4. A pungent odor was produced and released on opening the bag, after which the cabbage smelt normal. A recent survey by Lilly et al. [72] on the incidence of *C. botulinum* in MAP and VP vegetables involving 1118 packages of a variety of precut produce (including cabbage, pepper, coleslaw, carrot, onion, broccoli, mixed vegetables, stir-fry vegetables, and various salad mixes) found that one package each of shredded cabbage, chopped green pepper, and Italian salad mix contained *C. botulinum*-type spores, while an additional salad mix (main ingredient, escarole) contained both *C. botulinum* type A and type B spores. The overall incidence rate (0.3%–6%) of *C. botulinum* spores thus may be quite low in commercially available precut vegetables.

#### 14.6.2.2 *Listeria monocytogenes*

The widespread presence of this organism in the environment and its ability to grow at low temperatures make it a pathogen of special concern. A serious outbreak of listeriosis was thought to be derived from cabbage fertilized with manure from infected sheep [86]. In many studies carried out since this outbreak on a variety of produce, it was frequently established that *L. monocytogenes*, when the organism was inoculated onto vegetables, grew as well under MA or CA conditions as in air at 4°C or 15°C [3,13,16,17,27,29,43,45]. By now, growth of this pathogen under MA conditions has been reported for asparagus, broccoli, cauliflower, lettuce, and chicory endive. Studies by Carlin et al. [28] investigated the fate of *L. monocytogenes* in minimally processed foods in the presence of nonpathogens and at temperatures ranging from 3°C to 20°C. It was shown that on unspoiled products *L. monocytogenes* would hardly grow more than 2 log units whatever the storage temperature, but that spoilage of the salad leaves would permit a rapid multiplication. Low storage temperatures reduced the growth of *L. monocytogenes* more than that of the spoilage microflora and are therefore a factor of improving safety. Carbon dioxide concentrations of 10%–20% reduce spoilage development and growth of the spoilage microflora, whereas higher concentrations slightly increased growth of *L. monocytogenes*. On minimally processed green endive, it was found that that high inoculum concentrations overestimated the maximum growth of *L. monocytogenes*. Again, the epiphytic microflora of green endive leaves had a barrier effect against *L. monocytogenes*.

#### 14.6.2.3 *Aeromonas hydrophila*

This psychrotrophic organism is also widespread in the environment and is mainly waterborne. It has been found in drinking water, fresh and saline water, and sewage water. Cytotoxic strains have been found on seafood, meats, and poultry, as well as on fresh produce, parsley, spinach, celery, and endive. The pathogen grows rapidly at refrigeration temperature [44]. Berrang et al. [14] observed that *Aeromonas* could grow to population densities exceeding 10<sup>6</sup> CFU/g within 2 weeks at 4°C on asparagus, broccoli, and cauliflower and that CA conditions did not markedly affect its growth potential.

#### 14.6.2.4 *Yersinia enterocolitica*

Animals, specifically swine, are the predominant natural source of *Y. enterocolitica*. However, this cold-tolerant pathogen has also been isolated from raw vegetables. As with the former two pathogens, modified atmospheres optimal for produce do not hamper its growth at refrigeration temperature. With little oxygen (1.5%) present, carbon dioxide levels as high as 50% were found to be required before its growth was significantly reduced [11].

#### 14.6.2.5 *Bacillus cereus*

This bacterium, a common contaminant of vegetables, does not usually grow below 10°C [53]. However, recent reports have shown that some enterotoxigenic strains can grow at temperatures as low as 4°C and produce toxin at 8°C. *B. cereus* is rather susceptible to the antimicrobial effects of CO<sub>2</sub> [11], and CO<sub>2</sub>-rich environments severely reduce the ability of the spores to germinate.

#### 14.6.2.6 *Salmonella* spp.

This organism is most commonly associated with animals and birds and is only present on vegetables through cross-contamination. Nevertheless, two large outbreaks of salmonellosis have been attributed to fresh produce, both involving tomatoes stored at ambient temperatures [54,99]. *Salmonella* species have also been implicated in smaller outbreaks in which raw bean sprouts and different types of melons were the vehicles. Although high levels of CO<sub>2</sub> retard the growth of *Salmonella*, generally the inhibitory effect on the organism is largely dependent on decreased temperature. Most *Salmonella* species are mesophilic bacteria, but many isolates survive well during storage at 5°C [46].

#### 14.6.2.7 *Staphylococcus aureus*

*S. aureus* does not grow well under chill conditions or in the presence of competing microorganisms. The pathogen has been found on fresh produce and ready-to-eat vegetable salads. It is known to be carried by food handlers. Generally, CO<sub>2</sub> has an adequate inhibitory effect on the growth of *S. aureus* when combined with low-temperature storage.

#### 14.6.2.8 *Escherichia coli*

*E. coli* is a mesophilic bacteria often used as an indicator of fecal contamination. Enterotoxigenic *E. coli*, the common cause of travelers' diarrhea, is regularly detected on raw vegetables. Strains can grow at temperatures below 10°C, but not usually below 7°C. Some strains reportedly are able to grow and produce toxin at 5°C. Growth of this organism can be inhibited by high levels of CO<sub>2</sub>. Enterohemorrhagic *E. coli* O157:H7 is recognized as an important emerging pathogen. Outbreaks of this pathogen have been associated with unpasteurized apple cider and cantaloupe. Also, broccoli is suspected to have carried this type of *E. coli*. MAP had no effect on pathogen growth on shredded lettuce and cucumber in experiments in which storage temperatures were 12°C and higher [1,33].

#### 14.6.2.9 *Campylobacter jejuni*

This organism is still one of the major causes of bacterial enteritis. Poultry and other foods of animal origin are the main sources. The pathogen has been implicated in diseases caused by consumption of fruits and vegetables. Cross-contamination of fresh produce with *C. jejuni* from poultry meats has been suspected. The pathogen has been found to survive sufficiently on sliced watermelon and papaya to be a risk for consumers. Total absence of oxygen was noted, whereas survival, without growth, was enhanced in an atmosphere of 100% N<sub>2</sub>. Optimal growth has been documented to occur under atmospheres of reduced oxygen level and high temperatures (42°C–45°C). The minimum growth temperature reportedly is 32°C, so the risk with consumption of refrigerated MAP produce should be minimal.

#### 14.6.2.10 Disinfectant Usage

The use of disinfectants to reduce the microbial load of minimally processed fresh salads is permitted and practiced in many countries around the world. It has been found that after disinfection, the surviving spoilage microorganisms have an increased growth rate and rapidly reach the same level found on nondisinfected products [10,28]. In the case of contamination with *L. monocytogenes* during processing, disinfection of salad leaves would reduce the antagonism from epiphytic bacteria and might increase growth of the foodborne pathogen. Therefore, the major role of disinfectants may be to prevent build-up of contamination in washing water during processing rather than to reduce microbial load of raw salad leaves. In the production of MAP produce, good manufacturing practices should be observed that avoid recontamination of disinfected produce with hazardous pathogens.

---

### 14.7 Recommended MA Conditions for Produce

The benefits of CA and MA packaging vary greatly according to the plant product. Storing some products, like apples, under low O<sub>2</sub> conditions can increase the storage period by months. Also some products, like carrots [96], do not respond positively to low O<sub>2</sub> or high CO<sub>2</sub> concentrations. In general, altered gas conditions are regarded as positive only within a certain range of concentrations, the so-called optimum concentrations.

Much research effort has been devoted to the determination of the optimum gas concentrations for individual products [61,75,84]. Table 14.1 gives a recent update on recommended storage conditions for a range of fruits and vegetables. Traditionally, lists of recommended storage conditions have been developed by national research organizations conducting extensive laboratory research [59]. A common experimental procedure is to store products under a range of O<sub>2</sub> and CO<sub>2</sub> concentrations and monitor quality changes. The lower O<sub>2</sub> limit for stored fruits is accomplished empirically by lowering the storage O<sub>2</sub> concentration until intolerable damage occurs. Each commodity and new cultivar requires a large investment in time, equipment, and materials [49,98]. By repeating the trials year after year, it is possible to sense the importance of climatic variation on product behavior [59].

Some caution is needed in the application of optimal concentrations. For the various apple cultivars, for instance, the advised optima differ according to country [75]. Growing conditions like climate and orchard factors influence crop growth and contribute to these differences [21,30,74]. Although this is probably also the case of other plant products, this is never specified.

Another important aspect of optimal values for temperature, O<sub>2</sub>, and CO<sub>2</sub> concentrations is that they are often established separately, although interactions between temperature, O<sub>2</sub>, and CO<sub>2</sub> concentrations (and probably also humidity) are known. Optimal O<sub>2</sub> concentrations are found to shift to a higher value

**TABLE 14.1**  
Recommended Optimal Storage Conditions

Commodity	Temperature (°C)	RH (%)	[O <sub>2</sub> ] %	[CO <sub>2</sub> ] %	Potential
Fruits					
Apple	1–4	90–95	1–3	0–6	A
Avocado	5–13	90	2–5	3–10	B
Banana	12–14	85–95	2–3	8	A
Blackberry	0–2	90–95	5–10	15–20	A
Blueberry	0–2	90–95	2–5	12–20	A
Cherry	0–2	85–90	3–10	10–15	B
Kiwi	0–2	85–90	1–2	3–5	A
Mango	10–15	90	3–7	5–8	B
Melon	8–10	85–90	3–5	5–15	B
Nectarine	0–2	85–90	1–2	3–5	B
Peach	0–2	85–90	1–2	3–5	B
Pear	0–1	90–95	2–3	0–2	A
Persimmon	0–5	90	3–5	5–8	B
Plum	0–2	85–90	1–2	0–5	B
Raspberry	0–2	85–90	5–10	15–20	A
Red currant	0–2	90	5–10	15–20	A
Strawberry	0–2	90	5–10	12–20	A
Sweet corn	0–2	90	2–4	5–10	B
Tomato	1–13	90	3–5	2–4	B
Vegetables					
Artichoke	0–2	90	3–5	0–2	B
Asparagus (green)	0–2	95	10–15	7–12	A
Broccoli	0–1	90–95	2–3	8–12	A
Brussels sprouts	0–1	90–95	2–4	4–6	A
Cabbage	0–1	95	2–3	3–6	A
Celery (stem)	0–2	90–95	3–5	1–4	B
Chicory (witloof)	0–2	90–95	2–3	5–10	A
Leek	0–2	90–95	3–5	3–6	B
Lettuce	0–2	90–95	2–3	2–5	B
Mung bean	0–2	90–95	1–2	1–3	A
Onion	0–2	70–80	1–4	2–5	B
Spinach	0–2	95	21	10–20	B

Note: Value based on the *Proceedings of the 6th and 7th International Controlled Atmosphere Research Conferences* (Ithaca 1993 and Davis 1997). Potential: A, excellent; B, fair. Products with a low potential or no potential are not listed.

Source: Adapted from A. A. Kader, Ed., *Postharvest Technology of Horticultural Crops*, Agriculture and Natural Resources, Publication 3311, University of California (1992), p. 85.

when CO<sub>2</sub> concentrations are increased [7,62,73,93], products are more mature [19,62,71,94], they are kept at a higher temperature [8,65,85,93], or when products sensitive to chilling injury are stored at too low temperatures [73]. For apples, the CO<sub>2</sub> limit at low O<sub>2</sub> concentrations decreases when the temperature is decreased [66]. The effect of RH is often an interacting factor as a cause for, or in the symptom expression of, a disorder. Relative humidity, however, is often not mentioned and frequently not (accurately) measured [87]. The conclusion is that it is very hard to recommend absolute values for optimum O<sub>2</sub> and CO<sub>2</sub> concentrations or O<sub>2</sub> and CO<sub>2</sub> limits for a product without knowledge of other factors. The understanding of actual physiological processes determining the potential of products for MA is developing steadily and will help the further development of optimal and safe packaging techniques.

---

## 14.8 Future Outlook

Fruit and vegetable consumers increasingly demand high-quality products. An important quality feature is freshness. No signs of senescence, decay, wilting, or shriveling are accepted. In general, consumers are willing to pay more for products with better quality. Often consumers also have specific expectations as to the ripening stage. For instance, consumers in Northern Europe want firm, not mealy tomatoes (i.e., the fruits should not be too ripe), but also tomatoes with taste and flavor (i.e., the fruits should not be harvested in a very unripe stage). These quality demands result in strict criteria for storage conditions, transport conditions, and shelf conditions. MA packaging is a tool of increasing importance in meeting these criteria.

MA packages are increasingly being used. The total European MAP market handles on average 300 million package units of produce per year with a market value of about \$1 billion [22,32]. In the United States, a market share of about \$8 billion in MAP products has been predicted for the year 2000. Often successful applications are due to good control of the whole distribution chain, from the moment of packing the product until it is displayed on the retail shelf. When film permeabilities or respiration rates are not well characterized, package designers have to resort to empirical studies with MA packages that can be described as “pack and pray” [26]. A thorough understanding of principles and processes will lead to a more rational selection of packaging materials [62]. Nevertheless, even a package that has been well designed in a laboratory may not necessarily perform well in practice, when no information on the actual storage, transport, or shelf-life conditions were considered at the design stage.

Current state-of-the-art MAP systems for minimally processed produce have been optimized mainly for product quality. Safety and cost aspects have not yet been optimized. Also, quality deterioration still occurs, and further improvements can still be achieved through, for example:

- A systematic approach to select appropriate gas conditions in MAP for specific products
- Availability of more data on the interaction between produce and gas composition
- Development of better computer software to aid in the selection of suitable packaging systems (gas compositions plus foils) for use under dynamic conditions (temperature, humidity)
- Combating microbial hazards in MAP systems (i.e., psychrotrophic pathogens) using improved MAP systems or new hurdles to microbial growth
- Use of “smart” films that compensate for temperature fluctuations by changing permeability properties
- Studies on more environment-friendly MAP systems (e.g., simple foils, biodegradable foils)
- Minimizing packaging in MAP systems (including biocoatings as part of the packaging concept)

Table 14.2 lists these and other trends foreseen in MAP. A misconception of MAP is that it can overcome hygienic abuses in the production or handling of a product. MAP is not a panacea for the preservation of food products, but, if used correctly, it slows the natural deterioration of a product. There is no enhancement of product quality but, when starting with a good clean product, the initial fresh state of the product may be prolonged. Strict codes of practice should be enforced to ensure the maximum quality shelf life and safety of MA-packed foods.

With the increasing importance of MA worldwide, the role of temperature and of its control in the successful use of MAP should be considered [25]. MA packages will not be a substitute for adequate

TABLE 14.2

## New Developments in Modified Atmosphere Packaging

Packaging	Active packaging
Tailoring gas transmission/selectivity (new plastics, microperforation)	Absorbers (O <sub>2</sub> , ethylene, water, off-flavors)
Water vapor transmission/selectivity (modified humidity storage)	Generators (CO <sub>2</sub> , antifungals, flavors)
Biodegradability—environment (multimixed-layered plastics fortified with biodegradable mass)	Controlled release (antimicrobials, antioxidants)
Composites (metals/cartons with plastics/liners)	Dynamic packaging
New concepts (high oxygen, noble gases, optimization)	Temperature dynamic films
Chain optimization (controlling basics: chilling, handling, logistics)	Humidity dynamic films
Minimal packaging	Biopackaging
Integrating functionalities	Biodegradable/edible films
Simpler/less films, better recyclable films	Custom-made physical properties
	Biocoatings
	Edible, physical protection (invisible)
	Functional features (antimicrobials)

temperature management. For all nontropical products only cooling is always better than only MA. But also when only MA can be applied in cases where cooling is not possible, stable temperatures are necessary since no films are yet available that respond to temperature fluctuations of the packed product [40].

Modern consumer demands for convenient and fresh, wholesome produce together with the recent reorganization of the distribution chain will further stimulate the use and the broadening of the application area of MAP. Continued basic physiological and microbiological research on the action of MAs will minimize the risks of loss and safety associated with the use of MAs and will allow for faster MAP optimization using models. New technological developments, especially in the area of more suitable packaging films, will contribute to the success of MA as a preservation technique. The main limiting factors for further expansion of MAP may arise out of environmental concerns. A solution for the huge waste problem, in the long run, may be found in the use of edible and biodegradable films that are able to create a modified atmosphere [51]. The integration of different preservative hurdles, such as refrigeration, MAP, active components, and green chemicals in accordance with the concept of combined processing [70], may not only minimize potential microbial problems but also contribute to optimized product quality. The range of powerful technologies we have at our disposal today will help to ensure a good supply of minimally processed, fresh, safe, and ready-to-eat products.

## References

1. U. M. Abdul-Raouf, L. R. Beuchat, and M. S. Ammar, Survival and growth of *Escherichia coli* O157:H7 on salad vegetables, *Appl. Environ. Microbiol.*, 59:1999 (1993).
2. R. Ahvenainen, New approaches in improving the shelf life of minimally processed fruit and vegetables, *Trends Food Sci. Technol.*, 7:179 (1996).
3. S. A. Aytac and L. G. M. Gorris, Survival of *Aeromonas hydrophila* and *Listeria monocytogenes* on fresh vegetables stored under moderate vacuum, *World J. Microbiol. Biotechnol.*, 10:670 (1994).
4. R. C. Baker, R. A. Qureshim, and J. H. Hotchkiss, Effect of an elevated level of carbon dioxide containing atmosphere on the growth of spoilage and pathogenic bacteria at 2, 7, and 13-degrees-C, *Poultry Sci.*, 65:729 (1986).
5. N. H. Banks, B. K. Dadzie, and D. J. Cleland, Reducing gas exchange of fruits with surface coatings, *Postharv. Biol. Technol.*, 3:269 (1993).
6. C. R. Barmore, Packaging technology for fresh and minimally processed fruits and vegetables, *J. Food Qual.*, 10:207 (1987).
7. R. M. Beaudry, Effect of carbon dioxide partial pressure on blueberry fruit respiration and respiratory quotient, *Postharv. Biol. Technol.*, 3:249 (1993).



8. R. M. Beaudry, A. C. Cameron, A. Shirazi, and D. L. Dostal-Lange, Modified-atmosphere packaging of blueberry fruit: effect of temperature on package O<sub>2</sub> and CO<sub>2</sub>, *J. Am. Soc. Hort. Sci.*, 117:436 (1992).
9. Ben-Yehoshua, B. Shapiro, Z. E. Chen, and S. Lurie, Mode of action of plastic film in extending life of lemon and bell pepper fruits by alleviation of water stress, *Plant Physiol.*, 73:87 (1983).
10. M. H. J. Bennik, H. W. Peppelenbos, C. Nguyen-the, F. Carlin, E. J. Smid, and L. G. M. Gorris, Microbiology of minimally processed, modified atmosphere packaged chicory endive, *Postharv. Biol. Technol.*, 9:209 (1996).
11. M. H. J. Bennik, E. J. Smid, F. M. Rombouts, and L. G. M. Gorris, Growth of psychrotrophic food-borne pathogens in a solid surface model system under the influence of carbon dioxide and oxygen, *Food Microbiol.*, 12:509 (1995).
12. J. E. Berard, Memoire sur la maturation des fruits, *Ann. Chim. Phys.*, 16:152 (1819).
13. M. E. Berrang, R. E. Brackett, and L. R. Beuchat, Growth of *Listeria monocytogenes* on fresh vegetables stored under controlled atmosphere, *J. Food Prot.*, 52:702 (1989).
14. M. E. Berrang, R. E. Brackett, and L. R. Beuchat, Growth of *Aeromonas hydrophila* on fresh vegetables stored under a controlled atmosphere, *Appl. Environ. Microbiol.*, 55:2167 (1989).
15. L. B. Beuchat, Pathogenic bacteria associated with fresh produce, *J. Food Prot.*, 59:204 (1995).
16. L. R. Beuchat and R. E. Brackett, Survival and growth of *Listeria monocytogenes* on lettuce as influenced by shredding, chlorine treatment, modified atmosphere packaging and temperature, *J. Food Sci.*, 55:755,870 (1990).
17. L. R. Beuchat and R. E. Brackett, Behavior of *Listeria monocytogenes* inoculated into raw tomatoes and processed tomato products, *Appl. Environ. Microbiol.*, 57:1367 (1991).
18. E. Blickstad, S. O. Enfors, and G. Molin, Effect of high concentrations of CO<sub>2</sub> on the microbial flora of pork stored at 4-degrees-C and 14-degrees-C, In *Psychrotrophic Microorganisms in Spoilage and Pathogenicity* (T. A. Roberts, G. Hobbs, and J. H. B. Christian, Eds.), Academic Press, London (1981).
19. M. R. Boersig, A. A. Kader, and R. J. Romani, Aerobic-anaerobic respiratory transition in pear fruit and cultured pear fruit cells, *J. Am. Soc. Hort. Sci.*, 113:869 (1988).
20. R. E. Brackett, Influence of modified atmosphere packaging on the microflora and quality of fresh bell peppers, *J. Food Prot.*, 53:255 (1990).
21. W. J. Bramlage, M. Drake, and W. J. Lord, The influence of mineral nutrition on the quality and storage performance of pome fruits grown in North America, *Acta Hort.*, 92:29 (1980).
22. A. L. Brody, A perspective on MAP products in North America and Western Europe, In *Principles of Modified-Atmosphere and Sous Vide Product Packaging* (J. M. Farber and K. L. Dodds, Eds.), Technomic Publishing Company, Inc., Lancaster, PA (1995), p. 13.
23. S. P. Burg, Hypobaric storage and transportation of fresh fruits and vegetables, In *Postharvest Biology and Handling of Fruits and Vegetables* (N. F. Haard and D. K. Salunkhe, Eds.), Avi Publ. Co., Westport, CT (1975), p. 172.
24. S. P. Burg and E. A. Burg, Fruit storage at subatmospheric pressures, *Science*, 153:314 (1966).
25. A. C. Cameron, B. D. Patterson, P. C. Talasila, and D. W. Joles, Modeling the risk in modified-atmosphere packaging: a case for sense and respond packaging, *Proceedings of the 6th National Controlled Atmosphere Research Conferences*, Ithaca, NY, June 15-17 (1993), p. 95.
26. A. C. Cameron, P. C. Talasila, and D. W. Joles, Predicting film permeability needs for modified atmosphere packaging of lightly processed fruits and vegetables, *HortScience*, 30:25 (1995).
27. F. Carlin and C. Nguyen-the, Fate of *Listeria monocytogenes* on four types of minimally processed green salads, *Lett. Appl. Microbiol.*, 18:222 (1994).
28. F. Carlin, C. Nguyen-the, and A. Abreu da Silva, Factors affecting the fate of *Listeria monocytogenes* on minimally processed fresh endive, *J. Appl. Bacteriol.*, 78:636 (1995).
29. F. Carlin, C. Nguyen-the, A. Abreu da Silva, and C. Cochet, Effect of carbon dioxide on the fate of *Listeria monocytogenes*, aerobic bacteria and on the development of spoilage in minimally processed fresh endive, *Int. J. Food Microbiol.*, 32:159 (1996).
30. P. M. Chen, D. M. Borgic, D. Sugar, and W. M. Mellenthin, Influence of fruits maturity and growing district on brown core disorder of Bartlett pears, *HortScience*, 21:1172 (1986).
31. N. Church, Developments in modified-atmosphere packaging and related technologies, *Trends Food Sci. Technol.*, 5(11):345 (1994).
32. B. P. F. Day and L. G. M. Gorris, Modified atmosphere packaging of fresh produce on the West-European market, *Int. J. Food Techn. Mark. Pack. Anal.*, 44:32 (1993).

33. C. Diaz and J. H. Hotchkiss, Comparative growth of *Escherichia coli* O157:H7, Spoilage organisms and shelf-life of shredded iceberg lettuce stored under modified atmospheres, *J. Sci. Food Agric.*, 70:433 (1996).
34. T. Eklund, The effect of CO<sub>2</sub> on microbial growth and on uptake processes in bacterial membrane vesicles, *Int. J. Food Microbiol.*, 1:179 (1984).
35. T. Eklund and J. Jarmund, Microculture model studies on the effect of various gas atmospheres on microbial growth at different temperatures, *J. Appl. Bacteriol.*, 55:119 (1983).
36. S. O. Enfors and G. Molin, The influence of high concentrations of CO<sub>2</sub> on the germination of bacterial spores, *J. Appl. Bacteriol.*, 45:279 (1978).
37. S. O. Enfors and G. Molin, Effect of high concentrations of CO<sub>2</sub> on growth rate of *Pseudomonas fragi*, *Bacillus cereus*, and *Streptococcus cremoris*, *J. Appl. Bacteriol.*, 48:409 (1980).
38. S. O. Enfors and G. Molin, The influence of temperature on the growth inhibitory effect of CO<sub>2</sub> on *Pseudomonas fragi* and *Bacillus cereus*, *Can. J. Microbiol.*, 27:15 (1981).
39. S. O. Enfors and G. Molin, The effect of different gases on the activity of microorganisms, In *Psychrotrophic Microorganisms in Spoilage and Pathogenicity* (T. A. Roberts, G. Hobbs, and J. H. B. Christian, Eds.), Academic Press, London (1981).
40. A. Exama, J. Arul, R. W. Lencki, L. Z. Lee, and C. Toupin, Suitability of plastic films for modified atmosphere packaging of fruits and vegetables, *J. Food Sci.*, 58:1365 (1993).
41. J. M. Farber, Microbiological aspects of modified-atmosphere packaging technology—a review, *J. Food Prot.*, 54:58 (1991).
42. J. D. Floros, Controlled and modified atmospheres in food packaging and storage, *Chem. Eng. Progr.*, 6:25 (1990).
43. G. A. Francis and D. O’Beirne, Effect of gas atmosphere, antimicrobial dip and temperature on the fate of *Listeria innocua* and *Listeria monocytogenes* on minimally processed lettuce, *Int. J. Food Sci. Technol.*, 32:141 (1997).
44. R. M. Garcia-Gimeno, M. D. Sanchez-Pozo, M. A. Amaro-Lopez, and G. Zurera-Cosano, Behaviour of *Aeromonas hydrophila* in vegetable salads stored under modified atmosphere at 4 and 15 degree C, *Food Microbiol.*, 13:369 (1996).
45. R. M. Garcia-Gimeno, G. Zurera-Cosano, and O. Amaro-Lopez, Incidence, survival and growth of *Listeria monocytogenes* in ready-to-use mixed vegetable salads in Spain, *J. Food Safety*, 16:75 (1996).
46. D. A. Golden, E. J. Rhodhamel, and D. A. Kautter, Growth of *Salmonella* spp. in cantaloupe, watermelon and honeydew melons, *J. Food Prot.*, 56:194 (1993).
47. L. G. M. Gorris and H. W. Peppelenbos, Modified atmosphere and vacuum packaging to extend the shelf life of respiring food products, *HortTechnology*, 2:303 (1992).
48. L. G. M. Gorris, Y. de Witte, and E. J. Smid, Storage under moderate vacuum to prolong the keepability of fresh vegetables and fruits, *Acta Hort.*, 368:479 (1994).
49. C. D. Gran and R. M. Beaudry, Determination of the low oxygen limit for several commercial apple cultivars by respiratory quotient breakpoint, *Postharv. Biol. Technol.*, 3:259 (1993).
50. W. Grierson and W. F. Wardowski, Relative humidity effects on the postharvest life of fruits and vegetables, *HortScience*, 13:22 (1978).
51. S. N. Guilbert, N. Gontard, and L. G. M. Gorris, Prolongation of the shelf-life of perishable food products using biodegradable films and coatings, *Lebensm. Wiss. Technol.*, 29:10 (1996).
52. Y. Y. Hao and R. E. Brackett, Influence of modified atmosphere on growth of vegetable spoilage bacteria in media, *J. Food Prot.*, 56:223 (1993).
53. S. M. Harmon and D. A. Kautter, Incidence and growth potential of *Bacillus cereus* in ready-to-serve foods, *J. Food Prot.*, 54:372 (1991).
54. C. W. Hedberg, K. L. MacDonald, and M. T. Osterholm, Changing epidemiology of foodborne disease: a Minnesota perspective, *Clin. Infect. Dis.*, 18:671 (1994).
55. Y. S. Henig, Storage stability and quality of produce packaged in polymeric films, In *Symposium: Postharvest Biology and Handling of Fruits and Vegetables* (N. F. Haard and D. K. Salunkhe, Eds.), Avi Publ. Co., Westport, CT (1975), p. 144.
56. M. L. A. T. M. Hertog, H. W. Peppelenbos, L. M. M. Tijskens, and R. G. Evelo, Modified atmosphere packaging: optimisation through simulation, *Proceedings of the 7th International Controlled Atmosphere Research Conferences*, July, Davis, CA (1997).
57. C. B. Hintlian and J. H. Hotchkiss, The safety of modified atmosphere packaging: a review, *Food Technol.*, 40(12):70 (1986).

58. J. H. Hotchkiss and M. J. Banco, Influence of new packaging technologies on the growth of microorganisms in produce, *J. Food Prot.*, 55:815 (1992).
59. J. Jameson, CA storage technology—recent developments and future potential, *Proceedings of the COST94 Workshop, 22–23 April, 1993, Milan* (1995), p. 1.
60. A. A. Kader, Ed., Modified atmospheres during transport and storage, *Postharvest Technology of Horticultural Crops*, Agriculture and Natural Resources, Publication 3311, University of California (1992), p. 85.
61. A. A. Kader, A summary of CA and MA requirements and recommendations for fruits other than pome fruits, *Proceedings of the 6th International Controlled Atmosphere Research Conferences*, Ithaca, NY, June 15–17 (1993), p. 859.
62. A. A. Kader, D. Zagory, and E. L. Kerbel, Modified atmosphere packaging of fruits and vegetables, *Crit. Rev. Food Sci. Nutr.*, 28:1 (1989).
63. D. A. Kautter, T. Lilly Jr., and R. Lynt, Evaluation of the botulism hazard in fresh mushrooms wrapped in commercial polyvinylchloride film, *J. Food Prot.*, 55:372 (1991).
64. S. J. Kays, *Postharvest Physiology of Perishable Plant Products*, AVI, Van Nostrand Reinhold, New York (1991).
65. D. Ke, L. Goldstein, M. O'Mahony, and A. A. Kader. Effects of short-term exposure to low O<sub>2</sub> and CO<sub>2</sub> atmospheres on quality attributes of strawberries, *J. Food Sci.*, 56:50 (1991).
66. F. Kidd and C. West, Brown heart, a functional disease of apples and pears, Special report no. 12, Food Inv. Board, Dep. Sci. Ind. Res. (1923), p. 1.
67. M. Larsen and C. B. Watkins, Firmness and concentrations of acetaldehyde, ethyl acetate and ethanol in strawberries stored in controlled and modified atmospheres, *Postharv. Biol. Technol.*, 5:39 (1995).
68. D. S. Lee, P. E. Hagggar, J. Lee, and K. L. Yam, Model for fresh produce respiration in modified atmospheres based on principles of enzyme kinetics, *J. Food Sci.*, 56:1580 (1991).
69. L. Lee, J. Arul, R. Lencki, and F. Castaigne, A review on modified atmosphere packaging and preservation of fresh fruits and vegetables: physiological basis and practical aspects—Part I, *Pack. Technol. Sci.*, 8:315 (1995).
70. L. Leistner and L. G. M. Gorris, Food preservation by hurdle technology, *Trends Food Sci. Technol.*, 6:41 (1995).
71. P. D. Lidster, G. D. Blanpied, and E. C. Lougheed, Factors affecting the progressive development of low-oxygen injury in apples, *Proceedings of the 4th International Controlled Atmosphere Research Conferences*, Raleigh, NC (1985), p. 57.
72. T. Lilly Jr., H. M. Solomon, and E. J. Rhodehamel, Incidence of *Clostridium botulinum* in vegetables packaged under vacuum or modified atmosphere, *J. Food Prot.*, 59:59 (1996).
73. E. C. Lougheed, Interactions of oxygen, carbon dioxide, temperature and ethylene that may induce injuries in vegetables, *HortScience*, 22:791 (1987).
74. M. T. Luton and D. A. Holland, The effects of preharvest factors on the quality of stored conference pears. I. Effects of orchard factors, *J. Hort. Sci.*, 61:23 (1986).
75. M. Meheriuk, CA storage conditions for apples, pears and nashi, *Proceedings of the 6th and International Controlled Atmosphere Research Conferences*, Ithaca, NY (June 15–17, 1993), p. 819.
76. G. Molin, The resistance to CO<sub>2</sub> of some food related bacteria, *Eur. J. Appl. Microbiol. Biotechnol.*, 18:214 (1983).
77. C. Nguyen-the and F. Carlin, The microbiology of minimally processed fresh fruits and vegetables, *Crit. Rev. Food Sci. Nutr.*, 34:371 (1994).
78. H. W. Peppelenbos, L. M. M. Tijsskens, J. van't Leven, and E. C. Wilkinson, Modelling oxidative and fermentative carbon dioxide production of fruits and vegetables, *Postharv. Biol. Technol.*, 9:283 (1996).
79. H. W. Peppelenbos and J. van't Leven, Evaluation of four types of inhibition for modelling the influence of carbon dioxide on oxygen consumption of fruits and vegetables, *Postharv. Biol. Technol.*, 7:27 (1996).
80. H. W. Peppelenbos, H. Zuckermann, and S. Robat, Alcoholic fermentation of apple fruits at various oxygen concentrations. Model prediction and photoacoustic detection, *Proceedings of the 7th International Controlled Atmosphere Research Conferences*, Davis, CA (1997).
81. P. Perata and A. Alpi, Plant responses to anaerobiosis, *Plant Sci.*, 93:1 (1993).
82. C. A. Phillips, Review: modified atmosphere packaging and its effects on the microbiological quality and safety of produce, *Int. J. Food Sci. Technol.*, 31:463 (1996).

83. V. Rodov, S. Ben-Yehoshua, T. Fierman, and D. Fang, Modified-humidity packaging reduces decay of harvested bell pepper fruit, *HortScience*, 30:299 (1995).
84. M. E. Saltveit, A summary of CA and MA requirements and recommendations for the storage of harvested vegetables, *Proceedings of the 6th International Controlled Atmosphere Research Conferences*, Ithaca, NY (June 15–17, 1993), p. 800.
85. M. E. Saltveit and W. E. Ballinger, Effects of anaerobic nitrogen and carbon dioxide atmospheres on ethanol production and postharvest quality of 'Carlos' grapes, *J. Am. Soc. Hort. Sci.*, 108:462 (1983).
86. W. F. Schlech III, P. M. Lavigne, R. A. Bortolussi, A. C. Allen, E. V. Haldane, A. J. Wort, A. W. Hightower, S. E. Johnson, S. H. King, E. S. Nicholls, and C. V. Broome, Epidemic listeriosis-evidence for transmission by food, *N. Engl. J. Med.*, 308:203 (1983).
87. S. P. Schouten, R. K. Prange, J. Verschoor, T. R. Lammers, and J. Oosterhaven, Improvement of quality of Elstar apples by dynamic control of ULO conditions, *Proceedings of the 7th International Controlled Atmosphere Research Conferences*, Davis, CA (13–18 July, 1997).
88. A. Shirazi and A. C. Cameron, Controlling relative humidity in modified atmosphere packages of tomato fruit, *HortScience*, 27:336 (1992).
89. H. M. Solomon, D. A. Kautter, T. Lilly, and E. J. Rhodehamel, Outgrowth of *Clostridium botulinum* in shredded cabbage at room temperature under a modified atmosphere, *J. Food Prot.*, 53:831 (1990).
90. H. Sugiyama and K. H. Yang, Growth potential of *Clostridium botulinum* in fresh mushrooms packaged with semipermeable plastic film, *Appl. Microbiol.*, 30:964 (1975).
91. P. C. Talasila, A. C. Cameron, and D. W. Joles, Frequency distribution of steady-state oxygen partial pressures in modified-atmosphere packages of cut broccoli, *J. Am. Soc. Hort. Sci.*, 119:556 (1994).
92. P. S. Taoukis and T. P. Labuza, Applicability of time-temperature indicators as shelf life monitors of food products, *J. Food Sci.*, 54:783 (1989).
93. M. Thomas, A quantitative study of the production of ethyl alcohol and acetaldehyde by cells of the higher plants in relation to concentration of oxygen and carbon dioxide, *Biochem. J.*, 19:927 (1925).
94. M. Thomas and J. C. Fidler, Zymasis by apples in relation to oxygen concentration, *Biochem. J.*, 27:1629 (1933).
95. P. Varoquaux, G. Albagnac, C. Nguyen-the, and F. Varoquaux, Modified atmosphere packaging of fresh bean sprouts, *J. Sci. Food Agric.*, 70:224 (1996).
96. J. Weichmann, Physiological response of root crops to controlled atmospheres, *Proceedings of the 2nd National Controlled Atmosphere Research Conferences*, East Lansing, MI (1977), p. 667.
97. J. H. Wells and R. P. Singh, Application of time-temperature indicators in monitoring changes in quality attributes of perishable and semiperishable foods, *J. Food Sci.*, 53:148 (1988).
98. A. S. Wollin, C. R. Little, and J. S. Packer, Dynamic control of storage atmospheres, *Proceedings of the 4th International Controlled Atmosphere Research Conferences*, Raleigh, NC (1985), p. 308.
99. R. C. Wood, C. Hedberg, and K. White, A multistate outbreak of *Salmonella javiana* infections associated with raw tomatoes, CDC Epidemic Intelligence Service, 40th Ann. Conf. Atlanta, U.S. Dept. of Health and Human Services, Public Health Service (1991), p. 69.
100. D. Zagory and A. A. Kader, Modified atmosphere packaging of fresh produce, *Food Technol.*, 42:70 (1988).
101. D. Zagory, J. D. Mannapperuma, A. A. Kader, and R. P. Singh, Use of a computer model in the design of modified atmosphere packages for fresh fruits and vegetables, *Proceedings of the 5th International Controlled Atmosphere Research Conferences*, Wenatchee (June 14–16, 1989), p. 479.



# 15

## *Glass Transition and State Diagram of Foods*

Mohammad Shafiur Rahman

### CONTENTS

15.1	Introduction.....	336
15.1.1	Background .....	336
15.1.2	Glass Transition and Glassy State .....	337
15.2	State Diagram and Its Components .....	337
15.2.1	State Diagram .....	337
15.2.2	Components of State Diagram .....	338
15.2.3	Equilibrium and Nonequilibrium State .....	340
15.2.3.1	Thermodynamic Equilibrium .....	340
15.2.3.2	Metastable Equilibrium.....	340
15.2.3.3	Nonequilibrium .....	340
15.2.4	Cooling and Metastability .....	340
15.2.4.1	Typical Cooling Curves .....	340
15.2.4.2	Cooling Rate and Thermodynamic Equilibrium.....	341
15.2.5	State of Water in Foods .....	343
15.2.6	Differential Scanning Calorimetry .....	344
15.2.7	Dynamic Mechanical Thermal Analysis .....	346
15.2.8	Freezing Point .....	346
15.3	Theoretical Progresses in Glassy State.....	347
15.3.1	Free Volume Theory .....	347
15.3.2	Relaxation in the Glassy State .....	348
15.4	Applications of Glassy State Concept in Food Systems .....	349
15.4.1	Diffusion Process.....	349
15.4.2	Texture and Structure .....	350
15.4.3	Crystallization .....	350
15.4.4	Stickiness.....	350
15.4.5	Grain Damage by Drying .....	350
15.4.6	Pore Formation in Foods.....	351
15.4.7	Microbial Stability.....	352
15.4.8	Desiccation-Tolerant Organisms .....	352
15.4.9	Oxidation .....	353
15.4.10	Nonenzymatic Browning.....	353
15.4.11	Enzymatic Reaction.....	354
15.4.12	Denaturation of Protein .....	354
15.4.13	Hydrolysis .....	354
15.4.14	Enzyme Inactivation and Other Chemical Reactions .....	355
15.4.15	Sensory Properties.....	355
	References .....	356

## 15.1 Introduction

### 15.1.1 Background

In the literature, new concepts and hypotheses are being developed and proposed in the areas of food properties to bring food science from empiricism to a strong scientific foundation [130]. The stability of foods is of utmost interest to both food scientists and engineers, and a better understanding of the factors controlling stability or reaction rates is clearly needed [96,132]. In the middle of the twentieth century, scientists began to discover the existence of a relationship between the water contained in a food and its relative tendency to spoil [164]. In the 1980s, Labuza and his group generated significant data on food stability as a function of water activity. They also began to realize that the active water could be much more important to the stability of a food than the total amount of water present. Thus, it is possible to develop generalized rules or limits for the stability of foods using water activity. For example, there is a critical water activity below which no microorganisms can grow. For most foods, this critical range is in the 0.6–0.7 values of water activity. Pathogenic bacteria cannot grow below a water activity of 0.85–0.86, whereas yeasts and molds are more tolerant to a reduced water activity of 0.80, but usually no growth occurs below a water activity of about 0.62. A food product is most stable at its monolayer moisture content, which varies with the chemical composition and structure. This was the main reason why food scientists started to emphasize on water activity rather than total water content. Since then, the scientific community has explored the great significance of water activity in determining the physical characteristics, processes, shelf life, and sensory properties of foods. It is now used to predict the end point of drying, process design and control, ingredient selection, product stability, and packaging selection.

Recently, the limitations of water activity were elucidated and alternatives proposed. Water activity is defined at equilibrium, whereas foods with low and intermediate water content may not be in a state of equilibrium and it is time-temperature-moisture dependent. The critical limits of water activity may also be shifted to higher or lower levels by other factors such as pH, salt, antimicrobial agents, heat treatment, and temperature to some extent [136]. The third limitation is the effect of specific solutes [39]. It has been demonstrated that minimum water activity for the growth of microbial organisms is dependent on the solutes employed to adjust the water activity of a medium [164]. Also, it was observed later that some solutes were more inhibiting than others. Thus, the water activity of a medium is not the only determining factor regulating microbial response. The nature of the solute used also plays an important role, thus the concept of generalization with water activity is questioned. Moreover, water activity does not provide any indication of the state of the water present and how it is bound to the substrate [65]. In addition, many physical characteristics such as crystallization, caking, stickiness, gelatinization, collapse, molecular mobility, and diffusivity could not be explained based on the basis of water activity concept [136]. Therefore, the glass transition concept was put forward.

Glassy materials have been known for centuries, but it is only in the last 70 years or so that scientific understanding of these systems has evolved [55]. Early attempts to describe the vitrification phenomenon concluded that glass is a liquid that has lost its ability to flow, thus instead of taking the shape of its container, glass itself can serve as a container for liquids. Food materials are in an amorphous or non-crystalline state below the glass transition temperature, and are rigid and brittle. Glasses are not crystalline with a regular structure, but retain the disorder of the liquid state. Physically it is solid, but thermodynamically it is a liquid. Molecular mobility increases 100-fold above glass transition. In kinetic terms, Angell [9] described a glass as any liquid or supercooled liquid whose viscosity is between  $10^{12}$  and  $10^{13}$  Pa s, thus effectively behaving like a solid that is able to support its own weight against flow due to gravity. To put this viscosity into context, a supercooled liquid with a viscosity of  $10^{14}$  Pa s would flow  $10^{-14}$  m/s in the glassy state compared with the flow rate of a typical liquid in the order of 10 m/s. In other words, a glass is a liquid that flows about 30  $\mu\text{m}$  in a century [30]. This is evidenced by the fact that ancient stained glass windows are thicker at their base due to flow under gravity [81].

The earliest papers on the glass transition concept in food and biological systems can be found in the literature of the 1960s [103,139,188]. White and Cakebread [188] first highlighted the importance of the glassy state of foods in determining its stability. They were perhaps the first food scientists to discuss the importance of the glassy and rubbery states in relation to the quality control of a number of

high-solids systems. In the 1980s, significant applications of the glass transition concept in food processing emerged when Levine and Slade [97] and Slade and Levine [177] identified its major merits. In the 1990s, Roos, Karel, and other groups generated significant data on glass transition and components of state diagram for a number of food components. It has been mentioned in the literature that foods can be considered very stable at the glassy state, since below glass temperature the compounds involved in the deterioration reactions take many months or even years to diffuse over molecular distances and approach each other to react [178]. A hypothesis put forth recently states that this transition greatly influences food stability, as the water in the concentrated phase becomes kinetically immobilized and therefore does not support or participate in reactions. Formation of a glassy state results in a significant arrest of translational molecular motion, and chemical reactions become very slow [127]. The rules of glass transition concept are: (i) the food is most stable at and below its glass transition, and (ii) higher the  $T-T_g$  (i.e., above glass transition), higher the deterioration or reaction rates. Similarly, mechanical and transport properties could also be related with glass transition. It is very interesting to see that this concept has been so widely tested in foods. In many instances, glass transition concept does not work alone; thus, it is now recommended to use both the water activity and glass transition concepts in assessing processability, deterioration, food stability, and shelf-life predictions [145,148].

### 15.1.2 Glass Transition and Glassy State

Phase transitions in foods can be divided into two groups: first-order and second-order. At first-order transition temperature, the physical state of a material changes isothermally from one state to another (e.g., solid to liquid, liquid to gas) by release or absorption of latent heat (e.g., melting, crystallization, condensation, evaporation). Second-order transition occurs (e.g., amorphous state to glassy state) without release or absorption of latent heat [126]. Glass transition is a nature of second-order time-temperature-dependent transition, which is characterized by a discontinuity or change in slope in physical, mechanical, electrical, thermal, and other properties of a material when plotted as a function of temperature [126]. A process is considered to be of second-order thermodynamic transition if the material undergoes a change in state but not in phase. It is more meaningful to define glass transition as the nature second-order change in the properties since each measurement technique is based on monitoring change in a specific property, and since change or break in properties is achieved within a certain temperature range rather than a specific temperature. A perfect second-order transition occurs at a specific temperature.

Glasses are formed when a liquid or a rubbery system is cooled so rapidly that there is no time for the molecules to rearrange themselves and pack into crystalline domains [68]. With continued cooling, the system exhibits a significant change in thermal, mechanical, and other physical properties at the glass transition region. Experimentally, this is supported by calorimetric studies on supercooled glycerol, which produces a steep change in heat capacity as a function of temperature at 190 K [8]. During heating, devitrification of polydisperse food materials does not occur at a fixed point with the change of specific heat. Instead, networks soften over quite a large range of temperatures [81]. Researchers may prefer to refer the molecular processes as glass transition rather than as second-order transitions to avoid implying a thermodynamic state at which equilibrium conditions are achieved. This is due to the fact that increasing rates of cooling shift the glass transition at higher temperatures and produce a less dense glass, arguing that equilibrium glass conditions lie below the experimentally accessible values [43].

---

## 15.2 State Diagram and Its Components

### 15.2.1 State Diagram

State diagram is the map of different states of a food as a function of water or solids content and temperature [129]. The main advantages of drawing a map are to help in understanding the complex changes when the food's water content and temperature are changed. It also assists in identifying the food's stability during storage as well as selecting a suitable temperature and moisture content for processing. Figure 15.1 shows a state diagram indicating different states as a function of temperature and solids mass fraction.





decreased with the increase of temperature. A reaction zone was defined from thermo-mechanical analysis by plotting  $G'$  and  $G''$  as a function of temperature when both  $G'$  and  $G''$  increased from a minimum value and start separation each other and then decreased again starting the softening region. All these transitions are observed in the region BQEL. The line BDL is the melting line that is important when products reach high temperatures during processing, such as frying, baking, roasting, and extrusion cooking. In the case of multicomponent mixtures such as food, a clear melting is difficult to observe at high temperature due the reactions between components. In this case, Rahman [129] defines it as decomposition temperature. Line MDP is the boiling line for water evaporation from the liquid (line MD) and solid phases (line DP). This line does not intersect the y-axis on the right.

Recently, many papers presented data on water activity as well as glass transition as a function of water content. However, the link between water activity and glass transition—in order to determine stability—was not identified. Karel et al. [77] attempted to relate water activity and glass transition by plotting equilibrium water content and glass transition as a function of water activity. By drawing a vertical line on the graph, stability criterion can be determined from the isotherm curve and glass transition line. However, at any given temperature (say 25°C), the stability moisture content from glass transition line is much higher than the stability moisture from the isotherm. So the question is how to use them both. Even at present, it is a real challenge to link them. In his first attempt, Rahman [131] plotted BET-monolayer value as LO line—shown in Figure 15.1. It intersects at point N with the glass line ES, which shows that at least in one location (point N) glass and water activity concepts provide the same stability criterion. This approach forms more microregions, which could give different stability in the state diagram. More studies regarding stability need to be undertaken on the left (above and below glass) and right sides (above and below) of the line LO. A successful combination of water activity and glass transition could provide more in-depth knowledge on stability criteria. In addition, how could other factors such as pH and preservatives be linked with these concepts. Are we too far away to develop a unified theoretical basis? The region of drying and freezing process can be easily visualized in the diagram, and product stability could be assessed based on moisture content and temperature. The sources of state diagram of different foods and foods components are compiled in Table 15.1. Most of the transitions defined in the state diagram are commonly measured by the DSC method using appropriate protocol. The thermo-mechanical analysis (TMA) and oscillation methods are less commonly used; however, these methods are more sensitive. More details of measurement methods are presented by Rahman [126,132].

It is evident from the review by Rahman [131] that the degree of variation of food stability below glass transition are not following the rule indicating only the glass transition temperature for developing the stability rule could not be enough. The types or characteristics of glassy state in different types of foods with variations of composition and water content should be used to characterize the stability criterion. In addition, the effect of temperature below  $T_m'$ ,  $T_g''$ ,  $T_g'$ , and  $T_g'''$  should also be explored. Samples having freezable water are more complex and the four temperatures are defined as:  $T_m' > T_g'' > T_g' > T_g'''$  [136]. There are only few references available that include all the four characteristic temperatures

TABLE 15.1

State Diagram Developed for Different Foods and Food Components

Material	Components	References
Apple, grape, onion, strawberry, sucrose, fructose, bacterial suspension, tomato, garlic	Freezing curve, glass line, $X_s''$ , and $T_g''$	[4,5,15,24,57,69,88, 137,157,158,165,166]
Honey	Freezing curve,	[74]
glass line, $X_s''$ , $T_g''$ , and $T_g'''$		
Sucrose	$X_s''$ , $T_g''$	[2]
Sucrose, lactose, maltose, glucose, maltodextrins, starch, arabinosylan	Freezing curve, glass line, $X_s'$ , $T_m'$ , and $T_g'$	[56,149,150–152]

with their moisture content. It is important to know how these temperatures affect the stability of foods. It would be interesting to explore what other differences in stability exist in products within these different ranges [131].

### 15.2.3 Equilibrium and Nonequilibrium State

Complex foods exist in states of either unstable nonequilibrium or metastable equilibrium, but never in true thermodynamic equilibrium [51]. Fennema [53] defined the terminology as follows.

#### 15.2.3.1 Thermodynamic Equilibrium

Any food consisting of only one phase requires minimization of free energy to attain thermodynamic equilibrium. For foods containing two or more phases, thermodynamic equilibrium requires that the chemical potential be equal, in every part of the system, for each substance present. Chemical potential determines whether a substance will undergo a chemical reaction or diffuse from one part of a system to another. An equilibrium state can be attained through many possible paths, i.e., the same properties must be obtainable at a given temperature regardless of whether the temperature is approached by cooling or warming.

#### 15.2.3.2 Metastable Equilibrium

Metastable equilibrium refers to a state of pseudoequilibrium, or apparent equilibrium, which is stable over practical time periods but is not the most stable state possible. A metastable state can exist (i.e., conversion to a more stable equilibrium state will not occur) when the activation energy for conversion to a more stable equilibrium state is so high that the rate of conversion is of no practical importance.

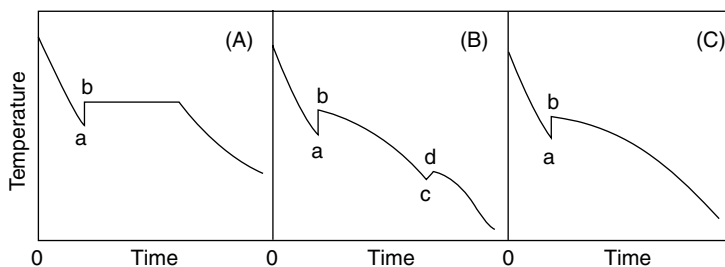
#### 15.2.3.3 Nonequilibrium

Nonequilibrium refers to a state that is inherently unstable, i.e., change to a more stable state is likely to occur at a rate of practical importance. The exact rate at which destabilization occurs depends on the particular system and the conditions to which it is exposed.

### 15.2.4 Cooling and Metastability

#### 15.2.4.1 Typical Cooling Curves

Typical cooling curves during freezing are shown in Figure 15.2 [126]. The abrupt rise in temperature due to liberation of the heat of fusion after initial supercooling represents the onset of ice crystallization. Cooling below the initial freezing point of the sample without formation of ice is defined as supercooling [53]. Pure water can be supercooled by several degrees before the nucleation phenomenon begins. Once the critical mass of nuclei is reached, the system nucleates at point a in Figure 15.2 and releases its latent heat faster than the rate at which it is being removed from the system [126]. The temperature then increases instantly to the initial or equilibrium freezing temperature at point b.



**FIGURE 15.2** Typical cooling curves; A: water, B: solution, C: food; a: ice crystallization, b: equilibrium freezing point, c: initiation of solute crystal, d: eutectic point. (From Rahman, M. S. 1995. *Food Properties Handbook*. CRC Press, Boca Raton, FL.)

In aqueous solutions, point *a* is not as low as in the case of pure water since the added solute will promote heterogeneous nucleation, thereby accelerating the nucleation process. Solute greatly decreases the amount of supercooling for two reasons: faster nucleation and lowered freezing point. In very concentrated solutions, it is sometimes difficult to even induce supercooling [58].

After crystallization is completed, the temperature drops as the sensible heat is released in case of water (Figure 15.2A). In solutions, supersaturation continues due to the freezing of water, and solute crystals may form by releasing latent heat of solute crystallization, causing a slight jump in temperature from *c* to *d* (Figure 15.2B). These points are known as eutectic points. However, in reality it is very difficult to trace the points *c* or *d* using the cooling curve.

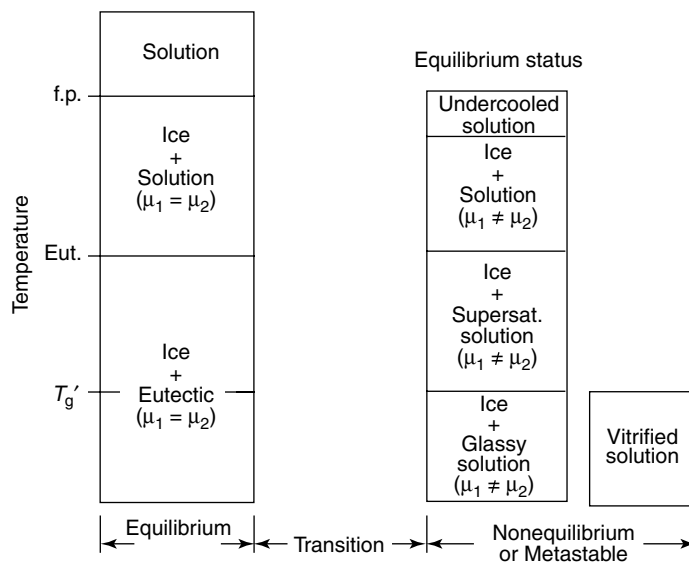
In solutions with multiple solutes or foods, it is difficult to determine the eutectic points. Many different eutectic points might be expected, but each plateau would be quite short if small quantities of solutes were involved (Figure 15.2C). If a material is heated from a frozen or glass state, then the onset of ice melting is called melting point of ice. The freezing point or melting point is considered as an equilibrium process, i.e., neither cooling or heating nor its rate affects the phase transition point of ice crystallization.

### 15.2.4.2 Cooling Rate and Thermodynamic Equilibrium

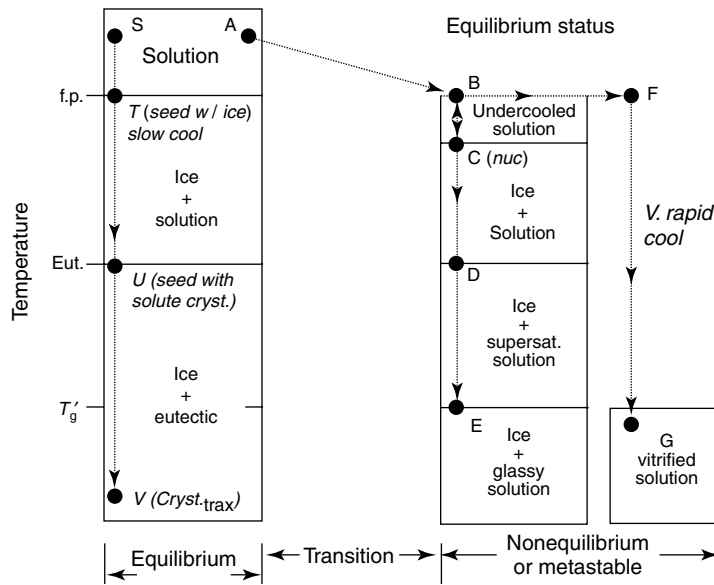
Fennema's [53] schematic depiction of a binary system is used to simplify the presentation. The basic format of the figures is shown in Figure 15.3, a plot of sample temperature versus equilibrium state. The columns represent different rates of cooling: equilibrium cooling, moderate cooling, and rapid cooling. The left column (equilibrium cooling) represents cooling at an exceedingly slow rate, the middle column (moderate cooling) represents cooling at a moderate rate consistent with commercial practice, and the right column (very rapid cooling) represents cooling at a rate that is exceedingly rapid. Cooling will follow a downward path in the columns.

#### 15.2.4.2.1 Equilibrium Cooling

Cooling in the first column in Figure 15.3 is in accordance with thermodynamic equilibrium, which is not possible under practical circumstances, nor is it desirable. Thermodynamic freezing is, however, worthy of consideration for conceptual reasons. The path begins at point *S*, which represents an aqueous solution containing one solute at thermodynamic equilibrium (Figure 15.4). Cooling must occur at an exceedingly slow rate to preserve equilibrium conditions [192], which will eventually bring the solution to its initial



**FIGURE 15.3** Equilibrium status based on rate of cooling. (From Fennema, O. 1995. In: *Food Preservation by Moisture Control: Fundamentals and Applications*. Technomic Publishing, Lancaster, PA. pp. 243.)



**FIGURE 15.4** Equilibrium status and path of cooling. (From Fennema, O. 1995. In: *Food Preservation by Moisture Control: Fundamentals and Applications*. Technomic Publishing, Lancaster, PA. pp. 243.)

freezing point T. At this point, an ice crystal must be added to avoid undercooling and subsequent nucleation of ice, both of which are nonequilibrium events. With the ice crystal in place, further cooling will result in the formation of additional pure ice crystals and a decline in the freezing point of the unfrozen phase. Eventually, the temperature decreases to the saturation or eutectic point U. At this point, a small crystal of solute must be added to avoid supersaturation and subsequent nucleation of solute, both of which are nonequilibrium events. Fennema [53] noted that solute crystallization is mandatory to sustain thermodynamic equilibrium, and it is common even in the presence of seed crystals of solute that the solute will not crystallize at a subeutectic temperature. However, here it is assumed here to form solute crystallization. Further cooling results in crystallization of ice and solute in constant proportion, leaving the unfrozen phase unchanged in composition and freezing point. This dual crystallization process continues at constant temperature until crystallization of water and solute is as complete as possible. Further cooling will simply lower the sample temperature with no further change in physical state.

#### 15.2.4.2.2 Moderate Cooling

The metastable or nonequilibrium pathways are quite different from equilibrium cooling. Both paths start in the solution at point A, and cooling brings the sample to its initial freezing point B. At this point, further cooling at a moderate rate, consistent with commercial practices, results in undercooling to point C. This nonequilibrium supercooling eventually results in nucleation, release of latent heat of crystallization, and, if cooling is relatively slow, a reversal in temperature almost to the initial freezing point B. As ice forms with further cooling, the freezing point of the solution phase declines. With further cooling, more of the original water converts to ice and the solute eventually attains its saturation concentration D (eutectic point). Further cooling typically does not result in nucleation of solute crystals, rather the solution becomes increasingly supersaturated with solute, and this condition is normally metastable. Continued cooling to point E will cause the supersaturated unfrozen phase to convert to a metastable, amorphous solid (a glass) with a very high viscosity (about  $10^{12}$  Pa s). This temperature is the glass transition temperature ( $T_g$ ), which is usually determined by the composition of the sample and the rate of cooling. If cooling has been slow by commercial standards, the unfrozen solution can be maximally freeze concentrated, and  $T_g$ , under this circumstance, will assume quasiinvariant value known as  $T_g'$ , which is dependent only on the solute composition of the sample. In practice, maximum freeze concentration is usually not obtained, and the observed  $T_g$  differs from  $T_g'$ . Numerical data for different food components have been compiled by Rahman [126].

#### 15.2.4.2.3 Very Fast Cooling

A third possible cooling pathway (Figure 15.4) involves very rapid removal of heat from very small samples. This path has no commercial significance for foods. Thus, the ABFG path results in vitrification of the entire sample. The glass temperature is not an equilibrium process, and the cooling rate also affects the glass temperature. With very slow cooling during freezing there is a possibility of heterogeneous nucleation of ice and less possibility of ice formation. In the extreme case (fast cooling), the material may transform from liquid to glass at the melting point without further ice formation.

### 15.2.5 State of Water in Foods

Different states of water, such as bound, free, capillary, mobile, nonsolvent water, and unfreezable, are defined in the literature [126]. The state of water can be measured with different techniques or methods. The water sorption isotherm is based on three types of water: monolayer, multilayer, and mobile or free water [143]. The BET-monolayer is estimated from water sorption isotherm and commonly presented in the literature. It could be mentioned that only BET-monolayer has strong theoretical basis and should be used in stability determination. The BET-monolayer for a large number of foods and their components has been compiled by Rahman and Labuza [136]. It is not recommended to use GAB-monolayer value due to the number of defects in estimating its real value, although it is popular for its validity up to water activity of 0.9 [126].

Unfreezable water content can be estimated by comparing DSC enotherms of samples having freezable water. Paakkonen and Plit [115] measured the unfreezable water of cabbage using this method. Unfreezable water, can be estimated from the plot of melting enthalpy as a function of water content. This procedure was used for model crackers [62], strawberry [147], date flesh [129], sucrose [2], and garlic [136]. Usually, unfreezable water is independent of total water, present in the system. In case of chitin, unfreezable water increased with the increase of total water, and the amount of freezable water is relatively very low compared to the unfreezable water [116]. In case of water–gellan systems, unfreezable water increased with the size of junction zone [66]. Using NMR technique, Li et al. [99] studied the mobility of freezable and unfreezable water in waxy cornstarch determined by DSC. Water was found to be isotropically mobile for samples over a range of water contents (6.3%–47%) at room temperature. Mobility increased with increasing water content and temperature. A large fraction of unfreezable water was relatively mobile, comparable to a liquid state down to  $-32^{\circ}\text{C}$ . The decreasing fraction of mobile water with decreasing temperature suggested that only some of the so-called unfreezable water could be progressively immobilized as temperature decreased. Much of the water remained high in mobility, regardless of the relatively rigid starch molecules in the glassy solid state. This means that water in the glassy state of starch can greatly influence reactions at both ambient and freezing temperatures. At least in this example, the glassy state of the solid materials is not an appropriate term to imply or to predict the molecular dynamics of water and its influence on food stability. Bell et al. [17] determined water mobility in a polyvinyl pyrrolidone (PVP) system, as determined via NMR, and found that water mobility was not affected by glass transition. PVP systems at constant water activities and water contents, but different physical states (glassy and rubbery), had the same water mobility. An evaluation of four chemical reactions showed no relation between water mobility and kinetic data. The effect of water on chemical reactions is multidimensional and cannot be reduced to a single physicochemical parameter.

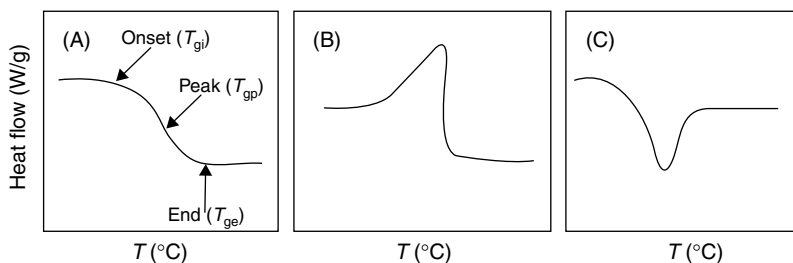
From the state diagram shown in Figure 15.1, unfreezable water can be estimated from points C and F. Comparisons of determining unfreezable water using different methods were presented for dates [129] and garlic [136]. It is always found that BET-monolayer values are much lower than that of unfreezable water [50]. Other techniques used to determine the state of water are dielectric spectroscopy, Fourier transformation infrared spectroscopy (FTIR), x-ray scattering, nuclear magnetic resonance (NMR), magnetic resonance imaging (MRI), electrical resistance, and self-diffusion [1,65,72,92]. Three states of water (polymer, capillary, and free) were identified in whey by NMR [118]. The NMR and dielectric measurements of starch paste showed one type of water, while agar gels contain two types of water, in samples containing less than 55% moisture [117]. Lang and Steinberg [94] studied the types of water in cornstarch, sugar, sodium chloride, and a mixture of starch and sugar using NMR. It was found that sucrose is a structure former, while sodium chloride is a structure breaker. Three types of water mobility were observed in sucrose solution by NMR techniques [140]. Solute–solvent and solute–solute interactions via hydrogen bonding are suggested as

the mechanisms to explain the observed decrease in water mobility. Lai et al. [93] studied the water mobility in starch-based food products when fat is replaced by fat mimetic components. The active water in starch–sucrose system was strongly dependent on sucrose content [38]. Molecular mobility of starch and water in starch–water mixtures was studied with the NMR technique and related with water sorption isotherm [42]. The effect of bound water on glycinin was studied by FTIR spectra [1]. In addition to the techniques mentioned above, many techniques are being used to determine the mobility, and state of water and solutes available for chemical reactions, but their interpretation is far from straightforward [65].

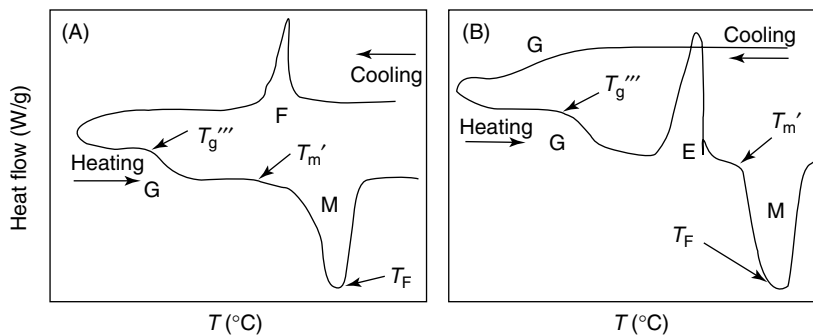
### 15.2.6 Differential Scanning Calorimetry

The glass transition temperature is difficult to determine in real food systems due to their complexity and heterogeneity [34]. The most common and popular method used to determine glass transition is the DSC that detects the change in heat capacity occurring over the transition temperature range. For almost half a century, most of the work in these systems has been carried out by DSC, which measures as a function of temperature the difference in energy inputs into a substance and its reference, with both materials subjected to a control temperature program. In the 1990s, modulated DSC (MDSC) was commercialized to increase the sensitivity and resolution of thermal analysis, and provide the heat capacity and heat flow in a single experiment [81,185]. It is common to use mainly heating DSC curve to study the characteristic transitions, and usually a heating rate of 5°C/min is used. However, heating rate affects the values of glass transition. Experimental conditions such as cooling rate, sample size, and annealing conditions used should always be reported with glass transition values. Calorimetric or spectroscopic techniques have some limitations in terms of sample size and shape, and water content control. In some cases, for example, in case of starch it is less sensitive.

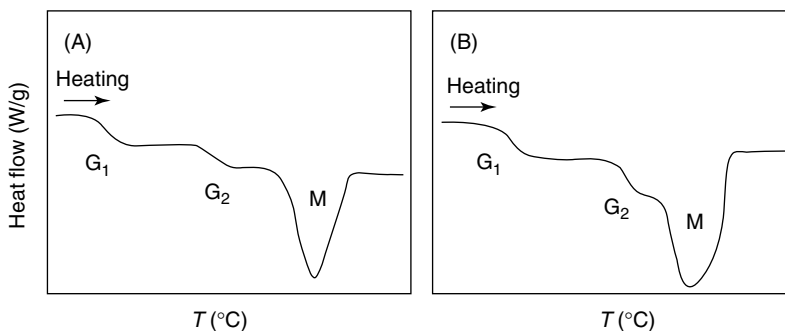
The typical DSC curves shown in Figures 15.5 through 15.7 are based on the level of moisture content and types of the samples. Figure 15.5 shows DSC graphs for low moisture content (i.e., high solids) when there is no freezable water in the sample. In the case of samples with unfreezable water, the DSC curve is shown in Figure 15.5, indicating no ice formation during cooling or ice melting during heating. Many foods or food components showed an exothermic (Figure 15.5B) or endothermic (Figure 15.5C) peak. Kasapis [81] pointed out that (at a low moisture content <30%) regardless of the polysaccharide types, an endothermic peak appeared consistently within the 45°C–80°C temperature band during the first heating scan on a calorimeter. The position of the peak remained constant and independent of the temperature shifts of the glass transition (when it appeared), but the associated enthalpy increased with moisture content [12]. This was interpreted on the basis of stabilizing enthalpic associations between water molecules and ordered macromolecular sequences. The endothermic overshoot may be deliberately used to help in detecting the glass transition, with materials for which the heat capacity jump is particularly small and smeared out over a broad temperature range. There is no consensus for the definition of the glass transition point on a DSC curve among the various points that may be chosen as onset ( $T_{gi}$ ), mid ( $T_{gp}$ ), and end ( $T_{ge}$ ). Earlier data presented in the literature dealt mainly with the mid or peak point; however, the recent trend is to present onset, mid, and end points. Champion et al. [34] pointed out that a glass transition should be characterized by at least two parameters indicating its onset or mid and the width of the transition.



**FIGURE 15.5** Typical DSC thermograms for glass transition of samples containing unfreezable water. (From Rahman, M. S. 2006. *Trends Food Sci. Technol.* 17: 129–141.)



**FIGURE 15.6** Typical DSC thermograms showing glass transition, freezing and melting endotherms for sample containing freezable water. (From Rahman, M. S. 2006. *Trends Food Sci. Technol.* 17: 129–141.)

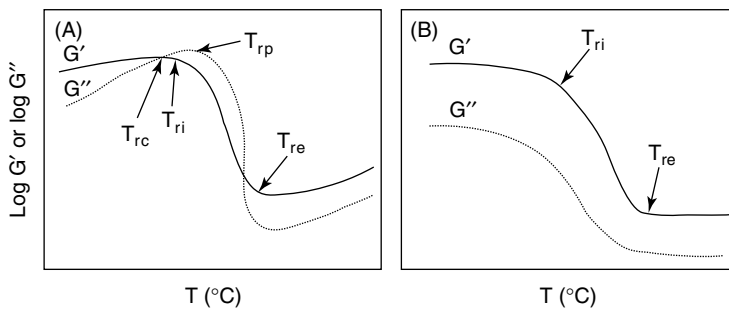


**FIGURE 15.7** Typical DSC thermograms showing two glass transitions and melting endotherm for a sample containing freezable water. (From Rahman, M. S. 2006. *Trends Food Sci. Technol.* 17: 129–141.)

Figure 15.6 shows DSC cooling and heating curves for samples containing freezable water. If the moisture content is high and the cooling rate is relatively slow, freezing of the water is observed during cooling—as shown by  $F$  in Figure 15.6A. If the sample contains relatively low freezable water and the cooling rate is relatively fast, the freezing exotherm does not appear—as shown in Figure 15.6B. The location of  $T_g'''$  and  $T_m'$  is shown in Figure 15.6. In many samples, the exothermic peaks  $E$  (Figure 15.6B) are observed after glass transition and melting endotherm in the heating DSC curve. To determine  $T_m'$ , optimum annealing needs to be performed to maximize the ice formation at a temperature between  $T_g'''$  and apparent  $T_m'$  (without annealing). It is common to perform annealing at  $T_m' - 1$ . Owing to kinetic constraints, solutions with high initial solutes (60%–80%) may require several days or even weeks of annealing at  $T_g' < T < T_m'$  until the maximally freeze-concentrated state is achieved [77]. The observed exothermic enthalpy relaxation peak during rewarming, between the glass transition and the melting endotherm, may disappear after annealing or rescanning [15,130]. This process, generally called devitrification, corresponds to ice crystallization. Freezable water that had remained unfrozen due to hindered crystallization during fast cooling, crystallizes during warming [104].

In many cases, two glass transitions are observed—as shown in Figure 15.7—even with annealing [57,130]. In extreme cases, a second glass transition may be observed with the melting endotherm (Figure 15.7B). Different hypotheses are proposed for two or more glass transitions. The two transitions occurred, one due to the backbone of a large polymer or less mobile component, and the other due to the less mobile or side chains [129]. Another reason could be due to the incompatibility of different solutes in the mixture [110]. Yet another proposed concept for solutions with a single solute is: it is the result of the formation of a solute-crystal-rich, unequilibrated phase trapped around or within the rapidly nucleated ice crystals, and solute inclusion within the ice crystals itself [64]. Li and Chen [100] used these two glass transitions to identify the degree of compatibility of rice starch–hydrocolloid mixtures. In the case of compatible samples, such as rice starch–high methoxyl pectin mixture, a new single glass transition





**FIGURE 15.8** The typical plots of  $\log G'$  or  $\log G''$  showing the glass transition. (From Rahman, M. S. et al. 2002. *J. Food Eng.* 53: 301–313.)

was exhibited, which is between the transitions of two individual components. In contrast, incompatible rice starch–low methoxyl pectin and rice starch–locust bean gum showed two transitions corresponding to the two individual components. In the case of concentrated samples with freezable water, no ice crystallization was observed during cooling, indicating that vitrification was accomplished.

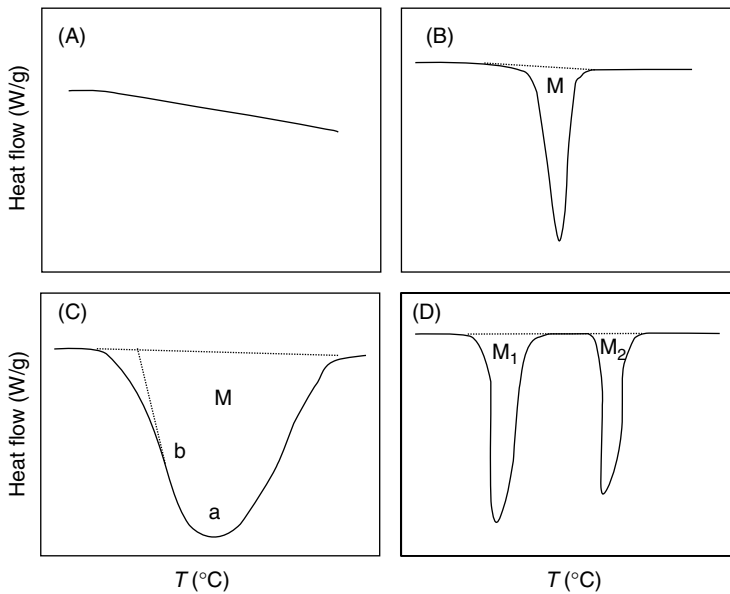
### 15.2.7 Dynamic Mechanical Thermal Analysis

Other useful and sometimes more sensitive methods include thermomechanical analysis (TMA), dynamic mechanical analysis (DMA), dynamic mechanical thermal analysis (DMTA), and dynamic oscillation method. In DMTA, structural properties are examined with  $G'$  and  $G''$  as a function of temperature at a constant frequency or time of measurement. Figure 15.8 shows the typical curves. Again, it is necessary to specify how the transition temperature ( $T_r$ ) is defined from the experimental curves. The temperature is commonly taken from the maximum of the loss factor ( $\tan \delta$ ), which is more easily determined. The maximum of the loss modulus ( $E''$  or  $G''$ ) is much better for transition determined from the point of view of its physical meaning [34]. Moreover, no  $\tan \delta$  peak is expected with small molecular weight systems. In Figure 15.8A, it was proposed that the rheological glass transition was the point between the glass transition and the glassy state [83]. The transition from  $T_g$  (DSC glass) and  $T_r$  (mechanical or rheological glass) should not be considered as fully equivalent. Shalaev and Kanev [167] mentioned that mechanical glass transition occurs above DSC glass due to the sample's ability to keep its form. In DSC and DMTA, the sample is subjected to stresses of different physical nature (change of temperature in DSC, shearing or compression in DMTA). The experimental time may also be different (depending on cooling–heating rates and annealing in DSC, on measurement frequency in DMTA). Blond [23] and Kasapis et al. [82] compared the results for glass transition from DSC and mechanical methods. A different coupling of the imposed perturbations with the structural units (with particular relaxation times) may be responsible for discrepancies in the data obtained with different techniques. In Figure 15.8B, a cross over between  $G'$  and  $G''$  is not observed. In general, it can be recommended to present  $T_{ri}$ ,  $T_{re}$ ,  $T_{rc}$ , and  $T_{rp}$  in comparison with glass transition by DSC.

### 15.2.8 Freezing Point

Cooling curve is one of the most simple and popular methods to measure the freezing point of foods. The complete discussion is not presented here since details of the cooling curve method are given by Rahman [126] and Rahman et al. [134]. The cooling curve method was used to measure the freezing point of milk [36,37], coffee extract [14], dates [84], tuna flesh [135], and garlic [136].

Typical melting endotherms for melting of ice are shown in Figure 15.9. The ice melting or freezing point is commonly characterized from the endothermic peak during melting [63,130]. This method provides very accurate determination for a sharp peak. In case of a wider peak (Figure 15.9C), it is difficult to determine from the peak. A wider peak appears due to the wide variation in the state of water in foods; in this case, the maximum slope of the endotherm (point b in Figure 15.9C) or the extra-plotted peak is used as onset temperature of the ice melting [57,63]. When the sample contains mainly free water, it shows a sharp endothermic peak at melting similar to pure water (Figure 15.9C). Multippeak natures of the DSC curves are



**FIGURE 15.9** Typical thermogram for sample containing unfreezable water and different types of melting endotherms of ice. (From Rahman, M. S. 2006. *Trends Food Sci. Technol.* 17: 129–141.)

found for the metastable states of water in gum from *Acacia senegal* [124] and gellan [66] (Figure 15.9D). The sample containing nonfreezing water shows no first-order transition (Figure 15.9A).

## 15.3 Theoretical Progresses in Glassy State

Kasapis [81] provided scientific progress of the science of the glassy phenomenon, which cuts across several domains of science. The present knowledge about glass transition is essentially phenomenological, very little is known about theoretical aspects [34]. Champion et al. [34] reviewed different proposed theories for understanding the glass transition, including free volume theory, entropy-controlled cooperative motions, mode coupling theory, frustration-limited domains, and hierarchical correlated molecular motions. Basic and deeper understanding could determine their real applications in food technology.

### 15.3.1 Free Volume Theory

Among all the theories, the free volume theory and relaxation phenomenon are beginning to contribute in explaining some changes in foods below glass temperature. Although there is as yet no fully satisfactory theory of the glass transition in polymers, the free volume approach has been widely employed in a quantitative fashion to interpret glassy phenomenon in terms of molecular processes [48]. The useful and simple concept argues that the total volume per mole of a material is the sum of the free volume and occupied volume. The latter includes not only the van der Waals radii but also the volume associated with vibrational motion of atoms. The free volume is therefore that extra volume required for larger scale vibrational motions than those found between consecutive atoms of the same chain [13]. On the free volume concept, glass transition is defined as that temperature at which free volume collapses sensibly to zero and the mobility is restricted keeping only movement allowed by the occupied volume [109]. Quantitatively, Williams–Landel–Ferry (WLF) equation is proposed as [189]:

$$\log\left(\frac{\mu}{\mu_g}\right) = \frac{-C_1(T - T_g)}{C_2 + (T - T_g)} \quad (15.1)$$

where  $T$  and  $T_g$  are the experimental and reference temperature, and  $C_1$  and  $C_2$  the WLF constants (phenomenological coefficients), which are related to the free volume. Other properties, such as shift factor ( $a_T$ ),  $G'$ ,  $G''$ , and rate constant could also be used instead of  $\mu$ . The universal values of  $C_1$  and  $C_2$  are  $-17.4$

and 51.6, respectively, as given by Williams et al. [189]. Soesanto and Williams [180] found these coefficients valid for the WLF correlation of the viscosity of sugars. Ferry [54] identified that these values fluctuate slightly as a function of material types. The VTF equation is also used and expressed as

$$\mu_g = A \exp\left(\frac{BT_0}{T - T_0}\right) \quad (15.2)$$

where  $T_0$  is the reference temperature and  $A$  and  $B$  are the parameters. Angell et al. [11] and Angell [10] classified material as strong/fragile through the glass transition based on the variations of  $B$  and  $C_2$ . The fragility parameter  $m$  was introduced to differentiate fragile systems ( $100 < m < 200$ ), which are highly sensitive to temperature changes above glass transition, from strong ones ( $16 < m < 100$ ), which are less disturbed by passage through the glass transition. The application of various methods to estimate  $m$  for food materials is available in the literature [174,175]. Champion et al. [34] discussed different values of  $m$  for food components and their practical significance of the strong/fragile classification with respect to foods. They mentioned that a small variation in the value of  $m$  for two products may result in a large difference in stability, as the sensitivities to temperature around glass transition are different. It could also benefit from a better knowledge of the strong/fragile behavior of the material processed, such as extrusion, puffing, or flaking. The theory of free volume has been quite successful in following the temperature dependence of viscoelastic functions in the glass transition region and relating parameters to molecular characteristics. Complex nonlinearity and nonexponentiality could not be explained much with free volume approach. The popularity of WLF/free volume approach is due to its simplicity, and it considers that all relaxation processes have the same temperature dependence. In addition, it does not consider the intermolecular interactions, which are more fundamental, and the ultimate determining factor of molecular dynamics in densely packed polymers [112].

### 15.3.2 Relaxation in the Glassy State

The glass transition temperature is a kinetic and relaxation process associated with the primary relaxation of the material [34]. The relaxation time (characteristic time of mobility) is the time that is necessary for the recovery of equilibrium conditions after perturbation of one property of the material. As a relaxation phenomenon, glass transition temperature can be studied with techniques such as mechanical or impedance spectroscopies, termed as  $\alpha$ -relaxation (main relaxation). When the temperature is well above glass transition, the molecules or the structural units (such as the repetitive element of a polymer) can move independently from each other because there is enough free volume between the entities. The molecular organization in the material is strongly dependent on temperature above glass transition, but it is relatively stable below glass: molecules stay in an isoconfigurational state, the cooperativity effect being restricted [34]. Within the glassy state, the change in dynamic properties obeys the Arrhenius law. Relaxation processes can be observed in the glassy state with mechanical or impedance spectroscopies. This is also evident with the endothermic features on DSC curves. In addition to the main relaxation  $\alpha$ , several secondary relaxations  $\beta$  are observed. Its origin is still being investigated and it corresponds to: more localized molecular motions (for example, in the case of sugar molecules it is linked to the presence and motions of  $-OH$  groups), molecular structure of carbohydrate, and rotation of the whole molecule in heterogeneity of the matrix [25,35,61,70,73,156]. Below glass, a microstructural change may take place, which corresponds to the system approaching the metastable equilibrium, with some extra loss in enthalpy and volume. This *physical aging* can be regarded as a continuation of the  $\alpha$  relaxation. The more compact molecular organization and the strengthening of interactions result in changes in mechanical and also in transport properties. Its relevance is being increasingly recognized with cereal products [25,34]. Physical aging is responsible for the appearance of various features on DSC curves: endothermic overshoot that expresses rapid enthalpy recovery after aging below glass transition, but also an exothermic event when rapid cooling is followed by a much slower rewarming [175]. Two other characteristics need to be explained in the glass transition domain – nonlinearity, which means that the characteristic changes with time, as it depends on the structure of the glass and nonexponential behavior, which means that the process of  $\alpha$ -relaxation cannot be described by a single relaxation function, due to microstructural heterogeneities.

Nonexponentiality is most commonly interpreted as a distribution of relaxation times and mathematically represented by a so-called stretch exponential function [34]:

$$\Phi = \exp[-(\theta/\tau)^k] \quad (15.3)$$

where  $\Phi$  is the mechanical property and exponent  $k$  close to 1 for strong liquids (nearly exponential relaxation). For fragile liquids, it changes from near 1 at high temperature to a value close to 0.3–0.5 near glass transition [34]. In this situation, Ngai et al. [112] used stretched exponential function of Kohlrausch, Williams, and Watts (KWW). In case of stress relaxation modulus

$$\Phi = (\Phi_g - \Phi_e)[\exp(\theta/\tau)^{1-n}] + \Phi_e \quad (15.4)$$

where  $\Phi_g$  is the glassy mechanical property,  $\Phi_e$  the equilibrium mechanical property of the local segmental motion,  $\theta$  the time after the application of a fixed strain,  $\tau$  a measured relaxation time, and  $n$  the coupling constant, which ranges from 0 to 1.0. It was found that strongly coupled (interacting) systems have high values of  $n$  and an apparently broad distribution of relaxation times, which is the cornerstone of the coupling theory [144]. The parameter  $n$  need not be constant during a relaxation, hence the theory is not thermorheologically simple. Kasapis [81] anticipated that much attention would be focused in the area of coupling theory in the future. Other types of theoretical models are discussed by Champion et al. [34].

## 15.4 Applications of Glassy State Concept in Food Systems

A low glass transition means that at room/mouth temperature, the food is soft and relatively elastic, and at higher temperatures it may even flow. In contrast, a food with a high glass transition temperature is hard and brittle at ambient temperature. Glass transition and state diagram concepts are widely applied in foods to explore its validity. The following section provides a review on this aspect.

### 15.4.1 Diffusion Process

The glass transition affects diffusion-controlled chemical reactions through the decrease of diffusion coefficient [79,179]. The decrease in diffusivity is due to the changes in viscosity and mobility. The diffusion time of a water molecule over 1 Å distance should be more than  $10^6$  years at room temperature in a glassy matrix based on the Stoke–Einstein relation [34]. The timescale for the loss of stability in food at low water content is not so large. Ablett et al. [3] measured translational diffusion coefficients of water using the pulsed-field gradient NMR technique in 81% pullulan. They showed that diffusivity of water is around  $4 \times 10^{-11}$  m<sup>2</sup>/s at glass transition. There was no significant drop below the glass transition, instead there was a change in slope above or below the glass transition when diffusivity was plotted as a function of temperature. The diffusion coefficient of water in low-moisture food polymers decreased with the decrease in moisture content, without any break in the glass transition when diffusivity was plotted versus water content. The diffusivity depends mainly on moisture content and exhibits a low sensitivity to the nature of the surrounding polymer [27]. In the case of water diffusivity in maltose–water mixtures above and below glass transition, Parker and Ring [119] plotted diffusivity and viscosity as a function of  $T_g/T$  and found that the slopes for diffusivity and viscosity with temperature were not parallel, but instead were extremely divergent when  $T_g/T > 0.8$ . This decoupling evidence (between viscosity of the diffusion medium and diffusion of small molecule) indicated that the decrease in diffusivity near or below glass is not solely due to the decrease in viscosity. Another important factor affecting diffusivity, in addition to glassy state, is the porosity, porous structure, and structural collapse of foods. The release of entrapped volatiles and flavors is also important to food stability. Arrhenius plot of diffusivity of helium, methanol, and ethyl bromide and glass transition temperature of sucrose: raffinose matrix showed changes in the slope at glass transition [77].

When the molecular size of the diffusing molecule is very small, compared to the molecules of the matrix, the Stokes–Einstein relation is inadequate to predict the reactant diffusion. In this case, solute diffusion and macroscopic viscosity did not significantly reduce the diffusion of small molecules [46,95,105]. The decoupling effect from Stokes–Einstein relation based on viscosity was also observed for diffusion of fluorescein in sucrose solutions [33]. The decoupling started at  $T_g/T > 0.86$ , and the discrepancy increases as temperature reaches glass transition. The motion of small probes in such viscous materials may be facilitated by the presence of nanodefects or by local motions in the material (secondary relaxations).

### 15.4.2 Texture and Structure

If the moisture content of crispy products such as chips, crackers, cornflakes, and extruded products increases due to water sorption or if the temperature is increased during storage, the crispy structure is lost [34]. Roudaut et al. [155] showed that the loss of the crispy texture of dried white bread corresponds to a critical water content of 9%–10% for which samples are in the glassy state. A sharp decreasing trend was observed when compressive failure stress of the frozen sample is plotted as a function of temperature. This change was defined as brittle–ductile transition. It is not generally true that brittle–ductile appears at glass transition, although in certain cases the brittle–ductile transition coincided with the glass transition temperature [120]. Nicholls et al. [113] clearly demonstrated that the brittle–ductile transition occurred within gelatinized starch, while it was still in the glassy state as defined by the DSC. Watanabe et al. [187] found that there was a remarkable difference between the brittle–ductile and glass transitions temperature in case of fish meat. They pointed out that to ascertain the reasons as to why these are different, lengthy and detailed experimentation is necessary because the brittle–ductile transition depends on a number of extrinsic factors, including strain rate, temperature, stress state, specimen geometry, and the presence of notches and flaws.

### 15.4.3 Crystallization

Temperatures above glass allow molecular mobility and rearrangement of molecules to the crystalline state [97]. Crystallization releases adsorbed water, which in closed containers further plasticizes the remaining amorphous portion of the material [85,154]. Crystallization causes the most drastic changes to the physical properties of food polymers. It may considerably affect food stability and it may impair the rehydration properties of food powders [85,154,169]. It also affects textural properties, e.g., crystallization of starch in bakery products during staling [179]. Lactose crystallization in milk powders leads to increased free fat and flavor deterioration, and it may also promote nonenzymatic browning [85,160]. The crystalline materials are not able to entrap other compounds, which become completely released due to crystallization, thus volatiles are lost and lipids become exposed to oxygen. Increasing  $T-T_g$  raises the rate of crystallization, with increasing crystallinity. Sandiness in ice cream resulted from lactose crystallization [150]. The crystallization time for amorphous lactose can be predicted using WLF equation [154]. The extent of crystallization and melting behavior of gelatinized cornstarch was affected by  $(T-T_g)$  [71]. Crystallization under low  $T-T_g$  conditions appears to produce smaller and less perfect crystallites than those produced under high  $T-T_g$  conditions, owing to lower molecular mobility. The crystallization of isomalt in plasticized form was reduced by adding hydrogenated starch hydrolysates (HSH). The low-molecular HSH appeared to be more effective in reducing crystallization than high-molecular HSH, which indicates that high glass transition is not necessarily the best inhibitor of isomalt crystallization [108]. In honey stored at 20°C, coarse crystals were formed with melting temperatures between 45°C and 65°C, whereas honey stored at –20°C granulated as a finely grained, fondant-like honey, melting between 25°C and 45°C. In honeys stored at 10°C and 4°C, big and small crystals were produced having intermediate characteristics when compared with honeys stored at 20°C and –20°C [102].

### 15.4.4 Stickiness

Initiation of viscous flow, caking, and stickiness depends on the glass transition temperature. In the case of spray-dried lactose, caking and collapse increased with increase in  $T-T_g$  [101]. The sticky point of an amorphous sucrose and fructose was found to be 10°C higher than glass transition [153].

### 15.4.5 Grain Damage by Drying

It was found that for a Bengal variety of rice grain, at a moisture content of 15% (wet basis) the values for thermal expansion coefficients  $\beta_{\text{glass}}$  and  $\beta_{\text{rubber}}$  were  $8.60 \times 10^{-5}/^\circ\text{C}$  and  $4.99 \times 10^{-5}/^\circ\text{C}$ , respectively [121]. Similarly, for Cypress at 14% moisture content, the values for  $\beta_{\text{glass}}$  and  $\beta_{\text{rubber}}$  were  $8.80 \times 10^{-5}/^\circ\text{C}$  and  $4.26 \times 10^{-5}/^\circ\text{C}$ , respectively. It can be seen that there is a considerable difference between the values

of  $\beta_{\text{glass}}$  and  $\beta_{\text{rubber}}$  in the two zones of the state diagram. A hypothesis based on glass transitions inside rice kernels was proposed to explain rice fissure formation during the drying process [44,122,170]. Similarly, when drying occurred in the glassy region, head rice yield was not reduced noticeably after drying. When drying occurred in the rubbery region and no tempering was performed immediately following drying, head rice yield reduction would be marginal if the drying durations were shorter than the maximum moisture content gradient time [190,191].

#### 15.4.6 Pore Formation in Foods

The glass transition theory is one of the concepts that has been proposed to explain the process of shrinkage, collapse, fissuring, and cracking during drying [45,75,76,89,129]. The *hypothesis* indicates that a significant shrinkage can be noticed during processing only if the drying temperature is higher than the glass transition of the material at that particular moisture content [6]. The methods of freeze-drying and hot-air drying can be compared based on this theory. In freeze-drying, if the drying temperature is below or close to  $T_g'$  (maximally freeze-concentrated glass transition temperature, which is independent of solids content) or  $T_g$  (glass transition as a function of solids content), the material is in the glassy state. Hence shrinkage is negligible. As a result, the final product is very porous. With hot-air drying, however, if the drying temperature is above  $T_g'$  or  $T_g$ , the material is in the rubbery state and substantial shrinkage occurs causing a lower level of pores. Karel et al. [77] performed freeze-drying under high vacuum (0.53 Pa) and reduced vacuum conditions (90.64 and 209.28 Pa) to obtain varying initial sample temperatures that were below ( $-55^\circ\text{C}$ ), near ( $-45^\circ\text{C}$ ), and above ( $-28^\circ\text{C}$ ) for the three vacuum pressure. Collapse was determined by measuring apparent shrinkage before and after freeze-drying of apple, potato, and celery. Samples dried at  $-55^\circ\text{C}$  showed no shrinkage (more pores), while shrinkage increased with an increase in drying temperature, justifying the glass transition concept. Recent experimental results dictate that the concept of glass transition is not valid for freeze-drying of all types of biological materials, thereby indicating the need to incorporate other concepts [159], and thus a unified approach ought to be used. In the case of freeze drying, pore formation in food materials showed two distinct trends when shelf temperatures were maintained at a constant level between  $-45^\circ\text{C}$  and  $15^\circ\text{C}$  [159]. The materials in group I (i.e., abalone, potato, and brown date) showed a decreasing trend, whereas those in group II (i.e., apple and yellow date) showed an increasing trend in pore formation. This may be due to the structural effects of the materials. However, none of the papers measured the actual temperature history of the sample passing during freeze drying. The temperature and moisture history of the sample during freeze drying could shed more fundamental knowledge and thus help explain the real process of pore formation or collapse.

In many cases of convection air-drying, observations related to collapse or pore formation are just the *opposite of the glass transition* concept [47,137,138,186]. The mechanism proposed for this was the concept of case hardening, and internal pressure development [6,137,138]. They indicated that at a low drying rate (low temperature), the moisture gradient within the product is small and internal stresses are low and hence the material shrinks down fully onto a solid core, and shrinkage is uniform. At a high drying rate (higher temperature), the surface moisture decreased very rapidly so that the surface became stiff (i.e., case hardening phenomenon), limiting subsequent shrinkage, thus increasing pore formation [133]. In this instance of case hardening, the permeability and integrity of the crust play a role in maintaining the internal pressure inside the geometric boundary. Internal pressure always tries to puff the product by creating a force to the crust. Glass transition concept cannot explain the effect of crust and internal pressure. In the case of tuna meat, vacuum-drying produced higher porosity compared to air drying when both samples were dried at  $70^\circ\text{C}$  [132]. The porosity of dehydrated products increased as vacuum pressure decreased, which means shrinkage can be prevented by controlling pressure [90]. Microwaving creates a massive vaporization situation causing puffing [123]. This indicates that in addition to the temperature effect, environment pressure also affects pore formation, and this effect cannot be explained by the glass transition concept. Similarly, in the case of extrusion, after the processing temperature exceeds  $100^\circ\text{C}$ , porosity also increases correspondingly, which is contrary to the glass transition concept [7]. This is due to the rapid vaporization of water vapor at the exit of the die. After analyzing experimental results from literature, Rahman [128] identified that the glass transition theory does not hold true for all products or processes. Other concepts, such as surface tension, pore pressure, structure, environment pressure, and mechanisms of

moisture transport, also play important roles in explaining the formation of pores. Rahman [128] hypothesized that as capillary force is the main force responsible for collapse, counterbalancing this force causes formation of pores and lower shrinkage. The counterbalancing forces are a result of the generation of internal pressure due to vaporization of water or other solvents, variations in moisture transport mechanism, and pressure outside the material. The other factor could be strength of the solid matrix (i.e., ice formation; case hardening; surface cracks formation; permeability of water through crust; change in tertiary and quaternary structure of polymers; presence or absence of crystalline, amorphous, and viscoelastic nature of solids; matrix reinforcement; and residence time). However, some of these factors are related to glass transition.

### 15.4.7 Microbial Stability

The microbial stability of food has long been estimated by its water activity. The rule is: (i) lower the water activity, more microbiologically stable the food, and (ii) foods are most stable at its BET-monolayer moisture content. The water activity at the monolayer water content is also called the *critical water activity*. One defect in this concept is that microbial stability is affected by the nature and type of the solute at a given water activity. Another weakness is that water activity is defined at equilibrium, whereas foods at low and intermediate moisture are not in a state of equilibrium. In the dynamic state, water may be migrating from one component of food to another. This nonequilibrium state is difficult to predict by the equilibrium state defined by water activity.

What are the alternatives? Slade and Levine [176] and Franks [59] maintained that water activity could serve as a useful, but not the sole indicator of microbial safety. Slade and Levine's [176] hypothesis was that water dynamics or glass-rubber transition may be applied instead of water activity to predict the microbial stability of concentrated and intermediate-moisture foods. Sapru and Labuza [161] studied the inactivation of bacterial spores and their glass transition temperature. Spores at glass transition have high heat resistance, and above glass they are easy to inactivate. At a given temperature, the inactivation rate decreases with the increase of glass transition temperatures of spores. Chirife and Buera [40] maintained that glass-rubber transition would not be useful in predicting with confidence the microbial stability of foods. They analyzed data from the literature and concluded that water activity and glass transition are two different entities. The mobility factors (i.e., glass transition) in addition to water activity are not useful for a better definition of microbial stability of foods. Water activity is a solvent property and glass is a property related to the structure of food. Thus, both properties are needed for understanding food-water relationships at different conditions [40,182,184].

Macroscopic heterogeneities in a food material can induce the presence of areas with a higher mobility [34]. Chirife et al. [41] investigated microbial stability in glassy white bread and maltodextrins. They showed that mold growth may be possible below glass transition if nonglassy microregions exist. Champion et al. [34] stressed the need for further studies to investigate the effects of nonhomogeneous water distribution and phase separation on reaction rates. Hills et al. [67] first studied using NMR relaxation and electrical conductivity to actually distinguish the effect of local rather than global water activity on microbial stress in porous media. They found that microbial stress does not correlate with the global water activity measured for the whole assembly, but rather with the local water activity of the water actually surrounding the cells.

### 15.4.8 Desiccation-Tolerant Organisms

Desiccation-tolerant organisms (anhydrobiotes), such as seed and pollen, are capable of surviving the removal of their cellular water. The life span of seeds can be remarkably long, ranging from decades to centuries [86,125,181] and even millennia [168]. In the late 1980s, Burke [31] forwarded the hypothesis that the cytoplasm of seeds could enter into a glassy state. He suggested that in dry anhydrous organisms, glasses could be formed from cell solutes like sugars that were known to provide protection from denaturation of large molecules and formation of molecular aggregates, and high viscosity may stop all chemical reactions that require molecular diffusion. Thus, the glass concept turned out to be an interesting hypothesis to account for survival in the dry state. The physiological importance of the glassy state in desiccation tolerance and storage longevity was also assessed. More recently, in addition to the measurement of glass transition temperature, efforts focused on the assessment of additional physical properties such as molecular density and local viscosity of the intracellular glassy matrix [30]. When the concept of glasses

was introduced in seed science, sugars were thought to play an important part in the composition and properties of the glassy matrix. Many studies were conducted to explore the biological and physicochemical properties of the intracellular glassy matrix. Several techniques have been developed to provide further insights into the molecular properties of glasses, such as electron paramagnetic resonance (EPR) and Fourier transform infrared (FTIR) spectroscopy. Recently, Buitink and Leprince [30] reviewed the molecular properties of glasses. It is considered that the protective effect is improved by hydrogen bonding, water replacement of the sugars with proteins, increasing  $T_g$  and  $T_c$  (collapse), and filling the small voids. A *perfect biological glass* would exhibit a high  $T_g$  and  $T_c$ , low molecular mobility, and high density, existing of a mixture of molecules that have high hydrogen bonding capacity to undergo direct interactions with their neighboring molecules as well as to prevent phase separation and crystallization [30].

### 15.4.9 Oxidation

The oxidation phenomenon, such as fat or ascorbic acid oxidation, occurs in low-moisture food systems. The oxidation of unsaturated lipids entrapped in sugar-based matrices is affected by physical changes such as collapse or crystallization occurring above glass transition [91,169]. The encapsulated oil is released as a consequence of the crystallization of amorphous lactose. The released oil undergoes rapid oxidation, while encapsulated oil remains unoxidized.

### 15.4.10 Nonenzymatic Browning

Karmas et al. [80], Karel et al. [78], and Buera and Karel [29] indicated that phase transitions with physical aspects of the matrix are factors affecting the rates of nonenzymatic browning reactions. Nonenzymatic browning below glass transition was very slow. The systems used were vegetables, dairy products, and model food systems with amino acids and sugars in a PVP matrix. Karmas et al. [80] showed that the rate of the reaction is low at temperatures below glass and increases with increase in  $T-T_g$ . They also pointed that the reaction is also controlled by several other factors such as structural changes and water content independent of its plasticizing effect. In this case, both moisture and glass transition affected the reaction rate [29]. This is due to the changes in diffusion coefficient below glass transition when nonenzymatic reactions take place in the diffusion-limited region. Roos and Himberg [148] also showed that it is not stopped by the glass transition temperature of the maltodextrin, lysine, and xylose matrix, and is possible in the glassy state. The WLF equation was found valid in predicting the reaction rate constant as a function of moisture and temperature above glass [29].

There is no general rule as to whether water activity or glassy state of the system, as dictated by glass transition temperature, impacts the rates of chemical reactions in reduced moisture solid food systems. Bell [16] studied the kinetics of nonenzymatic browning pigment formation in a model PVP (different molecular weight) matrix. The browning rates of matrices having different glass temperature, but constant water activity, were significantly different except when all were in the glassy state. As the system changed from a glassy state to a rubbery state, the rate of browning increased sevenfold. The rate of browning also increased as water activity increased from 0.33 to 0.54, but then appeared to plateau with further increases in water activity. In addition, the concentration of reactants in the aqueous microenvironment had a significant impact on the rate of brown pigment formation.

Bell et al. [21] studied the glycine loss and Maillard browning as a function of glass transition temperature. At a water activity of 0.54, pH 7, and stored at 25°C, the rate constants were very low when  $T-T_g$  is close to zero and increased with the increase in  $T-T_g$ . O'Brien [114] studied the rate of nonenzymic browning in freeze-dried model systems containing lysine with glucose, sucrose, or trehalose at pH 2.5 and a water activity of 0.33. The temperatures were at 40°C, 60°C, and 90°C. All systems were in rubbery state at 90°C, whereas at 40°C and 60°C trehalose was in mixed amorphous glass-crystalline system while glucose and sucrose were in rubbery state. The rate of nonenzymatic browning in the trehalose system was much lower than that in sucrose or glucose, depending on temperature. The rate constant was in the order: glucose > sucrose > trehalose. The presence of crystalline material in the trehalose system at 40°C and 60°C may have influenced the overall rate of hydrolysis, stabilizing the system. At 90°C, all systems were in rubbery state, and there were substantial differences between the stability of sucrose and trehalose. Thus, glass transition is not only the controlling factor for rate of browning, but mainly the



rate-limiting sucrose hydrolysis step since glucose had a very high rate than sucrose. The effect of glass transition was much less than previously reported. Karel et al. [77] developed correlation for the browning rate constant as a function of  $1/T$ , moisture content, and  $T-T_g$ .

Bell and Hageman [18] studied the kinetics of aspartame degradation in the PVP model system at constant temperature (25°C) and pH (7.0) as a function of water activity and glass transition independently. Degradation reaction rates at constant water activity, but different glass transition temperature, were not significantly different and rates at a similar distance from  $T_g$ , but different water activities, were significantly different. Thus, the rate of aspartame degradation was significantly influenced by the water activity, while the effect of the glass transition temperature on the reaction was negligible.

#### 15.4.11 Enzymatic Reaction

Several enzymatic reactions can occur at low water contents [49,171] or in the frozen state [52,53,60,172,173] such as those catalyzed by alkaline phosphatase, lipoxygenase, lipase, or invertase. The effect of temperature on the reaction rate depends on the relative value of the diffusion of the reactants and the activity of the enzyme in such a concentrated media. Champion et al. [34] pointed that there is risk of proposing a unified theoretical model to predict the reactions in such concentrated materials. Torreggiani et al. [183] found no clear relationship between the anthocyanin loss and  $T-T_g$  of strawberry juices. Other important factors such as the pH of the unfrozen phase could influence anthocyanin pigment stability. It could be hypothesized that sorbitol showing stability could alter the nucleophilic power of the water or could play a specific protective role, due to its chemical nature, in the enzymatic breakdown of the anthocyanin pigments.

#### 15.4.12 Denaturation of Protein

The properties and functionality of the protein depend on whether it exists in the native or denatured state; maintaining protein structure and functionality is important in food science. The kinetics of aspartame degradation was evaluated in poly(vinyl) pyrrolidone model system [18,20]. Reaction rates at constant water activity but different glass transition values were not significantly different. Moreover, rates at the same values of  $T-T_g$  were significantly different with changing water activity. The temperature of denaturation decreased with increasing moisture content to some plateau, where further increases in moisture no longer influenced the denaturation temperature [19]. Bell and Hageman [19] studied the denaturation temperature of globular proteins ( $\beta$ -lactoglobulin, ovalbumin, and ribonuclease) in dry state as a function of glass transition temperatures of polyhydroxy compounds (water, glycerol, sorbitol, sucrose, and trehalose). The component was in the 25%–33% w/w range. They found that the thermal stability of protein correlated with glass transition temperatures of polyhydroxy component, and lower the  $T_g$  of the component, greater was the degree of protein destabilization. They hypothesized that in dry state, the additives were acting as plasticizers, enhancing the mobility and thus the unfolding of the globular proteins.

#### 15.4.13 Hydrolysis

The effect of glass transition on different chemical reactions is not as clear as in the cases with physical changes. This is due to the multiple roles of water in foods, such as plasticizer, reactant or product of chemical reactions, and pH [28]. One of the chemical reactions that was proposed to occur only in the rubbery phase (i.e., above glass transition) is sucrose inversion in acid-containing amorphous powders [98]. Buera et al. [28] investigated the effect of glass transition on the rate of acid-catalyzed sucrose hydrolysis in an amorphous polymeric matrix of PVP. No direct relationship was found between sucrose hydrolysis in a PVP matrix and  $T_g$  or  $T-T_g$ . Glass transition is not a key factor determining the rate of sucrose hydrolysis. The major effect on the rate of hydrolysis was related to changes in pH, which is moisture dependent. Knowledge of the actual pH of a system and the possible changes that may occur during concentration or drying is necessary for better understanding of chemical changes in low- and intermediate-moisture foods. Sucrose hydrolysis in an acid-containing (low pH 3.1) amorphous starch powder (native or pregelatinized) occurred to a significant extent in the glassy state [162]. The mobility effects do not control the extent of reaction. Hydrolysis (31%–85% remaining sucrose) was observed at

different water content and temperature below glass. Little reaction occurred at moisture contents below the so-called BET-monolayer. Temperature was a critical factor controlling sucrose inversion.

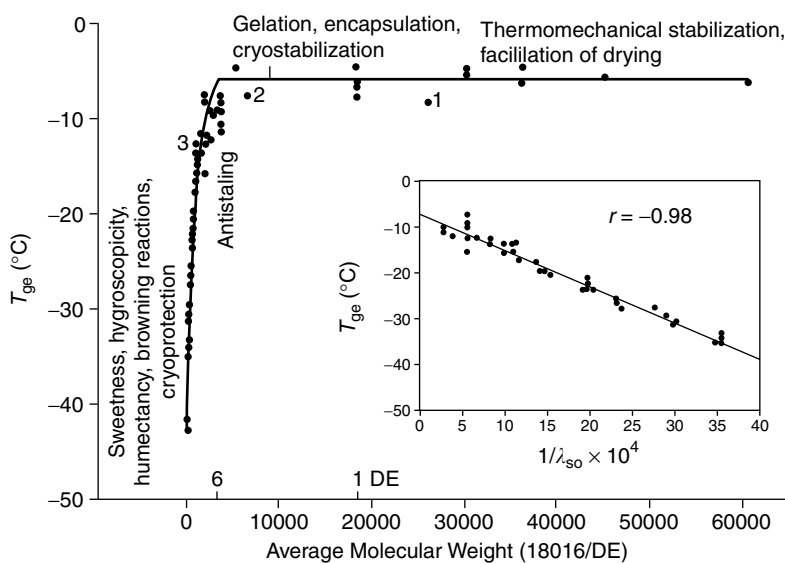
#### 15.4.14 Enzyme Inactivation and Other Chemical Reactions

The stability of enzymes in low-water systems was analyzed based on the glass concept. The stability of lactase during heating at 70°C was studied in different amorphous glassy matrices: trehalose, maltodextrin, or poly(vinyl) pyrrolidone [107]. The protective effect of the maltodextrin and poly(vinyl) pyrrolidone matrices on the enzyme was attributed to their glass transition temperature, but the trehalose matrix is much more efficient for enzyme stability independent of its glass transition value. Schebor et al. [163] studied the stabilization of the enzyme invertase ( $\beta$ -fructofuranosidase) by its incorporation in aqueous model systems of trehalose, maltodextrin, and poly(vinyl) pyrrolidone followed by freeze-drying and desiccation to zero moisture content. When the systems were heated to 90°C for thermal inactivation of invertase, the enzyme was protected by maltodextrin and PVP, but not significantly protected by trehalose, although all systems were in the glassy state. Cardona et al. [32] observed significant inactivation of invertase when maltodextrin and PVP were kept well below their glass transition, but the enzyme was fairly stable in rubbery trehalose systems. At moisture contents that allowed trehalose crystallization, rapid thermal inactivation of invertase was observed. The invertase inactivation in heated systems of reduced moisture could not be predicted on the basis of glass transition, and this was particularly true for trehalose for which it was evident that the glassy state was not the main stabilizing factor.

The relevance of glass transition as a reference temperature for predicting the rate of chemical or enzymatic reactions was studied, but no clear relationship has been established [34]. Bell and White [22] studied thiamin loss as a function of water activity and glass transition temperature. The maximum rate constant appeared to be around  $T - T_g = -23^\circ\text{C}$ . Below glass transition (i.e., lower  $T - T_g$ ), the rate constant decreased and correlated reasonably well with the decreasing values of  $T - T_g$ . In the rubbery region (i.e., water activity more than 0.4), the rate constants no longer correlated with  $T - T_g$ , but correlated instead with water activity. The reason could be attributed to the collapse of the matrix.

#### 15.4.15 Sensory Properties

The effect of molecular weight on the glass temperature of starch hydrolysis products (SHP) is shown in Figure 15.10. The plateau region in Figure 15.10 indicates the useful range of gelation, encapsulation,



**FIGURE 15.10** Effect of molecular weight on glass transition of starch hydrolysis product (SHP). (From Levine, H., Slade, L. 1986. *Carbohydr. Polym.* 6: 213–244.)

cryostabilization, thermochemical stabilization, and facilitation of drying process. The lower end corresponds to the area of sweetness, browning reactions, and cryoprotection. The intermediate region at the upper end of the steeply rising portion represents the area of antistaling ingredients. The map can be used to choose individual SHPs or mixtures of SHPs and other carbohydrates to achieve the desired complex functional behavior for specific product applications [97]. For example, the synthesis of SHPs capable of gelation from solution should be designed to yield materials of dextrose equivalent (DE)  $\leq 6$  and  $T_g' \geq 8^\circ\text{C}$ . Similarly, potato starch maltodextrins of 5–6 DE (25% w/w) produced thermoreversible, fat-mimetic gels, and tapioca SHPs of DE  $\leq 5$  also form fat-mimetic gels from solution to develop fat-replaceable ingredients [26,141,142]. Levine and Slade [97] developed a linear relation between DE and glass transition temperature of maximally freeze-concentrated solution of commercial SHPs. Thus, the correlation can be used to approximately calculate DE for dextrin and maltodextrin of unknown SHPs, which can do away with the more tedious and time-consuming classical experimental methods for DE determination [111].

Glass transition alone could not be considered as a generic rule for food stability criteria since in a number of instances, such as pore formation, diffusion, microbial stability, and nonenzymatic browning, other factors or mechanisms play an important role. However, glass transition is definitely one of the factors affecting stability, and presents a future challenge to combine the glass concept with other mechanisms or factors such as water activity, pH, and preservatives [131].

---

## References

1. Abbott, T. P., Nabetani, H., Sessa, D. J., Wolf, W. J., Liebman, M. N., Dukor, R. K. 1996. Effects of bound water on FTIR spectra of glycinin. *J. Agric. Food Chem.* 44: 2220–2224.
2. Ablett, S., Darke, A. H., Izzard, M. J., Lillford, P. J. 1992. Modelling of heat capacity–temperature data for sucrose–water systems. *J. Chem. Soc. Faraday Trans.* 88(6): 795–802.
3. Ablett, S., Darke, A. H., Izzard, M. J., Lillford, P. J. 1993. Studies of the glass transition in malto-oligomers. In: *The Glassy States in Foods*. Blanshard, J. M. V., Lillford, P. J. Eds. Nottingham Press, Nottingham. pp. 189–206.
4. Ablett, S., Izzard, M. J., Lillford, P. J. 1992. Differential scanning calorimetric study of frozen sucrose and glycerol solutions. *J. Chem. Soc. Faraday Trans.* 88(6): 789–794.
5. Ablett, S., Izzard, M. J., Lillford, P. J., Arvanitoyannis, I., Blanshard, J. M. V. 1993. Calorimetric study of the glass transition occurring in fructose solutions. *Carbohydr. Res.* 246: 13–22.
6. Achanta, S., Okos, M. R. 1996. Predicting the quality of dehydrated foods and biopolymers – research needs and opportunities. *Drying Technol.* 14(6): 1329–1368.
7. Ali, Y., Hanna, M. A., Chinnaswamy, R. 1996. Expansion characteristics of extruded corn grits. *Food Sci. Technol.* 29: 702–707.
8. Allen, G. 1993. A history of the glassy state. In: *The Glassy State in Foods*. Blanshard, J. M. V., Lillford, P. J. Eds. Nottingham University Press, Nottingham. pp. 1–12.
9. Angell, C. A. 1988. Perspective on the glass transition. *J. Phys. Chem. Solids.* 49: 863–871.
10. Angell, C. A. 1991. Relaxation in liquids, polymers and plastic crystals—strong/fragile patterns and problems. *J. Non-Cryst. Solids.* 13–31 and 131–133.
11. Angell, C. A., Bressel, R. D., Green, J. L., Kanno, H., Oguni, M., Sare, E. J. 1994. Liquid fragility and the glass transition in water and aqueous solutions. *J. Food Eng.* 22: 115–142.
12. Appelqvist, I. A. M., Cooke, D., Gidley, M. J., Lane, S. J. 1993. Thermal properties of polysaccharides at low moisture: 1 an endothermic melting process and water carbohydrate interactions. *Carbohydr. Polym.* 20: 291–299.
13. Arridge, R. G. C. 1975. The glass transition. In: *Mechanics of Polymers*. Clarendon Press, Oxford. p. 24–50.
14. Barnett, S. 1973. Freezing of coffee extract to produce a dark colored freeze-dried product. *AIChE Symposium Series.* 69(132): 26–32.
15. Baroni, A. F., Sereno, A. M., Hubinger, M. D. 2003. Thermal transitions of osmotically dehydrated tomato by modulated temperature differential scanning calorimetry. *Thermochim. Acta.* 395: 237–249.
16. Bell, L. N. 1996. Kinetics of nonenzymatic browning in amorphous solid systems: distinguishing the effects of water activity and the glass transition. *Food Res. Int.* 28: 591.

17. Bell, L. N., Bell, H. M., Glass, T. E. 2002. Water mobility in glassy and rubbery solids as determined by oxygen-17 nuclear magnetic resonance: impact on chemical stability. *Food Sci. Technol.* 35: 108–112.
18. Bell, L. N., Hageman, M. J. 1994. Differentiating between the effects of water activity and glass transition dependent mobility on a solid-state chemical reaction: aspartame degradation. *J. Agric. Food Chem.* 42: 2398–2401.
19. Bell, L. N., Hageman, M. J. 1996. Glass transition explanation for the effect of polyhydroxy compounds on protein denaturation in dehydrated solids. *J. Food Sci.* 61: 372–374 and 378.
20. Bell, L. N., Labuza, T. P. 1991. Aspartame degradation kinetics as affected by pH in intermediate and low moisture food systems. *J. Food Sci.* 56: 17–20.
21. Bell, L. N., Touma, E., White, K. L., Chen, Y. 1998. Glycine loss and Maillard browning as related to the glass transition in a model food system. *J. Food Sc.* 63(4): 625–628.
22. Bell, L. N., White, K. L. 2000. Thiamin stability in solids as affected by the glass transition. *J. Food Sci.* 65(3): 498–501.
23. Blond, G. 1994. Mechanical properties of frozen model solutions. *J. Food Eng.* 22: 253–269.
24. Blond, G., Simatos, D., Catte, M., Dussap, C. G., Gros, J. B. 1997. Modeling of the water-sucrose state diagram below 0°C. *Carbohydr. Res.* 298: 139–145.
25. Borde, B., Bizot, H., Vigier, G., Emery, J., Buleon, A. 1999. Sub  $T_g$  relaxations and physical ageing in hydrated glassy polysaccharides. In: *Biopolymer Science: Food and Non Food Applications*. Colonna, P., Guilbert, S. Eds. INRA Editions, Paris. pp. 167–172.
26. Braudo, E. E., Belavtseva, E. M., Titova, F. F., Plashchina, I. G., Krylov, V. L., Tolstoguzov, V. B., Schierbaum, F. R., Richter, M. 1979. Struktur und Eigenschaften von maltodextrin-hydrogelen. *Starch.* 31:188 .
27. Bruin, S., Luyben, K. 1980. In: *Advances in Drying*. Mujumdar, A. Ed. Hemisphere, Washington, DC.
28. Buera, M. D. P., Chirife, J., Karel, M. 1995. A study of acid-catalyzed sucrose hydrolysis in an amorphous polymeric matrix at reduced moisture contents. *Food Res. Int.* 28: 359–365.
29. Buera, M. P., Karel, M. 1993. Application of the WLF equation to describe the combined effects of moisture and temperature on nonenzymatic browning rates in food systems. *J. Food Process. Preserv.* 17: 31–45.
30. Buitink, J., Leprince, O. 2004. Glass formation in plant anhydrobiotes: survival in the dry state. *Cryobiology.* 48: 215–228.
31. Burke, M. J. 1986. The glassy state and survival of anhydrous biological systems. In: *Membranes, Metabolism and Dry Organisms*. Leopold, A. C. Ed. Cornell University Press, Ithaca, New York. pp. 358–363.
32. Cardona, S., Schebor, C., Buera, M. P., Karel, M., Chirife, J. 1997. Thermal stability of invertase in reduced-moisture amorphous matrices in relation to glassy state and trehalose crystallization. *J. Food Sci.* 62: 105–112.
33. Champion, D., Hervet, H., Blond, G., Le Meste, M., Simatos, D. 1997. Translation diffusion in sucrose solutions in the vicinity of their glass transition. *J. Phys. Chem.* B10: 10674–10679.
34. Champion, D., Le Meste, M., Simatos, D. 2000. Towards an improved understanding of glass transition and relaxations in foods: molecular mobility in the glass transition range. *Trends Food Sci. Technol.* 11: 41–55.
35. Chan, R. K., Pathmanathan, K., Johari, G. P. 1986. Dielectric relaxations in the liquid and glassy states of glucose and its water mixtures. *J. Phys. Chem.* 90: 6358–6362.
36. Chen, P., Chen, X. D., Free, K. W. 1996. Measurement and data interpretation of the freezing point depression of milks. *J. Food Eng.* 30: 239–253.
37. Chen, X. D., Chen, P. 1996. Freezing of aqueous solution in a simple apparatus designed for measuring freezing point. *Food Res. Int.* 29(8): 723–729.
38. Chinachoti, P., Stengle, T. R. 1990. Water mobility in starch/sucrose systems: an oxygen-17 NMR. *J. Food Sci.* 55(6): 1732–1734.
39. Chirife, J. 1994. Specific solute effects with special reference to *Staphylococcus aureus*. *J. Food Eng.* 22: 409–419.
40. Chirife, J., Buera, M. D. P. 1994. Water activity, glass transition and microbial stability in concentrated/semimoist food systems. *J. of Food Sci.* 59(5): 921–927.
41. Chirife, J., Buera, M. P., Gonzalez, H. L. 1999. The mobility and mold growth in glassy/rubbery substances. In: *Water Management in the Design and Distribution of Quality Foods*. ISOPOW 7. Roos, Y. H., Leslie, R. B., Lillford, P. J. Eds. Technomic, Lancaster. pp. 285–298.

42. Choi, S., Kerr, W. L. 2003. <sup>1</sup>H NMR studies of molecular mobility in wheat starch. *Food Res. Int.* 36: 341–348.
43. Christensen, R. M. A. 1977. A thermodynamical criterion for the glass-transition temperature. *Trans. Soc. Rheol.* 21: 163–181.
44. Cnossen, A. G., Siebenmorgen, T. J., Yang, W., Bautista, R. C. 2000. An application of glass transition temperature to explain rice kernel fissure occurrence during the drying process. *Drying Technol.* 19(8): 1661–1682.
45. Cnossen, A. G., Siebenmorgen, T. J. 2000. The glass transition temperature concept in rice drying and tempering: effect on milling quality. *Trans. ASAE.* 43(6): 1661–1667.
46. Contreras-Lopez, E., Champion, D., Hervet, H., Blond, G., Le Meste, M. 1999. Effet de differents polysaccharides sur la mobilite rotationnelle et translationelle de petites molecules dans des solutions concentrees de saccharose. In: *Les Produits Alimentaires et l'Eau*. Agoral-99, Paris. pp. 253–258.
47. Del Valle, J. M., Cuadros, T. R. M., Aguilera, J. M. 1998. Glass transitions and shrinkage during drying and storage of osmosed apple pieces. *Food Res. Int.* 31(3): 191–204.
48. Dlubek, G., Fretwell, H. M., Alam, M. A. 2000. Positron/positronium annihilation as a probe for the chemical environment of free volume holes in polymers. *Macromolecules.* 33: 187–192.
49. Drapon, R. 1972. Reactions enzymatiques en Milieu Peu Hydrate. *Annal. Technol. Agric.* 21: 487–499.
50. Duckworth, R. B., Smith, G. M. 1963. The environment for chemical change in dried and frozen foods. *Proc. Nutr. Soc.* 22: 182–189.
51. Fennema, O. 1975. Activity of enzymes in partially frozen aqueous systems. In: *Food Sci. Technol. A Series of Monograph*. Duckworth, R. B. Ed. Academic Press, London. pp. 397–412.
52. Fennema, O. 1978. Enzyme kinetics at low temperature and reduced water activity. In: *Dry Biological Systems*. Crowe, J. H., Clegg, J. S. Eds. Academic Press, London. pp. 297–342.
53. Fennema, O. 1995. Metastable and nonequilibrium states in frozen food and their stabilization In: *Food Preservation by Moisture Control: Fundamentals and Applications*. Barbosa-Canovas, G. V., Welti-Chanes J. Eds. Technomic Publishing, Lancaster, PA. pp. 243.
54. Ferry, J. D. 1980. *Viscoelastic Properties of Polymers*. Wiley, New York.
55. Ferry, J. D. 1991. Some reflections on the early development of polymer dynamics: viscoelasticity, dielectric dispersion, and self-diffusion. *Macromolecules.* 24: 5237–5245.
56. Fessas, D., Schiraldi, A. 2001. State diagram of arabinoxylan-water binaries. *Termochim. Acta.* 370: 83–89.
57. Fonseca, F., Obert, J. P., Beal, C., Marin, M. 2001. State diagrams and sorption isotherms of bacterial suspensions and fermented medium. *Termochim. Acta.* 366: 167–182.
58. Franks, F. 1985. Complex aqueous systems at subzero temperatures. In: *Properties of Water in Foods*. Simatos, D., Multon, J.L. Eds. Martinus Nijhoff Publishers, Dordrecht.
59. Franks, F. 1991. Water activity: a credible measure of food safety and quality? *Trends Food Sci. Technol.* 2(3): 68–72.
60. Franks, F., Hatley, R. H. M. 1992. Stable enzymes by water removal. In: *Stability and Stabilization of Enzymes*. Van Den Tweel, W. J. J., Harde, R. A., Buitelaar, R. M. Eds. Elsevier Science, Amsterdam. pp. 45–54.
61. Gidley, M. J., Cooke, D., Ward-Smith, S. 1993. Low moisture polysaccharide systems: thermal and spectroscopic aspects. In: *Glassy State of Foods*. Blanshard, J. M. V., Lillford, P. J. Eds. Nottingham University Press, Nottingham. pp. 303–316.
62. Given, P. S. 1991. Molecular behavior of water in a flour-water baked model system. In: *Water Relationships in Food*. Levine, H., Slade, L. Eds. Plenum Press, New York. pp. 465–483.
63. Goff, H., Caldwell, K. B., Stanley, D. W., Maurice, T. P. 1993. The influence of polysaccharides on the glass transition in frozen sucrose solutions and ice cream. *J. Dairy Sci.* 76: 1268–1277.
64. Goff, H. D., Montoya, K., Sahagian, M. E. 2002. The effect of microstructure on the complex glass transition occurring in frozen sucrose model systems and foods. In: *Amorphous Food and Pharmaceutical Systems*. Levine, H. Ed. The Royal Society of Chemistry, Cambridge. pp. 145–157.
65. Hardman, T. M. 1986. Interaction of water with food component. In: *Interaction of Food Components*. Birch, G. G., Lindley, M. G. Eds. Elsevier Applied Science Publishers, London. pp. 19–30.
66. Hatakeyama, T., Quinn, F. X., Hatakeyama, H. 1996. Changes in freezing bound water in water-gellan systems with structure formation. *Carbohydr. Polym.* 30: 155–160.
67. Hills, B. P., Manning, C. E., Ridge, Y., Brocklehurst, T. 1996. NMR water relaxation, water activity and bacterial survival in porous media. *J. Sci. Food Agric.* 71: 185–194.
68. Hutchinson, J. M. 1995. Physical aging of polymers. *Prog. Polym. Sci.* 20: 703–760.

69. Izzard, M. J., Ablett, S., Lillford, P. J. 1991. Calorimetric study of the glass transition occurring in sucrose solutions. In: *Food Polymers, Gels, Colloids*. Dickinson, E. Ed. The Royal Society of Chemistry, London. pp. 289–300.
70. Johari, G. P. 1976. Glass transition and secondary relaxations in molecular liquids and crystals. *Ann. NY Acad. Sci.* 2: 177–140.
71. Jouppila, K., Roos, Y. H. 1997. The physical state of amorphous cornstarch and its impact on crystallization. *Carbohydr. Polym.* 32: 95–104.
72. Kaatze, U. 1990. On the existence of bound water in biological systems as probed by dielectric spectroscopy. *Phy. Med. Biol.* 35(12): 1663–1681.
73. Kalichevsky, M. T., Blanshard, J. M. V. 1992. A study of effect of water on the glass transition of 1:1 mixtures of amylopectin, casein and gluten using DSC and DMTA. *Carbohydr. Polym.* 19: 271–278.
74. Kantor, Z., Pitsi, G., Thoen, J. 1999. Glass transition temperature of honey as a function of water content as determined by differential scanning calorimetry. *J. Agric. Food Chem.* 47: 2327–2330.
75. Karathanos, V., Angelea, S., Karel, M. 1993. Collapse of structure during drying of celery. *Drying Technol.* 11: 1005.
76. Karathanos, V. T., Kanellopoulos, N. K., Belessiotis, V. G. 1996. Development of porous structure during air drying of agricultural plant products. *J. Food Eng.* 29: 167–183.
77. Karel, M., Angelea, S., Buera, P., Karmas, R., Levi, G., Roos, Y. 1994. Stability-related transitions of amorphous foods. *Thermochim. Acta.* 246: 249–269.
78. Karel, M., Buera, M. P., Roos, Y. 1993. Effects of glass transitions on processing and storage. In: *The Science and Technology of the Glassy State in Foods*. Blanshard, J. M. V., Lillford, P. J. Eds. Nottingham University Press, Nottingham.
79. Karel, M., Saguy, I. 1991. Effects of water on diffusion in food systems. In: *Water Relationships in Foods*. Levine, H., Slade, L. Eds. Plenum Press, New York. p. 157.
80. Karmas, R., Buera, M. P., Karel, M. 1992. Effect of glass transition on rates of nonenzymatic browning in food systems. *J. Agric. Food Chem.* 40: 873.
81. Kasapis, S. 2005. Glass transition phenomena in dehydrated model systems and foods: a review. *Drying Technol.* 23(4): 731–758.
82. Kasapis, S., Al-Marhoobi, I. M., Mitchell, J. R. 2003. Testing the validity of comparisons between the rheological and the calorimetric glass transition temperatures. *Carbohydr. Res.* 338: 787–794.
83. Kasapis, S., Al-Marhobi, I. M. A., Sworn, G. 2001.  $\alpha$  and  $\beta$  mechanical dispersions in high sugar/acyl gellan mixtures. *Int. J. Biol. Macromol.* 29: 151–160.
84. Kasapis, S., Rahman, M. S., Guizani, N., Al-Aamri, M. K. S. 2000. State diagram of temperature vs. date solids obtained from the mature fruit. *J. Agric. Food Chem.* 48: 3779–3784.
85. Kim, M. N., Saltmarch, M., Labuza, T. P. 1981. Nonenzymatic browning of hygroscopic whey powders in open versus sealed pouches. *J. Food Process Preserv.* 5: 49–57.
86. Kivilaan, A., Bandurski, R. S. 1981. The one-hundred-year period for Dr. Beal's seed viability experiment. *Am. J. Bot.* 68: 1290–1292.
87. Kokini, J. L., Cocero, A. M., Madeka, H., De Graaf, E. 1994. The development of state diagrams for cereal proteins. *Trends Food Sci. Technol.* 5: 281–288.
88. Kramkowski, R., Kaminski, E., Serowik, M. 2001. Characterisation of garlic freeze drying with the use of differential scanning calorimetry. *Electron. J. Polish Agric. Univ.* 4(2): 1–6.
89. Krokida, M. K., Karathanos, V. T., Maroulis, Z. B. 1998. Effect of freeze-drying conditions on shrinkage and porosity of dehydrated agricultural products. *J. Food Eng.* 35: 369–380.
90. Krokida, M., Maroulis, Z. 2000. Quality changes during drying of food materials. In: *Drying Technology in Agricultural and Food Sciences*. Mujumdar, A. S. Ed. Science Publishers, Enfield. pp. 61–106.
91. Labrousse, S., Roos, Y., Karel, M. 1992. Collapse and crystallization in amorphous matrices with encapsulated compounds. *Sci. Aliments.* 12: 757.
92. Labuza, T. P., Hayman, C. R. 1998. Moisture migration and control in multi-domain foods. *Trends Food Sci. Technol.* 9: 47–55.
93. Lai, H. M., Schmidt, S. J., Chiou, R. G., Slowinski, L. A., Day, G. A. 1993. Mobility of water in a starch-based fat replacer by  $^{17}\text{O}$  NMR spectroscopy. *J. Food Sci.* 58(5): 1103–1106.
94. Lang, K. W., Steinberg, M. P. 1983. Characterization of polymer and solute bound water by pulsed NMR. *J. Food Sci.* 48: 517–538.
95. Le Meste, M., Champion, D., Roudaut, G., Contreras-Lopez, E., Bond, G., Simatos, D. 1999. Mobility and reactivity in low moisture and frozen foods. In: *Water Management in Design and Distribution of*

- Quality Foods*. ISOPOW Roos, Y. H., Leslie, R. B., Lillford, P. J. Eds. Technomic Publisher, Lancaster. pp. 267–284.
96. Le Meste, M., Roudaut, G., Rolee, A. 1997. The physical state and quality of cereal-based foods. In: *Food Engineering 2000*. Fito, P., Ortega-Rodriguez, E., Barbosa-Canovas, G. V. Eds. Chapman & Hall, New York. pp. 97–113.
  97. Levine, H., Slade, L. 1986. A polymer physico-chemical approach to the study of commercial starch hydrolysis products (SHPs). *Carbohydr. Polym.* 6: 213–244.
  98. Levine, H., Slade, L. 1989. Interpreting the behavior of low moisture foods. In: *Water and Food Quality*. Hardman, T. M. Ed. Elsevier Applied Science, New York. pp. 71–134.
  99. Li, S., Dickinson, L. C., Chinachoti, P. 1998. Mobility of “unfreezable” and “freezable” water in waxy cornstarch by  $^2\text{H}$  and  $^1\text{H}$  NMR. *J. Agric Food Chem.* 46: 62–71.
  100. Li, T. Y., Chen, J. T. 2001. Evaluation of rice starch-hydrocolloid compatibility at low-moisture content by glass transitions. *J. Food Sci.* 66(5): 698–704.
  101. Lloyd, R. J., Chen, X. D., Hargreaves, J. B. 1996. Glass transition and caking of spray-dried lactose. *Int. J. Food Sci. Technol.* 31: 305–311.
  102. Lupano, C. E. 1997. DSC study of honey granulation stored at various temperatures. *Food Res. Int.* 30(9): 683–688.
  103. Luyet, B., Rasmussen, D. 1968. Study by differential thermal analysis of the temperatures of instability of rapidly cooled solutions of glycerol, ethylene glycol, sucrose and glucose. *Biodynamica.* 10: 167–191.
  104. MacFarlane, D. R. 1986. Devitrification in glass forming aqueous solutions. *Cryobiology.* 23(3): 230–244.
  105. Martin, D. R., Ablett, S., Sutton, M., Sahagian, M. E. 1999. Diffusion of aqueous sugar solutions as affected by locust bean gum studied by NMR. *J. Food Sci.* 64: 46–49.
  106. Matveev, Y. I. 2004. Modification of the method for calculation of the  $C_g'$  and  $T_g'$  intersection point in the state diagrams of frozen solutions. *Food Hydrocolloids.* 18: 363–366.
  107. Mazzobre, M. F., Buera, M. P., Chirife, J. 1997. Protective role of trehalose on thermal stability of lactose in relation to its glass and crystal forming properties and effect of delaying crystallization. *Food Sci. Technol.* 30: 324–329.
  108. McFetridge, J., Rades, T., Lim, M. 2004. Influence of hydrogenated starch hydrolysates on the glass transition and crystallization of sugar alcohols. *Food Res. Int.* 37: 409–415.
  109. Moonan, W. K., Tschoegl, N. W. 1985. The effect of pressure on the mechanical properties of polymers. IV. Measurements in Torsion. *J. Polym. Sci.: Polymer Physics Edition.* 23: 623–651.
  110. Morales-Diaz, A., Kokini, J. L. 1998. Understanding phase transitions and chemical complexing reactions in 7S and 11S soy protein fractions. In: *Phase/State Transitions in Foods*. Rao, M. A., Hartel, R. W. Eds. Marcel Dekker, New York. pp. 273–311.
  111. Murray, D. G., Luft, L. R. 1973. Low-DE cornstarch hydrolysates. *Food Technol.* 27: 32.
  112. Ngai, K. L., Magill, J. H., Plazek, D. J. 2000. Flow, diffusion and crystallization of supercooled liquids: revisited. *J. Chem. Phys.* 112: 1887–1892.
  113. Nicholls, R. J., Appleqvist, I. A. M., Davies, A. P., Ingman, S. J., Lillford, P. J. 1995. Glass transitions and the fracture behavior of gluten and starches within the glassy state. *J. Cereal Sci.* 21: 25–36.
  114. O'Brien, J. 1996. Stability of trehalose, sucrose and glucose to nonenzymic browning in model systems. *J. Food Sci.* 61: 679–682.
  115. Paakkonen, K., Plit, L. 1991. Equilibrium water content and the state of water in dehydrated white cabbage. *J. Food Sci.* 56(6): 1597–1599.
  116. Paakkonen, K., Plit, L. 1991. The state of water and chitin in the northern milk cup mushroom (*Lactarius trivialis*). *Food Sci. Technol.* 24(3): 204–207.
  117. Padua, G. W. 1993. Proton NMR and dielectric measurements on sucrose filled agar gels and starch pastes. *J. Food Sci.* 58(3): 603–626.
  118. Padua, G. W., Richardson, S. J., Steinberg, M. P. 1991. Water associated with whey protein investigated by pulsed NMR. *J. Food Sci.* 56(6): 1557–1561.
  119. Parker, R., Ring, S. G. 1995. Diffusion in maltose-water mixtures at temperatures close to the glass transition. *Carbohydr. Res.* 273: 147–155.
  120. Parker, R., Smith, A. C. 1993. The mechanical properties of starchy food materials at large strains and their ductile-brittle transitions. In: *The Glassy States in Foods*. Blanshard, J. M. V., Lillford, P. J. Eds. Nottingham University Press, Leicestershire. pp. 519–522.

121. Perdon, A. A. 1999. Amorphous state transition in rice during the drying process. Ph.D. dissertation, University of Arkansas, Fayetteville, AR.
122. Perdon, A. A., Siebenmorgen, T. J., Mauromoustakos, A. 2000. Glassy state transition and rice drying: development of a brown rice state diagram. *Cereal Chem.* 77(6): 708–713.
123. Pere, C., Rodier, E., Schwartzentruber, J. 1998. Effects of the structure of a porous material on drying kinetics in a microwave vacuum laboratory scale dryer. *IDS '98. 11th International Drying Symposium.* pp. 1922–1929.
124. Phillips, G. O., Takigami, S., Takigami, M. 1996. Hydration characteristics of the gum exudate from *Acacia senegal*. *Food Hydrocolloids.* 10(1): 11–19.
125. Priestley, D. A., Cullinan, V. I., Wolf, J. 1985. Differences in seed longevity at the species level. *Plant Cell Environ.* 8(8): 557–562.
126. Rahman, M. S. 1995. *Food Properties Handbook*. CRC Press, Boca Raton, FL.
127. Rahman, M. S., 1999, Glass transition and other structural changes in foods, In: *Handbook of Food Preservation*, Rahman, M. S., Ed. Marcel Dekker, New York. pp. 75–93.
128. Rahman, M. S. 2001. Toward prediction of porosity in foods during drying: a brief review. *Drying Technol.* 19(1): 1–13.
129. Rahman, M. S. 2004. State diagram of date flesh using differential scanning calorimetry (DSC). *Int. J. Food Prop.* 7(3): 407–428.
130. Rahman, M. S. 2005. Dried-food properties: challenges ahead. *Drying Technol.* 23(4): 695–715.
131. Rahman, M. S. 2006. State diagram of foods: its potential use in food processing and product stability. *Trends Food Sci. Technol.* 17: 129–141.
132. Rahman, M. S., Al-Amri, O. S., Al-Bulushi, I. M. 2002. Pores and physico-chemical characteristics of dried tuna produced by different methods of drying. *J. Food Eng.* 53: 301–313.
133. Rahman, M. S., Al-Zakwani, I., Guizani, N. 2005. Pore formation in apple during air drying as a function of temperature and pore size distribution. *J. Sci. Food Agric.* 85(6): 979–989.
134. Rahman, M. S., Guizani, N., Al-Khaseibi, M., Al-Hinai, S., Al-Maskri, S. S., Al-Hamhami, K. 2002. Analysis of cooling curve to determine the end point of freezing. *Food Hydrocolloids.* 16(6): 653–659.
135. Rahman, M. S., Kasapis, S., Guizani, N., Al-Amri, O. 2003. State diagram of tuna meat: freezing curve and glass transition. *J. Food Eng.* 57(4): 321–326.
136. Rahman, M. S., Labuza, T. P. 1999. Water activity and food preservation. In: *Handbook of Food Preservation*. Rahman, M. S. Ed. Marcel Dekker, New York. pp. 339–382.
137. Rahman, M. S., Sablani, S. S., Al-Habsi, N., Al-Maskri, S., Al-Belushi, R. 2005. State diagram of freeze-dried garlic powder by differential scanning calorimetry and cooling curve methods. *J. Food Sci.* 70(2): E135–E141.
138. Ratti, C. 1994. Shrinkage during drying of foodstuffs. *J. Food Eng.* 23: 91–105.
139. Rey, L. R. 1958. Etude Physiologique et Physico-chimique de l'Action des Basses Temperatures sur Tissus Animaux Vivants. Ph.D. thesis, 122 p.
140. Richardson, S. J., Baianu, I. C., Steinberg, M. P. 1987. Mobility of water in sucrose solutions determined by deuterium and oxygen-17 nuclear magnetic resonance measurements. *J. Food Sci.* 52(3): 806–812.
141. Richter, M., Schierbaum, F., Augustat, S., Knoch, K. D. 1976. U.S. Patent 3,3962,454, 8 June.
142. Richter, M., Schierbaum, F., Augustat, S., Knoch, K. D. 1976. U.S. Patent 3,986,890, 19 October.
143. Rockland, L. B. 1969. Water activity and storage stability. *Food Technol.* 23: 11–21.
144. Ronald, C. M., Santangelo, P. G., Ngai, K. L. 1999. The application of the energy landscape model to polymers. *J. Chem. Phys.* 111: 5593–5598.
145. Roos, Y. 1995. Characterization of food polymers using state diagrams. *J. Food Eng.* 24: 339–360.
146. Roos, Y. 1995. Water activity and glass transition temperature: how do they complement and how do they differ? In: *Food Preservation by Moisture Control. Fundamentals and Applications*. Barbosa-Canovas, G.V., Welti-Chanes, J. Eds. Technomic Publishing Company, PA, pp. 133–154.
147. Roos, Y. H. 1987. Effect of moisture on the thermal behavior of strawberries studied using differential scanning calorimetry. *J. Food Sci.* 52(1): 146–149.
148. Roos, Y. H., Himberg, M. J. 1994. Nonenzymatic browning behavior, as related to glass transition of food model at chilling temperature. *J. Agric. Food Chem.* 42: 893–898.
149. Roos, Y., Karel, M. 1991. Water and molecular weight effects on glass transitions in amorphous carbohydrates and carbohydrate solutions. *J. Food Sci.* 56(6): 1676–1681.



150. Roos, Y., Karel, M. 1991. Applying state diagrams in food processing and product development. *Food Technol.* 45(12): 66–71, 107.
151. Roos, Y., Karel, M. 1991. Nonequilibrium ice formation in carbohydrate solutions. *Cryo-Letter.* 12: 367–376.
152. Roos, Y., Karel, M. 1991. Amorphous state and delayed ice formation in sucrose solutions. *Int. J. Food Sci. Technol.* 26: 553–566.
153. Roos, Y., Karel, M. 1991. Plasticizing effect of water on thermal behavior and crystallization of amorphous food models. *J. Food Sci.* 56: 38–43.
154. Roos, Y., Karel, M. 1992. Crystallization of amorphous lactose. *J. Food Sci.* 57: 775–777.
155. Roudaut, G., Dacremont, C., Le Meste, M. 1998. Influence of water on the crispness of cereal based foods—acoustic, mechanical, and sensory studies. *J. Texture Stud.* 29: 199–213.
156. Roudaut, G., Maglione, M., Le Meste, M. 1999. Sub-T<sub>g</sub> relaxations in cereal-based systems. *Cereal Chem.* 76: 78–81.
157. Sa, M. M., Figueiredo, A. M., Sereno, A. M. 1999. Glass transitions and state diagrams of fresh and processed apple. *Thermochim. Acta.* 329: 31–38.
158. Sa, M. M., Sereno, A. M. 1994. Glass transitions and state diagrams for typical natural fruits and vegetables. *Thermochim. Acta.* 246: 285–297.
159. Sablani, S. S., Rahman, M. S. 2002. Pore formation in selected foods as a function of shelf temperature during freeze drying. *Drying Technol.* 20(7): 1379–1391.
160. Saltmarch, M., Vagnini-Ferrari, M., Labuza, T. P. 1981. Theoretical basis and application of kinetics to browning in spray-dried whey food systems. *Prog. Food Nutr. Sci.* 5: 331–344.
161. Sapru, V., Labuza, T. P. 1993. Glass state in bacterial spores predicted by polymer glass-transition theory. *J. Food Sci.* 58: 445–448.
162. Schebor, C., Buera, M. D. P., Chirife, J., Karel, M. 1995. Sucrose hydrolysis in glassy starch matrix. *Food Sci. Technol.* 28: 245–248.
163. Schebor, C., Buera, M. P., Chirife, J. 1996. Glassy state in relation to the thermal inactivation of enzyme invertase in amorphous dried matrices of trehalose, maltodextrin and PVP. *J. Food Eng.* 30(3–4): 269–282.
164. Scott, W. J. 1953. Water relations of *Staphylococcus aureus* at 30°C. *Aust. J. Biol. Sci.* 6: 549.
165. Sereno, A. M., Sa, M. M., Figueiredo, A. M. 1995. Low temperature phase transitions in natural and osmotic dehydrated fruits. In: *Osmotic Dehydration of Fruits and Vegetables*. Lenart, A., Lewicki, P. P. Eds. Warsaw Agricultural University Press, Warsaw. pp. 50–68.
166. Sereno, A. M., Sa, M. M., Figueiredo, A. M. 1998. Glass transitions and state diagrams for freeze-dried and osmotically dehydrated apple. *Proceedings of the 11<sup>th</sup> International Drying Symposium (IDS '98)*, Halkidiki, Greece, August 19–22.
167. Shalaev, E. Y., Kanev, A. N. 1994. Study of the solid–liquid state diagram of the water-glycine-sucrose system. *Cryobiology.* 31: 374–382.
168. Shen-Miller, J., Mudgett, M. B., Schopf, J. W., Clarke, S., Berger, R. 1995. Exceptional seed longevity and robust growth: ancient sacred lotus from China. *Am. J. Bot.* 82: 1367–1380.
169. Shimada, Y., Roos, Y., Karel, M. 1991. Oxidation of methyl linoleate encapsulated in amorphous lactose-based food models. *J. Agric. Food Chem.* 39: 637–641.
170. Siebenmorgan, T. J., Yang, W., Howell, T. A., Meullenet, J. F., Wang, Y. J., Cnossen, A. G. 2000. Fissure formation in rice kernels during the drying process: a glass transition perspective. *Proc. of the 2000 Rice Technical Working Group Conference*, Biloxi, MS.
171. Silver, M., Karel, M. 1981. The behavior of invertase in model systems at low moisture content. *Food Chem.* 5: 283–311.
172. Simatos, D., Blond, G. 1991. DSC studies and stability of frozen foods. In: *Water Relationships in Foods*. Levine, H., Slade, L. Eds. Plenum Press, New York. pp. 139–156.
173. Simatos, D., Blond, G. 1993. Some aspects of the glass transition in frozen food systems. In: *The Glassy State in Food*. Blanshard, J. M. V., Lillford, P. J. Eds. Nottingham University Press, Nottingham. pp. 395–415.
174. Simatos, D., Blond, G., Perez, J. 1996. Basic physical aspects of glass transition. In: *Food Preservation by Moisture Control Fundamentals and Applications*. Barbosa-Canovas, G. V., Welti-Chanes, J. Eds. Technomic Publishing, Lancaster. pp. 3–31.
175. Simatos, D., Blond, G., Roudaut, G., Champion, D., Perez, J., Faivre, A. L. 1996. Influence of heating and cooling rates on the glass transition temperature and the fragility parameter of sorbitol and fructose as measured by DSC. *J. Thermal Anal.* 47: 1419–1436.

176. Slade, L., Levine, H. 1987. Structural stability of intermediate moisture foods—a new understanding. In: *Food Structure—Its Creation and Evaluation*. Mitchell, J. R., Blanshard, J. M. V. Eds. Butterworths, London. pp. 115.
177. Slade, L., Levine, H. 1988. Nonequilibrium behavior of small carbohydrate-water systems. *Pure Appl. Chem.* 60: 1841–1864.
178. Slade, L., Levine, L. 1991. A food polymer science approach to structure property relationships in aqueous food systems: nonequilibrium behavior of carbohydrate-water systems. In: *Water Relationships in Food*. Levine, H., Slade, L., Eds. Plenum Press, New York.
179. Slade, L., Levine, L. 1991. Beyond water activity: recent advances based on an alternative approach to the assessment of food quality and safety. *Crit. Rev. Food Sci. Technol.* 30: 115.
180. Soesanto, T., Williams, M. C. 1981. Volumetric interpretation of viscosity for concentrated and dilute sugar solutions. *J. Phys. Chem.* 85: 3338.
181. Steiner, A. M., Ruckenbauer, P. 1995. Germination of 110-year-old cereal and weed seeds, the Vienna sample of 1877. Verification of effective ultra-dry storage at ambient temperature. *Seed Sci. Res.* 5: 195–199.
182. Taylor, J. R. 1995. Glass-state molecular mobility. *Food Ind. South Africa.* 48: 29–31.
183. Torregiani, D., Forni, E., Guercilena, I., Maestrelli, A., Bertolo, G., Archer, G. P., Kennedy, C. J., Bone, S., Blond, G., Contreras-Lopez, E., Champion, D. 1999. Modification of glass transition temperature through carbohydrates additions: effect upon colour and anthocyanin pigment stability in frozen strawberry juices. *Food Res. Int.* 32: 441–446.
184. Van den Berg, C. 1991. Food–water relations: progress and integration, comments and thoughts. In: *Water Relations in Foods*. Levine, H., Slade, L. Eds. Plenum Press, New York. pp. 21.
185. Verdonck, E., Schaap, K., Thomas, L. C. 1999. A discussion of the principles and applications of modulated temperature DSC (MTDSC). *Int. J. Pharmaceutics.* 192: 3–20.
186. Wang, N., Brennan, J. G. 1995. Changes in structure, density and porosity of potato during dehydration. *J. Food Eng.* 24: 61–76.
187. Watanabe, H., Tang, C. Q., Suzuki, T., Mihori, T. 1996. Fracture stress of fish meat and the glass transition. *J. Food Eng.* 29: 317–327.
188. White, G. W., Cakebread, S. H. 1966. The glassy state in certain sugar-containing food products. *J. Food Technol.* 1: 73–82.
189. Williams, M. L., Landel, R. F., Ferry, J. D. 1955. The temperature dependence of relaxation mechanisms in amorphous polymers and other glass-forming liquids. *J. Amer. Chem. Soc.* 77: 3701–3707.
190. Yang, W., Jia, C. C., Howell, T. A. 2003. Relationship of moisture content gradients and glass transition temperatures to head rice yield during cross-flow drying. *Biosys. Eng.* 86(2): 199–206.
191. Yang, W., Jia, C. C., Siebenmorgen, T. J., Pan, Z., Cnossen, A. G. 2003. Relationship of kernel moisture content gradients and glass transition temperatures to head rice yield. *Biosys. Eng.* 85(4): 467–476.
192. Zhao, J., Notis, M. R. 1993. Phase transition kinetics and the assessment of equilibrium and metastable states. *J. Phase Equil.* 14: 303.



# 16

## *Food Preservation and Processing Using Membranes*

Shyam S. Sablani

### CONTENTS

16.1	Introduction .....	365
16.2	Principles of Membrane Separation .....	366
16.3	Membrane Modules.....	367
16.4	Performance of Membrane Separation Systems .....	368
16.5	Applications in the Food Industry.....	370
16.5.1	Fruit Juices .....	371
16.5.1.1	Clarification .....	371
16.5.1.2	Membrane Selection .....	372
16.5.1.3	Concentration .....	372
16.5.2	Dairy.....	374
16.5.2.1	Quality of Ultrafiltered Milk .....	374
16.5.2.2	Microbiology of Ultrafiltered Milk .....	375
16.5.2.3	Cheese and Other Dairy Foods .....	375
16.5.3	Oils and Fats .....	376
16.5.3.1	Solvent Recovery .....	376
16.5.3.2	Degumming.....	376
16.5.3.3	Lipid Separations .....	377
16.5.3.4	Dewaxing .....	378
16.5.3.5	Removal of Contaminants.....	378
16.5.3.6	Removal of Pigments .....	378
16.5.3.7	Membrane Bioreactors .....	378
16.5.4	Potential Applications of Membrane Processes.....	378
16.5.4.1	Wine .....	379
16.5.4.2	Pervaporation .....	379
16.6	Concentration Polarization and Fouling .....	380
16.7	Cleaning Membranes.....	380
	References .....	381

### 16.1 Introduction

Separation processes based on membrane utilize semipermeable membranes of the appropriate physical and chemical nature to separate molecules primarily on the basis of size, and, to a lesser extent, on shape and chemical composition [1]. In these processes, the membrane acts as a selective barrier, enriching certain components in a feed stream, and depleting it of others. Reid and Breton [2], who used cellulose acetate (CA) membranes for desalination of water, made the first real breakthrough. Shortly thereafter, Loeb and Sourirajan [3,4] developed the casting procedure for asymmetric CA membranes. The most attractive feature of the process is its simplicity. It involves only bulk movement of fluids using mechanical energy (i.e., pumping). Membrane concentration processes have several advantages over conventional

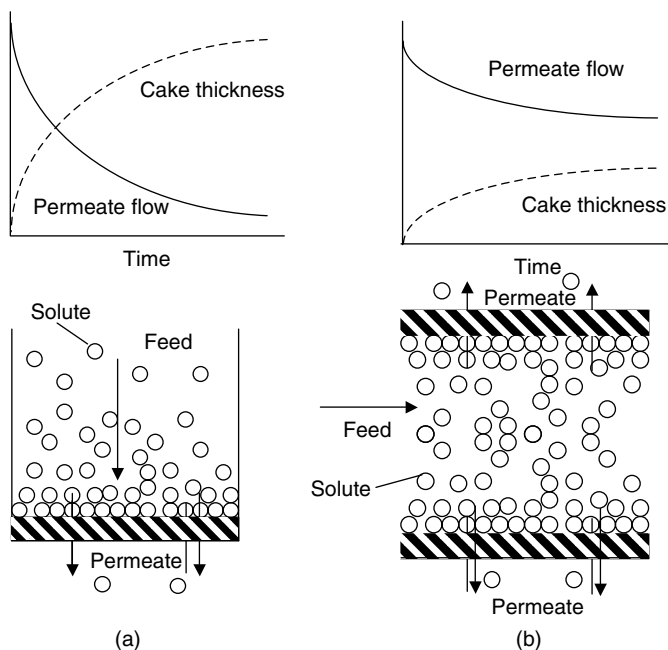
concentration processes, i.e., evaporation. Undesirable heat-related changes such as color, aroma, and viscosity characteristics are avoided because membrane processes can be operated at room temperature. Unlike evaporation or freeze concentration, membrane separation does not involve a phase change for separation, thereby energy is used more efficiently.

Membrane processing in food industry has been applied mainly for clarification of fruit juices using microfiltration and ultrafiltration, and for concentration of fruit juices and dairy products. Clarified fruit juices may have better quality and stability, while concentrated beverages are desirable for transport and storage. Filtration rate and product quality are influenced by pretreatment of product, selection of membrane system, and operating parameters. This chapter presents principles of membrane separation processes, membrane materials and modules, performance measurement of membrane system, and application of membranes for selected food groups.

## 16.2 Principles of Membrane Separation

Membrane processes include a wide range of unit operations from sieving to reverse osmosis (RO). Filtration of coarse particles, i.e., in the micron range, is carried out by conventional dead-end filtration where particles are retained by the filter that later form a cake layer resulting in increased resistance to filtration. This requires frequent cleaning and replacement of filters. The most common membrane configuration used in the industrial setup is cross-flow membrane filtration. It is continuous type and used to separate particles, which are about 10  $\mu\text{m}$  to solute molecules that are a few Angstroms [5]. In cross-flow membrane separation, the bulk phase is forced to flow along the membrane surface using external pressure. The permeate (less particle concentration) is collected on the low-pressure side of the membrane, while on the high-pressure side the concentrate sweeps the retained particles so that the cake layer remains relatively thin and the resistance to filtration remains low (Figure 16.1). Flow of the liquid through the membrane is driven by hydraulic pressure gradient, while flow of the solute through the membrane is diffusion driven and by concentration gradient [5].

The membrane filtration is divided into four narrower ranges based on particle size: microfiltration, ultrafiltration, nanofiltration, and RO (Table 16.1). The size of particles retained in these processes ranges from 0.1 to 10  $\mu\text{m}$  (microfiltration), 1000–500,000 molecular weight cut-off (ultrafiltration), and



**FIGURE 16.1** Dead-end and cross-flow filtration. (a) Dead-end filtration. (b) Gas-flow filtration. (Adapted from Mannapperuma, J. D., In *Handbook of Food Engineering Practice*, CRC Press, Boca Raton, FL, 1997.)

**TABLE 16.1**

Membrane Filtration Range

Filtration Spectrum	Diameter of Pores in Membrane ( $\mu\text{m}$ )	Molecular Weight (of Solute)	Filtrate
Microfiltration	0.05–5.0	>1,000,000	Latex, blood, paint pigment, indigo dye, yeast, bacteria, plant gums, amylopectin
Ultrafiltration	0.005–0.1	4000–10,000	Colloidal silica, virus, enzymes, protein, gelatin, amylose
Nanofiltration	0.0005–0.01	100–5000	Synthetic dye, antibiotics, colorant, amino acids, sugars
Reverse osmosis	0.0001–0.001	<800	Atoms, metal ions, fragrance, flavors, salts

Source: Adapted from Mannapperuma, J. D., In *Handbook of Food Engineering Practice*, CRC Press, Boca Raton, FL (1997).

100–1000 molecular weight cutoff (nanofiltration). The RO membranes can retain the smallest solute molecules such as sodium chloride and are classified by percentage rejection of sodium chloride in an aqueous solution under specified conditions and range from 95% to 99.5%. The operating pressure ranges are 10–50 psi (microfiltration), 20–200 psi (ultrafiltration), 100–500 psi (nanofiltration), and 200–1500 psi (RO). The mechanisms of membrane transport proposed are sieve mechanism, hydrogen-bonding mechanisms, solution-diffusion mechanism, and preferential sorption–capillary flow mechanism [1].

### 16.3 Membrane Modules

A wide variety of materials are used for manufacturing of membranes, including sintered metals, ceramics, and polymers (Table 16.2). The membrane structure varies in its chemical nature, microcrystalline structure, pore size and pore size distribution, and degree of asymmetry. Two simple parameters—membrane permeate flux and solute rejection—are used to describe the characteristics of membranes. Since the properties of membrane material can be influenced by environmental conditions and time, secondary properties such as resistance to compaction, temperature and chemical stability, and resistance to microbial attack are also important. Additional requirements for food processing are good tolerance of cleaning and disinfecting solutions, and lack of toxicity of the contact materials [1].

Membranes are assembled as modules that are easily integrated into systems containing hydraulic components. The modules are designed to contain large membrane area in a small volume, withstand the pressures required during separation, and cross-flow velocities required to maintain a clean membrane surface [5]. The most common module configurations are flat plate, tubular, hollow fiber, and spiral wound (Figure 16.2). Each design has its own advantages and disadvantages.

In flat plate modules, two flat sheets are separated by a support plate that also contains the permeate channels. These membrane sandwiches are separated by a spacer that also has feed-flow channels. Alternate layers of membrane sandwiches and spacers are assembled and held together by bolts. Advantages of such system are (1) fairly low holdup and moderately high packing density, (2) easy membrane replacement, (3) flexibility with regard to membrane usage, (4) simplicity in the capacity, and (5) ability of module to withstand high pressures. The main disadvantages are susceptibility to fouling by suspended particles and high initial capital cost. Tubular modules consist of membrane casted inside a porous support tube, typically 6–25 mm in diameter. Several of such tubes are housed within one pressure vessel in a shell and tube arrangement. Advantages of tubular modules include (1) high turbulence, (2) ability to handle suspended particles of 1–1.5 mm, and (3) easy cleaning. The major disadvantages are low surface area to volume and high energy costs for pumping.

Hollow fiber modules consist of hollow fibers typically 0.5–3 mm in diameter sealed into plastic header and assembled in permeate castings. The feed passes through the central bore and the permeate collects in the outer casing. These can accommodate moderate levels of suspended particles and can withstand low

TABLE 16.2

Polymer, Ceramic, and Metallic Base Membranes and Their Filtration Range and Modules

Membrane Material	Filtration Range	Module
Polymers		
Cellulose acetate (CA)	NF, RO	FP, TU, HFF, SW
Polyamide (PA)	NF, RO	FP, TU, HFF, SW
Sulfonated polysulfone	UF, NF, RO	FP, TU, HFF, SW
Polysulfone	MF, UF	FP, TU, SW
Polyethersulfone	MF, UF	FP, SW
Polyvinylidene fluoride	MF, UF	FP, TU, HF, SW
Polytetrafluoroethylene	MF	FP, TU, SW
Polypropylene	MF	FP, HF
Polyacrylonitrile	MF, UF	FP, HF, SW
Polycarbonate	MF	
Polyester	MF	
Ceramics/metallic		
Alumina	MF	TU
Zirconia/alumina	MF, UF	TU
Zirconia/metal	MF	TU
Zirconia/carbon	MF	TU
Silica	MF	TU
Silicon carbide	MF	TU
Titanium oxide/metal	MF	TU
Sintered steel	MF	FP, TU
Sintered alloys	MF	FP, TU

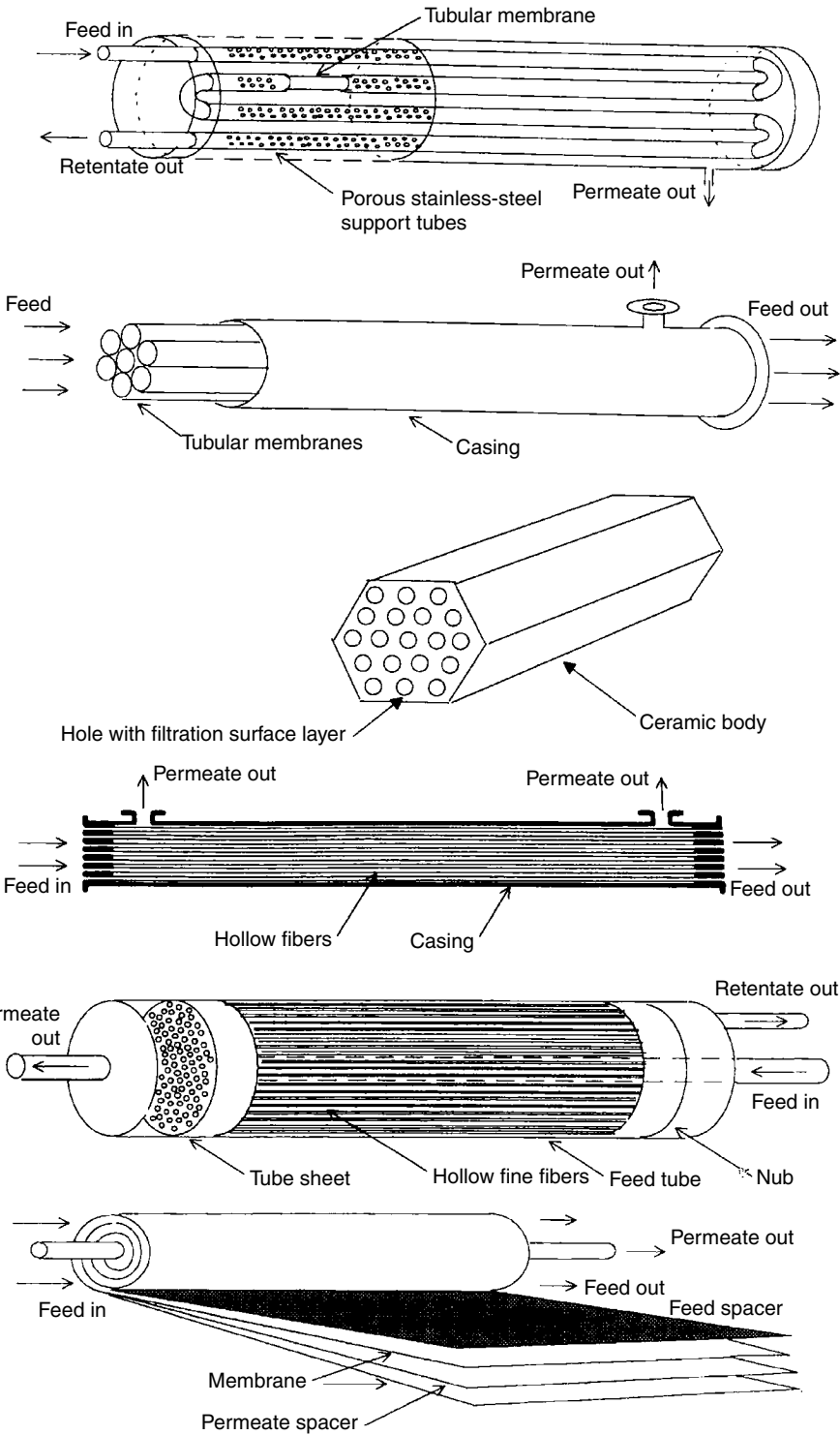
Note: MF, microfiltration; UF, ultrafiltration; NF, nanofiltration; RO, reverse osmosis; FP, flat plate; TU, tubular; HF, hollow fiber; HFF, hollow fine fiber; and SW, spiral wound.

Source: Adapted from Mannapperuma, J. D., In *Handbook of Food Engineering Practice*, CRC Press, Boca Raton, FL (1997).

pressures. Hollow fine fiber modules are made with a strand of fine fiber about 50–100  $\mu\text{m}$  in diameter. A bundle of fibers are formed into U shape, the ends are formed into a single header, and the U bundle is placed in a tube. The feed liquid is outside the fibers while the permeate flows into the fibers. Some advantages of this configuration are (1) compactness, very high packing density; (2) relatively low holdup; and (3) high resistance to compression, and hence can withstand high pressures. Some disadvantages are (1) extremely susceptible to fouling by suspended particles, (2) difficulty in operating in sanitary mode and in cleaning, and (3) individual membrane elements (i.e., fibers) cannot be replaced when damaged. Spiral wound modules utilize flat sheet membranes. Two membrane sheet are sandwiched with a permeate spacer between them and three edges are sealed. The fourth is connected to a central perforated tube. A feed channel spacer is placed on top of one layer, and the membrane-screen composite is rolled into a spiral configuration around the central collection tube. The module is placed inside the tubular pressure vessel. Feed flows longitudinally in the feed channel, while permeate flows between the membrane sandwich and spirally around to the permeate collection tube [1]. Advantages of such systems are (1) relatively high packing density, (2) low cost per unit membrane area, (3) easy replacement of modules from the pressure vessels, and (4) low energy consumption. The disadvantage is difficulty in cleaning when fouled with large amount of suspended matter and hence prefiltration is needed. The selection of module configuration and membrane material depends on the feed type and economics.

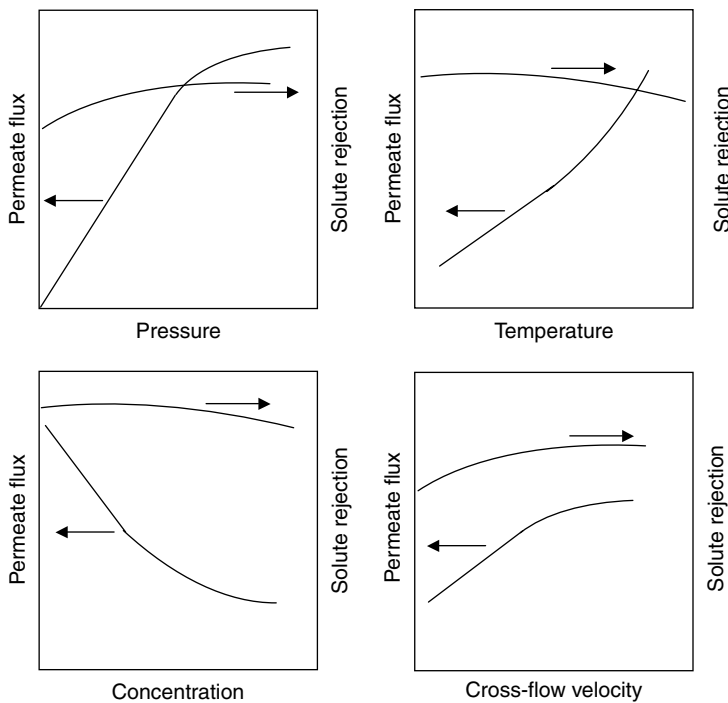
## 16.4 Performance of Membrane Separation Systems

The performance of membrane separation systems is calculated in terms of permeate flux and solute rejection. Permeate flux is defined as the volume of permeate produced in a unit time period through a



**FIGURE 16.2** Membrane modules. (Adapted from Mannapperuma, J. D., In *Handbook of Food Engineering Practice*, CRC Press, Boca Raton, FL, 1997.)





**FIGURE 16.3** Performance characteristics of reverse osmosis. (Adapted from Mannapperuma, J. D., In *Handbook of Food Engineering Practice*, CRC Press, Boca Raton, FL, 1997.)

unit area of membrane

$$\text{Permeate flux} = \frac{\text{Permeate volume}}{\text{Membrane area} \times \text{Time}}$$

It is measured as liter per square meter per hour. It indicates the ability of the module to produce volumes of filtrate in a given time. Solute rejection is defined as the solute retained by the membrane as a fraction of the solute in the original feed stream and is expressed as

$$\text{Solute rejection} = \left[ 1 - \frac{\text{Solute concentration in permeate}}{\text{Solute concentration in feed}} \right] 100$$

Solute rejection indicates the ability of membrane to produce a degree of purity of permeate with respect to the solute concentration. The major objective in the design and selection of membrane module for a given feed is to maximize permeate flux and solute rejection.

Permeate flux and solute rejection depends on operating conditions during the filtration process (Figure 16.3). Permeate flux increases with feed pressure, but the osmotic pressure at the membrane surface also increases due to concentration of polarization of solute. There is a moderate increase in solute rejection with the increase in feed pressure. The feed temperature increases the permeate flux due to decrease in viscosity of feed and change in membrane structure. The concentration of solute in the feed decreases the permeate flux due to increase in osmotic pressure. The solute rejection also decreases due to increase in solute concentration in the feed. The increasing cross-flow velocity of feed increases the permeate flux due to enhanced mass transfer coefficient, which increases with increase in cross-flow velocity. The solute rejection increases with increase in velocity and is moderate similar to its variation with pressure.

## 16.5 Applications in the Food Industry

In recent years, the application of membranes in food industry has increased tremendously. The application ranges from the use of microfiltration to RO membranes. In terms of products, it includes fruit juices, dairy, wine and brewery, fats, and oils.

## 16.5.1 Fruit Juices

### 16.5.1.1 Clarification

The main application of membrane technology to the fruit juice industry has been for clarification [6]. The UF and MF allow the combination of fining and filtration step to clarify fruit juices such as apple, pear, cranberry, grape, and citrus (Table 16.3). The main advantages of using membrane technology in fruit juice industry could be savings in enzymes; short processing time; no addition/removal of fining agents (diatomaceous earth, gelatin, bentonite) required; no problems with wastewater due to fining agents; no over- or underfining, which can result in haze formation; energy saving; no clouding of concentrate; simple cleaning-in-place, etc. Though juices produced by membrane filtration and traditional methods have mostly been shown to have similar properties, some differences have also been noted. Rao et al. [32] found that the retention of odor-active volatile in UF apple juice was intermediate to traditional plate and frame filtration and vacuum drum filtration. Plate and frame filtration gave the highest retention. Rwabahizi and Wrolstad [33] found that strawberry juice clarified through hollow fiber membrane had an average of 55% anthocyanin loss compared with 17% loss by conventional filtration. Drake and Nelson [34] reported that the UF apple juice had lower turbidity, 5% higher soluble solids, and less color than the traditionally clarified juice.

**TABLE 16.3**

Applications in Fruit Juice Clarification

Juice	Membrane Material and Module	MWCO (kDa)	Operating Parameters <sup>a</sup>	Flux (L/m <sup>2</sup> h)	Reference
Apple	Polysulfone, hollow fiber	10–500	25°C–35°C, 121 kPa	30–275	[7]
	Polysulfone, spiral wound	5	—	28.5	[8]
	Polysulfone, hollow fiber	50	—	—	—
	Ceramic, tubular	0.1 µm	—	111.9	—
	Ceramic, tubular	200 A	50°C, 414 kPa	390	[9]
	Apple treated with ascorbic acid	0.2 µm	200 A	190 280 280	—
Kiwi	Polysulfone, hollow fiber	10	20°C, 138 kPa	15.6	[11]
Lemon/ orange	Polysulfone, tubular	15–200	20°C–40°C, 50–400 kPa	10–60	[12,13]
	Polysulfone, hollow fiber	30	—	—	—
	Polysulfone, plate and frame	30	—	—	—
	Ceramic, tubular	25	—	—	—
Pear	Polysulfone, hollow fiber	10	50°C,	64	[10]
		30	157 kPa	68	
		50	—	70	
Tangerine	Polysulfone, plate and frame	25	25°C,	15	[14]
		50	93–194 kPa	34	
		100	—	45	
		0.1 µm	—	69	
		0.2 µm	—	41	

<sup>a</sup>Temperature and transmembrane pressure.

Pretreatments of fruit juices are important to obtain higher flux and better quality of clarified juice. Depectinization is needed to achieve high flux and concentration factors in membrane clarification processes. Polygalacturonase treatment has been found to decrease the size of granule particles in apple juice as well as to remove their web-like aspect [35]. Reduction in the size of particles and subsequent decrease in viscosity could improve flux. Depectinization is therefore needed to achieve high flux and concentration factors in membrane clarification processes [6]. Prefiltration and decantation reduce the particulate matter in juice, which improves flux and allows higher concentration to be achieved. Wucherpennig et al. [36] reported that the high-molecular-weight (>500 kDa) neutral polysaccharides in sloe juice and wine created difficulty in filtration. Citrus juices and tropical juices contain many hydrophobic compounds and clouds that result in lower fluxes.

### 16.5.1.2 Membrane Selection

The choice of membrane depends on the type of juice and the desired properties of the clarified juice (permeate). The factors that need to be considered while selecting a membrane include its configuration, material, and molecular weight cutoff. Tubular configurations are widely used for fruit juices [37]. They are recommended for clarification because their channels of larger diameters allow for the filtration of feed streams with high solids content and high yields can be obtained. In terms of power consumption per unit permeate of apple juice, Wu et al. [8] found that laboratory systems such as a tubular ceramic MF system (0.1  $\mu\text{m}$ ) and a spiral wound polysulfone (PS) UF (5 kDa) were comparable (1.15 W h/L). The total energy requirement for a commercial ultrafiltration process using a two-stage tubular system has been reported to be at approximately 5.3 W h/L for the production of clarified apple juice.

The choice of membrane material for a given juice is mainly determined on its pressure resistance, temperature resistance, pH resistance, and chemical compatibility. Many materials are suitable under the conditions needed for UF and MF clarification of juices: 1–10 bar, 20°C–55°C, and pH 2.5–4. The cleaning protocol for membranes, however, often decides the choice of membrane material. Other factors to be considered in material selection are its approval for food use, durability, availability, and cost. Polymeric membranes have a life of at least 1 year and ceramic membranes of at least 5–7 years under continuous use. However, ceramic membranes are more expensive [6]. Some studies have found that membrane material can have some influence on the UF and MF processing. Braddock [38] reported a decline in flux after contact with limonene. The PS membranes had the most severe decline followed by CA and Teflon. Rao et al. [32] found that apple juice permeate from polyamide (PA) membrane is more volatile than the PS membrane.

In general, the flux increases with pore size or molecular weight cutoff (MWCO) because the membrane permeability is proportional to the square of the pore radius. For a solute of a given size, retention decreases as pore size increases. Ideally, flux and retention of haze compound (to be separated) should be as high as possible. The flux need not always increase with pore size [9,13,14]. Membranes of larger pore size tend to be more susceptible to fouling, as the proportion of smaller particles and colloids in juice increases and can lead to pore blocking and plugging. Juice quality did not appear to be significantly affected by MWCO, although more colored compounds and haze precursors were retained with lower MWCO [6]. The UF and MF membranes have very low retention of low-molecular weight-compounds, such as minerals, acids, vitamins, and sugars. Larger components such as pulp, starch, and pectin show very high retention. Volatiles such as alcohols, aldehydes, and esters in fruits such as apple have low retentions in the retentate [32]. The retention of intermediate-weight compounds like enzymes depends on their molecular weights and the pore size of the membrane.

### 16.5.1.3 Concentration

Several studies have reported the use of membrane process such as RO for concentration of a variety of fruit juices such as orange, apple, tomato, pears, grapefruit, kiwi, and passion fruit (Table 16.4). The major constraint with RO is that high concentrations are difficult to obtain due to the high pressures reached by juice retentate. The most important components in fruit juices contributing to osmotic pressure are sugars (hexoses and disaccharides) and organic acids [15]. Table 16.5 lists some osmotic pressures for different juices. The maximum concentration of apple juice by conventional RO is limited to around 30°Bx–35°Bx, and the most efficient recovery was between 20°Bx and 25°Bx [19,42]. With current advances in

**TABLE 16.4**

Concentration of Fruit Juices by Reverse Osmosis

Juice	Membrane Material and Module	Operating Parameters	Flux (L/m <sup>2</sup> h)	Reference
Orange	Cellulose acetate, flat sheet	2000 psi 10.5°Bx–42.0°Bx	0.79–2.83	[15]
Maple sap	Cellulose acetate; spiral wound	600 psi 5 gal/min 5.5°Bx–10.3°Bx	9.0	[16]
Concord grape	Cellulose acetate, flat sheet	1500 psig 0.06–0.55 m/s 15.7°Bx–25.3°Bx	0.5–6.2	[17]
Passion fruit	Cellulose acetate, flat sheet	40 atm 6°C 8 L/min 16°Bx–26°Bx	1.5–10	[18]
Apple	Thin film composite, flat sheet	40 bar 30°C–60°C	9.6–21.7	[19]
	CA and PA, spiral wound	690–703 psi 21°C–27°C 13°Bx–22°Bx	3–14	[20]
Orange	Plate and frame, spiral configuration	1200 psig 10–12 cycles/min 0.3–0.9 fps 12°Bx–14°Bx	2–16	[21]
Apple juice	CA, plate and frame	35–45 bar 20°C 12°Bx–25°Bx	8–37	[22]
Beet	CA, plate and frame	30–40 bar 20°C 7–31	12–106	[23]
Pineapple	Plate and frame, tubular (PCI)	6000 kPa 40°C 13°Bx–25°Bx	16–18	[24]
Orange	Osmonics, 192 MS02-P, spiral wound	6.21 MPa 20°C 15 L/min 10.3–17.8	9–28	[25]
Tomato	ZF-99, tubular (PCI)	41.4 bar 40°C–78°C 4.7°Bx–9.5°Bx	18.5–41	[26]
Tomato	Cellulose acetate, plate and frame	3.0 MPa 20°C 4.8°Bx–12.5°Bx	2.3–15.1	[27]
Orange	Cellulose acetate, flat sheet	70–80 kg/cm <sup>2</sup> 27°C 9.9°Bx–46.6°Bx	7–12	[28]
Mandarin	Polyacrylamide, flat sheet	711 psi 20°C 5°Bx–25°Bx	2–18.5	[29]
Grape	Plate and frame	70 atm 6°C 8 L/min 10°Bx–25°Bx	3.1–14.2	[30]
Grape	ZF-99, tubular (PCI)	40 bar 16°C 16.5°Bx–22.5°Bx	3.2–13.2	[31]

membrane technology, most juices can be concentrated up to 65°Bx. This can be viewed as a first-stage process with other methods like freeze concentration or evaporation completing the concentration system.

Reverse osmosis has been used commercially to concentrate tomato juice from 4.5°Bx to 8.5°Bx. Later it can be concentrated in evaporators up to 30°Bx. This RO preconcentration can effectively double the operating capacity and improve color and flavor characteristics. Similarly, orange juice from 11°Bx–12°Bx to 18°Bx–20°Bx has been concentrated using RO prior to flash evaporation for producing high-quality concentrate. RO has also been a useful application for maple sap concentration where up to 75% of water can be removed at 1/20 [16].

As in the case of fruit juice clarification using UF and MF, the pretreatment before RO concentration is not always beneficial in terms of flux. It has been reported that both clarified and cloudy pineapple juice had similar flux [24]. However, enzyme treatment may also be useful to assist juice component separation. Invertase catalyzes the hydrolysis of sucrose into glucose and fructose. The use of invertase with pectinase effected a 23% reduction in retained soluble solids and an additional fivefold increase in pigment concentration on a fresh weight basis when processed during RO [23]. The flux of RO is influenced by pressure, temperature, membrane type, flow rate, and concentration [24,43]. The optimal operating parameters for various fruit juices during RO concentration are reported in Table 16.4. Increasing transmembrane pressure and temperature improves the permeate flux. At higher feed temperature, the membrane permeability coefficient is higher, the diffusivity coefficient in the solution increases, and the viscosity coefficient decreases. The flux has been shown to increase with cross-flow velocity when using RO on liquids containing protein, starches, or other micromolecules.

The membrane material plays an important role in determining permeation of solutes through the RO membrane due to interaction of solute and solvent at the membrane surface. Retention of compounds such as alcohols and organic acids with a CA membrane strongly depends on their polarity or hydrogen bonding capacity. Aromatic PA membranes have greater retention of flavor components of apple juice water, but lower fluxes. By using a composite membrane, it was found that the recovery of apple juice volatiles during RO concentration to 20°Bx was about 80% [22].

## 16.5.2 Dairy

Membrane processes have been investigated in dairy food industry for concentration of fluid milk and whey. Maubois et al. [44] proposed the use of ultrafiltration of milk before cheese making. The advantages of using ultrafiltered milk were 16%–20% increased in the yield of cheese, better control of dry matter and milk fat in the cheese, reduction in the quantity of coagulant up to 80%, and reduced environmental pollution due to protein/fat-free permeate/whey.

### 16.5.2.1 Quality of Ultrafiltered Milk

Milk fat is completely retained in the concentrated milk, and this increases yield of cheese due to greater retention of fat in curd than curd made from unfiltered milk [45,46]. Most of the protein of milk is also retained in the retentate, and this increases nitrogenous material in cheese made from UF-treated milk. Calcium in the milk exists in two forms: free ions and those partly bound to casein, phosphate, and citrate. The free ions in the aqueous phase of the milk are not concentrated by the UF. However, calcium-bound casein micelles increase in the retentate as the concentration factor increases. The lactose retention in UF milk is very low (~10%). This could cause textural defects and excessive acid production in cheese

**TABLE 16.5**

Osmotic Pressure of Various Fruit Juices at Room Temperature

Fruit Juice	Solids Concentration (%)	Osmotic Pressure (psi)	Reference
Orange	10.5	210	[15]
	11.0	230	[39]
Apple	15.0	300	[39]
	14.0	300	[15]
Pineapple	14.0	300	[40]
	16.0	300	[39]
Orange	21.5	430	[15]
	31.5	850	[15]
	42.0	1370	[15]
	60	2900	[41]

during ripening if the retentate is used to make cheese. Hence, the level of lactose must be obtained in the cheese curd [46]. The fat- and water-soluble vitamins, folic acid and B<sub>12</sub>, bound to protein are completely retained by UF. Ascorbic acid is mostly destroyed, and hence the milk and milk products are not considered as a good source of dietary ascorbic acid [45–47]. The viscosity of concentrated milk is increased drastically due to increase in the concentration of protein content. This creates difficulty in mixing the coagulant and starter culture in the concentrated milk that may lead to textural problem in the cheese. Another problem associated with the viscous retentate is entrapment of air that can lead to a spongy-type texture of cheese [48,49]. The texture abnormalities in the cheese made from homogenized and pasteurized whole milk are fewer than nonhomogenized concentrated milk [50]. The synthesis of curd made from UF milk tends to be slower than by curd from unfiltered milk. The curd obtained by UF milk is relatively difficult to cut, stir, and transport by conventional methods; hence, special coagulator is used [45].

#### 16.5.2.2 Microbiology of Ultrafiltered Milk

The conditions for growth and inhibition of bacteria in UF concentrated milk differ from those of regular milk. Haggerty and Potter [51] reported that growth and death of *Staphylococcus aureus*, *Streptococcus faecalis*, and *Escherichia coli* in UF concentrated and unconcentrated milk was not significantly different. Rash and Kosikowski [52] found that *E. coli* serotype 0124 had a greater survival and growth in Camembert cheese made from UF concentrated milk, and this was attributed to the differences in physicochemical properties of cheese. El-Gazzar et al. [53] reported that *Listeria monocytogenes* (V7 and California) grew faster and achieved higher counts at 4°C in UF concentrated milk than in skim milk. Previously, Dega et al. [54] also reported that heat resistance of several strains of *Salmonella* and *E. coli* increased as the solids content of reconstituted skim milk increased from 10% to 50%.

#### 16.5.2.3 Cheese and Other Dairy Foods

Several studies have been reported on the use of ultrafiltered milk for the production of cheese of different varieties. Geilman [55] concentrated skim milk up to 14.5% solids using UF and made cottage cheese of commercial quality. To develop a soft coagulum, trisodium citrate was added at the rate of 0.3% of the total concentrate. The pH was maintained close to normal isoelectric point of casein. Lelievre and Lawrence [56] also showed a possibility of making ricotta and cream cheese from UF concentrated milk since these varieties of cheese are not ripened. Olson and Qvist [57] used pasteurized (72°C–78°C for 15 s) UF concentrate of whole milk to manufacture Feta cheese. Fermentation was carried out using a strain of *Streptococcus lactis*. The minimum pH not higher than 4.8 was maintained to prevent softening of the cheese during storage. They also indicated that Cast Feta cheese made from UF concentrated milk had favorable characteristics and became popular in Greece. Cast Feta cheese has 3%–4% more moisture; a smoother texture; strong acid, rancid, and salty flavor. Abd-El-Salam et al. [58] manufactured Domiati cheese using UF concentrated buffalo skim milk (concentration factor 3.5) mixed with fresh cream of 35% milk fat at the rate of 4:1. The Domiati cheese showed less weight loss when stored without salt brine than in those when cheeses were stored in 5% brine solution or in salted (5%) permeate.

Camembert-type cheeses have successfully been manufactured using UF concentrated milk [47,59,60]. For this, skim milk is initially pasteurized and then concentrated about fivefold by ultrafiltration. It was reported that the yield of cheese was 20% higher [59], whey drainage was eliminated [47], and time of production was reduced [60]. Mahaut and Maubois [61] described the manufacturing of blue cheese from UF milk. Cheeses made from concentrate containing 12% protein were as good as, or better than traditional blue cheese. Mozzarella cheese can also be manufactured from milk concentrated (two- to fivefold) using ultrafiltration [62,63]. Colby and brick cheeses were manufactured by Bush et al. [64] using UF skim milk standardized with cream. They reported the reduction in the amount of milk-clotting enzyme used and elimination of curd washing. The brick cheese was more firm, and it had a more acid flavor, less typical cheese flavor, and ranked lower in overall preference than did cheese made from regular milk. However, characteristics of Colby cheese made from UF milk were reasonably close to those of commercial cheeses. Rao and Renner [65] manufactured cheddar cheese from UF milk and reported that the extent of proteolysis was highest in the cheese made from unfiltered milk,

followed by cheese made from unheated UF concentrate, and lowest in the cheese made from heated retentate. Organoleptically, there was no significant difference in appearance and constancy among ripened cheese samples. Sharma et al. [66] reported that the cheddar cheese manufactured using UF milk resulted in faster acid development, promoted more proteolysis, caused faster disappearance of lactose, and contributed a smoother body and texture. They used lower cooking and cheddaring temperature of 35°C. The use of starter culture at 2% by weight of unconcentrated milk together with lowering the cooking and cheddaring temperature caused the pH to be reduced at a faster rate and shortened the cheese-making time by approximately 45 min, compared to cheese made using traditional temperature (39°C).

El-Gazzar and Marth [46] concluded from their review that the UF concentrated milk could be used for making soft cheese such as Feta, Cast Feta, and Domiati since these cheeses can be consumed without ripening. However, cheese types that require ripening may have problems in sensory properties because of the high content of whey proteins. It has been reported that a significantly slower degradation of casein occurs, and thus cheese from UF milk ripens more slowly than traditional cheese. The higher mineral content in UF concentrated milk leads to an acid taste and sandy texture in cheese. Acid and bitter flavors can also arise from excessive lactose in the precheese. Also, behavior of lactic acid bacteria and pathogenic microorganisms differs in retentate from UF milk compared to unfiltered milk. Hence, additional work is needed to solve such problems before it is used more widely in the dairy industry.

The use of RO in dairy industry has been limited. Few studies have reported the manufacturing of cheese from RO-concentrated milk and concentration of whey [47,67–69]. These studies reported the use of less starter culture and rennet. However, the major limitation of RO of skim and whole milk has been membrane fouling.

### 16.5.3 Oils and Fats

Soybean, palm, rapeseed, and sunflower oils are most important in terms of volume of production. Most oils are used for food applications, including salad and cooking oils, mayonnaise, margarines, and chocolate. The crude oil extracted from biological material contains fatty acids; mono-, di-, and triglycerides; phosphatides (gums); sterols and tocopherols; and pigments (e.g., chlorophyll). Low concentrations of trace metals, flavanoids, tannins, hydrocarbons, and glycolipids may also be found in some oils. The crude oils need to be refined before they can be sold commercially. This involves removing unwanted components and concentrating the desired products. Usually, agricultural oils are extracted using an organic solvent such as hexane; therefore, the product also needs to be removed from an organic phase. These processes require large amounts of energy and generate large quantities of wastewater. The membrane technology also has potential applications in oil processing. Table 16.6 summarizes some of the research that have been conducted on the use of membrane processing for refining agricultural fats and oils.

#### 16.5.3.1 Solvent Recovery

The CA RO/NF membranes were used to recover ethanol from cottonseed–ethanol mixtures [70]. The rejection of triglycerides was higher initially. Later, the performance of the system degraded due to alcoholysis of membranes. The PA membranes were also affected by ethanol. Kuk et al. [70] reported that RO/NF membranes with pore sizes of 2 nm or less and with a pore density of  $10^{12}/\text{cm}^2$  were the most appropriate for recovering ethanol from oil. In a laboratory test, Koseoglu et al. [71] found that CA RO and PA RO/NF membranes were most suitable for separation of *iso*-propanol and ethanol, respectively. However, pilot plant tests showed higher level of oils in permeate. The increasing temperature in the feed stream also showed poor rejection of oil.

#### 16.5.3.2 Degumming

Sen Gupta [75] found that membranes made with different materials such as PA, PS, polyvinylidene fluoride (PVDF), polyimide (PI), and polyacrylonitrile (PAN) could be used in UF module for removal of phospholipids from soybean oil in hexane. He reported that phospholipid content of soybean oil was reduced to less than 300 mg/L, glycolipids to less than 50 mg/L, and green pigments to less than 0.5 mg/L. The concentrations of free fatty acids and tocopherol were unchanged, but the concentrations of copper, iron, magnesium,

TABLE 16.6

Applications to Agricultural Oil Refining

Membrane Type	Membrane Material	Membrane Module	MWCO (kDa)	Oil	Process Objective	Reference
RO/NF	PA composite	Flat sheet, tubular	1	Cottonseed	Ethanol recovery	[70]
	PA composite	Flat sheet, tubular	0.5–1.0	Cottonseed	Hexane recovery	[71]
	Fluorinated polymer	Flat sheet, tubular	20	Cottonseed	<i>iso</i> -Propanol recovery	
	PA composite	Flat sheet	0.3–0.4	Cottonseed	Ethanol	
	CA	Flat sheet	98% NaCl rejection	Sunflower	Separation	[76]
UF	PI	Tubular	20	Soybean	Degumming	[72,73,74]
	PI	Hollow fiber	—	Soybean	Degumming	[75]
	PAN	Flat sheet	30	Soybean	<i>iso</i> -Propanol recovery	[77]
	PI	Rotating disk	20	Fish oil hydrolysate	Ethanol recovery	[78,79]
MF	Synthetic polymer (microza TP-313)	Hollow fiber	0.2 $\mu$ m pore size	Sunflower	Dewaxing	[80,81]
UF	Ceramic	Honeycomb monolithic elements (1.9 mm)	0.05–0.2 $\mu$ m pore size	Soybean	Removal of catalyst	[82]
Dialysis membrane	Cellulose	Hollow fiber	6	Soybean	Removal of metals	[83]

calcium, and phosphorus were reduced. Sun and Koseoglu [84] found that UF membranes can reduce the phospholipids in cottonseed oil in hexane and *iso*-propane by 98.1% and 70%, respectively. Iwama [72,73] also reported phospholipid concentrations of 10–50 mg/L in permeate of soybean oils in hexane. These values are well within the limits acceptable for industrial use. The permeate flux of the hexane–oil mixture varied from 6 to 60 L/m<sup>2</sup>h at 50°C and a transmembrane pressure of 0.4 MPa.

### 16.5.3.3 Lipid Separations

Koike et al. [76] found that CA membrane gave better flux among 18 membranes tested for their ability to separate fatty acids; and mono-, di-, and triglycerides, from lipase hydrolysate of high-oleic sunflower oil. There was a large difference in rejection between free fatty acids and glycerides. The polyvinyl alcohol, PA, and polyether membrane gave high rejections of both glycerides and free fatty acids but there was little difference between the different components. The permeate flux and rejection were lower in hexane than in the ethanol. Keurentjes et al. [77,83] found that PAN and cellulose membranes gave complete rejection of triglycerides, while separating fatty acids from oil. However, the permeate flux for PAN membrane was 30-fold higher. Sahashi et al. [78,79] reported a study on the concentration and purification of *n*-3 polyunsaturated fatty acids (PUFAs). A hydrophilic PI ultrafiltered membrane was found to be the most suitable for the separation of solvent phase containing free fatty acids as a permeate. The permeate flux was in the range of 40–80 L/m<sup>2</sup>h. Kuk et al. [70] observed differences in rejection between triglycerides of different fatty acid composition while separating cottonseed oil from ethanol using PA RO membrane. They attributed these differences to variation in viscosity and diffusivity. Tristearin, which had the highest viscosity, was completely rejected; whereas tripalmitin and mixed triglycerides containing oleic acid, palmitic acid, and lauric acid were rejected to varying degrees.



#### 16.5.3.4 Dewaxing

In edible oil processing, dewaxing is done between decolorization and deodorization, and is one of the areas where membrane processing has been applied successfully. The Asahai Chemical Industry has done membrane dewaxing of sunflower oil on an industrial scale in Japan for more than 15 years. Chayamizu and Kikuchi [80] and Watanabe and Chayamizu [81] reported 97% of wax rejection with an MF membrane of 0.2  $\mu\text{m}$  pore size. Periodic back flushing by gas and with 80°C hot oil was necessary to maintain the permeate flux and to remove any wax that accumulated at the membrane surface. The oil flux was 4.8–27 L/m<sup>2</sup>h under a pressure of 0.3 MPa and the feed oil temperature was 5°C–10°C.

#### 16.5.3.5 Removal of Contaminants

Keurentjes et al. [83] used a hollow-fiber cellulose membrane module to remove copper from soybean oil. Vavra and Koseoglu [82] and Koseoglu and Vavra [85] used ceramic membranes to separate nickel catalysts from hydrogenated soybean oils. The rejection varied from 82% to 100%, while the permeate flux ranged from 8.5 to 42.5 L/m<sup>2</sup>h. However, the permeate flux with PEI membrane was 113 L/m<sup>2</sup>h. Kuk et al. [70] and Hron et al. [86] used PA RO/NF membranes to concentrate aflatoxin B1 from cottonseed oil in ethanol or *iso*-propanol.

#### 16.5.3.6 Removal of Pigments

Vegetable oils contain numerous pigments, including chlorophyll, caretonoids, xanthophylls, and their derivatives, that need to be removed to give the oil an acceptable color. Koseoglu et al. [87] identified 5 suitable membranes out of 15 tested for their ability to remove pigments, phosphorus, and gossypol (a yellow pigment) from crude cottonseed, soybean, canola, peanut, and meadowfoam seed mixtures. Chlorophyll and  $\beta$ -carotene rejection efficiency varied between membranes and between oils. Typically, the color readings of the permeate were about one-tenth that of the crude oils. Diosady et al. [88] suggested the use of a combination of techniques, including membranes to reduce chlorophyll by more than 90% from canola oil. Reddy et al. [89] found that PE membrane had a poor rejection of chlorophyll (<4%), while PI composite membrane gave over 95% rejection from sunflower and soybean oils in stirred batch test cell.

#### 16.5.3.7 Membrane Bioreactors

In recent years, there has been a lot of interest in the enzymatic modification of fats and oils to produce high-value products from cheap and plentiful raw agricultural materials. The process involves the use of lipase to catalyze hydrolysis, ester synthesis, and interesterification reactions. In the process, membranes can be used to provide a solid-supported interface and recover enzymes for reuse. Many research groups have used membrane bioreactors for the modification of fats and oils. Snape and Nakajima [90] have reviewed the choice of membrane material, membrane characteristics, and reactor configuration.

### 16.5.4 Potential Applications of Membrane Processes

Pectic enzymes are used in the clarification of apple juice before membrane filtration. Membrane clarification can be used to recover these enzymes to reduce industrial processing costs [91]. The isolation and purification of pectin from fruits can be achieved using ultrafiltration [92,93]. UF can also be used to recover colloidal carbohydrates that withstand the hydrolytic conditions of commercial pectolytic enzyme preparations during juice clarification [94]. Other major by-products of the fruit juice industry are essential oils and essences. Many of these components are immiscible with and poorly soluble in water, and hence make UF and RO as potential recovery techniques. Membrane-processing techniques have been investigated for the purification and concentration of various pigments, such as anthocyanins and betanins [23,95,96].

The membrane processes can be combined with ion exchange to deacidify fruit juices. Snir et al. [97] used ultrafiltration permeate of passion fruit juice and deacidified using ion exchange chromatography without plugging the column with pulp and the mixed back to retentate of UF process to obtain a less

sour product with flavor similar to the original juice. Koseoglu et al. [98] treated the UF permeate of citrus juice with RO and ion exchange for deacidification, while the UF retentate was heat sterilized. The treated permeate was combined with the sterilized retentate to obtain better flavor and aromas.

#### **16.5.4.1 Wine**

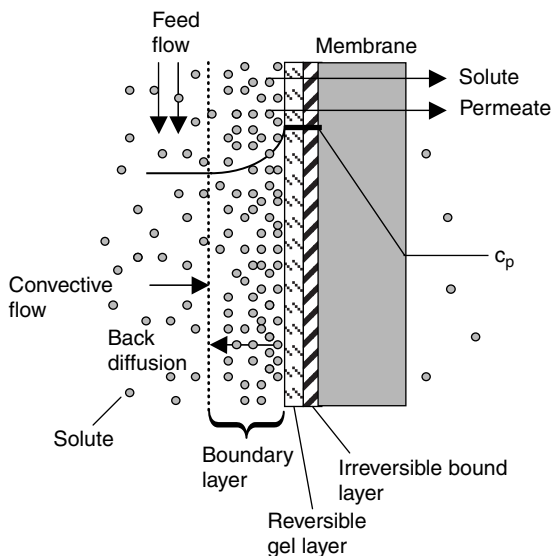
Reverse osmosis has been investigated for concentration and dealcoholization of wines [6]. The wines containing low alcohol are difficult to preserve and market. To increase the sugar concentration in these wines, RO has been applied as an alternative method to evaporation and freeze concentration. Duitschaever et al. [31] used thin film composite membranes in plate-frame module to increase sugars by 2.4%. Spiral wound and hollow fiber membranes have also been used for partial concentration and grape musts clarification prior to RO using centrifugation or MF [99–101]. The initial must from immature grapes can be concentrated with excessive malic acid content and reinforce the vegetal character using RO [102]. A low-acid, light-colored, and light-bodied red wine can be concentrated using RO to produce a high-acid, dark-colored, full-bodied product. Dick and Dixmier [103] used polyhydroxymethylacrylamide RO membrane with 85%–90% ethanol rejection to increase ethanol concentration from 10% to 12.5% while the alcohol content in the permeate remained below 2%. Most other constituents were found at trace levels in the permeate except methanol, which can cross the membrane freely [103,104].

Selective RO membranes have been used for dealcoholization of wines. The process involves wine as a feed, and the RO membranes allow water and ethanol to permeate while most flavor and all color compounds are retained. The wine is recycled across the membranes until the required degree of concentration is achieved. The permeate containing water and ethanol is distilled, and water is combined with concentrated wine to produce a low-alcohol product [6]. It is feasible to produce wine with 3% ethanol with acceptable quality [105]. The sensory properties of dealcoholized wine started to change significantly below 9% of alcohol. The wine appears to have less body and a more watery mouthfeel. To have acceptable products, organic acid and grape juice or concentrate are added to wines to obtain 6 g/L titratable acidity and 5°Bx [106]. Wucherrpfennig et al. [107] used dialysis process for dealcoholization of wine using another alcohol-free wine that was produced using vacuum distillation. As a concentration gradient exists only for alcohol, little change in concentration of other constituents occurs. The alcohol diffusing into the second wine is eliminated by vacuum distillation, allowing the reuse of the wine in the dialysis process. This way heat damage to the wine is eliminated. Bui et al. [108] used two RO modules, one equipped with ethanol-permeable PS membranes and the other with selective ethanol-retention polyacrylamide membrane. The ethanol-retention membrane produced concentrated wine (12%–13% ethanol) and the permeate (mainly water and 2% ethanol) is mixed with original wine (10%–11% ethanol) and used as the feed to ethanol-permeable membranes to produce light wine with 6%–7% ethanol. Because membranes were impermeable to anthocyanins, two different wines, such as rose and red wine, can be used simultaneously for the light and enriched streams [6]. The effects of membrane filtration on the aromatic profile and phenolic quality of Cabernet Sauvignon wine were studied by Arriagada-Carrazana et al. [109]. The results of their study showed that concentration of tannins (4.8%), anthocyanins (2.4%), and total phenolic index (10%) decreased. This was attributed to absorption in the membrane filter.

#### **16.5.4.2 Pervaporation**

Mass transport during pervaporation is achieved by partial vaporization through a nonporous selectively permeable membrane. The flux of any compound to be separated is determined by its partial pressure gradient across the membrane and its permeability in the membrane matrix. The difference in partial pressure is created on the permeate side, usually by the vacuum generated. The process results in a liquid retentate and a vapor permeate that is condensed using low temperatures [6]. One of the first pervaporation applications considered for the food industry was the production of dealcoholized beverages, including wine and beer [110,111]. Hydrophobic membranes can preferentially permeate ethanol over water vapor, and this can be used to extract ethanol from alcoholic beverages. To reduce the aroma loss, hydrophilic membranes can be used. Another promising application of pervaporation is aroma compound recovery and concentration. Bengtsson et al. [112] used pervaporation to concentrate a natural aroma condensate from an apple juice concentrate plant. Rajagopalan and Cheryan [113] evaluated

pervaporation membranes using a model flavor, i.e., methyl anthranilate compound of Concord grapes. Like other membrane techniques, pervaporation allows low-temperature extraction and makes it possible to treat heat-labile products such as beverages or fermentation media. Pervaporation has also been demonstrated as a possible means for juice concentration. Buvet and Idier [114] developed a hydrophilic membrane for extracting water from juices, syrups, and other aqueous solutions. Karlsson and Tragardh [115] investigated the effect of high ethanol concentrations during aroma compound recovery. Though pervaporation has not yet had a major commercial impact in the food industry, it is a very attractive approach to certain separations requiring the avoidance of high mechanical, thermal, or chemical stresses. The potential application of pervaporation is in the aroma recovery in fruit juice processing.



**FIGURE 16.4** A schematic representation of concentration polarization and fouling at the membrane surface.

## 16.6 Concentration Polarization and Fouling

The major goal of the membrane system is to achieve the required separation with economically acceptable permeate flux. Both concentration polarization and membrane fouling influence the performance of membrane system (Figure 16.4) [43]. Membrane lifetime and permeate fluxes are primarily affected by the phenomena of concentration polarization (i.e., solute build-up) and fouling (e.g., microbial adhesion, gel layer formation, and solute adhesion) at the membrane surface. The concentration polarization is a fluid dynamics phenomenon, whereas fouling is a chemical phenomenon between solutes and the membrane. In a laminar flow regime, decreasing channel height, increasing inlet velocity, and decreasing channel length can decrease concentration polarization. Disrupting the boundary layer by mechanically inducing turbulence in the fluid stream can improve permeate flux. The flux can be improved with dynamic turbulence promotion involving acrylic resin plastic spheres moving randomly in the retentate channels of an RO system. The permeate flux can also be improved with reciprocating flow. Depending on the pulse rate and flow velocity conditions, the permeate flux improved from 1.7 to 5.1 L/m<sup>2</sup>h for 24% solids orange juice. Backwashing is another technique where the flow is intermittently reversed from feed-side-to-permeate-side flow to wash solutes off the membrane surface and out of the system. Other options such as ultrasonic vibration, rotational motion, and spongy balls have also been investigated [6,43].

## 16.7 Cleaning Membranes

Effective cleaning after processing is important to reduce the fouling on the membrane surface. Thus, flux can be restored, and membrane life and performance can be maximized. A wide variety of acid/alkaline detergent/sanitizer combinations can be applied to remove foulant accumulated in the membrane systems. Membrane manufacturers have spent considerable amount of effort to identify appropriate detergent and its strength suitable for particular application. For juice processing, the cleaning involves rinsing the membrane system with water initially and then using alkaline detergent and hypochlorite solutions at recommended temperatures (40°C–60°C). Typically, a membrane unit used for filtration of apple juice can be cleaned-in-place at 50°C using a 0.1%–0.5% alkaline detergent solution (pH 10–11) with 100–1000 ppm free chlorine, the rates being specific to the type of membrane [116,117]. Following a rinse with water, the cleaning cycle can be repeated. Mixtures of nitric and

phosphoric acid are recommended for dairy processing for dissolving minerals and salt foulant. For most commercial membrane systems, cleaning instructions that are provided by the membrane manufacturers should be followed. The cleaning protocol includes type of chemicals, time of exposure, and temperature. The RO membranes tend to be more susceptible to damage than MF and UF. In general, PVDF membranes can withstand higher rates of chlorine than CA or polyethersulfone. It is important to monitor the sanitizer strength and ensure contact with all areas of the membrane system.

---

## References

1. Cheryan, M. Concentration of liquid foods by reverse osmosis, In *Handbook of Food Engineering*, D. R. Heldman and D. B. Lund (Eds), Marcel Dekker, Inc. New York, pp. 393–436 (1992).
2. Reid, C. E. and Breton, E. J. Water and ion flow across cellulose acetate membranes, *Journal of Applied Polymer Science* 1: 133–143 (1959).
3. Loeb, S. and Sourirajan, S. Seawater demineralization by means of semi-permeable membranes, *UCLA Engineering Report* 60 (1960).
4. Loeb, S. and Sourirajan, S. Seawater demineralization by means of an osmotic membrane, *Advances in Chemical Series* 38: 117–132 (1962).
5. Mannapperuma, J. D. Design and performance evaluation of membrane systems, In *Handbook of Food Engineering Practice*, K. J. Valentas, E. Rotstein and R. P. Singh (Eds), CRC Press, Boca Raton, FL (1997).
6. Girard, B. and Fukumoto, L. R. Membrane processing of fruit juices and beverages: a review, *Critical Reviews in Food Science and Nutrition* 40: 91–157 (2000).
7. Padilla, O. I. and McLellan, M. R. Molecular weight cut-off of ultrafiltration membranes and the quality and stability of apple juice, *Journal of Food Science* 54: 1250–1254 (1989).
8. Wu, M. L., Zall, R. R., and Tzeng, W. C. Microfiltration and ultrafiltration comparison for apple juice clarification, *Journal of Food Science* 55: 1162–1163 (1990).
9. Fukumoto, L. R., Delaquis, P. D., and Girard, B. Microfiltration and ultrafiltration ceramic membranes for apple juice clarification, *Journal of Food Science* 63: 845–850 (1998).
10. Kirk, D. E., Montgomery, M. W., and Kortekaas, M. G. Clarification of pear juice by hollow fiber ultrafiltration, *Journal of Food Science* 48: 1663–1667 (1983).
11. Wilson, E. L. and Burns, D. J. W. Kiwifruit juice processing using heat treatment techniques and ultrafiltration, *Journal of Food Science* 48: 1101–1105 (1983).
12. Capannelli, G., Bottino, A., Munari, S., Ballarino, G., Mirzaian, R., Rispoli, G., Lister, D. G., and Maschio, G. Ultrafiltration of fresh orange and lemon juices, *Lebensmittel Wissenschaft und-Technologie* 25: 518–522 (1992).
13. Capannelli, G., Bottino, A., Munari, S., Lister, D. G., Maschio, G., and Becchi, I. The use of membrane processes in the clarification of orange and lemon juices, *Journal of Food Engineering* 21: 473–483 (1994).
14. Chamchong, M. and Noomhorn, A. Effect of pH and enzymatic treatment on microfiltration and ultrafiltration of tangerine juice, *Journal of Food Process Engineering* 14: 21–34 (1991).
15. Merson, R. L. and Morgan, A. I. Juice concentration by reverse osmosis, *Food Technology* 22: 631 (1968).
16. Underwood, J. C. and Willits, C. O. Operation of a reverse osmosis plant for the partial concentration of maple syrup, *Food Technology* 23: 79 (1969).
17. Lowe, E., Durkee, E. L., and Morgan, A. I. Jr. A reverse osmosis unit for food use, *Food Technology* 22: 103 (1968).
18. Pompei, C. and Rho, G. Concentration du jus de passiflore (*Passiflora edulis*) par osmose inverse, *Lebensmittel Wissenschaft und Technologie* 7: 167–172 (1974).
19. Sheu, M. J. and Wiley, R. C. Influence of reverse osmosis on sugar retention in apple juice concentration, *Journal of Food Science* 49: 304–305 (1984).
20. Chua, H. T., Rao, M. A., Acree, T. E., and Cunningham, D. G. Reverse osmosis concentration of apple juice flux and flavour retention by cellulose acetate and polyamide membranes, *Journal of Food Process Engineering* 9: 231–245 (1987).
21. Lowe, E. and Durkee, E. L. Dynamic turbulence promotion in reverse osmosis processing of liquid foods, *Journal of Food Science* 36: 31–32 (1971).
22. Sheu, M. J. and Wiley, R. C. Preconcentration of apple juice by reverse osmosis, *Journal of Food Science* 48: 422–429 (1983).

23. Lee, Y. N., Wiley, R. C., Sheu, M. J., and Schlimme, D. V. Purification and concentration of betalaines by ultrafiltration and reverse osmosis, *Journal of Food Science* 47: 465–471 (1982).
24. Bowden, R. P. and Isaacs, A. R. Concentration of pineapple juice by reverse osmosis, *Food Australia* 41: 850–851 (1989).
25. Medina, B. C. and Garcia, A. Concentration of orange juice by reverse osmosis, *Journal of Food Process Engineering* 10: 217 (1988).
26. Merlo, C. A., Rose, W. W., Pedersen, L. D., and White, E. M. Hyperfiltration of tomato juice during long term high temperature testing, *Journal of Food Science* 51: 395–398 (1986).
27. Dale, M. C., Okos, M. R. and Nelson, P. Concentration of tomato products: analysis of energy saving process alternatives, *Journal of Food Science* 47: 1853–1858 (1982).
28. Nomura, D. and Hayakawa, I. Studies on concentration of orange juice by reverse osmosis, *Nippon Shokuhin Kogyo Gakkaishi* 23: 404 (1976).
29. Fukutani, K. and Ogawa, H. A comparison of membrane's suitability and effect of operating pressure for juice concentration by reverse osmosis, *Nippon Shokuhin Kogyo Gakkaishi* 30: 636 (1983).
30. Peri, C. and Pompei, C. Concentrazione del mosto di uva per osmosi inversa, *Vini d'Italia* 17: 179 (1975).
31. Duitschaever, C. L., Alba, J., Buteau, C., and Allen, B. Riesling wines made from must concentrated by reverse osmosis. I. Experimental conditions and composition of musts and wines, *American Journal of Enology and Viticulture* 42: 19–25 (1991).
32. Rao, M. A., Acree, T. E., Cooley, H. J., and Ennis, R. W. Clarification of apple juice by hollow fiber ultrafiltration: fluxes and retention of odor-active volatiles, *Journal of Food Science* 52: 375–377 (1987).
33. Rwabahizi, S. and Wrolstad, R. E. Effects of mold contamination and ultrafiltration on the color stability of strawberry juice and concentrate, *Journal of Food Science* 53: 857–861 (1988).
34. Drake, S. R. and Nelson, J. W. Apple juice quality as influenced by ultrafiltration, *Journal of Food Quality* 9: 399–406 (1986).
35. McKenzie, D. L. and Beveridge, T. The effect of storage, processing and enzyme treatment on the microstructure of cloudy Spartan apple juice particulate, *Food Microstructure* 7: 195–203 (1988).
36. Wucherpennig, K., Dietrich, H., Kanzler, K., and Will, F. Origin, structure and molecular weight of colloids present in fruit juices and fruit wines and their significance for clarification and filtration processes, *Confructa Studien* 31: 80 (1987).
37. Maier, G., Frei, M., Wucherpennig, K., Dietrich, H., and Ritter, G. Innovative processes for production of ultrafiltered apple juices and concentrates, *Fruit Processing* 5: 134 (1994).
38. Braddock, R. J. Ultrafiltration and reverse osmosis recovery of limonene from citrus processing waste streams, *Journal of Food Science*, 47: 946–948 (1982).
39. Cheryan, M. Membrane separations: mechanisms, and models, In *Food Properties and Computer-Aided Engineering of Food Process Systems*, R. P. Singh and A. G. Medina (Eds), Kluwer Academic Publishers, Dordrecht, Netherlands, p. 367 (1989).
40. Leightell, B. Reverse osmosis in the concentration of food, *Process Biochemistry* 3: 41 (1972).
41. Gostolli, C., Bandini, S., Francesca, R. Di., and Zardi, G. Concentrating fruit juices by reverse osmosis—the low retention–high retention method, *Fruit Process* 6: 183 (1995).
42. Pepper, D., Orchard, A. C. J., and Merry, A. J. Concentration of tomato juice and other fruit juices by reverse osmosis, *Desalination* 53: 57–166 (1985).
43. Sablani, S. S., Goosen, M. F. A., Al-Belushi, R. H., and Wilf, M. Concentration polarization in ultrafiltration and reverse osmosis, *Desalination* 141: 269–289 (2001).
44. Maubois, J. L., Mocquot, G., and Vassal, L. A method for processing milk and dairy products, French Patent No. 2,052, 121 (1969).
45. Green, M. L., Scott, K. J., Anderson, M., Griffin, M. C. A., and Glover, F. A. Chemical characterization of milk concentrated by ultrafiltration, *Journal of Dairy Science* 51: 267–278 (1984).
46. El-Gazzar, F. E. and Marth, E. H. Ultrafiltration and reverse osmosis in dairy technology: a review, *Journal of Food Protection* 54(10): 801–809 (1991).
47. Glover, F. A. Ultrafiltration and reverse osmosis for the dairy industry, National Institute for Research in Dairying, Reading, England (1985).
48. de Boer, R. and Nooy, P. F. C. Low-fat semi-hard cheese from ultrafiltered milk, *North European Dairy Journal* 46: 52–61 (1980).

49. Kosikowski, F. New cheese making procedures utilizing ultrafiltration, *Food Technology* 40: 71–77 (1986).
50. Green, M. L., Glover, F. A., and Marshall, R. J. Cheddar cheesemaking behavior of whole milk concentrated by ultrafiltration, *Proceedings of 21st International Dairy Congress*, Vol. I, 2: 448 (1982).
51. Haggerty, P. and Potter, N. Growth and death of selected microorganisms in ultrafiltered milk, *Journal of Food Protection* 49: 233–235 (1986).
52. Rash, K. E. and Kosikowski, F. V. Behavior of enteropathogenic *Escherichia coli* in Camembert cheese made from ultrafiltered milk, *Journal of Food Science* 47: 728–732,736 (1982).
53. El-Gazzar, F. E., Bohner, H. F., and Marth, E. H. Growth of *Listeria monocytogenes* at 4, 32 and 40°C in skim milk and in retentate and permeate from ultrafiltered skim milk, *Journal of Food Protection* 54: 338–342 (1991).
54. Dega, C. A., Goepfert, J. M., and Amundson, C. H. Heat resistance of salmonellae in concentrated milk, *Applied Microbiology* 23: 415–420 (1972).
55. Geilman, G. W. Use of UF retentate for cottage cheese manufacture, In *Symposium on Advances in Dairy Products Technology*. San Luis Obispo, CA, October 4–5 (1989).
56. Lelievre, L. and Lawrence, R. C. Manufacture of cheese from milk concentrated by ultrafiltration. A review, *Journal of Dairy Research* 55: 465–478 (1988).
57. Olson, N. F. and Qvist, K. B. Manufacture of soft and semi soft cheese utilizing ultrafiltration, *Symposium on Advances in Dairy Products Technology*. San Luis Obispo, CA, October 4–5 (1989).
58. Abd-El-Salam, M. H., El-Shibiny, S., Ahmed, N. S., and Ismail, A. A. Use of ultrafiltration in manufacture of Domiati cheese from buffalo milk, *Egyptian Journal of Dairy Science* 9: 151–157 (1981).
59. Jepsen, S. Production of Camembert cheese by ultrafiltration according to the MMV Process, *North European Dairy Journal* 41: 101–105 (1975).
60. Maubois, J. L. Recent development of membrane ultrafiltration in the dairy industry, In *Ultrafiltration Membrane and Applications* (Symposium 1979), A. R. Cooper (Ed.), Plenum Press, New York, pp. 305–318 (1980).
61. Mahaut, M. and Maubois, J. L. Application of the MMV process to the making of blue cheeses, *Proceedings of the 20th International Dairy Congress*, Vol. E, pp. 793–794 (1978).
62. Fernandez, A. and Kosikowski, F. V. Physical properties of direct acidified Mozzarella cheese from ultrafiltered whole milk retentate, *Journal of Dairy Science* 69: 643–648 (1986).
63. Covacevich, H. R. and Kosikowski, F. V. Mozzarella and cheddar cheese manufacture by ultrafiltration principles, *Journal of Dairy Science* 61: 701–709 (1978).
64. Bush, C. S., Garoutte, C. A., Amundson, C. H., and Olson, N. F. Manufacture of Colby and brick cheeses from ultrafiltered milk, *Journal of Dairy Science* 66: 415–421 (1983).
65. Rao, D. V. and Renner, E. Studies on the application of ultrafiltration for the manufacture of Cheddar cheese. 3. Ripening characteristics, *Milchwissenschaft* 44: 351–354 (1989).
66. Sharma, S. K., Ferrier, L. K., and Hill, A. R. Effect of modified manufacturing parameters on the quality of Cheddar cheese made from ultrafiltered milk, *Journal of Food Science* 54: 573–577 (1989).
67. Agbevari, T., Rouleau, D., and Mayer, R. Production and quality of Cheddar cheese manufactured from whole milk concentrated by reverse osmosis, *Journal of Food Science* 48: 642–643 (1983).
68. Bynum, D. G. and Barbano, D. M. Whole milk reverse osmosis retentates for cheddar cheese manufacture: chemical changes during aging, *Journal of Dairy Science* 68: 1–10 (1984).
69. Barbano, D. M. and Bynum, D. G. Whole milk reverse osmosis and yield, *Journal of Dairy Science* 67: 2839–2849 (1984).
70. Kuk, M. S., Hron, R. J., and Abraham, G. Reverse osmosis membrane characteristics for partitioning triglycerides-solvent mixtures, *Journal of American Oil Chemists' Society* 66: 1374–1380 (1989).
71. Koseoglu, S. S., Lawhon, J. T., and Lusas, E. W. Membrane processing of crude vegetable oils: pilot plant scale removal of solvent from oil miscellas, *Journal of American Oil Chemists' Society* 67: 315–322 (1990).
72. Iwama, A. Membrane separation process for soybean oil refining and its economical effects, *Maku (membrane)* 11: 99–108 (1986).
73. Iwama, A. New process for purifying soybean oil by membrane separation and economic evaluation of the process, *Journal of American Oil Chemists' Society* 64: 1258 (1987).
74. Miki, S., Kusuda, M., Iwama, A., and Ochiai, T. Application of UF membrane process for purifying soybean oil by plate-type module having thin channels, *Proceedings Session Lectures and Scientific Presentations on ISF-JOCS World Congress*, Vol. 1, Japan Oil Chemists' Society paper 2S04 (1988).

75. Sen Gupta, A. K. Neuere Entwicklungen auf dem Gebiet der Raffination der Speiseole, *Fette Seifen Anstrichm* 88: 79–86 (1986).
76. Koike, S., Yokoo, M., Nabetani, H., and Nakajima, M. Membrane separation of fats and oils in organic solvents, *Progress in Bioseparation Engineering*, Japan Society of Chemical Engineering, 33: 84–87 (1992).
77. Keurentjes, J. T. F., Sluijs, J. T. M., Franssen, R. J. H., and van't Riet, K. Extraction and fractionation of fatty acids from oil using an ultrafiltration membrane, *Industrial Engineering and Chemical Research* 31: 581–587 (1992).
78. Sahashi, Y., Ishizuka, H., Koike, S., and Suzuki, K. Purification of polyunsaturated fatty acids from fish oil hydrolysate by membrane/extraction system, *Progress in Bioseparation Engineering*, Japan Society of Chemical Engineering 33: 79–83 (1993).
79. Sahashi, Y., Ishizuka, H., Koike, S., and Suzuki, K. Separation and concentration of polyunsaturated fatty acids by a combined system of liquid-liquid extraction and membrane separation, In *Developments in Food Engineering Part 2*, T. Yano, R. Matsuno, and K. Nakamura (Eds), Blackie Academic and Professional, Glasgow, UK, pp. 674–676 (1994).
80. Chayamizu, H. and Kikuchi, H. Dewaxing of sunflower oil by microza TP-113, *Proceedings of Session Lectures and Scientific Presentation on ISF-JOCS World Congress*, 1 (1988).
81. Watanabe, K. and Chayamizu, H. Dewaxing of edible oil (in Japanese) In *Maku-Shori-Gijutsu-Taikai*, M. Nakagaki and H. Shimizu (Eds), Fuji-Techno-System, Tokyo, pp. 178–182 (1991).
82. Vavra, C. and Koseoglu, S. S. Catalyst removal from hydrogenated oils using membrane technology, In *Developments in Food Engineering*, T. Yano, R. Matsuno, and K. Nakamura (Eds), Blackie Academic and Professional, Glasgow, UK (Proceedings of the 6th International Congress on Engineering and Food 23–27 May, 1993, Chiba, Japan), pp. 683–685 (1994).
83. Keurentjes, J. T. F., Bosklopper, Th. G. J., van Drop, L. J., and van't Riet, K. The removal of metals from edible oil by a membrane extraction procedure, *Journal of American Oil Chemists' Society* 67: 28–32 (1990).
84. Sun, S. and Koseoglu, S. S. Membrane degumming of cottonseed miscella, *American Oil Chemists Society Annual Meeting*, Atlanta, GA INFORM 5: 481 (1994).
85. Koseoglu, S. S. and Vavra, C. Catalyst removal from hydrogenated oil by using membrane processing, *INFORM* 3: 536 (1992).
86. Hron, R. J., Kuk, M. S., Abraham, G., and Wan, P. J. Ethanol extraction of oil, gossypol and aflatoxin from cottonseed, *Journal of American Oil Chemists Society* 71: 417–421 (1994).
87. Koseoglu, S. S., Rhee, K. C., and Lusas, E. W. Membranes processing of crude vegetable oils: laboratory scale membrane degumming, refining and bleaching, *Processing Edible Fats and Oils-Basic Principles and Modern Practices*, D. R. Erickson (Ed.), *American Oil Chemists Society Meeting*, October 1989, pp. 182–188 (1990).
88. Diosady, L. L., Rubin, L. J., and Hussein, A. Chlorophyll removal from vegetable oil, *INFORM* 3: 536 (1992).
89. Reddy, K. K., Nakajima, M., Snape, J. B., Kawakatsu, K., Ichikawa, S., and Nabetani, H. Membrane decolorization of crude oil, *Proceedings of the International Congress on Membrane Science*, Yokohama, Japan, paper 894 (1996).
90. Snape, J. B. and Nakajima, M. Processing of agricultural fats and oils using membrane technology, *Journal of Food Engineering* 30: 1–41 (1996).
91. Sheu, M. J., Wiley, R. C. and Schimme, D. V. Solute and enzyme recoveries in apple juice clarification using ultrafiltration, *Journal of Food Science* 52: 732–756 (1987).
92. Vatai, G. and Tekic, M. N. Ultrafiltration of pectin solutions in hollow-fiber modules, *Lebensmittel Wissenschaft und-Technologie* 24: 566 (1991).
93. Hoagland, P. D., Konja, G., and Fishman, M. L. Component analysis of disaggregation of pectin during plate module ultrafiltration, *Journal of Food Science* 58(3): 680–686 (1993).
94. Will, F., Mischler, M., and Dorreich, K. Pilot scale isolation and separation of apple juice colloids, *Lebensmittel Wissenschaft und Technologie* 27: 292–294 (1994).
95. Metivier, R. P., Francis, F. J., and Clydesdale, F. M. Solvent extraction of anthocyanins from wine pomace, *Journal of Food Science* 45: 1099–1100 (1980).
96. Chung, M. Y., Hwang, L. S., and Chiang, B. H. Concentration of perilla anthocyanins by ultrafiltration, *Journal of Food Science* 51: 1494–1497 (1986).

97. Snir, R., Wicker, L., Koehler, P. E., and Sims, K. A. Membrane fouling and molecular weight cutoff effects on the partitioning of pectinesterase, *Journal of Agricultural Food Chemistry* 44: 2091–2095 (1996).
98. Koseoglu, S. S., Lawhon, J. T., and Lusas, E. W. Use of membranes in fruit juice processing, *Food Technology* 44: 90–97 (1990).
99. Peynaud, E. and Allard, J. J. Concentration des mouts de raisin par osmose inverse, *C. R. Acad. Agric. France* 1454 (1970).
100. Delfini, C., Giacosa, D., Nicolini, G., Bardi, L., Lanati, D., Pagliara, A., Borsa, D., and Garcia-Moruno, E. Essais d'enrichissement partiel de mout de raisin par osmose inverse, *Journal International des Sciences de la Vigne et du Vin. Connaissance de la Vigne et du Vin* 25: 1 (1991).
101. Berger, J. L. Auto-enrichissement du mout par osmose inverse, *Bulletin de l'O.I.V.* 721–722: 189 (1980).
102. Wucherpfennig, K. Possibilités d'utilisation de processus membranaires dans l'industrie des boissons, *Bull de l'O.I.V.* 583: 186 (1980).
103. Dick, R. and Dixmier, F. Traitement par osmose inverse de vins de consommation courante en vue d'augmenter leur teneur en alcool, *Le Lait* 64: 163 (1984).
104. Bui, K., Dick, R., Moulin, G., and Galzy, P. Partial concentration of red wine by reverse osmosis, *Journal of Food Science* 53: 647–648 (1988).
105. Gibson, R. L. Cross flow membrane technology for the wine industry, *Australian Grapegrower and Winemaker* 268: 17 (1986).
106. Cuenat, P., Kobel, D., and Crettenand, J. Sur la potentialité de l'osmose inverse pour la desalcoolisation partielle ou totale des vins—exemples d'application, *Revue Suisse Vitic. Arboric. Hortic.* 17: 367 (1985).
107. Wucherpfennig, K., Millies, K. D., and Cristmann, M. Manufacture of alcohol-reduced wine, with special reference to the dialysis procedure, *Weinwirtschaft-Technik* 122: 346 (1986).
108. Bui, K., Dick, R., Moulin, G., and Galzy, P. A reverse osmosis for the production of low ethanol content wine, *American Journal of Enology Viticulture* 37: 297–300 (1986).
109. Arriagada-Carrazana, J. P., Saez-Navarrete, C., and Bordeu, E. Membrane filtration effects on aromatic and phenolic quality of Cabernet wines, *Journal of Food Engineering* 68: 363–368 (2005).
110. Escoudier, J. L., Le Bouar, M., Moutounet, M., Jouret, C., and Barillere, J. M. Application and evaluation of pervaporation for the production of low alcohol wines. *Proceedings of the Third International Conference on Pervaporation Processes in the Chemical Industry*, Bakish, R. (Ed.), Bakish Materials Corporation, Englewood, NJ, pp. 387 (1988).
111. Kimmerle, K. and Gudernatsch, W. Pilot dealcoholization of beer by pervaporation, *Proceedings of the Fifth International Conference on Pervaporation Processes in the Chemical Industry*, Bakish, R. (Ed.), Bakish Materials Corporation, Englewood, NJ, pp. 291–307 (1991).
112. Bengtsson, E., Tragardh, G., and Hallstorm, B. Concentration of apple juice aroma from evaporator condensate using pervaporation, *Lebensmittel Wissenschaft und Technologie* 25: 29 (1992).
113. Rajagopalan, N. and Cheryan, M. Pervaporation of grape juice aroma, *Journal of Membrane Science* 104: 243–250 (1995).
114. Buvet, R. and Idier, L. Process for concentration by pervaporation of aqueous liquids containing volatile or steam-entrainable organic compounds, French Patent 2: 641–984 (1990).
115. Karlsson, H. O. E. and Tragardh, G. Aroma compound recovery with pervaporation—feed flow effects, *Journal of Membrane Science* 81, 163–171 (1993).
116. Dornier, M., Petermann, R., and Decloux, M. Influence of start-up procedure on crossflow microfiltration of raw cane sugar, *Journal of Food Engineering* 24: 213–224 (1995).
117. Girard, B. and Fukumoto, L. R. Apple juice clarification using microfiltration and ultrafiltration polymeric membranes, *Lebensmittel—Wissenschaft und-Technologie* 32: 290–298 (1999).





# 17

## *Stickiness and Caking in Food Preservation*

**Bhesh R. Bhandari**

### **CONTENTS**

17.1	Introduction .....	387
17.2	Structure of Food Solids .....	388
17.2.1	Crystalline Structure .....	388
17.2.2	Amorphous Structure .....	388
17.2.3	Mixed Structure .....	388
17.3	Stickiness of Food Solids .....	388
17.3.1	Cohesive Forces and Stickiness .....	389
17.3.1.1	Liquid Bridges .....	389
17.3.1.2	Solid Bridges.....	389
17.3.1.3	van der Waals Forces .....	389
17.3.1.4	Electrostatic Forces.....	390
17.3.1.5	Mechanical Interlocking .....	390
17.3.2	Adhesive Forces and Surface Energetics.....	390
17.3.3	Occurrence of Cohesion and Adhesion during Drying .....	391
17.3.4	Stickiness Testing Methods for Powders .....	392
17.3.4.1	Testing for Cohesion.....	392
17.3.4.2	Testing for Adhesion.....	396
17.4	Caking of Powders .....	396
17.4.1	Factors Responsible for Caking.....	397
17.4.1.1	Presence of Liquid Component .....	397
17.4.1.2	Moisture Absorption .....	398
17.4.1.3	Crystallization .....	398
17.4.1.4	Consolidation .....	398
17.4.2	Measurements of Degree of Caking .....	399
17.4.3	Anticaking Agents .....	399
References	.....	400

### **17.1 Introduction**

Dry solid food materials can exist in various forms and dimensions. These may range from pieces to very fine nanosize powders. The dimensions of individual particulates may vary from few microns (or even nano size) to several millimeters or centimeters. Food powders generally have the dimension of few millimeters to a few micrometers. Granular products (diameters of few millimeters) are also categorized as powder. In this chapter, dried foods are referred to as powders, since the powder form is the most common dry state of food materials.

Various methods are employed to produce foods in dried form. These processes include various methods of drying, crystallization, grinding, milling, or mixing (liquid to solid) with other ingredients. Depending on the type of the process employed and nature of the components present, the dried product

may exist in amorphous, crystalline, or mixed (semi-crystalline) form. Some examples of food powders in these states are listed in Table 17.1. The physical form of the powder and their individual properties influence many functional properties such as flowability, bulk density, ease of handling, dust forming, mixing/segregation, compressibility, and surface activity. The stickiness and caking behavior of powders are also related to the physical forms and dimensions of particulates. Fundamental understanding of the sticking and caking behavior of powder is important since these phenomena alter the expected functional and nutritional properties and stability of the food powders.

**TABLE 17.1**

Physical States of Various Food Powders

Forms	Examples of Powders
Amorphous	Milk, some whey powders, encapsulated powders, instant coffee and tea, spices, cheese, protein, coffee whitener, cocoa, spice mixes (gravy, soup, etc.)
Crystalline	Refined sugar, organic acids, polyols, salts
Mixed	Some whey powders, starch powders, ground icing sugar

Source: Bhandari, B.R. and Hartel, R.W., 2005, In *Encapsulated and Powdered Foods*, Ed. C. Onwulata, New York: Taylor and Francis, pp. 261–291.

## 17.2 Structure of Food Solids

### 17.2.1 Crystalline Structure

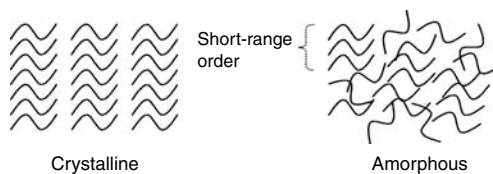
Many dried solid foods are in crystalline form. Thermodynamically, the crystalline form is at the lowest energy level or stable equilibrium state. The crystalline state has a defined molecular arrangement in the long-range order (Figure 17.1). The molecules in crystalline form are tightly packed; therefore, only radical or functional molecular groups on the external surface of the crystals can interact with external materials such as water (absorption). Powders in the crystalline state are the most stable. No caking occurs unless the surface of the crystals dissolves due to a high-humidity environment.

### 17.2.2 Amorphous Structure

The majority of the processed dried foods exist in amorphous form. Thermodynamically, the amorphous state is at a higher entropy level than the corresponding crystals. Molecules in this state are nonaligned, tangled, more open, and porous. Amorphous solid may also possess short-range order and regions of high and low densities (Figure 17.1) and have higher entropy than the corresponding crystals. Since an amorphous state is at a high energy level, it can undergo crystallization to achieve equilibrium. Amorphous powders are most prone to stickiness and caking.

### 17.2.3 Mixed Structure

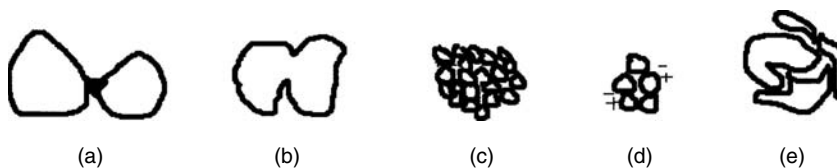
Mixed structure dried foods (coexistence of amorphous and crystalline structure) have both amorphous and crystalline regions. Mixed structure occurs during processing, such as partial crystallization or by grinding the crystalline structure. These powders are also prone to stickiness and caking due to the presence of amorphous structure.



**FIGURE 17.1** Schematic representation of crystalline and amorphous molecular structure. (From Bhandari, B.R. and Hartel, R.W., 2005, In *Encapsulated and Powdered Foods*, Ed. C. Onwulata, New York: Taylor and Francis, pp. 261–291.)

## 17.3 Stickiness of Food Solids

Stickiness of foods is generally an undesirable property. This can cause difficulty in processing, handling, mixing, and storage of food materials. In certain food processing situations, such as in agglomeration and coating, the same property can be useful. Stickiness relates to both cohesiveness within the same food material and adhesiveness to different material. Since stickiness is a surface property, the surface energy of both similar and dissimilar materials will play a role.



**FIGURE 17.2** Schematic diagram of interparticulate cohesive forces. (a) Liquid bridges (b) solid bridges (c) van der Waals forces (d) electrostatic forces and (e) mechanical interlocking.

### 17.3.1 Cohesive Forces and Stickiness

The various interparticulate cohesive forces (Figure 17.2) involved in stickiness are

- Liquid bridges
- Solid bridges
- van der Waals forces
- Electrostatic forces
- Mechanical interlocking

#### 17.3.1.1 Liquid Bridges

Liquid bridges are produced due to melting, wetting, and dissolution of the external surface of the particles or release of mobile liquid components from the interior of the particles (Figure 17.2a). This type of cohesion is mainly dominated by the surface tension and capillary properties. For example, during rewetting of the particles in an agglomeration process, there is a flow of liquid between two adjacent particles. On removal of solvent (such as water), the mobile liquid bridges turn into solid bridges. However, this type of solid bond can be fragile due to the narrowness of the bridge. The presence of low-melting point-components (such as oil) will also result in liquid bridges. This type of nonaqueous bonds is weak due to the noncompatibility with other solids present in the powder. The powder flow is adversely affected by the presence of liquid bridges. Many high fat powders do not flow well for this reason. Solidification of these liquid bridges due to temperature fluctuation makes the bond stronger.

#### 17.3.1.2 Solid Bridges

Solid bridges between the particles are formed by melting and solidifying (sintering), and crystallization of dissolved solids (Figure 17.2b). The interparticulate contact area is large and the strength of the agglomerate is high. Lowering of the temperature of the powder converts the liquid bridges into solid bridges. In some powders such as milk powders or high-sugar powders, this type of bond is so strong that it will need a hammer to break the lump.

#### 17.3.1.3 van der Waals Forces

All molecules possess weak attraction forces at very close distances. This is due to the electrostatic attraction of the nuclei of one molecule to the electrons of the other. This may result in polarization of the molecules at the surface. Fine powder particles (<1  $\mu\text{m}$  in size), which have very small interparticulate space, tend to stick to each other due to this force (Figure 17.2c). The oscillation of the molecules and vibration of the bonds may also cause such attractions due to facilitation of the alignment of the positive and negative forces. When the force of gravity (e.g., larger particles) is larger than the van der Waals forces, the particles do not show such cohesive behavior. Generally, high-molecular-weight materials having more electrons tend to be more cohesive. The fundamental mechanism of the van der Waals forces is electrostatic in nature [2]. This type of stickiness will be common in submicron or nanoparticles. Deposition of fine powders into the dryer wall, equipment surfaces, and room walls is the result of van der Waals forces. This force is relatively weaker and therefore can be broken easily. However, owing to close proximity and minimum interparticulate space, this force accelerates other type of caking.

### 17.3.1.4 Electrostatic Forces

There is normally confusion over electrostatic forces and van der Waals forces. The van der Waals is a short-range force, whereas the electrostatic is a long-range force. The fine particles can have some excess electrons due to friction. If these excess electrons are not dissipated (due to low conductivity), the electron-rich particles can realign themselves with electron-poor (oppositely charged) particles to balance the charge (Figure 17.2d). This results in cohesion or adhesion of particles. In fact, van der Waals forces and electrostatic forces act in combination in the case of cohesion/adhesion of fine powders [2].

### 17.3.1.5 Mechanical Interlocking

This occurs due to the irregular and uneven shape and size of the particles (Figure 17.2e). The fibrous, bulky, and flaky particles will interlock with each other or “bird nest” [3]. Under compaction or vibration, particles will reposition and become more entangled. On heating, wetting, and drying, these physical bonds can become very strong.

The energy of interactions between particles depends on the type of material, moisture content, size, and shape of the particles and external electrical field. In general, the solid bridges are stronger than the liquid bridges. The van der Waals forces are the weakest one and their dominance is high when particles are very small and gravitational effect becomes nominal. The interlocking energy depends on the surface roughness of the particles and the amount of distortion and packing. Barbosa and Juliano [4] compiled some information on the energy of binding of various forces (Table 17.2).

## 17.3.2 Adhesive Forces and Surface Energetics

As stated earlier, stickiness is related to both cohesion to similar and adhesion to dissimilar surfaces. In the case of adhesion of food particulates in different surfaces, it is influenced by the adhesive balance between contacting surfaces. In fact, the stickiness property is directly related to the interfacial surface energy of contacting materials. Adhesion of fine particles to dissimilar surfaces is also influenced by their electrostatic charges and the electric conductivity of the contact surface.

In some food processing situations, food adhesion can be of significant concern, particularly in the case of foods that are more adhesive than others. One of the important processes where stickiness has been an issue is drying of high-sugar and high-fat products [5,6]. This causes difficulties in drying equipment design and in processing resulting in frequent down time and high losses of product that sticks onto the equipment surfaces. Several research and review papers have been published in this regard. However, inadequate focus has been given to both the interfacial and interphase surface energies that contribute to stickiness.

The wetting of the solid surface is related to the surface energy of adhesive and adherend (also called substrate). If the liquid wets the surface, it will spread out on the solid surface. If the adhesive has low energy levels or low surface tension, it is absorbed by high-energy level solids; the contact angle decreases and the wetting is effective. If the surface of the solids has lower energy, the contact angle is high and the wetting is poor. In other words, to achieve wetting, the surface energy of the solid material should be higher than that of the liquid. The surface energy of various solid materials is listed in Table 17.3. Similarly, the surface energy of some liquids is presented in Table 17.4. Normally, inorganic materials have higher surface energy than organic materials; this means that organic materials have poor wettability (fewer tendencies to cause sticking of materials). Metals have high surface energy; therefore, materials tend to stick more on a metal surface. Polymers have low surface energy and therefore are difficult to be wetted. One polymer, Teflon, has very low surface energy. Since water is a very high-energy material (Table 17.4) and Teflon has a very low surface energy (Table 17.3), these events are energetically incompatible; therefore,

TABLE 17.2

Dissociation Energy of Particle–Particle Cohesion

Interparticulate Forces	Dissociation Energy
Liquid bridges	Dependent on the composition of powder
Solid bridges	200–800 kJ/mol
van der Waals forces	4–40 kJ/mol
Electrostatic forces	Dependent on the particle surface, shape, external electric field, and prehistory
Mechanical interlocking	Variable depending on shape, bulkiness, and flakiness

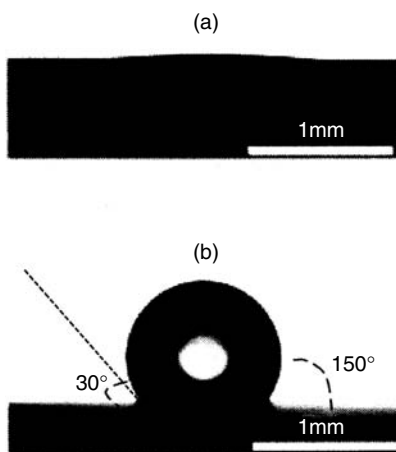
Source: Barbosa-Canovas, G.V. and Juliano, P., 2005, In *Encapsulated and Powdered Foods*, Ed. C. Onwulata, New York: Taylor and Francis, pp. 39–74.

TABLE 17.3

Surface Wetting Tension of Various Solid Materials

Surface	Wetting Tension (mN/m)
Polytetrafluoroethylene (Teflon)	18
Polydimethyl siloxane (silicone)	21
Polyethylene	31
Polystyrene	33
Polyvinyl chloride	39
Cured epoxy resin	43
Polyethylene terephthalate (PET)	43
Nylon-6,6	46
Stainless steel	71
Aluminum	90
Soda glass	65

Source: Pocius, A.V., 2002, *Adhesion and Adhesives Technology*, 2nd ed. Ohio: Hanser Gardner Publications, Inc.



**FIGURE 17.3** Nanoparticles coating results in low surface energy self-cleaning surface, water droplets on the surface: (a) with nonfluorinated nanostructured  $\text{TiO}_2$  coating; and (b) with nanostructured fluorinated  $\text{TiO}_2$  coating that gives a contact angle of the water drop around  $150^\circ$ . (From Burmeister, F. et al., *Surface and Coatings Technology* 200(4,6): 1555–1559.)

lent-glucose syrups, etc. Spray drying is the liquid food drying method where stickiness has most commonly been a major issue. The powder may deposit on the wall or blockage may occur in the duct or cyclone. In spray drying, the stickiness is not purely demonstrated by adhesion onto the dryer wall. At the accumulation stage, the cohesive force between the particles can play a role since the wall can be completely covered with the material. It is important to avoid the early stage of adhesion, which can act as a seed for further accumulation of underdried or sticky particles.

The concentration of solutes during drying can increase the surface tension, but the most influential factor is the rapid increase in viscosity. The increased viscosity results in increased time required to wet the wall because of the high resistance to flow. Thus, the stickiness mechanism involves both the viscous flow of the droplets and surface energy of droplets and dryer wall [10]. Once the product (as droplets) is in contact with the system, the liquid flow will be dictated by the surface tension or energy of the system. The liquid bridge between dryer wall/product (adhesion) and product/product (cohesion) will occur as a function of time. If the contact area is very small and the drying continues, the dried particles may be carried

TABLE 17.4

Surface Energy of Some Liquids

Liquid	Surface Energy (mN/m) at $25^\circ\text{C}$
Water	72
Epoxy resin	43
Glycerol	63
Ethylene glycol	47
<i>n</i> -Hexane	18
Benzene	28.9
Nitrobenzene	43.9

Source: Pocius, A.V., 2002, *Adhesion and Adhesives Technology*, 2nd ed. Ohio: Hanser Gardner Publications, Inc.

the wetting angle is very large. Currently, the drive in nanoparticle technology has been to manufacture an ultrahydrophobic surface with very low energy level that can be nonadhesive and self-cleaning [7,8]. An example is presented in Figure 17.3, which shows the effect of surface coating with nanostructured fluorinated and non-fluorinated  $\text{TiO}_2$ . The coating with the former nanomaterial rendered a contact angle of  $150^\circ$  [8]. A surface with more than  $150^\circ$  water droplet contact angle has ultrahydrophobic, self-cleaning, and nonsticky properties. In the future, this material will have a greater application in the food and powder-processing (such as drying) industries handling sticky products.

### 17.3.3 Occurrence of Cohesion and Adhesion during Drying

Stickiness is encountered during drying and handling of some key dried food materials such as whey, lactose, protein hydrolysate, high-fat milk, fruit juices, honey, high-dextrose-equiva-

away from the wall. To reduce the contact area, it is important that the wall material has a low surface energy. In many drying situations, stainless steel is used as the wall material because of its durability and ease of cleaning, and for hygiene, but this metal has a high surface energy (Table 17.3). Teflon (PTFE) has been found to be very useful in the handling and processing of food materials due to its extremely low surface energy (18 mN/m), relative inertness, high tensile strength, and thermal stability. There are many other polymeric materials, which are hydrophobic and also have a low surface energy level. Owing to their poor physical and thermal stability, and possible interaction with the food components, they are not used in many food processing situations, particularly in high-temperature drying processes.

Many studies have sought to relate stickiness to the glass transition property of a drying food material. The glass transition normally signifies conversion of amorphous solid (or glass) into a rubbery state. In surface energy terms, a solid glass will have low surface energy and will not stick to any other low-energy solid surfaces. Owing to the transition from glass to rubbery (or liquid) state, the surface energy of the material increases and the molecules start interacting with the solid surface. In a food drying operation, the product is in a liquid or rubbery state and due to the removal of plasticizer (water) the liquid/rubbery food is converted into the glassy state. If the food material does not go through the transition due to a higher drying temperature than the glass transition temperature, the product will remain in a high-energy sticky state. If this food comes in contact with a high-energy solid surface, it will stick or cling to it [1].

The issue of adhesive/cohesive force is also important in the case of fluidized bed dryers handling pasty or solid particulates. The development of cohesive forces resulting from interparticulate liquid bridges can make the operation complex in fluidized and spouted beds [11]. The surface energy of dried or semidried particles can also be influenced by the electrostatic energy generated during their movement. Ciborowski and Wlodarski [12] reported the occurrence of electrical forces in fluidized beds. They found that electric charges that accumulate on solid particles might cause the adhesion of a layer of solid particles to the walls of the fluidizing equipment, the agglomeration of particles into larger aggregates, and the change of a fluidized bed into a channeling bed. Machowski and Balachandran [13] also stated that cohesive powders are generally much more difficult to transport due to short-range molecular forces (van der Waals) as well as electrostatic forces that cause agglomeration and adhesion of particles impeding the flow. The surface energetics of particulates and binding agents is also a very important factor in the agglomeration process applied to instantize dry food powders.

### 17.3.4 Stickiness Testing Methods for Powders

#### 17.3.4.1 Testing for Cohesion

##### 17.3.4.1.1 Propeller-Driven Method

Originally developed by Lazar et al. [14], this method has been used by several researchers with or without modifications to evaluate the effects of temperature on powder stickiness (Figure 17.4). The tester basically comprises a test tube containing powder with known moisture content. The test tube is immersed in a water bath. A machine-driven impeller stirs the powder. When the temperature of the powder is slowly raised by increasing the temperature of the water bath, at the sticky point a maximum force of stirring is recorded. As a search for a simpler and more efficient technique, Ozkan et al. [15] developed a viscometry technique based on the measurement of the torque required to turn a propeller inserted into powders.

##### 17.3.4.1.2 Optical Probe Method

A method based on the changes in the optical properties of a free-flowing powder was reported by Lockemann [16]. The motion of the powder in a constantly rotating tube is observed with a fiber-optic sensor (Figure 17.5). The tube and sensor are all immersed in an oil bath to maintain the temperature. A sharp rise in reflectance of a freely flowing powder is observed at its sticky point.

##### 17.3.4.1.3 Blow Test

Paterson et al. [17] attempted to develop a blow test for measuring the stickiness of powders (Figure 17.6). This method measures the velocity of air needed to blow a channel into a packed bed of

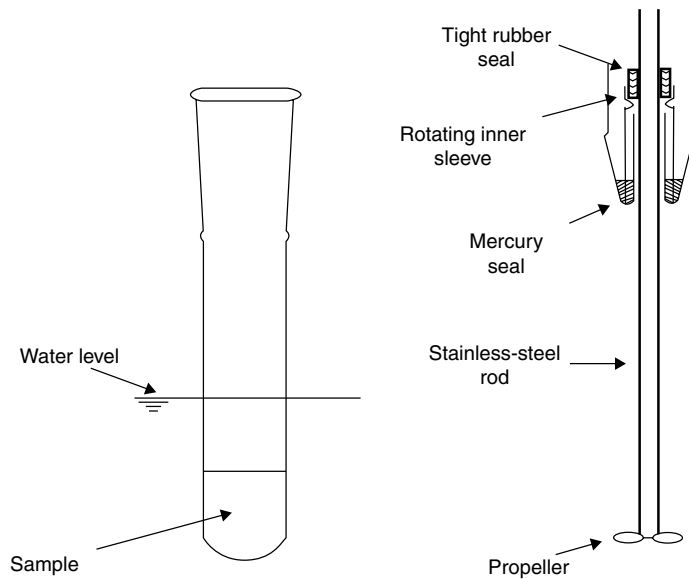


FIGURE 17.4 An early stickiness measuring device. (From Lazar, M.E. et al., 1956, *Food Technology* March: 129–134.)

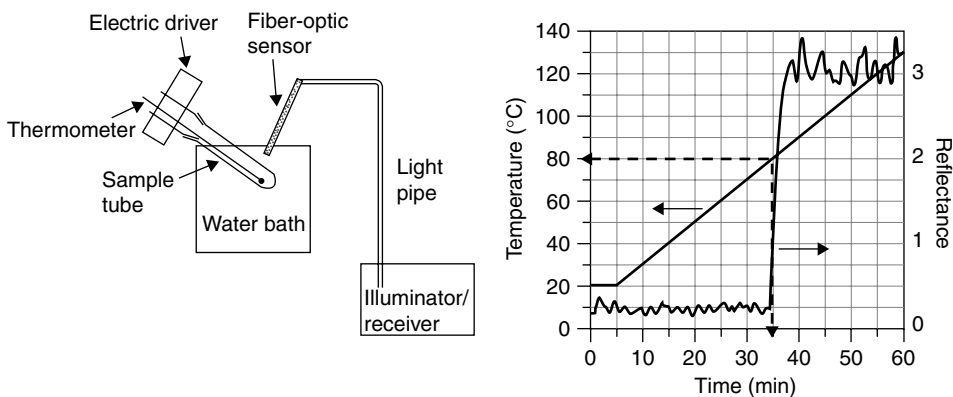


FIGURE 17.5 A stickiness device using an optical probe. (From Lockemann, C.A., 1999, *Chemical Engineering and Processing* 38: 301–306.)

powder and the stickiness of powder is classified based on the air velocity range. The apparatus consists of a multisegmented circular distributor (sample holder) where the preconditioned sample is packed in the distributor.

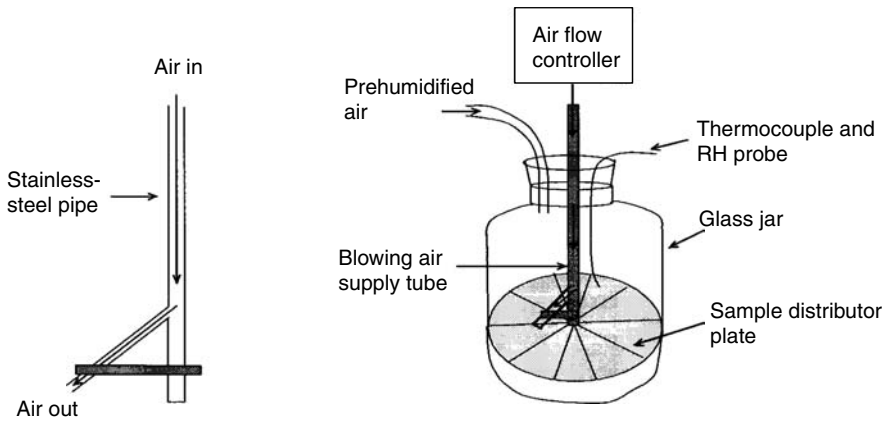
#### 17.3.4.1.4 Fluidization Method

Bloore [18] described a small fluidized bed setup to study the stickiness property of powder at different humidity and temperature conditions (Figure 17.7). The positive point of this method as compared to other tests is that the particulates are in a dynamic condition, which is closer to the spray drying and fluidized bed drying situations.

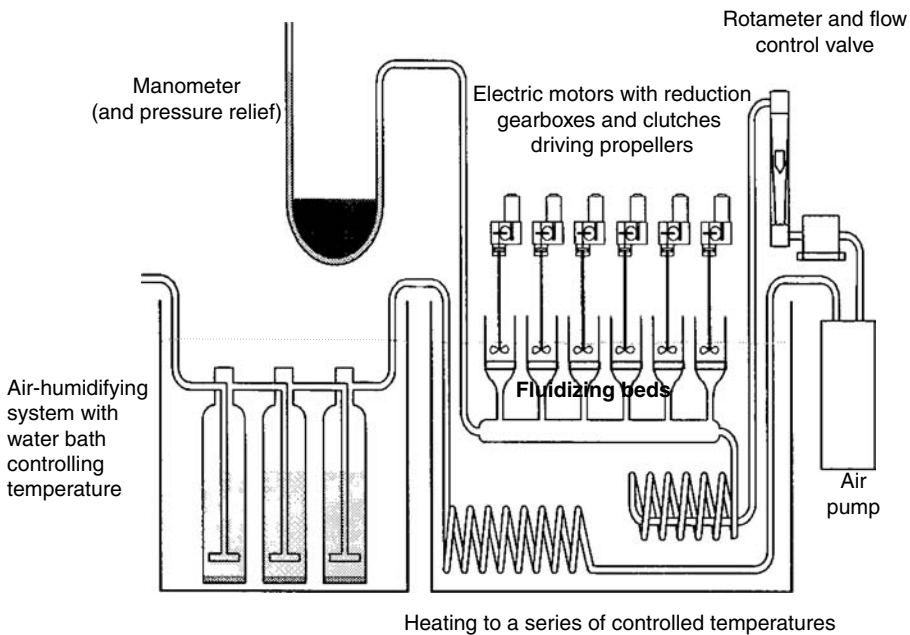
#### 17.3.4.1.5 Cyclone Method

A cyclone technique (previously conceptualized and developed by Bhandari and Howes at The University of Queensland, Brisbane, Australia) is described by Boonyai et al. [19] and used to



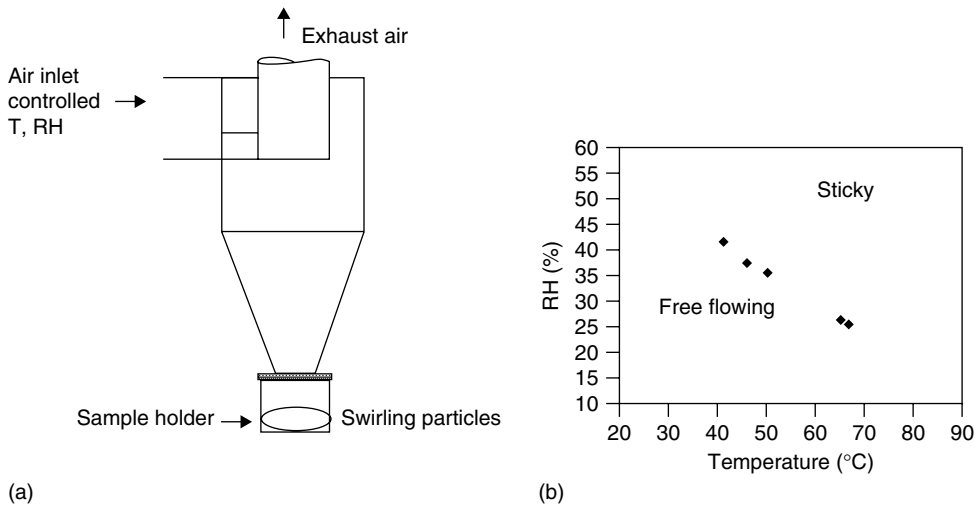


**FIGURE 17.6** Blow test to measure the stickiness property of powders. (From Paterson et al., 2001, The Blow Test for measuring the stickiness of powders, *Conference of Food Engineering 2001*, AIChE Conference, Reno, NV, November 4–9, pp. 408–414.)

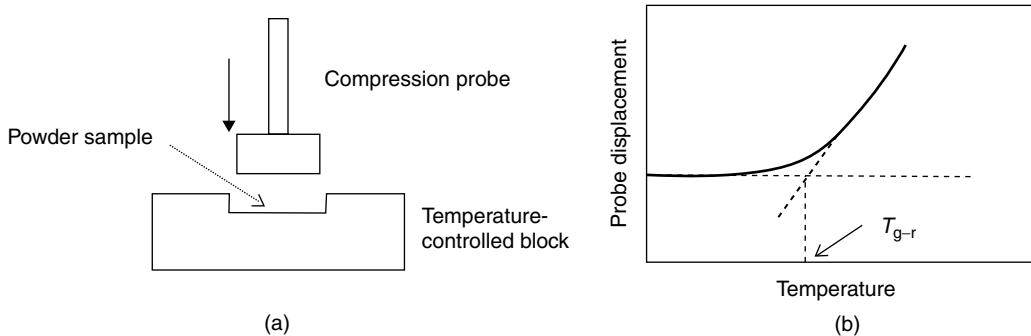


**FIGURE 17.7** Fluidized bed stickiness testing device. (From Bloore, C., 2000, Development in food drying technology—overview. International Food Dehydration Conference—2000 and Beyond, Food Science Australia, Melbourne, pp. 1.1–1.5.)

investigate stickiness behavior of food powders as a function of temperature and moisture conditions, simulating the dynamic condition in a spray-drying system (Figure 17.8). The powder particles are individually in contact with a preconditioned air stream, and hence a rapid simultaneous heat and moisture transfer occurs at the surface. The cyclone consists of a detachable sample holder at the bottom. A few grams of sample is put in the sample holder for the test. Stickiness is observed within 1–2 min when particles become cohesive and stick to each other and some adhere to the chamber wall due to adhesive force. If a longer time is allowed, all particles become completely immobilized. The testing time may also depend on hygroscopicity of the material and particle size.



**FIGURE 17.8** (a) Design of the cyclone chamber and sample holder; (b) stickiness curve of skim milk powder as a function of temperature and relative humidity measured using cyclone setup. (From Bhandari, B.R. and Hartel, R.W., 2005, In *Encapsulated and Powdered Foods*, Ed. C. Onwulata, New York: Taylor and Francis, pp. 261–291.)



**FIGURE 17.9** (a) Principles of measurement of stickiness of powder by thermal mechanical compression test (TMCT) method; (b)  $T_{g-r}$  indicates glass–rubber transition when the powder is scanned through temperature.

#### 17.3.4.1.6 Thermal Mechanical Compression Test Method

The thermal mechanical compression test (TMCT) method assumes that the critical point of stickiness of powders is at their rubbery state. During drying, the product is progressively transformed from liquid to rubbery and to glassy states. The product at the glassy state is totally solid in behavior and is not sticky. If the powder is not converted into the glassy solid state from the rubbery state during drying, it will exhibit stickiness behavior (both adhesive and cohesive in nature). The reversible conversion from rubbery to glassy or vice versa is called glass transition temperature ( $T_g$ ). The stickiness will occur when the powder glass transition temperature is below the outlet air temperature in the dryer. A common technique to measure  $T_g$  is differential scanning calorimeter (DSC). Since this technique is expensive and also requires expensive consumables (such as an aluminum pan), a simple technique called thermal mechanical compression test method was conceptualized and developed by Bhandari and Howes at The University of Queensland, Brisbane, Australia. This TMCT technique measures the phase change of a material based on mechanical changes during the transition (Figure 17.9a). The powder sample is axially compressed at constant pressure (1–3 kg/cm<sup>2</sup>) until equilibrium and temperature scanned in creep mode in a texture analyser (such as TA.XT2). When the powder reaches its glass transition temperature, the probe displacement takes place and this point is considered as the stickiness point of that particular sample as depicted in Figure 17.9b [20]. In dynamic and very short contact time situations, the stickiness usually occurs at 10°C–20°C above the measured glass transition temperature.

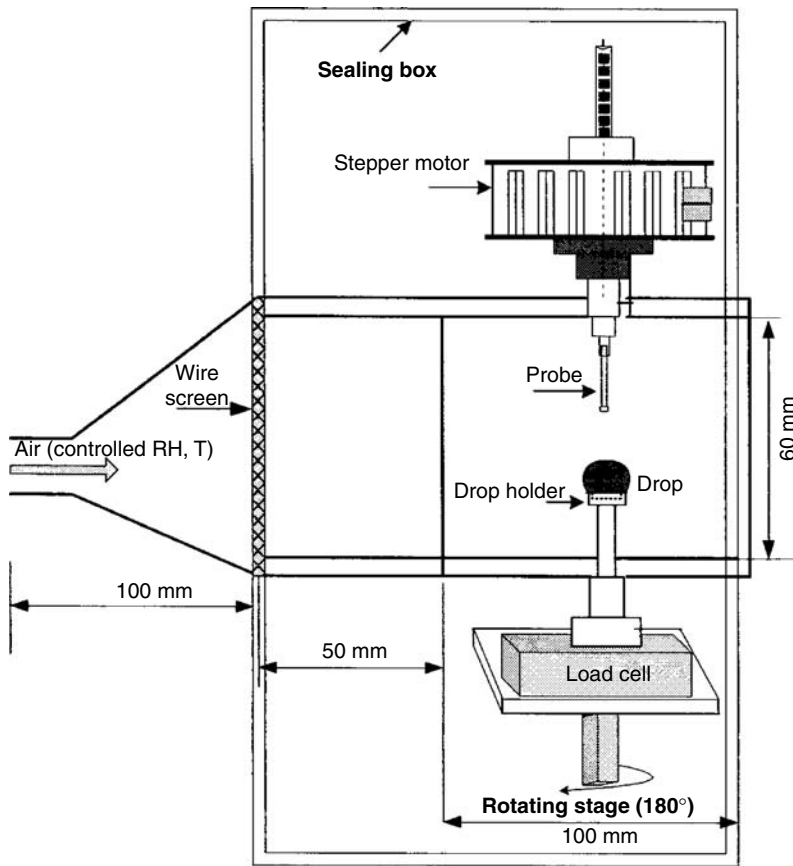


FIGURE 17.10 *In situ* stickiness testing device for a drying droplet.

#### 17.3.4.2 Testing for Adhesion

The surface properties of a droplet, such as film formation and dried wall material properties, can greatly influence stickiness. The film formation property once again is a function of drying conditions. Adhikari et al. [21] developed a rig for testing the *in situ* stickiness behavior of a drying droplet (Figure 17.10). There are two set-ups in this rig—one for measuring stickiness and the other for studying drying kinetics. Both the set-ups are housed inside a glass chamber supplied with hot air with controlled flow, temperature, and humidity. The linear actuator with an appropriate step size is used to achieve the forward and backward movements of the probe. The probe surface is made up of various materials (e.g., glass, stainless steel, Teflon, and polyurethane). The tensile and compression force during stickiness testing and air temperature is continuously logged. The temperature history of the sample is recorded using microthermocouples. The image of bonding, debonding, and failure modes during the testing is recorded using a color camera and recorded on a personal computer through a frame-grabbing card. The same image-capturing system is also used to monitor the drying droplet.

### 17.4 Caking of Powders

Stickiness is the preliminary stage of caking. In general, stickiness is an instantaneous phenomenon, while caking occurs over time. As mentioned previously, all amorphous products are metastable and therefore can potentially crystallize (for crystallizing species) during storage. The amorphous state is most vulnerable to caking. The crystalline state is less prone to caking; however, the presence of an amorphous glassy layer around the crystal, dissolution of the outer surface of the crystal due to

TABLE 17.5

Process and Product Characteristics Influencing Caking Behavior of Dried Foods (Powder)

Factors	Specific Details
Processing condition	Melting or dissolution of components in the powder due to high-temperature processing or moisture addition
Microstructure	Extent of amorphous structure, very low average particle size (increased van der Waals attraction due to large surface area)
Product composition	Presence of liquid components at room temperature (such as oil, organic acids), presence of highly hygroscopic component, usually low molecular weight sugars, polyols, or organic acids
Storage condition	High humidity and temperature conditions causing melting and solidifying, glass-rubber transition, or crystallization of part or all the components, powder consolidation due to overload

moisture absorption, and compaction can provoke caking of crystalline powder too. Longer contact times increase the tendency toward sticking and caking, all other things being equal. Thus, a dried product with a relatively free-flowing property immediately after drying could also cake in a collection or packaging container over a period of time if the surface viscosity is still relatively low due to higher temperature or moisture levels. For this reason, the dried product needs to be cooled immediately to an appropriate temperature before packaging. Temperature changes and moisture migration in the bags during travel through different climate zones and consolidation pressure can cause undesirable caking in the powders [15]. The moisture fluctuations during day and night (or during shipment) also result in internal moisture migration in bulk solids due to the vapor pressure differentials in cold and hot conditions. This temperature fluctuation at the outer surface of packaging can be as high as 25°C in some climate. Owing to the lack of conductivity of heat of the solids and cyclic heating and cooling, there is a formation of crust at the surface of the bulk powder. As stated earlier, the amorphous powders are most prone to cake due to their high hygroscopicity. Crystalline powder can also cake due to surface dissolution and recrystallization. Mixed powders (coexisting amorphous and crystalline structure) have mixed tendency to cake. Various factors that influence the caking behavior of powder are depicted in Table 17.5.

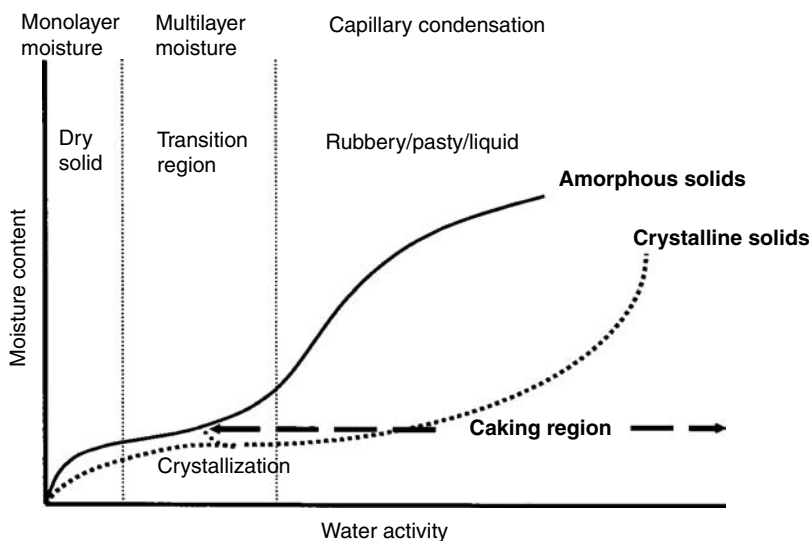
#### 17.4.1 Factors Responsible for Caking

The four major causes of caking are

- Presence of liquid component
- Moisture absorption
- Crystallization
- Consolidation

##### 17.4.1.1 Presence of Liquid Component

Some of the food components can be in liquid state such as fat in milk powder, oil in microencapsulated flavor powders, or viscous juice in dried fruits (such as raisins). In powder, such liquid state should be in discontinuous phase, so to be encapsulated by the solid continuous phase. However, leaching or breaking the structure can cause release and coalescence of such liquid at the surface of particles. This results in particles sticking together. This is manifested by decreased flowability and sluggish behavior of powder. Free fat/oil in the powders causes caking, but the cakes are not as strongly held together as in the case of caking as a result of other factors such as lactose crystallization in milk powder during storage. The increased temperature can also result in melting of the solid phase (fat to oil) or state change (glassy to rubbery), consequently resulting in caking of powder.



**FIGURE 17.11** Indicative graph of water sorption isotherm of amorphous, crystalline, or crystallizing solids and their relationship to caking.

#### 17.4.1.2 Moisture Absorption

Water absorption by the powder can cause dissolution of outer surface of the crystals or particles or condensation of the capillary moisture in amorphous material (Figure 17.11). This eventually creates a liquid bridge. Upon dehydration, these liquid bridges are converted into strong solid bridges. The distance between the particles and hygroscopic property of the particle components will influence the rate of caking. The higher the compactness of the particles and the finer the particles, the faster will be the caking.

#### 17.4.1.3 Crystallization

Crystallization is also encouraged by water absorption by amorphous powder (Figure 17.11). The extent of water absorption by powder depends on its sorption property. If a local portion of the product in a package picks up moisture, the glass transition temperature is locally depressed for that particular portion and the crystallization rate at that spot is accelerated. Formation of the lattice during crystallization generally excludes water molecules and the excess moisture is lost to the environment. Absorption of this ejected moisture at the surface of neighboring particles creates interparticulate liquid bridges resulting in “caking” [22]. Surrounding particles that absorb moisture are also crystallized and crystallization proceeds as a chain phenomenon. Crystallization of sugars is delayed by other ingredients present in the concentrated powder system by the same mechanism as in the supersaturated solution [23,24]. The crystallization process rejects impurities including volatiles. Senoussi et al. [25] found a loss of diacetyl as a function of rate of crystallization of lactose during storage. They found that when the lactose was stored at 20°C above  $T_g$ , the amorphous product went through immediate crystallization, and practically all diacetyl was lost after 6 days. Levi and Karel [26] also found an increased rate of loss of a volatile, 1-*n*-propanol, in an amorphous sucrose system as a result of crystallization.

#### 17.4.1.4 Consolidation

Consolidation or compression of powders decreases the distance between the particles, consequently van der Waals and other forces become predominant. This results in caking. This is more important if the powders are fine or brittle or break due to the compression force. The filling of the voids during compression, absorption of the moisture, leakage of liquid fraction, particle shape and size, and increased bulk density will contribute to caking during compression [27]. In some cases this is desirable, such as during tableting where the binders are sometimes added in some powders to increase the tensile strength

of the tablets. In the food situation, caking of the powder at the bottom of the stack is a commonly observed problem due to high consolidation force.

### 17.4.2 Measurements of Degree of Caking

There are various methods employed to characterize the degree of caking by analyzing the change in the basic properties of the powders, such as flowability, angle of repose, interparticulate cohesion, size distribution, and particle morphology (Table 17.6). Among all these techniques, microscopic observation and measurement of the increased size of the particles (indicated by the caking index) are the most appropriate methods.

### 17.4.3 Anticaking Agents

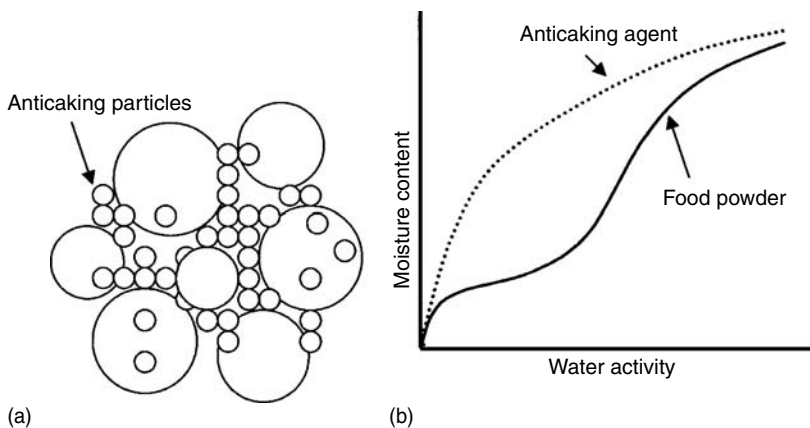
Anticaking agents prevent the powder particles from sticking together. These agents are natural, inert, and bland in taste. Normally, the anticaking agents are very fine powders (1–5  $\mu\text{m}$ ). Owing to their smaller size, they tend to stick and coat bigger particles and separate two surfaces likely to adhere together (Figure 17.12a). A similar process is applied in dry coating of particles [29]. The van der Waals and electrostatic forces are responsible for sticking of fine particles to the bigger one. Anticaking powders have more surface area per unit weight; therefore, they absorb moisture faster than the actual powder. They have the capacity of absorbing a large amount of water without exhibiting stickiness property (Figure 17.12b). They can be inorganic and organic products. The inorganic powders are calcium and magnesium phosphates, aluminum, calcium, sodium, magnesium, potassium, and ammonium salts of fatty acids, magnesium oxide, silicon dioxide (amorphous), calcium, aluminum, potassium and magnesium silicates or talc, bentonite (clay), polydimethylsiloxane or dimethylpolysiloxane, etc.

**TABLE 17.6**

Methods Employed to Measure the Degree of Caking

Method	Principle
Flowability	Discharge mass flow rate from a bin or funnel
Angle of repose	Heap angle along the horizontal plane ( $<40^\circ$ for free-flowing powder)
Cohesion	Negligible shear stress for a free-flowing powder (Jenike shear cell method)
Caking index	Weight fraction retained by a mesh with an opening size of maximum particle size of the powder
Microscopical attributes	Ratio of interparticulate bridge diameter to particle diameter (microscopic techniques)

Source: Aguilera, J.M. et al., 1995, *Trends in Food Science and Technology* 6: 149–155.



**FIGURE 17.12** (a) Schematic representation of finer anticaking particles incorporated into larger particles and (b) sorption isotherm property of anti-caking agents.

These inorganic anticaking agents are mostly used in dairy powders and salts. The organic anticaking agents are microcrystalline cellulose, isomalt, fruit and vegetable fibers, corn starch, cereal (corn, rice) starches, vegetable oil, etc. These agents are widely used in fine icing sugars, shredded cheese products, dried fruit pieces, and fruit leathers. The level of addition of anticaking agents is normally less than 1% and should comply with good manufacturing practice (GMP). Criteria for GMP are that the quantity shall be at the lowest level possible, not intended to accomplish any physical or technical effect in the food itself, and prepared and handled the same way as the food ingredient.

---

## References

1. Bhandari, B.R. and Hartel, R.W., 2005, Phase transitions during food powder production and powder stability, In *Encapsulated and Powdered Foods*, Ed. C. Onwulata, New York: Taylor and Francis, pp. 261–291.
2. Feng, Q.J. and Hays, D.A., 2003, Relative importance of electrostatic forces on powder particles, *Powder Technology* 135–136: 65–75.
3. Barbosa-Canovas, G.V., Ortega-Rivas, E., Juliano, P. and Yan, H., 2005, *Food Powders, Physical Properties, Processing, and Functionality*, New York: Kluwer Academic/Plenum Publishers.
4. Barbosa-Canovas, G.V. and Juliano, P., 2005, Physical and chemical properties of food powders, In *Encapsulated and Powdered Foods*, Ed. C. Onwulata, New York: Taylor and Francis, pp. 39–74.
5. Bhandari, B.R., Datta, N. and Howes, T., 1997, Problems associated with spray drying of sugar-rich foods, *Drying Technology* 15(2): 671–684.
6. Papadakis, S.E. and Bahu, R.E., 1992, The sticky issues of drying, *Drying Technology* 10(4): 817–837.
7. Ren, S., Yang, S., Zhao, Y., Yu, T. and Xiao, X., 2003, Preparation and characterization of an ultrahydrophobic surface based on a stearic acid self-assembled monolayer over polyethyleneimine thin films, *Surface Science* 546(2–3): 64–74.
8. Burmeister, F., Kohn, C., Kuebler, R., Kleer, G., Bläsi, B. and Gombert, A., 2005, Applications for TiAlN- and TiO<sub>2</sub>-coatings with nanoscale surface topographies, *Surface and Coatings Technology* 200(4,6): 1555–1559.
9. Pocius, A.V., 2002, *Adhesion and Adhesives Technology*, 2nd ed. Ohio: Hanser Gardner Publications, Inc.
10. Bhandari, B.R. and Howes, T., 2005, Relating the stickiness property of foods undergoing drying and dried products to their surface energetics, *Drying Technology* 23(4): 781–797.
11. Passos, M.L. and Mujumdar, A.S., 2000, Effect of cohesive forces on fluidized and spouted beds of wet particles, *Powder Technology* 110(3): 222–238.
12. Ciborowski, J. and Wlodarski, A., 1962, On electrostatic effects in fluidized beds, *Chemical Engineering Science* 17: 23–32.
13. Machowski, W. and Balachandran, W., 1998, Dispersion and transport of cohesive lactose powder using traveling wave field technique, *Powder Technology* 99(3): 251–256.
14. Lazar, M.E., Brown, A.H., Smith, G.S., Wang, F.F. and Lindquist, F.E., 1956, Experimental production of tomato powder by spray drying, *Food Technology* March: 129–134.
15. Ozkan, N., Walisinghe, N. and Chen, X.D., 2002, Characterization of stickiness and cake formation in whole and skim milk powders, *Journal of Food Engineering* 55(4): 293–303.
16. Lockemann, C.A., 1999, A new laboratory method to characterize the sticking properties of free-flowing solids, *Chemical Engineering and Processing* 38: 301–306.
17. Paterson, A.H.J., Bronlund, J.E. and Brooks, G.F., 2001, The Blow Test for measuring the stickiness of powders, Conference of Food Engineering 2001, AIChE Conference, Reno, NV, November 4–9, pp. 408–414.
18. Bloore, C., 2000, Development in food drying technology—overview. International Food Dehydration Conference—2000 and Beyond, Food Science Australia, Melbourne, pp. 1.1–1.5.
19. Boonyai, P., Bhandari, B. and Howes, T., 2004, Measurement of glass-rubber transition of skim milk powder by static mechanical test, *Drying Technology* 23: 1499–1514.
20. Boonyai, P., 2005, Stickiness of solid particulate food materials, PhD Thesis. The University of Queensland, Brisbane, Australia.
21. Adhikari, B., Howes, T., Bhandari, B.R. and Truong, V., 2003, In situ characterization of stickiness of sugar-rich foods using a linear actuator driven stickiness testing device, *Journal of Food Engineering* 58(1): 11–22.

22. Peleg, M. and Hollenbach, A.M., 1984, Flow conditioners and anticaking agents, *Food Technology* March: 93–99.
23. Hartel, R.W., 2001, *Crystallization in Foods*, Gaithersburg, MD: Aspen Publishing.
24. Roos, Y. and Karel, M., 1991, Water and molecular weight effects on glass transitions in amorphous carbohydrates and carbohydrate solutions, *Journal of Food Science* 56(1): 1676–1681.
25. Senoussi, A., Dumoulin, E.D. and Berk, Z., 1995, Retention of diacetyl in milk during spray-drying and storage, *Journal of Food Science* 60(5): 894–905.
26. Levi, G. and Karel, M., 1995, Volumetric shrinkage (collapse) in freeze-dried carbohydrates above their glass transition temperature, *Food Research International* 28: 145–151.
27. Fitzpatrick, J.J., 2005, Food powder flowability, In *Encapsulated and Powdered Foods*, Ed. C. Onwulata, New York: Taylor and Francis, pp. 247–260.
28. Aguilera, J.M., de Valle, J.M. and Karel, M., 1995, Caking phenomenon in amorphous food powders, *Trends in Food Science and Technology* 6: 149–155.
29. Tenou, E. and Poncelet, D., 2005, Dry coating, In *Encapsulated and Powdered Foods*, Ed. C. Onwulata, New York: Taylor and Francis, pp. 179–196.





# 18

## *Drying and Food Preservation*

Mohammad Shafiur Rahman and Conrad O. Perera

### CONTENTS

18.1	Introduction .....	404
18.1.1	Background of Drying .....	404
18.1.2	Mode of Preservation .....	404
18.1.3	State of Water in Foods .....	404
18.1.4	End Point of Drying .....	405
18.1.5	Heating Methods in Drying .....	405
18.2	Drying Methods .....	405
18.3	Thermal Drying .....	405
18.3.1	Drying Fundamentals .....	405
18.3.1.1	Drying Curve .....	406
18.3.1.2	Energy Aspect of Air Drying .....	407
18.3.1.3	Energy Losses in Air Drying .....	407
18.3.2	Air-Drying Methods .....	408
18.3.2.1	Sun Drying .....	408
18.3.2.2	Solar Drying .....	408
18.3.2.3	In-Store Drying .....	408
18.3.2.4	Convection Air Drying .....	409
18.3.2.5	Explosive Puff Drying .....	409
18.3.2.6	Spray Drying .....	409
18.3.2.7	Fluidized Bed Drying .....	409
18.3.2.8	Spouted Bed Drying .....	409
18.3.2.9	Ball Drying .....	410
18.3.2.10	Rotary Drum Drying .....	410
18.3.2.11	Drum Drying .....	410
18.3.3	Low Air Environment Drying .....	410
18.3.3.1	Vacuum Drying .....	410
18.3.3.2	Freeze Drying .....	410
18.3.3.3	Heat Pump Drying .....	410
18.3.3.4	Superheated Steam Drying .....	413
18.3.3.5	Impingement Drying .....	414
18.3.3.6	Smoking .....	414
18.3.4	Modified Atmosphere Drying .....	415
18.4	Pretreatments .....	417
18.4.1	Blanching .....	417
18.4.2	Sulfur Dioxide Treatment .....	417
18.4.3	Salting or Curing .....	418
18.4.4	Other Dipping Pretreatments .....	418
18.4.5	Freezing Pretreatment .....	419
18.4.6	Cooking .....	419
18.5	Quality Changes During Drying .....	420
18.5.1	Selection of Variety .....	420
18.5.2	Microflora in Dried Foods .....	420

18.5.3	Browning Reactions .....	421
18.5.4	Lipid Oxidation .....	422
18.5.5	Changes in Proteins .....	422
18.5.6	Structural Changes .....	423
18.5.7	Case Hardening or Crust Formation .....	423
18.5.8	Shrinkage or Collapse and Pore Formation .....	424
18.5.9	Stress Development and Cracking or Breakage .....	424
18.5.10	Rehydration .....	425
18.5.11	Volatile Development or Retention .....	425
18.5.12	Solubility .....	425
18.5.13	Caking and Stickiness .....	426
18.5.14	Texture .....	426
18.5.15	Vitamins Retention.....	426
18.5.16	Color Retention or Development .....	426
References	.....	427

---

## **18.1 Introduction**

### **18.1.1 Background of Drying**

The preservation of foods by drying is the time-honored and most common method used by humans and the food processing industry. Dehydration of food is one of the most important achievements in human history, making humans less dependent upon a daily food supply even under adverse environmental conditions [34]. Though in earlier times drying was dependent on the sun, nowadays many types of sophisticated equipment and methods are used to dehydrate foods. During the past few decades, considerable efforts have been made to understand some of the chemical and biochemical changes that occur during dehydration, and develop methods for preventing undesirable quality losses. Foods can be divided into three broad groups based on the value added through processing by drying. In the case of cereals, legumes, and root crops, very little value is added per kilogram processed. More value per unit mass is added to foods such as vegetables, fruits, and fish; and considerably more to high-value crops such as spices, herbs, medicinal plants, nuts; bioactive materials; and enzymes [7].

### **18.1.2 Mode of Preservation**

Drying reduces the water activity, thus preserving foods by avoiding microbial growth and deteriorative chemical reactions. The effects of heat on microorganisms and the activity of enzymes are also important in the drying of foods. In the case of foods to be preserved by drying, it is important to maximize microorganism and enzyme inactivation for preventing spoilage and enhancing safety, and reduce the components responsible for the deterioration of the dried foods. Also, in the case of drying bacterial cultures, enzymes, or vitamins, minimum inactivation of the microorganism and enzyme is required. Thus, detrimental effects of drying may be desirable or undesirable, depending on the purpose of the drying process.

### **18.1.3 State of Water in Foods**

The terms dried and dehydrated are not synonymous. The U.S. Department of Agriculture lists dehydrated foods as those with no more than 2.5% water (dry basis), while the term dried foods applies to any food product with more than 2.5% water (dry basis) [144]. The concept of bound water and free water has been developed from drying principles, and it is important for dried products – for its stability during processing and storage. A product containing no water is termed as bone-dry. Water exists in foods in different forms or states. In foods, water having properties different from those of pure water can be defined as bound water. In the literature, different forms of bound water are defined [101], for example, unfreezable, immobile, monolayer, and nonsolvent water. However, the fraction of bound water depends on its definition and the measurement technique used [101]. The binding energy of different states of bound water affects the drying process, since it requires more energy to remove bound water than free water.

### 18.1.4 End Point of Drying

Equilibrium in drying system is the ultimate endpoint for the process. Water activity is commonly used to estimate the equilibrium point in the case of thermal- and osmotic-drying processes. In mechanical dewatering, the magnitude of the applied force and rheological properties of the foods affect the equilibrium point. Generally meat, fish, and dairy products are dehydrated to a moisture content of 3% or less, vegetable products usually to 5%, and cereal products frequently to as much as 12% [118]. A maximum moisture level is usually established for each dried product separately, based on the desired quality after drying and during storage. Different attributes of quality can be targeted; thus, the endpoint should be determined from all aspects, such as safety first and then consumer acceptance.

### 18.1.5 Heating Methods in Drying

Heating air using either an electric heater or flue gas is the conventional heating method used for drying foods. In this case, heat transfer from the gas to the product occurs mainly through convection. The heating method is another important aspect of drying, in terms of quality as well as energy cost. Microwave, infrared, radio frequency, refractance window, and dielectric heating use electromagnetic wavelength spectrum as a form of energy, which interacts with the materials, thus generating heat and increasing the drying rate dramatically. Dielectric drying uses frequencies in the range of 1–100 MHz, whereas microwave drying uses frequencies in the range of 300–300,000 MHz. Microwave heating is rapid, more uniform in the case of liquids, and more energy efficient than the hot-air method [28]. Applying microwave energy under vacuum affords the advantages of both vacuum drying and microwave drying, thereby providing improved energy efficiency and product quality. The energy can be applied in pulsed or continuous mode; however, pulsed microwave drying is more efficient than continuous drying. The use of electrotechnology in drying is gaining priority in the food industry to improve drying efficiency as well as quality.

---

## 18.2 Drying Methods

Drying processes can be broadly classified, based on the water-removing method applied, as (a) thermal drying, (b) osmotic dehydration, and (c) mechanical dewatering. In thermal drying, a gaseous or void medium is used to remove water from the material. Thus, thermal drying can be divided further into three types: (a) air drying, (b) low air environment drying, and (c) modified atmosphere drying. In osmotic dehydration, a solvent or solution is applied to remove water, whereas in mechanical dewatering physical force is used. Consideration should be given to many factors before selecting a drying process. These factors are (a) the type of product to be dried, (b) desired properties of the finished product, (c) allowable temperature tolerance, (d) the product's susceptibility to heat, (e) pretreatments required, (f) capital and processing costs, and (g) environmental factors. There is no one best technique of drying that is applicable for all products [25,144].

---

## 18.3 Thermal Drying

Thermal drying is one of the most widely used methods of drying foods. In this process, heat is mainly used to remove water from the foods. The mechanisms of moisture transfer depend mainly on the types or physicochemical state of food materials and the drying process. Food materials can be classified as (a) homogeneous gels, (b) porous materials with interconnecting pores or capillaries, and (c) materials having an outer skin that is the main barrier to moisture flow [27]. The type or structure of foods always plays an important role in the drying process.

### 18.3.1 Drying Fundamentals

In terms of transport phenomenon, it is considered as both heat and mass transport process inside and outside of the food materials. Hence there are two resistances: heat transfer and mass transfer. During the *constant rate period*, it is considered that there exists a thin film of water on the slice and there is no internal or external mass transfer resistance. Hence, drying is controlled by external heat transfer. In the *falling rate period*,

drying is controlled by the internal mass transfer resistance. The absence of a constant rate period indicates that the drying is controlled from the beginning by internal mass transfer resistance. The moisture content at the point when the drying period changes from a constant to a falling rate can be considered as the critical moisture content. The critical moisture content depends on the characteristics of the food and the drying conditions. The critical moisture contents varied from 0.78 to 0.83 (kg/kg, wet basis) for vegetables and 0.85 to 0.89 (kg/kg, wet basis) for fruits [119]. At high moisture content, liquid flow due to capillary forces dominates. At decreasing moisture content, the amount of liquid in the pores also decreases and a gas phase is built up, causing a decrease in liquid permeability. Gradually, the mass transfer is taken over by vapor diffusion in a porous structure. At the saturation point, liquid is no longer available in the pores and mass transfer is taken over completely by vapor diffusion [26].

The moisture is transferred from the solid materials by diffusion or capillary mechanism. In diffusion mechanism, the concentration gradient is the driving force. Water diffusion can be in the form of liquid or vapor. In the case of liquid diffusion, osmotic pressure could be the driving force for water movement. In capillary mechanism, the moisture moves due to surface tension and does not conform to the laws of diffusion. A porous material contains a complicated network of interconnecting pores and channels extending to the exterior surface. As water is removed, a meniscus is formed across each pore, which sets up capillary forces by the interfacial tension between the water and the solid. Capillary forces act in a direction perpendicular to the surface of the solid. It has been suggested that a combined mechanism of capillary forces and vapor diffusion is responsible for moisture movement in the drying of potato [39,40]. The drying experiments of Saravacos and Charm [119] with surface-active agents failed to show any important capillary forces during the dehydration of potatoes and other vegetables. Surfactants are known to reduce the surface tension of water, thus increasing the capillary forces in porous materials. Therefore, capillary flow is not significant in the vegetables studied by Saravacos and Charm [119]. Waananen and Okos [146] showed that during drying of pasta at a temperature close to the boiling point, liquid flow dominates moisture transport at high moisture levels and vapor flow is significant only at low moisture levels. Achanta and Okos [3] reviewed the shrinkage of different biopolymers and concluded that shrinkage on drying is equal to the volume of moisture leaving; thus, it is conceptually difficult to justify that capillary flow is important during the drying of high-moisture biopolymers.

The strength of capillary forces at a given point in a pore depends on the curvature of the meniscus, which is a function of the pore cross section. Small pores develop greater capillary forces than large ones; thus, large pores tend to empty their water content first [76]. In large pores, the capillary forces are small. The force of gravity is large in comparison with the capillary forces, and there is a directional effect due to gravity [76].

### 18.3.1.1 Drying Curve

Drying curve usually plots the drying rate versus drying time or moisture contents. Three major stages of drying can be observed in the drying curve (Figures 18.1 and 18.2):

1. Transient early stage, during which the product is heating up (transient period)
2. Constant or first period, in which moisture is comparatively easy to remove (constant rate period)
3. Falling or second period, in which moisture is bound or held within the solid matrix (falling rate period)

Typical drying rate curves are shown in Figures 18.1 and 18.2. The moisture content at which the change from the first to the second period occurs is known as the critical moisture content. Typically, two falling rate periods are observed for both hygroscopic and nonhygroscopic solids [138]. The first falling rate period is postulated to depend on both internal and external mass transfer rates; while the second period, during which drying is much slower, is postulated to depend entirely on internal mass transfer resistance. The slower rate may be due to the solid–water interaction or glass–rubber transition [3].

The drying behaviors of food materials depend on the porosity, homogeneity, and hygroscopic properties. The immediate entrance into the falling rate is characteristic of hygroscopic food materials. Lee et al. [68] studied the effect of sodium sulfate on the surface evaporation of a porous medium during the constant rate

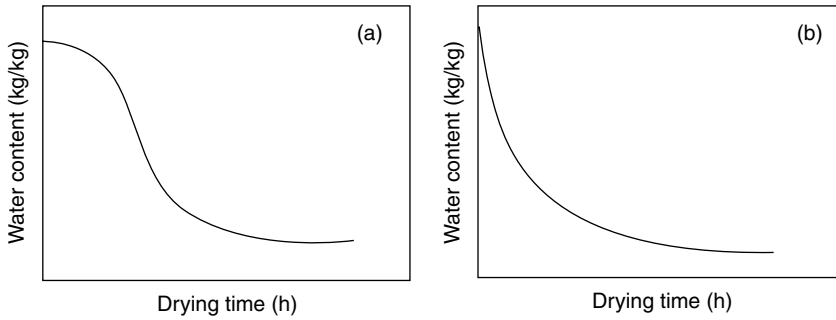


FIGURE 18.1 Typical drying curves (water content versus drying time): (a) with a lag period, (b) without a lag period.

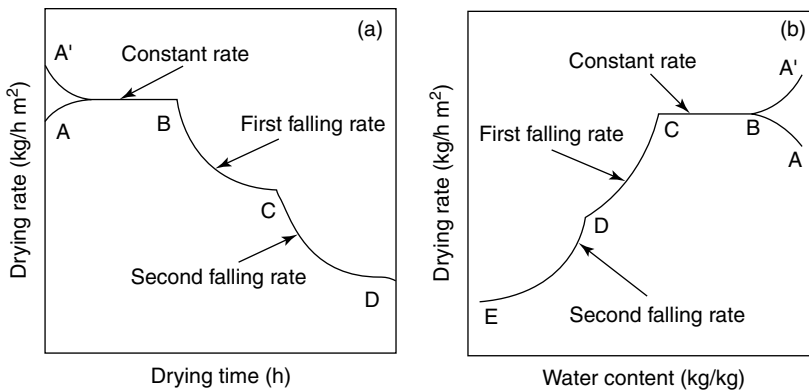


FIGURE 18.2 Typical drying rate curves: (a) drying rate versus drying time, (b) drying rate versus water content.

period. The drop in the drying rate was significant due to the decrease of surface vapor pressure and the change of liquid surface curvature due to meniscus effects by surface tension.

### 18.3.1.2 Energy Aspect of Air Drying

Drying is one of the most energy-intensive processes in the food industry. Apart from the rise of energy costs, legislation on pollution and sustainable and environment-friendly technologies created greater demand for energy-efficient drying processes in the food industry. Thus, novel thinking in the technology of drying methods and dryer design is evident. The food industry could save much money by avoiding costly energy waste. Improving energy efficiency by only 1% could result in as much as 10% increase in profits [12]. Conducting an energy survey is the traditional way to approach the problem. The energy survey analyzes the energy defect level at each stage of processing and strategies for their remedy [12].

### 18.3.1.3 Energy Losses in Air Drying

Heat losses during drying can be grouped into heat loss with the exhaust air, heat loss with the product, radiation heat loss from the dryer, heat loss due to leakage of air from the dryer, and heat loss due to overdrying of products. Table 18.1 shows the possible energy savings for walnut dehydration. Recirculating exhaust air in grain dryers is popular because of its effect on grain quality and energy conservation benefit. The high-humidity air damages grains to a lesser extent than low-humidity air.

Grains are severely damaged by high drying temperatures [130]. Thus, by changing the dryer design, energy losses can be avoided while achieving higher product quality. Energy can be saved by (a) reducing drying time or increasing throughput (better control), (b) avoiding heat losses, and (c) heat recovery from exhaust gas and dried product. The potential for energy conservation by design and changes in drying

operation is significant. Strumillo and Lopez-Cacicedo [134] reviewed most of the methods of energy recovery from exhaust air, including heat exchangers (pipe and plate types), thermal wheel, heat pipe installation, and runaround coil. These methods recover mainly sensible heat from the exhaust, while most of the heat is lost with the latent heat of water vapor in the exhaust air. This latent heat can be recovered by condensing out water using a refrigeration system. However, a refrigeration system will consume extra power before further use. Among these methods, the heat pump dryer (using a dehumidifier) has a high potential for use in the food industry (discussed later).

The broad classes of thermal drying are air drying, low air environment drying, and modified atmosphere drying.

### 18.3.2 Air-Drying Methods

In the case of air drying, atmosphere is used as the drying medium and heat as different modes could be applied in the process.

#### 18.3.2.1 Sun Drying

Earlier, only sun drying was used for drying. In this process, foods are directly exposed to the sun by placing them on the land or left hanging in the air. The main disadvantages of this type of drying are (i) contaminations from the environment, (ii) product losses and contaminations by insects and birds, (iii) floor space requirements, (iv) difficulty in controlling the process, and (v) bad odor. When the climate is not particularly suitable for air drying or better quality is desired, mechanical air drying is mainly used. However, sun drying is the cheapest method of drying foods. Nowadays, solar and mechanical air drying is widely used commercially.

#### 18.3.2.2 Solar Drying

Solar drying is an extension of sun drying that uses radiation energy from the sun. Solar drying is a non-polluting process and uses renewable energy. Moreover, solar energy is an abundant energy source that cannot be monopolized [55]. However, solar drying has several drawbacks that limit its use in large-scale production. These are the need for large areas of space and for high labor inputs, difficulty in controlling the rate of drying, and insect infestation and microbial contamination [25,55]. More options in designing are now available in the literature in order to avoid or reduce the above difficulties. Sablani et al. [117] studied the performance of open rack, multirack dome dryer, and cabinet drier with convection air flow created with fan operated by solar battery. In addition to the dryer performance, quality attributes of dried sardines were assessed by determining yeast, mold, and bacterial counts; peroxide value; and color. A significant variation in drying rates and quality attributes was observed. Dome drying could use the multirack tray in a big dome for increasing the floor space for high loading, efficient use of energy, and better control of the process.

#### 18.3.2.3 In-Store Drying

In-store drying can also be called low-temperature in-bin drying. It may be used when grains are stored until milled or sold. Weather conditions in tropical climates are less favorable for in-store drying, due to high ambient temperatures and relative humidity values. Two-stage drying can produce good quality by preventing discoloration of high-moisture grains and reduced cracking of skin dry kernels.

**TABLE 18.1**

Energy Savings for Walnut Dehydration

Method	Possible Savings (%)
Preventing overdrying	25–33
Recirculation of drying air	25
Reducing airflow rate	≤25
Improved burner design and operation	≤10
Insulation of drying	3–4

Source: Strumillo, C. and Lopez-Cacicedo, C. 1987. In: Handbook of Industrial Drying. Mujumdar, A.S., Ed. Marcel Dekker, NY. pp. 823–862.

#### **18.3.2.4 Convection Air Drying**

Cabinet- and bed-type dryers (i.e., kiln, tray, truck tray, rotary flow conveyor, and tunnel) fall into the first generation [144]. This is the simplest drying technique, which takes place in an enclosed and heated chamber. The drying medium, hot air, is allowed to pass over the product, which has been placed in open trays. Convection drying is often a continuous process and is mostly used for products that are relatively low in value. Air drying is usually accomplished by passing air at regulated temperature and humidity over or through the food in a dryer. Factors that affect the rate of drying are temperature, humidity, air velocity and distribution pattern, air exchange, product geometry and characteristics, and thickness. The sample is usually placed on mesh trays in one layer or in bulk on a bed or hung from a string for better air circulation over the product. Air circulation can be horizontal or vertical to the layer or bed. The structure and composition, such as fat content, of a product affects the drying rate. In general, the hotter is the air temperature, the faster is the drying rate; and similarly, the higher is the velocity, the higher is the drying rate; the lower is the air humidity, the higher is the drying rate. The relative humidity (a measure of dryness) is lower when air temperature is raised. A dryer must expel air to get rid of moisture, thereby allowing new, lower humidity air to enter the system. However, this process causes heat loss from the dryer. In many cases, two- or multistage drying with different conditions could be used, for example, initial drying at 90°C and then the second or final stage at 60°C.

#### **18.3.2.5 Explosive Puff Drying**

Explosive puff drying uses a combination of high temperature and high pressure, and a sudden release of the pressure (explosion) to flush superheated water out of a product. This method gives a product of good rehydrability. However, the high heat can degrade food quality, and the explosion puffing may compromise product integrity [25].

#### **18.3.2.6 Spray Drying**

Spray drying is used to remove water from a free-flowing liquid mixture, thus transforming it into a powder form. The fluid to be dried is first atomized by pumping it through either a nozzle or a rotary atomizer, thus forming small droplets with large surface areas. The droplets immediately come into contact with a hot drying gas, usually air. The liquid is very rapidly evaporated, thus minimizing contact time and heat damage. Disadvantages include the size of the equipment required to achieve drying is very large and very oily materials might require special preparation to remove excessive levels of fat before atomization [25]. Ultrasonication in the chamber can be used instead of complex atomization to produce small-diameter droplets in spray drying.

#### **18.3.2.7 Fluidized Bed Drying**

This technique involves the movement of particulate matter in an upward-flowing gas stream, usually hot air. Fluidization mobilizes the solid particulates, thus creating turbulences on the solid surfaces, which increases the drying rate. The hot gas is introduced at the bottom of a preloaded cylindrical bed and exits at the top. In some cases, a vibratory mechanism is used to increase the contact of the product with the hot gas. Fluidized bed drying is usually carried out as a batch process and requires relatively small, uniform, and discrete particles that can be readily fluidized [25]. The main advantages of fluidized bed drying are uniform temperature and high drying rates, thus less thermal damage. A rotating chamber is also used with the fluidized bed, thus increasing centrifugal force to further increase the drying rate and mixing. The use of a solid carrier, such as sea sand, and wheat bran could prevent the biomaterial from deterioration due to thermal shock [88].

#### **18.3.2.8 Spouted Bed Drying**

In a spouted bed dryer, a jet of heated gas enters the chamber at the center of a conical base. The food particles are rapidly dispersed in the gas, and drying occurs in an operation similar to flash drying. This works very well with large pieces that cannot be dried in a fluidized bed dryer [25].



### **18.3.2.9 Ball Drying**

In this method, the material to be dried is added at the top of the drying chamber through a screw conveyor. The material within the drying chamber comes into direct contact with heated balls made from ceramic or other heat-conductive material. Drying occurs primarily by conduction. Hot air is passed through the bottom side of the chamber. When the product arrives at the bottom of the chamber, it is separated from the balls and collected [25].

### **18.3.2.10 Rotary Drum Drying**

Rotary drum dryers are cylindrical shells 1–5 m in diameter, 10–40 m in length, and rotating at 1–8 rpm with a circumferential speed of approximately 0.2–0.4 m/s. These conditions depend on the product types to be dried. The dryers are designed to operate at a nearly horizontal position, inclined only by 2°–6° to maintain the axial advance of solids, which are fed from the upper end of the dryer body [94].

### **18.3.2.11 Drum Drying**

This technique removes water from a slurry, paste, or fluid that has been placed on the surface of a heated drum. The dryer may comprise either a single or a double drum. Drum drying is typically a continuous operation, and care must be taken to ensure that the product that is to be dried adheres well to the drying surface; in some cases, it may be necessary to modify the liquid product by using additives to change its surface tension or viscosity [25].

## **18.3.3 Low Air Environment Drying**

### **18.3.3.1 Vacuum Drying**

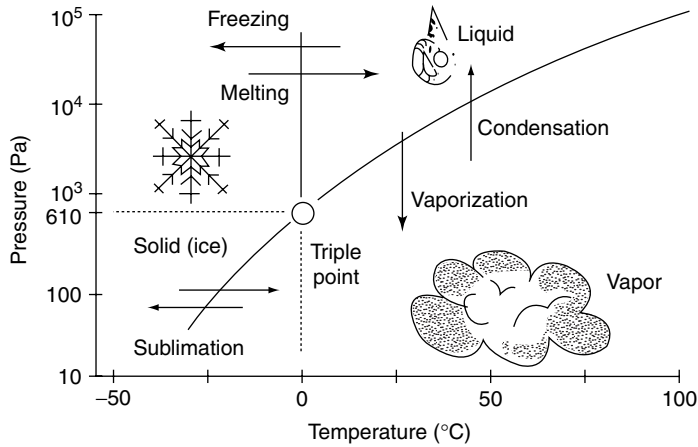
Vacuum drying of food involves subjecting the food to a low pressure and a heating source. The vacuum allows the water to vaporize at a lower temperature than at atmospheric conditions, thus foods can be dried without exposure to high temperature. In addition, the low level of oxygen in the atmosphere diminishes oxidation reactions during drying. In general, color, texture, and flavor of vacuum-dried products are improved compared with air-dried products. In some cases, the product is comparable to the quality of freeze-dried foods.

### **18.3.3.2 Freeze Drying**

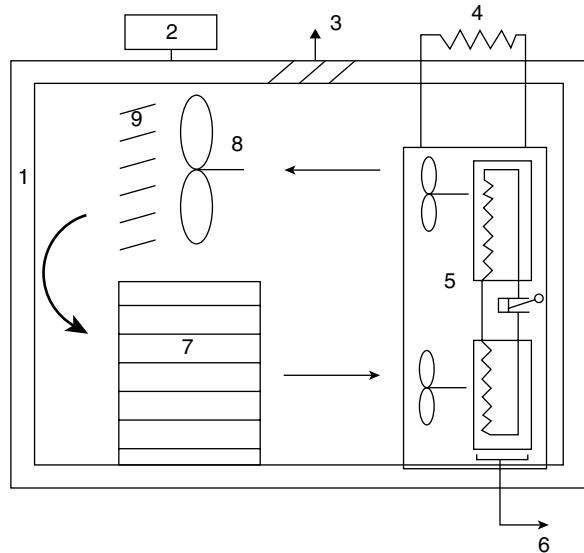
In freeze drying, frozen material is subjected to a pressure below the triple point (at 0°C, pressure: 610 Pa) and heated to cause ice sublimation to vapor. A schematic diagram of the different states of water with triple point is shown in Figure 18.3. This method is usually used for high-quality dried products, which contain heat-sensitive components such as vitamins, antibiotics, and microbial culture. The virtual absence of air and low temperature prevents deterioration due to oxidation or chemical modification of the product. It also gives very porous products, which results in high rehydration rates. However, freeze drying is a slow and expensive process. A long processing time requires additional energy to run the compressor and refrigeration units, which makes the process very expensive for commercial use. Thus, it is mainly used for high-value products [25].

### **18.3.3.3 Heat Pump Drying**

The heat pump dryer is a further extension of the conventional convection air dryer with an inbuilt refrigeration system (Figure 18.4). Dry heated air is supplied continuously to the product to pick up moisture. This humid air passes through the evaporator of the heat pump where it condenses, giving up its latent heat of vaporization to the refrigerant in the evaporator. This heat is used to reheat the cool dry air passing over the hot condenser of the heat pump. Thus, the latent heat recovered in the process is released at the condenser of the refrigeration circuit and used to reheat the air within the dryer. The use of the heat pump dryer offers several advantages over conventional hot air dryers for drying food products, including higher energy efficiency, better product quality, the ability to operate independent



**FIGURE 18.3** Schematic diagram of the different states of water showing triple point. (From Nijhuis, H. H. et al. 1996. *Drying Technol.* 14: 1429–1457.)



**FIGURE 18.4** A schematic diagram of the operation of a typical heat pump dryer: (1) vapor-sealed and insulated structure, (2) humidifier, (3) overheat vent, (4) external condenser, (5) heat pump dehumidifier, (6) condensate, (7) product tray, (8) primary air circulation fan and (9) air distributor. (From Perera, C. O. and Rahman, M. S. 1997. *Trends Food Sci. Technol.* 8(3): 75.)

of outside ambient weather conditions, and zero environmental impact. In addition, the condensate can be recovered and disposed of in an appropriate manner, and there is also the potential to recover valuable volatile components from the condensate [90]. One of the main reasons of quality improvements in heat pump dried products is due to its ability to operate at low temperatures. If a heat pump dryer is used at low temperatures (10°C–60°C) for highly perishable food products, adequate precautions need to be taken. There is also potential to use heat pump drying with modified atmospheres to obtain better quality products.

**18.3.3.3.1 Quality Improvement**

A major advantage of using heat pump drying is the potential improvements in the quality of the products dried under optimum drying conditions. Usually, dried products have low volatile-aroma content,

suffer a loss of heat-labile vitamins, and have a high incidence of color degradation. Ginger dried in a heat pump dryer was found to retain over 26% of gingerol, the principal volatile flavor component responsible for ginger's pungency, compared to only about 20% in rotary-dried commercial samples [75]. The higher volatile content retention in heat pump-dried samples may be due to reduced degradation of gingerol at the lower drying temperature used compared with the commercial dryer temperatures. The loss of volatiles varies with concentration, with the greatest loss occurring during the early stages of drying when the initial concentration of the volatile components is low. Since heat pump drying is conducted in a sealed chamber, any compound that volatilizes will remain within it, and the partial pressure for that compound will gradually build up within the chamber, retarding further volatilization from the product [90].

Development of a brown center sometimes occurs in macadamia nuts if high-moisture nuts are dried at elevated temperatures [98]. Van Blarcom and Mason [142] found that heat pump drying of macadamia nuts did not result in the above defect, even when they were dried at 50°C. Mason [74] studied the heat pump drying of macadamia kernels and herbs, at temperature and relative humidity ranges of 30°C–50°C and 0.10–0.50, respectively. Freshly harvested macadamia nuts can be dried rapidly up to a moisture content of 0.015 with no loss in quality when dried under the conditions mentioned above. This may be due to the faster drying rates associated with the heat pump drying process [90]. The losses in color, flavor, and nutritive value associated with dried products are attributed to nonenzymatic browning. It is recognized that the rate of reaction for nonenzymatic browning in dried products is highest at moisture levels that are commonly attained toward the end of the drying cycle, when the drying rate is low and the product temperature approaches that of the drying medium. However, the lower drying temperatures used throughout the drying cycle in heat pump dryers reduce the extent of nonenzymatic browning reactions.

The color and aroma of herbs (e.g., parsley, rosemary, and sweet fennel) can be improved when compared with the commercial products. The sensory values were nearly doubled in the case of heat pump-dried herbs when compared with commercially dried products. There was no significant difference in the quality of herbs dried below a moisture content of 0.04 for the experimental drying temperatures (40°C–50°C) and relative humidity (0.30 and 0.40). A range of quality characteristics can be obtained by running the dryer within wide ranges of temperature and relative humidity. The use of modified atmospheres for drying sensitive materials such as food products is another important potential aspect of heat pump drying technology. During drying, oxygen-sensitive materials such as flavor compounds and fatty acids can undergo oxidation, giving rise to poor flavor, color, and rehydration properties. Using modified atmospheres to replace air will permit new dry products to be developed without oxidative reactions occurring [90].

### 18.3.3.3.2 Energy Efficiency

Removal of water in its liquid state rather than the vapor state allows the latent heat of vaporization to be captured, and only a small amount of sensible heat is lost with the condensate. The energy spent in drying is usually expressed as the "specific moisture-extraction rate" or SMER. The SMER for a well-designed heat pump dryer lies between 1 and 4 kg/kWh, whereas the SMER of a single-pass hot dryer is only 0.95 kg/kWh [90]. A general comparison of heat pumps with vacuum- and hot-air drying is presented in Table 18.2.

**TABLE 18.2**

General Comparison of Heat Pump Dryer with Vacuum and Hot-Air Drying

Parameter	Hot-Air Drying	Vacuum Drying	Heat Pump Drying
SMER (kg water/kWh)	0.12–1.28	0.72–1.2	1.0–4.0
Drying efficiency (%)	35–40	≤70	95
Operating temperature range (°C)	40–90	30–60	10–65
Operating % RH range	Variable	Low	10–65
Capital cost	Low	High	Moderate
Running cost	High	Very high	Low

### 18.3.3.3.3 Process Efficiency

Heat pump drying has the ability to operate at set conditions independent of outside ambient weather conditions. In addition, it is environment friendly, i.e., no gases or fumes are given off to the atmosphere. The condensate can be recovered and disposed of in an appropriate manner, and there is also the potential to recover valuable volatiles from the condensate [90]. Since drying takes place in a closed system, a low air-leakage rate allows for negligible heat loss.

Strommen [133] studied the drying of stockfish (unsalted) and klipfish (salted) in a heat pump dryer and found that the drying time was lowered by a factor of four with a high quality level. The klipfish was dried from 0.55 to 0.45 water content (wet basis) and the stockfish was dried from 0.80 to 0.20 water content. The inlet temperature and relative humidity in the tunnel were 20°C–25°C and 0.73, respectively. For heavily salted fish, at about 27°C burn spots were found. The above authors found the total energy consumption for oil burner airflow, and automatic control of humidity at the exhaust and heat pump to be 875, 479, and 125 kWh/t, respectively.

Increasing the humidity in the drying air slows down the drying process but improves the energy efficiency [18]. In general, heat pump drying efficiency and capacity are dependent on temperature and humidity. Also, the SMER increases with an increase in humidity in the dryer [90]. In a conventional air dryer, at low temperature (10°C–30°C), it is not possible to run the drying operation due to high ambient relative humidity (0.70–0.90), but heat pump drying can be performed at these low temperatures since the relative humidity can be lowered to 0.10.

The thermal insulation and gas tightness of the seals of the chamber structure is important in achieving high energy efficiency for the heat pump. In addition to the electrical energy required to drive the compressor, energy is also required to preheat the product and chamber structure, drive the fan for primary airflow over the product that is to be dried, and replace any heat loss through conduction and air leakages. Motors driving the fan and the compressor can be located within the chamber so that the residual heat produced by them is absorbed within the drying chamber instead of being lost to the atmosphere [90].

### 18.3.3.3.4 Progress and Applications

There are a number of technological problems to be overcome before the process can be applied to the food industry.

*Capital cost:* The capital cost of a heat pump dryer is higher than for a conventional hot-air dryer due to the requirement for an additional refrigeration system. However, its cost should be much less than that of vacuum or freeze drying.

*Limited drying temperature:* While low-temperature drying has a potential advantage, too low a temperature will limit the drying rate, which has implications for throughput. Also, slower drying rates at low temperature may give rise to potential microbial growth problems [90].

*Process control and design:* Like vacuum or freeze dryers, heat pump dryers are more amenable to batch drying because the drying takes place in a hermetically sealed container. The construction of a continuous drying process may require high engineering modeling and design costs. Therefore, the benefits need to be evaluated on the basis of cost rather than energy efficiency alone [90].

*Microbiological safety:* Most of the vegetative cells of microorganisms will be destroyed by normal hot-air drying at 60°C–80°C with only a few exceptions (e.g., heat-resistant bacteria, yeast, and molds) [37]. Although there are some concerns about the potential for the growth of microorganisms at the temperatures used in heat pump dryers, in practice there have been no reports of increased microorganisms in heat pump-dried foods compared to those dried by conventional means [18]. Serious microbiological problems may arise if the dryer is designed poorly. The problems of microbial growth should be the focus of further research.

### 18.3.3.4 Superheated Steam Drying

Superheated steam is used as a drying medium. The main advantages of this type of drying are that it can provide an oxygen-free medium for drying, and process steam available in the industry can be used without any capital cost. An oxygen-free medium has the potential to provide high-quality food products; however, it is important to generate more information regarding quality improvement and processing efficiency.

### 18.3.3.5 Impingement Drying

Impingement drying is an old technology that has only recently been applied to food products. An impingement dryer consists of a single gas jet (air or superheated steam) or an array of such jets, impinging normally on a surface. There are a great variety of nozzles that can be used, and selection of the nozzle geometry and multinozzle configuration have important relevance on the initial and operating costs, and product quality [80]. Some characteristics of impingement drying include rapid drying, popular for convection drying, and the large variety of nozzles available (multizones). Typically, the temperature and jet velocity in impingement drying may range from 100°C to 350°C and from 10 to 100 m/s, respectively [83].

### 18.3.3.6 Smoking

Smoking foods is one of the most ancient food preservation processes, and in some communities one of the most important. The use of wood smoke to preserve foods is nearly as old as open-air drying. Although not primarily used to reduce the moisture content of food, the heat associated with the generation of smoke also causes a drying effect. Smoking has been mainly used with meat and fish. The main purposes of smoking are it imparts desirable flavors and colors to the foods, and some of the compounds formed during smoking have a preservative effect (bactericidal and antioxidant) due to the presence of a number of compounds [25]. In many cases, smoking is considered as a pretreatment rather than a drying process. It was found that smoke is effective in preventing lipid oxidation in meat and fish products [152]. The level of fats affects texture, oiliness, and color of smoked salmon during storage [30,127].

Smoking is a slow process and it is not easy to control. Smoke contains phenolic compounds, acids, and carbonyls, and the smoky flavor is primarily due to the volatile phenolic compounds [30,57]. Wood smoke is extremely complex and more than 400 volatiles have been identified [44,77]. Polycyclic aromatic hydrocarbons are ubiquitous in the environment as pyrolysis products of organic matter. Their concentration in smoked food can reach levels hazardous for human health, especially when the smoking procedure is carried out under uncontrolled conditions [81]. Wood smoke contains nitrogen oxides, polycyclic aromatic hydrocarbons, phenolic compounds, furans, carbonylic compounds, aliphatic carboxylic acids, tar compounds, carbohydrates, pyrocatechol, pyrogallols, organic acids, bases, and also carcinogenic compounds like 3:4 benzpyrene. Nitrogen oxides are responsible for the characteristic color of smoked foods, whereas polycyclic aromatic hydrocarbon components and phenolic compounds contribute to its unique taste. These three chemicals are also most controversial from a health perspective [77].

It is important to scrutinize processing conditions, which must be standardized, controlled, monitored, and documented so that the potential for producing toxic, or even lethal, food products is eliminated. This is especially true for seafood products, which may contain food-poisoning organisms of marine origin that are more difficult to control than those from land sources [51]. Color development in smoked fish is a complex process. Maillard type with glycolic aldehyde and methyglyoxal in the dispense phase of smoke is dominant role in developing golden color. Several types of synthetic colors, paprika, caramel, and seasoning can also be used [2].

All smoked fish must be stored chilled or vacuum packed to prolong shelf life. Brining and smoking affects on sensory quality as well as microbial preservation. Hansen and Huss [47] identified the microflora on spoiled, sliced, and vacuum-packed cold-smoked salmon from three different sources. Lactic acid bacteria dominated the microflora; in some cases large numbers of *Enterobacteriaceae* were also present. The microflora on cold-smoked salmon appeared to be related to the source of contamination, i.e., the raw material or the smokehouse rather than being specific for the product.

The traditional method of smoking fish involves passing hot smoke, from a range of woods, over the fish to partially dry it and impart the flavor and aroma of the smoke. Disadvantages of this method include a lack of control over the process and the finished product, with consequent health concerns if the surface of the fish is not properly dried. The smoking process involves extensive handling of raw and finished products. Smoked food is prepared with either of two basic procedures. One cooks the product (hot smoking) and the other does not (cold smoking). Cold smoking devices have one basic function—to apply smoke to the product. Hot smoking devices have the added function of applying heat. The hot-smoke process for smoking fish differs from the cold-smoke process in a fundamental way. The cold-smoke process requires that the fish reach an internal cooking temperature below 35°C, while the

hot-smoke process cooks the fish to the center at a minimum of 62.8°C for at least 30 minutes. Also, both processes should ensure at least 3.5% salts in water-phase of fish muscle. Between these two extremes are the temperatures that can create an environment favorable to the growth of food-poisoning bacteria. As an additional safety margin, hot-smoked fish should always be cooled to less than 3.3°C immediately after smoking and held at that temperature until consumed to prevent the growth of food-poisoning bacteria. Both hot- and cold-smoked fish are preserved primarily by controlling the salt and moisture content (water-phase salt). Smoke deposition is effective only in controlling surface spoilage [51].

The hot smoking of fish requires five steps, each with different goals and operating conditions. These steps are surface drying, smoking, drying, heating/cooking, and cooling. Surface drying is the removal of surface moisture, leaving a protein coating (pellicle) on each piece of fish so that it accepts an even smoke deposit. The second step involves producing a dense atmosphere of smoke and conditions where smoke is deposited evenly on the surface of each piece to insure good flavor, color, and surface preservation. Often, color does not develop until after the surface of the fish reaches 54.4°C–60°C during the cooking step. The next step involves evenly drying the fish to reduce moisture, raise the water-phase salt, and establish final texture. This is a critical step in producing safe products—heating each piece of fish to at least 62.8°C and holding that temperature for at least 30 minutes. This is followed by cooling the fish to below the cooking temperature (48.9°C–60°C) in the smokehouse as quickly as possible. A suitable sanitary refrigerated room is usually more practical and cost-effective than a refrigerated smokehouse. Cold-smoke procedures do not use step 4, i.e., heating/cooking. Usually these five cycles require 8–12 h. Cycles of 4 h or less are possible with thin and lightly smoked products [51]. The differences in the process employed depend primarily upon the type of fish and regional preferences for a particular product. Different schedules for different fish species are specified [30]. A smokehouse is equipped with a smoke generator where smoke is passed over water to remove tar and solid particles. Good manufacturing practice (GMP) from the FDA sets the minimum standards for time/temperature smoking cycles, salt and moisture content, manufacturing, holding and shipping temperatures, process monitoring and record keeping, and packaging.

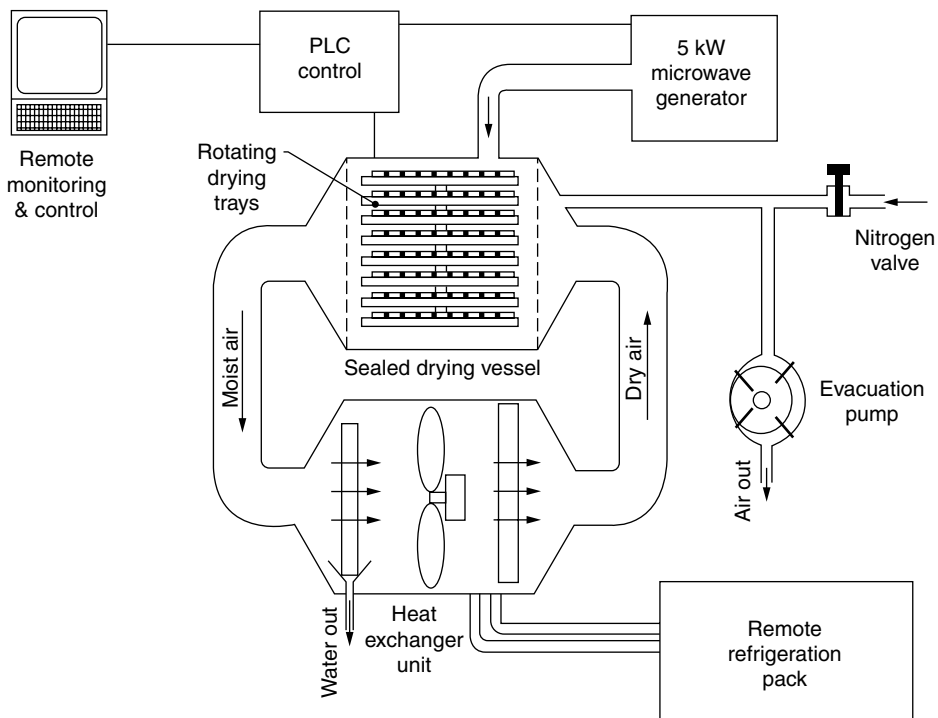
More modern methods of smoking fish use formulations of liquid smoke to provide flavor and a range of methods of drying to reduce water activity on the surface. The fish is dipped in smoke solutions prior to drying. Most drying methods use heat to change the relative humidity of the air passing over the fish. This is an inefficient way of using energy, and in addition the heat drives off many of the aromatic chemicals that go to make up the aroma, flavor, and color of the product. This can be overcome by using an energy-efficient heat pump dryer, where drying is performed in a closed chamber. *Smoke solutions* are available, either being condensed products from the dry distillation of wood or synthetically prepared mixtures of phenols. The use of smoke condensates offers some advantages. They are easy to apply and their concentration can be controlled. They can be analyzed, purified if necessary, and their antimicrobial activity can be evaluated. Sunen [136] identified the minimum inhibitory concentration of smoke-wood extracts against spoilage and pathogenic microorganisms associated with food. They found that the effectiveness in inhibition varied with the type of commercial liquid smoke. Synthetic smokes are nearer to actual smoke curing and harmful components can be eliminated from synthetic smokes. The odor, composition of flavor compounds, and antimicrobial activity of the smoke are recognized to be highly dependent on the nature of wood. Some studies have recognized beech and oak woods as those which produce wood smoke with the best sensory properties [43]. Further, herbs, spices (bay leaves, black peppers, cloves, coriander seed, and spice), or pinecones may also be added to produce unique aromatic smoke flavors [57]. Bacteriocin treatment was found effective in inhibiting *Listeria monocytogenes* on salmon packaged under vacuum or modified atmosphere [137].

### 18.3.4 Modified Atmosphere Drying

This is a new concept of drying foods using heat pump dryers, which uses modified atmospheres such as nitrogen and carbon dioxide, for better quality and preservation of constituents of foods, prone to oxidation. Technologies to create the modified atmosphere drying are now evolving. O'Neill et al. [85] showed that the browning of apple cubes during drying could be arrested if the oxygen level in the atmosphere is less than 0.5%. Apple cubes dried in nitrogen atmosphere gave more open pores and

uniform shrinkage than those dried in air and vacuum. Rahman et al. [108] studied the microbial (aerobic plate count, *Pseudomonas*, *Staphylococcus*, molds) and physicochemical (pH, expressed juice, fatty acid profile, rehydration ratio, color) characteristics of sun, air, vacuum, freeze, and modified atmosphere (nitrogen gas) dried goat meat. The modified atmosphere drying showed significant improvement in selected quality attributes such as shrinkage, color, types of molds, and peroxide values (PV).

Modified atmosphere heat pump dehumidifier (MAHPD) drying is a relatively new development described by Perera [91,92] and Hawlader et al. [49,50]. The fact that heat pump dehumidifier (HPD) drying is conducted in an enclosed, insulated chamber is made use of in the development of the MAHPD drying system. The air in the dehumidifier chamber is replaced with an inert atmosphere such as nitrogen, carbon dioxide, or their mixtures. Replacement of the air inside the chamber is easily carried out by exhausting the chamber using a vacuum pump and then breaking the vacuum using an inert gas. Vacuum exhaustion is a more cost-effective way to replace air than by direct purging with the specific inert gas. Replacement of air with carbon dioxide or nitrogen by purging requires over 50 volumes to achieve an oxygen level of less than 0.5%. Schematic diagram of the MAHPD drying system is shown in Figure 18.5. This consists of a sealed drying vessel connected to the heat exchanger unit. The drying vessel has provision for introduction of nitrogen or for evacuation through a valve connection. The MAHPD system shown also has provisions for introducing microwave energy for heating the product, through a slotted waveguide running down the wall of the chamber parallel to the axis of the chamber. A PLC control panel connected to a remote PC and monitor controls the whole system. The product is carried on microwave-transparent plastic trays stacked vertically on a rotating platform, which is mounted on a load cell, so that weight loss can be monitored and recorded on the PC. The current prototype is essentially a batch process, but it can be semiautomated depending on the products and pretreatments required for specific products. Some of the pretreatments may include vacuum infusion or osmotic dehydration before MAHPD drying. After the product is loaded on to the trays and stacked on the platform, the drying chamber is evacuated to 600–700 Pa for 30 minutes, after which, the vacuum is



**FIGURE 18.5** Schematic diagram of the MAHPD drying system. (From Perera, C. O. 2001. Proceedings of the 2nd Asian-Oceania Drying Conference. Penang, Malaysia, 2001; Perera, C. O. 2004. In: *Dehydration of Products of Biological Origin, Chapter 6*. Science Publishers Inc., Enfield, NH, USA. pp. 153–163.)

broken with the selected modified atmosphere and normal HPD drying is carried out in this modified atmosphere. Microwave energy improves the drying rate. The surface temperature of the product is monitored using an infrared detector. Controls can be set for the microwave energy to cut off at a preset surface temperature of the product, so that overheating can be minimized.

The quality of apple cubes dried by MAHPD was evaluated using several techniques. The color of these cubes was measured by Hunter Lab spectrophotometer. Density and porosity of the fruit tissues were measured by helium gas pycnometer and structural properties of the fruit tissues were evaluated by scanning electron microscopy [50]. It was found that apple tissues dried by MAHPD had lighter color, lower bulk density values, porous (noncollapsed) structure, and better rehydration properties compared with those dried by most other common drying methods. Hawlader et al. [50] also found that fruits dried by MAHPD retained the highest level of nutrients, such as vitamin C, and flavor compounds [50]. These observations suggest that MAHPD is highly suited for drying sensitive food and pharmaceutical products.

---

## 18.4 Pretreatments

### 18.4.1 Blanching

Pretreatments are common in most of the drying processes in order to improve product quality, storage stability, and process efficiency. In recent years, an improvement in quality retention of the dried products by altering processing strategy and pretreatment has gained much attention. Blanching is a process of preheating the product by immersion in water or steam. The main purpose of blanching is to inactivate the naturally occurring enzymes present in foods, since enzymes are responsible for off-flavor development, discoloration or browning, deterioration of nutritional quality, and textural changes in food materials. Other advantages are that it removes air-bubbles from vegetable surfaces and from intercellular spaces, reduces the initial microbial load, cleans raw food materials initially, facilitating preliminary operations such as peeling and dicing, and improving color, texture and flavor under optimum conditions [13,36,73]. Blanching may have disadvantages, for example, it may change the texture, color, and flavor because of the heating process [45,125]; it increases the loss of soluble solids, such as vitamins [5,14], especially in the case of water blanching; it may change the chemical and physical states of the nutrients and vitamins [1,13,33]; and it has adverse environmental impacts, such as large water and energy usage, and problems of effluent disposal.

Time and temperature of blanching are the important factors for achieving optimum quality of the dried product [56]. The normal blanching temperature varies from 80°C to 100°C. Recently, low-temperature and long-time blanching has been proposed for better texture and retention of some nutrition components [78,100]. The temperature used is between 50°C and 70°C. Blanching times correlated with the flavor and sensory attributes of dried fruits and vegetables [125]. Limiting blanching time, rapid cooling, and alternative blanching methods and combinations may result in dried products with better flavor. Processing methods that include steam and microwave blanching, and nonthermal enzyme inactivation such as high pressure and ohmic heating may hold out potential for future blanching processes, with less detrimental effects on flavor while maintaining optimum texture.

### 18.4.2 Sulfur Dioxide Treatment

Sulfur dioxide preserves the texture, flavor, vitamin content, and color that make food attractive to the consumer. Sulfur dioxide treatment is used widely in the food industry to reduce the fruit-darkening rate during drying and storage, and preserves ascorbic acid and carotene. Sulfur dioxide taken up by the foods displaces air from the tissue in plant materials, softens cell walls so that drying occurs more easily, destroys enzymes that cause darkening of cut surfaces, shows fungicidal and insecticidal properties, and enhances the bright attractive color of dried fruits [131]. Permitted levels of sulfur dioxide and other additives (solutes) in dried foods vary from country to country. According to the Institute of Food Technologists (IFT) [54] expert panel, sulfur dioxide in dried fruits is set at the highest level by food legislation. The allowed limit is 2000 mg/kg of dried fruit. Sulfiting treatment can be done by burning



sulfur or soaking foods in sulfite solution. Gaseous sulfur dioxide can be produced by burning sulfur with oxygen in the air and then circulating it to the smoking chamber. Potential advantages in using a bisulfite solution are [131] decreased air pollution, better control of the sulfuring process, greatly shortened sulfuring time, and decreased desorption losses during drying.

The chemical reactions of sulfur dioxide when it is added to fruits and other food products are complex [15]. Sulfite could be bound or free in the food matrix. The bound sulfite is considered to have no retarding effect on product deterioration; thus, it is important to know the factors that influence binding [15]. The amount of bound sulfite depends on pH; carbonyl groups of aldehydes, acetaldehyde, pyruvic acid; and the availability of oxygen, sugars, and starch [15,19,89]. Sulfiting and blanching can also be used together for pretreatment [139]. Sulfiting ruptures and collapses cells, resulting in a smaller cell volume and hardness of the dried samples [82,97]. A number of factors affect sulfur dioxide uptake by fruits and vegetables, including concentration and temperature of dipping solution, time of dipping, geometry and conditions of sample (i.e., peeled or unpeeled, whole or sliced), and agitation of solution [114,131].

### **18.4.3 Salting or Curing**

Salting or curing is a natural type of osmotic dehydration. Curing was originally developed to preserve certain foods by the addition of sodium chloride. In the food industry, the application of curing is related only to certain meat, fish, and cheese products. Today sodium chloride, and sodium and potassium nitrite (or nitrate) are considered as curing salts. Salting is one of the most common pretreatments used for fish products. It converts fresh fish into shelf-stable products by reducing the moisture content and acting as a preservative. In combination with drying, these processes contribute to the development of characteristic sensory qualities in the products, which influence their utilization as food [124]. Although curing was originally a mechanism for preservation by salting, over several millennia additional processes concomitant with curing have evolved, notably fermentation, smoking, drying, and heating. Curing may have different connotations: in meat, salt and nitrite or nitrate are always added; in fish, salt is always added, but nitrite only rarely; and in cheese, which always contains salt but infrequently contains nitrate, the term curing is applied to the production of desirable proteolytic and lipolytic changes. In the past half-century, cured products have been developed that are not stable unless refrigerated. Indeed, most cured meat products must be refrigerated to remain safe and wholesome, and during the past two decades even the packaging of many classes of cured products has become important in extending the period during which the product remains wholesome [128]. Cured meats can be divided broadly into three groups: unheated, mildly heated (pasteurized to a center temperature of 65°C–75°C), and severely heated (shelf stable after heating to 100°C–120°C) [128].

In addition to the curing salts and related processes mentioned above, additives collectively known as adjuncts are used in many cured meat products. These include ascorbates, phosphates, glucono-d-lactone, and sugars. Adjuncts are used primarily to obtain or maintain desirable changes, the ascorbates in connection with color and the others in connection with pH, texture, and in some cases flavor. Adjuncts may also affect safety. The concentration of each curing agent depends on the nature of the food products and the technology used in individual countries [128].

### **18.4.4 Other Dipping Pretreatments**

Dipping treatment with chemicals is also used in addition to blanching or sulfite treatment. The dipping treatment is a process of immersion of foods in a solution containing additives. Usually, the concentration level is below 5% and the dipping time below 5 minutes, whereas osmotic dehydration is carried out at higher concentrations and for long processing times. The main purpose of the dipping treatment is to improve the drying characteristics and quality. Certain chemicals are used to enhance the rate of dehydration [45]. Among these compounds, methyl and ethyl oleate, or olive oil are the most common [16,93,95,148]. Methyl oleate has realized the greatest usage because of economics and its higher taste threshold. A carbonate-oleate combination was found to be superior when used alone in accelerating drying rate [109,112,140]. A synergistic effect results from the combined use of alkali

**TABLE 18.3**

Chemicals Used for Dipping Treatment

Type	Compounds
Chemicals	
Esters	Methyl oleate, ethyl oleate, butyl oleate
Salts	Potassium carbonate, sodium carbonate, sodium chloride, potassium sorbate, sodium polymetaphosphate
Organic acids	Oleic acid, steric acid, caprillic acid, tartaric acid, oleanolic acid
Oils	Olive oil
Alkali	Sodium hydroxide
Wetting agents	Pectin, tween, nacconol
Others	Sugar, liquid pectin
Surfactants	
Nonionic	Monoglycerides, diglycerides, alkylated aryl polyester alcohol, polyoxyethylene sorbitan monostearate, D-sorbitol, polyoxyethylene
Anionic	Sodium oleate, steric acid, sorbitan heptadecanyl sulfate, dimethyl-benzyl-octyl ammoniumchloride

carbonates and methyl oleate for drying. When excess carbonate was used, drying was further accelerated. Sodium carbonate was less effective than potassium carbonate; however, the cost of sodium salt is about a fifth of that for potassium.

Esters affect the waxy surface of fruits by altering the physical arrangement of the surface wax platelets, thus allowing moisture to more readily evaporate from the fruit. This was confirmed using electron microscopy for grapes and sweet cherries [48]. Increase of the hydrophilic groups on the wax surface by a reversible attachment of long-chain fatty acids and their esters was observed. The increase in hydrophilic groups on the normally lipophilic wax surface would form a sequence of attachment sites to facilitate the transfer of water through the crystalline wax layer [21,41]. The addition of potassium carbonate is necessary, possibly acting by saponification of fatty acids such as oleic, steric, and oleanolic acids, which are known constituents of grape wax. Table 18.3 shows the chemicals used for dipping treatment.

#### 18.4.5 Freezing Pretreatment

Freezing treatment affects the drying process. The rehydration rate of air- and vacuum-dried fruits and vegetables subjected to freezing treatment increased to a level comparable with that of freeze-dried products [63]. It was also noticed that the longer the duration of freezing, the better the rehydration kinetics of dried products. This was due to the formation of large ice crystals by slow freezing. Drying rate was not dependent on the pressure in the drying chamber—ranging between 20 and 50 mm Hg, and above 50 mm Hg the drying rate decreased rapidly with pressure.

#### 18.4.6 Cooking

Cooking at different pressure levels before drying can destroy microorganisms and affect the physico-chemical properties of dried products. The bacterial load on the final product can thus be reduced considerably, and the cooked product can be minced and spread evenly on drying trays with much less trouble than the raw material. Precooking is usually used for rice, beef [6], fish, and beans [29]. Formation of superficial pellicle (case-hardening) may be avoided by precooking, which considerably retards drying. It is clear that the more severe the initial conditions of cooking, the more stable is the subsequently dehydrated product. When an animal or plant is killed, its cells become more permeable to moisture, as pointed out by Potter [96]. When the tissue is blanched or cooked, the cells may become still more permeable to moisture. Generally, cooked vegetable, meat, or fish is dried more easily than their fresh counterparts, provided that the cooking does not cause excessive shrinkage or toughening [96]. Cooking also results in a decrease in water-holding capacity of meat products [132].

## 18.5 Quality Changes During Drying

### 18.5.1 Selection of Variety

Optimum freshness plays an important role in determining the quality and stability of dried foods; fresher the raw material, more stable and better is the quality of the product. Suitable varieties of produce with the desired maturity should be used to achieve a product that is best in quality [135]. The quality characteristics of dried foods can be grouped as microbial, chemical, physical, and nutritional (Table 18.4).

### 18.5.2 Microflora in Dried Foods

Multiplication of microorganisms should not occur in properly processed dehydrated foods, but they are not immune to other types of food spoilage. If dried foods are safe in terms of pathogenic microbial count and toxic or chemical compounds, then acceptance depends on the flavor or aroma, color, appetizing appearance, texture, taste, and nutritional value of the product. Microbial standards are usually based on the total number of indicator organisms or number of pathogens [111]. The microbial load and its changes during drying and storage are important for establishing a standard that will ensure food safety. Poor processing, handling, and storage practices often result in a limited storage life of dried fish [150]. Perishable foods such as meat and fish are prone to rapid microbial spoilage; thus, adequate care must be taken in drying. The microbial load for dried mackerel ranged from  $3 \times 10^3$  colonies per gram sample to too numerous to count. No evidence of spoilage was detected even when the samples had water activity from 0.72 to 0.74. The isolates found were *Alcaligenes*, *Bacillus*, *Leuconostoc*, *Micrococcus*, *Halobacterium*, *Flavobacterium*, *Halococcus*, *Aspergillus*, and *Penicillium*. All the samples were positive for *Coliform*, *Streptococcus*, and *Staphylococcus*. *Vibrio* and *Clostridium* were not detected while *Salmonella* was detected only in some samples [111]. Brining and drying decreased the microbial load but did not eliminate the pathogens. Wheeler et al. [150] studied the common fungi involved in spoiling dried salted fish. They studied the mycoflora of dried salted fish with emphasis on visible spoiled fish and spoilage fungi. A total of 364 isolates from 74 fish were cultured and identified. Wheeler and Hocking [149] studied the effect of water activity and storage temperature on the growth of fungi associated with dried salted fish. Microorganisms did grow during the drying of highly perishable products such as fish (Trevally) in heat pump dehumidifier drying at low temperatures of 20°C–40°C. Lower temperatures gave lower counts regardless of the relative humidity of drying. Sulfur-producing organisms formed a significant portion of the total flora of dried fish. Rahman et al. [106] studied the endogenic microflora changes in tuna mince during convection air drying between 40°C and 100°C. A drying temperature of 50°C or below showed no lethal effect on the microflora, but instead aided growth. The drying temperature of fish must be above 60°C to avoid microbial risk in the product. The actual optimum temperature above 60°C should be determined based on other quality characteristics of the dried fish [106].

Reducing the water activity of a product inhibits microbial growth but does not result in a sterile product. The highest possible drying temperatures should be used to maximize thermal death even though low drying

**TABLE 18.4**  
Quality Characteristics of Dried Foods

Microbial	Chemical	Physical	Nutritional
Pathogens	Browning	Rehydration	Vitamin loss
Spoiling	Oxidation	Solubility	Protein loss
Toxin	Color loss	Texture	Functionality loss
	Aroma development	Aroma loss	Fatty acid loss
	Removal of undesired components	Porosity	
		Shrinkage	
		Pores' characteristics	
		Crust formation	
		Structure	

temperatures are best for maintaining organoleptic characteristics [86]. Another alternative is to use high drying temperatures initially at high moisture content and then drying at a low temperature. The microbial deactivation kinetics depends on several factors such as variety, water content (i.e., water activity), temperature, and compositions of the medium (acidity, types of solids, pH, etc.) as well as on the heating method [71,58,121]. Models to predict the decimal reduction time (D-value) were also developed as a function of temperature, pH, and water activity for isothermal conditions [20,38]. These models could not be used in the case of drying conditions since the level of water content does not remain the same for each temperature studied. Bayrock and Ingledew [11] measured the D-values for changing moisture content (i.e., drying) and moist conditions (i.e., no change of moisture during heating). The heat resistance of the microorganism increased significantly during drying compared with the moist heat conditions. During drying of tuna, Rahman et al. [106] found that the D-value for endogenous microflora varied from 12.66 to 2.64 h when drying temperature varied from 60°C to 100°C, respectively. As expected, the values decreased with the increase in temperature, which indicates that an increase in drying temperature increased the lethal effect. However, the D-values at 100°C were much lower than at 90°C or below. This may be due to the high drying rate at 100°C [10,106]. Rahman et al. [105] investigated the changes of endogenous bacterial counts in minced tuna during dry heating (convection air drying) and moist heating (heating in a closed chamber) as a function of temperature. The D-values for total viable counts decreased from 2.52 to 0.26 h for moist heating and from 2.57 to 0.34 h for dry heating, respectively, when temperature was maintained at a constant of within 60°C–140°C. In both cases, increasing temperature caused significant decrease in D-values, whereas the effect of the heating methods was not significant. The Z-values were found to be 144°C and 46°C for temperatures between 60°C–100°C and 100°C–140°C, respectively. Rahman et al. [105] also identified the types and characteristics of endogenous microbes present in fresh and dried tuna. Initially, tuna contained a mixture of different microbes, of which some are more heat- and osmotolerant than others. In dried tuna, the predominant microbes were moderately osmotolerant and the dominant microbes were sensitive to heat.

### 18.5.3 Browning Reactions

Browning reactions change color, decrease nutritional value and solubility, create off-flavors, and induce textural changes. Browning reactions can be classified as enzymatic or nonenzymatic, with the latter being more serious as far as the drying process is concerned. The two major types of nonenzymatic browning are caramelization and Maillard browning. In addition to moisture level, temperature, pH, and composition are the other parameters that affect the rate of nonenzymatic browning. The rate of browning is most rapid in the intermediate moisture range and decreases at very low and very high moistures. Browning tends to occur primarily at the center of the drying period. This may be due to the migration of soluble constituents toward the center. Browning is also more severe near the end of the drying period, when the moisture level of the sample is low and less evaporative cooling is taking place that causes the product temperature to rise. Several suggestions were found to help reduce browning during drying. In all the cases, it was emphasized that the product should not experience unnecessary heat when it is in its critical moisture content range [86].

Maillard-type nonenzymatic browning reactions in processed meat products also contribute to the product's external surface color. The main browning reaction involves the reaction of carbonyl compounds with amino groups, although lesser amounts of carbonyl browning also occur. Muscle usually contains small amounts of carbohydrates in the form of glycogen, reducing sugars, and nucleotides, while the amino groups are readily available from the muscle proteins. Browning occurs at temperatures of 80°C–90°C and increases with time and temperature [22]. A loss of both amino acids and sugars from the tissue occurs as a result of the browning reaction. Lysine, histidine, threonine, methionine, and cysteine are some of the amino acids that may become involved in browning [52]. Potter [96] identified that Maillard browning proceeds most rapidly during drying if the moisture content is decreased to a range of 15%–20%. As the moisture content drops further, the reaction rate slows down, and therefore products dried below 2% moisture further color change are not perceptible even during subsequent storage. Drying systems or heating schedules generally are designed to dehydrate rapidly through the 15%–20% moisture range so as to minimize the time for Maillard browning. In carbohydrate foods, browning can be controlled by removing or avoiding amines and in protein foods by eliminating the reducing sugars.

### 18.5.4 Lipid Oxidation

Dehydrated foods containing fats are prone to develop rancidity after a period, particularly if the water content is reduced too much. Fish oils or fats are more unsaturated than beef or butter, and they are usually classified as drying oils because they contain considerable proportions of highly unsaturated acids. The behavior of drying oils toward atmospheric oxygen is well known, and oxidation is a serious problem for commercial drying of fatty fish and seafood. The flesh of some fatty fish, such as herrings, contains a fat pro-oxidant that is not wholly inactivated by heat [9].

Lipid oxidation is responsible for rancidity, development of off-flavors, and the loss of fat-soluble vitamins and pigments in many foods, especially in dehydrated foods. Factors that affect oxidation rate include moisture content, type of substrate (fatty acid), extent of reaction, oxygen content, temperature, presence of metals and natural antioxidants, enzyme activity, UV light, protein content, free amino acid content, and other chemical reactions. Moisture content plays a big part in the rate of oxidation. At water activities around the monolayer ( $a_w \approx 0.3$ ), resistance to oxidation is greatest.

The elimination of oxygen from foods can reduce oxidation, but the oxygen concentration must be very low. The effect of oxygen on lipid oxidation is also closely related to the product porosity. Freeze-dried foods are more susceptible to oxygen because of their high porosity. Air-dried foods tend to have less surface area and pores due to shrinkage, and thus are not affected by oxygen. Minimizing oxygen level during processing and storage, and the addition of antioxidants as well as sequesterants were recommended in literature to prevent lipid oxidation [86]. Fish oils or fats are drying oils, which rapidly absorb oxygen from the air and harden just as paints harden on exposure to air. Fatty fish must be dehydrated quickly in a vacuum and must be stored in vacuum or in an inert gas atmosphere [57].

Antioxidants directly added to herrings before air drying are ineffective, but antioxidants released from wood smoke (used in air drying), which contains some of the simple antioxygenic phenols, stabilizes the fat of the dehydrated products considerably [9]. Oxidation of the fat normally occurs during dehydration. Herrings and haddock dried at 80°C–90°C compared to a lower temperature were found to be more stable during storage [9]. One factor could be the formation of browning products from protein nonfatty part, which gave antioxidant activity. The effectiveness of nonenzymatic browning products in preventing lipid oxidation was demonstrated and is one of the mechanisms hypothesized by Karel [59] to prevent lipid oxidation.

The effects of water on the destruction of the protective food structure in some specific dehydrated foods are probably involved in the prevention of lipid oxidation in heated meat systems [59]. In systems containing both surface lipids and lipids encapsulated within a carbohydrate, polysaccharide, or protein matrix, the surface lipids oxidize readily when exposed to air. The encapsulated lipids, however, do not oxidize until the structure of the encapsulated matrix is modified and destroyed by the adsorption of water [129]. Another reason is the increase of oxygen diffusion by increasing molecular mobility above the glass–rubber transition [113].

The peroxide values of different dried meat samples were studied by Rahman et al. [108]. The values were significantly different according to the methods of drying. Freeze drying gave the highest value, while air drying gave the lowest value. Similar results were also observed in the case of air-dried, vacuum-dried, and freeze-dried tuna meat [104]. Rahman et al. [104] indicated that this was due to the fact of increased oxygen diffusion and higher exposed surface area in case of freeze-dried samples, which was created by high porosity (volume fraction of void or air in the sample).

### 18.5.5 Changes in Proteins

The protein matrix in muscle has a marked effect upon its functionality and properties [122]. The nonfatty part of fish is very susceptible to changes caused by the high temperature of initial cooking, as well as drying and storage. Every process involved in the conversion of muscle to meat alters the characteristics of the structural elements [132]. Heating is believed to cause the denaturation of the muscle proteins even below 60°C but not enough to greatly shear resistance [123]. The decrease in shear observed at 60°C was attributed to collagen shrinkage. Hardening at 70°C–75°C was believed to be due to increased cross-linking and water loss by the myofibrillar proteins, while decreasing shear at higher temperatures may indicate solubilization of collagen [22]. After 1 h at 50°C, the collagen fibrils of the endomysium appear beaded, which is brought about by their close association with the heat-denatured noncollagenous proteins in the extracellular spaces. Heat denaturation

of the lipoprotein plasmalemma results at a temperature of 60°C after 1 h. The breakdown products of the plasmalemma are large granules and are often associated with the basement lamina, which appears to survive intact even after heating at 100°C for 1 h [115,116].

### 18.5.6 Structural Changes

Structural changes in food during drying are usually studied by microscopy. Microscopy provides a good tool to study this type of phenomenon as well as other types of physical and chemical changes during the drying of food materials. Shrinkage occurs first at the surface and then gradually moves to the bottom as the drying time [147] increases. The cell walls became elongated. As drying proceeds at high temperature, cracks are formed in the inner structure. Using microscopy, it was found that the shrinkage of apple samples dried by convection is significantly anisotropic while less damage to the cell structure during freeze drying leads to a more isotropic deformation [79]. The cellular structure of microwave-vacuum-dried apple with and without osmotic treatment indicated collapse of the cellular structure in the untreated apple [35]. Osmotic treatment prior to vacuum drying preserved the cellular structure by keeping intact their three-dimensional nature. Electron microscopic investigations of the cell structure in dried carrots and green beans showed that drying leads to shrinkage and twisting of the cells and clumping of the cytoplasm [42]. Histological changes in air-dried, freeze-dried, and osmotically treated freeze-dried samples showed that air-dried samples exhibited the elongated and thinned cell wall and enlarged intercellular air spaces [67].

Heating produces major changes in muscle structure. Voyle [145] reviewed modifications in cooked tissue observable with the scanning electron microscope. Alterations in muscle structure due to heating include coagulation of the perimysial and endomysial connective tissue, sarcomere shortening, myofibrillar fragmentation, and coagulation of sarcoplasmic proteins [53,145]. Heating and drying intensifies the detachment of the myofibrils from the muscle fiber bundles, which is caused mainly by electrical stunning or stimulation and improper conditioning following slaughter [24].

Rehydration is maximized when cellular and structural disruption such as shrinkage is minimized [86]. Chang et al. [23] illustrates the morphological changes that occur in the appearance of muscle fiber bundles during cooking and drying in a convection-heated rotary dryer. They found that after cooking, the fibers are bound together in a compact bundle. The bundle size is gradually reduced due to the effects of heating and tumbling during the early stage of predrying in the modified clothes dryer. Apparently, the bundle size is expanded with the endomysial capillary moisture being removed during drying.

### 18.5.7 Case Hardening or Crust Formation

During drying, the concentration of moisture in the outer layers of foods is less than in the interior, since the outer layers necessarily lose moisture before the interior. This surface shrinkage causes checking, cracking, and warping. This type of shrinkage causes moisture gradient and resistance near the surface. In extreme cases, shrinkage and drop in diffusivity may combine to yield a skin practically impervious to moisture, which encloses the volume of the material so that the interior moisture cannot be removed. This is called case hardening. In food processing, case hardening is also commonly known as crust formation. The extent of crust formation can be reduced by maintaining flattening moisture gradients in the solid, which is a function of drying rate. The faster the drying rate, the thinner the crust [3]. Crust (or shell) formation may be either desirable or undesirable in dried food products. In microencapsulation of flavors, rapid crust formation is required to prevent flavor losses. Achanta and Okos [3] pointed that crust formation may be inhibited by allowing the drying rate to be slow enough that moisture loss from the product surface is replenished by moisture from the inside. Crust formation is also important in explosion puffing. In this case, the high-moisture product is exposed to rapid drying conditions such as high temperature and vacuum, which create a crust. The impermeable crust, coupled with the extreme drying conditions, results in rapid moisture vaporization and causes large internal pressures to build up, resulting in product expansion/puffing. During the expansion stage, stress buildup in the glassy surface may cause the surface to crack, allowing vapor to escape.

### 18.5.8 Shrinkage or Collapse and Pore Formation

Two types of shrinkage are usually observed in the case of food materials—*isotropic* and *anisotropic* shrinkage. *Isotropic* shrinkage can be described as the uniform shrinkage in all geometric dimensions of the materials. *Anisotropic* shrinkage is described as the nonuniform shrinkage in the different geometric dimensions. In many cases, it is important to estimate the changes in all the characteristic geometric dimensions to characterize a material. In the case of muscle, such as in fish and seafood, shrinkage in the direction parallel to the muscle fibers was significantly different from that perpendicular to the fibers during air drying [8,103]. This is different from the *isotropic* shrinkage of most fruits and vegetables.

Shrinkage is an important phenomenon impacting dried food product quality by reducing product wettability, changing product texture, and decreasing product absorbency. Depending on the end use, crust and pore formation may be desirable or undesirable. If a long bowl life is required for a cereal product, a crust product that prevents moisture reabsorption may be preferred. If a product (such as dried vegetables in instant noodles) with good rehydration capacity is required, high porosity with no crust is required. Rahman [102] provides the latest on the mechanism of pore formation in foods during drying and related processes. Glass transition theory is one of the proposed concepts to explain the process of shrinkage and collapse during drying and other related processes. According to this concept, there is negligible collapse (more pores) in the material if processed below glass transition and higher the difference between the process temperature and the glass transition temperature, the higher the collapse. The methods of freeze drying and hot-air drying can be compared based on this theory. In freeze drying, since the temperature of drying is below  $T_g'$  (maximally freeze concentrated glass transition temperature), the material is in the glassy state. Hence shrinkage is negligible. As a result, the final product is very porous. In hot-air drying, since the temperature of drying is above  $T_g'$  or  $T_g$ , the material is in the rubbery state and substantial shrinkage occurs. Hence, the food produced from hot-air drying is dense and shriveled [3]. However, the glass transition theory does not hold good for all products. Other concepts such as surface tension, structure, environment pressure, and mechanisms of moisture transport also play important roles in explaining the formation of pores. Rahman [102] hypothesized that as capillary force is the main force responsible for collapse, so counterbalancing of this force causes formation of pores and lowers shrinkage. The counterbalancing forces are due to the generation of internal pressure, variation in moisture transport mechanism, and environmental pressure. Other factors could be the strength of the solid matrix (i.e., ice formation, case hardening, and matrix reinforcement).

### 18.5.9 Stress Development and Cracking or Breakage

During air drying, stresses are formed due to nonuniform shrinkage resulting from nonuniform moisture and temperature distributions. This may lead to stress crack formation when stresses exceed a critical level. Crack formation is a complex process influenced interactively by heat and moisture transfer, physical properties, and operational conditions [70]. The relative humidity of air and temperature are the most influential parameters that need to be controlled to eliminate the formation of cracks.

Checking and breakage of dried foods has two undesirable consequences—loss of valuable product and loss of consumer satisfaction [3]. Cracking is detrimental to grain quality since the affected kernels are more susceptible to mold attack during storage and pathogenic invasion after seeding. Cracked grains are also of lower organoleptic quality, which limits their use in direct food preparation. Internal cracking in the starchy endosperm of a grain is induced by mechanical stress due to the high humidity gradient inside the kernel and thermal stress. The fissure is a large internal fracture usually found to be perpendicular to the long axis of the grain [126]. The drying rate, which is a function of drying temperature and humidity, is the main cause of fissures [17,32,120]. The process of fissuring also continues after drying. Most fissuring occurs within 48 h after drying, but additional fissures develop at a low rate for another 72 h thereafter [65]. In microwave drying, stress cracking can be even more pronounced due to superposition of the pressure gradient that may build up within the material under certain drying conditions [141]. In the case of wheat, it also depends on the variety

[64]. The high-humidity air damages grains to a lesser extent than low-humidity air. Grains are severely damaged by high drying temperatures [130].

In the case of plant materials also, cracks are formed. At higher drying rates, the outer layers of the material becomes rigid and the final volume is fixed early in the drying process. As drying proceeds, the tissues split and rupture internally forming an open structure, and cracks are formed in the inner structure. When the interior finally dries and shrinks, the internal stresses pull the tissue apart [147]. Initial structure before drying can also create different extent of cracks, both inside as well as on the surface.

### 18.5.10 Rehydration

Rehydration is a process of moistening dry material. It is mostly done by applying an abundant amount of water. In most cases, dried foods are soaked in water before cooking or consumption, thus rehydration is one of the important quality criteria. In practice, most of the changes during drying are irreversible and rehydration cannot be considered simply as a process reversible to dehydration [69]. In general, absorption of water is fast at the beginning and thereafter slows down. This rapid moisture uptake is due to surface and capillary suction. Rahman and Perera [107], and Lewicki [69] reviewed the factors affecting the rehydration process. The factors are porosity, capillaries and cavities near the surface, temperature, trapped air bubbles, amorphous–crystalline state, soluble solids, dryness, anions, and pH of the soaking water. Porosity, and capillaries and cavities near the surface enhance the rehydration process, whereas the presence of trapped air bubbles is a major obstacle to the invasion of the fluid. Until the void or air cavities are filled with water, water penetrates to the material through its solid phase. In general, temperature strongly increases the early stages of water rehydration. There is a resistance of crystalline structures to salivation, whereas amorphous regions hydrate fast. The presence of anions in water affects volume increase during water absorption.

### 18.5.11 Volatile Development or Retention

In addition to physical changes, drying generates flavor or releases flavor from the foods. Drying changes the composition of volatiles by evaporating most volatiles and forming new volatile odor compounds by chemical reactions [72,143]. Such changes in volatiles might affect the aroma of fresh foods after drying, such as off-flavors were produced in peanut when drying air temperatures were above 35°C. In the case of peanut, they observed that the amount of off-flavor detected appeared to be a function of drying air temperature, moisture content, and off-flavor was likely to occur in immature peanuts than in mature peanuts [87]. Off-flavors resulting from high-temperature drying can be passed on to peanut butter and roasted peanuts. Acetaldehyde and ethyl acetate may be better indicators of off-flavor. High-temperature drying of pasta also leads to off-color and off-flavor [110].

A substantial volatile loss occurred during the first three stages of spray drying, and there should be zero or very little loss of volatiles during the fourth stage due to selective diffusion [62]. Losses can occur during atomization, from undisturbed drops, and as a result of morphological development. Several factors affect volatile retention, including control of atomizer pressure or rotation speed, choice of spray angle, configuration of air input, alteration of air temperature profile, feed concentration, presence of an oil phase and suspended solids, foaming of the feed, feed composition, surfactant, and steam blanketing of the atomizer [60–62]. The retention increased with increasing initial concentration of solids, increasing air temperature and velocity, and decreasing humidity. This is due to the selective diffusion mechanism, when surface water content is reduced sufficiently so that the diffusion coefficients of volatile substances become substantially lower than that of water [60,61].

### 18.5.12 Solubility

Many factors affect solubility, including processing conditions, storage conditions, composition, pH, density, and particle size. It was found that an increase in drying temperature is accompanied by increasing protein denaturation, which decreases solubility. Thus, more protein is denatured and solubility decreased [86]. Removal of water by evaporation results in the formation of an amorphous state.



### **18.5.13 Caking and Stickiness**

Caking and stickiness of powders, desirable or undesirable, occur in dried products. Caking is desirable for tablet formation and undesirable when a dry free-flowing material is required. To reduce caking during drying, a logical option is to dry rapidly so that the moisture content drops to a level where caking is inhibited. The rapid drying will form a crust, which may be undesirable, thus product optimization or solutes in product formulation may be considered. Tendencies to form surface folds on particles during spray drying are governed by the viscosity of the concentrated solution. Stickiness and agglomeration tendencies also depend upon the viscosity of the concentrated solution, surface tension, particle size, and exposure time [61]. For viscosities below the critical value, stickiness usually occurs. The predicted critical viscosity was within the range of  $10^8$ – $10^{10}$  Pa s. The mechanism of sticking and agglomeration was postulated through viscous flow driven by surface tension and forming bridges between particles [31]. Adhikari et al. [4] presented a complete review on stickiness in foods, including mechanisms and factors controlling the process. The main factors affecting stickiness are temperature, viscosity, and water, followed by low-molecular sugars, organic acids, and compaction or pressure. The use of a glass transition temperature-based model provides a rational basis for understanding and characterizing the stickiness of many foods.

### **18.5.14 Texture**

Factors that affect texture include moisture content, composition, variety or species, pH, product history (maturation or age), and sample dimensions. Texture is also dependent on the method of dehydration and pretreatments. Purslow [99] stated that meat texture is affected by the structure of the solid matrix. He concluded that it is important to have a fundamental understanding of the fracture behavior of meat and how it relates to the structure of the material. Stanley [132] stated that many researchers now believe the major structural factors affecting meat texture are associated with connective tissues and myofibrillar proteins. Moreover, two other components—muscle membranes and water—also deserve consideration not because of their inherent physical properties, but rather as a result of the indirect influence they have on the physical properties. It should be noted that sarcoplasmic proteins could be important for the same reason, although little information on their role is available. He suggested that these structures merit particular attention.

Kuprianoff [66] referred to the possible adverse effects of removing bound water from foods as (i) denaturation of protein by concentration of the solutes, (ii) irreversible structural changes leading to textural modification upon rehydration, and (iii) storage stability problems. Stanley [132] stated that the water-holding capacity of muscle is related to its sorption properties. The bound water in the muscle is primarily a result of its association with the myofibrillar proteins as indicated by Wismer-Pedersen [151]. Protein–water interactions significantly affect the physical properties of meat [46]. Changes in water-holding capacity are closely related to pH and the nature of muscle proteins.

### **18.5.15 Vitamins Retention**

In general, losses of B vitamins are usually less than 10% in dried foods. Dried foods do not greatly contribute to dietary requirements for thiamin, folic acid, and vitamin B-6. Although vitamin C is largely destroyed during drying due to heating, meat per se is not a good source [22]. From nonfatty vegetables, such as cabbage, as much water as possible should be removed, because this helps to conserve ascorbic acid. The loss of vitamin A and ascorbic acid in dried products could be avoided in the absence of oxygen. Even though most amino acids are fairly resistant to heating–drying, lysine is quite heat labile and likely to be borderline or low in the diet of humans and especially so in developing countries where high-quality animal proteins are scarce and expensive [34].

### **18.5.16 Color Retention or Development**

High temperature and long drying time degrade a product's original color. Color in foods can be preserved by minimal heat exposure or applying high temperature and short time with pH adjustment.

Water activity is one of the important factors degrading chlorophyll. Another cause of color degradation may be due to enzymatic browning causing rapid darkening, mainly of the leafy portions. The formation of dark pigments via enzymatic browning is initiated by the enzyme polyphenol oxidase (PPO). Another reason for discoloration is photooxidation of pigments, caused by light in combination with oxygen.

---

## References

1. Abdelhaq, E. H. and Labuza, T. P. 1987. Air drying characteristics of apricots. *J. of Food Sci.* 52: 342–360.
2. Abu-Bakar, A., Abdullah, M. Y. and Azam, K. 1994. The effects of caramel on the quality of smoked fish. *ASEAN Food J.* 9(3): 116–119.
3. Achanta, S. and Okos, M. R. 1996. Predicting the quality of dehydrated foods and biopolymers – research needs and opportunities. *Drying Technol.* 14(6): 1329–1368.
4. Adhikari, B., Howes, T., Bhandari, B. R. and Truong, V. 2001. Stickiness in foods: a review of mechanisms and test methods. *Int. J. Food Prop.* 4(1): 1–33.
5. Alzamora, S. M., Hough, G. and Chirife, J. 1985. Mathematical prediction of leaching losses of water-soluble vitamins during blanching of peas. *J. Food Technol.* 20: 251–262.
6. Arganosa, F. C. and Ockerman, H. W. 1987. The influence of curing ingredients, packaging method and storage on the biochemical and sensory qualities and acceptability of a dried beef product. *J. Food Process. Preserv.* 12: 45–51.
7. Axtell, B. 1996. *Int. Technol. Food Chain.* 19: 10–11.
8. Balaban, M. and Pigott, G. M. 1986. Shrinkage in fish muscle during drying. *J. Food Sci.* 51(2): 510–511.
9. Banks, A. 1950. *J.S.F.A.* 1: 28–34.
10. Bayrock, D. and Ingledew, W. M. 1997. Fluidized bed drying of baker's yeast: moisture levels, drying rates, and viability changes during drying. *Food Res. Int.* 30(6): 407–415.
11. Bayrock, D. and Ingledew, W. M. 1997. Mechanism of viability loss during fluidized bed drying of baker's yeast. *Food Res Int.* 30(6): 417–425.
12. Beedie, M. 1995. Energy savings – a question of quality. *S. Afr. J. Food Sci. Technol.* 48(3): 14, 16.
13. Beveridge, T. and Weintraub, S. E. 1995. Effect of blanching pretreatment on color and texture of apple slices at various water activity. *Food Res. Int.* 28: 83–86.
14. Biekman, E. S. A., Kroese-Hoedeman, H. I. and Schijvens, E. P. H. M. 1996. Loss of solutes during blanching of mushrooms (*Agaricus bisporus*) as a result of shrinkage and extraction. *J. Food Eng.* 28: 139–152.
15. Bolin, H. R. and Jackson, R. 1985. Factors affecting sulfur dioxide binding in dried apples and apricots. *J. Food Process. Preserv.* 9: 25–34.
16. Bolin, H. R., Petrucci, V. and Fuller, G. 1975. Characteristics of mechanically harvested raisins produced by dehydration and by field drying. *J. Food Sci.* 40: 1036.
17. Bonazzi, C., Courtois, F., Geneste, C., Pons, B., Lahon, M. C. and Bimbenet, J. J. 1994. Experimental study on the quality of rough rice related to drying conditions. In: *Drying '94*, Rudolph, V., Keey, R. B., Mujumdar, A. S., Eds. Drying Symposium, Gold Coast, Australia. pp. 1031–1036.
18. Britnell, P., Birchall, S., Fitz-Payne, S., Young, G., Mason, R. and Wood, A. 1994. The application of heat pump dryers in the Australian food industry. In: *Drying 94*, Rudolph, V., Keey, R. B., Mujumdar, A. S., Eds. Drying Symposium, Gold Coast, Australia. pp. 897–904.
19. Burroughs, L. F. and Sparks, A. H. 1973. Sulphite-binding power of wines and ciders, III. Determination of carbonyl compounds in a wine and calculation of its sulphite-binding power. *J. Sci. Food Agric.* 24: 207.
20. Cerf, O., Davey, K. R. and Sadoudi, A. K. 1996. Thermal inactivation of bacteria – a new predictive model for the combined effect of three environmental factors: temperature, pH and water activity. *Food Res. Int.* 29(3,4): 219, 226.
21. Chambers, T. C. and Possingham, J. V. 1963. Studies of the fine structure of the wax layer of sultana grapes. *Aust. J. Biol. Sci.* 16: 818–25.
22. Chang, S. F., Huang, T. C. and Pearson, A. M. 1996. Control of the dehydration process in production of intermediate-moisture meat products: a review. *Adv. Food Nutrition Res.* 39: 71–161.
23. Chang, S. F., Huang, T. C. and Pearson, A. M. 1991. Some parameters involved in production of Zousoon – a semi-dry, long fibered pork product. *Meat Sci.* 30: 303–325.

24. Chang, S. F. and Pearson, A. M. 1992. Effect of electrical stunning or sticking without stunning a microstructure of zousoon, a Chinese semi dry pork product. *Meat Sci.* 31(3): 309–326.
25. Cohen, J. S. and Yang, T. C. S. 1995. Progress in food dehydration. *Trends Food Sci. Technol.* 6: 20–25.
26. Coumans, W. J. and Kruf, W. M. A. 1994. Transport parameters and shrinkage in paper drying. *Drying '94*, Proceedings of the 9th International Drying Symposium, Gold Coast, Australia. 1994. p. 1205.
27. Crank, J. 1958. Some mathematical diffusion studies relevant to dehydration, *Fundamental Aspects of Dehydration of Foodstuffs*. Macmillan, London. pp. 37.
28. Decareau, R. V. 1985. *Microwave in the Food Processing Industry*. Academic Press, New York.
29. Del Valle, F. R. and Marco, E. 1988. Production of quality quick-cooking beans by a cooking/dehydration process. *J. Food Process. Preserv.* 12: 83–93.
30. Deng, J., Toledo, R. T. and Lillard, A. Effect of smoking temperatures on acceptability and storage stability of smoked Spanish mackere. 1974. *J. Food Sci.* 39(3): 596–601.
31. Downton, G. E., Flores-Luna, J. L. and King, C. J. 1982. Mechanism of stickiness in hygroscopic, amorphous powders. *Ind. Eng. Chem. Fundam.* 21: 447.
32. Du-Peuty, M. A., Themelin, A., Cruz, J. F., Arnaud, G. and Fohr, J. P. 1996. Improvement of paddy quality by optimizing of drying conditions. *Drying '94*, Proceedings of the 9th International Drying Symposium, Gold Coast, Australia. p. 929.
33. Dutton, H. J., Baily, G. F. and Kohake, E. 1943. Dehydrated spinach. *Ind. Eng. Chem.* 35: 1173–1177.
34. Erbersdobler, H. F. 1986. In: *Concentration and Drying of Foods*. MacCarthy, D., Ed. Elsevier, London. pp. 69–87.
35. Erle, U. and Schubert, H. 2001. Combined osmotic and microwave-vacuum dehydration of apples and strawberries. *J. Food Eng.* 49: 193–199.
36. Fox, B. A. and Cameron, A. G. 1982. *Food Science a Chemical Approach*. Hodder and Stoughton, London.
37. Frazier, W. C. and Westhoff, D. C. 1978. *Food Microbiology, 3rd Edition*. McGraw-Hill, New York.
38. Gaillard, S., Leguerinel, I. and Mafart, P. 1998. Modelling combined effects of temperature and pH on the heat resistance of spores of *Bacillus cereus*. *Food Microbiol.* 15: 625–630.
39. Gorling, P. 1956. Drying behavior of vegetable substances. *V. D. I. Forsch. Gebiete Ingenieurw.* 22: 5.
40. Gorling, P. 1958. Physical phenomena during the drying of foodstuffs. *Fundamental Aspects of Dehydrated Foods*. Macmillan, London. p. 42.
41. Grncarevic, M., Radler, F. and Possingham, J. V. 1968. The dipping effect causing increased drying of grapes demonstrated with an artificial cuticle. *Am. J. Enol. Vitic.* 19: 27.
42. Grote, M. and Fromme, H. G. 1984. Electron microscopic investigations of the cell structure in fresh and processed vegetables (carrots and green bean pods). *Food Microstructure.* 3: 55–64.
43. Guillen, M. D. and Ibargoitia, M. L. 1996. Volatile components of aqueous liquid smokes from *Vitis vinifera* L. shoots and *Fagus sylvatica* L. wood. *J. Sci. Food Agric.* 72(1): 104–110.
44. Guillen, M. D. and Manzanos, M. J. 1999. Smoke and liquid smoke. Study of an aqueous smoke flavoring from the aromatic plant *Thymus Vulgaris* L. *J. Sci. Food Agric.* 79: 1267–1274.
45. Haas, G. J., Prescott, H. E. and Cante, C. J. 1974. On rehydration and respiration of dry and partially dried vegetables. *J. Food Sci.* 39: 681–684.
46. Hamm, R. 1960. Biochemistry of meat hydration. *Adv. Food Res.* 10: 355–463.
47. Hansen, L. T., Rontved, S. D. and Huss, H. H. 1998. Microbiological quality and shelf life of cold smoked salmon from three different processing plants. *Food Microbiol.* 15(2): 137–150.
48. Harrington, W. O., Hills, C. H., Jones, S. B., Stafford, A. E. and Tennes, B. R. 1978. Ethyl oleate sprays to reduce cracking of sweet cherries. *HortScience* 13(3): 279–280.
49. Hawlader, M. N. A., Perera, C. O., Tian Min, Ong, B. K. and Chung, K. J. 2004. Heat pump drying under inert atmosphere. *Proceedings of the International Drying Symposium 2004*, Sao Paulo, Brazil, August 22–25, Vol A. pp. 309–316.
50. Hawlader, M. N. A., Perera, C. O. and Tian Min. 2006. Properties of modified atmosphere heat pump dried foods. *J. Food Eng.* 74(3): 392–401.
51. Hilderbrand, K. S. 1992. Fish smoking procedures for forced convection smokehouses. Special report 887, Oregon State University Extension Service. Newport, Oregon.
52. Hsieh, Y. C., Pearson, A. M., Morton, I. D. and Magee, W. T. 1980. Some changes in the constituents upon heating a model meat flavour system. *J. Sci. Food Agric.* 31: 943–949.

53. Hsieh, Y. P. C., Cornforth, D. P. and Pearson, A. M. 1980. Ultrastructural changes in pre- and post-rigor beef muscle caused by conventional and microwave cookers. *Meat Sci.* 4: 299–311.
54. IFT. 1990. Expert panel on food safety and nutrition. Quality of fruits and vegetables, scientific status summary. *Food Technol.* 6: 99–106.
55. Imre, L. L. 1987. Solar drying. In: *Handbook of Industrial Drying*. Mujumdar, A. S., Ed. Marcel Dekker, New York. p. 357.
56. Jackson, J. C., Bourne, M. C. and Barnard, J. 1996. Optimization of blanching for crispness of banana chips using response surface methodology. *J. Food Sci.* 61(1): 165–166.
57. Jarvis, D. 1987. In: *Curing of Fishery Products*. Teaparty Books, Kingston, MA.
58. Juneja, V. K. and Marmer, B. S. 1998. Thermal inactivation of *Clostridium Perfringens* vegetative cells in ground beef and turkey as affected by sodium pyrophosphate. *Food Microbiol.* 15: 281–287.
59. Karel, M. 1986. In: *Concentration and Drying of Foods*. MacCarthy, D., Ed. Elsevier, London. pp. 37–68.
60. Kieckbusch, T. G. and King, C. J. 1980. Volatiles loss during atomization in spray drying. *AIChE J.* 26: 718.
61. King, C. J. 1984. Transport processes affecting food quality in spray drying. In: *Engineering and Food, Volume 2: Processing and applications*. McKenna, B. M., Ed. Elsevier Applied Science Publishers Ltd., Essex. pp. 559–574.
62. King, C. J. 1994. Spray drying: retention of volatile compounds revisited. In: *Drying '94*. Proceedings of the 9th International Drying Symposium (IDS '94), Gold Coast, Australia, August 1–4. pp. 15–26.
63. Kompany, E., Allaf, K., Bouvier, J. M., Guigon, P. and Maureaux, A. 1991. A new drying method of fruits and vegetables-quality improvement of the final product. In: *Drying '91*. Mujumdar, A. S. and Filkov, I., Eds. Elsevier Science Publishers, Amsterdam. pp. 499–505.
64. Kudra, T., Niewczas, J., Szot, B. and Raghavan, G. S. V. 1994. Stress cracking in high-intensity drying: identification and quantification. In: *Drying '94*. Rudolph, V., Keey, R. B., Mujumdar, A. S., Eds. Proceedings of the 9th International Drying Symposium, Gold Coast, Australia. p. 809.
65. Kunze, O. R. 1979. Fissuring of the rice grain after heated air drying. *Trans. ASAE.* 22: 1197.
66. Kuprianoff, J. 1958. *Fundamental Aspects of Dehydration of Foodstuffs*. Society of Chemical Industry, London.
67. Lee, C. Y., Salunkhe, D. K. and Nury, F. S. 1967. Some chemical and histological changes in dehydrated apple. *J. Sci. Food Agric.* 18: 89–93.
68. Lee, M., Chou, L. and Huang, J. 1994. The effect of salt on the surface evaporation of a porous medium, *Drying '94*, Proceedings of the 9th International Drying Symposium, Gold Coast, 1994. p. 223.
69. Lewicki, P. P. 1998. Effect of pre-drying treatment, drying and rehydration on plant tissue properties: a review. *Int. J. Food Properties.* 1(1): 1–22.
70. Liu, H., Zhou, L. and Hayakawa, K. 1997. Sensitivity analysis for hygrostress crack formation in cylindrical food during drying. *J. Food Sci.* 62(3): 447–450.
71. Lopez, M., Martinez, S., Gonzalez, J., Martin, R. and Bernado, A. 1998. Sensitization of thermally injured spores of *Bacillus Stearothermophilus* to sodium benzoate and potassium sorbate. *Lett. Appl. Microbiol.* 27: 331–335.
72. Luning, P. A., Yuksel, D., De Vries, R. V. D. V. and Roozen, J. P. 1995. Aroma changes in fresh bell peppers (*Capsicum annuum*) after hot-air drying. *J. Food Sci.* 60: 1269–1276.
73. Maharaj, V. and Sankat, C. K. 1996. Quality changes in dehydrated dasheen leaves: effects of blanching pre-treatments and drying conditions. *Food Res. Int.* 29: 563.
74. Mason, R. L. 1989. Application of heat pumps to drying food products. *Food Aust.* 41(12): 1070–1071.
75. Mason, R. L., Britnell, P. M., Young, G. S., Birchall, S., Fitz-Payne, S. and Hesse, B. J. 1994. Development and application of heat pump dryers to Australian food industry. *Food Aust.* 46(7): 319–322.
76. McCabe, W. L. and Smith, J. C. 1976. *Unit Operations of Chemical Engineering, 3rd edition*. McGraw-Hill Book Company, New York.
77. McIlveen, H. and Valley, C. 1996. Something's smoking in the development kitchen. *Nutrition Food Sci.* 96(6): 34–38.
78. Mohamed, S. and Hussein, R. 1994. Effect of low temperature blanching, cysteine-HCl, N-acetyl-L-cysteine, Na metabisulphite and drying temperatures on the firmness and nutrient content of dried carrots. *J. Food Process. Preserv.* 18: 343–348.
79. Moreira, R. et al. 1998. In: *Drying '98*. Proceedings of the 11th International Drying Symposium (IDS '98), Halkidiki, Greece, August 19–22, vol. B. pp. 1108–1114.

80. Moreira, R. G. 2001. Impingement drying of foods using hot air and superheated steam. *J. Food Eng.* 49: 291–295.
81. Moret, S. Contre, L. and Dean, D. 1999. Assessment of polycyclic aromatic hydrocarbon content of smoked fish by means of a fast HPLC/HPLC method. *J. Agric. Food Chem.* 47(4): 1367–1371.
82. Moyls, A. L. 1981. Drying of apple purees. *J. Food Sci.* 46: 939.
83. Mujumdar, A. S. 1986. Impingement drying. In: *Handbook of Industrial Drying*. Marcel Dekker, New York.
84. Nijhuis, H. H., Tiringa, E., Luyten, H., Rene, F., Jones, P., Funebo, T. and Ohlsson, T. 1996. Research needs and opportunities in the dry conservation of fruits and vegetables. *Drying Technol.* 14: 1429–1457.
85. O’Neill, M. B., Rahman, M. S., Perera, C. O., Smith, B. and Melton, L. D. 1998. Color and density of apple cubes in air and modified atmosphere. *Int. J. Food Prop.* 1(3): 197–205.
86. Okos, M. R., Bell, L., Castaldi, A., Jones, C., Liang, H., Murakami, E., Pflum, J., Waananen, K., Bogusz, J., Franzen, K., Kim, M., Litchfield, B., Narsimhan, G., Singh, R. and Xiong, X. 1989. Design and Control of Energy Efficient Food Drying Processes with Specific Reference to Quality. Report Purdue University, Indiana.
87. Osborn, G. S., Young, J. H. and Singleton, J. A. 1996. Measuring the kinetics of acetaldehyde, ethanol, and ethyl acetate within peanut kernels during high temperature drying. *Trans. ASAE.* 39(3): 1039–1045.
88. Pan, Y. K., Pang, J. Z., Mujumdar, A. S. and Kudra, T. 1994. Drying of heat-sensitive bio-products on solid carriers in vibrated fluid bed. In: *Drying 94*. Rudolph, V., Keey, R. B., Mujumdar, A. S., Eds. Drying Symposium, Gold Coast, Australia. pp. 819–824.
89. Paterson, L., Mitchell, J. R., Hill, S. E. and Blanshard, J. M. V. 1996. Evidence for sulfite induced oxidative depolymerisation of starch polysaccharides. *Carbohydr. Res.* 292: 143–151.
90. Perera, C. O. and Rahman, M. S. 1997. Heat pump drying. *Trends Food Sci. Technol.* 8(3): 75.
91. Perera, C. O. 2001. Modified atmosphere drying of fruits and vegetables. Proceedings of the 2nd Asian-Oceania Drying Conference. Penang, Malaysia, 2001.
92. Perera, C. O. 2004. Modified atmosphere heat pump drying of food products. In: *Dehydration of Products of Biological Origin, Chapter 6*. Mujumdar, A. S., Ed. Science Publishers Inc., Enfield, NH, USA. pp. 153–163.
93. Petrucci, V., Canata, N., Bolin, H. R., Fuller, G. and Stafford, A. E. 1974. Use of oleic acid derivatives to accelerate drying of Thompson seedless grapes. *J. Am. Oil Chem.* 51: 77.
94. Platin, B. E., Erden, A. and Gulder, O. L. 1982. Modelling and design of rotary dryers. In: *Proceedings of the Third International Drying Symposium, vol. 2*. Ashworth, J. C., Ed. Drying Research Ltd., Wolverhampton, England. pp. 466–477.
95. Ponting, J. D. and McBean, D. M. 1970. Temperature and dipping treatment effects on drying rates and drying times of grapes, prunes and waxy fruits. *Food Technol.* 24: 1403–1406.
96. Potter, N. N. 1986. *Food Science*. AVI Publication, CT.
97. Prestamo, G. and Fuster, C. 1984. Proceedings of the IUFost International Symposium on Chemical Changes During Food Processing 1. p. 269.
98. Prichavudhi, K. and Yamamoto, H. Y. 1965. Effect of drying temperature on chemical composition and quality of macadamia nuts. *Food Technol.* 19: 1153.
99. Purslow, P. P. 1987. The fracture behaviour of meat – a case study. In: *Food Structure and Behaviour*. Blanshard, J. M. V. and Lillford, P., Eds. Academic Press Ltd., London. pp. 177–197.
100. Quintero-Ramos, A., Bourne, M. C. and Anzaldua-Morales, A. 1992. Texture and rehydration of dehydrated carrots as affected by low temperature blanching. *J. Food Sci.* 57: 1127.
101. Rahman, M. S. 1995. *Food Properties Handbook*. CRC Press, Boca Raton, FL.
102. Rahman, M. S. 2001. Towards prediction of porosity in foods during drying: a brief review. *Drying Technol.* 19(1): 3–15.
103. Rahman, M. S. and Potluri, P. L. 1990. Shrinkage and density of squid flesh during air drying. *J. Food Eng.* 12(2): 133–143.
104. Rahman, M. S., Al-Amri, O. S. and Al-Bulushi, I. 2002. Pores and physico-chemical characteristics of dried tuna produced by different methods of drying. *J. Food Eng.* 53: 301–313.
105. Rahman, M. S., Guizani, N. and Al-Ruzeiki, M. H. 2004. D- and Z-values of microflora in tuna mince during moist- and dry-heating. *Food Sci. Technol.* 37: 93–98.
106. Rahman, M. S., Guizani, N., Al-Ruzeiki, M. H. and Al-Khalasi, S. 2000. Microflora changes in tunas during convection air drying. *Drying Technol.* 18(10): 2369–2379.
107. Rahman, M. S. and Perera, C. O. 1999. Drying and food preservation. In: *Handbook of Food Preservation*. Rahman, M. S., Ed. Marcel Dekker, New York. pp. 173–216.

108. Rahman, M. S., Salman, Z., Kadim, I. T., Mothershaw, A., Al-Riziqi, M. H., Guizani, N., Mahgoub, O. and Ali, A. 2005. Microbial and physico-chemical characteristics of dried meat processed by different methods. *Int. J. Food Eng.* 1(2): 1–13.
109. Raouzeos, G. S. and Saravacos, G. D. 1986. Solar drying of raisins. *Drying Technol.* 4(4): 633–649.
110. Resmini, P., Pagani, M. A. and Pellegrino, L. 1996. Effect of semolina quality and processing conditions on nonenzymatic browning in dried pasta. *Food Aust.* 48(8): 362–367.
111. Rillo, B. O., Magat, R. P., Miguel, M. M. S. and Diloy, M. L. 1988. Microbiological quality of dried salted mackerel (*Rastrelliger brachosomus*). In: *Food Science and Technology in Industrial Development*. Maneepun, S., Varagoon, P. and Phithakpol, B., Eds. Institute of Food Research and Product Development, Bangkok. pp. 690–694.
112. Riva, M. and Peri, C. 1983. A study of grape drying 1-effect of dipping treatments on drying rate. *Sci. Des Aliments.* 3: 527–550.
113. Roos, Y. and Karel, M. 1992. Crystallization of amorphous lactose. *J. Food Sci.* 57(3): 775–777.
114. Ross, L. R. and Treadway, R. H. 1961. Factors affecting the sulfur dioxide uptake in sulfited pre-peeled potatoes. *Amer. Potato J.* 38: 9.
115. Rowe, R. W. D. 1989. Electron microscopy of bovine muscle, I- The native state of post rigor sarcolemma and endomysium. *Meat Sci.* 26(4): 271–279.
116. Rowe, R. W. D. 1989. Electron microscopy of bovine muscle, II- The effect of heat denaturation on post rigor sarcolemma and endomysium. *Meat Sci.* 26(4): 281–294.
117. Sablani, S. S., Rahman, M. S., Haffar, I., Mahgoub, O., Al-Marzouki, A. S., Al-Ruzeiqi, M. H., Al-Habsi, N. H. and Al-Belushi, R. H. 2003. Drying rates and quality parameters of fish sardines processed using solar dryers. *Agric. Marine Sci.* 8(2): 79–86.
118. Salwin, H. 1960. Defining minimum moisture contents for dehydrated foods. *Food Technol.* 13: 594–595.
119. Saravacos, G. D. and Charm, S. E. 1962. A study of the mechanism of fruit and vegetable dehydration. *Food Technol.* 1: 78.
120. Sarker, N. N., Kunze, O. R. and Strouboulis, T. 1996. Transient moisture gradients in rough rice mapped with finite element model and related to fissures after heated air drying. *Trans. ASAE.* 39(2): 625–631.
121. Schaffner, D. W. and Labuza, T. P. 1997. Predictive microbiology: where are we, and where are we going. *Food Technol.* 51(4): 95–99.
122. Schmidt, G. R., Mawson, R. F. and Siegel, D. G. 1981. *Food Technol.* 35(5): 235.
123. Sebranek, J. G. 1988. *Meat Science and Processing*. Paladin House, WI.
124. Sefa-Dedeh, S. 1993. In: *Encyclopedia of Food Science, Technology and Nutrition*. Macrae, R., Robinson, R. and Sadler, M., Eds. Academic Press, New York. pp. 4600–4606.
125. Shamaila, M., Durance, T. and Girard, B. 1996. Water blanching effects on headspace volatiles and sensory attributes of carrots. *J. Food Sci.* 61(6): 1191–1195.
126. Sharma, A. D. and Kunze, O. R. 1982. Post-drying fissure developments in rough rice. *Trans. ASAE.* 25: 465.
127. Sheehan, E. M., Connor, T. P. O., Sheehy, P. J. A., Buckley, D. J. and FitzGerld, R. 1996. Effect of dietary fat intake on the quality of raw and smoked salmon. *Ir. J. Agric. Food Res.* 35: 37–42.
128. Silliker, J. H., Elliott, R. P., Baird-Parker, A. C., Bryan, F. L., Christian, J. H. B., Clark, D. S., Olson, J. C. and Roberts, T. A., Eds. 1980. In: *Microbial Ecology of Foods. Volume 1: Factors Affecting Life and Death of Microorganisms*. Academic Press, New York.
129. Simatos, D. and Karel, M. 1988. In: *Food Preservation by Moisture Control*. Seoe, C. C., Ed. pp. 1–41.
130. Sokhansanj, S. 1982. Quality of food grains in recirculating hot-air dryers. In: *Proceedings of the 3rd International Drying Symposium, vol. 2*. Ashworth, J. C., Ed. Drying Research Ltd., Wolverhampton. p. 253.
131. Stafford, A. E. and Bolin, H. R. 1972. Absorption of aqueous bisulfite by apricots. *J. Food Sci.* 37: 941–943.
132. Stanley, D. W. 1983. Relation of structure to physical properties of animal material. In: *Physical Properties of Foods*. Peleg, M. and Bagley, E. B., Eds. AVI Publishing Co. Inc., CT. p. 157.
133. Strommen, I. 1982. New equipment in fish drying. In: *Proceedings of the Third Drying Symposium, vol. 1*. Ashworth, J. C., Ed. Drying Research Ltd., Wolverhampton, England. pp. 295–299.
134. Strumillo, C. and Lopez-Cacicedo, C. 1987. Energy aspects in drying. In: *Handbook of Industrial Drying*. Mujumdar, A. S., Ed. Marcel Dekker, NY. pp. 823–862.
135. Su, H. L. and Chang, K. C. 1995. Dehydrated precooked pinto bean quality as affected by cultivar and coating biopolymers. *J. Food Sci.* 60(6): 1330–1332.

136. Sunen, E. 1998. Minimum inhibitory concentration of smoke wood extracts against spoilage and pathogenic micro-organisms associated with foods. *Lett. Appl. Microbiol.* 27(1): 45–48.
137. Szabo, E. A. and Cahill, M. E. 1999. Nisin and ALTATM 2341 inhibit the growth of *Listeria monocytogenes* on smoked salmon packaged under vacuum or 100% CO<sub>2</sub>. *Lett. Appl. Microbiol.* 28: 373–377.
138. Treybal, R. E. 1981. *Mass Transfer Operations, 3rd edition*. McGraw-Hill, Singapore.
139. Trongpanich, K. 1993. Effect of pretreatments on texture of dehydrated bamboo shoot. In: *Development of Food Science and Technology in South East Asia*. Liang, O. B., Buchanan, A. and Fardiaz, D., Eds. IPB Press, Bogor. pp. 485–494.
140. Tulasidas, T. N., Raghavan, G. S. V. and Norris, E. R. 1996. Effects of dipping and washing pre-treatments on microwave drying of grapes. *J. Food Process. Eng.* 19: 15–25.
141. Turner, I. W. and Jolly, P. G. 1991. Combined microwave and convective drying of a porous material. *Drying Technol.* 9: 1209.
142. Van Blarcom, A. and Mason, R. L. 1988. Low humidity drying of macademia nuts. *Proceedings of the Fourth Australian Conference on Tree and Nut Crops*. Lismore, NSW. p. 239.
143. Van-Ruth, S. M. and Roozen, J. P. 1994. Gas chromatography/sniffing port analysis and sensory evaluation of commercially dried peppers (*Capsicum annuum*) after rehydration. *Food Chem.* 51: 165.
144. Vega-Mercado, H., Gongora-Nieto, M. M. and Barbosa-Canovas, G. V. 2001. Advances in dehydration of foods. *J. Food Eng.* 49: 271–289.
145. Voyle, C. A. 1981. *Scanning Electron Microscope*. 3: 405.
146. Waananen, K. M. and Okos, M. R. 1991. Analysis of bulk flow transfer. *Technol. Today*. p. 289.
147. Wang, N. and Brennan, J. G. 1995. A mathematical model of simultaneous heat and moisture transfer during drying of potato. *J. Food Eng.* 24(1): 47–60.
148. Weitz, D. A., Lara, M. A. and Piacentini, R. D. 1989. Dipping treatment effects on simulated prune solar drying. *Can. Inst. Food Sci. Technol.* 22(2): 133–136.
149. Wheeler, K. A. and Hocking, A. D. 1993. Interactions among xerophilic fungi associated with dried salted fish. *J. Appl. Bacteriol.* 74: 164–169.
150. Wheeler, K. A., Hoking, A. D., Pitt, J. I. and Anggawati, A. M. 1986. Fungi association with Indonesian dried fish. *Food Microbiol.* 3: 351–357.
151. Wismer-Pedersen, J. 1971. In: *The Science of Meat and Meat Products*. Price, J. F., Schweigert, B. S., Eds. Freeman, San Francisco. pp. 177–191.
152. Woolfe, M. L. 1975. The effect of smoking and drying on the lipids of west African herring (*Sardinella spp.*). *J. Food Technol.* 10: 515–522.

# 19

## *Osmotic Dehydration of Foods*

Mohammad Shafiur Rahman

### CONTENTS

19.1	Osmotic Processes and Their Effects .....	433
19.1.1	Osmotic Dehydration .....	433
19.1.2	Curing by Salts.....	435
19.1.3	Effects of Osmosis on Biological Materials .....	435
19.2	Potential Advantages for Industry .....	436
19.2.1	Quality Improvement .....	436
19.2.2	Energy Efficiency.....	437
19.2.3	Packaging and Distribution Cost Reduction .....	437
19.2.4	Chemical Treatment Not Required .....	437
19.2.5	Product Stability during Storage .....	438
19.3	Factors Affecting Osmotic Dehydration Process .....	438
19.3.1	Types of Osmotic Agents.....	438
19.3.2	Concentration of Osmotic Solution .....	438
19.3.3	Temperature of Osmotic Solution .....	439
19.3.4	Properties of Solute Used in Osmosis .....	439
19.3.5	Agitation of Osmotic Solution.....	439
19.3.6	Material Geometry .....	440
19.3.7	Osmotic Solution and Food Mass Ratio .....	440
19.3.8	Physicochemical Properties of Food Materials .....	440
19.3.9	Operating Pressure and Other Forces .....	441
19.4	Problems in Applying the Osmotic Dehydration Process in the Food Industry .....	441
19.4.1	Product Sensory Quality .....	441
19.4.2	Syrup Management .....	441
19.4.3	Process Control and Design.....	442
	References .....	442

### 19.1 Osmotic Processes and Their Effects

#### 19.1.1 Osmotic Dehydration

Osmotic dehydration of foods has potential advantages in fruit and vegetable processing industries. This dehydration process generally does not produce a product of low moisture content that can be considered shelf stable. Consequently, the osmotically treated product should be further processed (generally by air, freeze-, or vacuum-drying methods) to obtain a shelf-stable product, or the dehydration process could be used as a pretreatment for canning, freezing, and minimal processing.

Osmotic dehydration is the process of water removal by immersion of water-containing cellular solid in a concentrated aqueous solution. The driving force for water removal is the concentration gradient between the solution and the intracellular fluid. If the membrane is perfectly semipermeable, the solute is unable to diffuse through the membrane into the cells. However, it is difficult to obtain a perfect



semipermeable membrane in food systems due to their complex internal structure, and there is always some solute diffusion into the food and leaching out of the food's own solute. Thus, mass transport in osmotic dehydration is actually a combination of simultaneous water and solute transfer processes (see Figure 19.1).

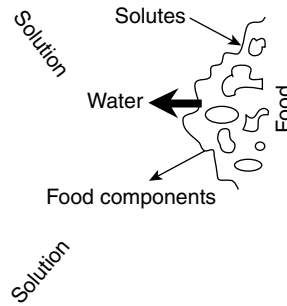


FIGURE 19.1 Water and solutes transfer in osmotic process.

The removal of water during osmotic process is mainly by diffusion and capillary flow, whereas solute uptake or leaching is only by diffusion. The fundamental knowledge for prediction of mass transport is still a gray area, although considerable efforts have been made over the past decade to improve the understanding

of mass transfer in osmotic dehydration [78]. Empirical models have been developed for mass transfer, which are easy to use when kinetics parameters are correlated with dimensionless processing conditions [59,67]. Recently, Rastogi et al. [81] conducted a review on enhanced mass transfer.

The osmotic dehydration process can be characterized by equilibrium and dynamic periods [74]. In the dynamic period, the mass transfer rates are increased or decreased until equilibrium is reached. Equilibrium is the end point of osmotic process, i.e., net rate of mass transport is zero. Rahman [74] proposed equilibrium distribution coefficients for the  $i$ th component as

$$\lambda_i^e = \frac{X_i^e}{Y_i^o} \quad (19.1)$$

where  $\lambda_i^e$  is the distribution coefficient, and  $Y_i^o$  and  $X_i^e$  are the mass fractions (wet basis) of the  $i$ th component in the initial osmotic syrup and food product at equilibrium, respectively. The distribution coefficients for water can be defined as

$$\lambda_w^e = \frac{X_w^e}{Y_w^o} \quad (19.2)$$

Similarly, the distribution coefficient for total solids can be defined as

$$\lambda_s^e = \frac{X_s^e}{Y_s^o} \quad (19.3)$$

The equilibrium coefficients varied with concentration, temperature, types of solutes, geometry, and food–syrup mass ratio. The  $\lambda_w^e$  varied from 0.74 to 1.43 and  $\lambda_s^e$  varied from 0.82 to 1.12 in case of osmotic dehydration of pineapple when temperature and syrup concentration varied from 30°C to 60°C and 50% to 75%, respectively [97]. Similarly, distribution coefficients were measured for pineapple [68], potato [73], apple [84], and mango [85]. In case of apple, at constant syrup concentration, the distribution coefficient of water decreased and distribution coefficient of solids increased with the increasing temperature. The influence of syrup concentration on distribution coefficients showed opposite trends, i.e., increasing syrup concentration increased distribution coefficient of water but decreased the distribution coefficient of solids [84]. Sablani et al. [84] also developed correlations as a dimensionless function of temperature and syrup concentration. Sablani and Rahman [85] developed correlations for mango as

$$\lambda_w^e = 2.05 \left( \frac{T}{T_r} \right)^{-1.60} (Y_s^o)^{0.397} \left( \frac{A_s}{l^2} \right)^{-0.007} \quad (19.4)$$

$$\lambda_s^e = 0.468 \left( \frac{T}{T_r} \right)^{2.04} (Y_s^o)^{0.317} \left( \frac{A_s}{l^2} \right)^{0.023} \quad (19.5)$$

where  $T$  is the process temperature (K),  $T_r$  the reference temperature (273 K),  $A_s$  the surface area of the sample (m<sup>2</sup>), and  $l$  the smallest geometric dimension of the sample (m), respectively.

### 19.1.2 Curing by Salts

Curing was originally developed to preserve certain foods by addition of sodium chloride. In the food industry, the application of curing is related only to certain meat, fish, and cheese products. Today, sodium chloride, and sodium and potassium nitrite or nitrate are considered as curing salts. Salting is one of the most common pretreatments used for fish products. Salting converts fresh fish into shelf-stable products by reducing the moisture content and acting as a preservative. In combination with drying, these processes contribute to the development of characteristic sensory qualities in the products, which influence their utilization as food [42,92]. Although curing was originally a mechanism for preservation by salting, over several millennia, additional processes concomitant with curing have evolved, notably fermentation, smoking, drying, and heating. Curing may have different connotations: in meat, salt and nitrite or nitrate are always added; in fish, salt is always added, but nitrite only rarely; and in cheese, which always contains salt but infrequently contains nitrate, the term curing is applied to the production of desirable proteolytic and lipolytic changes. In the past half century, cured products have been developed that are not stable unless refrigerated. Indeed, most cured meat products must be refrigerated to remain safe and wholesome, and during the past two decades even the packaging of many classes of cured products has become important in extending the period during which the product remains wholesome [96]. Cured meats can be divided broadly into three groups: unheated, mildly heated (pasteurized to center temperature of 65°C–75°C), and severely heated (shelf stable after heating to 100°C–120°C) [96].

In addition to the curing salts and related processes mentioned above, additives collectively known as adjuncts are used in many cured meat products. These include ascorbates, phosphates, glucono-d-lactone, and sugars. Adjuncts are used primarily to obtain or maintain desirable changes, the ascorbates in connection with color and the others in connection with pH, texture, and in some cases flavor. However, adjuncts may affect safety. The concentration of each curing agent depends on the nature of the food product and on the technology used in individual countries [96].

Salting can be done by placing the fish in salt solution or covering with dry salt. During salting, water is removed from the flesh, salt enters the tissues of the fish, and the body juices become a concentrated salt solution. When enough salt enters, it interacts with all the proteins, causing coagulation. When the tissue cells shrink because of the loss of a large share of the moisture content, the fish flesh loses most of its translucent appearance and does not feel sticky to the touch. At this stage, it is said to be *struck through* [48]. A review on the osmotic treatment of fish and meat products has been provided by Collignan et al. [19].

### 19.1.3 Effects of Osmosis on Biological Materials

The cell viability of an osmotic-treated apple revealed that the first layer of cells, at a depth of 1–2 mm from the surface, died as a result of severe osmotic shock. The depth of the layer of severely injured or dead cells coincided with penetration depth of the osmotic, solute [62]. Cell viability of onion protoplast did not suffer any significant change with regard to the nature of the sugar and the sucrose concentration. Sucrose solution dramatically decreased the cell viability in strawberry tissue [27]. During osmotic treatment, a redistribution of the components in cell membrane took place causing a reduction in the surface membrane available for swelling. It might explain why protoplasts swell until plasma membrane broke during the rehydration with isotonic solution with respect to fresh tissue. Maltose and trehalose had a protective effect on the plasma membrane of onion epidermis cell, maintaining its properties as a barrier. Trehalose played a main role during the rehydration of onion epidermis, leading to the highest swelling rate. Contrarily, parenchymatic cells of strawberry tissue were not susceptible to any protective effect with regard to the kind of disaccharides employed [27].

Electron microscopy of strawberry [2,27], apple [106], onion [27], orange peel [31], kiwifruit [65], and eggplant [31] was studied to explain the modification of the cellular structure and disruption of cell membrane by osmotic process. The rehydration kinetics of osmotic-pretreated and air-dried carrot slices decreased with an increase in syrup concentration used for osmotic dehydration. In addition, solute loss increased during rehydration, possibly due to structural changes induced by the osmotic process [82].

Water sorption characteristics of osmotically treated apple slices shifted to the right [53]. Osmotic treatment changed the moisture isotherm of air-dried sweet potato [12]. Salting or solute addition process affects the air-drying process by reducing water diffusivity [23,49,76,88]. In the case of sweet potato,

osmotic treatment with corn syrup did not affect the water diffusivity during air drying [12]. Water diffusivity in strawberry during air-drying increased in the case of blanched or blanched followed by osmotic treatment [2]. The concentration of salt has also great influence on the rate of surface evaporation [55]. In addition, depending on the salt concentration and relative humidity, salted fish may reabsorb moisture from the environment during storage [66].

---

## 19.2 Potential Advantages for Industry

The use of osmotic dehydration process in the food industry has several advantages: (i) quality improvement in terms of color, flavor, and texture, (ii) energy efficiency, (iii) reduction in packaging and distribution costs, (iv) elimination of the need for chemical treatment, and (v) product stability and retention of nutrients during storage.

### 19.2.1 Quality Improvement

It is well established that osmotic dehydration improves the product quality in terms of color, flavor, pigment, vitamins, and texture. Rahman [74], Torreggiani [103], Raoult-Wack [78], and Torreggiani and Bertolo [104] reviewed the merits of osmotic dehydration for product quality improvement and process efficiency. Air-dried cashew apple pretreated with an osmotic solution of sodium chloride and sucrose showed improved color, firmer texture, astringency, and overall acceptability [9]. Fluidized bed air-dried blueberries pretreated by osmotic solution showed low shrinkage, better rehydration, and soft raisin-like texture [50]. Agreeable flavor, color, and texture of osmo-air-dried peppers with whey and sorbitol were developed without preservatives [102]. Osmo-air-dried pea was developed with attractive color and acceptable organoleptic properties with preosmotic dehydration in sucrose and citrate solution [25]. Microwave-dried apple and strawberry pretreated with osmotic dehydration showed high quality in terms of color, taste, vitamin C, and structure retention.

Scanning Electron Microscopy (SEM) analysis revealed that the cellular structure was preserved better with osmotic treatment [24]. Structural and compositional profiles in osmotically dehydrated apple were studied by Cryo-SEM analysis [87]. The firmness of osmo-dehydro-frozen apple measured by oscillation rheometry showed in the following order: no treatment > sorbitol = sucrose > corn syrup > blanched [106]. Vacuum pulse did not favor either preservation of kiwi and mango mechanical response or their cryopreservation. Mechanical response of strawberry was better preserved by air-drying osmotic treatment, but freezing-thawing process provided similar results. Thus, it is necessary to optimize the process treatment based on each fruit [14]. Atmospheric osmotic-treated kiwifruit with glucose, glycerol, or sucrose showed lower failure forces than fresh fruit. Calcium lactate infiltration or vacuum infusion increased failure due to enhanced cell cohesion and increased cell wall integrity. Relaxation tests showed that infusion (atmospheric or vacuum) sharply decreased the elastic component of the rheological behavior of kiwifruit [65]. In the case of potato, longitudinal stiffness was affected much more by osmotic treatment than shear stiffness [91].

In the literature, there is not much fundamental understanding about the mechanisms of flavor entrapment in the food matrix, color retention, and physics of textural improvement. The phenomena that may occur to retain aroma are: adsorption of volatiles onto the infused solute matrix, physicochemical interactions between volatiles and other substances, and microregional encapsulation in which volatile compounds are immobilized in *cages* formed with the association of dissolved solids [16,17,32–34,99,110]. In the case of papaya, the loss of hydrosoluble solutes such as vitamin C could be reduced, most likely because of a sugar barrier layer that is formed at the periphery [44]. In the case of kiwifruit, high temperatures and high sugar concentrations could reduce the loss of vitamin C and chlorophyll due to the preferential increase in water loss compared to solutes [109]. Processing at 50°C or more leads to disadvantageous modifications of color, ascorbic acid, and chlorophyll contents. Processing at 40°C or lower gave satisfactory ascorbic acid and pigment contents in the finished product. Furthermore, additions of ascorbic acid in syrup, as well as calcium and copper chlorides, can enrich the quality, in particular the color [109]. Talens et al. [100] found that osmotic treatment caused changes in the volatile profile of kiwifruit depending on the treatment conditions. The concentration of the ester fraction increased whereas aldehydes and alcohols decreased. Vacuum pulse application and process time promoted the ester formation. The decrease in the aldehydes and alcohols was greater in treatments carried out at atmospheric pressure. After 1 month in frozen storage,

a severe reduction of all compounds (esters, aldehydes, and alcohols) resulted in the same volatile profile in treated and directly frozen sample. The use of high sucrose concentration (40%–65%) in osmotic dehydration of kiwifruits can be recommended to minimize microbial adhesion and to slow down microbial growth during storage, even if it has to be taken into account that high sugar concentration could determine problems of solubility and sugar recrystallization [39].

Minerals or functional substances could be fortified in vegetables and fruits by applying the osmotic process. The effect of incorporating Ca and Fe ions in the structural matrix of apple during vacuum osmotic dehydration process at 30°C was studied by Barrera et al. [5]. It was found that only calcium had the capability of strengthening cell structure, which diminished effective diffusivities. Osmotic dried apple showed much lower and uniform shrinkage compared to the air-dried control, at the same level of moisture content [63]. Calcium infiltration in osmotic-treated apple showed better retention of cellular microstructure during subsequent high-temperature and short-time blanching process [22]. Osmotic pretreatment kept residues of the solute inside the product, which not only influenced the taste and flavor of the product, but also the dielectric properties. The increased salt concentration has a strong effect upon the loss factor. Mushrooms treated by osmotic process followed by drying in microwave hot air produced more homogeneously heating due to the reduced center heating, slight shorter drying time, improved rehydration properties, reduced shrinkage, and a high open-pore porosity [105]. Fito et al. [31] explored the possibility of formulating functional, stable, and fresh-like products by incorporating minerals, vitamins, and health-beneficial functional components in the osmotic solution, in addition to water activity or pH depressors, and antimicrobial components.

The osmotic pretreatments (sugar, sodium chloride, and maltodextrin) affect quality attributes of french fries [51]. Osmotic pretreatment decreases oil and moisture content of french fries, while the porosity increased and provided an improved structure. Color darkening took place during osmotic dehydration and browning reactions during frying are promoted, resulting in more dark- and red-colored fried product. Salt-treated samples have the most acceptable color.

### 19.2.2 Energy Efficiency

Osmotic dehydration is a less energy-intensive process than air- or vacuum-drying because it can be conducted at low temperatures. Lenart and Lewicki [57] found that energy consumption in osmotic dehydration at 40°C, with syrup reconcentration by evaporation, was at least two times lower than convection air-drying at 70°C. In the frozen food industry, high energy levels are used for freezing, because a large quantity of water is present in fresh foods. A significant proportion of this energy could be saved if the plant materials were to be concentrated prior to freezing [7,46]. A reduction in moisture content of food can reduce refrigeration load during freezing. This is typified by salting, which is one of the oldest methods for preserving fish and vegetables. The high level of solute in osmotically treated products decreases water activity and preserves them, and thus the energy-intensive drying process can also be avoided. Following osmotic treatment, the resultant syrup can be used in juice or beverage industries as a by-product, thereby improving process economy.

### 19.2.3 Packaging and Distribution Cost Reduction

Partially concentrating fruits and vegetables prior to freezing saves packaging and distribution costs [11]. The product quality is comparable with that of conventional products. The process is referred to as *dehydrefreezing*.

### 19.2.4 Chemical Treatment Not Required

Canning of apples is not practiced commercially due to some inherent problems associated with the high gas volume in apple tissue, difficulty of its removal during exhausting, less drained weight, and mushy texture [93]. There have been a few attempts of canning apple slices by using calcium chloride, a firming agent, to improve texture [21]. However, using osmotically treated apple pieces in the canning process resulted in a firmer texture and improved quality of the product [93]. This process is known as *osmocanning*. Similarly, firmer apple slices were obtained when calcium ion was used in the osmotic syrup [5].

Chemical treatment to reduce enzymic browning can be avoided by the osmotic process [72]. There are two effects of sugar in producing high-quality product: (i) effective inhibition of polyphenol oxidase, the enzyme that catalyzes oxidative browning of many cut fruits, and (ii) prevention of the loss of volatile flavor during further air- or vacuum-drying [113]. However, if the final product after air-drying contains 10%–20% moisture, enzymic and nonenzymatic browning causes slow deterioration of color and flavor [71]. Therefore, Ponting [71] suggested adding a blanching step after the osmotic process and using sulfur dioxide during or after the osmotic step if the final moisture content of the fruits and vegetables is more than 20%.

### 19.2.5 Product Stability during Storage

The product obtained by osmotic process is more stable than untreated fruits and vegetables during storage due to low water activity by solute gain and water loss. At low water activity, deteriorative chemical reactions, and growth and toxin production by microorganisms in the food are low. In case of canning using high-moisture fresh fruits and vegetables, water can flow from the product to the syrup brine causing dilution. This can be avoided using the *osmocanning process* to improve product stability [93]. Similarly, the use of *osmo-dehydrofrozen* apricot and peach cubes in yogurt can improve consistency and reduce whey separation of the yogurt [38]. Solute exerts germicidal effect. Salt reduces the solubility of oxygen in the substrate, thereby, restricting the growth of aerobes.

---

## 19.3 Factors Affecting Osmotic Dehydration Process

The mass transport during osmotic dehydration depends on the factors described in the following sections.

### 19.3.1 Types of Osmotic Agents

The most commonly used osmotic agents are sucrose for fruits and sodium chloride for vegetables, fish, and meat. Other osmotic agents include glucose, fructose, lactose, dextrose, maltose, polysaccharide, maltodextrin, corn starch syrup, whey, sorbitol, ascorbic acid, citric acid, calcium chloride, and combinations of these osmotic agents. A number of researchers investigated the use of binary mixtures of solutes, with sucrose as a means of reducing solute cost and improving the effectiveness of osmosis [43,47]. The ultimate choice of blend will depend on many factors such as solute cost, organoleptic compatibility with the end product, and additional preservative action by the solute. Calcium from a calcium chloride brine approximately iso-osmotic with cucumber cell sap penetrated cucumber fruit much more slowly than did calcium ions from a mixture of sodium chloride and calcium chloride. After 96 h, calcium that penetrated from the iso-osmotic brine was localized mostly in the exocarp and relatively little in the interior tissues, while calcium that penetrated from the supra-osmotic brine reached higher concentrations and was more evenly distributed among the exocarp, mesocarp, and endocarp sections [112]. It was observed that a synergistic action of two solutes (sucrose and sodium chloride) on soluble solids increases in apple. With respect to the sensory analysis of apple samples dehydrated in ternary solutions, it is possible to assert that salt gain was not sufficient to balance the excessive sweetness of the product processed at high sucrose concentrations. Small additions of sodium chloride (up to 1%) did not determine the complete decay of product acceptability if coupled with limited sucrose concentration (<54.5%) [86].

### 19.3.2 Concentration of Osmotic Solution

Both water loss to equilibrium level and osmotic-drying rate increase with the increase in osmotic syrup concentration, since water activity (i.e., mass transfer driving force) of syrup decreases with the increase in solute concentration in the syrup [10,11,26,53,56,58,60,75]. A dense solute-barrier layer at the surface of the product is formed with the increase in syrup concentration, thus enhancing the dewatering effect and reducing the loss of nutrients during the process [89,90]. A similar solute barrier is also formed in the case of syrups with higher molecular weight solutes at even low concentration.

### 19.3.3 Temperature of Osmotic Solution

The rate of osmosis is markedly affected by temperature [8]. This is the most important parameter influencing the kinetics of water loss and solute gain. Water loss increases with increase in temperature, whereas solid gain is less affected by temperature. In the case of high temperature, the solute cannot diffuse as easily as water through the cell membrane, and thus the approach to osmotic equilibrium is achieved primarily by flow of water from the cell [75]. This type of equilibrium results in a lower solute gain by the product. Askar [3] recommended a high temperature and short time for osmo-solar-dried peach since it can produce good texture with high aroma and color retention. The main influence in osmotic dehydration was observed at a high temperature of 50°C, and at 26°C no appreciable change in solids concentration was observed at distances deeper than 0.5 cm from the cube surfaces even after 168 h. At 50°C, all the layers were affected even at shorter times (8 h) [37].

Fish are salted over the temperature range of 0°C–38°C. Higher the temperature, faster is the salt infusion and quicker the process reaches equilibrium. In general, fish absorbs salt faster as the brining temperature increases. It is best to standardize brining at a cool temperature (1.1°C–1.7°C) to achieve consistent and predictable results and to discourage bacterial growth. Using ice in the brine make-up water is a good way to accomplish this, but caution must be exercised to make sure that no ice remains in the finished brine. Brining in a cold room is also a good way to keep brines cool and is advisable for long brining times [45].

In general, salt absorption is affected by brine concentration and temperature, brining time, thickness and geometry of fish, texture and fat content of fish, species, and fish quality [45]. Fish flesh absorbs salt faster from higher salt brine concentration. Brine greater than 15.8% tends to remove moisture from the fish, which can be advantageous in some products. However, strong brines and short times may not allow even distribution of salt into the center of the fish geometry prior to smoking. Dry salting has the advantage of removing moisture but has the disadvantage of uneven salt absorption. Dry salting is a technique that covers fish with a thin layer of salt (0.64–1.27 cm) between layers of fish [45]. Tilapia was processed by dry salting (3:1 fish:salt ratio), varying salting time (0–24 h), air-drying time (6–20 h), and drying temperature (40°C–60°C). The critical salting times for attaining minimum moisture were 20.5, 12, and 8.5 h, respectively, for products air dried at 40°C, 50°C, and 60°C. The hardness, color, and overall acceptability of salted dried tilapia were found to be dependent on the process variables, salting time, drying time, and temperature [66].

### 19.3.4 Properties of Solute Used in Osmosis

The osmotic process is affected by the physicochemical properties of the solutes employed. These differences arise mainly from differences in molecular weight, ionic state, and solubility of solute in water. According to the principle of osmosis, the rate of water loss from the fruit to the syrup having a large molecular weight solute is lower than that of syrup having small molecular weight solutes when both syrups are at the same mass concentration. This is due to low vapor pressure of the syrup having low molecular weight solute. However, contrary to the above physical chemistry principle, for osmotic syrups with equal concentrations at the early stage, those with high molecular weight solutes will have greater rate of water removal and lower solute transfer (due to low solute penetration) than those of low molecular weight. This was demonstrated by a model agar gel [77] and apple [54].

The pH of the syrup can also affect the osmotic process. Acidification increases the rate of water removal by changes in tissue properties and consequential changes in the texture of fruits and vegetables [64]. Water removal was maximal at pH 3 for apple rings using corn syrup [20]. In a more acidic solution (i.e., at pH 2), the apple ring became very soft. However, firmness was maintained at pH values between 3 and 6. The softening may be due to hydrolysis and depolymerization of the pectin.

### 19.3.5 Agitation of Osmotic Solution

Osmotic dehydration can be enhanced by agitation or circulation of the syrup around the sample [20,43,56]. However, the improvement is so small that in some cases it might be more economical to not use agitation when considering equipment needs and breaking of fruits [72]. The effect of agitation on the osmotic dehydration of kiwifruit slices was found to depend on the syrup-to-fruit mass ratio and syrup concentration [69].

### 19.3.6 Material Geometry

Osmotic concentration behavior depends on the geometry of sample pieces, due to the variation of surface area per unit volume (or mass), and diffusion length of water and solutes involved in mass transport. Contreras and Smyrl [20] found that mass loss was about 1.3 times higher when apple slice thickness decreased from 10 to 5 mm. Lericci et al. [58] found that solute gain increased as the ratio of surface area to minimum diffusion length increased, while water loss increased to a maximum (depending on the shape) and then decreased. This decrease in water loss was probably due to a reduction of diffusion caused by high solid gain at the surface and consequent formation of a solute layer. At the same operating conditions, fresh fruit having different sizes and shapes can yield final products with very different characteristics [58]. In case of osmotic dehydration of apple, water loss and solids gain generally increased with contact time, temperature, and concentration, and decreased with an increase in the size of the cylindrical sample [108].

### 19.3.7 Osmotic Solution and Food Mass Ratio

Both solid gain and water loss increase with an increase in syrup-to-food mass ratio [35,72]. Uddin and Islam [107] studied the effect of syrup and fruit slice mass ratio on osmotic treatment of pineapple at 21°C. They observed that weight loss increased until the syrup to fruit ratio was 4:1, but by increasing the ratio up to 6:1 no further gain was observed. Thus, they defined the optimum ratio as 4:1 for pineapple. The rate of solid gain and water loss increased significantly: the syrup-to-fruit mass ratio was increased from 1:1 to 6:1 in case of osmotic drying of potato in 61% sucrose syrup [56]. At equilibrium, solute content in potato was the same at syrup fruit ratios of 1:1 and 10:1. Thus, syrup-to-fruit mass ratio has negligible effect on potato composition at equilibrium.

### 19.3.8 Physicochemical Properties of Food Materials

The chemical composition (protein, carbohydrate, fat, and salt), physical structure (porosity, arrangement of the cells, fiber orientation, and skin), and pretreatments may affect the kinetics of osmosis in food. A steam-blanching step for 4 min before osmosis gave lower water loss and higher solid gain when applied to fresh potato slices [47]. The loss of membrane integrity due to heating was the cause of the poor osmotic concentration behavior [47]. Freezing the raw fruit disrupts cells and results in poor osmosis of the thawed fruit [71]. Saurel et al. [90] studied osmosis of frozen apple without thawing in ethylene glycol and polyethylene glycol at 30°C to 70°C. They observed results similar to those with fresh apple.

Soft-textured fish tend to absorb salt faster than tough or firm-textured fish. Frozen flesh absorbs negligible salt, thus need thawing. Mishandled fish with gaping (separated flesh fibers) may have decreased brining times. High-fat-content fish absorb salt slower than low-fat fish. However, they may need less salt to obtain adequate final water phase salt content. Also, the fat content in flesh varies at different locations on the body of the fish. Salmon, for example, tends to have less fat at the tail. Different species of fish have different flesh characteristics and may absorb salt at different rates. Salting times should be specific for each species. Moreover, geometrical shapes of fish having different thickness and width along the length also contribute to the difficulty in controlling the salting process and cause nonuniform salt distribution. Frozen-thawed fish or low-quality fish have flesh characteristics that may affect (usually increase) the rate of salt absorption. The rate of freezing affects flesh cell structure and therefore the subsequent rate of salt absorption [45]. In some cases, for example, in the case of salmon, the fish is soaked overnight in freshwater or for a period of 12–16 h before curing. The water is changed two or three times. Ten or twelve hours of freshening should be sufficient, but a more thorough soaking may be required to satisfy some markets.

Diffusivity of manganese ion in cured pork was varied,  $0.42-1.0 \times 10^{-10}$  m<sup>2</sup>/s [40]. Salt diffusion in pork meat was found to be  $3.6-1.2 \times 10^{-10}$  m<sup>2</sup>/s (temperature  $-2^{\circ}\text{C}$  to  $36^{\circ}\text{C}$ ), and for fat it was  $0.07 \times 10^{-10}$  m<sup>2</sup>/s [114]. Salt has a profound effect on the ultrastructure and hence moisture binding of fish muscle. It has more effect compared to freezing, drying, or heat treatment [111].

### 19.3.9 Operating Pressure and Other Forces

Vacuum osmotic dehydration results in a change of behavior of mass transfer in fruit sugar or salt solution systems [15,28,30,69,94,95]. Vacuum treatments intensify the capillary flow and increase water transfer, but have no influence on solute uptake [28]. The total water transfer results from a combination of traditional diffusion and capillary flow, and is affected by the porosity or void fraction of the fruit [29,94]. The reduction in pressure causes the expansion and escape of gas occluded in the pores, and pores can be occupied by osmotic solution, thus increasing mass transfer rate. In addition to vacuum, applications of high hydrostatic pressure [79], centrifugal force [4], high electric pulse [1,80], and ultrasound [98] are used to improve the mass transfer [81]. The increased mass transfer in high electric field and high pressure was due to the irreversible increase in cell wall permeability [79], and the initiation and growth of the pores was time dependent [1]. The acoustic increases the mass transfer by reducing the thickness of boundary layer by generating localized pressure fluctuations [36]. Petrotos and Lazarides [70] reviewed osmotic concentration of liquid foods by applying osmotic membrane techniques, namely, direct osmosis, membrane distillation, and osmotic distillation.

---

## 19.4 Problems in Applying the Osmotic Dehydration Process in the Food Industry

There are a number of technological problems to be overcome before the osmotic dehydration process can be applied to the food industry. These are discussed in the following sections.

### 19.4.1 Product Sensory Quality

A main disadvantage of the osmotic process is that it may increase the saltiness (or sweetness) or decrease the acidity of the product, which may not be desired in some cases. This can be avoided by controlling the solute diffusion and optimizing the process to improve the sensory assessment of the product. Adequate protective edible coating enriched with specific additives could be developed by osmotic process, which reduces surface microbial growth and provides other barrier (such as moisture, oxygen) properties during storage [41]. Edible semipermeable membrane coatings can also be used to reduce solute uptake and increase water loss [13]. Salting of cod fillets was achieved in osmotic solutions (sucrose and salt, or corn starch syrup and salt) with high molecular solutes allowed better control of salt entrance, thus producing light salted fish [18]. However, microbiological and organoleptic validations need to be carried out for complete process validation.

### 19.4.2 Syrup Management

The microbial validation of the process for long-time operation and reuse of the syrup by recycling are important factors for industrial applications [78]. The management of syrup is a major challenge to make the process industrially viable. These include syrup composition and concentration, syrup recycling, solute addition, reuse of the syrup, and waste disposal. The cost of the syrup is a key factor for the success of the process. The compositional changes related to leaching from the fruit or vegetable may influence the product quality (color, acids, sugar, minerals, and vitamins). Microbial contamination can increase with the number of times the syrup is recycled. Depending on the environmental process conditions, the microbial load after several osmotic cycles can range from  $2 \times 10^2$  cfu/mL to high levels of yeast and fungi only after the 15th cycle and  $10^5$  cfu/mL after 8 h of continuous treatment [83]. A pilot recycling system was validated for salt in the case of meat and fish. Over a 6-day processing period, the microbial load of the brine was kept at a low level ( $8.37 \times 10^4$  cfu/g of AAMEF;  $1.19 \times 10^3$  cfu/g of yeasts and molds), and the mass transfer potential of the solution (water loss and salt gain) remained steady [19]. The options to reduce microbial contamination are: more care for low-acid foods, avoidance of much dilution of solution, use of air filtering system by processing environment, and hygienic management of osmotic solution [83]. The control of solute composition in recycling for single solute syrup is easier than mixed solute syrups.

Barranco et al. [6] considered the following options for osmotic solution management: (i) direct reuse after some degree of regeneration, (ii) reuse with the final product after preconditioning or a partial



regeneration process, (iii) use of the spent solution to produce substances of interest (these could be either obtained directly or through a microbiological process), and (iv) treatment with specific process. During the recycling process, the diluted syrup can be reconcentrated by evaporation, reverse osmosis, membrane filtration, freeze concentration, and treated with active carbon [6,19,83]. The unused syrup needs to be adequately treated before disposal in wastewater [6,83]. The syrup-to-fruit mass ratio should be kept as low as possible to reduce production costs. Torreggiani [101] emphasized that the problems of microbial growth in the syrup and the effects of repeated reconcentration and recycling of syrup on its properties need to be overcome to develop large-scale industrial processes. Acidification of sucrose could happen from the acidic fruits, which could increase the osmotic rate; however, this caused darkening and quality losses during the subsequent drying process. Kubiak et al. [52] studied the effect of pH (4–10), temperature (50°C–60°C), and sucrose concentration (50°Bx–70°Bx) on sucrose hydrolysis rate. The sucrose hydrolysis at pH range of 6–10 was insignificant and did not depend on temperature and sucrose concentration. Sucrose hydrolysis increased significantly and depended on hydrogen ion and sucrose concentration, temperature, and time when pH values were below 5.0.

### 19.4.3 Process Control and Design

Inadequate information about the experiments presented in the literature and limited data available have precluded effective design and control of this process by the food industry. Further studies are necessary to get a clear understanding of the variation of equilibrium and rate constants with process variables and characteristics of the food materials. Most of the osmosis studies have been concerned with the qualitative prediction of the processing factors, but more quantitative prediction is necessary for industrial use in process design and control. Online measurements of syrup properties can provide continuous control of the process. Fruits and vegetables tend to float on the concentrated syrup due to the higher density of the syrup. Moreover, the viscosity of the syrup exerts considerable mass transfer resistance, causing difficulty in agitation and the syrup tends to adhere to the surface of the food material. Breakage of the fruit or vegetable pieces may occur by flow of syrup in case of continuous process or by mechanical agitation in case of batch process.

Marouze et al. [61] provided different possible equipment (batch and continuous processes) designs for osmotic dehydration. They provided the following parameters that need to be considered: (i) creating relative movement between the solution and the food, characterized by relative speed and homogeneity for all the food, (ii) control of treatment time and equipment used for continuous processing, control of the spread of residence times in the contactor to ensure homogeneous treatment of the food, (iii) ability to accept different shapes of food (whole or in cubes, slices, or fillets), (iv) reduction of the solution mass/food mass ratio (a low mass ratio is of particular interest if the cost of the solution is high; it also restricts equipment size), avoidance of oxidation in food in contact with air, (v) allowing a system for the solution to be introduced and removed, (vi) allowing the food to be introduced and its subsequent removal (for continuous processing: continuous introduction, and removal of food when it has reached the required state of treatment), (vii) allowing control of the process control parameters (food and solution temperature, solution concentration, static pressure of food and solution, agitation), (viii) complying with the appropriate mechanical, electrical, and food-related standards, and (ix) a reasonable cost of equipment manufacture.

The equilibrium is the end point of osmosis, but for practical purposes a number of other factors should be considered to ensure the quality of the final product. These include damage to the cells and development of off-flavor due to longer processing time and reuse of the syrup [74]. Finally, adequate packaging systems should be used to make sure that the consumers are getting good quality products.

---

## References

1. B. I. O. Ade-Omowaye, P. Talens, A. Angersbach and D. Knorr, Kinetics of osmotic dehydration of red bell peppers as influenced by pulsed electric field pretreatment, *Food Res. Int.* 36:475 (2003).
2. C. A. Alvarez, R. Aguerre, R. Gomez, S. Vidales, S. M. Alzamora and L. N. Gerschenson, Air dehydration of strawberries: effects of blanching and osmotic pretreatments on the kinetics of moisture transport, *J. Food Eng.* 25:167 (1995).
3. A. Askar, Osmotic and solar dehydration of peach fruits, *Fruit Process.* 7:258 (1996).

4. E. Azuara, H. S. Garcia and C. I. Bertistain, Effect of the centrifugal force on osmotic dehydration of potatoes and apples, *Food Res. Int.* 29(2):1995 (1996).
5. C. Barrera, N. Betoret and P. Fito,  $\text{Ca}^{2+}$  and  $\text{Fe}^{2+}$  influence on the osmotic dehydration kinetics of apple slices (var. Granny Smith), *J. Food Eng.* 65:9 (2004).
6. C. R. Barranco, M. B. Balbuena, P. G. Garcia and A. G. Fernandex, Management of spent brines or osmotic solutions, *J. Food Eng.* 49:237 (2001).
7. M. Beedie, Energy saving – a question of quality, *South African J. Food Sci. Technol.* 48(3):14 (1995).
8. C. I. Beristain, E. Azuara, R. Cortes and H. S. Garcia, Mass transfer during osmotic dehydration of pineapple rings, *Int. J. Food Sci. Technol.* 25:575 (1990).
9. G. Bidaisee and N. Badrie, Osmotic dehydration of cashew apples (*Anacardium occidentale* L.): quality evaluation of candied cashew apples, *Int. J. Food Sci. Technol.* 36:71 (2001).
10. R. N. Biswal, K. Bozorgmehr, F. D. Tompkins and X. Liu, Osmotic concentration of green beans prior to freezing, *J. Food Sci.* 56:1008 (1991).
11. R. N. Biswal and M. Le Maguer, Mass transfer in plant materials in contact with aqueous solutions of ethanol and sodium chloride: equilibrium data, *J. Food Process. Eng.* 11:159 (1989).
12. R. N. Biswal, L. R. Wilhelm, A. Rojas and J. R. Mount, Moisture diffusivity in osmotically concentrated diced sweet potato during air-drying, *Trans. ASAE* 40(5):1383 (1997).
13. W. M. Camirand, R. R. Forrey, K. Popper, F. P. Boyle and W. L. Stanley, Dehydration of membrane-coated foods by osmosis, *J. Sci. Food Agric.* 19:472 (1968).
14. A. Chiralt, P. Fito, J. M. Barat, A. Andres, C. Gonzalez-Martinez, I. Escriche and M. M. Camacho, Use of vacuum impregnation in food salting process, *J. Food Eng.* 49:141 (2001).
15. A. Chiralt, N. Martinez-Navarrete, J. Martinez-Monzo, P. Talens, G. Moraga, A. Ayala and P. Fito, Changes in mechanical properties throughout osmotic processes cryoprotectant effect, *J. Food Eng.* 49:129 (2001).
16. J. Chirife and M. Karel, Volatile retention during freeze drying of aqueous suspensions of cellulose and starch, *J. Agr. Food Chem.* 21:936 (1973).
17. J. Chirife, M. Karel and J. Flink, Studies on mechanisms of retention of volatile in freeze-dried food models: the system PVP-n-propanol, *J. Food Sci.* 38:671 (1973).
18. A. Collignan, P. Bohuon, F. Deumier and I. Poligne, Osmotic treatments of fish and meat products, *J. Food Eng.* 49:153 (2001).
19. A. Collignan and A. L. Raoult-Wack, Dewatering and salting of cod by immersion in concentrated sugar/salt solutions, *Food Sci. Technol.* 27:259 (1994).
20. J. E. Contreras and T. G. Smyrl, An evaluation of osmotic concentration of apple rings using corn solids solutions, *Can. Inst. Food Technol. J.* 14:310 (1981).
21. R. L. Dang, R. P. Singh, A. K. Bhatia and S. K. Verma, Studies on Kashmir apples – canning as rings, *Indian Food Packer.* 30:9 (1976).
22. J. M. Del-Valle, V. Aranguiz and H. Leon, Effects of blanching and calcium infiltration on PPO activity, texture, microstructure and kinetics of osmotic dehydration of apple tissue, *Food Res. Int.* 31(8):557 (1998).
23. A. A. El-Aouar, P. M. Azoubel and F. E. X. Murr, Drying kinetics of fresh and osmotically pre-treated papaya (*Carica papaya* L.), *J. Food Eng.* 59(1):85 (2003).
24. U. Erle and H. Schubert, Combined osmotic and microwave-vacuum dehydration of apples and strawberries, *J. Food Eng.* 49:193 (2001).
25. F. K. Ertekin and T. Cakaloz, Osmotic dehydration of peas II. Influence of osmosis on drying behavior and product quality, *J. Food Process. Preserv.* 20:105 (1996).
26. D. F. Farkas and M. E. Lazar, Osmotic dehydration of apple pieces: effect of temperature and syrup concentration on rates, *Food Technol.* 23(5):688 (1969).
27. M. Ferrando and W. E. L. Spiess, Cellular response of plant tissue during the osmotic treatment with sucrose, maltose, and trehalose solutions, *J. Food Eng.* 49:115 (2001).
28. P. Fito, Modelling of vacuum osmotic dehydration of food, *J. Food Eng.* 22:313 (1994).
29. P. Fito and A. Chiralt, An update on vacuum osmotic dehydration, In *Food Preservation by Moisture Control. Fundamentals and Applications*, G. V. Barbosa-Canovas and J. Welte-Chanes, Eds., Technomic Publishing, PA, pp. 351–374 (1995).
30. P. Fito, A. Chiralt, N. Betoret, M. Gras, M. Chafer, J. Martinez-Monzo, A. Andres and D. Vidal, Vacuum impregnation and osmotic dehydration in matrix engineering applications in functional fresh food development, *J. Food Eng.* 49:175 (2001).
31. P. Fito and R. Pastor, Non-diffusional mechanisms occurring during vacuum osmotic dehydration, *J. Food Eng.* 21:513 (1994).

32. J. M. Flink, Dehydrated carrot slices: influence of osmotic concentration on drying behaviour and product quality, In *Food Process Engineering*, P. Linko, Y. Malkki, J. Oikku and J. Larinkari, Eds., Applied Science Publishers, London, pp. 412–418 (1979).
33. J. Flink and M. Karel, Retention of organic volatiles in freeze-dried solutions of carbohydrates, *J. Agr. Food Chem.* 18:295 (1970).
34. J. Flink and M. Karel, Effects of process variables on retention of volatiles in freeze-drying, *J. Food Sci.* 35:444 (1970).
35. J. Flink and T. P. Labuza, Retention of 2-propanol at low concentration by freeze drying carbohydrate solutions, *J. Food Sci.* 37:617 (1972).
36. J. D. Floros and H. Liang, Acoustic assisted diffusional through membrane and biomaterials, *Food Technol.* 79:84 (1994).
37. P. Genina-Soto, J. Barrera-Cortes, G. Gutierrez-Lopez and E. A. Nieto, Temperature and concentration effects of osmotic media on OD profiles of sweet potato cubes, *Drying Technol.* 19(3,4):547 (2001).
38. R. Giangiacomo, D. Torreggiani, M. L. Erba and G. Messina, Use of osmodehydrofrozen fruit cubes in yogurt, *Ital. J. Food Sci.* 6:345 (1994).
39. A. Gianotti, G. Sacchetti, M. F. Guerzoni and M. Dala Rosa, Microbial aspects on short-time osmotic treatment of kiwifruit, *J. Food Eng.* 49:265 (2001).
40. T. Guiheneuf, S. Gibbs, A. Fischer and L. Hall, Measurement of the diffusion coefficient of manganese ions in cured pork by one-dimensional 1H magnetic resonance imaging, *Int. J. Food Sci. Technol.* 31:195 (1996).
41. S. Guilbert, N. Gontard and A. L. Raoult-Wack, Superficial edible films and osmotic dehydration: Application of hurdle technology without affecting the food integrity, In *Food Preservation by Moisture Control. Fundamentals and Applications*, G. V. Barbosa-Canovas and J. Welte-Chanes, Eds., Technomic Publishing, PA, pp. 305–323 (1995).
42. R. Hardy, Fish lipids, In *Advances in Fish Science and Technology*, J. J. Connell, Ed., Torry Research Station, Aberdeen, Scotland, pp. 103–111 (1980).
43. J. Hawkes and J. M. Flink, Osmotic concentration of fruit slices prior to freeze dehydration, *J. Food Process. Preserv.* 2:265 (1978).
44. K. Heng, S. Guilbert and J. L. Cuq, Osmotic dehydration of papaya: influence of process variables on the product quality, *Sciences Des Aliments* 10:831–848 (1990).
45. K. S. Hilderbrand, Fish Smoking Procedures for Forced Convection Smokehouse, Special Report 887, Oregon State University Extension Service, pp. 1–41 (1992).
46. C. C. Huxsoll, Reducing the refrigeration load by partial concentration of foods prior to freezing, *Food Technol.* 35(11):98 (1982).
47. M. N. Islam and J. N. Flink, Dehydration of potato II. Osmotic concentration and its effect on air drying behavior, *J. Food Technol.* 17:387 (1982).
48. D. Jarvis, *Curing of Fishery Products*. Teaparty Books, MA (1987).
49. V. T. Karathanos, A. Reppa and A. E. Kostaropoulos, Air-drying kinetics of osmotically dehydrated fruits, *Proceedings of the 9th International Drying Symposium (IDS '94)*, August 1–4, Gold Coast, Australia, pp. 871–878 (1994).
50. M. H. Kim and R. T. Toledo, Effect of osmotic dehydration and high temperature fluidized bed drying on properties of dehydrated rabbiteye blueberries, *J. Food Sci.* 52(4):980 (1987).
51. M. K. Krokida, V. Oreopoulou, Z. B. Maroulis and D. Martinos-Kouris, Effect of osmotic dehydration pretreatment on the quality of French fries, *J. Food Eng.* 49:339 (2001).
52. K. N. W. Kubiak, M. A. S. Cervantes, H. D. C. Gonzalez, M. I. R. Bello and A. J. S. Solis, Effect of pH, temperature and sucrose concentration on its hydrolysis rate during osmotic dehydration process, *Proceedings of the 9th International Drying Symposium (IDS '94)*, August 1–4, Gold Coast, Australia (1994).
53. H. Lazarides, E. Katsanidis and A. Nickolaidis, Mass transfer kinetics during osmotic preconcentration aiming at minimal solid uptake, *J. Food Eng.* 25:151 (1995).
54. H. N. Lazarides, A. Nickolaidis and E. Katsanidis, Sorption changes induced by osmotic preconcentration of apple slices in different osmotic media, *J. Food Sci.* 60(2):348 (1995).
55. M. Lee, L. Chou and J. Huang, The effect of salt on the surface evaporation of a porous medium, In *Drying '94: Proceedings of the 9th International Drying Symposium (IDS '94)*, August 1–4, Gold Coast, Australia, pp. 223–230 (1994).
56. A. Lenart and J. M. Flink, Osmotic concentration of potato. I. Criteria for the end-point of the osmosis process, *J. Food Technol.* 19:45 (1984).
57. A. Lenart and P. P. Lewicki, Energy consumption during osmotic and convective drying of plant tissue, *Acta Alimentaria Polonica* 14:65 (1988).

58. C. R. Lerici, G. Pinnavaia, M. D. Rosa and L. Bartolucci, Osmotic dehydration of fruit: influence of osmotic agents on drying behavior and product quality, *J. Food Sci.* 50:1217 (1985).
59. T. R. A. Magee, A. A. Hassaballah and W. R. Murphy, Internal mass transfer during osmotic dehydration of apple slices in sugar solutions, *Ir. J. Food Sci. Technol.* 7:147 (1983).
60. M. Marcotte and M. Le Maguer, Repartition of water in plant tissues subjected to osmotic process, *J. Food Process Eng.* 13:297 (1991).
61. C. Marouze, F. Giroux, A. Collignan and M. Rivier, Equipment design for osmotic treatments, *J. Food Eng.* 49:207 (2001).
62. N. E. Mavroudis, P. Dejmek and I. Sjöholm, Osmotic treatment-induced cell depth and osmotic processing kinetics of apples with characterized raw properties. *J. Food Eng.* 63:47–56 (2004).
63. R. Moreira and A. M. Sereno, Evaluation of mass transfer coefficients and volumetric shrinkage during osmotic dehydration of apple using sucrose solutions in static and non-static conditions, *J. Food Eng.* 57:25 (2003).
64. J. H. Moy, N. B. H. Lau and A. M. Dollar, Effects of sucrose and acids on osmotic-dehydration of tropical fruits, *J. Food Process. Preserv.* 2:131 (1978).
65. V. Muntada, L. N. Gerschenson, S. M. Alzamora and M. A. Castro, Solute infusion effects on texture of minimally processed kiwifruit, *J. Food Sci.* 63(4):616 (1998).
66. J. Nketsia-Tabiri and S. Sefa-Dedeh, Optimization of process conditions and quality of salted dried tilapia (*Oreochromis niloticus*) using response surface methodology, *J. Sci. Food Agric.* 69:117 (1995).
67. N. M. Panagiotou, V. T. Karathanos and Z. B. Maroulis, Mass transfer modeling of the osmotic dehydration of some fruits, *Int. J. Food Sci. Technol.* 33:267 (1998).
68. Parjoko, M. S. Rahman, K. A. Buckle and C. O. Perera, Osmotic dehydration kinetics of pineapple wedges using palm sugar, *Food Sci. Technol.* 29:452 (1996).
69. C. O. Perera, A report on drying of kiwifruit (confidential). Horticulture and Food Research Institute of New Zealand Ltd. pp. 18 (1990).
70. K. B. Petrotos and H. N. Lazarides, Osmotic concentration of liquid foods, *J. Food Eng.* 49:201 (2001).
71. J. P. Ponting, Osmotic dehydration of fruits—recent modifications and applications, *Process Biochem.* 8:18 (1973).
72. J. D. Ponting, G. G. Watters, R. R. Forrey, R. Jackson and W. L. Stanley, Osmotic dehydration of fruits, *Food Technol.* 20(10):125 (1966).
73. M. S. Rahman, Osmotic dehydration kinetics of foods, *Indian Food Indus.* 15:20 (1992).
74. M. S. Rahman and J. Lamb, Osmotic dehydration of pineapple, *J. Food Sci. Technol.* 27:150 (1990).
75. M. S. Rahman and J. Lamb, Air-drying behaviour of fresh and osmotically dehydrated pineapple, *J. Food Process Eng.* 14(3):163 (1991).
76. M. S. Rahman, S. S. Sablani and M. A. Al-Ibrahim, Osmotic dehydration of potato: equilibrium kinetics, *Drying Technol.* 19(5):1164 (2001).
77. A. L. Raoult-Wack, Recent advances in the osmotic dehydration of foods, *Trends Food Sci. Technol.* 5:255 (1994).
78. A. Raoult-Wack, S. Guilbert and M. Le Maguer, Simultaneous water and solute transport in shrinking media—Part 1. Application to dewatering and impregnation soaking process analysis (osmotic dehydration), *Drying Technol.* 9:589 (1991).
79. N. K. Rastogi, M. N. Eshtiaghi and D. Knorr, Accelerated mass transfer during osmotic dehydration of high intensity electrical field pulse pretreated carrots, *J. Food Sci.* 64:1020 (1999).
80. N. K. Rastogi, C. A. Nayak and K. S. M. S. Raghavarao, Influence of osmotic pre-treatments on rehydration characteristics of carrots, *J. Food Eng.* 65:287 (2004).
81. N. K. Rastogi and K. Niranjana, Enhanced mass transfer during osmotic dehydration of high pressure treated pineapple, *J. Food Sci.* 63:508 (1998).
82. N. K. Rastogi, K. S. M. S. Raghavarao, K. Niranjana and D. Knorr, Recent developments in osmotic dehydration: methods to enhance mass transfer, *Trends Food Sci. Technol.* 13:48 (2002).
83. M. D. Rosa and F. Giroux, Osmotic treatments (OT) and problems related to the solution management, *J. Food Eng.* 49:223 (2001).
84. S. S. Sablani, M. S. Rahman and D. S. Al-Sadeiri, Equilibrium distribution data for osmotic drying of apple cubes in sugar-water solution, *J. Food Eng.* 52:193 (2002).
85. S. S. Sablani and M. S. Rahman, Effect of syrup concentration, temperature and sample geometry on equilibrium distribution coefficients during osmotic dehydration of mango, *Food Res. Int.* 36:65 (2003).
86. G. Sacchetti, A. Gianotti and M. D. Rosa, Sucrose-salt combined effects on mass transfer kinetics and product acceptability. Study on apple osmotic treatments, *J. Food Eng.* 49:163 (2001).

87. D. Salvatori, A. Andres, A. Albors, A. Chiralt and P. Fito, Structural and compositional profiles in osmotically dehydrated apple, *J. Food Sci.* 63(4):606 (1998).
88. C. K. Sankat, F. Castaigne and R. Maharaj, The air drying behavior of fresh and osmotically dehydrated banana slices, *Int. J. Food Sci. Technol.* 31(2):123 (1996).
89. R. Saurel, A. Raoult-Wack, G. Rios and S. Guilbert, Mass transfer phenomena during osmotic dehydration of apple. I. Fresh plant tissue, *Int. J. Food Sci. Technol.* 29:531 (1994).
90. R. Saurel, A. Raoult-Wack, G. Rios and S. Guilbert, Mass transfer phenomena during osmotic dehydration of apple. II. Frozen plant tissue, *Int. J. Food Sci. Technol.* 29:543 (1994).
91. M. G. Scanlon, C. H. Pang and C. G. Biliaderis, The effect of osmotic adjustment on the mechanical properties of potato parenchyma, *Food Res. Int.* 29(5–6):481 (1996).
92. S. Sefa-Dedeh, In *Encyclopedia of Food Science, Technology and Nutrition*, R. Macrae, R. Robinson, M. Sadler, Eds., Academic Press, New York, pp. 4600–4606 (1993).
93. R. C. Sharma, V. K. Joshi, S. K. Chauhan, S. K. Chopra and B. B. Lal, Application of osmosis – osmo-canning of apple rings, *J. Food Sci. Technol.* 28:86 (1991).
94. X. Q. Shi, P. Fito and A. Chiralt, Influence of vacuum treatment on mass transfer during osmotic dehydration of fruits, *Food Res. Int.* 28(5):445 (1995).
95. X. Q. Shi and P. F. Maupoey, Mass transfer in vacuum osmotic dehydration of fruits: a mathematical model approach, *Food Sci. Technol.* 27:67 (1994).
96. J. H. Silliker, R. P. Elliott, A. C. Baird-Parker, F. L. Bryan, J. H. B. Christian, D. S. Clark, J. C. Olson, T. A. Roberts, Eds., *Microbial Ecology of Foods*. Volume 1: Factors Affecting Life and Death of Microorganisms, Academic Press, New York, pp. 136–159 (1980).
97. E. T. F. Silveira, M. S. Rahman and K. A. Buckle, Osmotic dehydration of pineapple: kinetics and product quality, *Food Res. Int.* 29(3–4):227 (1996).
98. S. Simal, J. Benedito, E. S. Sanchez and C. Rosello, Use of ultrasound to increase mass transfer rates during osmotic dehydration, *J. Food Eng.* 36:323 (1998).
99. J. Solms, F. Osman-Ismail and M. Beyeler, The retention of volatiles with food components, *Can. Inst. Food Sci. Technol. J.* 6:10 (1973).
100. P. Talens, I. Escriche, N. Martinez-Navarrete and A. Chiralt, Influence of osmotic dehydration and freezing on the volatile profile of kiwi fruit, *Food Res. Int.* 36(6):635 (2003).
101. D. Torreggiani, Osmotic dehydration in fruit and vegetable processing, *Food Res. Int.* 26:59 (1993).
102. D. Torreggiani, Technical aspects of osmotic dehydration in foods, In *Food Preservation by Moisture Control. Fundamentals and Applications*, G. V. Barbosa-Canovas and J. Welte-Chanes, Eds., Technomic Publishing, PA, pp. 281–304 (1995).
103. D. Torreggiani and G. Bertolo, Osmotic pre-treatments in fruit processing: chemical, physical and structural effects, *J. Food Eng.* 49:247 (2001).
104. D. Torreggiani, E. Forni, M. L. Erba and F. Longoni, Functional properties of pepper osmodehydrated in hydrolyzed cheese whey permeate with or without sorbitol, *Food Res. Int.* 28(2):161 (1995).
105. E. Torringa, E. Esveld, I. Scheewe, R. van den Berg and P. Bartels, Osmotic dehydration as pre-treatment before combined microwave-hot-air drying of mushrooms, *J. Food Eng.* 49:185 (2001).
106. N. B. Tregunno and H. D. Goff, Osmodehydrofreezing of apples: structural and textural effects, *Food Res. Int.* 29(5–6):471 (1996).
107. M. B. Uddin and N. Islam, Development of shelf-stable pineapple products by different methods of drying, *J. Inst. Engrs. Bangladesh* 13:5 (1985).
108. N. H. van Nieuwenhuijzen, M. R. Zareifard and H. S. Ramaswamy, Osmotic drying kinetics of cylindrical apple slices of different sizes, *Drying Technol.* 19(3&4):525 (2001).
109. C. Vial, S. Guilbert and J. L. Cuq, Osmotic dehydration of kiwi fruits: influence of process variables on the color and ascorbic acid content, *Sciences Des Aliments* 11:63 (1991).
110. A. Voilley and D. Simatos, Retention of aroma during freeze- and air-drying, In *Food Process Engineering*, P. Linko, Y. Malkki, J. Olkkund, J. Larinkari, Eds., Applied Science Publishers, London, pp. 371–384 (1979).
111. P. M. Walde, Transport phenomena in dehydration of fish muscle. Ph.D. thesis, Norwegian University of Science and Technology, Alesund, Norway (2003).
112. W. M. Walter, H. P. Fleming, R. L. Thompson and T. I. Fine, Effect of sodium chloride concentration on calcium uptake into brined cucumbers, *J. Food Quality* 19:161 (1996).
113. A. G. Wientjes, The influence of sugar concentrations on the vapor pressure of food odor volatiles in aqueous solutions, *J. Food Sci.* 33:1 (1968).
114. F. W. Wood, The distribution of salt in pork muscle and fat tissue, *J. Sci. Food Agric.* 17:138 (1966).

# 20

## *Water Activity and Food Preservation*

Mohammad Shafiur Rahman and Theodore P. Labuza

### CONTENTS

20.1	Basics of Water Activity .....	448
20.1.1	Basic Terminologies.....	448
20.1.1.1	Water Activity .....	448
20.1.1.2	Sorption Isotherm .....	449
20.1.1.3	Hysteresis .....	449
20.1.1.4	Water Activity Shift in Isotherm.....	452
20.1.1.5	Water Activity Break.....	452
20.1.1.6	Concept of Local Isotherm .....	453
20.1.1.7	Thermodynamic Properties Prediction .....	453
20.1.1.8	Porous Structure Investigation .....	453
20.1.2	Factors Affecting Water Activity .....	454
20.1.2.1	Food Components .....	454
20.1.2.2	Physicochemical State of Food Components .....	454
20.1.2.3	Porous Structure of Foods.....	454
20.1.2.4	Temperature.....	455
20.1.2.5	Pressure.....	456
20.1.2.6	Surface Tension.....	456
20.2	Water Activity in Food Preservation .....	456
20.2.1	Monolayer Concept .....	456
20.2.2	Food Stability Diagram .....	457
20.2.3	Microbial Activity .....	457
20.2.3.1	Minimum Water Activity Limit .....	457
20.2.3.2	Mode of Action .....	459
20.2.3.3	Adaptation.....	461
20.2.4	Fat Oxidation .....	463
20.2.5	Nonenzymatic Activity .....	464
20.2.5.1	Types of Browning .....	464
20.2.5.2	Factors Affecting Browning .....	464
20.2.5.3	Maximum Browning Region .....	465
20.2.6	Enzymatic Activity.....	465
20.2.7	Vitamin Loss .....	466
20.2.8	Texture .....	466
20.3	Water Activity Concepts and Other Alternatives .....	467
20.3.1	Limitations Identified.....	467
20.3.1.1	Validity of Equilibrium Conditions .....	467
20.3.1.2	Break in the Isotherm .....	468
20.3.1.3	Effect of Solute Types.....	468
20.3.2	Glass Transition Concept.....	471
	References .....	471

## 20.1 Basics of Water Activity

Water is an important constituent of all foods. Why water activity and not water content? In the middle of the nineteenth century, scientists began to discover the existence of a relation between water in a food and its relative tendency to spoil. They also began to realize that the *active water* could be much more important to the stability of food than the total amount of water present. Scott [130,131] clearly identified that water activity of a medium correlated well with the deterioration of food stability due to the growth of microorganism. Thus, it was possible to develop generalized rules or limits for the stability of foods by using water activity. This was the main reason why food scientists started to emphasize water activity rather than water content. Since then, the scientific community has explored the great significance of water activity in determining the physical characteristics, processes, shelf life, and sensory properties of foods. The water activity of fresh foods, as shown by Chirife and Fontan [34], is 0.970–0.996. Other applications of water activity are: (i) process design and control, (ii) ingredient selection, and (iii) packaging selection. Water activity data are important to food processing, such as osmotic dehydration and air drying. In drying operations, desorption isotherms at the process temperature are needed for design and control purposes. The endpoint of drying or osmotic dehydration process can be determined from the equilibrium moisture content. In the drying process, the foods equilibrate with air equilibrium relative humidity; in osmotic or salting process, foods equilibrate with the osmotic solution water activity. Hence, water activity plays an important role in designing, operation, and control of drying processes and reverse osmosis. Water activity's depressing power of solutes needs to be considered when selecting ingredients or additives for food product formulation. When food materials are packed in a semipermeable membrane, the food will (a) collect moisture if its water activity is lower than the external relative humidity of the air or (b) lose moisture if its water activity is higher than the relative humidity. The sorption isotherm is necessary to predict the moisture transfer rate through the packaging film and edible food coating, so that shelf life can be predicted. The mathematical equations used to determine the isotherms for moisture transfer through packaging material are available in the literature [44,114].

### 20.1.1 Basic Terminologies

A number of basic terminologies related to water activity have been developed over the last 5 decades. It is important to understand these terminologies for proper utilization of water activity concept in food preservation and processing.

#### 20.1.1.1 Water Activity

Water activity, a thermodynamic property, is defined as the ratio of vapor pressure of water in a system and the vapor pressure of pure water at the same temperature, or the equilibrium relative humidity of the air surrounding the system at the same temperature. A number of methods have been reported in literature to measure or estimate the water activity of foods. Water activity measurement methods include the following: (i) equilibrium sorption rate method (isopiestic method), (ii) vapor pressure measurement method, and (iii) hygrometric instrument method. In addition, water activity can be predicted from other thermodynamic properties such as freezing point. The accuracy of most methods lies in the range of 0.01–0.02 water activity units [118]. Details of the various measurement techniques are described by Labuza et al. [80], Rizvi [118], Rahman [109], Rahman and Sablani [112], Rahman et al. [113], Fontana [53], and Sablani et al. [124]. Water activity can be lowered or controlled by several methods such as separating out of water and adding solutes. Processes that can be used to remove water are drying, concentration, and dewatering by centrifuge. Other unit operations such as baking, extrusion, and frying also reduced the water activity to some extent. Solutes can be added to foods to reduce water activity as well as improve the

**TABLE 20.1**

Some Criteria for Humectants to be Used in Foods

Safe
Approved by regulatory agencies
Effective at reasonable concentrations
Compatible with the nature of the food
Flavorless at concentrations of use
Colorless and imparts no color changes in the food

functional and sensory properties of foods, for example, adding salt to meat and fish, and adding sugars to fruits. When only solutes are used to reduce water activity, then the specific antimicrobial effects and the cost of solutes or humectants should be considered for food product formulation. The factors affecting the selection of humectants are summarized in Table 20.1.

### 20.1.1.2 Sorption Isotherm

The moisture sorption isotherm is the dependence of moisture content on the water activity of one of the samples at a specified temperature. It is usually presented in a graphical form or as an equation. Brunauer et al. [19] classified adsorption isotherms of materials into five general types (Figure 20.1). If water-soluble crystalline components are present in foods, e.g., sugars or salt, the isotherm appears as concave shape type III. Most other foods result sigmoid isotherm type II. The inflection point of the isotherm indicates the change of water-binding capacity or of the relative amounts of free and bound water. Type I is indicative of a nonswelling porous solid, such as silicate anticaking agents. For practical purposes, the isotherm is presented in an empirical or theoretical model equation. However, none of the isotherm models in the literature is valid over the entire water activity scale of 0–1. The Guggenheim-Anderson-de Boer (GAB) model is one of the most widely accepted models for foods over a wide range of water activities from 0.10 to 0.9. The details of the isotherm models with their parameters are compiled by Rizvi [118], Okos et al. [106], Lomauro et al. [91,92], and Rahman [109].

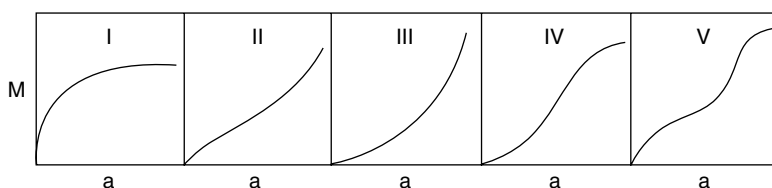
### 20.1.1.3 Hysteresis

The difference in the equilibrium moisture content between the adsorption and desorption curves is called hysteresis and is shown in Figure 20.2. In region II of this figure, the water is held less tightly and is usually present in small capillaries, whereas in region III, the water is held loosely in large capillaries or is free [53]. Hysteresis in sorption has important theoretical and practical implications in foods. The theoretical implications are evidence of irreversibility of the sorption process and the validity of the equilibrium thermodynamic process. The practical implications deal with the effects of hysteresis on chemical and microbiological deterioration and its importance on low- and intermediate-moisture foods [70]. Strasser [140] and Wolf et al. [154] maintained that changes in hysteresis could be used as an index of quality deterioration, since hysteresis loops of foods change with storage time, but this is a poor method of evaluation. Rahman and Al-Belushi [111] presented more reviews on the sorption hysteresis in foods.

#### 20.1.1.3.1 Factors Affecting Hysteresis

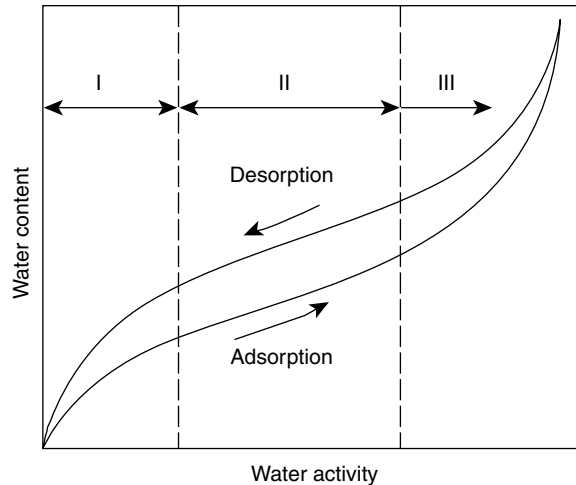
The desorption hysteresis loop usually ends at the monolayer, but in some cases it extends down to an activity of zero [77]. In foods, a variety of hysteresis loop shapes can be observed depending on the type of food and the temperature [152]. The principal factors affecting hysteresis are composition of the product, isotherm temperature, storage time before isotherm measurement, pretreatments, drying temperature, and the number of successive adsorption and desorption cycles.

**20.1.1.3.1.1 Types of Foods Affecting Hysteresis** Variations in hysteresis can be grouped into three types of foods [70]: (i) Hysteresis in high-sugar foods—in high-sugar or high-pectin foods such as air-dried apple, hysteresis occurs mainly in the monomolecular layer of water region, below the first inflection point of isotherm region I in Figure 20.2 [106]. Although the total hysteresis is large, there is no hysteresis above 0.65. (ii) Hysteresis in high-protein foods—in pork, a moderate hysteresis begins at about



**FIGURE 20.1** The five types of van der Waals adsorption isotherms proposed by Brunauer et al. [19].





**FIGURE 20.2** Sorption isotherm for typical food product showing hysteresis.

0.85 (i.e., in the capillary condensation region) [69]. (iii) Hysteresis in high-starch foods—in starchy foods a large hysteresis loop occurs, with a maximum water activity of about 0.70, which is within the capillary condensation region [106].

**20.1.1.3.1.2 Temperature Effects on Hysteresis** Total hysteresis decreases as sorption temperature increases [152]. Desorption isotherms usually give a higher water content than adsorption isotherm. Chinachoti and Steinberg [28] found hysteresis in sugar containing starch up to 0.60 and Bolin [13] in resin (with very high sugar content) up to 0.30. Tsami et al. [145] observed significant hysteresis below 0.5 or 0.6 and at temperatures above 30°C in case of fruits (raisin, currant, fig, prune, and apricot) and mentioned that absence of hysteresis at higher temperatures was due to the dissolution of sugars at high temperatures. The water activity below which a significant hysteresis effect was manifested was inversely proportional to the sugar content of the fruits [145]. In high-sugar or high-pectin foods such as air-dried apple, hysteresis occurs mainly in the monomolecular layer of water region [106]. Although the total hysteresis is large, there is no hysteresis above 0.65. In case of pork, a moderate hysteresis begins at about 0.85 (i.e., in the capillary condensation region) [69]. In starchy foods, a large hysteresis loop occurs with a maximum water activity of about 0.70, which is within the capillary condensation region [106], whereas in case of kudzu starch hysteresis continues up to 0.90 [12]. Increasing the temperature decreases the total hysteresis [154]. Iglesias and Chirife [64] estimated and compared the isosteric heats of water adsorption and desorption for a number of foods and reported that the effect of temperature on the magnitude of hysteresis varied. There was no direct relationship between the observed differences in adsorption and desorption heats and the distribution of hysteresis along the isotherm. For some foods (thyme, winter savoy, sweet marjoram, cooked trout, raw and cooked chicken, and tapioca), increasing temperature decreased or eliminated hysteresis, while for others the total hysteresis remained constant (ginger and nutmeg) or even increased (anise, cinnamon, chamomile, and coriander) [70].

**20.1.1.3.1.3 Effects of Physicochemical Nature** The type of changes encountered upon adsorption and desorption depends on: (i) initial state of the sorbent (amorphous versus crystalline), (ii) transitions taking place during adsorption, (iii) final water activity adsorption point, and (iv) sorption rate. If the saturation point has been reached and the material has gone into sorption, rapid desorption may preserve the amorphous state due to supersaturation [70]. Some water remained after desorption at dry conditions even after prolonged storage due to hydrogen-bonded trapped water in the amorphous sugar microregions as well as water of crystallinity [42,154].

*20.1.1.3.1.4 Effects of the Sorption Cycle on Hysteresis* In some cases hysteresis seems to be reproducible a second time [5,140], and for some cases the second sorption–desorption cycle resulted in the elimination of hysteresis [4]. Elimination of hysteresis upon the second or subsequent cycles may take place for a variety of reasons, including change in crystalline structure when a new crystalline form persists in subsequent cycles [6], swelling and increased elasticity of capillary walls resulting in a loss of power of trapping water [115,116], denaturation [39], surface-active agents [122], and even mechanical treatment, which may affect the capillary structure [70].

#### *20.1.1.3.2 Theories of Sorption Hysteresis*

Several theories have been formulated to explain the phenomenon of hysteresis but at present no theory has given a complete insight into the several mechanisms responsible [145], and no quantitative prediction of hysteresis is available in literature. The theories proposed in the literature on the causes of hysteresis are discussed in the following sections.

*20.1.1.3.2.1 Capillary Condensation* This can mainly explain hysteresis in nonswelling porous solids. Capillary condensation can be explained using the Kelvin equation. Owing to the presence of impurities, such as dissolved gas, the contact angle of the receding film upon desorption is smaller than that of the advancing film upon adsorption. Therefore, capillary condensation along the adsorption branch of the moisture sorption isotherm is at a higher relative vapor pressure [69].

*20.1.1.3.2.2 Ink Bottle Theory* Rao [117] assumed capillaries to be composed of narrow necks with a large pore, somewhat like an ink bottle. On adsorption, the capillary does not completely fill until the water activity corresponding to the large radius of the pore is reached. During desorption, the smaller radius of the pore neck controls the emptying of the capillary, so that activity is lowered considerably [77]. This theory was confirmed by Labuza and Rutman [83] for a cellulose model system. Cohan [41] elaborated upon the open-pore theory by extending the bottleneck theory, including considerations of multilayer adsorption. This was based on the difference as affected by the shape of the meniscus.

*20.1.1.3.2.3 Mechanisms of Physicochemical Changes* The physicochemical changes in food components also cause hysteresis, such as deformability and elastic stresses of the sorbent, a deformation of the polypeptide chains within the protein molecule [70], and the energy surplus of unfolding (swollen) protein phase transition [23]. Kapsalis [70] discussed that adsorption from the dry state by biopolymers is due to: (i) side chain amino groups, (ii) end carboxylic and other groups, (iii) peptide bonds, and (iv) secondary structures. In general, below 0.5 water activity the main sites of sorption are the polar side chain groups. The contribution of the polypeptide chain becomes progressively more important at higher activities, for example, at 0.80 activity the peptide bonds account for almost half the adsorbed water in wool keratin. Deamination of methylation of side chain groups in wool and benzylation in casein did not show any appreciable changes of hysteresis [100]. This suggested that it was the main chains of the biopolymers that were primarily responsible [70]. Sheehof et al. [133] supported the polar group interpretation of hysteresis, where binding mainly involves the free basic groups of the protein. Kapsalis [70] showed a correlation between the maximum amount of hysteresis with the sum of arginine, histidine, lysine, and cystine groupings. Besides the free basic groups of the protein molecule, sulfur linkages are also of prime importance in hysteresis [137]. In contrast to this work, hysteresis in casein was observed to be independent of the content of free amino groups [100]. Thus, a twofold nature of hysteresis was proposed: constant hysteresis, independent of the relative humidity desorption point; and hysteresis proportional to the amount adsorbed above the upper adsorption break of the isotherm [70]. In a swelling polymer, hysteresis depends on the mechanical constants contributed by the elastic properties and cannot be interpreted by capillary condensation [7]. Van Olphen [148] described retardation of adsorption due to the development of elastic stress in crystallites during the initial peripheral penetration of water between the unit layers. The shift toward higher relative vapor pressure during adsorption is caused by the activation energy required to open the unit layer stacks. The glass–rubber transition during adsorption and desorption may also cause hysteresis due to the nonequilibrium state of phase transition.

**20.1.1.3.2.4 Structural Collapse** With sorption, the capillary pores of the adsorbent become elastic and swell. Upon desorption, the removal of water causes shrinkage, and a general collapse of the capillary porous structure occurs. Alteration of structure causes elimination of hysteresis due to the absence of capillary condensation [70]. The collapse of capillaries during desorption also affects sorption hysteresis.

#### 20.1.1.4 Water Activity Shift in Isotherm

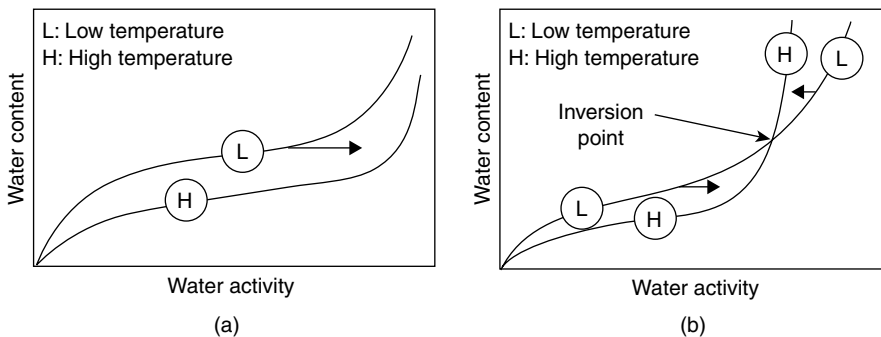
The isotherm shift due to temperature can usually be estimated by the well-known Clausius–Clapeyron equation [50,81]:

$$\ln \frac{(a_w)_2}{(a_w)_1} = \frac{q + \lambda_w}{R} \left[ \frac{1}{T_2} - \frac{1}{T_1} \right] \quad (20.1)$$

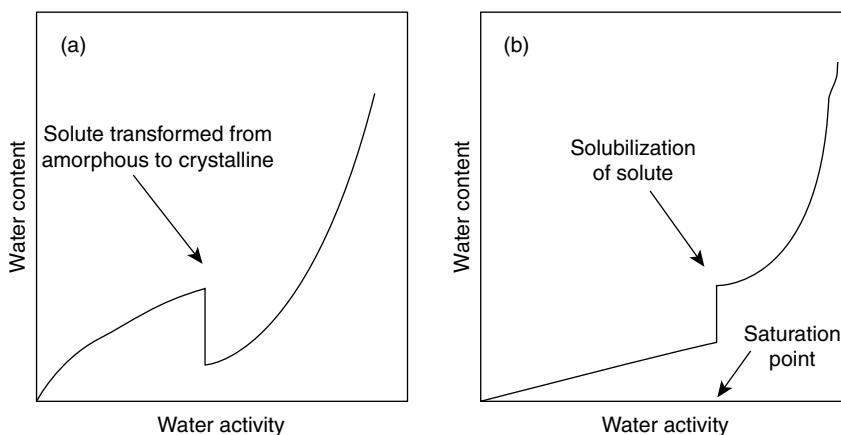
The slope of a plot of  $\ln a_w$  versus  $1/T$  should give the value of  $(q + \lambda_w)/R$ , where  $q$  is the excess heat of sorption (kJ/kg) and  $\lambda_w$  the latent heat of vaporization for water (kJ/kg). Typical water activity shift due to temperature at constant moisture content is shown in Figure 20.3. The water activity shift caused by temperature is mainly due to the change in water binding, dissociation of water, physical state of water, or increase in the solubility of solute in water. It is widely accepted that an increase in temperature results in decreased equilibrium moisture content (Figure 20.3a). Tsami et al. [145] found similar results for the dried fruits up to a water activity of about 0.55–0.70. In that region, the curves for several temperatures intersect. At water activity values higher than 0.7, there was an inversion in the effect of temperature (i.e., equilibrium moisture content increased with temperature) due to an increase in solubility of sugars in water. The intersection (or inversion) point depends on the composition of the food and the solubility of sugars [152]. For sultana raisin and currant, the inversion point was about 0.55, likewise, 0.65 for fig, 0.70 for prune, 0.75 for apricot (possessing the lowest sugar content of fruit) [145], 0.55 for quince jam (ferbar brand), and 0.65 for quince jam (tapada nova) [123]. A similar intersection was also found by Saravacos et al. [128] for sultana raisin and by Weisser et al. [151] for sugar alcohol. Apple (low sugar fruit) does not show intersection [121]. For products with protein or starch content, there is also no intersection point with the increase of temperature [4].

#### 20.1.1.5 Water Activity Break

In a pure component isotherm, the change of solute from the amorphous state to a crystal affects the isotherm. A break is observed in the isotherm, as shown in Figure 20.4. In some foods, one part of the solute (salts and sugar) is bound to a polymer (protein and starch) and the other part is crystalline or amorphous. Bound and free forms of solutes are in equilibrium, which is strongly dependent on the actual water activity. If change in water activity takes place slowly, this equilibrium may be maintained, whereas during rapid changes nonequilibrium conditions are likely to be attained. Bound, crystalline, and amorphous solutes produce characteristic changes (i.e., break and shift) in the water sorption isotherm [57]. A typical curve showing break is shown in Figure 20.4b, where a break is also observed due to transformation of



**FIGURE 20.3** Water activity shift of food due to temperature. (a) Shift without intersection. (b) Shift showing the point of intersection or inversion point.



**FIGURE 20.4** Water activity shift of food due to physicochemical parameters. (a) Shift with solute transformation from amorphous to crystalline. (b) Shift with solubilization of solute.

the solute from an amorphous to a crystalline state. This break was observed for sodium chloride–starch mixture [27]; sucrose–starch mixtures [26]; and sucrose, albumin, and gluten mixtures [29].

#### 20.1.1.6 Concept of Local Isotherm

Rockland [119] proposed the concept of local isotherm to characterize the physical state or special type of water binding in foods [65]. The local isotherm can be identified by graphical analysis of experimental sorption data according to Henderson's equation. The three localized isotherms may be distinguished by plotting experimental sorption data as  $\ln[-\ln(1-a)]$  versus  $\ln M_w$ . Three straight lines rather than a single straight line are observed, each being identified as a local isotherm. The three regions are identified as three types of water. Iglesias and Chirife [64] analyzed 235 isotherms based on this concept and concluded that although in a broad sense the local isotherms proposed by Rockland [119] may be related to the different modes of water binding, they cannot be used to give a precise and unequivocal definition of the physical state of water in foods. Moreover, the original Henderson equation should give only one curve during complete water activity range. In reality more linear segments in the curve present a poor fit.

#### 20.1.1.7 Thermodynamic Properties Prediction

Thermodynamic properties such as the freezing point, boiling point, and heat sorption can also be predicted from water activity. For example, the freezing point (Equation 20.2) and boiling point (Equation 20.3) can be estimated as follows [51]:

$$\ln a_w = 9.6934 \times 10^{-3} \delta + 4.761 \times 10^{-6} \delta^2 \quad (20.2)$$

$$\ln a_w = 1.1195 \times 10^{-4} \delta^2 - 3.5127 \times 10^{-2} \delta \quad (20.3)$$

where  $\delta$  is the freezing point depression or boiling point depression. The above equation could be very useful when measurement of freezing point is very fast and easy.

#### 20.1.1.8 Porous Structure Investigation

Water sorption can be influenced by the surface area and porosity of the food material. The characteristics of a material (e.g., porous or nonporous) can be determined from sorption isotherms. It has been proposed in the literature that water activity could be used to calculate the food surface area as well as the pore size. However, Nagai and Yano [103] found the surface area and pore size calculated from the water sorption to be misleading. They suggested that water adsorption not only occurred on the surface, but also mainly on the water-binding sites inside the structure that does not increase with an increase in surface area.

## 20.1.2 Factors Affecting Water Activity

### 20.1.2.1 Food Components

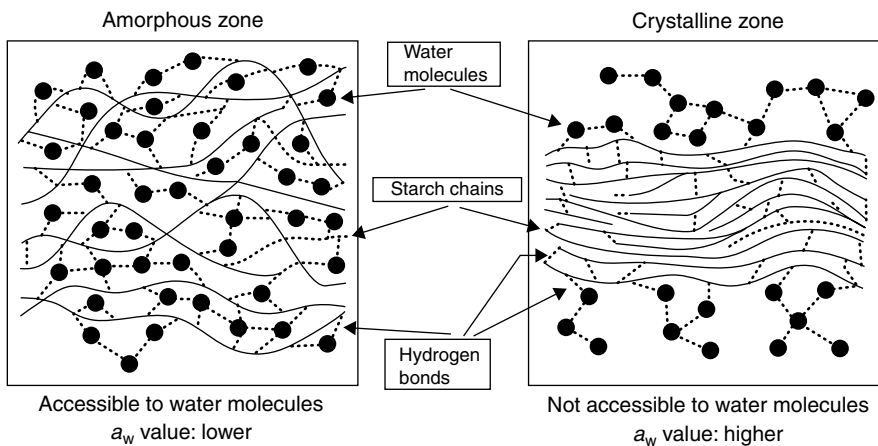
Protein and starch adsorb much more water at low water activities than do fatty materials or crystalline substances like sugar. Pretreatment, such as heating, has little effect on proteins. On the other hand, such pretreatment increases the amount of water-impenetrable crystalline starch at the expense of amorphous starch. The smaller active site for adsorption means that less water can be adsorbed [77]. Sugars and salts present a difficult problem because the change from an amorphous to a crystalline state occurs fairly rapidly at normal temperature [94]. This change releases water, which may be picked up by other materials if the sugar is present in a mixture such as dried milk. The material would then become sticky and lumpy, making it undesirable. Salwin [127] observed that the equilibrium condition obtained is not an equal moisture content in all components in multicomponent mixture, but an equal activity.

### 20.1.2.2 Physicochemical State of Food Components

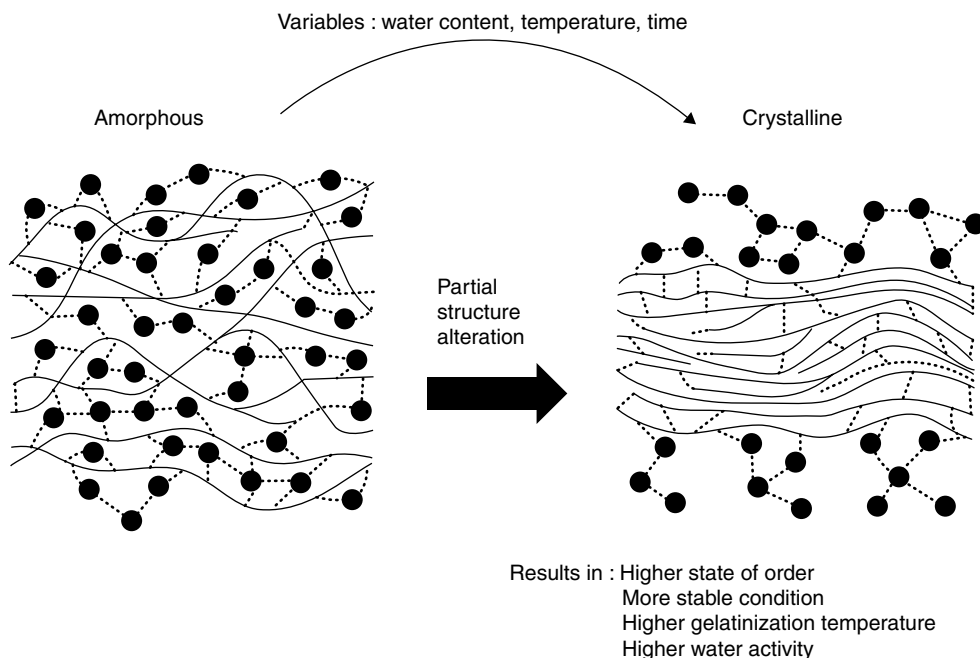
Many food components may be present in several states: crystalline solids, amorphous solids either rubbery or glassy, aqueous solution, or bound to other components. Sorption in such systems is complex. Crystalline sugars adsorb very little water, but amorphous sugars adsorb substantially more water at the same conditions. The adsorption of water results in breaking of some hydrogen bond and an increase in mobility of sugar molecules, resulting eventually in the sugars transforming to the crystalline state. In this process the sugar loses water [71]. However, the sugar-polymer interaction and physical state play an important role in separating out water from the system. Gelatinization followed by freeze drying results in only minor differences in water-binding behavior of water activity up to 0.94; above 0.95 the gelatinized samples adsorb considerably more water [147]. Saltmarch and Labuza [126] studied the effects of water activity and temperature on the transition of lactose from the amorphous to the crystalline state. Results from scanning electron microscopy indicated that lactose crystallized at 0.40, 0.33, and 0.33 water activity after 1 week at 25°C, 35°C, and 45°C, respectively. Water activity also influences protein conformation. The annealing effect of water, time, and temperature can alter the structural and functional properties of cereal starch (Figures 20.5 and 20.6). When crystalline starch is transformed to amorphous form, polar sites develop in the starch molecule, which could form hydrogen bonds with water molecules [102].

### 20.1.2.3 Porous Structure of Foods

Structure or pore size and distribution of material may also affect the sharply increasing region at higher water activity.



**FIGURE 20.5** Schematic model of starch structure during amorphous and crystalline states. (From Munzing, K. 1991. *Thermochim. Acta* 193: 441–448.)



**FIGURE 20.6** Annealing effects of starch induced by water, temperature, and time. (From Munzing, K. 1991. *Thermochim. Acta* 193: 441–448.)

### 20.1.2.4 Temperature

#### 20.1.2.4.1 Above Freezing

The isotherm shift due to temperature can be estimated by Clausius–Clapeyron equation as discussed earlier.

#### 20.1.2.4.2 Below Freezing

Information in the literature on water activity of the frozen state below freezing is limited [70]. The vapor pressures of animal tissues over the temperature span of  $-26^{\circ}\text{C}$  to  $-1^{\circ}\text{C}$  ranged from 13% to 20% lower than those of pure ice at the same temperature [46,63]. Other researchers demonstrated that the vapor pressures of frozen biological materials were equal to the vapor pressure of ice at the same temperatures [47,49,93,139]. Water activity values at subfreezing temperatures can be calculated (rather than measured) as [70]

$$a_w = \frac{\text{Vapor pressure of solid water (ice)}}{\text{Vapor pressure of liquid supercooled water (not ice)}} \quad (20.4)$$

The equation indicates that water activity does not depend on the composition, but only on the temperature. In a two-phase system (ice and solution) at equilibrium, the vapor pressure of solid water as ice crystals and the interstitial concentrated solution are identical; thus, water activity depends only on the temperature, and not on the nature and initial concentration of solutes, present in the third or fourth phase (i.e., irrespective of the kind of food). This creates a basis to estimate the water activity of foods below freezing using Equation 20.4. Thus, Fennema [49] concluded that changes in properties could occur below freezing without any change in water activity. These include changes in diffusion properties, addition of additives or preservatives, and disruption of cellular systems. The water activity data of ice from  $0^{\circ}\text{C}$  to  $-50^{\circ}\text{C}$  are correlated with an exponential function as

$$a_w = 8.727 \left[ \exp \left( - \frac{595.1}{T} \right) \right] \quad (20.5)$$

where  $T$  is in K. The maximum error in prediction is 0.012 unit water activity and the average is 0.0066, respectively. The data of Fennema [49] were used to develop the above correlation.

### 20.1.2.5 Pressure

The effect of pressure on the sorption isotherm is relatively small and negligible at reasonable pressure levels [106]. At constant moisture content, the variation of water activity with pressure can be derived thermodynamically as [106]

$$\ln \frac{a_2}{a_1} = \frac{\lambda_w}{\rho_w RT} (P_2 - P_1)$$

where  $a_1$  and  $a_2$  are the water activity at  $P_1$  and  $P_2$ ,  $R$  is the gas constant ( $82.05 \times 10^{-3} \text{ m}^3 \text{ atm/kg mole K}$  or  $8.314 \times 10^3 \text{ m}^3 \text{ Pa/kg mole K}$ ),  $T$  the temperature (K), and  $P_1$  and  $P_2$  are total pressure (atm or Pa).

### 20.1.2.6 Surface Tension

The effect of capillary action on water activity can be estimated from the Kelvin equation as

$$a_w = \exp\left(-\frac{\Delta P V_m}{RT}\right)$$

For spherical interface

$$\Delta P = \gamma_s \left[ \frac{1}{r_1} + \frac{1}{r_2} \right] \cos \theta$$

where  $\Delta P$  is the pointing pressure (Pa),  $V_m$  the liquid molar volume ( $18 \text{ m}^3/\text{kg mole}$ ),  $R$  the gas constant ( $8.314 \text{ Nm/kgmolK}$ ),  $T$  the temperature (K),  $\gamma_s$  the surface tension (N/m),  $\cos \theta$  the contact angle, and  $r$  the radius of curvature (m). If the droplet is spherical, then  $r_1 = r_2$  and the above equation can be written as

$$a_w = \exp\left[-\frac{2\gamma \cos \theta V_m}{rRT}\right]$$

If surface tension is reduced by a factor of 0.5, the ratio of the water activities at the two conditions can be calculated using the above equation. The ratio is 0.995 at  $20^\circ\text{C}$ , thus the effect of surface tension cannot be measured. Chen and Karmas [25] reported that in case of intermediate food solutions, water activity increased very little as the surface tension decreased. They suggested that ingredients that result in reduction of surface tension should be avoided to attain low water activity. In contrast to Chen and Karmas [25], Alzamora et al. [1] found that surface tension did not appear to have any significant effect on water activity, at least within the range of apparatus error from 0.004 to 0.005 water activity unit.

## 20.2 Water Activity in Food Preservation

### 20.2.1 Monolayer Concept

The monolayer value can be determined from Brunaur-Emmett-Teller (BET) isotherm and is widely used to determine the stability of foods. The BET equation can be derived from kinetic, statistical mechanics, or thermodynamic considerations. The equation can be written as

$$\frac{a_w}{M_w(1-a_w)} = \left(\frac{C-1}{M_m}\right)a_w + \frac{1}{M_m C}$$

where  $a_w$  is the water activity,  $M_m$  the BET monolayer, and  $C$  the temperature dependence for sorption excess enthalpy. The value of  $C$  indicates how strongly water is bound to the polar sites of the solid matrix and can be related with temperature as

$$C = \alpha \left[ \exp\left(-\frac{Q_s}{RT}\right) \right]$$

where  $Q_s$  is the excess heat of sorption (kJ/kg) and  $\alpha$  the preexponent factor. The monolayer can be estimated from the slope of the linear line of the plot  $a_w/M_w(1-a_w)$  versus  $a_w$ . The BET equation is valid only within 0.05–0.50 water activity. Thus, values within that range should be used to estimate the

monolayer value. The monolayer value is generally around a water activity of 0.2–0.4 [78]. In addition, the BET monolayer calculation is an effective method for estimating the amount of bound water to specific polar sites in dehydrated food systems [98]. The BET monolayer values usually vary from 0.01 to 0.14 (dry basis) in case of foods and food components. Macromolecules such as starch, protein, and agar usually have higher BET monolayer whereas high fat content foods such as avocado, peanuts, and whole milk showed lower monolayer. Iglesias and Chirife [64] found that monolayer values decreased significantly with increasing temperature after studying 100 foods and food components. This may be due to the thermodynamics where higher temperatures increase the escaping tendencies of gas molecules. In recent years, the most widely accepted and represented model for sorption isotherms for foods has been the GAB. This is mainly due to its accuracy and its validity over a wide range of water activities from 0.1 to 0.9. The GAB isotherm was developed by Guggenheim, Anderson, and De Boer and can be written as

$$M_w = \frac{M_{gm}CKa_w}{(1 - Ka_w)(1 - Ka_w + CKa_w)}$$

where  $C$  and  $K$  are the model parameters and are related to the temperature. The GAB isotherm equation is an extension of the two-constant BET model and takes into account the modified properties of the sorbate in the multilayer region and bulk liquid properties through the introduction of a third constant  $K$ . The GAB model parameters and monolayer values have been compiled by Rahman [109] for a number of food products. It is important to point that BET monolayer has more physical meaning and acceptability to be used for food stability compared to the GAB monolayer, although GAB provides better mathematical prediction of isotherm over the wide range of water activities. Recently, the advantages were discussed by Rahman and Al-Belushi [111].

## 20.2.2 Food Stability Diagram

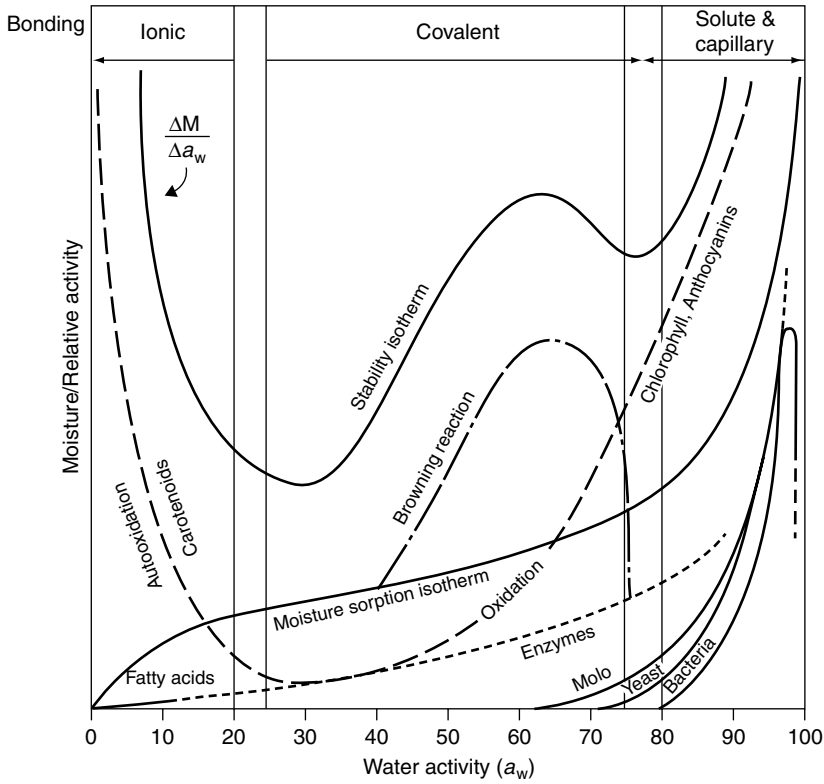
The moisture sorption isotherm is an extremely valuable tool for food scientists because of its usefulness in predicting food stability. Most foods have a critical moisture content below which the rate of quality loss is negligible. Quality is understood to include growth and toxin production by microorganisms as well as chemical deterioration and decrease of sensory intensity, such as crispness, hardness, caking, texture, color, flavor or aroma [78]. A global food stability map is presented in Figure 20.7 [84,120]. As discussed by Labuza [78], the rate of quality loss begins to increase above water activity 0.2–0.3 for most chemical reactions (Figure 20.7). At this water activity, the amount of water adsorbed on surfaces and in capillaries is enough to affect the overall dielectric properties such that the water can now behave as a solvent. Thus, chemical species can dissolve, become mobile, and are reactive. The higher the water activity, the faster the reaction rate because of the greater solubility and increased mobility of the reactants. However, at some higher water activity no further species dissolve, and therefore an increase in water activity decreases the concentration of the reacting species. Since the rate of a reaction is proportional to concentration on a molecular basis, the rate should reach a maximum and then fall as in Figure 20.7. Between this maximum and the monolayer, a semilog plot of rate versus water activity generally results in a straight line. For most dry foods, an increase of 0.1 water activity unit in this region decreases shelf life two to three times [78].

## 20.2.3 Microbial Activity

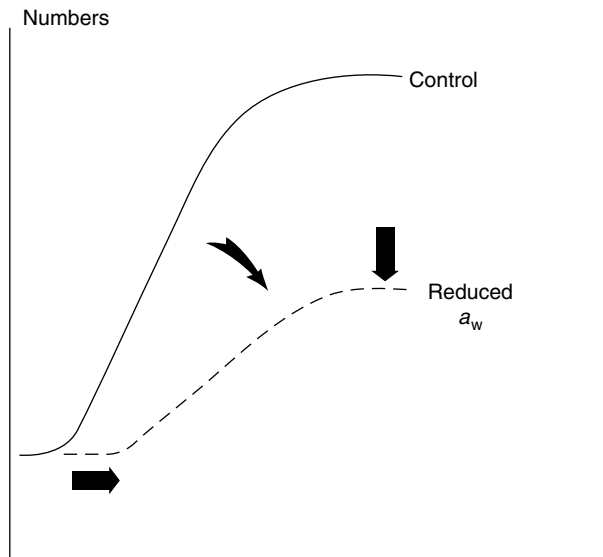
### 20.2.3.1 Minimum Water Activity Limit

The minimum water activity is the limit below which a microorganism or group of microorganisms can no longer reproduce. Hypothetical curves showing effects of water activity are presented in Figure 20.8. The initial portion of this growth curve is composed of a lag phase during which the physiological machinery is created for later growth. The lag period is increased with an increase in solute content or a decrease in water activity. The growth or logarithmic phase is also affected by water activity as shown in Figure 20.8 [143]. Secondary metabolites are produced by some microorganisms that are highly toxic and carcinogenic to humans. The factors that affect spore formation can influence the formation of these metabolites. Beuchat [9] summarized the effects of water activity on spore formation and germination as well as toxin production by microorganisms commonly associated with foods and food spoilage. Minimal water activity values for





**FIGURE 20.7** Food stability as a function of water activity. (From Rockland, L. B. and Beuchat, L. R. 1987. In: *Introduction, Water Activity: Theory and Applications to Food*. Rockland, L. B. and Beuchat, L. R. eds. Marcel Dekker, New York. p. v.)



**FIGURE 20.8** Hypothetical curves showing effects of water activity reduction on bacterial growth. (From Troller, J. A. 1987. In: *Water Activity: Theory and Applications to Food*. Rockland, L. B. and Beuchat, L. R. eds. Marcel Dekker, New York. pp. 101–117.)

growth and toxin production by microorganisms of public health significance are listed in Tables 20.2 through 20.7. The concern of food safety increases with increasing water activity. The water activity values of some foods cause their susceptibility to spoilage microorganisms as shown in Table 20.7 [8]. There is a critical water activity below which no microorganisms can grow. For most foods, this is in the 0.6–0.7 water activity range. Pathogenic bacteria cannot grow below a water activity of 0.85–0.86, whereas yeast and molds are more tolerant to a reduced water activity of 0.80, but usually no growth occurs below a water activity of about 0.62 [32]. The critical limits of water activity may also be shifted to higher or lower levels by other factors, such as pH, salt, antimicrobial agents, heat treatment, and temperature of storage. Leistner and Rodel [88] found the rate of microbial death during frozen storage to be reduced by a decrease in temperature without fluctuation. Thus, they suggested that the microbiological quality of frozen foods could be improved by initial storage of foods at  $-10^{\circ}\text{C}$  ( $a_w = 0.90$ ) to reduce the number of undesirable organisms followed by freezing at very low temperature (i.e.,  $-30^{\circ}\text{C}$ ) [89]. In case of selected penicillia, spores produced on media at 0.99 water activity appeared more heat resistant compared to those produced at 0.88 water activity [11]. All treated spores were more sensitive to benzoate and sorbate but more resistant to cycloheximide. McClure [97] provided a review on the effect of water activity on the growth of microorganisms.

### 20.2.3.2 Mode of Action

For many years, scientists believed these mechanisms relied mainly on the influx and outflow of small, charged inorganic particles, primarily the ions of sodium, potassium, hydrogen, and chloride. Cell physiologists are coming to appreciate that changes in a cell's volume compromise more than just the shape or even the integrity of a cell. Any imbalance in the number of dissolved particles between a cell's interior and exterior can cause water either to rush in and burst the cell's membrane, or to seep out, causing the cell

**TABLE 20.2**

Minimal  $a_w$  for Growth and Toxin Production by Bacteria of Public Health Concern

Bacteria	Minimal Water Activity for		
	Growth	Toxin Production	Toxin
<i>Bacillus cereus</i>	0.93–0.95	–	–
<i>Clostridium botulinum</i>	0.93–0.95	0.94–0.95	Type A
	0.93–0.94	0.94	Type B
	0.95–0.97	0.97	Type E
<i>Clostridium perfringens</i>	0.93–0.95	–	–
<i>Salmonella</i> spp.	0.92–0.95	–	–
<i>Staphylococcus aureus</i>	0.86–0.87	0.87–0.90	Enterotoxin A
	0.86–0.87	0.97	Enterotoxin B
<i>Vibrio parahaemolyticus</i>	0.94	–	–

Source: Beuchat, L. R. 1981. *Cereal Foods World* 26: 345–349.

**TABLE 20.3**

Minimal  $a_w$  for Growth of Foodborne Pathogens in Laboratory Media at Optimum pH and Temperature

Pathogen	Minimal $a_w$	Pathogen	Minimal $a_w$
<i>Campylobacter jejuni</i>	0.990	<i>Salmonella</i> spp.	0.940
<i>Aeromonas hydrophilia</i>	0.970	<i>Escherichia coli</i>	0.935
<i>Clostridium botulinum</i> E	0.965	<i>Vibrio parahaemolyticus</i>	0.936
<i>Clostridium botulinum</i> G	0.965	<i>Bacillus cereus</i>	0.930
<i>Shigella</i> spp.	0.960	<i>Listeria monocytogenes</i>	0.920
<i>Yersinia enterocolitica</i>	0.960	<i>Staphylococcus aureus</i> (anaerobic)	0.910
<i>Clostridium perfringens</i>	0.945	<i>Staphylococcus aureus</i> (aerobic)	0.860
<i>Clostridium botulinum</i> A and B	0.940		

Source: Chirife, J. 1993. *Food Control* 4: 210.

TABLE 20.4

Sodium Chloride versus Glycerol in Minimum Water Activity Supporting Growth of Pathogenic Bacteria

Bacteria	$a_w$ Adjusted with	
	Sodium Chloride	Glycerol
<i>Clostridium botulinum</i> E	0.966	0.943
<i>Clostridium botulinum</i> G	0.966	–
<i>Escherichia coli</i>	0.945	0.940
<i>Clostridium perfringens</i>	0.945	0.930
<i>Salmonella</i> spp.	0.941	–
<i>Clostridium botulinum</i> A and B	0.940	0.930
<i>Vibrio parahaemolyticus</i>	0.932	0.911
<i>Bacillus cereus</i>	0.930	0.920
<i>Listeria monocytogenes</i>	0.920	0.900
<i>Staphylococcus aureus</i>	0.860	0.890

Source: Chirife, J. and Buera, M. D. P. 1996. *Crit. Rev. Food Sci. Nutri.* 36(5): 465–513.

TABLE 20.5

Minimal Water Activity for Growth of Pathogenic Bacteria<sup>a</sup>

Bacteria	NaCl	KCl	Sucrose	Glucose
<i>Listeria monocytogenes</i>	0.920	–	0.920	–
<i>Vibrio parahaemolyticus</i>	0.935	0.936	0.940	–
<i>Clostridium botulinum</i> G	0.965	–	0.965	–
<i>Clostridium botulinum</i> E	0.972	0.972	0.972	0.975
<i>Clostridium perfringens</i>	0.945	–	–	0.946
<i>Staphylococcus aureus</i>	0.864	0.864	0.867	–

<sup>a</sup>In laboratory media, water activity adjusted with salts (NaCl and KCl) or sugars (sucrose and glucose).

Source: Chirife, J. 1994. *J. Food Eng.* 22: 409–419.

TABLE 20.6

Minimal  $a_w$  for Growth of and Toxin Production by Molds of Public Health Concern

Mold	Minimal Water Activity for		
	Growth	Toxin Production	Toxin
<i>Alternaria alternate</i>	–	<0.90	Altenuene, alternariol, alternariol monomethyl ether
<i>Aspergillus flavus</i>	0.78–0.80	0.83–0.87	Aflatoxin
<i>Aspergillus parasiticus</i>	0.82	0.87	Flatoxin
<i>Aspergillus oryzae</i>	0.77–0.83	0.83–0.87	Ochratoxin
<i>Byssoschlamys nivea</i>	0.84	–	–
<i>Penicillium cyclopium</i>	0.81–0.85	0.87–0.90	Ochratoxin
<i>Penicillium viridicatu</i>	0.83	0.83–0.86	Ochratoxin
<i>Penicillium ochraceus</i>	0.76–0.81	0.80–0.88	Penicillic acid
<i>Penicillium cyclopium</i>	0.82–0.87	0.97	Penicillic acid
<i>Penicillium martensii</i>	0.79–0.83	0.99	Penicillic acid
<i>Penicillium islandicum</i>	0.83	–	–
<i>Penicillium urticae</i>	0.81–0.85	0.85–0.95	Patulin
<i>Penicillium expansum</i>	0.83–0.85	0.99	Patulin
<i>Stachybotrys atra</i>	0.94	0.94	Stachybotrym
<i>Trichothecium roseum</i>	0.90	–	Trichothecine

Source: Beuchat, L. R. 1981. *Cereal Foods World* 26: 345–349.

TABLE 20.7

Water Activity of Some Foods and Susceptibility to Spoilage by Microorganisms

Range of $a_w$	Microorganisms Generally Inhibited by the Lowest $a_w$ in This Range	Examples of Foods Generally within This Range of $a_w$
1.00–0.95	<i>Pseudomonas</i> , <i>Escherichia</i> , <i>Proteus</i> , <i>Shigella</i> , <i>Klebsiella</i> , <i>Bacillus</i> , <i>Clostridium perfringens</i> , some yeasts	Highly perishable foods (fresh and canned fruit, vegetables, meet fish) and milk; cooked sausages and breads
0.95–0.91	<i>Salmonella</i> , <i>Vibrio parahaemolyticus</i> , <i>C. botulinum</i> , <i>Serratia</i> , <i>Lactobacillus</i> , <i>Pediococcus</i> , some molds, <i>Rhodotorula</i> , <i>Pichia</i>	Some cheeses (Cheddar, Swiss, Muenster, provolone), cured meat, some fruit juice concentrates
0.91–0.87	Many yeasts ( <i>Candida</i> , <i>Torulopsis</i> , <i>Hansenula</i> ), <i>Micrococcus</i>	Fermented sausage (salami), sponge cakes, dry cheeses, margarine
0.87–0.80	Most molds (mycotoxigenic penicillia), <i>Staphylococcus aureus</i> , most <i>Saccharomyces</i> (billii) ssp., <i>Debaryomyces</i>	Most fruit juice concentrates, sweetened condensed milk, chocolate syrup, maple and fruit syrup, rice, pulses, fruit cakes, country-style ham, fondants, high sugar cake
0.80–0.75	Most halophilic bacteria, mycotoxigenic aspergilli	Jam, marmalade, marzipan, glace fruit, some marshmallows
0.75–0.65	Xerophilic molds ( <i>Aspergillus chevalieri</i> , <i>A. candidus</i> , <i>Wallemia sebi</i> ), <i>Saccharomyces bisporus</i>	Rolled oats, grained nougats, fudge, marshmallows, jelly, molasses, raw can sugar, some dried fruits, nuts
0.65–0.60	Osmophilic yeasts ( <i>Saccharomyces rouxii</i> ), a few molds ( <i>Aspergillus echinulatus</i> , <i>Monascus bisporus</i> )	Dried fruits, some toffees and caramels, honey
0.50	No microbial proliferation	Noodles, spaghetti, dried spices
0.40		Whole egg powder
0.30		Cookies, crackers, bread crusts
0.20		Whole milk powder, dried vegetables, corn flask, dehydrated soup, some cookies, crackers

Source: Beuchat, L. R. 1981. *Cereal Foods World* 26: 345–349.

to shrink. In case of hypertonic solution, the cells shrink whereas in case of hypotonic solution, cells expands [85]. A decrease in water activity in the environment increases the osmotic stress of microbial cells because the cells always try to maintain a slightly lower internal osmolality (i.e., water activity). This causes an influx of water into the cell to maintain surface integrity. It is the disruption of this process by solutes that leads to cell damage and death. In addition to osmotic stress, solutes may have other effects on microorganisms, including enzyme inhibition, cytoplasmic coagulation, and damage to the cell wall. Brown [18] showed that high levels of salt with antibiotics like penicillium and cycloserine caused prokaryotic cell walls to become fragile while strong-walled eukaryotes survived. In the above case, the controlling mode of action was damage to the cell wall. Water activity can explain only the osmotic stress. Genetic control is closely tied to the amino acid pool, especially betaine and praline, and the potassium level in the cell.

### 20.2.3.3 Adaptation

A variety of mechanisms may help avoid water loss or gain from microorganisms [58]. Such mechanisms are reviewed by Troller [143].

### 20.2.3.3.1 Sensing and Translation

While potassium may or may not be the trigger that initiates the process of osmoregulation, its transport into the cell is the primary modulatory event [61]. Helmer et al. [62], in a series of experiments, demonstrated that at least two and probably four  $K^+$  transport systems exist in *Escherichia coli*. The first system is accomplished, in part, by a series of three high-affinity genes. The first three genes of the inner membrane proteins of various molecular weights act as gatekeepers. The fourth gene alters its conformation in a manner that permits and intensifies transcription to maintain cytoplasmic  $K^+$  content [47]. The second system is constitutive and requires ATP and a proton motive force to supply energy for net  $K^+$  uptake. Helmer et al. [62] identified a proton motive force as supplying the primary energy to drive this reaction, whereas ATP supplies the energy to turn off  $K^+$  transport. Another system, the  $K^+$  export model, has only been postulated and is of some interest because of the potential existence of export-blocking proteins that might be synthesized by the cell in response to osmotic challenge. In this case,  $K^+$  would not be pumped out of the cell but would be retained to trigger a metabolic response or to provide primary iso-osmotic conditions across the membrane [143].

### 20.2.3.3.2 Accommodation

Christian [37] and Christian and Waltho [38] observed first that growth of *Salmonella oranienburg* at low water activity was stimulated by the addition of the amino acid proline. They observed a reversal of plasmolysis when exogenous proline was supplied to the bacteria growing at low water activity. Although uptake from the media may be one method of accumulating proline in response to water stress, most organisms appear to be able to synthesize proline. In fact, synthesis probably is the most common mechanism for accumulating proline in osmotically inhibited bacteria [144]. This is called compatible solute. A number of osmoregulatory solutes protect proteins against denaturation by heat [58]. Measures [99] and Gould and Measures [60] showed that  $K^+$  was required to maintain electrical neutrality or to balance the charges within cells exposed to environments with low water activity in which various amino acids, such as  $\alpha$ -ketoglutarate and glutamic acid, accumulate intracellularly. The principal reaction involves conversion of  $\alpha$ -ketoglutarate to glutamic acid by glutamate dehydrogenase, an enzyme activated by  $K^+$ . Glutamic acid reduces the intracellular water activity to reverse plasmolysis by reducing relative amounts of  $K^+$  and glutamate dehydrogenase. This leaves the cell at a balanced, osmotic null point by virtue of the increased glutamic acid pool. For some bacteria the process stops at this point, but for other organisms glutamic acid is converted to  $\gamma$ -aminobutyric acid or proline, neither of which is highly charged. Accumulation of high concentrations of glutamic acid would require concomitant acquisition of  $K^+$  to keep the system at neutrality. This excessive amount of  $K^+$  could be detrimental to the organism and at the very least, costly in terms of energy expenditure. Both  $\gamma$ -aminobutyric acid and proline are remarkably efficient at reducing intracellular water activity without interfering in the cell's metabolism and for this reason have been termed compatible solutes [17]. Compatible protoplasmic solutes in bacteria include glycylbetaine, proline, glutamic acid,  $\gamma$ -aminobutyric acid, and glycerol. Polyols of various types are compatible protoplasmic solutes in many fungi (Table 20.8). Exactly how these solutes avoid interference is not fully understood [143]. Gould [58] suggested that specific binding between solutes and intracellular enzymes is not the mechanism. Jones and Pollard [66] suggested that as these solutes may be excluded from the hydration sphere of proteins, the term benign solutes might more accurately describe the nonparticipatory nature of these materials.

### 20.2.3.3.3 Genetic Adaptation

The genetic components controlling osmoregulation in microorganisms are being investigated. *Escherichia coli* appears to have evolved a particularly advanced scheme for protection against osmotic stress through a proline-overproduced mutation, which confers osmotolerance. *Klebsiella pneumoniae* experiences an increase in intracellular-free proline when it is exposed to high levels of sodium chloride. Thus an enhanced level of osmoresistance in the organism results in its ability to fix nitrogen while under osmotic stress Troller [143].

### 20.2.3.3.4 Changing Cell Metabolism

An important role of the membrane may be to exclude  $Na^+$ , which if permitted to enter the cell can quickly inactivate a number of vital enzymatic systems.  $Na^+$  alters the types and amount of phospholipids within the membrane [143]. How a bacterial spore maintains such low cytoplasmic water content or water activity even when suspended in pure water is not yet understood [58].

TABLE 20.8

Compatible Protoplasmic Solutes in Fungi

Solute	Genus	Solute	Genus
Mannitol	<i>Geotrichum</i>	D-Galactosyl-(1,1)-glycerol	<i>Ochromonas</i>
	<i>Platymonas</i>	Glycerol	<i>Chlamydomonas</i>
	<i>Aspergillus</i>		<i>Aspergillus</i>
	<i>Dendryphiella</i>		<i>Dunaliella</i>
	<i>Penicillium</i>		<i>Saccharomyces</i>
Cyclohexanetetrol	<i>Monochrysis</i>		<i>Debaromyces</i>
Arabitol	<i>Dendryphiella</i>	Erythritol	<i>Aspergillus</i>
	<i>Saccharomyces</i>		<i>Penicillium</i>
Sorbitol	<i>Stichococcus</i>		

Source: Brown, A. D. and Simpson, J. R. 1972. *J. Gen. Microbiol.* 2: 589.

### 20.2.4 Fat Oxidation

Figure 20.7 shows a quality loss by oxidation below monolayer value. If a food is susceptible to oxidation of unsaturated fats, e.g., cereal grains, the rate increases as water activity decreases below the monolayer. Oxidation and rancidity are aggravated by drying of foods to very low moisture levels [127]. An oxygen attack is also responsible for pigment instability, loss of vitamins, and sometimes initiates nonenzymatic browning reactions [138]. The attachment of an oxygen molecule to a binding site of a protein would produce an incongruity in the aqueous covering sheath, which could distribute the hydration structure of neighboring sites [75]. Competition with oxygen is not the sole basis for explaining the protective effects of water. The bond energy of the adsorbed water would inhibit interactions between polar groups on adjacent carbohydrate or protein molecules and thereby preserve rehydration ability, reconstitution ability, and texture of foods [127]. Moreover, with respect to fat oxidation, the catalytic effect of metallic compounds is reduced when they form coordination spheres with polar groups [146]. Water is important in lipid oxidation because it acts as a solvent, mobilizes reactants, and interacts chemically or by hydrogen bonding with other species. The basic protective function that water exhibits when the moisture content increases the absolute dry state can be accounted for by two factors: (i) water interacts with metal catalysts, making them less effective through changes in their coordination sphere, and (ii) water hydrogen bonds with hydroperoxides, tying them up so that they are no longer available for decomposition through initiation reactions. When moisture content is higher than the value at the monolayer, the solvent and mobilization properties of water become more important and the catalysts present are more easily mobilized and possible swelling of solid matrix exposes new catalytic sites, making oxidation rates even higher [77,82]. Thus, foods having unsaturated fat should be kept at the critical water activity to maximize shelf life. The water activity at BET monolayer can be defined as *critical water activity*. Autoxidation of lipids occurs rapidly at low water activity levels, decreasing until a water activity range of 0.3–0.5 is reached [142]. At low water content especially in porous substrates in the complete absence of water, peroxidation of unsaturated lipids proceeds very rapidly. The addition of small quantities of water tends to produce a protective effect if the substrate is still free of oxidation products and reactive intermediates. However, reactions of oxidation products with proteins follow a more complex pattern [71]. In a model system consisting of methyl linoleate and lysozyme, the free radicals and other reactive species formed by the linoleate react with the protein, resulting in increased fluorescence, decreased enzyme activity, and decreased protein solubility. Water activity has an inhibitory effect on the initial oxidation of the lipid, but the secondary reactions of the lipid degradation products with the protein are accelerated by increasing water activity [68]. Schaich [129] showed that the free radical formed in proteins reacted with peroxide lipids and found that the amount and type of free radicals formed in the proteins were strongly affected by water activity. It appears that water facilitates recombination of free radicals and as a consequence the steady-state concentration of radicals, whereas various radical-initiated processes such as protein cross-linking increase at high water content. In case of freeze-dried model systems, certain amino acids, including histidine,  $\beta$ -amino-butyric acid, lysine, and cysteine, showed substantial antioxidant activity [72].

## 20.2.5 Nonenzymatic Activity

Browning reactions in foods affect nutritional value as well as color and texture [79]. The induction period, defined as the time to visually detectable browning, is inversely proportional to water activity [76,150]. Browning reactions are influenced by the types of reactant sugars and amines, pH, temperature, water activity, and the types of solutes or humectants used to adjust the water activity [142].

### 20.2.5.1 Types of Browning

There are three major pathways by which nonenzymatic browning can occur: high-temperature caramelization, ascorbic acid oxidation, and the Maillard reaction [79]. The browning reaction of sugars heated above their melting point in the absence of proteins or amino acids is called caramelization. This can be either beneficial or detrimental to the quality of a food product and can be prevented by avoiding high-temperature processing and low storage temperatures. It is enhanced in alkaline or acid conditions and is used to make commercial caramel colorings and flavors. Ascorbic acid (vitamin C) oxidation, a second type of browning reaction, is catalyzed by low pH and elevated temperatures. The decomposition products resulting from the oxidation of ascorbic acid cause a brown discoloration as well as decreased nutritional value. The Maillard reaction is a result of reducing compounds, primarily sugars, reacting with proteins or free amine groups. This changes both the chemical and the physiological properties of the protein. In general, the accumulation of brown pigments is the most obvious indication that Maillard browning has occurred in a food containing both carbohydrate and protein. It is used as an indicator of excessive thermal processing in the milk industry [79]. In the early stages of the Maillard reaction, the carbonyl group of the reducing sugar reacts with the free amino group of the amino acid to form a Schiff base and then the *N*-substituted glycosylamine as well as a molecule of water. Glycosylamines are converted to 1-amino-1-deoxy-2-ketose by Amadori rearrangement (cyclization and isomerization) [90]. The Maillard reactions forming Amadori compounds do not cause browning but do reduce the nutritive value [96]. The advanced Maillard reaction has five pathways. The first pathways start from the 1,2-enol or 2,3-enol forms of the Amadori product, yielding various flavor compounds. The third pathway is Strecker degradation, which involves oxidative degradation of amino acids by the dicarbonyls produced in the first two pathways. The fourth pathway involves transamination of the Schiff base. The fifth pathway starts with a second substitution of the amino-deoxyketose. The final step of the advanced Maillard reaction is the formation of many heterocyclic compounds, such as pyrazines and pyroles [90]. Brown melanoidin pigments are produced in the final stage of the Maillard reaction. The pigments are formed by polymerization of the reactive compounds produced during the advanced Maillard reaction, such as unsaturated carbonyl compounds and furfural. The polymers have a molecular weight greater than 1000 and are relatively inert [96]. These pathways depend upon environmental conditions such as temperature and pH.

### 20.2.5.2 Factors Affecting Browning

The browning reaction rate increases sharply from water activity at BET to a maximum, and then decreases (Figure 20.7). Water can retard the rate of the initial glycosylamine reaction of which it is a product. This results in product inhibition by some of the intermediate reactions. A second factor is the dilution of reactive components with increasing water content. The mobility of the reactive species increases due to a decrease in viscosity with increasing water activity. However, the first two factors eventually overcompensate for the decreased viscosity at higher water activity, and thus the overall rate of browning decreases [79]. Wolf et al. [153] demonstrated that losses of free lysine and methionine were highly dependent on water activity, protein, and sugar. Thermal degradation of both amino acids followed first-order kinetics, and rates decreased at 65°C and 115°C with increasing water activity. A more rapid decrease of lysine, tryptophan, and threonine at higher water activity is observed in model systems when heated to 95°C [87]. The retention of tryptophan was greater than lysine at water activity 0.75, but lysine retention was greater than that of tryptophan at water activity 0.22. At higher water activity, the Maillard reaction predominates and a rapid loss of lysine occurs. At lower water activity, browning proceeds at a slower rate and reactions involving the indole ring of tryptophan become significant [90]. Glucose utilization in a model system consisting of glucose, monosodium glutamate, corn starch, and lipids during nonenzymatic browning was investigated by Kamman and Labuza [67]. The rates of glucose utilization at water activity 0.81 were higher than at 0.41.

Lipid accelerated the reaction rates at 0.41 but had virtually no effect at 0.81 water activity. Liquid oil is more effective than shortening in increasing the degradation rate of glucose. These can be explained by the mobility of solutes in both water and oil [90]. Cerrutti et al. [24] studied browning in a model system consisting of lysine, glucose, sodium chloride, and phosphate buffer. They showed that water had little or no effect on the rate of glucose loss at water activity 0.90–0.95, but the rate was highly dependent on temperature and pH. Similar behavior was observed on accumulation of 5-hydroxymethylfurfural, fluorescent compounds, and brown pigments. Seow and Cheah [132] found that nonenzymatic browning decreased with an increase in water activity and temperature in a water-glycerol-sorbate-glycine model system at pH 4. In case of dehydrated orange juice ( $a_w = 0.44$ ) stored at 30°C and 50°C, the total amino acids lost due to nonenzymatic browning were 30% and 65% of initial concentration [21].

### 20.2.5.3 Maximum Browning Region

The region where the maximum browning occurs is usually near 0.65–0.80 water activity. In model freeze-dried foods, the maximum browning rate is in the range of 0.40–0.67 [39], in whey powders at 0.44 [79], and in dehydrated foods in the range of 0.65–0.75 [149]. Petriella et al. [107] found that water had relatively less effect on the browning rates at water activity of 0.90–0.95. At this range, pH and temperature were the determining factors. At very high water content, i.e., water activity greater than 0.95, moisture strongly inhibits the browning rate by diluting the reactive species [142]. Warmbier et al. [149] studied the influence of solutes on the maximal range of browning. For example, if glycerol is employed to reduce water activity, the range of maximal browning shifts from 0.65–0.75 to 0.40–0.50. They concluded that glycerol can influence the rate of browning at lower water activity values by acting as an aqueous solvent and thereby allowing reactant mobility at much lower moisture values than would be expected for water alone. The overall effect of glycerol or other liquid humectants on the maximum for nonenzymatic browning is to shift it to a lower water activity [79]. Obanu et al. [105], on the other hand, observing browning in glycerol–amino acid mixtures stored at 65°C, concluded that glycerol itself might participate in the browning reaction. Moreover, Troller [142] pointed that product quality relative to browning could be improved by reducing the water activity and, more importantly, the temperature during the final stage of drying. It is somewhat paradoxical that at water activity levels that minimize browning, autoxidation of lipids is maximized.

### 20.2.6 Enzymatic Activity

Enzyme-catalyzed reactions can proceed in foods with relatively low water contents. Karel [71] summarized two features of the results mentioned in the literature as follows: (i) The rate of hydrolysis increases with increasing water activity, with the reaction being extremely slow at very low activities. (ii) At each water activity, there appears to be a maximum extent of hydrolysis, which also increases with water content. The apparent cessation of the reaction at low moisture cannot be because of irreversible inactivation of the enzyme, but because upon humidification to a higher water activity, hydrolysis is resumed at a rate characteristic of the newly obtained water activity [71]. Silver [134] investigated a model system consisting of avicel, sucrose, and invertase and found that the reaction velocity increased with water activity. Complete conversion of the substrate was observed for water activities greater than or equal to 0.75. Below water activities of 0.75, the reaction continued to 100% hydrolysis. In solid media, water activity can affect reactions in two ways: lack of reactant mobility and alteration of active conformation of substrate and enzymatic protein [141]. Effects of varying the enzyme-to-substrate ratios on reaction velocity and the effect of water activity on the activation energy for the reaction could not be explained by a simple diffusion model, but required more complex postulates [71]: (i) The diffusion resistance is localized in a shell adjacent to the enzymes. (ii) At low water activities, the reduced hydration produces conformational changes in the enzyme affecting its catalytic activity. Tome et al. [141] tested the simple diffusion-related hypothesis on the basis of experiments in liquid systems in which water activity was reduced by the addition of glycerol, ethylene glycol, propylene glycol, diethylene glycol, sorbitol, methanol, or ethanol. In these solutions, the effects of polyphenoloxidase on tyrosine were very similar to those obtained in solid systems. The optimum pH of activity is shifted slightly toward alkaline values. Three characteristic curves were observed: (i) for low water activity, there was almost a total inhibition, (ii) in the intermediate range, reaction rate was very dependent on water activity, and (iii) for high water activity zones, activity was weakly affected by organic



TABLE 20.9

Minimum Water Activity Values for Enzymatic Reactions in Selected Food Systems

Product/Substrate	Enzyme	T (°C)	Water Activity Threshold
Grains	Phytases	23	0.90
Wheat germ	Glycoside hydrolases	20	0.20
Rye flour	Amylases	30	0.75
	Proteases	—	—
Macaroni	Phospholipases	25–30	0.45
Wheat flour dough	Proteases	35	0.96
Bread	Amylases	30	0.36
	Proteases	—	—
Casein	Trypsin	30	0.50
Starch	Amylases	37	0.40/0.75
Galactose	Galactosidase	30	0.40–0.60
Olive oil	Lipase	5–40	0.25
Triolein, triaurin	Phospholipases	30	0.45
Glucose	Glucose oxidase	30	0.40
Lenoleic acid	Lipoxygenase	25	0.50/0.70

Source: Drapron, R. 1985. In: *Properties of Water in Foods*. (Simato, D. and Multon, J. L., eds.) Martinus Nijhoff Publishers, Dordrecht.

additives. In general, the rate increased rapidly with increasing water activity, and the reaction stopped at a certain level before all reactants were consumed; the higher the water content, the higher the plateau. The authors were unable to find a correlation of enzyme activity with viscosity, solubility of oxygen and tyrosine, or dielectric constant. It also appeared that the more the mixture deviated from ideality, the more the enzymatic activity was inhibited, regardless of whether the deviation was positive or negative. Thus, solvent–water interaction is the main parameter in polyphenoloxidase inhibition. The minimum water activities for enzymatic reactions in selected food systems are given in Table 20.9.

### 20.2.7 Vitamin Loss

The nutrition loss of dehydrated foods depends on the storage temperature, light, oxygen, and water activity. The loss of thiamine due to heating is affected by (i) the state of thiamin molecule (incorporated into the enzyme or protein bound), (ii) pH (the rate of destruction increases especially in the alkaline region), (iii) metals (free metals act as catalysts to increase the rate of thiamine destruction), and (iv) oxygen (oxygen can accelerate thiamine destruction especially in solutions above 70°C) [48]. The thiamine destruction during heat treatment strongly depended on pH and insignificant influence of water activity within 0.9–1.0 values [54]. Products with a pH value of 3 show excellent thiamine retention, while those with a pH value approaching 7 showed a strong instability during the thermal process. The destruction of thiamine in the model system was less than 5% at storage temperatures  $\leq 37^\circ\text{C}$  and was independent of water activity at  $a_w \leq 0.65$ . A significant increase in the thiamine loss occurred in the model system stored at 45°C when the water activity was at or above 0.24. Riboflavin is considered more heat stable than thiamine but highly sensitive to degradation by light. The stability of riboflavin in dry products is considered to be excellent in the absence of light [74]. With only one expectation, the reaction rates of vitamins A, B1, B2, and C increased with increasing water activity 0.24–0.65 [90]. The B vitamins are more stable than vitamins A and C at various water activity values [90].

### 20.2.8 Texture

Rockland [119] defined food texture as a function of localized moisture sorption isotherms as follows: (i) region I (low water activity)—dry, hard, crisp, and shrunken, (ii) region II (intermediate water activity)—dry, firm, and flexible, (iii) region III (high water activity)—moist, juicy, soft, flaccid, swollen,

**TABLE 20.10**

Critical Values for Ingredients in Model Food Products

Moistness	Crispness	Chewiness	Toughness
Cereal		<0.40	>0.50
Fruit	>0.30	<0.50	<0.30
Nuts		<0.65	

Source: Bourne, M. C. 1987. In: *Water Activity: Theory and Applications to Food*. Rockland, L. B. and Beuchat, L. R. eds. Marcel Dekker, New York. pp. 75–99.

stickiness. Table 20.10 shows textural characteristics of model food products as water activity. The effect of water activity on textural measurements for different types of foods is reviewed by Bourne [14]. Presently, there are insufficient data to predict what the textural properties of a given type of food will be at a given water activity, and no sound theories exist to predict in advance the textural properties of a food at a given water activity. Cenkowski et al. [22] studied the mechanical behavior of canola kernels by bringing them to equilibrium, adsorption or desorption, at the same final moisture. The ratio of elasticity was 18%–38% higher for kernels brought to equilibrium through adsorption than those through desorption for a moisture range of 9.5%–7.5% (dry basis). At higher moisture contents, the differences in modules of elasticity were not significant. In case of dry snacks, the loss of crispness occurred close to BET monolayer [77]. In case of potato chips [108] and corn chips [15], the *critical water activity* when the product was unacceptable was found to be 0.40 water activity. The change in sensory crispness of potato chips, popcorn, puffed corn curls, and saltines generally fell in the 0.35–0.50 water activity range [73]. Instron analysis showed that the force–deformation curve changed distinctly near critical  $a_w$  for saltines and puffed corn curls, while the curve changed more gradually with increasing  $a_w$  for popcorn.

## 20.3 Water Activity Concepts and Other Alternatives

### 20.3.1 Limitations Identified

Two major drawbacks of the water activity concepts are identified in the literature. These are: validity of equilibrium conditions, discontinuity or break in the isotherm, and effects of different solutes.

#### 20.3.1.1 Validity of Equilibrium Conditions

Water activity is defined at equilibrium, whereas foods with low and intermediate water content may not be in a state of equilibrium. Instead they may be in an amorphous multistate, which is very sensitive to changes in moisture content and time. In low- and intermediate-moisture foods, the concept of water activity may be meaningless because the measured vapor pressure of water is no longer the equilibrium vapor pressure as defined in the literature. A stationary state may be reached under a given set of environmental conditions and mistaken for equilibrium. In moisture-sorption studies, the situation is further complicated if the amorphous material undergoes a glass–rubber transition during the course of the measurement. Chirife and Buera [33] believe that an analysis of various literature data may throw some light on these aspects. An important comprehensive collaborative study within the framework of European Corporation in the Field of Scientific and Technical Research (COST) was conducted to determine the precision of data (e.g., repeatability or reproducibility) in the determination of sorption isotherms. In the water activity range of interest to microbial growth (0.6–0.9), the average standard deviation of all data from 24 laboratories was  $\pm 2.6\%$  for equilibrium moisture content of microcrystalline cellulose (MCC) and  $\pm 3.8\%$  for potato starch, respectively. The repeatability was 2% for both MCC and potato starch. Chirife and Buera [33] also reported data on isotherms from different sources of the same material and found good reproducibility within a wide range of water activities. Lomauro et al. [92] concluded from a study of a large number of foods that a pseudoequilibrium was reached when the moisture content (dry basis) did not change by more than  $\pm 0.5\%$  during three consecutive sample periods at an interval of no more than 7 days. This criterion for equilibrium moisture content was compared with the values obtained after 6 months of storage in closed

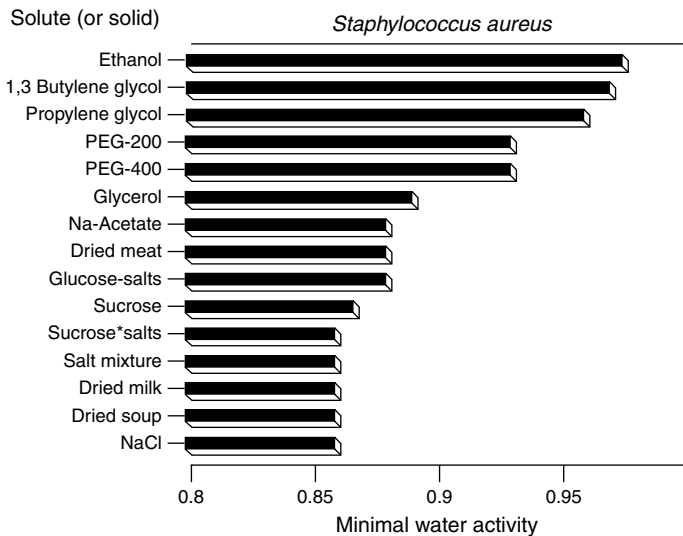
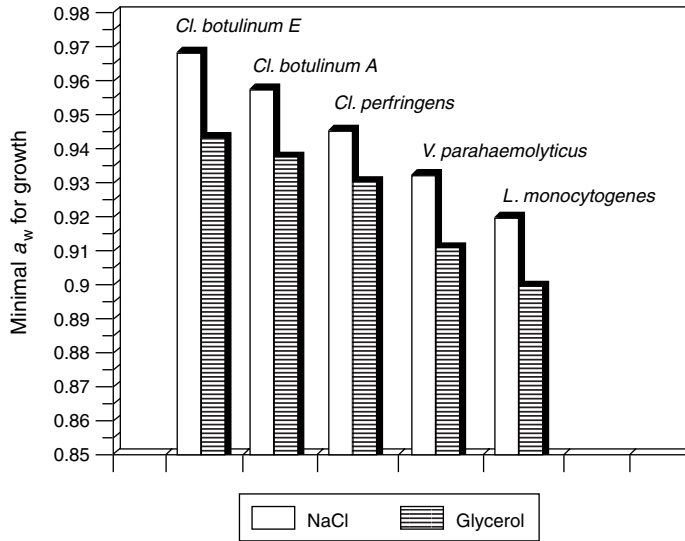
mason jars, which were considered to be very close to the equilibrium moisture content. Lomauro et al. [92] concluded that the foods tested reached (or were very close to) equilibrium within 1 month, based on the above criterion. Various authors reported their equilibrium times for isotherm determinations of different food systems using the gravimetric static method over saturated salt solutions, and their equilibrium times ranged mostly between 1 and 4 weeks, depending on the temperature and relative humidity. Bizot et al. [10] utilized a practical equilibrium time of about 7 days ( $\pm 0.02\%$  water per 24 h) for a 1 g sample, but they also stored their starch samples over saturated salt solutions for 2 years. They noted a slow drift in desorption pseudoequilibrium, but there was only a 1% difference in water content (dry basis) over this long time. Thus, water activities measured are likely to be close to equilibrium, and the differences should be within the uncertainties associated with the experimental determination of isotherm [33].

### 20.3.1.2 Break in the Isotherm

Chirife and Buera [33] reviewed sorption isotherms of fruits containing crystallizable sugars that constitute a nonequilibrium system. For example, in raisins the discontinuities in the isotherm are not noticed at water activity of 0.30–0.90, suggesting that sugars remained amorphous even at very large  $T-T_g$ . Sorption isotherm of other fruits reported in the literature does not show discontinuities [33,125]. Bolin [13] observed little effect on isotherm when raisins were sealed in glass jars held at 21°C or 32°C up to 12 months. This suggested that nonequilibrium effects are very slow, at least in their experiments. Chirife and Buera [33] also presented data on fruits, but they overlooked the crystallization of sugars in dairy products and formulated products having sugars or salts, as discussed in Chuy and Labuza [40] and Saltmarch and Labuza [126]. Recently developed dynamic sorption apparatus could measure the water activity within a couple of hours with a sample size in the range of  $\mu\text{g}$ . Although the break in isotherm poses a problem in the measurement, it provides a practical importance as far as detecting any change in structural components when stored on a specific water activity environment is concerned.

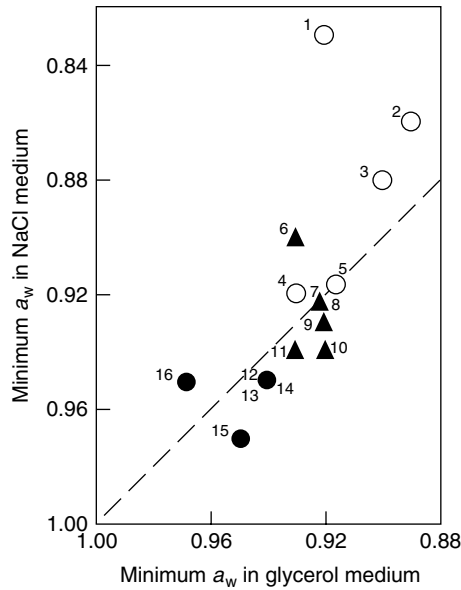
### 20.3.1.3 Effect of Solute Types

The microbial response may differ at a particular water activity when the latter is obtained with different solutes [32,33]. Thus, the proposed basis of water activity limit for growth may not be universal. Corry [43] reported that the survival of vegetative bacteria is influenced by nutrients in the food matrix. These influences show no consistent inhibitory pattern and are greatly affected by the matrix. Mugnier and Jung [101] studied the survival of bacteria and fungi in biopolymer gels with and without nutritive solutes. They observed that survival is increased at the point of mobilization of solute in the case of mannitol. While comparing a Gram-positive bacterium and a Gram-negative one, they concluded that low molecular weight compounds ( $C_3$ – $C_5$ ) had a deleterious effect on survival compared to higher molecular weight compounds ( $C_6$ – $C_{12}$ ), which had a protective effect. The glass–rubber state of solutes may also play an important role, since higher molecular weight solutes have higher glass transition temperatures than low molecular weight solutes. The degree of protective effect was in the order of mannitol > dextrin > ribose > glycerol. Above a certain amount of hydration (the mobilization point), there exists a second fraction of solute in the polymer system, which can serve as a true solvent for the microbial nutrient to maintain the organism's metabolic activity [89]. Brown [16] stated that freeze drying of microorganisms with a nonelectrolyte such as glycerol or sugar reduces mortality during dehydration, storage, and rehydration. This indicates that the nonelectrolyte functions directly as a solvent molecule for nutrients. Gould [58] acknowledged that in some instances solute effects might depend on the ability of the solute to permeate the cell membrane. Glycerol, for example, readily permeates the membrane of many bacteria and so does not initiate the same osmoregulatory response as nonpermeable solutes like sodium chloride and sucrose; therefore a different, usually lower, inhibitory water activity. Scott [131] noted that minimal water activity for the growth of microorganisms was independent of the solutes employed to adjust the water activity of a medium. It was observed later that some solutes were more inhibiting than others, thus water activity of a medium is not the only determining factor regulating microbial response. The nature of the solute used also plays an important role [36,59]. This is referred to as *specific solute effects* by Chirife [31]. Selected examples are discussed as follows. Figures 20.9 and 20.10 compare the minimal water activity supporting growth of various pathogenic bacteria when sodium chloride or glycerol is used to control the water activity. In all cases, glycerol is less



**FIGURE 20.9** Effect of minimum water activity levels on growth of bacteria in different solutes. (From Chirife, J. and Buera, M. D. P. 1996. *Crit. Rev. Food Sci. Nutri.* 36(5): 465–513.)

inhibitory than sodium chloride. Glycerol readily permeates the membrane of bacteria and does not initiate the same osmoregulatory response as the nonpermeate solute sodium chloride [31]. It is conclusive that the water activity limit varies with the type of solute used and the microorganisms in the medium. Thus, it is important to identify the range of variations and the possible causes of variations. Table 20.5 shows the effects of solute types on *Staphylococcus aureus*. The range of water activities varies from 0.860 to 0.966. Propylene glycol is more effective in *S. aureus*, which is explained by Chirife [31]. The points in Figure 20.10 are distributed on both sides of the line, indicating a high correlation of water activity with growth and fluctuation due to other factors in the microorganisms. The effect of solute type on different microorganisms should be clearly identified to recognize generalized trends or at least the limitation of validity. Electron micrographs of *S. aureus* after growing in a medium containing different solutes were analyzed [31]. Microbial cells subjected to sodium chloride and sucrose ( $a_w = 0.85$ ) did not show any important morphological changes in the cells; thus, the inhibitory effects of sucrose and sodium chloride against cells were



**FIGURE 20.10** Relationship between the minimum water activity levels for growth of 16 species of bacteria in NaCl and in glycerol-adjusted medium. (From Christian, J. H. B. 1981. In: *Water Activity: Influences on Food Quality*. Rockland, L. B. and Stewart, G. F. eds. Academic Press, New York. pp. 825–854.)

primarily related to their ability to lower water activity, specific solute effects were not significant. Solutions of propylene glycol ( $a_w = 0.92$ ), 1,4-butylene glycol ( $a_w = 0.85$ ), and polyethylene glycol 400 and 1000 ( $a_w = 0.85$ ) showed that these solutes caused dramatic morphological modifications in the cells. These antibacterial effects may be attributed mainly to the effects of these molecules on the membrane enzymes responsible for peptidoglycan synthesis. Anand and Brown [2] observed that polyethylene glycol was more inhibitory to yeast growth than were glucose and sucrose at a similar water activity. Marshall et al. [95] evaluated the inhibitory effects of sodium chloride and glycerol at the same water activity on 16 species of bacteria. They found that glycerol was more inhibitory than sodium chloride to relatively salt-tolerant bacteria and less inhibitory than sodium chloride to salt-sensitive species. Lenovich et al. [89] showed that the type of solute influences resistance to sorbate in *Saccharomyces rouxii*, thus indicating an interactive effect of solute type and preservative. Buchanan and Bagi [20] studied the effects of solutes (mannitol, sorbitol, and sucrose) in combination with four pH levels and three incubation temperatures on the growth of *Escherichia coli*. In addition to water activity, the growth kinetics was influenced by temperature and pH, and inhibition order followed as sorbitol > mannitol > sucrose. In addition at higher water activity levels, particularly when temperature and pH were nonlimiting, the differences between the humectants were minimal. However, as the environment was made more inhospitable, differences due to humectants were observed. Effects of solutes were insensitive to the *Lactobacillus casei* when sodium chloride or sorbitol was used to control the water activity [3]. The time of germination of spores appeared to vary depending on the water activity and solute type during spore production [11]. Resistance or susceptibility of microorganisms to antibiotics depends on the water activity and types of solutes. For example, resistance of *Streptococcus thermophilus* increased when water activity was lowered with glycerol, while susceptibility increased when water activity was adjusted with glucose and acid production was higher when sucrose was used. Susceptibility to gentamycin increased in both species (*Streptococcus thermophilus* and *Lactobacillus bulgaricus*) with reduced water activity [86]. Although there are differences in microbial stability when different solutes are used to achieve the same water activity, it does not mean that the concept of water activity is invalid [104]. It has been shown repeatedly in the literature that each microorganism has a critical water activity below which growth cannot occur. For example, pathogenic bacteria cannot grow below a water activity of 0.85–0.86; yeasts and molds are more tolerant of reduced water activity, but usually no growth exists below a water activity of about 0.6 (Table 20.7).

### 20.3.2 Glass Transition Concept

Recently, Rahman [110] reviewed the applications of glass transition concept in food product stability during storage. Slade and Levine [136] and Franks [55] proposed that water activity could serve as a useful, but not the sole indicator of microbial safety. Slade and Levine's [136] hypothesis stated that water dynamics or glass-rubber transition might be used instead of water activity to predict microbial stability. Slade and Levine [135] reported that for matched pairs of fructose and glucose at equal solute concentrations, fructose produced a much less stable system in which mold spores germinated much faster, i.e., the solute with lower ratio of melting temperature to glass transition temperature ( $\alpha = T_m/T_g$ ) allowed faster germination. Thus, the following order of antimicrobial stabilization was predicted by Slade and Levine [136]: glycerol ( $\alpha = 1.62$ ) > glucose ( $\alpha = 1.42$ ) > mannose ( $\alpha = 1.36$ ) > fructose ( $\alpha = 1.06$ ) and sucrose ( $\alpha = 1.43$ ) > maltose ( $\alpha = 1.27$ ). The germination of *Aspergillus flavus*, *Aspergillus niger*, and *Eurotium herbariorum* did not follow the above sequence [35]. For example, germination times for all three molds in fructose or glucose were always greater than in glycerol. In all cases, germination time increased when the water activity decreased; the relative effect, however, depended both on the solute type and the mold. None of the molds studied germinated in solution of propylene glycol (at  $a_w = 0.85$  or  $0.90$ ;  $\alpha = 1.27$ ) after 70 days of incubation at 28°C [35]. This is simply because the behavior of propylene glycol cannot be explained on the basis of mobility or water activity effects alone, since this molecule possesses specific antimicrobial effects already recognized in the literature [35]. However, further studies from the microbiology groups could clarify the above-published results. Chirife and Buera [33] also showed evidence that above glass transition, microbial growth is inhibited in prunes and that below glass transition, microbial growth is possible in wheat flour. Overall both the water activity and glass transition concepts are not valid in all systems and conditions. Recent trends are to apply multiple concepts, such as water activity, glass transition, and pH, together to determine the chemical, physical, and microbial changes in foods. However, we are far from developing a more unified approach, including water activity, pH, glass transition, and preservatives. More discussions on glass transition concept and other factors are provided in the chapter on glass transition.

---

## References

1. Alzamora, S. M., Chirife, J. and Fontan, C. F. 1981. Effect of surface active agents on water activity of IM food solutions. *J. Food Sci.* 46: 1974–1975.
2. Anand, J. C. and Brown, A. D. 1968. Growth rate patterns of the so-called osmophilic and nonosmophilic yeasts in solutions of polyethylene glycol. *J. Gen. Microbiol.* 52: 205.
3. Beker, M. E., Vigant, A. K., Marauska, M. K. and Klintsare, A. A. 1998. Osmotic sensitivity of the bacterium *Lactobacillus casei* var. *alactosus*. *Appl. Biochem. Microbiol.* 34(2): 146–148.
4. Benado, A. L. and Rizvi, S. S. H. 1985. Thermodynamics properties of water on rice as calculated from reversible and irreversible isotherms. *J. Food Sci.* 45: 1190.
5. Benson, S. W. and Richardson, R. L. 1955. A study of hysteresis in the sorption of polar gases by native and denatured proteins. *J. Am. Chem. Soc.* 77: 2585–2590.
6. Berlin, E., Anderson, B. A. and Pallansch, M. J. 1968. Water vapor sorption properties of various dried milks and whey. *J. Dairy Sci.* 51: 1339.
7. Bettelheim, F. A. and Ehrlich, S. H. 1963. Water vapor sorption of mucopolysaccharides. *J. Phys. Chem.* 67: 1948.
8. Beuchat, L. R. 1981. Microbial stability as affected by water activity. *Cereal Foods World* 26: 345–349.
9. Beuchat, L. R. 1987. In: *Water Activity: Theory and Applications to Food*. Rockland, L. B. and Beuchat, L. R. eds. Marcel Dekker, New York. p. 137–151.
10. Bizot, H., Buleon, A., Mouhous-Riou, N. and Multon, J. L. 1985. Some factors concerning water vapor sorption hysteresis in potato starch. In: *Properties of Water in Foods in Relation to Quality and Stability*. Simatos, D. and Multon, J. L. eds. Martinus Nijhoff, Dordrecht. p. 83.
11. Blaszyk, M., Blank, G., Holley, R. and Chong, J. 1998. Reduced water activity during sporogenesis in selected penicillia: impact on spore quality. *Food Res. Int.* 31(6–7): 503–509.
12. Boki, K. and Ohno, S. 1991. Moisture sorption hysteresis in kudzu starch and sweet potato starch. *J. Food Sci.* 56(1): 125–127.

13. Bolin, H. R. 1980. Relation of moisture to water activity in prunes and raisins. *J. Food Sci.* 45: 1190–1192.
14. Bourne, M. C. 1987. Effects of water activity on textural properties of food. In: *Water Activity: Theory and Applications to Food*. Rockland, L. B. and Beuchat, L. R. eds. Marcel Dekker, New York. pp. 75–99.
15. Brickman, C. L. 1957. Evaluating the packaging requirements of a product. *Package Eng.* 2(7): 19.
16. Brown, A. D. 1976. Microbial water stress. *Bacteriol. Rev.* 40(4): 803–846.
17. Brown, A. D. and Simpson, J. R. 1972. The water relations of sugar-tolerant yeasts: the role of intracellular polyols. *J. Gen. Microbiol.* 2: 589.
18. Brown, L. M. 1982. *Psychology* 21: 408.
19. Brunauer, S., Deming, L. S., Deming, W. E. and Teller, E. 1940. On a theory of the van der Waals adsorption of gases, *Am. Chem. Soc. J.* 62: 1723.
20. Buchanan, R. L. and Bagi, L. K. 1997. Effect of water activity and humectant identify on the growth kinetics of *Escherichia coli* O157:H7. *Food Microbiol.* 14: 413–423.
21. Castillo, M. D. D., Corzo, N., Polo, M. C., Pueyo, E. and Olano, A. 1998. Changes in the amino acid composition of dehydrated orange juice during accelerated non-enzymatic browning. *J. Agric. Food Chem.* 46: 277–280.
22. Cenkowski, S., Zhang, Q. and Crerar, W. J. 1995. Effect of sorption hysteresis on mechanical behavior of canola. *Trans. ASAE* 38(5): 1455–1460.
23. Cerofolini, G. F. and Cerorolini, M. 1980. Heterogeneity, allostericity, and hysteresis in adsorption of water by proteins. *J. Colloid Interface Sci.* 78: 65–73.
24. Cerrutti, P., Resnik, S. L., Seldes, A. and Ferro-Fontan, C. 1985. Kinetics of deteriorative reactions in model food systems of high water activity: glucose loss, 5-hydroxymethyl furfural accumulation and fluorescence development due to nonenzymatic browning. *J. Food Sci.* 50: 627.
25. Chen, C. C. and Karmas, E. 1979. Effect of surface active agents on water activity in intermediate moisture foods. *Food Sci. Technol.* 12: 68–71.
26. Chinachoti, P. and Steinberg, M. P. 1984. Interaction of sucrose with starch during dehydration as shown by water sorption. *J. Food Sci.* 49: 1604–1608.
27. Chinachoti, P. and Steinberg, M. P. 1985. Interaction of sodium chloride with raw starch in freeze-dried mixtures as shown by water sorption. *J. Food Sci.* 50: 825–839.
28. Chinachoti, P. and Steinberg, M. P. 1986. Moisture hysteresis due to amorphous sugar. *J. Food Sci.* 51: 153.
29. Chinachoti, P. and Steinberg, M. P. 1988. Interaction of sucrose with gelatin, egg albumin and gluten in freeze-dried mixtures as shown by water sorption. *J. Food Sci.* 53(3): 932–939.
30. Chirife, J. 1993. Physicochemical aspects of food preservation by combined factors. *Food Control* 4: 210.
31. Chirife, J. 1994. Specific solute effects with special reference to *Staphylococcus aureus*. *J. Food Eng.* 22: 409–419.
32. Chirife, J. and Buera, M. D. P. 1994. Water activity, glass transition and microbial stability in concentrated/semimoiest food systems. *J. Food Sci.* 59(5): 921–927.
33. Chirife, J. and Buera, M. D. P. 1996. Water activity, water glass dynamics, and the control of microbiological growth in foods. *Crit. Rev. Food Sci. Nutri.* 36(5): 465–513.
34. Chirife, J. and Fontan, C. F. 1982. Water activity of fresh foods. *J. Food Sci.* 47: 661–663.
35. Chirife, J., Gonzalez, H. H. L. and Resnik, S. L. 1996. On water dynamics and germination time of mold spores in concentration sugar and polyol solutions. *Food Res. Int.* 28(6): 531–535.
36. Christian, J. H. B. 1981. Specific solute effects on microbial water relations. In: *Water Activity: Influences on Food Quality*. Rockland, L. B. and Stewart, G. F. eds. Academic Press, New York. pp. 825–854.
37. Christian, J. H. B. 1955. The water relations of growth and respiration of *Salmonella oranienburg* at 30°C. *Aust. J. Biol. Sci.* 8: 490.
38. Christian, J. H. B. and Waltho, J. A. 1964. The sodium and potassium content of nonhalophilic bacteria in relation to salt tolerance. *J. Gen. Microbiol.* 25: 97.
39. Chung, C. Y. and Toyomizu, M. 1976. Studies on the browning of dehydrated foods as a function of water activity. I. Effect of  $a_w$  on browning in amino acid-lipid systems. *Bull. Jap. Soc. Fisheries* 42: 697–702.
40. Chuy, L. and Labuza, T. P. 1994. Caking and stickiness of dairy based food powders related to glass transition. *J. Food Sci.* 59: 43.
41. Cohan, L. 1944. Hysteresis and the capillary theory of adsorption of vapors. *J. Am. Chem. Soc.* 66: 98.
42. Cohen, E. and Saguy, I. 1983. Effect of water activity and moisture content on the stability of beet powder pigments. *J. Food Sci.* 48: 703–707.
43. Corry, J. E. L. 1973. The water relations and heat resistance of microorganisms. *Prog. Ind. Microbiol.* 12: 73.

44. Desobry, S. and Hardy, J. 1993. Modelling of the total water desorption rate from packaging moist food. *Int. J. Food Sci. Technol.* 28: 347–359.
45. Drapron, R. 1985. Enzyme activity as a function of water activity. In: *Properties of Water in Foods*. Simato, D. and Multon, J. L. eds. Martinus Nijhoff Publishers, Dordrecht.
46. Dyer, D. F., Carpenter, D. K. and Sunderland, J. E. 1996. Equilibrium vapor pressure of frozen bovine muscle. *J. Food Sci.* 34: 196.
47. Epstein, W. and Lamins, L. 1980. Potassium transport in *Escherichia coli*: diverse systems with common control by osmotic forces. *Curr. Trends Biochem.* 5: 21.
48. Farrer, K. T. H. 1955. The thermal destruction of vitamin B1 in foods. *Ad. Food Res.* 6: 257–311.
49. Fennema, O. 1981. Water activity at subfreezing temperatures. In: *Water Activity: Influences on Food Quality*. Rockland, L. B. and Stewart, G. F. eds. Academic Press, Inc., New York. pp. 713–732.
50. Fennema, O. R. 1985. Water and ice. In: *Food Chemistry*, 2nd ed., Fennema, O. R. ed. Marcel Dekker, Inc., New York. pp. 23–67.
51. Fontan, C. F. and Chirife, J. 1981. The evaluation of water activity in aqueous solutions from freezing point depression. *J. Food Technol.* 16: 21–30.
52. Fontana, A. J. 2001. Dew-point method for the determination of water activity. In: *Current Protocols in Food Analytical Chemistry (CPFA)*. Wiley, New York. pp. A2.2.1–A.2.2.10.
53. Fortes, M. and Okos, M. R. 1980. Drying theories: their bases and limitation as applied to foods and grains. In: *Advances in Drying, Vol. 1*, Majumdar, A. S. ed. Hemisphere, Washington DC. pp. 119–154.
54. Fox, M., Loncin, M. and Weiss, M. 1982. Investigations into the influence of water activity, pH and heat treatment on the breakdown of thiamine in foods. *J. Food Qual.* 5: 161–182.
55. Franks, F. 1991. Water activity: a credible measure of food safety and quality. *Trends Food Sci. Technol.* 1: 68.
56. Gal, S. 1983. The need for and practical applications of sorption data. In: *Physical Properties of Foods*. Peleg, M. and Bagley E. B. eds. AVI Publishing Co., Westport, CT.
57. Gal, S. and Bankay, D. 1971. Hydration of sodium chloride bound by casein at medium water activities. *J. Food Sci.* 36: 800–803.
58. Gould, G. W. 1985. Osmoregulation: is the cell just a simple osmometer? The microbiological experience. In: *A Discussion Conference: Water Activity: A Credible Measure of Technological Performance and Physiological Viability?* Faraday Division, Royal Society of Chemistry, Girton College, Cambridge, UK. July 1–3.
59. Gould, G. W. 1988. Interference with homeostasis-food. In: *Homeostatic Mechanisms in Microorganisms*. Banks, J. G., Board, R. G., Gould, G. W. and Mittenbury, R. W. eds. Bath University Press, Bath, UK.
60. Gould, G. W. and Measures, J. C. 1977. Water relations in single cells. *Phil. Trans. R. Soc. Lond. B.* 278: 151.
61. Harold, F. M. 1982. Pumps and currents: a biological perspective. *Curr. Top. Membrane Transp.* 16: 485.
62. Helmer, G. L., Laimins, L. A. and Epstein, W. 1982. Mechanisms of potassium transport in bacteria. In: *Membranes and Transport*. Vol. 2. Martonosi, A. N. ed. Plenum Press, New York.
63. Hill, J. E. and Sunderland, J. E. 1967. Equilibrium vapor pressure and latent heat of sublimation for frozen meats. *Food Technol.* 21: 112–114.
64. Iglesias, H. A. and Chirife, J. 1976. On the local isotherm concept and modes of moisture binding in food products. *J. Agric. Food Chem.* 24(1): 77–79.
65. Isse, M. G., Schuchmann, H. and Schubert, H. 1993. Divided sorption isotherm concept: an alternative way to describe sorption isotherm data. *J. Food Eng.* 16: 147–157.
66. Jones, R. G. W. and Pollard, A. 1985. Towards a physical chemical characterization of compatible solutes. In: *Biophysics of Water*. Franks, F. and Mathias, S. F. eds. Wiley, Chichester.
67. Kamman, J. F. and Labuza, T. P. 1985. A comparison of the effect of oil versus plasticized vegetable shortening on rates of glucose utilization in nonenzymatic browning. *J. Food Proc. Pres.* 9: 217.
68. Kanner, J. and Karel, M. 1976. Changes in lysozyme due to reactions with peroxidizing methyl linoleate in a dehydrated model system. *J. Agric. Food Chem.* 24: 468.
69. Kapsalis, J. G. 1981. Moisture sorption hysteresis. In: *Water Activity: Influences on Food Quality*. Rockland, L. B. and Stewart, G. F. eds. Academic Press, New York. pp. 143–177.
70. Kapsalis, J. G. 1987. In: *Water Activity: Theory and Applications to Food*. Rockland, L. B. and Beuchat, L. R. eds. Marcel Dekker, New York. pp. 173–213.
71. Karel, M. 1979. The significance of moisture to food quality. In: *Developments in Food Science 2*. Chiba, H., Fujimaki, M., Iwai, K., Mitsuda, H. and Morita, Y. eds. Kodansha Ltd., Tokyo, pp. 378–383.



72. Karel, M., Tannenbaum, S. R., Wallace, D. H. and Maloney, H. 1966. Autoxidation of methyl linoleate in freeze-dried model systems. III. Effects of added amino acids. *J. Food Sci.* 31: 892–896.
73. Katz, E. E. and Labuza, T. P. 1981. Effect of water activity on the sensory crispness and mechanical deformation of snack food products. *J. Food Sci.* 46: 403–409.
74. Kirk, J. R. 1981. Influence of water activity on stability of vitamins in dehydrated foods. In: *Water Activity: Influences on Food Quality*. Rockland, L. B. and Stewart, G. F. eds. Academic Press, New York. pp. 531–566.
75. Klotz, I. M. and Heiney, R. E. 1957. Changes in protein topography upon oxygenation. *Proc. Natl. Acad. Sci. USA* 43: 717.
76. Kopelman, I. J., Meydau, S. and Weinberg, S. 1977. *J. Food Sci.* 42: 403.
77. Labuza, T. P. 1968. Sorption phenomena in foods. *Food Technol.* 22: 263–272.
78. Labuza, T. P. 1984. *Moisture Sorptions: Practical Aspects of Isotherm Measurement and Use*. Am Assoc. Cereal Chemists, St. Paul, MN.
79. Labuza, T. P. and Saltmarch, M. 1981. Kinetics of browning and protein quality loss in whey powders under steady state and nonsteady state storage conditions. *J. Food Sci.* 47: 92–96,113.
80. Labuza, T. P., Acott, K., Tatini, S. R., Lee, R. Y., Flink, J. and McCall, W. 1976. Water activity determination: a collaborative study of different methods. *J. Food Sci.* 41: 910–917.
81. Labuza, T. P., Kaanane, A. and Chen, J. Y. 1985. Effect of temperature on the moisture sorption isotherms and water activity shift of two dehydrated foods. *J. Food Sci.* 50: 385–391.
82. Labuza, T. P., Maloney, J. F. and Karel, M. 1966. Autoxidation of methyl linoleate in freeze-dried model systems. II. Effect of water on cobalt-catalyzed oxidation. *J. Food Sci.* 31: 885–891.
83. Labuza, T. P. and Rutman, M. 1967. The effect of surface active agents on sorption isotherms of model systems. Presented at *Ann. Can. Chem. Eng. Conference*, October. 18.
84. Labuza, T. P., Tannenbaum, S. R. and Karel, M. 1970. Water content and stability of low moisture and intermediate moisture foods. *Food Technol.* 24: 543.
85. Lang, F. and Waldegger, S. 1997. Regulating cell volume. *Am. Sci.* 85: 456–463.
86. Larsen, R. F. and Anon, M. C. 1989. Interaction of antibiotics and water activity on *Streptococcus thermophilus* and *Lactobacillus bulgaricus*. *J. Food Sci.* 54(4): 922–939.
87. Leahy, M. M. and Warthesen, J. J. 1983. The influence of a Millard browning and other factors on the stability of free tryptophane. *J. Food Proc. Pres.* 1: 25.
88. Leistner, L. and Rodel, W. 1979. Microbiology of intermediate moisture foods. In: *Proceedings of the International Meeting on Food Microbiology and Technology*. Jarvis, B., Christian, J. H. B. and Michener, H. D. eds. Medicina Viva Servizio Congress, Parma, Italy.
89. Lenovich, L. M. 1987. In: *Water Activity: Theory and Applications to Food*. Rockland, L. B. and Beuchat, L. R. eds. Marcel Dekker, New York. pp. 119–136.
90. Leung, H. K. 1987. Influence of water activity on chemical reactivity. In: *Water Activity: Theory and Applications to Food*. Rockland, L. B. and Beuchat, L. R. eds. Marcel Dekker, New York. pp. 27–54.
91. Lomauro, C. J., Bakshi, A. S. and Labuza, T. P. 1985. Evaluation of food moisture sorption isotherm equations. Part II: Milk, coffee, tea, nuts, oilseeds, spices and starchy foods. *Food Sci. Technol.* 18: 118–124.
92. Lomauro, C. J., Bakshi, A. S. and Labuza, T. P. 1985. Moisture transfer properties of dry and semimoist foods. *J. Food Sci.* 50: 397.
93. Mackenzie, A. P. 1995. The physico-chemical environment during freezing and thawing of biological materials. In: *Water Relations of Foods*. Duckworth, R. B. ed. Academic Press, New York.
94. Makower, B. and Dye, W. B. 1956. Equilibrium moisture content and crystallization of amorphous sucrose and glucose. *J. Agric. Food Chem.* 4(1): 72–77.
95. Marshall, B. J., Ohye, D. F. and Christian, J. H. B. 1971. Tolerance of bacteria to high concentrations of NaCl and glycerol in the growth medium. *Appl. Microbiol.* 21: 363.
96. Mauron, J. 1981. The Maillard reaction in food: a critical review from the nutritional standpoint. *Progr. Food Nutr. Sci.* 5: 5.
97. McClure, P. J. 1999. Predictive modeling of microbial growth: the microorganisms response to water activity. In: *Water Management in the Design and Distribution of Quality Foods*. Roos, Y. H., Leslie, R. B. and Lillford, P. J. eds. Technomic Publishing, Lancaster. pp. 375–393.
98. McLaren, A. D. and Rowen, J. W. 1952. Sorption of water vapor by proteins and polymers: a review. *J. Polym. Sci.* 7(2/3): 289–324.
99. Measures, J. C. 1975. Role of amino acids in osmoregulation of nonhalophilic bacteria. *Nature* 257: 398.
100. Mellon, E. F., Korn, A. H. and Hoover, S. R. 1948. Water adsorption of protein. II. Lack of dependence of hysteresis in casein on free amino groups. *J. Am. Chem. Soc.* 70: 1144.

101. Mugnier, J. and Jung, G. 1985. Survival of bacteria and fungi in relation to water activity and solvent properties of water in biopolymer gels. *Appl. Environ. Microbiol.* 50: 108.
102. Munzing, K. 1991. DSC studies of starch in cereal and cereal products. *Thermochim. Acta* 193: 441–448.
103. Nagai, T. and Yano, T. 1990. Fractal structure of deformed potato starch and its sorption characteristics. *J. Food Sci.* 55(5): 1334.
104. Nelson, K. 1993. Reactions kinetics of food stability: comparison of glass transition and classical models for temperature and moisture dependence. Ph. D. thesis. University of Minnesota.
105. Obanu, Z. A., Ledward, D. A. and Lawrir, R. A. 1977. Reactivity of glycerol in intermediate moisture meals. *Meat Sci.* 1: 177.
106. Okos, M. R., Narsimhan, G., Singh, R. K. and Weitnauer, A. C. 1992. Food dehydration. In: *Handbook of Food Engineering*. Heldman, D. R. and Lund, D. B. eds. Marcel Dekker, New York. pp. 437–562.
107. Petriella, C., Resnik, S. L., Lozano, R. D. and Chirife, J. 1985. Kinetics of deteriorative reactions in model food systems of high water activity: color changes due to nonenzymatic browning. *J. Food Sci.* 50: 1358–1359.
108. Quast, D. G. and Karel, M. 1972. Effects of environmental factors on the oxidation of potato chips. *J. Food Sci.* 37: 584.
109. Rahman, M. S. 1995. *Food Properties Handbook*. CRC Press, Inc. Boca Raton.
110. Rahman, M. S. 2006. State diagram of foods: its potential use in food processing and product stability. *Trends Food Sci. Technol.* 17: 129–141.
111. Rahman, M. S. and Al-Belushi, R. H. 2006. Dynamic isopiestic method (DIM): measuring moisture sorption isotherm of freeze-dried garlic powder and other potential uses of DIM. *Int. J. of Food Prop.* 9(3): 421–437.
112. Rahman, M. S. and Sablani, S. S. 2002. Measurement of water activity by electronic sensors. In: *Current Protocols in Food Analytical Chemistry (CPFA)*. Wiley, New York. pp. A2.5.1–A2.5.4.
113. Rahman, M. S., Sablani, S. S., Guizani, N., Labuza, T. P. and Lewicki, P. P. 2001. Direct manometric determination of vapor pressure. In: *Current Protocols in Food Analytical Chemistry (CPFA)*. Wiley, New York. pp. A2.4.1–A2.4.6.
114. Rangarao, G. C. P., Chetana, U. V. and Veerajju, P. 1995. Mathematical model for computer simulation of moisture transfer in multiple package systems. *Food Sci. Technol.* 28(1): 38–42.
115. Rao, K. S. 1939. Hysteresis in the sorption of water on rice. *Current Sci.* 8: 256.
116. Rao, K. S. 1939. Hysteresis loop in sorption. *Current Sci.* 8: 468.
117. Rao, K. S. 1941. Hysteresis in sorption-V. *J. Phys. Chem.* 45: 522.
118. Rizvi, S. S. H. 1995. Thermodynamic properties of foods in dehydration. In: *Engineering Properties of Foods*. 2nd ed., Rao, M. A. and Rizvi, S. S. H. eds. Marcel Dekker, New York.
119. Rockland, L. B. 1969. Water activity and storage stability. *Food Technol.* 23: 1241–1251.
120. Rockland, L. B. and Beuchat, L. R. 1987. In: *Introduction, Water Activity: Theory and Applications to Food*. Rockland, L. B. and Beuchat, L. R. eds. Marcel Dekker, New York. p. v.
121. Roman, G. N., Urbicain, M. J. and Rotstein, E. 1982. Moisture equilibrium in apples at several temperatures: experimental data and theoretical consideration. *J. Food Sci.* 47: 1484–1507.
122. Rutman, M. 1967. The effect of surface active agents on sorption isotherms of model systems. M.S. thesis, Massachusetts Institute of Technology, Cambridge, MA.
123. Sa, M. M. and Sereno, A. M. 1993. Effect of temperature on sorption isotherms and heats of sorption of quince jam. *Int. J. Food Sci. Technol.* 28: 241–248.
124. Sablani, S., Rahman, M. S. and Labuza, T. P. 2001. Measurement of water activity using isopiestic Methods. In: *Current Protocols in Food Analytical Chemistry (CPFA)*. Wiley, New York. pp. A2.3.1–A2.3.10.
125. Saltmarch, M. and Labuza, T. P. 1981. SEM investigation of the effect of lactose crystallization on the storage properties of spray dried whey. In: *Studies of Food Microstructure*. Holcomb, D. N. and Kalab, M. eds. Scanning Electron Microscopy Inc., IL. pp. 203–210.
126. Saltmarch, M. and Labuza, T. P. 1981. SEM investigation of the effect of lactose crystallization on the storage properties of spray dried whey. In: *Studies of Food Microstructure*. Holcomb, D. N. and Kalab, M. eds. Scanning Electron Microscopy Inc., IL. pp. 203–210.
127. Salwin, H. 1960. Defining minimum moisture contents for dehydrated foods. *Food Technol.* 13: 594–595.
128. Saravacos, G. D., Tsiourvas, D. A. and Tsami, E. 1986. Effect of temperature on the water adsorption isotherms of sultana raisins. *J. Food Sci.* 51: 381.
129. Schaich, K. M. 1974. Free radical formation in proteins exposed to peroxidizing lipids. D.Sc. thesis, Massachusetts Institute of Technology, Cambridge, MA.

130. Scott, W. J. 1957. Water relations of food spoilage microorganisms. *Adv. Food Res.* 7Z: 83–127.
131. Scott, W. J. 1953. Water relations of *Staphylococcus aureus* at 30°C. *Aust. J. Biol. Sci.* 6: 549.
132. Seow, C. C. and Cheah, P. B. 1985. Reactivity of sorbic acid and glycerol in nonenzymatic browning in liquid intermediate moisture model systems. *Food Chem.* 18: 71.
133. Sheehof, J. M., Keilin, B. and Benson, S. W. 1953. The surface areas of proteins, v. The mechanisms of water sorption. *J. Am. Chem. Soc.* 75: 2427.
134. Silver, M. E. 1976. The behavior of invertase in model systems at low moisture contents. Ph.D. thesis, Massachusetts Institute of Technology, Cambridge, MA.
135. Slade, L. and Levine, H. 1986. Non-equilibrium behavior of small carbohydrate-water systems. *Pure Appl. Chem.* 60: 1841.
136. Slade, L. and Levine, H. 1987. Structural stability of intermediate moisture foods—a new understanding, *Food Structure—Its Creation and Evaluation*. Mitchell, J. R. and Blanshad, J. M. V. eds. Butterworths, London. p. 115.
137. Speakman, J. B. and Stott, C. J. 1936. The influence of drying conditions on the affinity of wool for water. *J. Text. Inst.* 27: T186.
138. Stadtman, E. and Earl, R. 1948. Nonenzymatic browning in fruit products. *Adv. Food Res.* 1: 325.
139. Storey, R. M. and Stainsby, G. 1970. The equilibrium water vapour pressure of frozen cod. *J. Food Technol.* 5: 157–163.
140. Strasser, J. 1969. Detection of quality changes in freeze-dried beef by measurement of the sorption isobar hysteresis. *J. Food Sci.* 34: 18.
141. Tome, D., Nicolas, J. and Drapron, R. 1978. Influence of water activity on the reaction catalyzed by polyphenoloxidase from mushrooms in organic liquid media. *Food Sci. Technol.* 11: 38.
142. Troller, J. A. 1989. Water activity and food quality. In: *Water and Food Quality*. Hardman, T. M. ed. Elsevier Applied Science, London. pp. 1–32.
143. Troller, J. A. 1987. In: *Water Activity: Theory and Applications to Food*. Rockland, L. B. and Beuchat, L. R. eds. Marcel Dekker, New York. pp. 101–117.
144. Troller, J. A., and Christian, J. H. B. 1978. Microbial survival. In: *Water Activity and Food*. Academic Press, New York.
145. Tsami, E., Marinos-Kouris, D. and Maroulis, Z. B. 1990. Water sorption isotherms of raisins, currants, figs, prunes and apricots. *J. Food Sci.* 55(6): 1594–1625.
146. Uri, N. 1956. Metal ion catalysis and polarity of environment in the aerobic oxidation of unsaturated fatty acids. *Nature* 177: 1177.
147. Van Den Berg, C., Kaper, F. S., Weldring, J. A. G. and Wolters, I. 1975. Water binding by potato starch. *J. Food Sci.* 10: 589–602.
148. Van Olphen, H. 1965. Thermodynamics of interlayer adsorption of water in clay. I. Sodium vermiculite. *J. Colloid Sci.* 20: 822.
149. Warmbier, H. C., Schnickels, R. A. and Labuza, T. P. 1976. Nonenzymatic browning kinetics in an intermediate moisture model system: effect of glucose to lysine ratio. *J. Food Sci.* 41: 981–983.
150. Warren, R. and Labuza, T. P. 1977. Comparison of chemically measured availability by lysine with relative nutritive value measured by a tetrahymena bioassay during early stage of nonenzymic browning. *J. Food Sci.* 42: 429.
151. Weisser, H. 1985. Influence of temperature on sorption equilibria. In: *Properties of Water in Foods*. Simatos, D. and Multon, J. L. eds. Martinus Nijhoff Publishers, Dordrecht.
152. Weisser, H., Weber, J. and Loncin, M. 1982. Wasserdampf sorption isotherms von zuckeraustauschstoffen im temperaturbereich von 25 bis 80°C. *Food Sci. Technol.* 33: 89.
153. Wolf, M., Thompson, D. R., Warthesen, J. J. and Reineccius, G. A. 1981. Relative importance of food composition in the free lysine and methionine losses during elevated temperature processing. *J. Food Sci.* 46: 1074.
154. Wolf, M., Walker, J. E. and Kapsalis, J. G. 1972. Water vapor sorption hysteresis in dehydrated foods. *J. Agric. Food Chem.* 20: 1073.

# 21

## *Surface Treatments and Edible Coatings in Food Preservation*

Elizabeth A. Baldwin

### CONTENTS

21.1	Rationale for Using Edible Coating and Surface Treatments .....	478
21.2	Mechanism of Action .....	479
21.2.1	Permeability Properties of Coatings .....	479
21.2.1.1	Effect on Water Loss .....	480
21.2.1.2	Effect on Gas Exchange of Fresh Fruits and Vegetables .....	480
21.2.1.3	Effect on Stability of Lightly Processed Fruits and Vegetables .....	481
21.2.2	Structural Integrity and Appearance of Coated Products .....	481
21.3	Materials Used in Edible Coatings and Film Formulations .....	481
21.3.1	Lipids .....	482
21.3.1.1	Oils .....	482
21.3.1.2	Waxes .....	483
21.3.1.3	Emulsions .....	483
21.3.2	Resins .....	483
21.3.2.1	Shellac .....	484
21.3.2.2	Wood Rosin .....	484
21.3.2.3	Other Resins .....	484
21.3.3	Proteins .....	484
21.3.3.1	Milk Proteins .....	484
21.3.3.2	Collagen and Gelatin .....	485
21.3.3.3	Wheat Gluten .....	485
21.3.3.4	Corn Zein .....	485
21.3.3.5	Soy Protein .....	485
21.3.3.6	Peanut Protein .....	486
21.3.4	Carbohydrates .....	486
21.3.4.1	Cellulose .....	486
21.3.4.2	Pectin .....	486
21.3.4.3	Chitin/Chitosan .....	487
21.3.4.4	Starch .....	488
21.3.4.5	Aloe Vera .....	488
21.3.4.6	Konjac Glucomannan .....	488
21.3.4.7	Seaweed and Gum Polymers .....	488
21.4	Additives as Individual Treatments or in Coating Formulations .....	489
21.4.1	Plasticizers, Emulsifiers, and Surfactants .....	489
21.4.1.1	Plasticizers .....	489
21.4.1.2	Emulsifiers and Surfactants .....	489
21.4.2	Fungicides and Biocontrol Agents .....	489
21.4.2.1	Fungicides .....	489
21.4.2.2	Biological Control Agents .....	490
21.4.3	Preservatives .....	491

21.4.3.1	Benzoates, Sorbates, and Other Short-Chain Organic Acids .....	491
21.4.3.2	Parabens .....	491
21.4.3.3	Sulfites.....	492
21.4.3.4	Sucrose Esters and Chitosan .....	492
21.4.3.5	Other Natural Antifungal Compounds .....	492
21.4.4	Antioxidants .....	492
21.4.4.1	Phenolic Antioxidants .....	492
21.4.4.2	Other Antioxidants and Antibrowning Agents .....	493
21.4.5	Mineral and Growth Regulator Treatments .....	494
21.4.5.1	Calcium .....	494
21.4.5.2	Growth Regulators .....	494
21.5	Fumigation and Gas Treatments .....	494
21.6	Fruit Quarantine Treatments .....	495
21.7	Surface Preparation and Coating Techniques .....	495
21.8	Reported Applications in Foods .....	496
21.8.1	Fresh Intact Fruits and Vegetables .....	496
21.8.2	Lightly Processed Fruits and Vegetables, Dried Fruit, and Nut Products .....	496
21.8.3	Processed Food and Animal Products .....	497
21.9	Legal Aspects.....	497
21.10	Consumer Attitudes .....	498
	References .....	498

Consumer interest in health, nutrition, and food safety combined with environmental concerns has renewed efforts in edible coating research. Renewable and abundant resources are available for use as film-forming agents that could potentially reduce the need for synthetic packaging films that add to waste-disposal problems. Alternatives to petroleum-based packaging include naturally occurring lipid, resin, protein, and carbohydrate film formers and their derivatives. In fact, coating techniques had been in use for decades, and even centuries, before the development of plastic polymers. For example, beeswax was used to coat citrus fruit to retard water loss in China during the twelfth and thirteenth centuries [1], and “larding” (coating food with fat) to prevent desiccation was practiced in sixteenth-century England [2]. The use of synthetic and natural waxes and resins to coat fresh fruits and vegetables has been researched and practiced in the United States, the United Kingdom, and Australia since the 1930s [3–9]. Development of edible coatings for use on meat products was first reported in the late 1950s [10–14].

Currently, edible coatings and films are commonly used on many commodities such as candies, fresh fruits and vegetables, and processed meats. New research seeks to expand and improve coating technologies and materials to further enhance food stability and quality. Other surface treatments for foods include application of antioxidants, acidulants (or other pH-control agents), fungicides, preservatives, and mineral salts, some of which are more extensively covered in other chapters of this volume.

---

## 21.1 Rationale for Using Edible Coating and Surface Treatments

Edible coatings serve many purposes in food systems. Coatings are used to improve appearance or texture and reduce water loss. Examples include the “waxing” of apples and oranges to add gloss and reduce shrinkage due to water loss or the coating of candies to reduce stickiness [15,16]. Use of antioxidants and sulfites to preserve fresh appearance in minimally processed fruits and vegetables or processed foods is well reviewed by Sapers [17] and Sherwin [18]. Antioxidants are used to reduce browning of cut apple and pear [19–22], potato [23,24], mushrooms [25,26], and shellfish [17,27,28] and to preserve the color of fish [29], which is more extensively reviewed in another chapter. Fungicides are used to reduce decay of whole fruits [30]; and salts, such as calcium, are reported to delay ripening, increase firmness, improve appearance, and enhance disease resistance of fruits [31–35]. Preservatives, acidulants, and to some extent antioxidants and sulfites reduce surface microbial populations on fresh-cut produce and processed foods [36,37]. Many of these treatments are covered in more detail in other chapters.

This review concentrates on the use of edible coatings alone and as carriers of antioxidants [38–41], preservatives [41–46], acidulants [40,41,47], salts [34], and fungicides [48–55]. Coatings have been shown to increase the efficiency of preservatives [41,44], but fungicides sometimes have reduced activity in a coating system [51,52]. Edible coatings can also encapsulate flavor for preservation, storage, or controlled release in food systems [56]. Another advantage is the retention of flavor volatiles in coated fruit [57]. Coatings and films can slow deteriorative changes in coated products by reducing desiccation and oxidation and, in some cases, by creating a modified atmosphere (MA) around coated products [15,16]. Coatings can reduce the migration of lipids (fats and oils) in confectionary products [58] and fried foods [16,58,59] or separate components of different water activity [60,61]. Formulations can be designed to carry desired additives (including antioxidants, acidulants, chelators, preservatives, and fungicides) that help to extend product stability and, therefore, shelf life [62]. Edible films and coatings can also improve mechanical handling properties and structural integrity of various food products by helping fruit slip over packing lines with less injury [63] or by holding toppings in place during product distribution [64].

---

## 21.2 Mechanism of Action

### 21.2.1 Permeability Properties of Coatings

Permeability of films and coatings to water vapor, gas, solute, or lipids is an important property to consider when selecting film materials or for tailoring coatings for specific commodities. Permeability of a barrier is calculated from a combination of Ficks first law of diffusion and Henry's law of solubility. This is used to determine the flux of a permeate through a nonporous barrier, assuming that the barrier has no imperfections. Permeance is a measure of flux without accounting for barrier thickness and used for performance evaluation of a film rather than describing its property. Transmission rate describes permeance without accounting for film thickness or the partial pressure gradient of permeate. Resistance describes the ability of a material to serve as a barrier to the diffusion of a permeate. A detailed discussion of terms, equations, and theories of permeability is presented by Donhowe and Fennema [64] and McHugh and Krochta [65].

Permeability properties of edible films are often unpredictable due to the absence of a homogeneous structure and the often hydrophilic nature of most formulations [65]. The chemical composition and structure of the film-forming polymer affect film permeability in general. Highly polar materials with a high degree of hydrogen bonding exhibit low gas permeability, especially under conditions of low humidity, but are poor barriers to moisture. Nonpolar materials, such as lipids, provide good moisture barriers, but are permeable to gases such as oxygen. The type of functional group on a polymer can also have an effect, depending on the resulting chain interaction and motion and whether the functional group is hydrophilic or hydrophobic. Ionic functional groups create strong polymer chain interactions, which restrict chain motion. This usually results in good oxygen barriers, but also hydrogen bonding with water and subsequent water absorption at high relative humidities (RHs), which, in turn, results in high rates of water vapor permeation. In addition, absorption of water disrupts intermolecular chain interaction, which increases permeability in general. This is the reason that films are often more permeable at high RHs [66]. Nonpolar groups result in a much less effective oxygen barrier film when present as the side chain but improve water permeability slightly.

Addition of low-molecular-weight components, or plasticizers, can affect film permeability and flexibility, often increasing both (especially water vapor permeability) by disruption of polymer chain hydrogen bonding [65,67]. These components are generally added to decrease film brittleness by increasing elasticity/flexibility, resulting in less cracking and flaking of coatings.

The structure of the film-forming polymer is also important in terms of influencing permeability properties of a film. Polymer chain packing, whether it is tight or loose due to bulky side chains, results in increased or decreased permeability properties, respectively [65]. Molecular weight and crystalline structure of a polymer can have an effect [67]. Lipids can exist in different crystalline states, which result in different barrier properties, with the higher degree of crystallinity resulting in lower permeability. Temperature affects polymer mobility [68] and thus permeability. Higher temperatures (above the "glass" transition state) result in polymers that are more mobile (plastic amorphous state) and have relatively increased permeability properties compared to when they exist as "glasses" or in brittle form at lower temperatures [65]. Even without going through a structural transition,

oxygen transmission through protein films was affected by temperature [68]. Orientation of polymers to the flow of permeate can affect permeability properties. For example, the packed arrangement of wax crystals perpendicular to the direction of gas flow presents a better barrier [69] than when parallel to the direction of flow.

Cross-linking of polymer chains with ions or enzymes can lower permeability values as well as change the pH (depending on the isoelectric point in the case of protein films) [65,70]. The addition of hydrophobic materials (lipids) to a hydrophilic film-former to make a composite coating can sometimes improve the moisture-barrier properties of the hydrophilic film former. This was demonstrated for a matrix of methylcellulose and hydroxypropyl methylcellulose combined with saturated C<sub>16</sub> and C<sub>18</sub> fatty acids laminated with beeswax and with a chitosan film containing lauric acid [71–73]. This can also be achieved by forming bilayer films from hydrophilic and hydrophobic materials. An example of this was reported for hydroxypropyl methylcellulose and a blend of stearic and palmitic acids [60,74].

### **21.2.1.1 Effect on Water Loss**

Water loss usually occurs in the vapor phase. Water vapor permeability describes the movement of water vapor through a film or coating per unit area and thickness, and determines the vapor pressure difference across the film at a specific temperature and humidity [75]. If pores, cracks, or pinholes form on the film surface, then water vapor flows through these areas directly, which is different from the dissolving and diffusion of water vapor through a film barrier [65]. Water vapor transfer through films is dependent on environmental conditions such as temperature and humidity, and thus should be tested under the conditions expected to be encountered by a specific product. Generally, the more hydrophilic the film-forming material, the more permeable the film will be to water vapor.

### **21.2.1.2 Effect on Gas Exchange of Fresh Fruits and Vegetables**

#### *21.2.1.2.1 Creation of a Modified Atmosphere for Coated Fresh Produce and Effect on Ripening*

Cells of plant tissues, such as harvested fruits and vegetables, are physiologically active in that they consume oxygen (O<sub>2</sub>) and produce carbon dioxide (CO<sub>2</sub>) as they respire. When fruits or vegetables are sealed in semipermeable plastic packaging or coating, an MA is created within the packaging or in the internal atmosphere of the fruit, in the case of edible coatings, depending on the permeability of the film or coating. During storage, fruit respiration continues to consume O<sub>2</sub> and release CO<sub>2</sub> [15]. If O<sub>2</sub> levels fall too low (below 1%–3%, depending on the produce and storage temperature), anaerobic reactions can occur, which result in off-flavors, abnormal ripening, and spoilage [76,77]. Climacteric-type fruits are often harvested immature and ripen off the mother plant with an accelerated respiration pattern and ethylene production [76]. The high rates of respiration and ethylene production, which turn on genes regulating ripening and senescence, contribute to a relatively short shelf life for this type of produce. Ethylene production, like respiration, is a process that requires O<sub>2</sub>. Low O<sub>2</sub> (below 8%) and high CO<sub>2</sub> (above 5%) concentrations slow down respiration and retard ethylene production and, therefore, ripening [77]. High storage temperatures increase fruit or vegetable respiration [76] and exacerbate the effect of a coating or other packaging on the internal atmosphere of the coated produce. Low temperature, on the other hand, slows down fruit ethylene production and respiration, thus minimizing the effect of a film or coating in terms of modifying the atmosphere inside a fruit.

#### *21.2.1.2.2 Retardation of Weight Loss and Surface Desiccation*

Fruits and vegetables also lose water to the surrounding air in the form of water vapor through a process called transpiration. This entails the movement of water from fruit cells to the surrounding atmosphere following a gradient of high water concentration (~100% RH in fruit intercellular spaces or internal atmosphere) to low water concentration (% humidity of the storage environment). For this reason, fresh produce is often stored under conditions of high RH (90%–98%) to minimize water loss, subsequent weight loss, and shriveling [78]. Edible coatings can help retard this movement of water vapor but become more permeable to water vapor and gases under conditions of high RH as explained above.

### **21.2.1.3 Effect on Stability of Lightly Processed Fruits and Vegetables**

Light or minimal processing of fresh produce indicates cutting, slicing, coring, peeling, trimming, or sectioning of fruits and vegetables. Since fresh-cut produce, like intact products, have an active metabolism, the processing operations result in a series of chemical and biochemical reactions that can lead to deteriorative changes. These reactions include increased respiration, ethylene production, rapid senescence, undesirable color changes, flavor changes, synthesis of secondary metabolites, and increased microbial growth [79–81]. Many of these reactions are plant wound responses [82–84] due to injury incurred by the minimal processing. Methods used to extend the storage life of lightly processed products are application of antioxidants, acidulants, preservatives, mineral salts, and osmotic agents. Some applications can be made using an edible coating as a carrier of these active compounds that retard browning or discoloration, microbial growth, and softening. In addition, coatings with the appropriate permeability properties and under certain conditions can create an MA around the product and retard respiration, oxidation, and desiccation. Several reviews have been published on this subject [79–81,85]. Reduction of surface water activity can increase product stability. This can be achieved by infiltration of fruit slices or pieces with fruit juices, sucrose syrups, or glycerol with or without a coating made up of a suitable water-soluble polymeric material [79].

### **21.2.2 Structural Integrity and Appearance of Coated Products**

Coatings on fruits and vegetables can act as lubricants to reduce surface injury, scarring, and chafing [1,86]. With less wounding of fruits, decay due to opportunist wound pathogens is lessened. In addition, the act of applying certain types of coatings reduces surface microbial populations [87]. For these reasons, waxed citrus fruits experience less decay compared to unwaxed fruit [88]. For food consisting of multiple components, a film can be used to secure the components to the product during marketing [64]. Waxes are also used to encase cheese to prevent surface molding during the ripening and aging process [89]. Resins, zein protein, and microemulsions of waxes can impart a high gloss to the coated product [90,91]. Shellac, polyethylene, and carnauba wax microemulsions are used on fruits [15], and carnauba, shellac, and zein have been applied to candies and confectioneries as well [16,38,92]. Zein has been tested on tomato fruits but so far has not been used commercially on fruit [93]. Candelilla wax microemulsions impart a glossy appearance, especially when combined with gelatin protein [94]. Carbohydrate coatings, such as cellulose or pectin, result in an attractive nonsticky sheen when applied to products when dry, but often give an undesirable slippery texture when products become wet with condensation, as is often the case after removal from chilled storage. The polysaccharide film formers, however, do not result in the high gloss finish obtained with shellac, carnauba wax, or zein coatings.

---

## **21.3 Materials Used in Edible Coatings and Film Formulations**

Many diverse materials are used in coatings or film formulations. Descriptions of the most common main ingredients or film formers are given below. The United States is generally considered the leader in worldwide food regulation; thus, when possible, approval rating based on the U.S. Food and Drug Administration Federal Code of Regulations [95] is also given. Generally recognized as safe (GRAS) status covers direct food additives for their intended use at a quantity not to exceed the amount reasonably required to accomplish the intended physical, nutritional, or other technical effect in food, that are of appropriate food grade, and used with good manufacturing practices (GMP) (FDA, 21 CFR, 1996). The GRAS status is shown without differentiating between initial GRAS, status (FDA 21 CFR, Part 182) and reaffirmed as safe with minor restrictions and within specified ranges and uses or purposes and under prescribed conditions (Part 184). Part 180 refers to food additives permitted in food on an interim basis or in contact with food pending additional study; Part 172 contains other direct food additives that are not GRAS, including food preservatives, coatings, and films, and special dietary and nutritional additives; Part 173 contains secondary direct food additives including polymer substances and adjuvants for food treatment, enzyme preparations, and specific usage additives; and Part 175 contains indirect food additives including adhesives and components of coatings (FDA 21 CFR [95]).



TABLE 21.1

Common Lipid Components of Coatings

Lipid	Classification	U.S. FDA 21 CFR #
<b>Oils</b>		
Acetylated monoglyceride	Removable hot-melt strippable coating	172.828, 175.230
Castor oil	Component of coatings—candy, tablets	172.876
Fatty acids from edible sources: capric, lauric, myristic, oleic, palmitic, stearic	Release agent; lubricant; protective coating for raw fruits and vegetables	172.86
Lard oil	GRAS, edible oil	182.7
Mineral oil	Removable hot-melt strippable coating	175.23
Peanut oil	GRAS, edible oil	182.7
Rapeseed oil	GRAS, emulsifier, stabilizer	184.1555
Salts of fatty acids	Binder, emulsifier, anticaking agent	172.863
Soy oil	GRAS, edible oil	182.7
Synthetic isoparaffinic petroleum hydrocarbons	Component of coatings on fruits and vegetables	172.884
Tallow	GRAS, edible oil	182.7
White mineral oil	Component hot-melt coating for frozen meat acetylated monoglyceride	172.878
<b>Waxes</b>		
Beeswax	GRAS, surface finishing agent	184.1973
Candelilla	GRAS, lubricant, surface finishing agent	184.1976
Carnauba	GRAS, lubricant, surface finishing agent	184.1978
Paraffin wax	Component of coating	175.250, 175.300
Petroleum wax	Component of microcapsules for flavorings, defoamer, protective coating for cheese, and raw fruits and vegetables	172.886

### 21.3.1 Lipids

Lipids include a group of hydrophobic compounds, which are neutral esters of glycerol and fatty acids. They also include “waxes,” which are esters of long-chain monohydric alcohols and fatty acids [69]. A list of lipid components commonly used in coatings, along with their status according to U.S. FDA 21 CFR [95], is given in Table 21.1. Fatty acids and alcohols lack structural integrity and durability in their free form to be good film formers. Owing to the fragile nature of these compounds, lipids are often incorporated into a structural matrix of some other compound such as a polysaccharide [64]. Lipid components are, therefore, incorporated in composite coatings made up of at least two materials. The supporting matrix, if made up of hydrophilic polymers, may affect film resistance to water vapor transmission [96]. Generally, oils are not as resistant to gases and water vapor transfer as are the solid-state waxes [60,74]. Stearyl alcohol was the most resistant to O<sub>2</sub> transmission, probably due to its ability to crystallize as overlapping platelets with an orientation perpendicular to the direction of gas flow [97,98]. Generally, coatings that include lipid solids up to 75% can be used to improve coating performance without diminishing moisture-barrier properties, but below 25% solids, permeability increase was observed under test conditions [99].

#### 21.3.1.1 Oils

Paraffin oil, mineral oil, castor oil, rapeseed oil, acetylated monoglycerides, and vegetable oils (peanut, corn, and soy) have been used alone or in combination with other ingredients to coat food products. White mineral oil is a petroleum-based product, being a mixture of liquid paraffinic and naphthenic hydrocarbons. It is approved for use as a food-release agent and as a protective coating for fresh fruits and vegetables [69]. Fatty acids and polyglycerides are derived from vegetable or tab oils and are considered GRAS [95]. They are commonly used with glycerides as emulsifiers. Among several oils tested, paraffin oil had the greatest resistance to water followed by vegetable oil and light mineral oil [15].

Acetoglycerides are synthetic fats where acetic acid is substituted for a portion of a naturally occurring fat or oil resulting in mono- or diacetotriglycerides or combinations of these compounds. Although acetic acid is a fatty acid, it does not occur as a glyceride in natural fats. Its water vapor permeability was found to decrease with increasing acetylation [100,101]. Acetoglycerides are highly flexible in polymorphic form and stable in crystalline form. These modified fats have use as protective coatings and as plasticizers [102]. Most oils used in coatings are considered direct food additives with varying restrictions according to the U.S. FDA [95]. Paraffin and mineral oil are allowed as release agents and lubricants, defoamers, or components of coating, and castor oil is approved as a release agent and component of coatings. Vegetable oils are generally considered GRAS, while acetylated monoglycerides are considered food additives with few restrictions other than that they are made from edible fat [95].

### 21.3.1.2 Waxes

Paraffin, carnauba, beeswax, candelilla, and polyethylene waxes have been used to coat food products, alone or in combination with other ingredients. Paraffin wax is a distillate fraction of crude petroleum [103]. Synthetic paraffin wax is formed from the catalytic polymerization of ethylene and is allowed for food use in the United States. It is used as a protective coating for raw fruits, vegetables, and cheese, as a chewing gum base and defoamer, and as a component in the microencapsulation of flavorings [69]. Carnauba wax is the exudate of palm tree leaves from the tree of life (*Copernicia cerfera*) found in Brazil. Beeswax or “white wax” is secreted by honeybees, and candelilla wax is an exudate of the candelilla plant (*Euphorbia antisiphilitica*), which is a reedlike plant that grows in Mexico and southern Texas. These natural waxes are considered GRAS [95] in the United States and are used in chewing gum, hard candy, and edible coatings. Polyethylene wax is oxidized polyethylene or the basic resin produced by the mild oxidation of polyethylene, a petroleum-based product. This substance is allowed for use in edible coatings for fruits and nuts where the peel or shell is not normally ingested [69,95,105]. Coatings made with this wax are more permeable to gases than shellac and most other polymers [105].

### 21.3.1.3 Emulsions

Emulsion coatings are oils or waxes dispersed in water or some other hydrophilic solution. A macroemulsion has dispersed wax particle sizes ranging from  $2 \times 10^3$  to  $1 \times 10^5$  Å, and microemulsions from  $1 \times 10^3$  to  $2 \times 10^3$  Å. Melted wax disperses in water in a manner similar to oil [106]. Carnauba wax and beeswax form stable microemulsions with the appropriate emulsifiers, forming a glossy coating, while macroemulsions generally impart little shine to the coated product [69].

### 21.3.2 Resins

Resins are a group of acidic substances that are produced and secreted as a wound response by specialized plant cells of trees and shrubs. Synthetic resins are petroleum-based products [69]. A list of resins commonly used in coatings, along with their status according to 4% U.S. FDA 21 CFR [95], is shown in Table 21.2.

**TABLE 21.2**

Common Resin Components of Coatings

Resins	Classification	U.S. FDA 21 CFR #
Copal	Resinous and polymeric coatings	175.300
Coumerone indene	Resinous and polymeric coatings	172.215
Damar	Resinous and polymeric coatings	175.300
Elemi	Resinous and polymeric coatings	175.300
Shellac	Resinous and polymeric coatings	175.300
Terpene	Moisture barrier on soft gelatin capsules or powders of ascorbic acid	172.280
Wood rosin	Coatings on fresh citrus fruit	175.300

### 21.3.2.1 Shellac

Shellac resin is secreted by the insect *Laccifer lacca* found in India. Shellac is composed of aleuritic and shelloic acids [107], is compatible with waxes, and gives coated products a high gloss appearance. This compound is permitted as an indirect food additive (FDA 21 CFR 175.300: resinous and polymeric coatings for food contact surfaces), but is nevertheless commonly used in coatings for fresh fruits and candies where the coated surface is consumed. Apparently, this is allowed because a petition has been submitted for GRAS status [69]. Shellac and other resins have relatively low permeability to gases and moderate permeability to water vapor [105,108].

### 21.3.2.2 Wood Rosin

Wood rosin is manufactured from oleoresins of pine trees. The rosin is the residue left after distillation of volatiles from the crude resin [69]. It is less expensive than shellac, and specific esters of maleic anhydride-modified wood rosin are approved for use in coatings for citrus. Similarly, coumaroneindene resin is approved for use specifically on citrus fruit. Coumaroneindene resin is a petroleum or coal tar by-product that is available in several grades. It is most often used as a component of the "solvent waxes" for citrus [69,109]. These so-called waxes consist mostly of resins with little or no actual wax component and small amounts of petroleum solvent (U.S. FDA 21 CFR 172.250), ethanol (U.S. FDA 21 CFR 184.1293), or isopropanol (U.S. FDA 21 CFR 173.240, 173.340) [3,69,95]. They have low viscosity and rapid drying rates. Resin solution waxes contain a small amount of lipid (usually oleic acid), morpholine (U.S. FDA 21 CFR 172.235), or potassium or ammonium hydroxide (U.S. FDA 21 CFR 184.1631 and 184.1139, respectively), and other ingredients [95,110,111].

### 21.3.2.3 Other Resins

Terpene resin is obtained from polymerization of terpene hydrocarbons derived from wood and is approved as a direct food additive [95]. It is allowed for use as a moisture barrier in soft gelatin capsules. Other resins allowed only for food contact include copal, damar, and elemi, which are used in the pharmaceutical industry [69,95].

## 21.3.3 Proteins

Proteins have been used for their film-forming abilities for nonfood applications since ancient times as a component of glue, paint leather finishes, paper coatings, and inks. More recently, protein materials, such as the milk protein casein and corn protein zein, have been used as edible coatings for extruded meats as well as nuts and confectionery items, respectively [112]. A list of proteins commonly used in coatings and films, along with their status according to the U.S. FDA 21 CFR [95], is given in Table 21.3. Film-forming proteins of plant origin include corn zein, wheat gluten, soy protein, peanut protein, and cottonseed protein, of which all but the latter are considered GRAS [95]. Keratin, collagen, gelatin, casein, and milk whey proteins are film formers derived from animal sources, of which casein and whey proteins are GRAS [95]. Adjustment of protein film pH can alter film formation and permeability properties, as was demonstrated for soy protein, wheat gluten [113,114], and casein [70]. Most protein films are hydrophilic and, therefore, do not present good barriers to moisture. However, dry protein films such as zein, wheat gluten, and soy present relatively low permeabilities to O<sub>2</sub> [113].

### 21.3.3.1 Milk Proteins

Milk protein products include casein (80% of total milk protein) and whey (20% of total milk protein), and combinations of both [65,115]. They can result in films of different properties depending on the commercial source and method of extraction [70,115].

#### 21.3.3.1.1 Casein

Caseins are soluble in aqueous solutions and form flexible colorless films. The addition of lipid compounds and adjustment of pH reduced the water vapor permeability of casein films [116], while the addition of whole milk, sodium caseinate, and nonfat dry milk or whey into polysaccharide films

TABLE 21.3

Commonly Used Protein Materials in Coatings

Protein Materials	Classification	U.S. FDA 21 CFR #
Casein/sodium caseinate collagen	GRAS, GMP	182.90, 182.1748
Cottonseed (modified products)	Food additive	172.894
Gelatin	Microcapsules for flavorings (succinylated gelatin)	172.230
Fish protein concentrate	Food supplement	172.385
Fish protein isolate keratin	Food supplement	172.340
Peptones	GRAS, nutrient supplements	184.1553
Soy protein isolate	Migrating to food from paper products	182.90
Wheat gluten	GRAS, stabilizer, thickener, surface finishing agent	184.1322
Whey	GRAS, GMP	184.1979
Zein	GRAS, surface finishing agent	184.1984

Note: GRAS = generally recognized as safe by the U.S. Food and Drug Administration; GMP = good manufacturing practices.

decreased the water vapor permeability of these hydrophilic films [117]. Lactic acid-treated casein films retained more sorbic acid preservative, improving the microbial stability of dehydrated apricot and papaya in intermediate-moisture food test systems [118].

#### 21.3.3.1.2 *Whey*

Whey proteins produce films similar to those produced from caseinates. Heating is required to form intermolecular disulfide bonds, which produces films that are water insoluble and brittle, requiring plasticizers [112,115].

#### 21.3.3.2 *Collagen and Gelatin*

Collagen is the major component of skin, tendon, and connective tissues in animals [112]. This material is partially digested with acid or enzymes to produce edible collagen casings. Collagen casing for meat products was one of the first examples of edible film application in modern times. Gelatin is formed from the partial hydrolysis of collagen [112] and is also allowed as a component of microcapsules for flavorings and for soft capsules in the pharmaceutical industry [95]. It is soluble in aqueous solutions, forming a flexible, clear, oxygen-permeable film.

#### 21.3.3.3 *Wheat Gluten*

The gluten complex is a combination of gliadin and glutenin polypeptides with some lipid and carbohydrate components [112,119]. It is soluble in aqueous alcohol, but alkaline or acidic conditions are required for the formation of homogeneous film-forming solutions [113]. This material also requires plasticizers to increase flexibility, for the films are excessively brittle [112,119]. These films have high water permeability but are good barriers to O<sub>2</sub> and CO<sub>2</sub> [119].

#### 21.3.3.4 *Corn Zein*

Zein is a prolamine derived from corn gluten and is insoluble in water except at very low or high pH. This is due to its high content of nonpolar amino acids. It is soluble in aqueous alcohol and dries to a glossy grease-resistant surface. The film is, however, brittle and plasticizers are required to add plasticity [112,119]. It has been used as a substitute for shellac because of its high gloss appearance, faster drying rate, and increased stability during storage [119].

#### 21.3.3.5 *Soy Protein*

Soy protein is available as concentrate (70% protein) or isolate (90% protein). Film formation is enhanced by heating, which partially denatures the protein, allowing formation of disulfide bonds.

This was shown to lower water vapor permeability. Enzymatic digestion can increase cross-linking [120]. The pH must be adjusted away from the isoelectric point of the soy protein ( $\sim 4.6$ ) to form films. In Asia, films are formed from heated soy milk and are used for wrapping food products [112].

#### **21.3.3.6 Peanut Protein**

Peanut protein films can be formed by two methods. The first is surface film formation, using protein/lipid solutions derived from roasted peanut, partially defatted peanut flour, and protein concentrate. This produces films with rough surface texture and poor mechanical properties. Films can also be produced by deposition method at pH 9.0 from peanut protein concentrate. This method showed promise for development as an edible film [121].

Zein, casein, and soy proteins have been used on confectionery, fruit, and vegetable products as well as on eggs. Self-supporting sheets of edible proteins have been developed that dissolve in water for microencapsulation of flavorings. Casein, soy [123], peanut, corn protein, and collagen have been used to form freestanding films or sheets for wrapping of foodstuffs [112]. Films made of proteins can add a nutritional component to coated foods especially if formulated to include diet-limiting amino acids [112,119]. Allergies to food proteins can be a concern when developing coatings and films from these materials. Gluten intolerance and allergic reactions to milk proteins (casein and whey) and associated lactose are common and may require labeling.

### **21.3.4 Carbohydrates**

Polysaccharides are used in food systems as thickeners, stabilizers, gelling agents, and emulsifiers [124]. They comprise an abundant and renewable resource of hydrophilic film-forming agents with a wide range of viscosities, relatively low permeability to gases, but little resistance to water vapor transfer. A list of commonly used polysaccharides in coatings and films, along with their status according to the U.S. FDA 21 CFR [95], is given in Table 21.4.

#### **21.3.4.1 Cellulose**

Cellulose is the most abundant polysaccharide on the planet, being a major component of plant cell walls. Cellulose is made up of repeating glucose units in  $\beta$ -1,4 linkage. In its natural form, cellulose is not soluble in water, but derivatized forms such as sodium carboxymethyl-, methyl-, hydroxypropyl and-, hydroxypropyl methylcellulose (CMC, MC, HPC, and HPMC, respectively) are more soluble [102,124]. These derivatives have different permeabilities to water vapor and gases and are good film formers [102,106]. The degree of substitution and type of substitution (ionic and nonionic) for functional groups and polymer chain length affect permeability, solubility, and viscometric properties [124,125]. The derivatives CMC and MC are GRAS, while HPC and HPMC are approved as direct food additives for the purpose of film former, stabilizer, thickener, and suspending agent [95]. The latter two derivatives are not permitted for food use in all countries. However, several commercial coatings were developed from cellulose polymers, including TAL Pro-long (Courtaulds Group, London), Semperfresh (United Agri Products, Greeley, CO), and Nature Seal (EcoScience Corp., Orlando, FL). Another cellulose product is called cellulon fiber, which is a bacterial cellulose produced by aerobic fermentation of glucose by a strain of *Acetobacter*. It has a fine fiber structure physically but is not chemically different from plant cellulose. It has been applied to surimi to aid in the binding of water [127] but has no reported uses as a coating or surface agent.

#### **21.3.4.2 Pectin**

Pectins are a complex mixture of polysaccharides that are also components of plant cell walls [129]. They are commercially obtained from citrus peel and apple pomace [125]. These polymers are mainly long chains of  $\alpha$ -1,4-linked galacturonic acid units with varying degrees of esterification with methyl groups. The degree of esterification (DE) affects solubility and gelation properties; pectins with DE above 50% are labeled high-methoxyl and below 50% DE low-methoxyl pectins [102,125]. As with cellulose

**TABLE 21.4**

Commonly Used Polysaccharides in Coatings

Polysaccharides	Classification	U.S. FDA 21 CFR #
Agar	GRAS, drying and flavoring agent, stabilizer, thickeners, surface finishing	184.1115
Alginate	GRAS, emulsifier, stabilizer, thickener	184.1011
Carageenan	Emulsifier, stabilizer, thickener, gelling agent	172.620
Salts of carageenan	Emulsifier, stabilizer, thickener	172.626
Chitosan	Approved in Canada	
Dextrin	GRAS, formulation aid, processing aid, stabilizer, thickener	184.1277
Ethyl cellulose	Binder, filler, component of protective coatings for vitamin and mineral tablets	172.868
Furcelleran	Emulsifier, stabilizer, thickener	172.655
Salts of furcelleran	Emulsifier, stabilizer, thickener	172.660
Gellan gum	Stabilizer, thickener	172.665
Gum arabic (acacia gum)	GRAS, emulsifier, formulation aid	184.1330
Gum ghatti	GRAS, emulsifier	184.1333
Gum karaya	GRAS, formulation aid, stabilizer, thickener	184.1349
Gum tragacanth	GRAS, emulsifier, formulation aid	184.1351
Locust bean gum	GRAS, stabilizer, thickener	184.1343
Guar gum	GRAS, emulsifier, formulation aid, firming agent	184.1339
Hydroxypropyl cellulose	Emulsifier, film former, protective colloid, thickener	172.870
Hydroxypropyl methylcellulose	Emulsifier, film former, protective colloid, thickener	172.874
Methylcellulose	GRAS, GMP	182.1480
Methyl ethyl cellulose	Aerating, emulsifying, or foaming agent	172.872
Modified starch	Food additive	172.892
Pectins	GRAS, GMP	184.1588
Sodium carboxymethyl cellulose	GRAS, GMP	182.1745
Xanthan gum	Stabilizer, emulsifier, thickener, suspending agent	172.695

Note: GRAS = generally recognized as safe by the U.S. Food and Drug Administration; GMP = good manufacturing practices.

polymers, the chain length also affects solubility and viscosity. When used as a film former in coatings, this polymer gives a somewhat glossy, nonsticky surface and LM pectins can be cross-linked with calcium ions to form gels [102]. Coatings made with pectin materials generally have high water vapor transmission rates [130] due to their hydrophilic nature [131], which can be improved by the addition of paraffin or beeswax. The tensile strength of pectinic acid films increases with a decrease in methoxyl content [132] because the removal of ester groups leads to increased cross-bonding between residual carboxyl groups. Miers et al. [132] reported that pectin coatings were of acceptable strength with methoxyl contents of 4% or less and intrinsic viscosities of 3.5 or above. Pectins are generally considered GRAS [95].

### 21.3.4.3 Chitin/Chitosan

Next to cellulose, chitin is the second-most abundant polysaccharide on the planet, being a component of fungal and green algae cell walls and the skeletal substance of invertebrates [133]. It is a  $\beta$ -1,4-linked polymer of 2-acetamido-2-deoxy-D-glucan [129]. Partial deacetylation of chitin results in chitosan, which has been shown to induce plant-defense responses and inhibit growth of fungi [134,135]. Use of this polymer as film former and natural preservative resulted in the commercial coating Nutri-Save (Nova Chem, Halifax, NS, Canada). Methylation of the polymer resulted in a twofold resistance to CO<sub>2</sub> [15,136]. This allows it to retard ripening of climacteric fruits [137]. It, however, has relatively low resistance to water vapor transfer compared to lipid materials. Chitosan has not yet received approval for food use in the United States (although approved for supplements), but it is approved in Canada. The antimicrobial activity of chitosan was found to increase with ionic strength but decreases with addition of metal ions. The antibacterial activity of chitosan was dependent on its charges and solubility [138].

#### 21.3.4.4 Starch

Amylaceous materials (amylose, amylopectin, and derivatives) have also been used to make coatings. These films have been reported to be semipermeable to CO<sub>2</sub> but highly resistant to O<sub>2</sub> [139]. Most starch consists of 25% amylose and 75% amylopectin, with one notable exception being hybrid corn, which contains 50%–80% amylose. Amylose is a polymer of an  $\alpha$ -1, 4-linked glucose, and amylopectin consists of an amylose backbone with side chains of an  $\alpha$ -1,6-linked glucose. Of the two polymers, amylose is a better film-former and amylopectin is more useful as a thickening agent. Some derivatives, such as an hydroxypropyl amylose, showed low permeability to O<sub>2</sub>, improved water solubility [102] and increased elongation properties, but offered no resistance to water vapor. Dextrins (partially hydrolyzed starch molecules, i.e., reduced in size as measured by dextrin equivalent) are used as film formers, encapsulating agents, and flavor carriers. Coatings made from such polymers have lower permeability to water vapor compared to starch films [102,140] and may have resistance to O<sub>2</sub> [141]. Carboxylated dextrins are used as encapsulating agents [129]. Raw starch and dextrin products are considered GRAS, while modified starch products (modified by acid, bleach, and esterification, or oxidized using chlorine) are approved as direct food additives [95].

#### 21.3.4.5 Aloe Vera

Aloe vera gel was used to coat table grapes and it extended shelf life by 35 days at 1°C. The gel worked as a barrier to O<sub>2</sub> and CO<sub>2</sub>, creating an MA, and acted as moisture barrier, and thus reduced weight loss, browning, softening, and growth of yeast and molds. The material reportedly contains antimicrobial compounds and thus prevents decay. This material has been used as a functional ingredient in beverages for years [142]. Aloe vera contains malic acid-acetylated carbohydrates (including  $\beta$ -1,4-glucomannans) that demonstrated anti-inflammatory activity [143].

#### 21.3.4.6 Konjac Glucomannan

Konjac glucomannan is a polysaccharide derived from the konjac tuber and consists of 1,4-linked  $\beta$ -mannose and  $\beta$ -glucose units with some acetyl groups. It has been used in food, film formers, and biomedical applications. It was combined with chitosan and nisin (used by the food industry as a preservative) and was founded to be effective against pathogenic bacteria, including *Staphylococcus aureus*, *Listeria monocytogenes*, and *Bacillus cereus* [144].

#### 21.3.4.7 Seaweed and Gum Polymers

##### 21.3.4.7.1 Seaweed Products

Seaweed products such as carrageenan, alginates, and agar make good film formers or gels. Carrageenan consists of sulfate esters of 3,6-anhydro- $\alpha$ -D-galactopyranosyl units [125,145], alginates are salts of alginic acid (1,4-polyuronic acid with poly- $\beta$ -D-mannopyranosyluronic and poly- $\alpha$ -L-gulopyranosyluronic acid blocks) [102,125,129,146], and agar is made up of  $\beta$ -1,4-D-galactopyranosyl linked to 3,6-anhydro- $\alpha$ -L-galactopyranosyl, partially esterified with sulfuric acid. Of these three, agar is more for formation of gels (currently used as a culture medium) and the other two polymers as gel and film formers. Alginate gels are relatively heat stable [125]. Carrageenan is approved as a direct food additive as an emulsifier, stabilizer, and thickener; while agar is GRAS [95]. In Japan, there is a commercial carrageenan-based coating called Soageena (Mitsubishi International Corp., Tokyo).

##### 21.3.4.7.2 Gum Products

Certain gum products are exudates from plants found mostly in Africa and Asia produced in response to injury [125,140,147], some of which are seed and fermentation products. Gums are complex heteropolysaccharides, including gum arabic or acacia gum from the tree *Acacia senegal* and related species (*n*-galactopyranosyl, L-rhamnopyranosyl, L-arabinopyranosyl, L-arabinofuranosyl, and D-glucopyranosyluronic acid units with calcium, magnesium, and potassium ions) [148,149]. Gum arabic forms an aqueous solution of low viscosity and can form stable emulsions with most oils [129]. It is used in the confectionery industry as a stabilizer, adhesive, and flavor fixative. It has also been used to coat pecans [150] and is a good emulsifier [125].

Other less used gums include gum tragacanth, whose film-forming properties are more useful in nonfood products such as hair and hand lotions and creams [129]; gum karaya, which forms smooth

films that require plasticizer; locust bean gum, whose film-forming properties have been used in the textile industry as a finishing agent and as a common component of cosmetics, sauces, and salad dressings; guar gum, which is also used as a film-former in the textile industry (both locust bean and guar gum are galactomannans) [125]; xanthan gum, a fermentation product with a cellulosic backbone [125], used as a thickener in sauces, gravies, frostings, fruit gels, and coatings to prevent moisture migration during frying [129] and in salad dressings with propylene glycol alginate [151]; and gellan gum, another fermentation product developed and patented by Kelco [152], which is also used in glazes, icings, and jams/jellies [129]. Of these gums, gum arabic (acacia gum), gum ghatti, guar gum, and locust bean gum (carob gum) are considered GRAS, while xanthan and gellan gum are approved as direct food additives for use in glazes, icings, frostings, jams, jellies, and as stabilizer, emulsifier, thickener, etc. [95].

---

## 21.4 Additives as Individual Treatments or in Coating Formulations

Materials other than film formers are added to edible coatings for basically two reasons. One is to improve the structural, mechanical, or handling properties of a coating. The other is to improve the quality, flavor, color, or nutritional properties of the coated product [62]. In the latter case, the coating acts as a carrier of useful compounds that have a desired effect on the coated item.

### 21.4.1 Plasticizers, Emulsifiers, and Surfactants

#### 21.4.1.1 Plasticizers

Plasticizers are usually low-molecular-weight compounds that impart increased strength and flexibility to coatings, but also increase coating permeability to water vapor and gases [64,102]. Commonly used plasticizers, along with their status according to the U.S. FDA 21 CFR [95], are listed in Table 21.5. Common plasticizers include polyols such as glycerol, sorbitol, mannitol, propylene glycol, and polyethylene glycol (molecular weight: 200–9500). Sucrose, sucrose fatty acid esters, and acetylated monoglycerides also can be used as plasticizers. Of these, glycerol, sorbitol, and propylene glycol are considered GRAS [95].

#### 21.4.1.2 Emulsifiers and Surfactants

Emulsifiers can be classified as surface-active agents or as macromolecular stabilizers. Macromolecular stabilizers are proteins, gums, and starches that stabilize emulsions [153]. Commonly used emulsifiers and surfactants, along with their status according to the U.S. FDA 21 CFR [95], are listed in Table 21.5. Surface-active agents reduce surface water activity and can affect the rate of moisture loss from a food when used as a coating. This was shown with glycerol monopalmitate and glycerol monostearate and other 16- to 18-carbon fatty alcohols [102]. Reduction of surface water activity at the water–oil interface helps to both form and stabilize emulsions, which is important for shelf-life properties of emulsion coatings. The hydrophilic–lipophilic balance (HLB) of surfactants ranks these compounds according to their hydrophobic and hydrophilic portions, which has an effect on their performance as emulsifiers. For example, sodium lauryl sulfate is a very hydrophilic surfactant with an HLB value of 40. Generally, surfactants with low HLB values are effective for water-in-oil emulsions, and those with high HLB values are more useful for oil-in-water emulsions [69]. Some common emulsifiers are acetylated monoglyceride, lecithin (GRAS) and lecithin derivatives, ethylene glycol monostearate, glycerol monostearate, sorbitan fatty acid esters (TWEENS), and palm and corn oil (GRAS) [95]. Surfactants help coatings adhere to coated surfaces. Most natural waxes also have emulsifying properties since they comprise long-chain alcohols and esters [69].

### 21.4.2 Fungicides and Biocontrol Agents

#### 21.4.2.1 Fungicides

Fresh fruits and vegetables are susceptible to a variety of postharvest decay types that can be reduced by treatment with fungicides with and without a coating of “wax” [154]. About 20 compounds have been developed and tested for use as postharvest pesticides over the last 30 years [62], but many have been banned or not reregistered in the United States and other nations. Use of fungicides applied in fruit



TABLE 21.5

Commonly Used Plasticizers, Emulsifiers, and Surfactants

Compounds	Classification	U.S. FDA 21 CFR #
Acetylated monoglycerides	Emulsifiers, component of coating	172.828
Corn oil	Edible oil	
Ethoxylated mono-, diglycerides	Emulsifiers	172.834
Glycerol	GRAS, GMP	182.1320
Glycerol monopalmitate (Ethoxylated mono- and diglycerides)	Emulsifier	172.834
Glycerol monostearate (Ethoxylated mono- and diglycerides)	Emulsifier	172.834
Hydroxylated lecithin	Emulsifier	172.814
Lecithin	GRAS, GMP	184.1400
Mannitol	Permitted food additive, component of resinous and polymeric coatings	180.25, 175.300
Oleic acid	Lubricant, binder, defoaming agent	172.862
Palm oil	GRAS, cocoa butter substitute	184.1259
Polyethylene glycol	MW 2200–9500; coating, binder, plasticizer, lubricant	172.820
Polysorbate 60	Emulsifier, foaming agent	172.836
Polysorbate 65	Emulsifier	172.838
Polysorbate 80	Emulsifier, dispersing agent, surfactant, wetting agent	172.840
Propylene glycol	GRAS, solvent, thickener, component of resinous and polymeric coatings	184.1666, 175.300
Propylene glycol alginate	Component of coatings for citrus	172.212
Sodium lauryl sulfate	Emulsifier, whipping agent, surfactant, wetting agent	172.822
Sodium stearoyl lactylate	Surfactant, emulsifier, stabilizer	172.846
Sorbitan monooleate	Emulsifier for clarification of cane or beet sugar juice	173.110
Sorbitan monostearate	Emulsifier	172.842
Sorbitol	Component of resinous and polymeric coatings	175.300
Sucrose	GRAS, GMP	184.1854
Sucrose fatty acid esters	Emulsifiers, texturizers, components of protective coatings for fresh fruit	172.859

Note: GRAS = generally recognized as safe by the U.S. Food and Drug Administration; GMP = good manufacturing practices.

coatings has been reported for citrus, including benomyl, imazalil, and thiabendazole (TBZ), of which only the latter two are currently registered for use on citrus in the United States. These fungicides are applied in solvent or water waxes, but this results in reduced ability to inhibit mold growth compared to application as an aqueous suspension. It is thought that encapsulation of the fungicide in the wax is the reason for its reduced efficiency [53]. Use of fungicides in fruit coatings has been reported for stone fruits (methyl-1-(butylcarbamoyl)-2-benzimidazolecarbamate or benomyl) [49], papayas (TBZ) [54], strawberries (3-(3,5-dichlorophenyl)-*N*-(1-methylethyl)-2,4-dioxo-1-imidazolidinecarboxamide, iprodione or Roveral®) [55], tomatoes (*N*-[(trichloromethyl)thio]-4-cyclohexene-1,2-dicarboximide or captan) [155], and apples (Roverol) [156], as well as captan and benomyl on raspberries [157].

#### 21.4.2.2 Biological Control Agents

Antagonistic yeasts and bacteria have been shown to inhibit mold growth and thus prolong the shelf life of fresh fruits and vegetables [158,159]. The mechanisms of action are reported to be the production of an antibiotic compound, competition for nutrients at wound sites on fresh produce, direct interaction with the pathogen, and induction of host defense responses [159]. These compounds have been successfully applied in fruit coatings and were shown to delay spoilage of citrus fruit by this method [160,161]. Two commercial products approved and available on the U.S. market are Biosave® (EcoScience Corp., Orlando, FL), which contains an antagonist bacteria (*Pseudomonas syringae*), and Aspire® (Ecogen Corp. Langhorne, PA), which contains an antagonist yeast (*Candida oleophila*) for control of decay on apples and citrus fruits.

TABLE 21.6

Commonly Used Preservatives

Preservatives	Classification	U.S. FDA 21 CFR #
Acetic acid	GRAS, curing or pickling agent, or in food at levels not to exceed GMP	184.1005
Benzoic acid	GRAS, antimicrobial agent	184.1021
Calcium disodium EDTA	Preservative, color retention	172.120
Citric acid	GRAS, GMP	184.103
Dehydroacetic acid	Preservative for cut or peeled squash	172.130
Fumaric acid	Nutritional additive	172.350
Lactic acid	GRAS, antimicrobial agent	184.1061
Methylparaben	GRAS, antimicrobial agent	184.1490
Natamycin	Mold inhibitor for sliced cheeses	172.155
Potassium sorbate	GRAS, GMP	182.3640
Propionic acid	GRAS, antimicrobial agent	184.1061
Propylparaben	GRAS, antimicrobial agent	184.1670
Sodium benzoate	GRAS, antimicrobial agent	184.1733
Sodium nitrate	Preservative, color fixative for fish and meat	172.170
Sodium nitrite	Preservative, color fixative for fish and meat	172.175
Sorbic acid	GRAS, GMP	182.3089

Note: GRAS = generally recognized as safe by the U.S. Food and Drug Administration; GMP = good manufacturing practices.

### 21.4.3 Preservatives

Chemical preservatives such as salt, nitrites, and sulfites have long been used to prolong the shelf life of food products [36]. Coatings can also act as carriers of antimicrobial agents for lightly processed and processed food products [62]. Commonly used preservatives, along with their U.S. FDA 21 CFR [95], are listed in Table 21.6.

#### 21.4.3.1 Benzoates, Sorbates, and Other Short-Chain Organic Acids

Preservatives such as benzoic acid and benzoates are most effective at pH 2.5–4.0 with the undissociated form of benzoic acid being most effective ( $pK_a$  4.2), rendering this preservative ineffective above pH 4.5 [36]. This preservative controls yeasts and molds more effectively than bacteria and is considered GRAS to a maximum of 0.1% in the United States and up to 0.15%–0.25% in other countries [95]. Sorbic acid and sorbates are also most effective in the undissociated state against fungi and certain bacteria [36]. This preservative is also considered GRAS for most products in accordance with good manufacturing practices up to a level of 0.1% in the United States [95]. Sorbates are permitted in all countries of the world for preservation of various food products in the range of 0.15%–0.25%. Acetic, lactic, propionic, fumaric, and citric acids also can be used in coatings and contribute to antimicrobial activity. Use of coatings as carriers of preservatives such as benzoates and sorbates improved their performance when applied to cut fruit or cheese analogs. This may be due to prevention of diffusion of preservatives into the food tissue or the fact that more preservative is present on the cut surface due to the thickness of the coating. Use of coatings to establish a surface pH that favors the active form of sorbic acid and other preservatives is also a possibility. This was demonstrated with a zein coating on a cheese analog for sorbate [162]; with MC/fatty acid films with sorbate in a test system [46,163]; with chitosan, MC, and HPMC films with sorbate in a test system; and with a CMC/soy protein coating on cut apple with sorbate and benzoate [41].

#### 21.4.3.2 Parabens

Alkyl esters of *p*-hydroxybenzoic acid, or parabens, are effective antimicrobial agents, especially against yeasts and molds. In the United States, methyl and propyl parabens are considered GRAS up to 0.1% [95]. In the United Kingdom, methyl, ethyl, and propyl parabens are permitted in food, while other countries allow butyl ester parabens as well [36].

### 21.4.3.3 Sulfites

Sulfites or sulfur dioxide and its various salts are effective antimicrobials for the control of yeasts, molds, and especially bacteria, and they prevent enzymatic browning in foods. The effectiveness of this preservative is greatest when the acid is undissociated at  $\text{pH} < 4$  ( $\text{p}K_a$  of sulfur dioxide = 1.76 and 7.20). Although sulfur dioxide and various sulfite salts are considered GRAS in the United States, they cannot be used on meats, in food products that are sources of thiamine, or on raw fruits and vegetables [95] due to the elicitation of allergic responses in a certain segment of the population [36].

### 21.4.3.4 Sucrose Esters and Chitosan

Sucrose esters are approved as emulsifiers and are an ingredient in edible coatings along with cellulose in Tal Pro-long (Courtaulds Group, London) and Semperfresh (United Agri Products, Greeley, CO), or with guar gum in Nu-coat Flo (Surface Systems International Ltd.). Sucrose esterified with palmitic and stearic acids showed some antimicrobial activity against certain molds at levels of 1%. Chitosan, the film former of the edible coating Nutri-Save (Nova Chem, Halifax, NS, Canada), has been shown to inhibit growth of fungi on plants by inducing plant defense responses [134,135].

### 21.4.3.5 Other Natural Antifungal Compounds

Unripe fruits are often more resistant to decay possibly due to the presence of some antifungal compounds. Several of these compounds were found in unripe mango, including 5,12-*cis*-heptadecenyl resorcinol and 5-pentadecenyl resorcinol. A similar situation was discovered in unripe avocado where an antifungal compound, 1-acetoxy-2-hydroxy-4-oxoheneicosa-12,15-diene and 1-acetoxy-2,4-dihydroxy-*n*-heptadeca-16-ene. High levels of  $\text{CO}_2$ -enhanced concentrations of the antifungal avocado diene in treated fruits [164], present a possible explanation for the antimicrobial action of this compound, at least in the case of avocado fruit.

An antifungal essential oil and a long-chain alcohol, thought to be 1,7-pentatriacontanol, showed antifungal activity by inhibiting the mycelial growth of *Aspergillus carneus*. This compound was isolated from *Achyranthes aspera*, a herb with reported medicinal properties [165]. Isothiocyanates derived from mustard and horseradish have also been shown to have antimicrobial activity [166]. Another compound, pyrrolnitrin, was isolated from the bacteria *Pseudomonas cepacia*, which in turn were isolated from apple leaves. This microbe was found to have antagonistic activity toward *Penicillium expansum*, *Botrytis cinerea*, and *Mucor* species due to the production of the secondary metabolite pyrrolnitrin. This compound was applied to harvested strawberries and was found to retard various storage rots [167]. None of these natural fungicides has been approved for human consumption, but they offer promising alternatives to synthetic fungicides and preservatives.

## 21.4.4 Antioxidants

Antioxidants are compounds that inhibit or prevent the oxidation reaction caused by free radicals, with or without oxidation enzymes, that cause discoloration or browning of certain fruit and vegetable tissues and rancidity of fats [17,18]. This can affect the color or flavor of meat, fish, mushrooms, fruit, and vegetable products. Commonly used antioxidants, along with their U.S. FDA 21 CFR [95], are listed in Table 21.7.

### 21.4.4.1 Phenolic Antioxidants

The phenolic structure of certain compounds suppresses free radical formation, which delays the autooxidative process in fat or oil by acting as a proton donor [18]. Approved phenolic antioxidants include butylated hydroxyanisole (BHA), butylated hydroxytoluene (BHT), and esters of gallic acid such as propyl gallate and tertiary butyl hydroquinone (TBHQ). Natural antioxidants are also effective, such as tocopherols and lecithin. The antioxidants BHA, BHT, tocopherol, and lecithin are GRAS, while TBHQ is approved as a direct food additive and propyl gallate as an indirect food additive component of coatings [95]. These antioxidants are also approved for food use in many countries, especially BHA, BHT, and tocopherol [18]. Coatings have been used as carriers of antioxidants to retard rancidity of meat and

**TABLE 21.7**

Commonly Used Antioxidants

Antioxidants	Classification	U.S. FDA 21 CFR #
Anoxomer	Antioxidant	172.105
Ascorbic acid	GRAS, GMP	182.8013, 182.5013
Ascorbic acid-2-phosphate		
Ascorbic acid-3-phosphate		
Ascorbyl palmitate	GRAS, GMP	182.3149, 172.110
BHA	GRAS, GMP	182.3169, 172.115
BHT	GRAS, GMP	182.3173
L-Cysteine	GRAS, improved biological quality of total protein in a food	184.1271, 172.320
Diphenylamine (DPA)	Surface treatment of apples for scald disorder	
Erythorbic acid	GRAS, GMP	182.3041
Ethoxyquin	Antioxidant	172.140
4-Hydrocymethyl-2-6-di-tert-butylphenol	Antioxidant	172.150
Lecithin	GRAS, GMP	184.140
Potassium bisulfite	GRAS, GMP, raw fruits and vegetables	182.3616
Potassium metabisulfite	GRAS, GMP, raw fruits and vegetables	182.3637
Propyl gallate	GRAS, antioxidant	184.1660
Rosemary	GRAS, flavoring	182.10, 182.20
Sodium bisulfite	GRAS, GMP, raw fruits and vegetables	182.3739
Sodium metabisulfite	GRAS, GMP, raw fruits and vegetables	182.3766
Sodium sulfite	GRAS, GMP, raw fruits and vegetables	182.3798
TBHP	Antioxidant	172.190
TBHQ	Antioxidant	172.185
Tocopherols	GRAS, GMP	182.8890
$\alpha$ -Tocopherols	GRAS, inhibitors of nitrosamine formation	184.1890
$\alpha$ -Tocopherol acetate	GRAS, GMP	182.8892

Note: GRAS = generally recognized as safe by the U.S. Food and Drug Administration; GMP = good manufacturing practices.

nut products and discoloration of lightly processed fruits and vegetables [16,39–41]. For whole apples, aqueous dips in the antioxidant diphenylamine (DPA) (300–3000 ppm) or ethoxyquin help to reduce surface discoloration known as scald [156,168].

#### 21.4.4.2 Other Antioxidants and Antibrowning Agents

Some agents such as cinnamic and benzoic acids (both GRAS) [95] are effective browning inhibitors in combination with ascorbic acid since, like sulfites, they inhibit polyphenol oxidase (PPO) activity [21]. This enzyme is responsible for the browning that occurs when monophenolic compounds of plants or shellfish are hydroxylated to *o*-diphenols and subsequently to *o*-quinones in the presence of oxygen and PPO in plants and shellfish. The PPO enzyme requires copper, and thus complexing and chelating agents such as ethylenediamine tetraacetic acid (EDTA) and citric acid can inhibit enzymatic browning [17]. Ascorbic acid and its derivatives, erythorbic acid, ascorbic acid-2-phosphate, and -triphosphate, are effective inhibitors of enzymatic browning for cut apple [21,169].

Ascorbyl palmitate, cinnamic acid, benzoic acid, and  $\sim$ 3-cyclodextrin were reported to be effective browning inhibitors in juice [21]. Ascorbic acid, erythorbic acid, and ascorbyl palmitate are GRAS [95], but other ascorbic acid derivatives are, so far, not approved. The amino acid cysteine is also an effective inhibitor of PPO [170]. Rosemary extract (and its constituents carnosol, carnosic acid, and rosmarinic acid) is a source of natural antioxidants [171,172]. Citric acid and EDTA have been incorporated into coatings as browning inhibitors for cut apples, potatoes, and mushrooms [41,173]. The amino acid cysteine inhibits PPO activity by reacting with quinone intermediates as well as reduced glutathione. Inorganic halides such as sodium or calcium chloride ( $\text{CaCl}_2$ ) also inhibit PPO activity [17]. Resorcinol and its derivatives, such as 4-hexyiresorcinol, inhibit browning tyrosinase isozymes in mushrooms and

may inhibit PPO by serving as a substrate for this enzyme. These compounds have antimicrobial activity as well [22]. They are not yet approved for food use in the United States.

## 21.4.5 Mineral and Growth Regulator Treatments

### 21.4.5.1 Calcium

The mineral calcium has many postharvest uses [31]. Postharvest dips of calcium chloride ( $\text{CaCl}_2$ ) can reduce symptoms of bitter pit or small brown lesions that occur on apples as well as scald [156,174]. Calcium or  $\text{CaCl}_2$  dips or infiltrations on whole or cut fruit have been reported to increase fruit firmness for apple [32,175], peach, [176], blueberry [33], and strawberry [177], and to delay ripening and decay of avocado [178], mango [179,180], apple [181], pear [182], peach [183], strawberry [177], and potato [34]. The reasons for these benefits range from alleviating disorders resulting from calcium deficiency, to the effect of calcium on cell walls that makes them more resistant to decay [181] and firmer in texture, to adversely affecting conidial germination and germ-tube elongation [184]. The mineral salt  $\text{CaCl}_2$  is considered GRAS [95]. There is a new compound out called Nature Seal that claims to contain vitamins and minerals, likely calcium ascorbate. This product is used to control browning of cut fruits and vegetables like cut apple [185,186].

### 21.4.5.2 Growth Regulators

The polyamines putrescine and spermidine altered texture when infiltrated into apples [32] and spermine and spermidine increased firmness in sliced strawberries [187]. Growth regulators such as 2,4-dichlorophenoxyacetic acid (2,4-D) and 2,4,5-trichlorophenoxyacetic acid (2,4,5-T) were added to fruit wax as antisenescence compounds to extend the shelf life of mandarin oranges [188]. Maleic hydrazide (250ppm) and 2,4-D were added to wax emulsions to delay ripening of mango fruits [189]. Gibberellic acid (150ppm) suppressed sprouting of yam tubers for 1 month [190]. The only approved postharvest growth regulator treatment for fruits in the United States is for lemons destined for long-term storage. These fruits are sometimes treated with 2,4-D to delay senescence of the button (calyx and residual stem) to reduce infection from *Alternaria* [191].

---

## 21.5 Fumigation and Gas Treatments

Hydrogen peroxide is an antibacterial agent on the basis of its oxidative properties [36], effective at concentration ranges of 0.01%–0.1% (U.S. FDA 21 CFR 184.1366) [95]. It is especially effective against Gram-negative bacteria such as coliforms. There is little information as to its effect on fungi. It is mostly used to extend the shelf life of dairy products and is considered GRAS as an antimicrobial agent for treatment of milk for the making of cheese, whey, and starch [95]. It is reportedly effective as a vapor-phase-treatment fumigant for fresh table grapes. Previously, fumigation with sulfur dioxide was used, but there are concerns about adverse effects on some sensitive individuals (U.S. FDA 21 CFR 182.3862) [95,192]. Acetaldehyde vapor (0.25%–0.5%) significantly reduced decay of harvested table grapes [193], while acetic acid vapor fumigation reduced fungal decay of grapes, apples, oranges, tomatoes, and strawberries [194,195]. Other natural fruit and plant volatiles have been found to exhibit fungistatic activity. Of these volatiles, benzaldehyde, methyl salicylate and ethyl benzoate, 1-hexanol, trans-2-hexenal 2-nonanone, and furan compounds were found to be particularly effective [196–199]. The antimicrobial activity of  $\text{CO}_2$  is greatest against molds and Gram-negative psychrotrophic bacteria in the concentration range of 10%–100% (U.S. FDA 21 CFR 184.1240) [36,95]. The mechanism of action is not known, but may be related to lack of  $\text{O}_2$ , acidification of intracellular contents, or effect on enzymes. Various concentrations of  $\text{CO}_2$  used in modified-atmosphere packaging (MAP) are often within the microbistatic range [200,201]. It has been shown to reduce brown rot of package cherry fruit [202]. 1-Methylcyclopropene (1-MCP) is an ethylene action inhibitor, and thus delays changes caused by the plant hormone ethylene such as ripening, softening, and undesirable

color changes such as browning in cut apples [186,203]. It is currently used by the apple industry to prolong storage life of whole apples and is commercially sold under the name of Smartfresh. However, as ethylene promotes volatile synthesis, use of 1-MCP, by inhibiting ethylene action, can reduce aroma volatiles [204].

---

## 21.6 Fruit Quarantine Treatments

Fruit flies are major pests worldwide, and their fruit hosts must be treated to kill 100% of the immatures inside the fruits prior to export to uninfested areas of the world. One of the main treatments currently used is methyl bromide fumigation, which is scheduled to be phased out over the next few years since it is a suspected stratospheric ozone depleter [205]. Other treatments include cold storage, hot air, vapor heat, and hot water treatments [206]. Unfortunately, most of these treatments impart surface or internal quality damage to many fruits. Recently, use of controlled atmosphere (CA) and edible coatings has been investigated as alternative treatment alone or in combination with currently used methods [207–209]. Preliminary findings suggest that lowered O<sub>2</sub> and elevated CO<sub>2</sub> may contribute to fruit fly mortality [208,209]. Fruit coatings are already approved as a disinfection treatment for surface mites on chermoyas and limes from South America [210].

---

## 21.7 Surface Preparation and Coating Techniques

Edible coatings can be applied by dipping products in coating materials and then allowing excess coating to drain as it dries and solidifies [64]. This was first reported for the Florida citrus industry [8] where the fruits were submerged into a tank of emulsion coating. Commodities are then generally conveyed to a drier where water or solvent is removed or coated items can be allowed to air-dry under ambient conditions [211]. Sometimes a porous basket can be used to drain excess coating. Some emulsion coatings are applied with a foam applicator where a foaming agent is added to the coating or compressed air is blown into the applicator tank. The agitated foam is applied to commodities as they move by on rollers and cloth flaps or brushes distribute the emulsion over the surface of the commodity [211]. Excess coating is then removed by squeegees and sometimes recirculated. This type of emulsion contains little water and, therefore, dries quite quickly, but inadequate coverage is often a problem. Edible coating can be sprayed, which is especially useful to obtain a thinner and more uniform coat or if only one part or side of a product is to be coated [64]. This is the most popular method for coating whole fruits and vegetables, especially with the development of high-pressure spray applicators and air-atomizing systems. Overhead drip emitters can also deliver coating to fruits and brushes below. The fruits tumble over rotating brush beds that become saturated with coating from overhead spray or drip applicators. As the fruits tumble and rotate over the saturated brushes, they become uniformly covered with coating [211]. Controlled drop applicator allows drops of coating to be shattered in microdrops that coating are delivered through a spray. Freestanding films can be cast such that the thickness can be controlled by spreading or pouring. A spreader with adjustable height can be used to control the thickness of the film, which is then allowed to dry [64]. Pan coating of tablets and candies involves a pan, which is enclosed and perforated along the side panels. The coating is delivered by a pump to a spray gun(s) mounted in various parts of the pan. The coating is atomized by the spray guns [211]. Solutions of antioxidant, preservatives, or other aqueous materials can be applied by dip or spray. In most cases, fruit and vegetable products are sanitized with chlorine or *o*-phenylphenate (SOPP) and dried on brushes or with fans as much as possible prior to coating. Sanitizing solutions are covered in U.S. FDA 21 CFR 178.1010 [95].

Coating of breakfast cereal products usually involves sugar-based materials, which presents a difficult situation since sugar is hydrophilic. With minimal water as solvent, sugar is heated to a hard candy condition and sprayed on cereal, which is further heated to fuse the sugar. Otherwise, sugar is spun into a blanket on which cereal pieces are placed prior to application of a second blanket of sugar. The whole sugar/cereal sandwich is then compressed and dried [16].

---

## 21.8 Reported Applications in Foods

### 21.8.1 Fresh Intact Fruits and Vegetables

Edible coatings have been applied to a diverse array of whole fruits and vegetables since the 1930s and 1940s [15]. Coatings of vegetable or mineral oil have been applied to tropical fruits (mango, pineapple, banana, papaya, guava, and avocado) with varying degrees of benefit in terms of extending shelf life [212–215]. Sometimes, oils, such as mineral oil, are used alone to coat fruits such as tomatoes or limes, but in such cases they remain in a liquid state as a thin film on the surface of the fruit. The purpose of coating these fruits with oils is to help them slip over equipment (lubricant); add a slight sheen; and delay ripening, weight (water) loss, and yellowing in the case of limes [15,86,216,217]. Use of a cellulose-based film reduced the number of viable *Salmonella montevideo* cells on the surface of tomatoes in addition to retarding the ripening process [218]. Casein–lipid coatings reduced moisture loss from citrus, apple, and zucchini [65]. Shellac, carnauba wax, and polyethylene wax retard moisture loss and add shine to apples, citrus, and other fruits [15]. Waxing of potatoes with paraffin wax did not adversely affect respiration, but it did reduce sprouting and synthesis of chlorophyll (green pigment) and solanine (toxic glycoalkaloid) [219]. The Tweens' lecithin and hydroxylated lecithin surfactants, and applied films were also useful in inhibiting chlorophyll and solanine synthesis in the peel of potato tubers [220,221]. Creation of an MA within the coated potatoes may have inhibited greening due to an effect on the synthesis of these undesirable compounds. In contrast, lipid and hydrocolloid coatings inhibited degreening of lemons and limes [217] probably by inhibiting chlorophyll breakdown due to an MA. The MA induced by coatings can also be useful in retarding ripening as demonstrated with zein or chitosan on tomato [93,137] and cellulose on mango and tomato [173].

### 21.8.2 Lightly Processed Fruits and Vegetables, Dried Fruit, and Nut Products

Coating of lightly processed fruits and vegetables is a new field [79,85,222], while coatings have been reported on nut and dried fruit products since the 1940s and 1950s [223]. Casein–lipid coatings reduced moisture loss [65], and a cellulose coating inhibited surface drying and the resulting color change (whitening) of peeled carrots [47,224,225]. There have been several reports of coatings applied to cut apple. Dextrin coatings prevented oxidative browning of apple slices [141], while a cellulose coating with antioxidants reduced cut apple discoloration more effectively than a solution of antioxidants alone [41]. A chitosan/lauric acid coating inhibited browning of cut apple [226], while caseinate-lipid coatings reduced moisture loss [70] and an alginate–casein–lipid coating reduced water loss and browning of cut apple [79]. A bilayer coating of polysaccharide and lipid decreased water loss, respiration, and ethylene production in cut apple [227]. Pectin coatings were used to coat almonds and reportedly held salt and antioxidants on the surface while providing a nonoily texture [39]. Coating nuts with hydrogenated oils or acetylated monoglyceride containing an antioxidant increased their shelf life by retarding development of oxidative rancidity [40,228]. Gum arabic has also been used to coat pecans [150]. Starch (amylose) and whey protein isolate coatings were used to reduce oxidative rancidity during storage of certain products such as nuts, cereal, beans [228–231], candies, and dried fruits [228]. This can also be controlled with antioxidants such as TBHQ alone or in a coating, as was shown for peanuts [40]. For coated candied fruit and dates, pectin coatings reduced stickiness [39]. Acetylated monoglycerides, hydrogenated coconut oil, or confectioner's butter-stabilized dried fruit pieces in cake or bread mix [232] and raisins in cereals [233,234]. Mineral oil, beeswax, vegetable oils, and acetylated monoglycerides have also been used to reduce clumping and stickiness of raisin products [233–237]. Vegetable oil blends as coatings for dried fruit have poor flavor stability [238]. Two commercial products, Spraygum® and Sealgum® (Colloides Naturels Inc., Bridgewater, NJ), are based on gum acacia and gelatin. These products have been used to coat chocolates, nuts, cheese, and pharmaceutical products. In addition, they reduced darkening of potatoes in combination with CaCl<sub>2</sub> [34].

### 21.8.3 Processed Food and Animal Products

Edible coatings are also applied to processed foods to restrict the movement of moisture and gases, especially O<sub>2</sub>. Edible coatings can be used to prevent moisture loss and absorption or transfer between components of differing water activity [16]. Edible coatings protect some commodities, such as meat and nut products, from oxidative rancidity, fat absorption, breading loss during frying [239,240], and oil migration from such products as chocolate using hydrocolloids [241]. Amylose coatings provided a non-sticky surface at RH < 80%, prevented fat migration from cheese and chocolate products, and retained volatile flavors [228]. Nonedible wax coatings are used to encase some cheese products [89,242]. Meat fats; vegetable oils; and acetylated monoglycerides; mono-, di-, and triglycerides; waxes; and mixtures of these components have been used to coat meats and meat products, including frozen chicken pieces and pork chops [239,243]. These coatings protected the meat products from dehydration [16]. Cornstarch–alginate coatings reduced moisture loss and improved juiciness of coated meat products [140], while HPC films reduced moisture loss from chicken [244]. Gelatin coatings have been used to coat or wrap meats [112] and form soft capsules in the pharmaceutical industry. Casein–lipid coatings reduced moisture loss from chicken eggs [65]. Emulsions of oil, water, and sugar have been used to coat cereal products to limit the entrance of water and therefore the amount of drying required [245]. Candies are sometimes coated with chocolate for flavor and reduction of moisture loss [246] or carnauba wax to add shine and reduce stickiness [16]. Corn zein and the derivatives MC and HPMC are oil repellent and reduced oil absorption for potato balls or meat when included in batters or when applied as coatings [125,244,247]. These compounds also improved adhesion of batters or coatings to food products [124]. Coatings can delay the uptake of liquid by dry cereal products so that they last longer in milk before becoming soggy [229]. Such coatings often have a sugar base to impart a sweet flavor [16].

Heterogeneous products of differing water activities, such as ice cream cones with ice cream, or frozen filled pies where a dry material is in contact with a moist filling, have shown benefit from a barrier film between the two components. Such films had a polysaccharide component in a bilayer system with palmitic or stearic acid or saturated C<sub>16</sub> and C<sub>18</sub> fatty acids and beeswax [72,74]. For example, a lipid–cellulose coating showed promise as a barrier to internal moisture migration between two components of a bread tomato sauce product [71,72].

---

## 21.9 Legal Aspects

The various coating components discussed thus far in this review reflect rulings by the U.S. FDA. The United States allows coating of fresh produce with restrictions as to what can be used as a coating material or ingredient and, in some cases, the type of produce (usually dependent on whether the coated fruit or vegetable peel is normally consumed or not, i.e., apple versus avocado). Other countries, however, do not allow coating of fruits and vegetables at all. For example, a ban has been reported in Norway on imports of waxed fruit. The Norwegian policy is that foods making significant nutritional contributions to the diet should be as free from additives as possible [248]. The German government tried to ban waxed apples, but the European Commission overruled them with a directive that allows apples, pears, and some other products to be imported from countries where waxing or coating of fruit is legal as long as the formulations contain beeswax, candelilla wax, carnauba wax, and shellac. Japan accepts shellac- and carnauba wax-coated citrus from the United States, but will not accept fruit coated with petroleum-based waxes that are legal in the United States for certain fruits, including citrus. The use of the cellulose derivative HPC is allowed in coating formulations in the United States, but not in New Zealand. Other countries such as Thailand and Australia are evaluating the applicability and acceptability of various coating film formers and additives [249,250].

The U.S. FDA ruled in 1993 that all waxed fruits must be subjected to ingredient labeling regulations at the retail level [251]. Retailers are permitted to use collective names for coating ingredients, however, which should be prominently visible in the retail area where the commodity is displayed. The label or sign should indicate that the commodity is waxed or coated with food-grade animal-, vegetable-, petroleum-, beeswax-, and shellac-based wax or resin to maintain freshness [250]. The United Kingdom proposed



a similar labeling scheme requiring labels indicating all postharvest treatments applied to fresh produce [251]. Processed foods in the United States are required to contain a label on the package listing all additives. Coatings, preservatives, and antioxidants are all considered to be additives and, therefore, must be listed as individual ingredients. Postharvest use of fungicides, however, is not required to be labeled in the United States.

---

### 21.10 Consumer Attitudes

Consumers are becoming increasingly educated about health and nutrition and are concerned about what goes on or into their food. Some consumer groups are concerned with the waxes and coatings themselves, and others fear that, in the case of fresh produce, harmful pesticide residues may be sealed inside the fruits by the coatings. There is also the issue of the use of animal products in coatings. Although there is a federal law in the United States about labeling coated produce, it is not always enforced. This presents a problem for Muslims, vegetarians, and Orthodox Jews, who have concerns about animal-derived products, and for those with certain protein allergies and intolerances. Enforcement of the regulations described in the previous section requiring a conspicuous sign would allow consumers to make an informed choice. Nevertheless, the main reason for coating produce such as apples and citrus is cosmetic. The fact remains that coated (shiny) fruit sell better than uncoated ones [252]. Some consumer groups want postharvest fungicide treatments to be listed as well as coating types [253].

In conclusion, edible coatings alone or as carriers of useful additives serve many functions for all types of food products. They improve the external and internal quality characteristics of diverse commodities. Coatings can reduce dehydration and oxidation as well as the resulting undesirable changes in color, flavor, and texture. Waxes and other coatings delay ripening and senescence of fresh produce and can increase the microbial stability of lightly processed fruits, vegetables, and some processed products. Coatings show promise as environment-friendly quarantine treatments. Most coating materials are produced from renewable, edible resources and can even be manufactured from waste products that represent disposal problems for other industries.

---

### References

1. R. E. Hardenburg, Wax and related coatings of horticultural products. A bibliography, *Agric. Res. Bull. No. 965*, Cornell University, Ithaca, NY, 1967, p. 1.
2. T. Labuza and R. Contreras-Medellin, Prediction of moisture protection requirements for foods, *Cereal Food World* 26: 335 (1981).
3. H. J. Kaplan, Washing, waxing and color adding, *Fresh Citrus Fruits* (W. F. Wardowski, S. Nagy, and W. Grierson, eds.), AVI Publishing Co., Westport, CT, 1986, p. 379.
4. S. A. Trout, E. G. Hall, and S. M. Sykes, Effects of skin coatings on the behavior of apples in storage, *Aust. J. Agric. Res.* 4: 57 (1953).
5. C. W. Hitz and I. C. Haut, Effects of waxing and pre-storage treatments upon prolonging the edible storage qualities of apples, *Univ. MD Agric. Exp. Sta. Tech. Bull. No. A14*, 1942.
6. L. L. Claypool, The waxing of deciduous fruits, *Am. Soc. Hort. Sci. Proc.* 37: 443 (1940).
7. D. V. Fisher and J. E. Britton, Apple waxing experiments, *Sci. Agric.* 21: 70 (1940).
8. H. Platenius, Wax emulsions for vegetables, *Cornell Univ. Agric. Exp. Stn. Bull. No. 723*, 1939.
9. R. M. Smock, Certain effects of wax treatments on various varieties of apples and pears, *Proc. Am. Soc. Hort. Sci.* 33: 284 (1935).
10. S. K. Williams, J. L. Oblinger, and R. L. West, Evaluation of a calcium alginate film for use on beef cuts, *J. Food Sci.* 43: 292 (1978).
11. C. R. Lazarus, R. L. West, J. L. Oblinger, and A. Z. Palmer, Evaluation of a calcium alginate coating and a protective plastic wrapping for the control of lamb carcass shrinkage, *J. Food Sci.* 41: 639 (1976).
12. R. D. Earl, Method of preserving foods by coating same, U.S. patent 3,395,024, 1968.
13. M. E. Zabik and L. E. Dawson, The acceptability of cooked poultry protected by an edible acetylated monoglyceride coating during fresh and frozen storage, *Food Technol.* 17: 87 (1963).

14. R. C. Meyer, A. R. Winter, and H. H. Weiser, Edible protective coatings for extending the shelf life of poultry, *Food Technol.* 12: 146 (1959).
15. E. A. Baldwin, Edible coatings for fresh fruits and vegetables: past, present, and future, *Edible Coatings and Films to Improve Food Quality* (J. M. Krochta, E. A. Baldwin, and M. O. Nisperos-Carriedo, eds.), Technomic Publishing Company, Lancaster, PA, 1994, p. 25.
16. R. A. Baker, E. A. Baldwin, and M. O. Nisperos-Carriedo, Edible coatings and films for processed foods, *Edible Coatings and Films to Improve Food Quality* (J. M. Krochta, E. A. Baldwin, and M. O. Nisperos-Carriedo, eds.), Technomic Publishing Company, Lancaster, PA, 1994, p. 89.
17. G. M. Sapers, Browning of foods: control by sulfates, antioxidants, and other means, *Food Technol.* 47: 75 (1993).
18. E. R. Sherwin, *Antioxidants, Food Additives* (A. L. Branen, P. M. Davidson, and S. Salminen, eds.), Marcel Dekker, New York, 1990, p. 139.
19. J. D. Ponting, R. Jackson, and G. Watters, Refrigerated apple slices: preservative effects of ascorbic acid, calcium and sulfites, *J. Food Sci.* 37: 434 (1972).
20. G. M. Sapers and F. W. Douglas, Measurement of enzymatic browning at cut surfaces and in juice of raw apple and pear fruits, *J. Food Sci.* 52: 1258 (1987).
21. G. M. Sapers, K. B. Hicks, J. G. Phillips, L. Garzarella, D. L. Pondish, R. M. Matulaitis, T. H. McCormack, S. M. Sondey, P. A. Seib, and Y. S. El-Atawy, Control of enzymatic browning in apple with ascorbic acid derivatives, polyphenol oxidase inhibitors, and complexing agents, *J. Food Sci.* 54: 997 (1989).
22. A. Monsalve-Gonzalez, G. V. Barbosa-Canovas, A. J. McEvily, and R. Iyengar, Inhibition of enzymatic browning in apple products by 4-hexylresorcinol, *Food Technol.* 49: 110–118 (1995).
23. L. Giannuzzi, A. M. Lambardi, and N. E. Zaritzky, Diffusion of citric and ascorbic acids in prepeeled potatoes and their influence on microbial growth during refrigerated storage, *J. Sci. Food Agric.* 68: 311 (1995).
24. G. M. Sapers and R. L. Miller, Heated ascorbic/citric acid solution as browning inhibitor for prepeeled potatoes, *J. Food Sci.* 60: 762 (1995).
25. R. Noble and K. S. Burton, Postharvest storage and handling of mushrooms: physiology and technology, *Postharvest News Info.* 4: 125 (1993).
26. G. M. Sapers, R. L. Miller, F. C. Miller, P. H. Cooke, and S. Choi, Enzymatic browning control in minimally processed mushrooms, *J. Food Sci.* 59: 1042 (1994).
27. P. S. Taoukis, T. P. Labuza, J. H. Lillemo, and S. W. Lin, Inhibition of shrimp melanosis (black spot) by ficin, *Lebensm. Wiss. Technol.* 23: 52 (1990).
28. A. J. McEvily, R. Iyengar, and S. Otwell, Sulfite alternative prevents shrimp melanosis, *Food Technol.* 45: 80 (1991).
29. D. H. Wasson, K. D. Reppond, and T. M. Kandianis, Antioxidants to preserve rockfish color, *J. Food Sci.* 56: 1564 (1991).
30. J. W. Eckert and J. M. Ogawa, The chemical control of postharvest diseases: subtropical and tropical fruits, *Ann. Rev. Phytopathol.* 23: 421 (1985).
31. B. W. Poovaiah, Role of calcium in prolonging storage life of fruits and vegetables, *Food Technol.* 40: 84 (1986).
32. C. Y. Wang, W. S. Conway, J. A. Abbott, G. F. Kramer, and C. E. Sams, Postharvest infiltration of polyamines and calcium influences ethylene production and texture changes in 'Golden Delicious' apples, *J. Am. Soc. Hort. Sci.* 118: 801 (1993).
33. E. J. Hanson, J. L. Beggs, and R. M. Beaudry, Applying calcium chloride postharvest to improve high-bush blueberry firmness, *HortScience* 28: 1033 (1993).
34. G. Mazza and H. Qi, Control of after-cooking darkening in potatoes with edible film-forming products and calcium chloride, *J. Agric. Food Chem.* 39: 2163 (1991).
35. W. S. Conway, C. E. Sams, and A. Kelman, Enhancing the natural resistance of plant tissues to postharvest diseases through calcium applications, *HortScience* 29: 751 (1994).
36. P. M. Davidson and V. K. Juneja, Antimicrobial agents, *Food Additives* (A. L. Branen, P. M. Davidson, and S. Salminen, eds.), Marcel Dekker, New York, 1990, p. 83.
37. S. Doores, pH control agents and acidulants, *Food Additives* (A. L. Branen, P. M. Davidson, and S. Salminen, eds.), Marcel Dekker, New York, 1990, p. 477.
38. C. Andres, Natural edible coating has excellent moisture and grease barrier properties, *Food Proc.* (Dec): 48 (1984).
39. H. A. Swenson, J. C. Miers, T. H. Schultz, and H. S. Owens, Pectinase and pectate coatings. II. Application to nut and fruit products, *Food Technol.* 7: 232 (1953).

40. M. W. Hoover and P. J. Nathan, Influence of tertiary butylhydroquinone and certain other surface coatings on the formation of carbonyl compounds in granulated roasted peanuts, *J. Food Sci.* 47: 246 (1981).
41. E. A. Baldwin, M. O. Nisperos, X. Chen, and R. D. Hagenmaier, Improving storage life of cut apple and potato with edible coating, *Postharvest Biol. Technol.* 9:151–163 (1996).
42. S. Guilbert, Use of superficial edible layer to protect intermediate moisture foods: application to the protection of tropical fruit dehydrated by osmosis, *Properties of Water in Foods* (C. C. Seow, ed.), Elsevier Applied Science Publishers, London, 1988, p. 119.
43. J. A. Torres, Sorbic acid stability during processing of an intermediate moisture cheese analog, *J. Food Proc. Pres.* 13: 409 (1989).
44. J. A. Torres and M. Karel, Microbial stabilization of intermediate moisture food surfaces. III. Effects of surface preservative concentration and surface pH control on microbial stability of an intermediate moisture cheese analog, *J. Food Proc. Pres.* 9: 107 (1985).
45. F. Vojdani and J. A. Torres, Potassium sorbate permeability of polysaccharide films, chitosan, methyl cellulose and hydroxy propyl methyl cellulose, *J. Food Proc.* 12: 33 (1989).
46. F. Vojdani and J. A. Torres, Potassium sorbate permeability of methyl cellulose and hydroxy propyl methyl cellulose coatings: effects of fatty acids, *J. Food Sci.* 55: 941 (1990).
47. S. A. Sargent, J. K. Brecht, J. J. Zoellner, E. A. Baldwin, and C. A. Campbell, Edible films reduce surface drying of peeled carrots, *Proc. Fla. State Hort. Soc.* 107: 245 (1994).
48. J. M. Wells, Heated wax-emulsions with benomyl and 2,6-dichloro-4-nitroaniline for control of postharvest decay of peaches and nectarines, *Phytopathology* 62: 129 (1971).
49. J. M. Wells and L. G. Reaver, Hydrocooling peaches after waxing: effects on fungicide residues, decay development and moisture loss, *HortScience* 11: 107 (1976).
50. G. E. Brown, Benomyl residues in Valencia oranges from postharvest applications containing emulsified oil, *Phytopathology* 64: 539 (1974).
51. J. W. Eckert and M. J. Kolbezen, Influence of formulation and application method on the effectiveness of benzimidazole fungicides for controlling postharvest diseases of citrus fruits, *Neth. J. Plant Path.* 83(suppl.): 343 (1977).
52. G. E. Brown, S. Nagy, and M. Maraulia, Residues from postharvest nonrecovert spray applications of imazalil to oranges and effects on green mold caused by *Penicillium digitatum*, *Plant Dis.* 67: 954 (1983).
53. G. E. Brown, Efficacy of citrus postharvest fungicides applied in water or resin solution water wax, *Plant Dis.* 68: 415 (1984).
54. H. M. Couey and G. Farias, Control of postharvest decay of papaya, *HortScience* 14: 719 (1979).
55. A. E. Ghaouth, J. Arul, R. Ponnampalam, and M. Boulet, Chitosan coating effect on storability and quality of fresh strawberries, *J. Food Sci.* 56: 1618 (1991).
56. G. A. Reineccius, Flavor encapsulation, *Edible Coatings and Films to Improve Food Quality* (J. M. Krochta, E. A. Baldwin, and M. O. Nisperos-Carriedo, eds.), Technomic Publishing Company, Lancaster, PA, 1994, p. 105.
57. M. O. Nisperos-Carriedo, P. E. Shaw, and E. A. Baldwin, Changes in volatile flavor components of Pineapple orange juice as influenced by the application of lipid and composite film, *J. Agric. Food Chem.* 38: 1382 (1990).
58. K. L. Nelson and O. W. Fennema, Methyl cellulose films to prevent lipid migration in confectionery products, *J. Food Sci.* 56: 504 (1991).
59. I. S. Saguy and E. J. Pinthus, Oil uptake dairying deep-fat frying: factors and mechanism, *Food Technol.* 49: 142 (1995).
60. S. L. Kamper and O. Fennema, Water vapor permeability of edible bilayer films, *J. Food Sci.* 49: 1478 (1984).
61. S. L. Kamper and O. Fennema, Use of an edible film to maintain water vapor gradients in foods, *J. Food Sci.* 50: 382 (1985).
62. S. L. Cuppett, Edible coatings as carriers of food additives, fungicides and natural antagonists, *Edible Coatings and Films to Improve Food Quality* (J. M. Krochta, E. A. Baldwin, and M. O. Nisperos-Carriedo, eds.), Technomic Publishing Company, Lancaster, PA, 1994, p. 121.
63. W. M. Mellenthin, P. M. Chen, and D. M. Borgic, In-line application of porous wax coating materials to reduce friction discoloration of 'Bartlett' and 'd'Anjou' pears, *HortScience* 17: 215–217 (1982).
64. G. Donhowe and O. Fennema, Edible films and coatings: characteristics, formation, definitions and testing methods, *Edible Coatings and Films to Improve Food Quality* (J. M. Krochta, E. A. Baldwin, and M. O. Nisperos-Carriedo, eds.), Technomic Publishing Company, Lancaster, PA, 1994, p. 1.

65. T. H. McHugh and J. M. Krochta, Milk-protein-based edible films and coatings, *Food Technol.* 48: 97 (1994).
66. I. G. Donhowe and O. Fennema, The effect of relative humidity gradient on water vapor, permeance of lipid and lipid-hydrocolloid bilayer films, *JAOCS* 69: 1081(1992).
67. H. J. Park, C. L. Weller, P. J. Vergano, and R. F. Testin, Permeability and mechanical properties of cellulose-based edible films, *J. Food Sci.* 58: 1361(1993).
68. A. Gennadios, C. L. Weller, and R. F. Testin, Temperature effect on oxygen permeability of edible protein-based films, *J. Food Sci.* 58: 212 (1993).
69. E. Hernandez, Edible coatings from lipids and resins, *Edible Coatings and Films to Improve Food Quality* (J. M. Krochta, E. A. Baldwin, and M. O. Nisperos-Carriedo, eds.), Technomic Publishing Company, Lancaster, PA, 1994, p. 279.
70. R. J. Avena-Bustillos and J. M. Krochta, Water vapor permeability of caseinate-based edible films as affected by pH, calcium cross linking and lipid content, *J. Food Sci.* 58: 904 (1993).
71. J. J. Kester and O. Fennema, An edible film of lipids and cellulose ethers: barrier properties to moisture vapor transmission and structural evaluation, *J. Food Sci.* 54: 1384 (1989).
72. J. J. Kester and O. Fennema, An edible film of lipids and cellulose ethers: performance in a model frozen-food system, *J. Food Sci.* 54: 1390 (1989).
73. D. W. S. Wong, F. A. Gastineau, K. S. Gregorski, S. L. Tillin, and A. E. Pavlath, Chitosanlipid films: microstructure and surface energy, *J. Agric. Food Chem.* 40: 540 (1992).
74. S. L. Kamper and O. Fennema, Water vapor permeability of an edible, fatty acid, bilayer film, *J. Food Sci.* 49: 1482 (1984).
75. ASTM, Standard test methods for water vapor transmission of materials, *ASTM Book of Standards*, E96-80, Philadelphia, PA, 1980.
76. R. H. Wills, T. H. Lee, D. Graham, W. B. McGlasson, and E. G. Hall, *Postharvest, An Introduction to the Physiology and Handling of Fruits and Vegetables*, AVI Publishing Co., Westport, CT, 1981.
77. A. A. Kader, Biochemical and physiological basis for effects of controlled and modified atmospheres on fruits and vegetables, *Food Technol.* 40: 99 (1986).
78. J. L. Woods, Moisture loss from fruits and vegetables, *Postharvest News Info.* 1: 195 (1990).
79. D. W. S. Wong, M. W. Camarind, and A. E. Pavlath, Development of edible coatings for minimally processed fruits and vegetables, *Edible Coatings and Films to Improve Food Quality* (J. M. Krochta, E. A. Baldwin, and M. O. Nisperos-Carriedo, eds.), Technomic Publishing Company, Lancaster, PA, 1994, p. 65.
80. E. A. Baldwin, M. O. Nisperos-Carriedo, and R. A. Baker, Edible coatings for lightly processed fruits and vegetables, *HortScience* 30: 35 (1995).
81. E. A. Baldwin, M. O. Nisperos-Carriedo, and R. A. Baker, Use of edible coatings to preserve quality of lightly (and slightly) processed products, *Crit. Rev. Food Sci. Nutr.* 35: 50 (1995).
82. R. F. MacLeod, R. A. Kader, and L. L. Morris, Stimulation of ethylene and CO<sub>2</sub> production of mature-green tomatoes by impact bruising, *HortScience* 11: 604 (1976).
83. T. Boller and H. Kende, Regulation of wound ethylene synthesis in plants, *Nature* 286: 259 (1980).
84. N. E. Hoffman and S. F. Yang, Enhancement of wound-induced ethylene synthesis by ethylene in preclimacteric cantaloupe, *Plant Physiol.* 69: 317 (1982).
85. S. Guilbert, N. Gontard, and L. G. M. Gorris, Prolongation of the shelf-life of perishable food products using biodegradable films and coatings, *Lebensm. Wiss. Technol.* 29: 10 (1996).
86. J. Hartman and F. M. Isenberg, Waxing vegetables, *New York Agric. Extent. Ser. Bull. No. 965*, 1956, p. 3.
87. R. G. McGuire and E. A. Baldwin, Compositions of cellulose coatings affect populations of yeasts in the liquid formulation and on coated grapefruits, *Proc. Flo. State Hort. Soc.*, 107: 293 (1994).
88. J. Waks, M. Schiffmann-Nadel, E. Lomaniec, and E. Chalutz, Relation between fruit waxing and development of rots in citrus fruit during storage, *Plant Dis.* 62: 869 (1985).
89. N. N. Potter, *Food Science*, AVI Publishing Co., Westport, CT, 1986, p. 372.
90. R. D. Hagenmaier and R. A. Baker, Internal gases, ethanol content and gloss of citrus fruit coated with polyethylene wax, carnauba wax, shellac or resin at different application levels, *Proc. Flo. State Hort. Soc.* 107: 261 (1994).
91. R. D. Hagenmaier and R. A. Baker, Layered coatings to control weight loss and preserve gloss of citrus fruit, *HortScience* 30: 296 (1995).
92. H. B. Cosler, Method of producing zein-coated confectionery, U.S. patent 2,791,509 (1957).
93. J. J. Park, M. S. Chinnan, and R. L. Shewfelt, Edible coating effects on storage life and quality of tomatoes, *J. Food Sci.* 59: 568 (1994).

94. R. D. Hagenmaier and R. A. Baker, Edible coatings from candelilla wax microemulsions, *J. Food Sci.* 61: 562 (1996).
95. U.S. FDA, Code of Federal Regulations 21: Parts 1–99 (1966).
96. J. J. Kester and O. Fennema, Tempering influence on oxygen and water vapor transmission through a stearyl alcohol film, *JAOCs* 66: 1154 (1989).
97. J. J. Kester and O. Fennema, Resistance of lipid films to oxygen transmission, *JAOCs* 66: 1130 (1989).
98. J. J. Kester and O. Fennema, Resistance of lipid films to water vapor transmission, *JAOCs* 8: 1139 (1989).
99. M. Martin-Polo, A. Voilley, G. Blond, B. Colas, M. Mesnier, and N. Floquet, Hydrophobic films and their efficiency against moisture transfer. 2. Influence of the physical state, *J. Agric. Food Chem.* 40: 413 (1992).
100. R. O. Feuge, Acetoglycerides—new fat products of potential value to the food industry, *Food Technol.* 9: 314 (1955).
101. N. V. Lovegren and R. O. Feuge, Permeability of acetostearin products to water vapor, *Agric. Food Chem.* 2: 558 (1954).
102. J. J. Kester and O. R. Fennema, Edible films and coatings: a review, *Food Technol.* 40: 47 (1986).
103. H. Bennett, *Industrial Waxes*, Vol. 1, Chemical Pub. Co., New York, 1975.
104. Eastman Chemicals, Water-emulsion fruit and vegetable coatings based on EPOLENE® waxes, Pub. No. F-257B, August 1986.
105. R. D. Hagenmaier and P. E. Shaw, Permeability of shellac coatings to gases and water vapor, *J. Agric. Food Chem.* 39: 825 (1991).
106. E. Hernandez and R. A. Baker, Candelilla wax emulsion, preparation and stability, *J. Food Sci.* 56: 1382 (1991).
107. W. C. Griffin, Emulsions, *Kirk-Othmer Encyclopedia of Chemical Technology*, 3rd ed., Vol. 8, 1979, p. 913.
108. R. D. Hagenmaier and P. E. Shaw, Gas permeability of fruit coating waxes, *J. Am. Soc. Hort. Sci.* 117: 105 (1992).
109. Nevill Chemical Co., Production information, resins, plasticizer, nonstaining antioxidants and chlorinated paraffins, Brochure No. NCCFA188, 1988, p. 1.
110. D. J. Hall, Innovations in citrus waxing—an overview, *Proc. Flo. State Hort. Soc.* 94: 258 (1981).
111. S. R. Drake, J. K. Fellman, and J. W. Nelson, Postharvest use of sucrose polymers for extending the shelf-life of stored golden delicious apples, *J. Food Sci.* 52: 1283 (1987).
112. A. Gennadios, T. H. McHugh, C. L. Welter, and J. M. Krochta, Edible coatings and films based on proteins, *Edible Coatings and Films to Improve Food Quality* (J. M. Krochta, E. A. Baldwin, and M. O. Nisperos-Carriedo, eds.), Technomic Publishing Company, Lancaster, PA, 1994, p. 201.
113. A. Gennadios, A. H. Brandenburg, C. L. Weller, and R. F. Testin, Effect of pH on properties of wheat gluten and soy protein isolate films, *J. Agric. Food Chem.* 41: 1835 (1993).
114. A. H. Brandenburg, C. L. Weller, and R. G. Testin, Edible films and coatings from soy protein, *J. Food Sci.* 58: 1086 (1993).
115. J. R. Maynes and J. M. Krochta, Properties of edible films from total milk protein, *J. Food Sci.* 59: 909 (1994).
116. J. M. Krochta, A. E. Pavlath, and N. Goodman, Edible films from casein–lipid emulsions for lightly-processed fruits and vegetables, *Engineering and Food, Vol. 2, Preservation Processes and Related Techniques* (W. E. Spiess and H. Schuberts, eds.), Elsevier, New York, 1990, p. 329.
117. N. Parris, D. R. Coffin, R. F. Joubran, and H. Pessen, Composition factors affecting the water vapor permeability and tensile properties of hydrophilic films, *J. Agric. Food Chem.* 43: 1432 (1995).
118. S. Guilbert, Use of superficial edible layer to protect intermediate moisture foods: application to protection of tropical fruits dehydrated by osmosis, *Food Preservation and Moisture Control* (C. C. Seow, ed.), Elsevier Applied Science Pub., Let., Essex, UK, 1988, p. 199.
119. A. Gennadios and C. L. Weller, Edible films and coatings from wheat and corn proteins, *Food Technol.* 44: 63 (1990).
120. Y. M. Stuchell and J. M. Krochta, Enzymatic treatments and thermal effects on edible soy protein films, *J. Food Sci.* 59: 1332 (1994).
121. A. Jangchud and M. S. Chinnan, Peanut protein film as affected by drying temperature and pH of film forming solution, *J. Food Sci.* 64: 153 (1999).
122. S. Okamoto, Factors affecting protein film formation, *Cereal Sci. Today* 25: 256 (1978).
123. A. Gennadios and C. L. Weller, Edible films and coatings from soymilk and soy protein, *Cereal Food World* 36: 1004 (1991).

124. A. J. Ganz, Cellulose hydrocolloids, *Food Colloids* (H. P. Graham, ed.), AVI Pub. Co., Westport, CT, 1977, p. 383.
125. G. R. Sanderson, Polysaccharides in foods, *Food Technol.* 35: 50, 83 (1981).
126. M. S. Chinnan and H. J. Park, Effect of plasticizer level and temperature on water vapor transmission of cellulose-based edible films, *J. Food Proc. Eng.* 18: 417 (1995).
127. R. A. Kent, R. S. Stephens, and J. A. Westland, Bacterial cellulose fiber provides an alternative for thickening and coating, *Food Technol.* 45: 108 (1991).
128. G. O. Aspinall, *Polysaccharides*, Pergamon Press, Oxford, UK, 1970.
129. M. O. Nisperos-Carriedo, Edible coatings and films based on polysaccharides, *Edible Coatings and Films to Improve Food Quality* (J. M. Krochta, E. A. Baldwin, and M. O. Nisperos-Carriedo, eds.), Technomic Publishing Company, Lancaster, PA, 1994, p. 305.
130. T. H. Schultz, J. C. Miers, H. S. Owens, and W. D. Maclay, Permeability of pectinase films to water vapor, *J. Phys. Colloid. Chem.* 53: 1320 (1949).
131. T. H. Schultz, H. S. Owens, and W. D. Maclay, Pectinase films, *J. Colloid. Sci.* 53: 53 (1948).
132. J. C. Miers, H. A. Swenson, T. H. Schultz, and H. S. Owens, Pectinase and pectate coatings. I. General requirements and procedures, *Food Technol.* 7: 229 (1953).
133. General news: Chitosan-derivative keeps apples fresh, *Postharvest News Info.* 2: 75 (1991).
134. M. Walker-Simmons, D. Jin, C. A. West, L. Hadwiger, and C. A. Rayan, Comparison of proteinase inhibitor-inducing activities and phytoalexin elicitor activities of a pure fungal endopolygalacturonase, pectic fragments, and chitosans, *Plant Physiol.* 76: 833 (1984).
135. P. Stossel and J. L. Leuba, Effect of chitosan, chitin and some aminosugars on growth of various soil-borne phytopathogenic fungi, *Phytopathol. Z.* 111: 82 (1984).
136. C. M. Elson and E. R. Hayes, Development of the differentially permeable fruit coating "NutriSave<sup>®</sup>" for modified atmosphere storage of fruit, *Controlled Atmosphere for Storage and Transport of Perishable Agricultural Commodities* (S. M. Blankenship, ed.), North Carolina State University, Raleigh, NC, 1985, p. 248.
137. A. El Gaouth, R. Pannampalam, F. Castaigne, and J. Arul, Chitosan coating to extend the storage life of tomatoes, *HortScience* 27: 1016 (1992).
138. Y. C. Chung, H. L. Wang, Y. M. Chen, and S. L. Li, Effect of abiotic factors on the antibacterial activity of chitosan against waterborne pathogens. *Bioresource Technol.* 88: 179–184 (2003).
139. J. C. Rankin, I. A. Wolff, H. A. Davis, and C. E. Rist, Permeability of amylose film to moisture vapor, selected organic vapors, and the common gases, *Indus. Eng. Chem.* 3: 120 (1958).
140. L. Allen, A. I. Nelson, M. P. Steinberg, and J. N. McGill, Edible corn-carbohydrate food coatings. I. Development and physical testing of a starch-algin coating, *Food Technol.* 17: 1437 (1963).
141. D. G. Murray and L. R. Luft, Low-D. E. corn starch hydrolysates, *Food Technol.* 27: 32 (1973).
142. J. M. Valverde, D. Valero, D. Martínez-Romero, F. Guillén, S. Castillo, and M. Serrano, Novel edible coating based on *aloe vera* gel to maintain table grape quality and safety, *J. Agric. Food Chem.* 54: 3882–3886 (2005).
143. M. F. Esua and J. W. Rauwald, Novel bioactive maloyl glucans from *aloe vera* gel: isolation, structure elucidation and invitro bioassays, *Carbohydrate Res.* 27(3): 355–364 (2006).
144. B. Li, J. Peng, X. Yie, and B. Xie, Enhancing physical properties and antimicrobial activity of konjac glucomannan edible films by incorporating chitosan and nisin, *J. Food Sci.* 71: C174–C178 (2006).
145. E. R. Morris, D. A. Rees, and G. Robinson, Cation-specific aggregation of carrageenan helices: domain model of polymer gel structure, *J. Mol. Biol.* 138: 349 (1980).
146. R. L. Whistler and J. R. Daniel, Functions of polysaccharides in foods, *Food Additives*, (A. L. Branen, P. M. Davidson, and S. Salminen, eds.), Marcel Decker, New York, 1990, p. 395.
147. R. L. Whistler and J. N. BeMiller, *Industrial Gums, Polysaccharides and Their Derivatives*, 2nd ed., Academic Press, New York, 1973.
148. A. M. Prakash, M. Joseph, and M. E. Mangino, The effects of added proteins on the functionality of gum arabic in soft drink emulsion systems, *Food Hydrocoll.* 4: 177 (1990).
149. M. E. Osman, P. A. Williams, A. R. Menzies, and G. O. Phillips, Characterization of commercial samples of gum arabic, *J. Agric. Food Chem.* 41: 71 (1993).
150. F. W. Arnold, U.S. patent 3,383,220 (1963).
151. D. J. Pettitt, J. E. B. Wayne, J. J. Renner Nantz, and C. F. Showmaker, Rheological properties of solutions and emulsions stabilized with xanthan gum and propylene glycol alginate, *J. Food Sci.* 60: 528 (1995).

152. Kelco, Gellan gum—multifunctional gelling agent, Technical Bull., Merck and Co., Rahway, NJ, 1990.
153. E. Art, Emulsifiers, *Food Additives* (A. L. Branen, P. M. Davidson, and S. Salminen, eds.), Marcel Dekker, New York, 1990, p. 347.
154. C. L. Wilson and P. L. Pusey, Potential for biological control of postharvest plant diseases, *Plant Dis.* 69: 375 (1985).
155. J. A. Domenico, A. R. Raliman, and D. E. Wescott, Effects of fungicides in combination with hot water and wax on the shelf life of tomato fruit, *J. Food Sci.* 37: 957 (1972).
156. C. R. Little, H. J. Taylor, and F. McFarlane, Postharvest and storage factors affecting superficial scald and core flush of 'Granny smith' apples, *HortScience* 20: 1080 (1985).
157. B. L. Goulart, P. E. Hammer, K. B. Evensen, W. Janisiewicz, and F. Takeda, Pyrolnitrin, captan+benomyl, and high CO<sub>2</sub> enhance raspberry shelf life at 0 or 18°C, *J. Am. Soc. Hort. Sci.* 117: 265 (1992).
158. S. Droby, E. Chalutz, and C. L. Wilson, Antagonistic microorganisms as biological control agents of postharvest diseases of fruits and vegetables, *Postharvest News Info.* 2: 169 (1991).
159. M. E. Wisniewski and C. L. Wilson, Biological control of postharvest diseases of fruits and vegetables: recent advances, *HortScience* 27: 94 (1992).
160. R. Potjewijd, M. O. Nisperos, J. K. Bums, M. Parish, and E. A. Baldwin, Cellulose-based coatings as carriers for *Candida guilliermondii* and *Debaryomyces* sp. in reducing decay of oranges, *HortScience* 30: 1417 (1995).
161. R. G. McGuire and R. D. Hagenmaier, Shellac coatings for grapefruits that favor biological control of *Penicillium digitatum* by *Candida oleophila*, *Biol. Cont.* 7: 100 (1996).
162. J. A. Torres, J. O. Bouzas, and M. Karel, Microbial stabilization of intermediate moisture food surfaces. II. Control of surface pH, *J. Food Proc. Pres.* 9: 93 (1985).
163. D. C. Rico-Pena and J. A. Torres, Sorbic acid and potassium sorbate permeability of an edible methyl cellulose-palmitic acid film: water activity and pH effects, *J. Food Sci.*, 56: 497 (1991).
164. D. Prusky and N. T. Keen, Involvement of preformed antifungal compounds in the resistance of subtropical fruits to fungal decay, *Plant Dis.* 77: 114 (1993).
165. T. N. Misra, R. S., Singh, H. S. Pandey, C. Prasad, and F. P. Singh, Antifungal essential oil and a long chain alcohol from *Achyranthes aspera*, *Phytochemistry* 31: 1811(1992).
166. P. J. Delaquis and G. Mazza, Antimicrobial properties of isothiocyanates in food preservation, *Food Technol.* 49: 73 (1995).
167. F. Takeda, W. J. Janisiewicz, J. Toitman, N. Mahoney, and F. B. Abeles, Pyrolnitrin delays postharvest fruit rot in strawberries, *HortScience* 25: 320 (1990).
168. A. L. Snowden, Pome fruits, apples and pears, *A Color Atlas of Post-Harvest Diseases and Disorders of Fruits and Vegetables, Vol. 1: General Introduction and Fruits*, CRC Press, Boca Raton, FL, 1990, p. 170.
169. G. M. Sapers, R. L. Miller, F. W. Douglas Jr., and K. B. Hicks, Uptake and fate of ascorbic acid-2-phosphate in infiltrated fruit and vegetable tissue, *J. Food Sci.* 56: 419 (1991).
170. R. C. Richard, P. M. Goupy, J. J. Nicolas, J. Lacombe, and A. A. Pavia, Cysteine as an inhibitor of enzymatic browning. I. Isolation and characterization of addition compounds formed during oxidation of phenolics by apple polyphenol oxidase, *J. Agric. Food Chem.* 39: 841 (1991).
171. S. Lai, J. I. Gray, D. M. Smith, A. M. Booren, R. L. Crackel, and D. J. Buckley, Effects of oleoresin rosemary, tertiary butylhydroquinone, and sodium tripolyphosphate on the development of oxidative rancidity in restructured chicken nuggets, *J. Food Sci.* 56: 616 (1991).
172. E. N. Frankel, S. Huang, R. Aeschbach, and E. Prior, Antioxidant activity of a rosemary extract and its constituents, carnosic acid carnosol, and rosmarinic acid, in bulk oil and oil-in-water emulsion, *J. Agric. Food Chem.* 44: 131(1996).
173. M. O. Nisperos-Carriedo, E. A. Baldwin, and P. E. Shaw, Development of an edible coating for extending postharvest life of selected fruits and vegetables, *Proc. Flo. State Hort. Soc.* 104: 122 (1991).
174. B. Mitcham, H. Andris, and C. H. Crisosto, Apple disorders, *Perish. Handl. Newslett.* 86: 2 (1996).
175. J. Stow, Effect of calcium ions on apple fruit softening during storage and ripening, *Postharvest Biol. Technol.* 3: 1 (1993).
176. H. Javeri, R. Toledo and L. Wicker, Vacuum infusion of citrus pectinmethylsterase and calcium effects on firmness of peaches, *J. Food Sci.* 56: 739 (1991).
177. J. M. Garcia, S. Herrera, and A. Morilla, Effects of postharvest dips in calcium chloride on strawberry, *J. Agric. Food Chem.* 44: 30 (1996).
178. R. B. H. Wills, M. C. C. Yuen, M. Utami, and D. Utami, Effect of calcium infiltration on delayed ripening of Minyak avocado, *Asian Food J.* 4: 43 (1988).

179. A. Mootoo, Effect of post-harvest calcium chloride dips on ripening changes in 'Julie' mangoes, *Trop. Sci.* 31: 243 (1991).
180. B. P. Singh, D. K. Tandon, and S. K. Kaira, Changes in postharvest quality of mangoes affected by pre-harvest application of calcium salts, *Sci. Hort.* 54: 211 (1993).
181. W. S. Conway and C. E. Sams, Possible mechanisms by which postharvest calcium treatment reduces decay in apples, *Phytopathology* 74: 208 (1984).
182. D. Sugar, Enhanced resistance to postharvest decay in Bose pears treated with calcium chloride, *Acta Hort.* 256: 201 (1989).
183. R. B. H. Wills and M. S. Mahendra, Effect of postharvest application of calcium on ripening of peach, *Aust. J. Exp. Agric.* 29: 751 (1989).
184. R. J. McLaughlin, A review and current status of research on enhancement of biological control of postharvest diseases of fruits by use of calcium salts with yeasts, *Biological Control of Postharvest Diseases of Fruits and Vegetables* (C. L. Wilson and E. Chalutiz, eds.), Workshop Proceedings, U.S. Department of Agriculture, Agric. Res. Ser. ARS-92 1990, p. 184.
185. C. Chen, Methods for preserving fruits and vegetables. U.S. Patent 5,925,395, 1999.
186. J. P. Rupasinghe, D. P. Murr, J. R. Deell, and J. Odumeru, Influence of 1-methylcyclopropene and Natureseal on quality of fresh cut apples, *J. Food Qual.* 28: 289 (2005).
187. T. Ponappa, J. C. Scheerens, and A. R. Miller, Vacuum infiltration of polyamines increases firmness of strawberry slices under various storage conditions, *J. Food Sci.* 58: 361 (1993).
188. B. B. Lodh, S. De, S. K. Mukherjee, and A. W. Bose, Storage of mandarin oranges. I. Effects of hormones and wax coatings, *J. Food Sci.* 28: 519 (1963).
189. H. Subramanyam, N. V. Moorthy, V. B. Dalal, and H. C. Srivastava, Effect of a fungicidal wax coating with or without growth regulator on the storage behavior of mangoes, *Food Sci. (Mysore)* 11: 236 (1962).
190. E. C. Nnodu and S. O. Alozie, Using gibberellic acid to control sprouting of yam tubers, *Trop. Agric.* 68: 329 (1992).
191. D. K. Saulukhe and B. B. Desai, Citrus, *Postharvest Biology of Fruits and Vegetables*, Vol. I, CRC Press, Boca Raton, FL, 1986, p. 59.
192. C. F. Forney, R. E. Rij, R. Denis-Arrue, and J. L. Smilanick, Vapor phase hydrogen peroxide inhibits postharvest decay of table grapes, *HortScience* 26: 1512 (1991).
193. I. Avissar and E. Pesis, The control of postharvest decay in table grapes using acetaldehyde vapors, *Ann. Appl. Biol.* 118: 229 (1991).
194. D. L. Sholberg and A. P. Guance, Fumigation of fruit with acetic acid to prevent postharvest decay, *HortScience* 30: 1271 (1995).
195. A. L. Moys, P. L. Sholberg, and A. P. Guance, Modified-atmosphere packaging of grapes and strawberries fumigated with acetic acid, *HortScience* 31: 414 (1996).
196. C. Wilson, J. D. Franklin, and B. I. Otto, Fruit volatiles inhibitory to *Moniliniafructicola* and *Botrytis cinera*, *Plant Dis.* 71: 316 (1987).
197. B. Hardin, Natural compounds inhibit decay fungi, *Agric. Res.* (Sept): 21 (1993).
198. S. F. Vaughn, G. F. Spencer, and B. S. Shasha, Volatile compounds from raspberry and strawberry fruit inhibit postharvest decay fungi, *J. Food Sci.* 58: 793 (1993).
199. S. Vaughn and M. K. Ehlenfeldt, Natural volatile furan compounds inhibit blueberry and strawberry decay fungi, *Proc. 6th Intro. Cont. Atmos. Res. Conf.*, Cornell University, Ithaca, NY, June 15–17, 1993, p. 393.
200. I. J. Church and A. L. Parsons, Modified atmosphere packaging technology: a review, *J. Sci. Food Agric.* 67: 143 (1995).
201. A. L. Brody, Integrating aseptic and modified atmosphere packaging to fulfill a vision of tomorrow, *Food Technol.* 50: 56 (1996).
202. R. M. De Vries-Paterson, A. L. Jones, and A. C. Cameron, Fungistatic effects of carbon dioxide in a package environment on the decay of Michigan sweet cherries by *Moniliniafructicola*, *Plant Dis.* 75: 943 (1991).
203. C. Perera, L. Balchin, E. Baldwin, R. Stanley, and M. Tian, Effect of 1-methylcyclopropene on the quality of fresh-cut apple slices, *J. Food Sci.* 88: 910–914 (2003).
204. J. Bai, E. A. Baldwin, K. L. Goodner, J. P. Mattheis, and J. K. Brecht, Response of four apple cultivars to 1-methylcyclopropene treatment and controlled atmosphere storage, *HortScience* 40: 1534–1538 (2005).
205. Addition of methyl bromide to list of Class I substances and phaseout schedule, *Fed. Reg.* 58: 65028 (1993).
206. J. L. Sharp and G. J. Haliman, *Quarantine Treatments for Pests of Food Plants*, Westview Press, Boulder, CO, 1994.



207. G. J. Hallman, Controlled atmospheres, *Insect Pests and Fresh Horticultural Products: Treatments and Responses* (R. E. Paull and J. W. Armstrong, eds.), CAB International, Wallingford, UK, 1994, p. 121.
208. G. H. Hallman, M. O. Nisperos-Carriedo, E. A. Baldwin, and C. A. Campbell, Mortality of Caribbean fruit fly immatures in coated fruits, *J. Econ. Entomol.* 87: 752 (1994).
209. G. J. Hallman, R. G. McGuire, E. A. Baldwin, and C. A. Campbell, Mortality of feral Caribbean fruit fly (Diptera: Tephritidae) immatures in coated guavas, *J. Econ. Entomol.* 88: 1353 (1995).
210. Treatment schedule TIO2b: soapy water and wax. *U.S. Dept. Agric., Animal Plant Health Inspec. Serv. Treatment Manual*, 1993.
211. L. Grant and J. K. Burns, Application of coatings, *Edible Coatings and Films to Improve Food Quality* (J. M. Krochta, E. A. Baldwin, and M. O. Nisperos-Carriedo, eds.), Technomic Publishing Company, Lancaster, PA, 1994, p. 189.
212. V. B. Dalal, P. Thomas, N. Nagaraja, G. R. Shah, and B. C. Amla, Effect of wax coating on bananas of varying maturity, *Indian Food Packer* 24: 36 (1970).
213. V. B. Dalal, W. E. Eipeson, and N. S. Singh, Wax emulsion for fresh fruits and vegetables to extend their storage life, *Indian Food Packer* 25: 9 (1971).
214. P. B. Mathur and H. C. Srivastava, Effect of skin coatings on the storage behavior of mangoes, *Food Res.* 20: 559 (1955).
215. A. N. Bose and G. Basu, Studies on the use of coating for extension of storage life of fresh Fajli mango, *Food Res.* 19: 424 (1954).
216. J. C. Ayres, A. A. Krafy, and L. C. Peirce, Delaying spoilage of tomatoes, *Food Technol.* 9: 100 (1964).
217. E. A. Baldwin, M. O. Nisperos-Carriedo, R. D. Hagenmaier, and R. A. Baker, Use of lipids in edible coatings for food products, *Food Technol.* 56–62 (1996).
218. R. Zhuang, L. R. Beuchat, M. S. Chinnan, R. L. Shewfelt, and Y. W. Huang, Inactivation of *Salmonella montevideo* on tomatoes by applying cellulose-based edible films, *J. Food Prot.* 59: 808 (1996).
219. M. T. Wu and D. K. Salunkhe, Control of chlorophyll and solanine synthesis and sprouting of potato tubers by hot paraffin wax, *J. Food Sci.* 37: 629 (1972).
220. P. A. Poapst, I. Price, and F. R. Forsyth, Prevention of post storage greening in table stock potato tubers by application of surfactants and adjuncts, *J. Food Sci.* 43: 900 (1978).
221. M. T. Wu and D. K. Salunkhe, Responses of lecithin- and hydroxylated lecithin-coated potato tubers to light, *J. Agric. Food Chem.* 26: 513 (1978).
222. E. A. Baldwin, M. O. Nisperos-Carriedo, and R. A. Baker, Edible coatings for lightly processed fruits and vegetables, *HortScience* 30: 35 (1995).
223. E. A. Baldwin, M. O. Nisperos-Carriedo, and R. A. Baker, Use of edible coatings to preserve quality of lightly (and slightly) processed products, *Crit. Rev. Food Sci. Nutr.* 35: 509 (1995).
224. L. R. Howard and T. Dewi, Sensory, microbiological and chemical quality of mini-peeled carrots as affected by edible coating treatment, *J. Food Sci.* 60: 142 (1994).
225. R. J. Avena-Bustillos, L. A. Cisneros-Zevallos, J. M. Krochta, and M. E. Saltveit, Optimization of edible coatings on minimally processed carrots using response surface methodology, *ASAE* 36: 801 (1993).
226. E. Pennisi, Sealed in edible film, *Sci. News* 141: 12 (1992).
227. D. W. S. Wong, S. J. Tillin, J. S. Hudson, and A. E. Paviath, Gas exchange in cut apples with bilayer coatings, *J. Agric. Food Chem.* 42: 2278 (1994).
228. L. Jokay, G. E. Nelson, and E. L. Powell, Development of edible amylaceous coatings for foods, *Food Technol.* 21: 1064 (1967).
229. R. Danials, Coatings for cereal-type products, *Edible Coatings and Soluble Packaging*, Noyes Data Corp., Park Ridge, NJ, 1973, p. 229.
230. M. S. Cole, U.S. patent 3,479,191 (1969).
231. J. I. Mate, E. N. Frankel, and J. M. Krochta, Whey protein isolate edible coatings: effect on the rancidity process of dry roasted peanuts, *J. Agric. Food Chem.* 44: 1736 (1996).
232. R. A. Shea, June 23, U.S. patent 3,516,836 (1970).
233. E. Lowe, E. L. Durkee, and W. E. Hamilton, U.S. patent 3,046,143 (1962).
234. G. G. Watters and J. E. Brekke, U.S. patent 2,909,435 (1959).
235. S. P. Kochhar and J. B. Rossell, A vegetable oiling agent for dried fruits, *J. Food Technol.* 17: 661 (1982).
236. E. Lowe, E. L. Durkee, W. E. Hamilton, G. G. Watters, and A. I. Morgan Jr., Continuous raisin coater, *Food Technol.* 17: 109 (1963).

237. G. G. Watters and J. E. Brekke, Stabilized raisins for dry cereal products, *Food Technol.* 15: 236 (1961).
238. N. Goldenberg, The oiling of dried sultanas, *Chem. Ind.* 21: 956 (1976).
239. R. Daniels, *Edible Coatings and Soluble Packaging*, Noyes Data Corp., Park Ridge, NJ, 1973.
240. Food gums stick it out in dry mix glazes, *Prep. Foods* 1: 53 (1993).
241. N. C. Brake and O. R. Fennema, Edible coatings to inhibit lipid migration in a confectionery product, *J. Food Sci.* 58: 1422 (1993).
242. A. H. Johnson and M. S. Pererson, eds., *Encyclopedia of Food Technology*, AVI Publishing Co., Westport, CT, 1974, p. 178.
243. C. D. Bauer, G. L. Neuser, and H. A. Pinkalla, U.S. patent 3,406,081 (1968).
244. V. M. Balasubramaniam, M. S. Chinnan, P. Mallikarjunan, and R. D. Phillips, The effect of edible film on oil uptake and moisture retention of a deep-fat fried poultry product, *J. Proc. Eng.* 20: 17 (1997).
245. A. A. Lyall and R. J. Johnston, U.S. patent 3,959,670 (1976).
246. B. Biquet and T. P. Labuza, Evaluation of the moisture permeability characteristics of chocolate films as an edible moisture barrier, *J. Food Sci.* 53: 989 (1988).
247. P. Mallikarjunan, M. S. Chinnan, V. M. Balasubramaniam, and R. D. Phillips, Edible coatings for deep-fat frying of starchy products, *Lebensm. Wiss. Technol.* 30: 709–714 (1997).
248. Waxed fruit banned in Norway, *Post/zaniest News Info.* 1: 433 (1990).
249. New ACIAR project to investigate edible coatings, *Postharvest News Info.* 3: 103 (1992).
250. Waxing fruit—the debate continues, *Citrograph* (1993).
251. UK government considers food labeling scheme, *Post/zaniest News info.* 3: 3 (1992).
252. C. Lecos, How to shine an apple, *Food Drug Admin.* 16: 8 (1992).
253. J. D. Aylsworth, Debate over waxing heats up, *Fruit Grower* (May): 6 (1992).



# 22

## *Encapsulation, Stabilization, and Controlled Release of Food Ingredients and Bioactives*

Ronald B. Pegg and Fereidoon Shahidi

### CONTENTS

22.1	Introduction .....	510
22.1.1	Basis of Encapsulation .....	511
22.1.2	Benefits and Types of Microcapsules .....	512
22.2	The Encapsulation Matrix .....	514
22.2.1	Carbohydrates .....	514
22.2.1.1	Maltodextrins and Corn Syrup Solids.....	515
22.2.1.2	Modified Starch.....	516
22.2.1.3	Cyclodextrins .....	517
22.2.1.4	Modified Cyclodextrins .....	519
22.2.1.5	Sucrose .....	519
22.2.1.6	Chitin and Chitosan .....	520
22.2.1.7	Cellulose .....	520
22.2.2	Gums .....	521
22.2.2.1	Seaweed Extracts .....	521
22.2.2.2	Exudate Gums.....	522
22.2.3	Lipids .....	524
22.2.3.1	Waxes .....	524
22.2.3.2	Acetoacylglycerols .....	524
22.2.3.3	Lecithins .....	525
22.2.3.4	Liposomes .....	525
22.2.4	Proteins.....	527
22.3	Microencapsulation Techniques .....	527
22.3.1	Spray Drying .....	527
22.3.1.1	Preparation of the Dispersion or Emulsion.....	528
22.3.1.2	Homogenization of the Dispersion .....	529
22.3.1.3	Atomization of the Infeed Emulsion .....	529
22.3.1.4	Dehydration of the Atomized Particles.....	530
22.3.2	Spray Cooling and Spray Chilling.....	530
22.3.3	Fluidized Bed Coating .....	531
22.3.4	Extrusion .....	532
22.3.5	Centrifugal Extrusion.....	534
22.3.6	Lyophilization .....	535
22.3.7	Coacervation .....	535
22.3.7.1	Formation of a Three-Immiscible Chemical Phase .....	536
22.3.7.2	Deposition of the Coating.....	536
22.3.7.3	Solidification of the Coating.....	536
22.3.8	Centrifugal Suspension Separation .....	537
22.3.9	Cocrystallization .....	538
22.3.10	Liposome Entrapment .....	539

22.3.10.1	Microfluidization .....	539
22.3.10.2	Ultrasonication .....	540
22.3.10.3	Reverse-Phase Evaporation .....	540
22.3.11	Interfacial Polymerization .....	540
22.3.12	Inclusion Complexation: Molecular Inclusion .....	540
22.3.13	Nanoparticulate Delivery Systems .....	542
22.4	Encapsulated Ingredients and Their Application .....	542
22.4.1	Acidulants .....	542
22.4.1.1	Meat-Processing Aids .....	543
22.4.1.2	Dough Conditioners .....	543
22.4.1.3	Other Encapsulated Acidulants .....	544
22.4.2	Flavoring Agents .....	544
22.4.3	Sweeteners .....	545
22.4.4	Clorants .....	546
22.4.5	Lipids .....	547
22.4.6	Vitamins and Minerals .....	548
22.4.7	Enzymes .....	550
22.4.8	Microorganisms .....	550
22.4.9	Gases .....	552
22.4.10	Other Food Additives and Ingredients .....	552
22.5	Controlled-Release Mechanism and Effects .....	552
22.5.1	Release Rate .....	553
22.5.2	Release Mechanisms .....	553
22.5.2.1	Fracturation or Pressure-Activated Release .....	554
22.5.2.2	Diffusion .....	554
22.5.2.3	Solvent-Activated Release .....	555
22.5.2.4	Melting-Activated Release .....	556
22.5.2.5	Biodegradation and pH-Sensitive Release .....	556
22.6	Conclusions .....	556
	References .....	557

---

## 22.1 Introduction

Ingredients are incorporated into the foods we eat for a multitude of reasons. For example, antimicrobial agents are added in an effort to ward off the early onset of microbial growth; antioxidants are used to prolong the shelf life of lipid-containing foods by protecting triacylglycerols and phospholipids against oxidative degradation; flavoring and coloring agents are added for the purpose of enhancing the sensory characteristics of the food; and various carbohydrate-based additives are employed to improve the rheological and textural properties of the product in question. Encapsulation technologies have been increasingly attracting the attention of food ingredient suppliers and food product manufacturers as a means of achieving much-needed differentiation and enhancing product value. Microencapsulated products can add that extra zing, mask the taste of nutrients, alleviate processing problems, and extend the shelf life of food products [1]. Within the past decade, the explosion of functional foods and nutraceuticals in the North American market has in effect created a new type of additive for foods, that being functional food ingredients, which may provide a physiological benefit and reduce the risk of chronic disease beyond basic nutritional functions. This has led to the development of innovative functional food products and product lines. The ever-increasing health-conscious consumer is very much interested in the beneficial properties of functional food ingredients and nutraceuticals; hence, the importance of encapsulation (i.e., microencapsulation and nanoencapsulation) and controlled-release technologies, as a means to better deliver bioactives and nutrients in both wet and dry applications, has grown both in scope and potential. Currently, there is a market interest in omega-3 fatty acids; phytosterols/stanols for cholesterol control; probiotics, prebiotics, and synbiotics for gut health; vitamins and minerals for fortification/augmentation of food; bioactive peptides for controlling high blood pressure; amino acids and proteins as key ingredients in sports and energy foods and drinks; polyphenolic antioxidants that are promoted for

general health benefits; and a number of lecithin products that are marketed for brain and memory function, liver support, and cholesterol control [2]. According to an analyst from Frost & Sullivan Research Service [3], “The growing functional foods market is the major driving force behind microencapsulation innovation. Microencapsulation offers food companies a viable means of penetrating this lucrative growth sector because it has the ability to mask the taste associated with some of these ingredients, allowing firms to include these ingredients in many more products than before.”

There has been a reduction in the permitted levels of many food additives, and where possible, replacing those chemically derived with alternatives that are perceived to be natural or organic [4,5]. For example, the use of synthetic antioxidants in foods, such as 2- and 3-*tert*-butyl-4-methoxyphenol (i.e., butylated hydroxyanisole, BHA), 2,6-di-*tert*-butyl-4-methylphenol (i.e., butylated hydroxytoluene, BHT) and *tert*-butylhydroquinone (TBHQ), is being reevaluated because of the growing concern over their possible carcinogenic effects [6,7]. Attention has been directed toward the development/isolation of natural antioxidants from botanical sources, especially edible plants. The employment of natural antioxidants in foods is limited, however, on account of a lack of knowledge concerning their molecular composition, the content of bioactives in the raw material, and the availability of relevant toxicological data. Unlike synthetic antioxidants, which are phenolic compounds with varying degrees of alkyl substitution, natural antioxidants can be phenolic compounds (flavonoids, phenolic acids, and tannins), nitrogen-containing compounds (alkaloids, chlorophyll derivatives, amino acids, peptides, and amines), carotenoids, tocopherols, or ascorbic acid and its derivatives [8]. Unfortunately, many of the natural ingredients are less potent at equivalent addition levels or are more restricted in their applicability than their “synthetic” counterparts. A novel strategy to increase the effectiveness and range of application of many types of natural ingredients is to make use of microcapsular delivery systems [5]. Because of the wide availability of encapsulated ingredients, many food products or functional food ingredients whose development was thought to be technically unfeasible are now possible. Such ingredients are products of a process in which the active ingredient has been enveloped in a coating or “capsule,” thereby conferring many useful or eliminating undesirable properties to or from the original ingredient, respectively.

### 22.1.1 Basis of Encapsulation

Encapsulation has been employed by the food industry for more than 75 years. In a broad sense, encapsulation technology in food processing involves the coating of minute ingredient particles (e.g., acidulants, leavening agents, artificial sweeteners, minerals, vitamins, antioxidants, essential oils, flavors, and bioactives) as well as whole ingredients (e.g., raisins, nuts, and confectionery products), which can be accomplished by microencapsulation and macrocoating techniques, respectively. More recently, nanoparticulate delivery systems have become a reality. In fact, nanoencapsulation is one of the most important subcategories of controlled-release bionanotechnology. Nanoencapsulated particles can be used in formulating “clear” beverages without the worry of turbidity, which has been associated with some microencapsulated ingredients. This is due to the smaller particle size. In nanoencapsulation, functional ingredients can be reduced to a size of 30 nm and are encapsulated in food-grade matrices/compounds; the process is essentially self-assembly once the base encapsulation material is finalized. Thus, nanotechnology provides an improved activity level and solubilized ingredients for clear beverages that previously could not be achieved.

The science of encapsulation deals with the manufacture, analytical evaluation, and application of encapsulated products. Despite the passage of time, the technology that has been developed for the food industry remains relatively unsophisticated compared with many other fields of application. This is a consequence of the limitations imposed on the food industry for the use of edible, low-cost ingredients and processing. Nevertheless, due to health-conscious consumers and the fashionable trend toward functional foods and nutraceuticals/natural health products, it is only now that manufacturers have been exploring new encapsulation delivery methods to ensure the bioavailability of efficacious quantities of sought-after functional food ingredients. Nanotechnology is an example of a recent outgrowth from this development.

King [9] notes it is important for the food scientist to distinguish between encapsulation and entrapment of food ingredients. He states that encapsulation may be defined as a process of forming a continuous thin coating around encapsulants (i.e., solid particles, droplets of liquids, or gas cells), which are wholly contained

within the capsule wall as a core of encapsulated material. In contrast, entrapment refers to the trapping of encapsulants within or throughout a matrix (e.g., gel, crystal). A small percentage of the entrapped ingredients will normally be exposed at the particle surface, whereas this would not be so for the encapsulated product. As aforementioned, the entrapped material is commonly a liquid but could be a solid particle or gas, and is referred to by various names such as core material, payload, actives, fill, or internal phase [10]. The material that forms the coating is either called the wall material, capsule, membrane, carrier, shell, or coating. The food industry applies encapsulation for a number of reasons [11–13]:

1. Encapsulation/entrapment can protect the core material from degradation by reducing its reactivity toward the outside environment (e.g., heat, moisture, air, and light).
2. Evaporation or transfer rate of the core material to the outside environment is decreased/retarded.
3. The physical characteristics of the original material can be modified and made easier to handle. For example
  - a. A liquid component can be converted into solid particles.
  - b. Lumping can be prevented.
  - c. The core material can be distributed more uniformly throughout a mixture by giving it a size and outside surface.
  - d. Hygroscopicity can be reduced.
  - e. Flow and compression properties can be improved.
  - f. Dustiness can be reduced.
  - g. Density can be modified.
4. The product can be designed to either release slowly over time or at a certain point (i.e., to control the release of the core material so as to achieve the proper delay until the right stimulus).
5. The taste of the core material can be masked.
6. The core material can be diluted when it is needed only in very small amounts, and to achieve uniform dispersion in the host material.
7. It can be used to separate reactive components within a mixture which would otherwise react with one another.

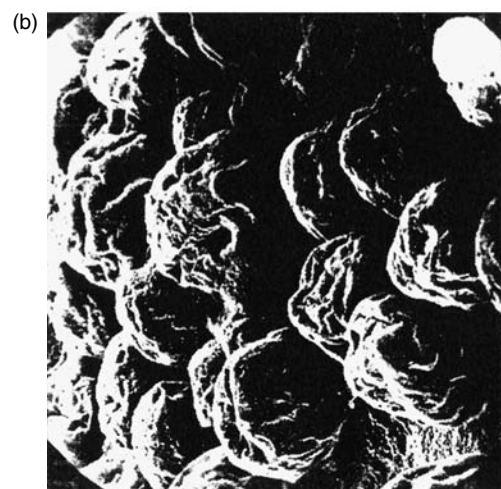
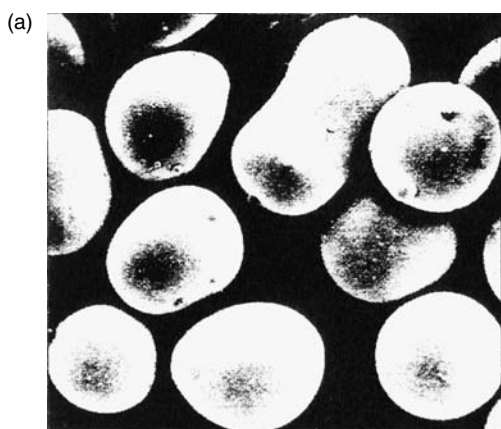
### 22.1.2 Benefits and Types of Microcapsules

Microencapsulation is defined as the technology of packaging solids, liquids, or gaseous materials into miniature, sealed capsules that can release their contents at controlled rates under specific conditions [2,14,15]. The small packages, called “microcapsules,” may range from submicron to several millimeters in size and have a multitude of different shapes, depending on the materials and methods employed to prepare them. Generally, the microcapsule has the capability of modifying and improving the apparent shape and properties of a substance. More specifically, the microcapsule has the capacity to preserve a substance in the finely divided state and to release it when the occasion demands.

Microcapsules offer the food processor a means to protect sensitive food components, ensure against nutritional/nutrient loss of functional food ingredients, utilize otherwise sensitive food-grade materials, incorporate unusual or time-release mechanisms to a formulation, mask or preserve flavors and aromas, and transform liquids into easily handleable solid ingredients [16]. The unusual properties afforded by encapsulated ingredients offer the food technologist greater flexibility and control in developing functional foods that are more flavorful and nutritious; and may offer physiological benefits, such as a reduction in the likelihood of developing a chronic disease, beyond basic nutritional functions to meet the expectations of today’s health-conscious consumers. Microencapsulation technology, however, is sometimes considered more art than science. In *Microcapsule Processing and Technology*, Dr. Asajo Kondo states, “Microencapsulation is like the work of a clothing designer. He selects the pattern, cuts the cloth, and sews the garment in due consideration of the desires and age of his customer, plus the locale and climate where the garment is to be worn. By analogy, in microencapsulation, capsules are designed and prepared to meet all the requirements in due consideration of the core material, intended use of the product, and the environment of storage.”

Various properties of microcapsules may be changed to suit specific ingredient applications, and they include composition, mechanism of release, particle size, final physical form, cost, and regulations. Before considering the properties desired in encapsulated products, the purpose of encapsulation must be clear. In designing the encapsulation process, the following questions should be taken into consideration: (i) what functionality should the encapsulated ingredients provide to the final product? (ii) what type of food-grade coating material should be selected? (iii) what processing conditions must the encapsulated ingredient survive before releasing its content? (iv) what is the optimum concentration of the active material in the microcapsule? (v) by what mechanism will the ingredient be released from the microcapsule? (vi) what are the particle size, density, and stability requirements for the encapsulated ingredient? (vii) what are the cost constraints of the encapsulated ingredient? and (viii) will the encapsulated ingredient meet regulations/standards to be considered as a functional food ingredient?

The architecture of microcapsules is generally divided into several arbitrary and overlapping classifications (Figure 22.1). One such classification is known as matrix encapsulation. This is the simplest structure in which a sphere is surrounded by a wall or membrane of uniform thickness, resembling that of a hen's egg. In this design, the core material is buried to varying depths inside the shell. This microcapsule has been termed as a single-particle structure (Figure 22.1a). In addition to this structure, it is also possible to design microcapsules that have several distinct cores within the same capsule or, more commonly,



**FIGURE 22.1** Photomicrographs of different food ingredients: microencapsulated potassium chloride (a) and vitamin A capsules in ethylcellulose (b). (From F. Shahidi and X.-Q. Han, *Crit. Rev. Food Technol.* 33: 501, 1993.)

numerous core particles embedded in a continuous matrix of wall material. This type of design is termed the aggregate structure (Figure 22.1b). The particles in the aggregate structure need not all be the same material. In the case of aggregate capsule structures, a degree of particle size control can be achieved. This technique has been accomplished with numerous materials to improve size distribution properties [18]. Another well-known design for a microcapsule is to form a multiwalled structure, in which the different concentric wall layers can have the same or quite different compositions. In this case, the multiple walls are placed around a core to achieve multiple purposes related to the manufacture of the capsules, their subsequent storage, and controlled release. This design is particularly important for controlled-release encapsulation systems using nanospheres containing an active ingredient. These nanospheres can be encapsulated with other ingredients, such as flavors, cooling or heating agents, or sweeteners, within a microsphere. Upon exposure to water or pH, the microsphere releases its contents, and over an extended period of time the nanosphere releases the encapsulated active ingredient via molecular diffusion and possibly by enzymatic degradation. The surface properties of the nanospheres can be altered to be bioadhesive, or negatively or positively charged depending on the intended target site [19].

The theory and application of microcapsular delivery systems encompass a variety of engineering techniques and scientific disciplines, thus making it difficult to present a systematic view of the total effort being dispensed in this field. This chapter summarizes the art of microencapsulation



as it relates to the food industry and presents current information on the process of encapsulation. To accomplish this, a comprehensive examination of the various encapsulating matrices currently utilized by the food industry is included. In addition to their general description, the advantages and disadvantages they offer as an encapsulating agent when forming microcapsules are discussed. An in-depth examination of the various microencapsulation techniques follows. This includes the processes of spray drying, spray cooling, and spray chilling; fluidized bed coating; extrusion; centrifugal extrusion; lyophilization; coacervation; centrifugal suspension separation; cocrystallization; liposome entrapment; interfacial polymerization; inclusion complexation; and nanoparticulate delivery systems. Subsequently, encapsulated ingredients and their application to various food systems are considered with reference to some of their common uses and growing importance to the functional food and nutraceutical arena. Finally, an examination of what is meant by controlled release and some of the mechanisms surrounding it are discussed.

## 22.2 The Encapsulation Matrix

To encapsulate a functional food ingredient, the first requirement is the selection of an appropriate coating material referred to as the encapsulating matrix. As indicated above, many researchers have referred to the coating material as the shell, wall material, or encapsulating agent [4].

Coating substances that are basically film-forming materials can be selected from a wide variety of natural or synthetic polymers, depending upon the material to be coated and the characteristics desired in the final microcapsules. It is the composition of the coating material, which is the main determinant of the functional properties of the microcapsule, and of how it may be used to improve the performance of a particular ingredient. An ideal coating material should have the following properties: (i) good rheological properties at high concentrations and be easy to work with during the process of encapsulation; (ii) a capability to disperse or emulsify the active material and stabilize the emulsion so produced; (iii) nonreactivity with the material to be encapsulated both during processing and upon prolonged storage; (iv) a capability to seal and hold the active material within its structure during processing and storage; (v) a complete release of the solvent or other materials, which are used during the process of encapsulation, under drying or other desolventization conditions; (vi) a capability to offer maximum protection to the active material/bioactive against environmental conditions (e.g., oxygen, heat, light, and humidity); (vii) solubility in solvents acceptable by the food industry (e.g., water and ethanol); (viii) chemical nonreactivity with the active material/bioactive; (ix) standards, which meet specified or desired solubility properties of the capsules, and release properties of the active material from the capsule; and (x) low cost. Because no single coating material meets all the criteria listed above, in practice, coating materials are employed either in combination or with modifiers such as oxygen scavengers, antioxidants, chelating agents, and surfactants. Some commonly used coating materials are presented in Table 22.1 and discussed in detail below.

### 22.2.1 Carbohydrates

The ability of carbohydrates to absorb and adsorb volatiles from the environment or to retain them tenaciously during the drying process has important implications and applications for flavor encapsulation. In fact, carbohydrates are the most commonly used coating material in flavor encapsulation processes.

**TABLE 22.1**

Coating Materials for Encapsulation of Food, Functional Food, and Nutraceutical Ingredients

Carbohydrate	Starch, maltodextrins, corn syrup solids, dextran, modified starch, sucrose, cyclodextrins
Cellulose	Carboxymethylcellulose, methylcellulose, ethylcellulose, nitrocellulose, acetylcellulose, cellulose acetate-phthalate, cellulose acetate-butylate-phthalate
Gum	Gum acacia, agar, sodium alginate, carrageenan
Lipid	Wax, paraffin, beeswax, tristearic acid, diacylglycerols, monoacylglycerols, oils, fats, hardened oils
Protein	Gluten, casein, gelatin, albumin, hemoglobin, peptides

Source: F. Shahidi and X.-Q. Han, *Crit. Rev. Food Technol.* 33: 501 (1993).

The mechanisms by which carbohydrates retain volatiles during processing such as freeze and spray drying as well as extrusion are not fully understood but most probably involve physical interactions [20]. It has been postulated that the formation of microregions during freeze drying, which contain highly concentrated solutions of carbohydrate and volatiles, results in molecular association of the carbohydrate through hydrogen bonding. This in turn creates a stable network and traps the volatiles [21]. For example, it has been reported that loss of volatiles from lactose during freeze drying increased when the material changed from an amorphous solid to a crystalline one [22]. Formation of cracks in the microregion structure might have accounted for this [20].

The two major processes used for encapsulation of food flavorings are spray drying and extrusion [23]. Both of these depend primarily on carbohydrates for the encapsulation matrix [24]. Though one can find examples of encapsulation using fats (e.g., spray-chilling), proteins (gelatine), and inorganics (fused silica), carbohydrates comprise the majority of the market of encapsulation matrices. While many compounds are classified as carbohydrate, discussion here does not include all such compounds. Some are described under different headings and classifications.

### 22.2.1.1 Maltodextrins and Corn Syrup Solids

Starch, the reserve polysaccharide of most plants, is one of the most naturally abundant polymers found on earth. It has been extracted from numerous food sources, including tubers (potato, tapioca, arrowroot, and sweet potato) and cereals (corn, waxy maize, wheat, and rice). It is the most commonly used food hydrocolloid, and this is partly because of the wide range of functional properties it can provide in its native and modified forms, and partly due to its low cost relative to alternatives [25].

Starch comprises polymers of glucose units linked together primarily by  $\alpha$ -(1 $\rightarrow$ 4) bonds and secondarily by  $\alpha$ -(1 $\rightarrow$ 6) bonds. In the native state, starch exists as granules that are insoluble in cold water owing to the hydrogen bonding of the polymer chains. The two polymer types found within the granules are amylose (a straight chain polymer) and amylopectin (a branched chain polymer). With its long, straight chains, amylose is known for forming strong, flexible films. In contrast, owing to its extensive branching, amylopectin is not a strong film former but is noted for clarity and stability when forming gels and may show a slightly greater tendency toward absorption or binding of flavors. The content of amylose and amylopectin in starch granules varies depending upon the source. Typically, starches contain 18%–30% amylose, except for waxy corn types that are virtually all amylopectin [25]. When mixed with water and provided with enough heat, starch granules swell sufficiently as hydrogen bonds are broken to form pastes that can produce strong films. For most encapsulation processes, however, the viscosity of native starch is too high.

Maltodextrins,  $(C_6H_{12}O_5)_nH_2O$ , are nonsweet nutritive polysaccharides consisting of  $\alpha$ -(1 $\rightarrow$ 4) linked D-glucose units. To be termed maltodextrin, they must possess a reducing sugar content or “dextrose equivalence” (DE) of less than 20. Maltodextrins are prepared as white powders or concentrated solutions by partial hydrolysis of cornstarch with safe and suitable acids or enzymes. If the DE equals or exceeds 20, they are referred to as corn syrup solids. The DE, which is a percentage, is a measure of the reducing power of a sample compared with an equal mass of dextrose. Common designations of maltodextrins are 5, 10, 15, and 18 DE, while commercial corn syrup solids have 20, 25, 36, and 42 DE [26]. Products with a DE greater than 42 cannot be easily dried and hence are sold only as concentrates/syrups. Because maltodextrins and corn syrup solids are so closely related to one another in terms of their physical and chemical properties as well as their applicability to food ingredient encapsulation, they will be discussed jointly. A flow diagram for the production of maltodextrins and corn syrup solids from cornstarch is presented in Figure 22.2.

In the production of maltodextrins and corn syrup solids, starch is only partially hydrolyzed by acid or enzymes; thus, the resulting products are heterogeneous mixtures of various chain length glucose polymers. The higher the DE, the higher the concentration of product that can be put into solution. In spray-dried encapsulations, increased level of soluble solids at a low viscosity is a major factor in the efficiency of production. In spray-dried encapsulation of citrus oils, Anandaraman and Reineccius [27] reported that the higher the DE of the corn syrup solids used, the longer the stability of the encapsulated oil. Bangs and Reineccius [28] found intermediate or lower DE products to be more efficient for spray-dried encapsulation of volatile artificial flavor compounds. It was postulated that a balanced polymer length might aid in trapping the volatiles as the surface of the droplet dries.

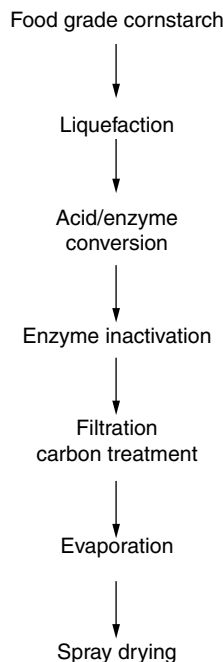
These hydrolyzed starches offer the advantages of being relatively inexpensive (approximately one-third that of modified starches), bland in flavor, and low in viscosity at high solids content. However, the major problem with these products is the lack of emulsification properties [29]. Since most active materials (especially the flavors) are insoluble in aqueous solutions and thus exist as emulsions, emulsion stability is viewed as an important consideration when selecting a coating material. Maltodextrins and corn syrup solids lack lipophilic characteristics and have virtually no emulsion-stabilizing effect on water-insoluble components [24]. It is also found that maltodextrins and corn syrup solids do not result in good retention of volatile compounds during the spray-drying process. Corn syrup solids typically perform more poorly. Retention often ranges between 65% and 80% [24]. The retention capacity changes significantly with a difference in DE value. Raja et al. [30] investigated the use of maltodextrins with varying DE values for encapsulating cardamom oil. The reason for the poor retention of volatiles by maltodextrins and corn syrup solids was believed to be due to their poor film-forming capabilities (NB, this is why they are sometimes referred to as carriers not encapsulators). The wet encapsulation matrix must form a film around the droplets of active material to effectively retain them during the drying process and water removal. Because maltodextrins and corn syrup solids have no emulsification properties, they produce coarse emulsions and therefore are considered to result in poor flavor retention during drying [31].

Maltodextrins and corn syrup solids vary greatly in protecting encapsulated ingredients from oxidation. There is a strong dependence of associative stability on DE of the hydrolyzed starch. An encapsulated product with the highest DE is extremely stable and will have a shelf life of years even without the addition of an antioxidant [27]. Several factors have been attributed to the outstanding protection afforded by high-DE coating materials. It has been considered that the higher-DE systems are less permeable to oxygen and therefore offer better protection to encapsulated ingredients [24]. One should also keep in mind that the presence of glucose in the encapsulation system has a considerable effect on the antioxidative properties.

### 22.2.1.2 Modified Starch

Starch presents an interesting situation with regard to flavor binding. Because the amylose fraction forms helical structures, starch can entrap flavor molecules, thereby forming very stable complexes [32]. However, starch is hydrophilic, and hydrolysates derived from it afford virtually no emulsification properties to the compound being encapsulated.

In its natural state, starch is cold-water insoluble [25]. One method used to modify its viscosity and cold-water solubility is pyroconversion or dextrinization. In dextrinization, starch is heated in the dry granular form with agitation, generally in the presence of an acid such as hydrochloric or sulfuric. The term “dextrinization” refers to the reduction in size of the starch molecule to smaller fractions or dextrans. Partial hydrolysis of starch granules ensues as well as repolymerization to form more highly branched polymers. The extent of this process can be varied based on time, temperature, and pH conditions to yield products with different solubility and viscosity characteristics. Dextrans have increased cold-water solubility and lower solution viscosity than gelatinized native starch. If heated too long the products become darker, and stronger reaction flavors are noted. Unfortunately, these strong color and



**FIGURE 22.2** Flow diagram for the production of maltodextrin and corn syrup solids from cornstarch. (From M. M. Kenyon, *Encapsulation and Controlled Release of Food Ingredients*, S. J. Risch and G. A. Reineccius, eds., ACS Symposium Series No. 590, American Chemical Society, Washington, DC, 1995, p. 42.)

flavor characteristics and a lack of lipophilic emulsifying qualities make dextrans less than ideal for encapsulation, especially of oil-based products.

The lack of emulsification properties of native starch creates two significant problems. The first is that poor flavor retention results. The fineness of the infeed emulsion has a strong influence on determining the extent of flavor retention during drying. The second problem relates to the stability of the flavor emulsion once reconstituted in the final product. If the carrier provides no emulsification to the flavor, then the flavor rapidly separates from the product and forms a ring at the top. For a compound to function as an emulsifier, it therefore must contain both lipophilic and hydrophilic groups. To overcome this problem, starches can be modified chemically to change their functional characteristics. For example, the US Food and Drug Administration has approved the reaction of starch with 1-octenylsuccinic anhydride to form a modified starch containing both hydrophobic and hydrophilic groups. This level of substitution, usually in the range of 0.02%, results in a product that is vastly different from that of the native starch. The addition of lipophilic moieties along the starch polymer permits the formation of emulsions with tight alignment of the polymer around an oil droplet. This stabilization is extremely important for encapsulation of lipid products. Modified starch provides excellent retention of volatiles during spray drying and can be used at a higher infeed solids level than gum acacia (also known as gum arabic). While gum acacia is generally limited to use at ~35% infeed solids level, modified starch can typically be employed at levels approaching 50% [24]. The high solids level helps to reduce loss of encapsulated ingredients and increases spray-dryer throughput.

The emulsification properties of lipophilic starches as well as the oil retention in the spray-dried powders are reported to be equal to or greater than that of gum acacia [33,34]. Modified starch also excels in promoting emulsion stability. One means of doing so is to prepare small particle size droplets. Solutions of gum acacia produced an average emulsion droplet size of ~3  $\mu\text{m}$ , and modified starch gave droplets of less than 2  $\mu\text{m}$ . The emulsions made with modified starch were physically more stable than those prepared with the standard gum acacia [23]. Reineccius [24] pointed out that the modified starches do have some disadvantages. For example, they are not considered natural for labeling purposes: they often have an undesirable off-flavor and do not afford good protection to oxidizable flavorings.

### 22.2.1.3 Cyclodextrins

Cyclodextrins are chemically and physically stable molecules formed by the enzymatic modification of starch. They have an ability to form complexes with a wide variety of organic compounds within their ringed structure, most notably flavor compounds [35]. The ability of these unusual molecules to form inclusion complexes, which can change the physical and chemical properties of guest molecules, offers a variety of potential uses to the food industry. Although cyclodextrins have been studied for a century, and their ability to form inclusion complexes has been recognized for at least 50 years, they were not utilized for food applications until the 1970s when Japan and Hungary began producing them commercially.

Cyclodextrins were discovered in 1891 when Villiers reported their appearance in rotting potatoes. In 1904, Schardinger characterized them as cyclic oligosaccharides and identified *Bacillus macerans* as the bacterium that produced cyclodextrin glycosyltransferase (CGTase), the enzyme responsible for the generation of cyclodextrins from starch. Because of Schardinger's studies, cyclodextrins were initially referred to as Schardinger dextrans, but of more significance was the fact that his work set the direction for future research, pointing it toward a study of the structure of cyclodextrins and their commercial production. French [36] has provided a detailed history of the development on cyclodextrins up to 1956.

Today, cyclodextrins are produced from starch by selected microorganisms such as *B. macerans* and *Bacillus circulans*, which have CGTase activity. After cleavage of starch by the enzyme, the ends are joined to form circular entities with  $\alpha$ -(1 $\rightarrow$ 4) linkages. Because cyclodextrins are closed circular molecules, glucoamylases and beta amylases cannot hydrolyze them as there is no reducing end group which is necessary to initiate hydrolysis. The cyclic dextrans formed contain six, seven, or eight glucose monomers; these are referred to as  $\alpha$ -,  $\beta$ -, and  $\gamma$ -cyclodextrin, respectively. The glucose monomers are joined to one another in a doublenut-shaped ring, giving the cyclodextrins a molecular structure that is relatively rigid and has a hollow cavity of specific diameter and volume. Depending upon the enzyme used and the conditions under which the reaction is performed, the ratio of cyclodextrins can vary from various mixtures to a single cyclodextrin being formed.

Figure 22.3 depicts the chemical structure of  $\beta$ -cyclodextrin, the predominant cyclodextrin produced by CGTase enzymes. Polar hydroxyl groups of the glucose monomers are located on the rim of the molecule and are directed away from the cavity. These groups interact with water giving cyclodextrins their aqueous solubility properties and will interact with polar groups of some molecules to form hydrogen bonds. While the outer surfaces (top and bottom) are hydrophilic, the internal cavity has a relatively high electron density and is hydrophobic in nature due to the hydrogen and glycosidic oxygen atoms being oriented to the interior of the cavity. Organic molecules of suitable size, shape, and hydrophobicity are able to interact noncovalently with cyclodextrins to form stable complexes. Several forces, such as van der Waals forces, hydrophobic interaction, and dipole–dipole interaction, are involved in the binding of guest molecules to the cyclodextrin cavity. These forces are sufficiently efficacious to form a stable complex, but are not so secure that the guest molecule can be released from the complex to become available for the intended effect of the guest molecule [37].

The dimensions of the cyclodextrin's cavity allow some selectivity for the complexation of guest molecules. Strong binding results if more interaction occurs between the walls of the cyclodextrin and the guest molecule. If the molecule to be encapsulated is small compared to the cavity, then only a part of its surface is in contact with the walls and the full potential of the guest molecule to interact with the cyclodextrin is not realized. For molecules containing five or fewer carbon atoms, the smaller cavity of  $\alpha$ -cyclodextrin affords more interaction between the molecule and the cavity walls. Thus, better complexation results than if  $\beta$ - or  $\gamma$ -cyclodextrin were used. In contrast, large bulky molecules, such as anthracene, fit into the cavity of the  $\gamma$ -cyclodextrin better than that of  $\alpha$ - or  $\beta$ -cyclodextrin. In fact sometimes, molecules are too large to fit into the cavity of one or more of these. Thus, the guest molecule might be totally excluded from the cavity, or only a portion of it would fit. As more of the molecule can fit into the cavity, a stronger binding results. Some of the physical properties of cyclodextrins are summarized in Table 22.2 [38].

$\beta$ -Cyclodextrin deserves special attention because it is the most readily available cyclodextrin. In preliminary studies, it is generally used and is known to be able to form inclusion complexes with flavor ingredients of molecular masses ranging between 80 and 250 Da. Linder [39] reported that the molecules of nearly all natural spices and flavors fit in this range. Much research has focused on the ability of cyclodextrins to prevent the volatilization of flavors and essences from spices, flavor extracts, and lipids. Nagatomo [40] reported that cyclodextrins improve the stability of spices for use in sausages and other meat products. Spices that have been included in cyclodextrins have demonstrated controlled flavor

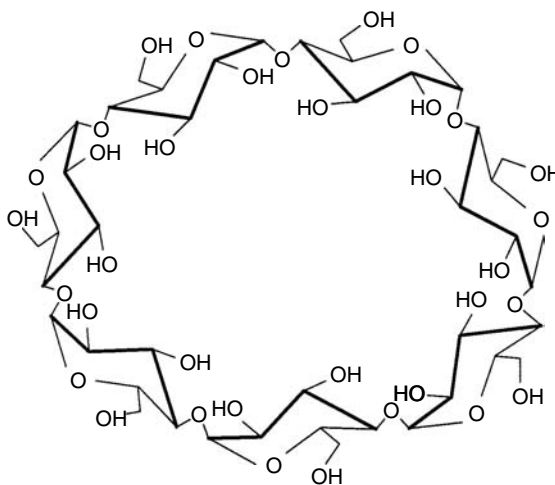


FIGURE 22.3 Chemical structure of  $\beta$ -cyclodextrin.

TABLE 22.2

Physical Properties of Cyclodextrins

Type of Cyclodextrin	Number of Glucose Units	Molecular Weight	Molecular Dimensions (Å)			Solubility at 25°C (g/100 mL H <sub>2</sub> O)	[ $\alpha$ ] <sub>D</sub> <sup>20</sup> (H <sub>2</sub> O, 1%)
			Inside Diameter	Outside Diameter	Height		
$\alpha$	6	973	5.7	13.7	7.0	14.50	150.5°
$\beta$	7	1135	7.8	15.3	7.0	1.85	162.5°
$\gamma$	8	1297	9.5	16.9	7.0	23.20	117.4°

Source: F. Shahidi and X.-Q. Han, *Crit. Rev. Food Technol.* 33: 501 (1993).

release. In addition, thermal stability is improved when fats are added to them. Nagatomo [40] also noted that cyclodextrins preserved the flavor of cookies, vegetable pastes, biscuits, citrus fruits, Japanese onions, garlic, celery, and a variety of other products. Pagington [41] reported that the strong odor of onion oil, garlic oil, and pyrazines was restricted by cyclodextrin use, but complexing with cyclodextrins prevented their flavor from being lessened in processing and released their flavor directly into the mouth.

Natural pigments, such as carotenoids and anthocyanins, can also be stabilized by a cyclodextrin complex [40]. Pigments can be masked or color tones intensified. It has been reported that the colors can be changed through the inclusion complexation process. Cyclodextrin complexes can protect ingredients from oxidation, light-induced reactions, thermal decomposition, and evaporation loss. Crystalline complexes are stable and improve processing conditions, handling, and storage of food ingredients.

#### 22.2.1.4 Modified Cyclodextrins

Although  $\beta$ -cyclodextrin forms a stable microcapsular structure, the water solubility of  $\beta$ -cyclodextrin complexes is generally a problem. The solubility of  $\alpha$ - and  $\gamma$ -cyclodextrin at room temperature is 12.8 and 25.6 g/100 mL water, respectively; whereas, for  $\beta$ -cyclodextrin it is only 1.8 g/100 mL. As temperature increases, the solubility of cyclodextrins also increases, but their solubility can change when a guest is complexed. If the guest molecule is highly soluble in water, then the inclusion complex is more soluble than the cyclodextrin itself. The polar or ionic moiety of the guest molecule projects out of the cavity and contributes to the solubility of the complex along with the interaction of the hydroxyl groups of the cyclodextrin. In contrast, complexation of the cyclodextrin with a guest that is not soluble or only partially soluble in water generally results in a decrease in the solubility of the cyclodextrin. Although solubility of the complex is generally less than that of the cyclodextrin, it is greater than that of the guest molecule.

The solubility of cyclodextrins can be improved by substituting various hydroxyl groups of the rims of the cyclodextrin molecule [42]. By chemical modification, cyclodextrins may attain characteristics very different from those of the original material. Cyclodextrins can be incorporated into polymer structures. One such polymer can be produced by linking of cyclodextrin rings with suitable agents, such as epichlorohydrin, to obtain insoluble copolymers in the form of water-swelling beads. Some of these polymers retain the ability of the cyclodextrin to form complexes with various compounds, especially those with hydrophobic groups.

It has been reported that if cyclodextrins are linked to polyethers, water-soluble polymers are produced [43]. Initial studies have shown that heptamino- $\beta$ -cyclodextrin can be crosslinked by hexamethylene diisocyanate. If the degree of polymerization is high enough, the cyclodextrins bound within the matrix become insoluble. The chemical structure of an experimental polymer produced by Amaizo is shown in Figure 22.4.

#### 22.2.1.5 Sucrose

As the most commonly used ingredient in the food industry, sucrose ( $\beta$ -D-fructofuranosyl- $\alpha$ -D-glucopyranoside) provides sweetness, and is used as a bulking agent, texture modifier, preserving agent, and fermentation substrate in food applications [44]. Sucrose is also useful as a carrier for food ingredient encapsulation because of the following properties: (i) quick dissolution in water producing a clear solution; (ii) heat stability; (iii) nonhygroscopicity; (iv) indefinite shelf life under ambient conditions; and (v) inexpensive nature [45].

In extrusion processing, sucrose and other mono- and disaccharides provide flavor, sweetness, energy, texture, stabilization, water activity control, and color control [46]. Sucrose and maltodextrin mixtures are the most commonly used coatings for extrusion encapsulation [47,48]. Flink and Karel [21] reported that retention of volatiles by carbohydrates during lyophilization was roughly in the order of sucrose > maltose  $\geq$  lactose > glucose  $\gg$  dextran T-10. In the case of lactose, its crystal form as well as the structure of the volatile influenced the amount of absorption [49].

Sucrose is used for encapsulating food flavors by a process known as cocrystallization [45,50–52]. Before it can be employed, however, its chemical structure needs to be modified from a single perfect crystal to that of a microsized, irregular, agglomerated form, before cocrystallization occurs. This modified structure has an increased void space and surface area, which provide a porous bed or base for the incorporation of active ingredients.

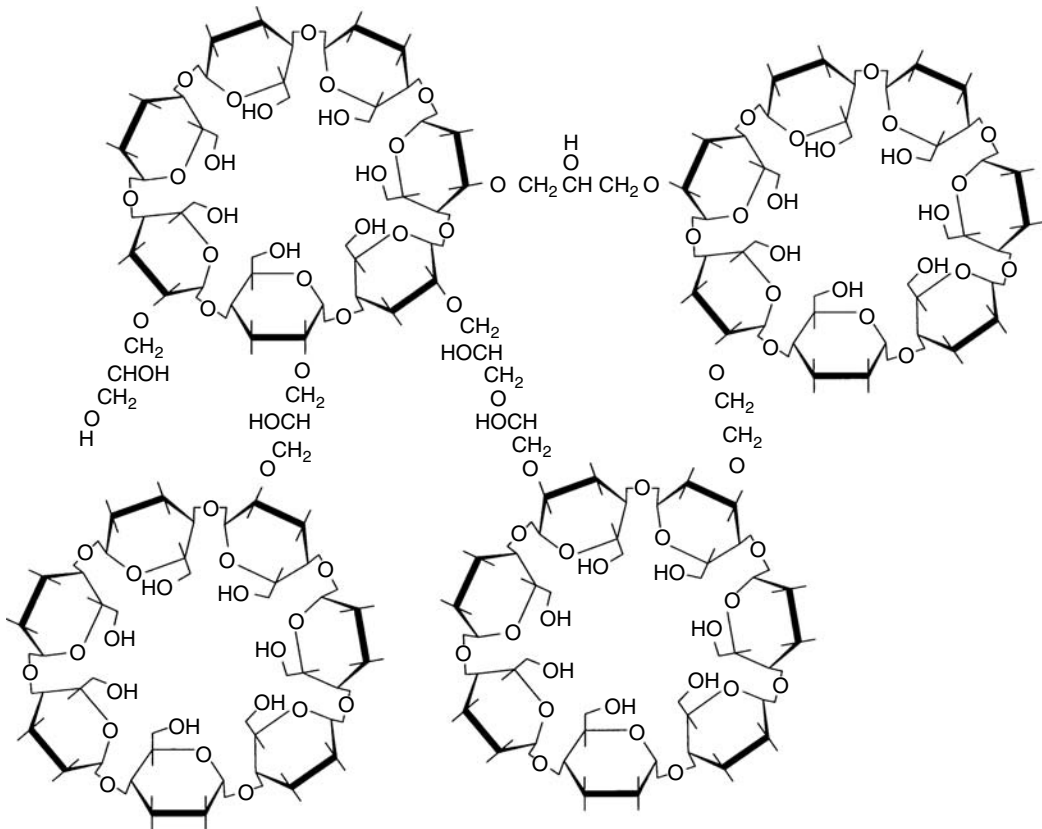


FIGURE 22.4 Structure of a polymeric, modified  $\beta$ -cyclodextrin. (From D. E. Pszczola, *Food Technol.* 42(1): 96, 1988.)

### 22.2.1.6 Chitin and Chitosan

Chitin is a  $\beta$ -(1 $\rightarrow$ 4)-linked linear polymer of 2-acetamido-2-deoxy-D-glucopyranosyl residues and is a main constituent of the exoskeleton of crustaceans such as crab. Chitosan is the principal product from the alkaline hydrolysis of chitin: it consists of 2-deoxy-2-aminoglucopyranosyl residues joined by  $\beta$ -(1 $\rightarrow$ 4) linkages. Complex coacervate capsule formation can occur between chitosan (a cationic polyglucosamine) and carrageenan or alginic acid (anionic in nature).

Gel bead formation can be achieved by interaction of chitosans with low molecular counterions such as polyphosphates. The gelling properties of chitosans allow for a wide range of applications, the most attractive being coating of foods and pharmaceuticals, and gel entrapment of biochemicals, plant embryos and whole cells, microorganisms, or algae [53,54]. Such entrapment offers diverse uses including microencapsulation and controlled release of flavors, nutrients, or drugs. Because chitosan has been shown to be an effective agent, concurrent cell permeabilization and immobilization using chitosan-containing complexes of coacervate capsules have been explored [53,54].

Polycationic chitosan molecules can be incorporated with oppositely charged polymers to form coacervate capsules of good mechanical strength. The permeability of these coacervate capsules can be controlled by either altering the type of chitosan or the counterion [55].

### 22.2.1.7 Cellulose

Cellulose is the main constituent of plant cell walls. It consists of glucopyranosyl residues joined by  $\beta$ -(1 $\rightarrow$ 4) linkages. Together with some other inert polysaccharides (e.g., lignin), cellulose constitutes the indigestible carbohydrate fraction of plant foods, referred to as dietary fiber. Until recently, the importance of dietary fibers in human nutrition appeared mostly to be the maintenance of intestinal mobility (peristalsis); however, "functional fiber" has been defined as consisting of isolated, nondigestible carbohydrates that

have beneficial physiological effects in humans. Functional fiber may bind bile acids or cholesterol in the intestine, preventing their reabsorption by the body. The liver responds by taking up more low-density lipoprotein (LDL) cholesterol from the blood stream, thereby lowering the concentration of LDL cholesterol in the blood. Short-chain fatty acids, products of fermentation from functional fiber in the gut, may inhibit synthesis of cholesterol by the liver, reducing the concentration of blood cholesterol. The high viscosity of soluble fiber may slow the rate of digestion and absorption of carbohydrates, affecting insulin activity, which is implicated in the removal of LDL-cholesterol from the blood.

Cellulose as an edible film for food preservation and other functional ingredients in food processing have attracted a lot of research interest [56–58]. Native cellulose is insoluble in water owing to the high level of intramolecular hydrogen bonding in the cellulose polymer [25]. As an edible film for food coatings, the permeability of cellulose coatings can be modified by combining them with other coating materials via etherification [59]; that is, reacting cellulose with aqueous caustic and then with methyl chloride, propylene oxide, or sodium monochloroacetate to yield methylcellulose, hydroxypropyl methylcellulose, hydroxypropylcellulose, and sodium carboxymethylcellulose [25]. It was found that methyl- and hydroxypropyl methylcellulose mixed with lauric, palmitic, stearic, and arachidic acids significantly ( $P < 0.05$ ) lowered the permeation rate relative to cellulose ether films containing no fatty acids [60]. Cellulose has always been used in encapsulation of water-soluble food ingredients such as sweeteners and acids. Furthermore, it can be used to encapsulate enzymes and cells [61].

## 22.2.2 Gums

One class of material often exploited for its encapsulating capabilities is that of hydrocolloids, or more commonly, gums. These compounds are long-chain polymers that dissolve or disperse in water to give a thickening or viscosity-building effect [62]. Gums are generally used as texturing ingredients, but their secondary effects include encapsulation capabilities [63], stabilization of emulsions, suspension of particulates, control of crystallization, and inhibition of syneresis (i.e., the release of water from fabricated foods) [64,65]. Additionally, a few gums are capable of forming gels.

Food gums are obtained from a variety of sources. Although most gums are obtained from plant materials, such as seaweed (e.g., carrageenans and alginates), seeds (e.g., locust bean gum and guar gum), and tree exudates (e.g., gum acacia); others are products of microbial biosynthesis (e.g., xanthan gum and gellan gum); and still others are produced by chemical modification of natural polysaccharides. Some commonly used gums as coating materials for food ingredient encapsulation are discussed below.

### 22.2.2.1 Seaweed Extracts

Alginates, agar, and carrageenan are extracts from red (*Rhodophyceae*) and brown (*Phaeophyceae*) algae, which are collectively referred to as seaweeds [66]. Their use in encapsulation processes is well documented. A major source of industrial production of alginates is the giant kelp, *Macrocystis pyrifera*, which is harvested mechanically off the coast of California. Other seaweed species of alginates include *Laminaria hyberborea*, *Laminaria digitata*, and *Ascophyllum nodosum*. Algae are extracted with alkali from seaweed, and the polysaccharide is usually precipitated from the extract by the addition of acids or calcium salts.

Alginates are salts of alginic acid and include a variety of products made up of poly- $\beta$ -D-mannopyranosyluronic ( $\beta$ -D-mannuronic) and poly- $\alpha$ -L-gulopyranosyluronic ( $\alpha$ -L-guluronic) acids joined in a linear fashion by  $\alpha$ -(1 $\rightarrow$ 4) linkages [67]. They are arranged either in regions composed solely of one unit or the other, referred to as M-blocks and G-blocks, or in regions where the two units alternate [66]. In alginates, both the ratio of mannuronic acid to guluronic acid and the structure of the polymer govern how effectively the chains associate during gel formation. Alginates are powerful thickening, stabilizing, and gel-forming agents and are utilized in a variety of foods. At a level of 0.25%–0.5%, they improve and stabilize the consistency of fillings for baked products, salad dressings, and milk chocolate, and prevent the formation of large ice crystals in ice cream during storage. They are also used as an encapsulating agent. It has been reported that water-soluble alginate was capable of forming encapsulated liquid capsules [68]. Alginate films tend to be quite brittle when dry but may be plasticized by the inclusion of glycerol [69]. Viscous high-fat food can also be encapsulated with calcium alginate [70].

Agar is a heterogeneous complex mixture of related polysaccharides having the same backbone chain structure. Its main component is  $\beta$ -D-galactopyranosyl linked (1 $\rightarrow$ 4) to a 3,6-anhydro- $\alpha$ -L-galactopyranosyl



unit and partially esterified with sulfuric acid. Deemed as one of the most potent gel-forming agents, agar produces perceptible gelation at concentrations as low as 0.04%. The gelling properties of the gum, the heat resistance of its gels, and the differential between the gel-forming and melting temperatures are the primary reasons for selecting agar. Agar is best known as a culture medium and is not employed to any great extent in foods. Nevertheless, chlorella agar has been used for the encapsulation of flavors [71].

Carrageenan is extracted mainly from the red seaweed species, *Chondrus crispus*, with water and a small amount of alkali, followed by filtration and recovery by alcohol precipitation [25]. It is composed of  $\beta$ -D-galactose and 3,6-anhydro- $\alpha$ -D-galactose that are partially sulfated as 2-, 4-, and 6-sulfates and 2,6-disulfates. The galactose residues are alternately linked by 1–3 and 1–4 linkages. There are three principal carrageenan fractions: iota ( $\iota$ ), kappa ( $\kappa$ ), and lambda ( $\lambda$ ).  $\kappa$ -Carrageenan fractions contain the lowest number of sulfate groups and the highest concentrations of the 3,6-anhydro- $\alpha$ -D-galactopyranosyl units.  $\iota$ -Carrageenan differs from  $\kappa$ -carrageenan with an additional sulfate group at the 2-position, whereas  $\lambda$ -carrageenan differs from  $\kappa$ - and  $\iota$ -carrageenan by having variable amounts of sulfate groups and no 3,6-anhydro- $\alpha$ -D-galactopyranosyl residues [25].

Carrageenan utilization in food processing is based on the ability of the polymer to gel, increase solution viscosity, and stabilize emulsions and various dispersions. Gels from carrageenan are thermoreversible. Because of its reactivity with certain proteins, the gum has found use at low concentrations (typically 0.01%–0.03%) in a number of food products. Locust bean gum is compatible with carrageenan, forming a cooperative association with the double helix structure, and increasing the elasticity of the resultant gels. A process for producing capsules containing meat soup or juice with agar–agar, carrageenan or pectin coatings has been developed by Hoashi [72].

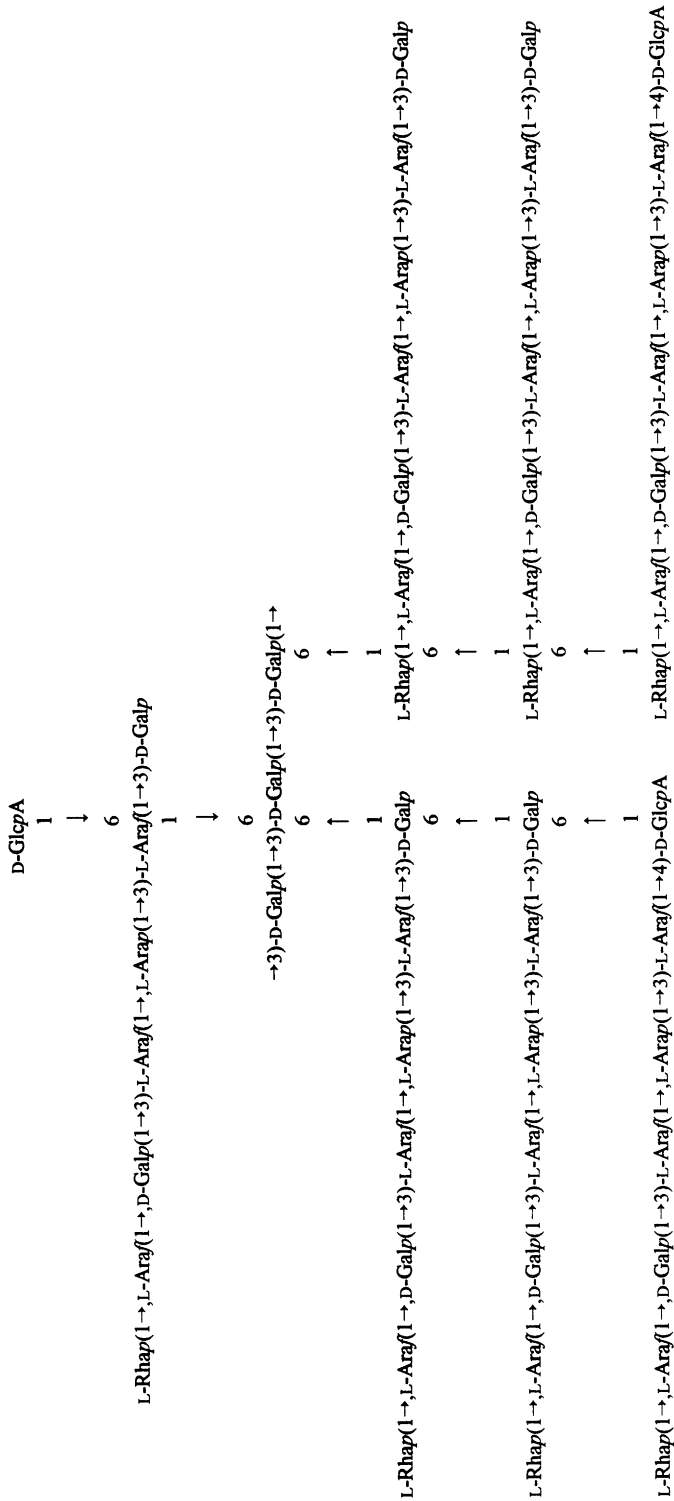
#### 22.2.2.2 Exudate Gums

Gum arabic (acacia), gum ghatti, gum karaya, and gum tragacanth are referred to as exudate gums. Exudate gums are structurally complex heteropolysaccharides obtained from certain shrubs and small trees that grow predominantly in Africa and Asia [73]. The term “exudates” refers to the fact that gums are secreted or exuded in response to plant tissue injury. Upon exposure to the atmosphere, they form extremely hard, glossy nodules or flakes that can be harvested [25]. Among these, gum arabic, which is a natural vegetable colloid obtained by exudation from the trunk and branches of leguminous plants of the Acacia family, primarily *Acacia senegal*, is the most commonly used encapsulation coating material [74,75]. Although there are several hundred species of Acacia, only a few are gum producers and these are located in the subdesert region of Africa.

Gum acacia is a neutral or slightly acidic salt of a complex polysaccharide with an average molecular weight range of 260–1160 kDa. Gum acacia primarily consists of D-galactopyranosyl, L-rhamnopyranosyl, L-arabinopyranosyl, L-arabinofuranosyl, and D-glucopyranosyluronic acid. It contains ~2%–3% protein with an arabinogalactan–protein complex and is rich in hydroxyproline, serine, and proline. This protein fraction is responsible for the emulsification properties of the gum. The gum also exists as a mixed salt of sodium, calcium, magnesium, and potassium ions. Owing to the complex character of this polymer, the stereochemical organization of the molecule is not completely understood even though the qualitative and quantitative analysis of the sugars is. A hypothesis of the structure of gum *A. senegal* is presented in Figure 22.5.

Gum acacia is the traditional gum of choice for flavor encapsulation via spray drying. It dissolves readily in hot or cold water, is an outstanding natural emulsifier, is the least viscous and the most soluble of the hydrocolloids, is stable in acidic media, and rates well based on criteria used in evaluating a flavor carrier. Because beverage applications account for a large proportion of dry flavorings used, emulsion stability in the finished product is one of the most important criteria in carrier selection. Gum acacia has the advantage of being considered natural in virtually all countries. An interesting and unique property of gum acacia is its low viscosity in aqueous solutions. Although solutions containing up to 50% gum can be prepared, the solution viscosity starts to rise steeply at concentrations greater than 35%. Most other gums yield solutions with high viscosity at concentrations as low as 1%. It would be impossible to effectively atomize these very viscous emulsions, and so these other gums are not very useful, especially as flavor encapsulants.

Gum acacia is also applied as a flavor fixative in the production of powdered aroma concentrates. While modified food starches are superior to traditional gum acacia in emulsion stability, gum acacia, nevertheless, produces quite stable emulsions. The emulsions are then spray dried. In this process, the polysaccharide forms a film surrounding the oil droplet, which then protects the oil against oxidative degradation. Compared



**FIGURE 22.5** Proposed structure of gum acacia (*Acacia senegal*), where L-Rhap =  $\beta$ -L-rhamnopyranosyl; L-Ara $\beta$  =  $\beta$ -L-arabinofuranosyl; D-Galp =  $\beta$ -D-galactopyranosyl; L-Ara $\alpha$  =  $\beta$ -L-arabinopyranosyl; and D-Glc $\alpha$ A =  $\beta$ -D-glucuronopyranosyl acid. (From F. Thevenet, *Encapsulation and Controlled Release of Food Ingredients*, S. J. Risch and G. A. Reineccius, eds., ACS Symposium Series No. 590, American Chemical Society, Washington, DC, 1995, p. 51.)

to maltodextrins, gum acacia offers superior aroma retention during drying, and very little aroma is lost during storage at humidities below the water monolayer level [76]. New generation gums (blends of West African gums) have been shown to be superior even to modified starches for stabilizing flavor emulsions [24]. Protection of oxidizable flavorings by gum acacia varies with the source of the gum. The traditional gum acacia is not quite as good as the modified food starch/corn syrup solids blend and is quite inferior to the blends of West African gums [24]. Blends of gum acacia with maltodextrins and the new West African gum acacia can be used to encapsulate flavors and offer excellent stability to oxidation [77].

Gum ghatti is an amorphous translucent exudate of the *Anogeissus latifolia* tree of the family Combretaceae, which is native to India [69]. It is a water-soluble, complex polysaccharide consisting of L-arabinofuranosyl, D-galactopyranosyl, D-mannopyranosyl, D-xylopyranosyl, and D-glucopyranosyluronic acid units. As a whole, it is nongelling but can be dispersed in hot or cold water to give a colloidal sol that develops due to a soluble fraction. The gum closely resembles the viscosity and emulsifying properties of gum acacia and has been effectively utilized in food systems as an emulsifier and a stabilizer. Gum ghatti is seldom used because of a limited supply [66].

Gum karaya is the dried exudate of the *Sterculia* tree, which grows in central and northern India; hence, it is routinely referred to as Indian gum. It occurs naturally as a complex, partially acetylated branched polysaccharide containing ~37% uronic acid residues and ~8% acetyl groups. Gum karaya comprises a central chain of D-galactopyranosyl, L-rhamnopyranosyl, and D-galactopyranosyluronic acid units, with some side chains containing D-glucopyranosyluronic acid [69]. It swells very easily in water and absorbs water very rapidly to form viscous colloidal dispersions at low concentrations. The gum forms smooth films that can be plasticized with compounds such as glycols to reduce brittleness [25].

Gum tragacanth is the dried gum exuded by the stems of *Astragalus gummifer* and other Asiatic species of *Astragalus*. The plants grow wild in certain areas of Asia Minor and in the arid and mountainous regions of Iran, Syria, and Turkey. Gum tragacanth has a complex structure and upon hydrolysis yields D-galacturonic acid, L-fucose, D-galactose, D-xylose, and L-arabinose. According to Glicksman [69], it comprises a mixture of a water-insoluble component, tragacanthic acid, that constitutes ~60%–70% of the gum and a water-soluble component, tragacanthin or arabinogalactan, in which L-arabinose is the predominant sugar. Gum tragacanth swells rapidly in either cold or hot water to form highly viscous colloidal sols or semigels, which act as protective colloids and stabilizing agents. The gum is generally used as a thickener and stabilizer in salad dressings, sauces, bakery emulsion, toppings, ice cream, and confectionery.

## 22.2.3 Lipids

### 22.2.3.1 Waxes

Waxes are important derivatives of higher alcohols, such as C<sub>12</sub>–C<sub>28</sub>, which are esterified to long chain fatty acids. Traditionally, wax coatings have been applied to fresh fruits and vegetables to extend their postharvest storage life. Edible waxes are significantly more resistant to moisture transport than most other lipid or nonlipid coatings. It has been reported that waxes are most effective in blocking moisture migration; paraffin wax being the most resistant followed by beeswax [78–80]. For this reason, waxes are commonly used as lipid coatings for encapsulation of food ingredients, particularly for the encapsulation of water-soluble ingredients. In 1980, petroleum wax was permitted for use by the US Food and Drug Administration in formulating microcapsules for encapsulation of spice-flavoring substances in frozen pizza [81].

The great resistance of paraffin and beeswax coatings to diffusion of water is related to their molecular compositions. Paraffin wax consists of a mixture of long-chain, saturated hydrocarbons, while beeswax comprises 71% hydrophobic, long-chain ester compounds; 15% long-chain hydrocarbons; 8% long-chain fatty acids; and 6% other compounds [82,83]. The absence of polar groups in paraffin and the relatively low level in beeswax account for their marked resistance to moisture transport.

### 22.2.3.2 Acetoacylglycerols

Acetylation of glycerol monostearate, by its reaction with acetic anhydride, yields 1-stearodiacetin. This acetylated monoacylglycerol displays unique characteristics of solidifying from the molten state into a flexible, wax-like solid.

**TABLE 22.3**

Percentage of Phosphatidyl Compounds in Unfractionated and Fractionated Soy Lecithin

Type	Unfractionated	Ethanol-Soluble Fraction	Ethanol-Insoluble Fraction
Phosphatidylethanolamine	32.6	32.5	32.6
Phosphatidylcholine	32.6	65.1	4.6
Phosphatidylinositol	34.8	2.4	62.8

Source: H.-D. Belitz and W. Grosch, *Food Chemistry*, Springer, Berlin, 1987, p. 128.

It is found that the barrier properties of acetoacylglycerol improve as the degree of acetylation increases. This is due to the removal of free hydroxyl groups that would otherwise interact directly with migrating water molecules or other small polar molecules. The lower permeability through the acetoacylglycerol film prepared from technical grade monoacylglycerols might be a consequence of the difference in crystal packing or the number of free hydroxyl groups [79]. Although the water vapor permeability of acetylated monoacylglycerol films is considerably less than that of most polysaccharide films, it is greater than the permeability values of ethyl- and methylcellulose [84].

### 22.2.3.3 Lecithins

Lecithin plays a significant role as a surface-active substance in the production of emulsions. Pure lecithin is a W/O (water in oil) emulsifier with an HLB (hydrophile–lipophile balance) value of ~3. Because commercially used lecithins are complex mixtures of lipids, their HLB values vary considerably.

Major phospholipids of raw soya lecithin are listed in Table 22.3 [85]. The ethanol-insoluble fraction is suitable for stabilization of W/O emulsions and the ethanol-soluble fraction for O/W (oil in water) emulsions. To increase the HLB value, “hydroxylated lecithins” are prepared by controlled partial oxidation of unsaturated acyl residues with hydrogen peroxide or benzoyl peroxide [85].

Lecithin vesicles have recently been used for encapsulation of food enzymes since the formation of lecithin capsules can be achieved under relatively low temperatures. By using lecithin vesicles to encapsulate lysozyme and pepsin, it was found that the encapsulating efficiency was best when the pH was close to the isoelectric point of each enzyme [86].

Blended with other coating materials, lecithin will change the structure of microcapsules formed. Studies on the encapsulation of  $\beta$ -galactosidase in lecithin–cholesterol liposomes prepared by dehydration–rehydration and reverse-phase evaporation by Matsuzki et al. [87] revealed that encapsulation efficiency decreased as cholesterol content increased. A mixture of lecithin and polyethylene has been used for encapsulating other active ingredients, such as sweeteners and flavor compounds [88]. As a nutrient, lecithin has also been encapsulated as a dietary supplement [89].

### 22.2.3.4 Liposomes

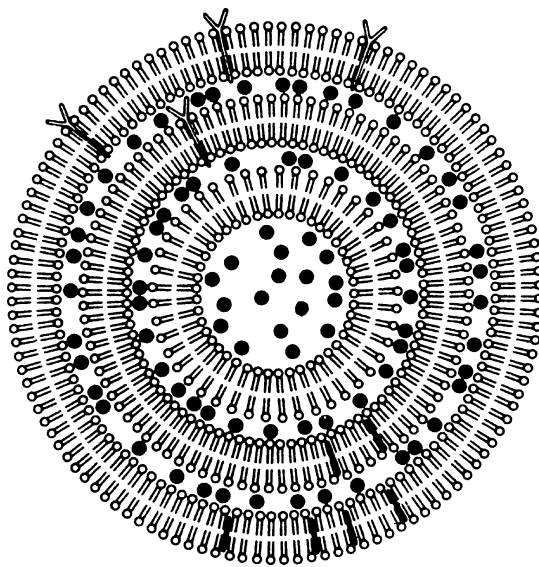
When amphiphilic molecules, such as lipids, surfactants, and copolymers, possessing both polar and non-polar characteristics, are dispersed in a polar solvent, hydrophobic interactions cause them to spontaneously self-assemble into a rich array of thermodynamically stable, lyotropic, liquid crystalline phases with characteristic length scales in the nanometer range [90]. A liposome (or lipid vesicle) is defined as a spherical, polymolecular aggregate of lipid bilayers that enclose a number of aqueous or liquid compartments [91]. Like micelles, liposomes can incorporate a wide variety of functional ingredients in their interior. Unlike micelles, however, they can be used to encapsulate both water- and lipid-soluble compounds. Prepared by a variety of techniques, liposomes consist of one, few, or many concentric bilayer membranes whose size varies from ~20 nm to a few hundred  $\mu\text{m}$  in diameter (Figure 22.6). Their core is aqueous in nature, with its chemical composition corresponding to that of the aqueous solution in which the vesicles are prepared. Because of the charge of the polar lipids employed in liposome preparations, charged but water-soluble ionic species can be trapped inside the vesicles. The pH and ionic strength of the liposomal core can therefore differ from those of the continuous phase in which the liposome might later be dispersed [90].

Over the past 30 years, liposomes have been studied extensively in the medical and pharmaceutical areas because of their potential use as targetable carriers of drugs and bioactive macromolecules [92]. Liposome microencapsulation technologies have been developed almost to the point where they can be employed in a variety of commercial applications. There has been interest in use of liposomes in the food industry for development of new food and functional food products with improved characteristics, especially for encapsulation or immobilization of enzymes. Recently, Taylor et al. [93] have reviewed many of these applications. For example, studies on liposomes used to increase the shelf life of dairy products by encapsulating lactoferrin (a bacteriostatic glycoprotein) as well as nisin Z (an antimicrobial polypeptide) were cited. Efficacy of encapsulated antimicrobials has also been reported by Gaysinsky et al. [94] and Were et al. [95].

Liposomes are prepared from phospholipids such as those of egg yolk or soybean lecithins. Semisynthetic phospholipids with fatty acid chains of defined length and saturation as well as cholesterol are also employed for specific purposes. The choice of the type of phospholipid and the quantity of cholesterol play important roles in determining liposomal stability upon storage and their fate in injected animals [92]. Virtually any substance regardless of its solubility, electrical charge, molecular size, or other structural characteristics can be incorporated into liposomes, provided that the substance does not interfere with liposome formation [92]. Water-soluble materials may be entrapped in the aqueous phase of liposomes, whereas lipid-soluble materials will be incorporated into the lipid phase. For example, liposomes have been successfully used to encapsulate proteins and provide a microenvironment in which the proteins can continue to function regardless of external environmental conditions.

Liposome structure is determined by its method of preparation. Although various techniques exist for preparing liposomes [96,97], they are generally divided into three classes, namely, multilamellar vesicles (MLVs), small unilamellar vesicles (SUVs), and large unilamellar vesicles (LUVs). MLVs were first prepared by Bangham et al. [98]. In a typical preparation, a solution of phospholipids in chloroform is evaporated producing a thin film, which is then hydrated with an aqueous solution. The main advantage of MLVs is that the lipid and the aqueous solution to be encapsulated are not subjected to harsh treatments such as exposure to organic solvents or to high-intensity ultrasound. A major disadvantage of MLVs, however, is their heterogeneous size distribution (diameters in the range 0.2–2.0  $\mu\text{m}$ ) and their low encapsulation efficiency (5%–14%) [99]. SUVs were first prepared from MLVs by sonication. High-intensity ultrasound results in MLVs of a much smaller size (25–50 nm in diameter). The second method for producing SUVs involves injection of lipid, dissolved in ethanol into the desired aqueous phase. The resulting vesicles had diameters in the range of 30–110 nm, while a third technique involves pumping of MLVs through a French pressure cell to produce liposomes with diameters in the range of 30–50 nm [97]. The main disadvantage of SUVs is their small diameter and consequently their low capture volume. Several methods are available for the production of LUVs, whose size ranges from 100 to 500 nm; these are often the most useful liposomes. Three common methods for their preparation are infusion, reverse-phase evaporation, and detergent dilution. In general, LUVs are more homogeneous than MLVs and have a higher encapsulation efficiency than SUVs.

A serious drawback of the aforementioned liposome preparations for their application in foods and functional foods has been the employment of organic solvents. Liposome microencapsulation using a microfluidizer eliminates this problem because the method does not utilize any organic solvent or



**FIGURE 22.6** Molecular organization of a liposome. (From F. Shahidi and X.-Q. Han, *Crit. Rev. Food Technol.* 33: 501, 1993.)

detergent. The two most common microencapsulation techniques, spray-drying and extrusion, encounter major problems with flavor encapsulation: the occurrence of oxidative reactions and inability to implement procedures for intermediate-moisture foods [91]. A limitation of the use of liposomes in some food applications may be their lack of stability in the presence of moderate levels of oils or hydrophobic proteins.

#### 22.2.4 Proteins

An important nutrient in food, proteins possess many desirable functional properties. These properties allow them to be good candidates as coating material for the encapsulation of food ingredients, even though food hydrocolloids are mostly used. Gelatine is the most commonly used protein for this purpose, but other proteins such as sodium caseinate, whey protein, soy protein concentrates, and soy protein isolates have been utilized [100].

Gelatine is a water-soluble protein derived from collagen and is a valuable coating material partially because it is nontoxic, inexpensive, and commercially available. In addition to good film-forming properties, gelatine has other ideal chemical and physicochemical characteristics that lend themselves to microencapsulation. For example, gelatine forms thermally reversible gels when warm aqueous suspensions of polypeptides are cooled. With an aqueous solution of gelatine, the change between the gel and solid state is quite definite. However, when the gelatine concentration in the aqueous solution is lower than ~1%, definite gelation cannot be observed even by cooling. These characteristic properties are effectively used in the formation of capsules.

The isoelectric point of gelatine and its derivatives can be changed depending upon the method of preparation [101]. By changing the pH of the aqueous solution, either polycationic or polyanionic effects are exhibited by gelatine. This property is used for coacervation formation.

Gelatine is often used in combination with gum acacia to form coating films. Gum acacia, a hydrocolloid derived from plant sources, consists mainly of carboxylic acid functional groups. When the pH is lower than its isoelectric point, gelatine becomes polycationic, and hence there is an interaction between polycationic gelatine and polyanionic gum acacia, resulting in the formation of a coacervation. As an example, if pigskin gelatine (isoelectric point pH 8–8.5) in aqueous solution is mixed with gum acacia at pH 4.0–4.5, a complex coacervation will form because of charge attraction between the negatively charged acacia gum and the positively charged gelatine [101]. Fixing (insolubilization) of this structure can be achieved by the use of cross-linking agents such as ionized calcium. The type of gelatine and gum acacia selected and the formation and fixing procedures employed ultimately influence coating permeability [101]. Coating formation can also be achieved by a solvent evaporation technique.

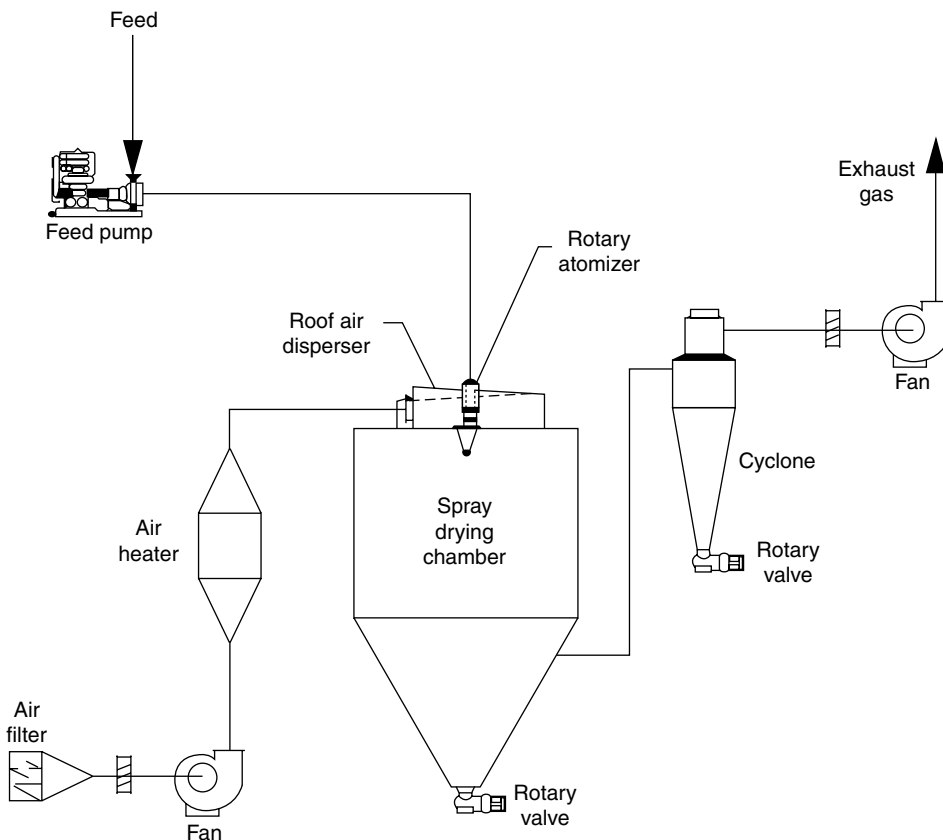
Protein-encapsulated tallow and vegetable oils have been applied to produce animal feeds [102]. Proteins can also be used, together with other coating materials, to form microcapsules. A mixture of protein and carbohydrate has been applied to an encapsulation process of oily substances [103,104].

---

## 22.3 Microencapsulation Techniques

### 22.3.1 Spray Drying

Spray drying accounts for the majority of commercial encapsulated materials in food products [19]. It is typically used for the preparation of dry stable food additives, functional ingredients, and flavors. At first it is by no means obvious that spray drying is suitable for encapsulating flavors, because in principle the volatile flavor compounds evaporate faster than water. It is only a question of finding suitable carriers that prevent the volatile flavor compounds from being lost during the drying process, yet simultaneously allow water to evaporate unhindered [105]. Spray drying is economical, flexible in that it offers substantial variation in encapsulation matrix, adaptable to commonly used processing equipment, and produces particles of good quality [106–108]. In fact, spray drying production costs are lower than those associated with most other methods of encapsulation. It is also one of the oldest and well-known encapsulation techniques—the C.E. Rogers Co. has been manufacturing spray dryers since the early 1900s—and is a standard technology in the food industry, especially the dairy industry [109]. In the 1930s, spray drying was employed to prepare the first encapsulated flavors using gum acacia as the coating [110].



**FIGURE 22.7** Typical spray-drying operation consisting of a drying chamber fitted with an atomizer, air heater, fan or blower, and cyclone for product recovery. (From J. D. Dziejak, *Food Technol.* 42(4): 136, 1988.)

Although spray drying is most often considered as a dehydration process and is used in the preparation of dried materials such as powdered milk, it can be used as an encapsulation process when it entraps active materials/bioactives within a protective matrix formed from a polymer or melt. In most cases, the encapsulated actives are released upon contact of the product with water, which dissolves the spray-dried capsules [19]. The process is conducted in a spray dryer such as the one shown in Figure 22.7 and involves the basic steps discussed below.

### 22.3.1.1 Preparation of the Dispersion or Emulsion

The initial step in spray drying an encapsulated food ingredient is the selection of a suitable wall material or encapsulating agent. The ideal choice should have adequate emulsifying properties; be a good film former; have low viscosity at high solids levels (<500 cps at  $\geq 45\%$  solids levels); exhibit low hygroscopicity; release the coated ingredients when reconstituted in a finished food product; be low in cost, bland in taste, and stable in supply; and afford good protection to the encapsulated ingredients [29,111]. A food-grade hydrocolloid, such as gelatine, vegetable gum, modified starch, dextrin, or non-gelling protein [16], is generally used as an encapsulating agent.

Once a wall material or combination has been selected, it must be hydrated. It is desirable to use a particular infeed solids level that is optimum for each encapsulating agent or the combination chosen. Research has shown that infeed solids level is the most important determinant of flavor retention during the spray-drying process [24]. Increasing solids level up to the point that the additional solids are no longer soluble benefits flavor retention by decreasing the required drying time to form a high solids surface film around the drying droplets. Once the droplet surface reaches  $\sim 10\%$  moisture, flavor molecules

cannot diffuse through this surface film, while the relatively smaller water molecules continue to do so and are lost to the drying air [112–115].

A high infeed solids means that this semipermeable membrane forms quickly and thus assists flavor retention. It is possible to pump and atomize infeed materials that contain encapsulating agent solids in excess of the solubility limits. Insoluble solids offer no barrier to the diffusion of flavor molecules and therefore do not improve flavor retention during drying. It has been found that there is an optimum infeed solids level that is unique for each wall material [111,116,117].

Once the encapsulating agent or mixture has been solubilized (with or without heating), the flavor or ingredient to be encapsulated is added to the mixture and then thoroughly dispersed throughout the system. A typical ratio of encapsulating agent to core material is 4:1, but in some applications higher flavor loads are used. Brenner et al. [118] have obtained a patent for a process that produces high-load spray-dried flavorings. They claim that high surface oils and poor flavor retention during drying are largely due to particle shrinkage and cracking during the dehydration process. A cracked particle surface results in substantial flavor loss during drying. Brenner et al. [118] used a combination of polysaccharides (e.g., gum arabic, starch derivatives, and dextrinized and hydrolyzed starches) and polyhydroxy compounds (e.g., sugar alcohols, lactones, monoethers, and acetals) to form an encapsulating mixture that remained plastic during spray drying. Using this plastic encapsulating agent, Brenner et al. [118] reported to have spray-dried infeed materials with a flavor load of up to 75% (based on dry solids). Mass balance data showed oil recoveries of 80% at this high loading. Higher flavor loads, however, typically result in an unacceptable loss of flavors in the dryer. For example, Emberger [119] has shown that compared to a 10% loading, only 33%–50% of the flavor was retained during drying when a 25% flavor load was used.

### **22.3.1.2 Homogenization of the Dispersion**

Prior to spray drying, the mixture is homogenized to create small droplets of flavor or ingredient within the encapsulating solution. The creation of a finer emulsion increases the retention of flavor during the drying process [11]. Sometimes, the addition of an emulsifier is required and the dispersion is then homogenized prior to spray drying. However, considerable process variation exists within the industry in this respect. Risch and Reineccius [120] reported a direct relationship between the degree of homogenization and the retention of orange peel oil during spray drying. Therefore, it appears advantageous to efficiently homogenize the dryer infeed material. Water-soluble materials may also be encapsulated by the treatment of homogenization. Instead of having a clearly defined core and coating, the product consists of a homogeneously blended matrix of the polymer entrapping the core. These products are sometimes described as matrix particles or entrapped ingredients. They are also said to be covered with a very fine film of coating.

### **22.3.1.3 Atomization of the Infeed Emulsion**

The core–wall material mixture is fed into a spray dryer where it is atomized through a nozzle or spinning wheel. The single-fluid, high-pressure spray nozzle and the centrifugal wheel are two types of atomizers that are widely used; the industry is nearly equally divided between their utilization. Although each type of atomizer has its advantages and disadvantages, there is nothing in the literature that suggests that one type is superior to the other.

Atomization parameters have a significant effect on the particle size distribution of the resultant powders. Several researchers have reported that larger particles result in improved flavor retention, but Reineccius and Coulter [22] found that particle size had no effect on flavor retention. However, studies by Chang et al. [121] indicated that there is an optimum particle size for flavor retention. Part of the controversy is cleared up by Bomben et al. [115], who showed that particle size is insignificant if high infeed solids were used. This might explain why some authors found a relationship between particle size and flavor retention while others did not. Although particle size may have a minimal influence on flavor retention during drying, it is often desirable to produce large particles to aid in dispersion upon reconstitution. Small particles are often difficult to disperse and tend to float on liquid surfaces. Larger



particles can be prepared by using a large orifice, low atomization pressure (pressure nozzle only), high infeed solids, high infeed viscosity, low wheel speed (centrifugal wheel atomization only), or some type of agglomeration technique [122].

#### **22.3.1.4 Dehydration of the Atomized Particles**

When hot air flowing in either a cocurrent or countercurrent direction contacts the atomized particles, water is evaporated and a dried product consisting of starch or encapsulating matrix containing small droplets of flavor or core is formed. As the atomized particles fall through the gaseous medium, they assume a spherical shape with the oil encased in the aqueous phase. This explains why most spray-dried particles are water soluble. The rapid evaporation of water from the coating during its solidification keeps the core temperature below 100°C in spite of the high temperatures used in the process [123]. The particles' exposure to heat is in the range of a few seconds at most [16]. Thus, the main advantage to this method is its ability to handle many heat-labile materials. Because a flavor may contain as many as 20–30 different components (alcohols, aldehydes, esters, ketones, etc.) with boiling points ranging from 38°C to 180°C, it is therefore possible to lose certain low-boiling point aromatics during the drying process [106]. The dried particles fall to the bottom of the dryer and are collected or they may be separated by a gas–solid separation unit such as a dust cyclone. Spray-dried ingredients typically have a very small particle size (generally less than 100 µm) that makes them highly soluble but may present separation problems in dry blends. Separation can be prevented and fluidity improved by a separate compacting or agglomeration step; in the latter, encapsulated particles are treated with steam to induce their cohesion and form large particles. Factors such as coating structure may also affect the solubility of the spray-dried microcapsules [124].

The processes of compacting and agglomeration complement spray drying. In both processes the objective, as stated above, is to obtain larger particles. Compacting gives a compressed product with lower porosity (strength). For example, spray-dried flavors are compressed under high pressure into lumps and then crushed to small pieces ranging in size from 0.7 to 3.0 mm. This process is useful for applications where a grainy structure is required to assure that flavors will not separate (e.g., in tea bags). In contrast, agglomeration products are loose products with high porosity (instant properties). Spray-dried product is fluidized in hot air. The fluidization singles out powder particulates and allows them to be sprayed from all sides. By spraying onto a binder, such as water, the powder particles gradually stick to one another forming larger particles [105].

#### **22.3.2 Spray Cooling and Spray Chilling**

Spray cooling and spray chilling are two commercially practiced encapsulation processes similar to spray drying in that both involve dispersing the core material into a liquefied coating material and spraying through heated nozzles to a controlled environment [125]. Unlike spray drying, however, there is no water to be evaporated since the coating material is a fat. Other principal differences between these processes and spray drying lie first in the temperature of the air used in the drying chamber and second in the type of coating applied. Spray drying employs hot air to volatilize the solvent from a coating dispersion; in contrast, spray cooling and spray chilling use air cooled to ambient or refrigerated temperatures. The core and lipid wall mixture are atomized in the chilled air that causes the fat to solidify around the core, thereby forming a crude encapsulated product.

Microcapsules produced by spray chilling and spray cooling are insoluble in water due to the hydrophobic coating. Consequently, these techniques tend to be utilized for encapsulating water-soluble core materials such as minerals, water-soluble vitamins, enzymes, acidulants, and some flavors. The major drawbacks of spray chilling include interactions between the fat and the active ingredient, volatilization of lipid-soluble materials over time, and loss of volatile materials during processing [19].

In spray cooling, the coating substance is typically a vegetable oil or one of its derivatives. Yet, a wide variety of other encapsulating materials can also be employed. These include fat and stearin with melting points of 45°C–122°C as well as hard mono- and diacylglycerols with melting points of 45°C–65°C. Taylor [106] indicated that mono- and diacylglycerols facilitate dispersion of the encapsulate in finished, reconstituted food products and may also be considered as part of the overall emulsification system.

In spray chilling, the coating is typically a fractionated or hydrogenated vegetable oil with a melting point in the range of 32°C–42°C. Coating materials with even lower melting points can be utilized, but their end products may require specialized handling and storage conditions [106]. Furthermore, in spray chilling, there is no mass transfer, i.e., evaporation from the atomized droplets, and therefore these solidify into almost perfect spheres to give free-flowing powders. Through atomization an enormous surface area is achieved, which provides an immediate and intimate mixing of these droplets with the cooling medium.

Spray chilling is employed primarily for the encapsulation of solid food additives, such as ferrous sulfate, acidulants, vitamins, minerals, and solid flavors, as well as for heat-sensitive materials or those that are not soluble in typical solvents [106]. With the functional food revolution, the importance of spray chill has increased, particularly in the production of functional food ingredients for the primary purpose of fortification. Liquids may also be encapsulated following their conversion to a solid form, perhaps by freezing. The end products of the process, resembling fine beadlets of a large particle size, are water soluble but release their contents at or around the melting point of the wall material. With the ability to select the melting point of the wall, this method of encapsulation can be used for controlled release. The process is thus suitable for protecting many water-soluble materials, such as spray-dried flavors, which may otherwise be volatilized from a product during thermal processing. Spray-chilled products have applications in bakery products, dry soup mixes, and foods containing high levels of fat [110].

Lamb [126] pointed out the importance of maintaining optimum temperatures during processing, as this can affect the fat's polymorphism, a phenomenon that describes the capability of a substance to exist in more than one crystalline form. He also noted that if a fat, say a powdered triacylglycerol, is permitted to exit from a chiller at too high a temperature, heat generated by polymorphism tended to reverse the encapsulating process and return the powder to a melt or perhaps a pasty mass.

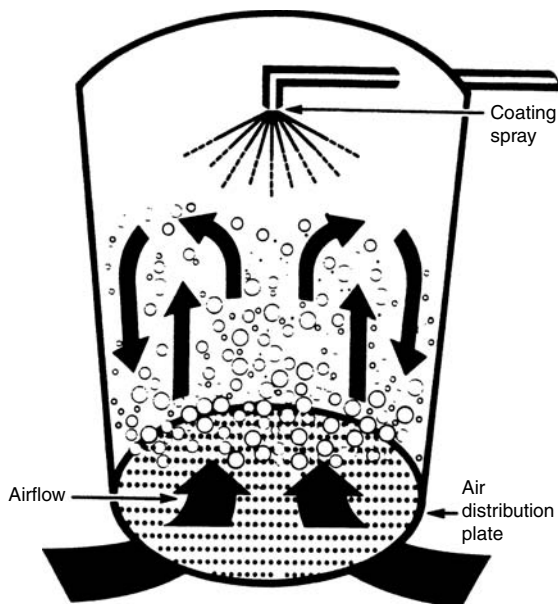
### 22.3.3 Fluidized Bed Coating

Fluidized bed coating, also referred to as air suspension coating or the Wurster process, is a common technique used for commercial production of encapsulated ingredients for the food industry. It was developed by D.E. Wurster in the 1950s. In general, it has been found that dense particles with a narrow particle size distribution and good flowability are most suitable for encapsulation by fluid bed. Ideally, a particle size distribution between 50 and 500  $\mu\text{m}$  is best, although it is possible to encapsulate particles ranging from 35 to 5000  $\mu\text{m}$  [13].

Fluidized bed coating of food ingredients was once viewed as the last choice by a formulator on account of the costs involved. Today, however, high production volumes and well-developed technologies have made a number of encapsulated food products standard items and available at cost-effective prices [127]. Solid particles to be sprayed are suspended in an upward-moving column of air in a fluidized-bed chamber at a controlled temperature and humidity. Depending upon the specific application, the airflow may be heated or cooled [125]. Once the moving fluid bed of particles has reached the prescribed temperature, the encapsulation coating material is introduced into the system. Great variations exist as to the type of the wall material chosen. Cellulose derivatives, dextrans, emulsifiers, lipids, protein derivatives, and starch derivatives are examples of typical coating systems, and they may be used in a molten state or dissolved in an evaporable solvent. The coating is atomized through binary or pneumatic spray nozzles at the top of the chamber, whose droplets are of smaller size than the substrate being coated. The atomized particles travel down to the particle stream and deposit as a thin layer on the surface of suspended core material. The turbulence of the air column is sufficient to keep the coated particles suspended, thereby allowing them to tumble and become uniformly coated. Upon reaching the top of the air stream, the particles move into the outer, downward-moving column of air, which returns them to the fluidized bed with their coating nearly dried (Figure 22.8). The particles pass through the coating cycle many times per minute [15]. With each successive pass, the random orientation of the particles further ensures their uniform coating. In the case of hot melts, the coating is hardened by solidification in cool air. In the case of solvent-based coatings, the coating is hardened by evaporation of the solvent in hot air. The amount of coating applied can be regulated by controlling the length of time (i.e., residence time) that the particles are in the chamber. To achieve a good degree of coating, the process

takes anywhere from 2 to 12 h to complete. After this period, only 0.2%–1.5% of the particles remains uncoated.

Fluidized bed spray granulation is a more recent technology that allows specific particle size distributions from 0.2 to 1.2 mm with low porosities to be designed for the product. As with spray drying, continuous spray granulation starts off with an aqueous emulsion. Repeated spraying, applying, and drying steps in a fluidized bed form granules with an onion-like structure. A particular advantage offered by granulation technology is the possibility of producing large flavored particles of uniform particle size and shape without the need for any additional production steps [105].



**FIGURE 22.8** Schematic representation of a conventional air suspension system. (From J. D. Dziezak, *Food Technol.* 42(4): 136, 1988.)

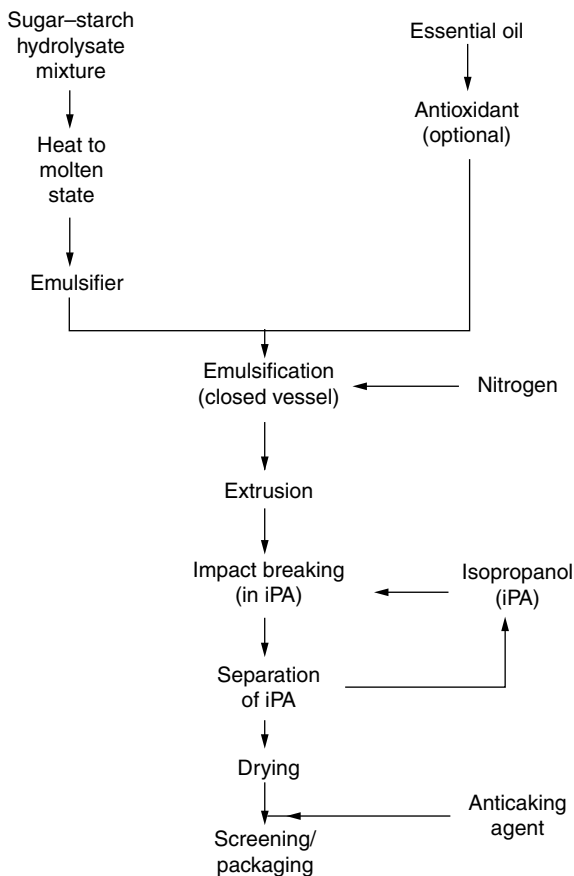
#### 22.3.4 Extrusion

Encapsulation of food ingredients by extrusion is a newer process than spray drying. Extrusion, used in this context, is not the same as that used for cooking and texturizing of cereal-based products. Actually, extrusion, as applied to flavor encapsulation, is a relatively low-temperature entrapping method that involves forcing a core material dispersed in a molten carbohydrate mass through a series of dies into a bath of dehydrating liquid. The pressures and temperatures employed are typically <100 psi and seldom exceed 115°C, respectively [29]. Upon contact with the liquid, the coating material, which forms the encapsulating matrix, hardens and entraps the core material. Isopropyl alcohol is the most common liquid employed for the dehydration and hardening process. The extruded filaments or strands are then broken into small pieces, dried to mitigate hygroscopicity (an anticaking agent such as calcium triphosphate can facilitate this), and sized.

Schultz et al. [128] were pioneers in the extrusion/encapsulation process. They emulsified orange peel oil in a molten dextrose mass, poured it on stainless steel sheets, and let it cool. The pulverized product exhibited good stability and flavor retention over a 6-month period. Combining the basic formulation of Schultz et al. [128] with extrusion, Swisher [129] created a novel encapsulating process that is similar to the one currently employed by the flavor industry. The primary benefit claimed in his patent [130] was the maintenance of fresh flavor in encapsulated citrus oils that otherwise would readily oxidize and yield objectionable off-flavors during storage. He conducted an accelerated shelf-life test on encapsulated orange peel oil, which contained an antioxidant, and found that its shelf life was about 1 year. Figure 22.9 shows the key steps for flavor encapsulation by extrusion.

Swisher [130] added an essential oil, such as orange peel oil, containing an antioxidant and a dispersing agent, to an aqueous melt of corn syrup solids (42 DE) and glycerine. The corn syrup melt contained 3%–8.5% moisture and was held at a temperature ranging from 85°C to 125°C, typically 120°C. The flavor–corn syrup mixture was agitated vigorously while blanketed under nitrogen to form an oxygen-free emulsion. This emulsion was forced through a die into a hot immiscible liquid (e.g., vegetable or mineral oils), which was then rapidly cooled or extruded into pellets and allowed to solidify. The hardened pellets or solid globules were ground to a desired particle size, washed with isopropanol to remove surface oil, and then dried under vacuum to yield a free-flowing granular material containing 8%–10% flavoring.

The extrusion process of encapsulation has remained largely unchanged since Swisher's patent [130]. Most research developments to date concern the composition of the material, which forms the encapsulating matrix. For example, Beck [131] replaced the high-DE corn syrup solids with a combination of sucrose



**FIGURE 22.9** Flow diagram of encapsulation of food flavors via extrusion processing. (From G. A. Reineccius, *Food Rev. Int.* 5: 147, 1989.)

manufacturers. Because sucrose will invert to glucose and fructose at low pHs and high temperatures, the resulting product would be more hygroscopic and readily participate in nonenzymatic browning reactions. Therefore, the replacement of sucrose permitted longer cooking times, larger bath sizes, and higher cooking temperatures. Barnes and Steinke [132] also claimed that fruit juices, fruit essences, volatile substances, and propylene glycol could be encapsulated in this way using their encapsulation matrix. To successfully encapsulate fruit essences, it was first necessary to remove water and low molecular weight alcohols from the essence. The essence was then incorporated in an edible oil so that it would form an emulsion with the encapsulation matrix. For example, orange juice concentrate (42% water) could be encapsulated at 10%–15% loading levels with their process. This was a substantial improvement considering that prior formulations using sucrose were limited to 5%–6% juice solids loading and could only be used with concentrates containing <20% water.

Miller and Mutka [133,134] were awarded two patents for flavor encapsulation via extrusion. The first patent [133] involved a process for the encapsulation of orange juice solids, while the second dealt primarily with optimization of the extrusion process. It was their intent to improve the flavor load and encapsulation efficiency. A study of the effect of cooking temperature on flavor load and encapsulation efficiency indicated that high-load products (greater than 22%) had an optimum cooking temperature of ~123°C. As shown in Table 22.4, temperatures above or below this value yielded poorer encapsulation efficiencies. Because the cooking temperature is basically determined by moisture content, Miller and Mutka [134] postulated that too little moisture reduced emulsification effectiveness while too much moisture hindered encapsulation. A cooking temperature of 123°C corresponded to ~5% moisture.

and maltodextrin; a melt consisting of ~55% sucrose and 41% maltodextrin (10–13 DE). Even though the low-DE maltodextrin/sucrose matrix was considerably less hygroscopic than that used by Swisher [129,130], Beck continued to employ an anticaking agent and even recommended pyrogenic silica rather than tricalcium phosphate. The flavor load obtained by Beck [131] ranged from 8% to 10%, with 12% considered as a practical maximum.

Barnes and Steinke [132] were awarded a patent for developing a modified food starch in place of sucrose in a similar process. Because chemically modified starches can possess good emulsification properties, the authors hypothesized that an emulsifying starch, with its lipophilic characteristics, would absorb the flavor oils in the matrix. The maltodextrin was, therefore, used primarily to provide bulk and some viscosity control. Barnes and Steinke [132] claimed that the employment of emulsifying starches in the encapsulation matrix would permit increasing the loading capacity up to 40% flavoring.

Another benefit cited by the authors was that the total replacement of sucrose with emulsifying starches resulted in a product that was “sugar free.” This might have some advantages in marketing of a final food product. Sucrose substituted with modified starches also provided greater flexibility to

**TABLE 22.4**

Influence of Cooking Temperature on Encapsulation Efficiency

Oil Encapsulated (%)	Encapsulation Efficiency (%)	Cooking Temperature (°C)
20.5	63.5	118
22.9	70.9	122
21.1	65.3	126
19.3	59.8	130
19.2	59.4	134

Source: G. A. Reineccius, *Food Rev. Int.* 5: 147 (1989).

From the work of Miller and Mutka [134], optimization of cooking temperature, emulsifier concentration, and pressurization of the cooking vessel resulted in an improved encapsulation efficiency at high flavor loadings. Although their patent claims loadings of up to 35% can be used, only one example with loading of as high as 27.6% was cited. The majority of examples demonstrated feasibility at flavor loadings from 15% to 20%, but still such levels are well over the traditional 8%–10% flavor loadings achieved in commercial applications.

The extrusion process is particularly useful for heat-labile compounds/bioactives and has been used to encapsulate flavors, vitamin C, and colorants. According to Risch [10], extrusion provides true encapsulation in that the core material is completely surrounded by the wall material. When the material contacts the isopropanol and the wall is hardened, all residual oil or core material is removed from the surface. The absence of residual surface oil and the complete encapsulation gives products manufactured in this manner an excellent shelf life. This technique produces larger particles that can be used when visible flavor pieces are desirable. The primary advantage of extrusion is unquestionably its outstanding protection of the flavor against oxidation. For example, an accelerated shelf-life test on encapsulated orange peel oil containing no antioxidants was reported to be in excess of 4 years [129]. In terms of its weaknesses, extrusion is considerably more expensive than spray drying: process costs are estimated to be nearly double. Twenty percent flavor loading is standard for spray drying, while extrusion delivers less flavor per unit weight because its loading is currently running in the 8%–12% range. Finally, one must realize that extrusion is a high-temperature batch process. The flavorings must be able to tolerate 110°C–120°C temperatures for a substantial period of time without deterioration.

### 22.3.5 Centrifugal Extrusion

Centrifugal extrusion is another encapsulation technique that has been investigated and used by some manufacturers. A number of food-approved coating systems have been formulated to encapsulate products such as flavorings, seasonings, and vitamins. These shell materials include gelatine, sodium alginate, carrageenan, starches, cellulose derivatives, gum acacia, fats/fatty acids, waxes, and polyethylene glycol.

Developed by scientists in the USA, centrifugal extrusion is a liquid coextrusion process utilizing nozzles consisting of concentric orifices located on the outer circumference of a rotating cylinder (i.e., head) [135]. The encapsulating cylinder or head consists of a concentric feed tube through which coating and core materials are pumped separately to the many nozzles mounted on the outer surface of the device. While the core material passes through the center tube, coating material flows through the outer tube. The entire device is attached to a rotating shaft such that the head rotates around its vertical axis. As the head rotates, the core and coating materials are coextruded through the concentric orifices of the nozzles as a fluid rod of core sheathed in coating material. Centrifugal force impels the rod outward, causing it to break into tiny particles. By the action of surface tension, the coating material envelops the core material, thus accomplishing encapsulation. The capsules are collected on a moving bed of fine-grained starch, which cushions their impact and absorbs unwanted coating moisture. Particles produced by this method have diameters ranging from 150 to 2000  $\mu\text{m}$  [136].

Another extrusion-based development is a process for encapsulating water-soluble lipids as particles of 1–15  $\mu\text{m}$ . In this process, a core material is fed down a vertical tube while the coating material, a viscous solution of sodium alginate, simultaneously flows through a ring-shaped opening around the base of the tube, forming a membrane across the bottom of the device. The extruding core material pushes against the membrane until it eventually breaks off and carries a portion of the membrane with it. Upon spinning, the particles assume a spherical shape and become encapsulated. Passage through a bath of aqueous calcium acetate, calcium glutamate, or calcium lactate finishes this film-forming process by converting the coating to a water-insoluble calcium salt.

### 22.3.6 Lyophilization

Lyophilization or freeze drying is a process for the dehydration of almost all heat-sensitive materials, bioactives, and aromas. It has been used to encapsulate water-soluble essences and natural aromas [137,138] as well as drugs [139]. Except for the long dehydration period required (commonly 20 h), freeze drying is a simple technique that is particularly suitable for the encapsulation of aromatic materials.

Because the entire dehydration process is carried out at low temperature and low pressure, it is believed that the process should have a high retention of volatile compounds. Model system investigations by Thijssen and coworkers [114,140] and Flink and Karel [21,141] indicated that the retention of volatile compounds during lyophilization was dependent upon the chemical nature of the system; flavor retention increased when the molecular weight of the carbohydrate wall materials decreased and the level of total soluble solids increased (up to ~20%).

For the production of citrus aroma powders to be used as natural flavor ingredients in soft drink dry mix formulations, Kopelman et al. [137] proposed the employment of a freeze-drying method. By simply dissolving various blends of corn syrup solids and sugars (mono- and disaccharides) in an aroma solution at a 25% (w/w) level followed by lyophilization, these authors claimed that ~75% of the initial aroma volatiles could be retained in the optimal maltodextrin sucrose mixture [137].

Freeze-drying methods can also be used for other encapsulation processes. For example, Kirby and Gregoriadis [139] used freeze drying in the development of a technique known as DRV (dehydration–rehydration vesicles) for liposome entrapment. Upon the controlled addition of water, up to 70% of the water-soluble drugs present were entrapped in the formed liposomes. It has been reported that preparation of coatings only entrapped drugs that could be freeze dried again, and the liposomal structural integrity was apparently preserved. Intact liposomes with most of their contents still entrapped were obtained after rehydration [92].

### 22.3.7 Coacervation

Coacervation is a phase separation phenomenon in which a homogeneous polymer solution is converted into two phases. One is a polymer-rich phase, called a coacervate; and the other is a polymer-poor phase, i.e., solvent [142]. Coacervation was developed and patented in the 1950s by the National Cash Register Company in the USA and was employed as a means of producing a two-component ink system for carbonless copy papers. Because of the very small particle sizes attainable with this process (ranging from a few submicrons to 6  $\mu\text{m}$ ), coacervation is regarded by many as the original and true microencapsulation technique [143].

An example of a simple coacervation process could be described as follows: a gelling protein is dissolved in water, the core material is emulsified in the protein solution, and formation of the coacervate wall is initiated by changing either the temperature, pH, or by adding a concentrated salt solution. The resultant microcapsules are isolated by centrifugation or filtration. In effect, coacervation involves the separation of a liquid phase of coating material from a polymeric solution followed by the coating of that phase as a uniform layer around suspended core particles. The coating is then solidified. In general, batch-type simple coacervation processes consist of three steps, as summarized below, and are carried out under continuous agitation [14].

### 22.3.7.1 Formation of a Three-Immiscible Chemical Phase

In the first step, a three-phase system consisting of a liquid manufacturing vehicle phase, a core material phase, and a coating material phase is formed by either a direct addition or *in situ* separation technique. In the direct addition approach, the coating-insoluble waxes, immiscible polymer solutions, and insoluble liquid polymers are added directly to the liquid manufacturing vehicle, provided that it is immiscible with the other two phases and is capable of being liquefied. In the *in situ* separation technique, a monomer is dissolved in the liquid vehicle and then subsequently polymerized at the interface.

### 22.3.7.2 Deposition of the Coating

Deposition of the liquid polymer coating around the core material is accomplished by controlled physical mixing of the coating material (while liquid) and the core material in the manufacturing vehicle. Deposition of the liquid polymer coating around the core material occurs if the polymer is sorbed at the interface formed between the core material and the liquid vehicle phase; this sorption phenomenon is a prerequisite to effective coating. Continued deposition of the coating is promoted by a reduction in the total free interfacial energy of the system brought about by a decrease of the coating material surface area during coalescence of the liquid polymer droplets.

### 22.3.7.3 Solidification of the Coating

Solidification of the coating is achieved either by thermal, cross-linking, or desolventization techniques, and forms a self-sustaining microcapsule entity. The microcapsules are usually collected by filtration or centrifugation, washed with an appropriate solvent, and subsequently dried by standard techniques such as spray- or fluidized-bed drying to yield free-flowing, discrete particles.

Simple coacervation deals with systems containing only one colloidal solute (e.g., gelatine), whereas complex coacervation deals with systems containing more than one solute (e.g., gelatine and gum acacia [144] or gelatine and polysaccharide [145]). By strict definition, however, complex coacervation involves two biopolymers with opposite charges forming a complex coacervate as a result of ionic interaction at the interface. For example, positively charged type A gelatine (component A) forms complex coacervates with negatively charged polyphosphate (component B). Other systems investigated have included gelatine/gum acacia, gelatine/pectin, gelatine/carboxymethyl guar gum, and whey protein/gum arabic [142]. This technology has been used in flavor encapsulation as well as for the storage and delivery of additives [146]. The relatively high processing costs, sensitive multistep batch process, regulations limiting the number of polymeric agents that can be used in food preparations, and the difficulty in dealing with encapsulates having both aqueous and lipid solubility properties—as well as the sensitivity of these systems to high shear—have limited the application of coacervation for flavor encapsulation in the food industry [19].

Coacervation may also be subdivided into nonaqueous phase separation and aqueous phase separation techniques: aqueous phase separation has been employed to encapsulate citrus oils, vegetable oils, and vitamin A. It requires a hydrophilic coating, such as gelatine or gelatine-gum acacia, and water-insoluble core particles. The resulting microcapsules may contain payloads of 85%–90% and can release their contents by pressure, hot water, or chemical reaction. For nonaqueous phase separation, the coating is usually hydrophobic and the core may be water soluble or water immiscible. This process has been investigated for the encapsulation of solid food additives such as ferrous sulfate [16].

Although coacervation is very efficient, it can be an expensive process. It has found limited use in flavor encapsulation [12,147], because of the high costs associated with the technology and difficulties encountered with the level of flavor that can be incorporated to the microcapsules [106]. Another reason cited by various industries for the limited use of coacervation deals with the problem of finding suitable encapsulating materials that are food approved. According to Blenford [110], the technology has been basically restricted to encapsulated ink systems used in carbonless office forms and fragrances that are applied in the form of “scratch and sniff” strips in promotional literature. Arneodo et al. [148] and King et al. [149] observed that research into this technology was in progress and proposed that commercial applications would be available in the near future.

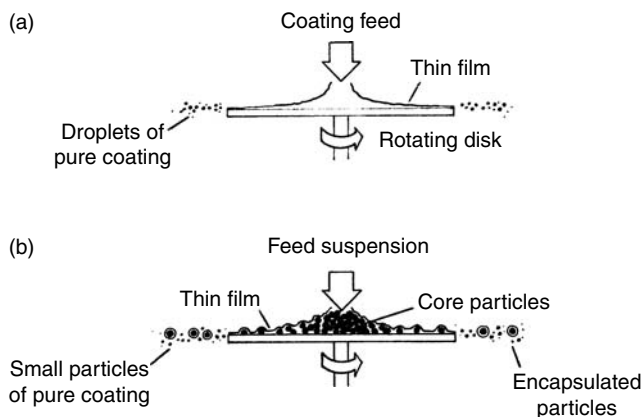
Ocean Nutrition Canada (ONC) uses a proprietary microencapsulation technology based on a complex coacervation process to encapsulate fish oil concentrates rich in eicosapentaenoic acid (EPA) and

docosahexaenoic acid (DHA). The technology is based on the patent of Yan and Jin [142]. Research has suggested that a diet containing omega-3 fatty acids, such as EPA and DHA, may have a beneficial effect in lowering the incidence of cardiovascular diseases [150]. Although there is no established daily requirement for the omega-3 fatty acids, recommendations range from 250 to 500 mg EPA/DHA per day. ONC's patented process involves preparing an emulsion comprising fish oil and a gelatine-based polymer. The emulsion has a particle size of  $<100$  nm. Two oppositely charged polymer colloids—one an amphoteric polymer and the other a polyanionic polymer—interact with each other to cause phase separation. The product is introduced into a spray-drier, and a dried microcapsule results. MEG-3™ powder is a patented microencapsulated fish oil product comprising a 60% payload of fish oil; this represents one of the highest, if not the highest, concentrations of bioavailable omega-3 in the market place. MEG-3™ powder is manufactured to withstand shear and high temperature and other food processing operations such as pasteurization and homogenization. Studies conducted by ONC have shown that there is no loss of omega-3 EPA/DHA during processing or via shelf-life deterioration. This functional food ingredient has been used to develop an omega-3 yoghurt product. Delivering 50–100 mg of EPA/DHA per serving in a variety of functional foods will help consumers reach the recommended daily intake levels.

### 22.3.8 Centrifugal Suspension Separation

Centrifugal suspension separation is a microencapsulation technique that has been around for only 20 years. The process has been patented [151,152] and was first applied commercially in February 1987 to a chemical produced in Europe. The process, in principle, involves suspending core particles in a pure, liquified coating material, and then pouring the suspension over a rotating disk apparatus under such conditions that excess liquid between the core particles spreads into a film thinner than the core's particle diameter. The excess liquid is atomized to tiny droplets, separated from the coated product, and recycled. The core particles leave the disk with residual liquid still around them, which forms the coating. The particles are hardened by chilling and drying [153]. The principle behind this process is illustrated in Figure 22.10.

Centrifugal suspension separation is a continuous, high-capacity process that takes seconds to minutes to coat core particles. The process can handle a wide variety of core materials (including those that are temperature sensitive) and coating materials (in solid, liquid, or suspension states) without presenting aggregation problems. Furthermore, the process handles each particle only once and, under most conditions, produces no uncoated particles. The technique has been used successfully to coat particles ranging from  $30\ \mu\text{m}$  to 2 mm. Coatings have been produced with thicknesses ranging from 1 to  $200\ \mu\text{m}$ . Microcapsules have been prepared with payloads ranging from 1% to 97%, depending on the diameter of the particle in question. Another advantage associated with centrifugal suspension separation is that the size distribution of the encapsulated particles resembles that of uncoated particles.



**FIGURE 22.10** Representation of rotational suspension separation system. (a) Establishing particle size for pure coating; and (b) encapsulation by suspension separation. (From R. E. Sparks and N. S. Mason, U.S. Patent 4,675,140, 1987.)



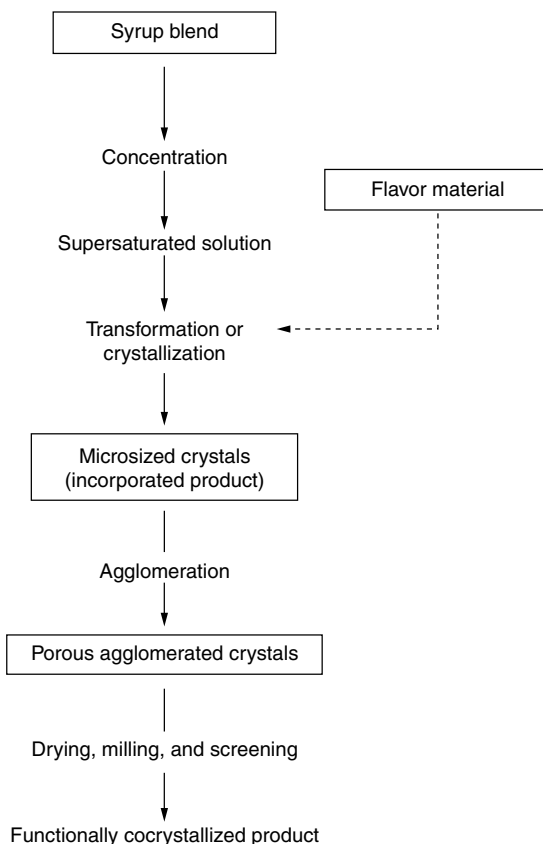
### 22.3.9 Cocrystallization

Cocrystallization is a new encapsulation process utilizing sucrose as a matrix for the incorporation of core materials. Although granulated sugar is composed of solid, dense, monoclinic spherical crystals with a limited surface area, it is not suitable as an encapsulating agent for flavor encapsulation. For flavors to be incorporated into the matrix, the structure of sucrose must be modified from a single perfect crystal to a microsized, irregular, agglomerated form, to increase void space and surface area [45,154]. It involves spontaneous crystallization, which produces aggregates of micro- or fondant-size crystals ranging from 3 to 30  $\mu\text{m}$  while causing the inclusion of entrapment of all nonsucrose materials within or between sucrose crystals [155]. Use of the cocrystallization process allows many types of food ingredients, either single ingredients or combinations of ingredients, to be incorporated permanently into a crystalline sucrose aggregate, thus providing interesting and useful characteristics.

Sucrose syrup is concentrated to the supersaturated state and maintained at a temperature high enough to prevent crystallization. A predetermined amount of core material is then added to the concentrated syrup with vigorous mechanical agitation, thus providing nucleation for the sucrose-ingredient mixture to crystallize. As the syrup reaches the temperature at which transformation and crystallization begin, a substantial amount of heat is emitted. Agitation is continued to promote and extend transformation/crystallization until the agglomerates are discharged from the vessel. The encapsulated products are then dried to a desirable moisture (if necessary) and screened to a uniform size [51,52]. It is very important to properly control the rates of nucleation and crystallization as well as thermal balance during the various phases. The essential steps for the preparation of cocrystallized flavor are presented in Figure 22.11.

The agglomerates form a loose network, bonded together by point contacts. The encapsulated materials are located primarily in the interstices between crystals. Owing to the porosity of the agglomerates, it is easy for an aqueous solution to rapidly penetrate the agglomerate and release core materials for dispersion and dissolution.

The cocrystallization process offers several advantages, for example, it can be employed to achieve particle drying. In the highly saturated solution, nucleation and crystallization proceed at a rapid rate and the resulting heat of crystallization can be utilized to affect particle dehydration by evaporation. By means of the cocrystallization process, core materials in a liquid form can be converted into a dry powdered form without additional drying. Because the flavor or core material is well entrenched in the modified sucrose matrix, there is no tendency for flavor material to separate from or settle out during handling, packaging, or storage. Additionally, all cocrystallized sugar/flavor products offer direct tableting characteristics because of their agglomerated structure, and thus provide significant advantages to the candy and pharmaceutical industries [156].



**FIGURE 22.11** Essential steps for the preparation of a cocrystallized flavor. (From A. C. Chen, M. F. Veiga, and A. B. Rizzuto, *Food Technol.* 42(11): 87, 1988.)

### 22.3.10 Liposome Entrapment

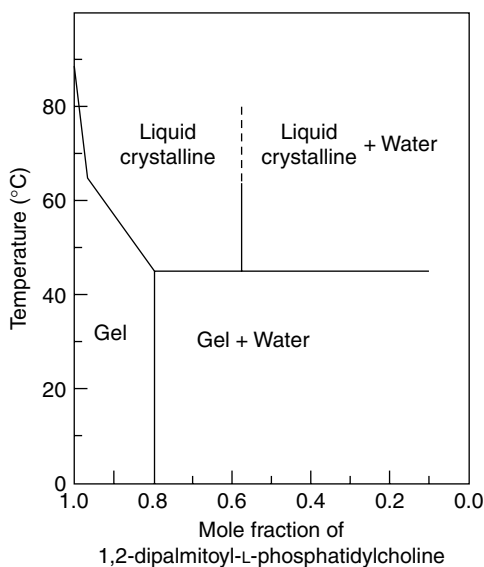
Numerous methods of liposome entrapment have been developed [91,92,157]. Preparations obtained vary widely in vesicle size distribution, number of bilayers per vesicle, and encapsulation efficiency.

Liposomes consist of an aqueous phase that is completely surrounded by a phospholipid-based membrane. When phospholipids, such as lecithin, are dispersed in an aqueous phase, the liposomes form spontaneously. One can either have aqueous- or lipid-soluble material enclosed in the liposome. However, liposome entrapment for many flavor compounds is not possible because liposomes will not form for materials that are soluble in both the aqueous and lipid phases [10]. From a physicochemical point of view, the formation of liposome structures may be illustrated by phase diagrams. A simplified phase diagram of the 1,2-dipalmitoyl phosphatidylcholine–water system is depicted in Figure 22.12 [158]. Addition of water decreases the transition temperature of the phospholipid to a limiting value ( $T_c$ ), which is the minimum temperature required for water to penetrate between the layers of lipid molecules. When the system is cooled below  $T_c$ , the hydrocarbon chains adopt an ordered packing. The structure of this phase, known as the gel, is lamellar and the hydrocarbon chains are extended [158]. Each type of phospholipid molecule is characterized by a phase transition temperature. Below  $T_c$ , its fatty acyl chains are in a quasicrystalline array; while above  $T_c$ , the chains are in a fluid-like state.

There are two principal requirements for liposome microencapsulation. First, the lipid of choice must have a negative Gibb's free energy value ( $\Delta G$ ) for bilayer structure formation, because a negative  $\Delta G$  value between two states of system indicates a favorable reaction. Second, sufficient energy must be put into the system to overcome the energy barrier. Close to room temperature, the value of  $\Delta G$  for the formation of liposomes is always negative and, therefore, favorable. Even though the thermodynamics are favorable, this does not mean that the reaction will proceed automatically; it is usually necessary to overcome an energy barrier to initiate a reaction. Different lipids and types of energy input may be used to produce different varieties of liposomes for specific purposes. Some methods commonly employed are described below.

#### 22.3.10.1 Microfluidization

The microfluidization technique is based on the dynamics in specially designed microchannels. The resulting momentum and turbulence allow the lipid emulsion to overcome the energy barrier ( $\Delta G^\ddagger$ ). An



**FIGURE 22.12** Phase diagram of the 1,2-dipalmitoyl-L-phosphatidylcholine-water system. (From F. Shahidi and X.-Q. Han, *Crit. Rev. Food Technol.* 33: 501, 1993.)

air-driven microfluidizer operates at pressures of up to 10,000 psi. A pump driven by compressed air is used to pump the aqueous emulsion of lipids, and the single-feed stream is split into two fluidized ones. The two flows interact with one another at ultrahigh velocities and in precisely defined microchannels.

Mayhew and Lazo [159,160] found that small (0.1  $\mu\text{m}$  in diameter) liposomes with high solute-capture efficiency could be easily formed by microfluidization technology. At an initial lipid concentration of 300 mM, up to 75% of cytosine arabinoside was captured in the aqueous space of these liposomes. Advantages of microfluidization include: (i) a large volume of liposomes can be formed in a continuous and reproducible manner; (ii) the average size of the liposomes can be adjusted; (iii) very high capture efficiencies (larger than 75%) can be obtained; (iv) the solutes to be encapsulated are not exposed to sonication, detergents, or organic solvents; and (v) the resulting liposomes appear to be stable, and do not aggregate or fuse.

### 22.3.10.2 Ultrasonication

Ultrasonic dispersion is often employed for the preparation of SUVs; the lipid emulsion overcomes the energy barrier through ultrasound absorption. In one approach, phospholipids are sonicated by immersing a metal probe directly into a suspension of large liposomes. In the second method, the lipid dispersion is sealed in a glass vial, which is then suspended in an ultrasonic cleaning bath. Bath sonication requires longer periods (up to 2 h) than probe sonication (only a few minutes), but it has the advantage that it can be carried out in a closed container under nitrogen or argon, and does not contaminate the lipid with metal from the probe tip [97].

### 22.3.10.3 Reverse-Phase Evaporation

This technique has been developed for the preparation of LUVs in which lipids in mixed aqueous–nonpolar solvents form inverted micelles (i.e., the lipid tails are inserted into the nonpolar phase and the head groups surround water droplets). When the nonpolar solvent is removed by rotary evaporation under vacuum, the gel-like intermediate phase changes to large unilamellar and oligolamellar vesicles. This procedure produces liposomes of quite uniform size, ranging from 0.1 to 1.0  $\mu\text{m}$  in diameter, with high encapsulation efficiency of up to 65% in low ionic strength media. Its disadvantage, however, is that components are exposed to both organic solvents and sonication. This may result in the denaturation of proteins and other molecules of similar stability [96].

### 22.3.11 Interfacial Polymerization

Interfacial polymerization happens when two different polymeric solutions are brought together. These two reactive polymeric species, each solubilized in a different liquid, react with one another when one liquid is dispersed in the other. The polymerization reaction takes place at the interface between the two polymeric liquids.

The interfacial polymerization process can be employed to encapsulate solutions or dispersions of hydrophobic materials. It can also be used to encapsulate aqueous solutions or dispersions of hydrophilic substances. In the interfacial polymerization microencapsulation process, both the dispersed and continuous phases serve as a source of reactive polymeric species. In general, an interfacial polymerization reaction proceeds at a rapid rate that results in the formation of a very thin film having physical property characteristics of a semipermeable membrane. Properties of the film are markedly influenced by the reaction time [161].

The ultimate capsule size of interfacial polymerization is determined by the size of the first monomer. In general, the capsule size ranges from  $\sim 1 \mu\text{m}$  to several millimeters. This capsule size is a direct function of the agitation rate [161]. It is found that an increase in the concentration of the emulsifier yields a narrow size distribution range and a reduction of the average particle size. The patent application for the microencapsulation process utilizing the principle of interfacial polymerization was filed by IBM (S/N: 813,425) in 1959 [161]. The use of interfacial polymerization for food systems is limited, however, as most coatings are not food grade.

### 22.3.12 Inclusion Complexation: Molecular Inclusion

Molecular inclusion is another means of achieving encapsulation. Unlike other processes discussed to this point, this technique takes place at a molecular level and  $\beta$ -cyclodextrin is typically used as the encapsulating medium [31]. As previously noted,  $\beta$ -cyclodextrin is a cyclic glucose oligomer, consisting of seven  $\beta$ -D-glucopyranosyl units linked by  $\alpha$ -(1 $\rightarrow$ 4) bonds. Owing to its molecular structure,  $\beta$ -cyclodextrin has limited solubility, a hydrophobic center, and a relatively hydrophilic outer surface, all of which affect the compound's formation of complexes.

The  $\beta$ -cyclodextrin molecule forms inclusion complexes with compounds that can fit dimensionally into its central cavity. These complexes are formed in a reaction that takes place only in the presence of water. Molecules that are less polar than water (i.e., most flavor substances) and have suitable molecular

dimensions to fit inside the cyclodextrin interior can be incorporated into the molecule. In aqueous solution, the slightly nonpolar cyclodextrin interior is occupied by water molecules. This situation is energetically unfavorable and, therefore, the sites occupied by water are readily substituted by the less polar guest molecules. Cyclodextrin complexes are relatively stable and their solubility in aqueous solutions is reduced compared to the uncomplexed cyclodextrin. Therefore, the complexed cyclodextrins readily precipitate out of the solution and can be recovered simply by filtration.

The complexing of a cyclodextrin with a guest compound can be accomplished by three methods [41] as described: (i) stirring or shaking the cyclodextrin and guest molecules to form a complex, which could then be easily filtered and dried. Although in some cases, complexation of an insoluble guest can only be accomplished through dissolution of the guest in a water-soluble solvent; (ii) blending of solid  $\beta$ -cyclodextrin and guest with water to form a paste. Solvent should not be used. This method is particularly applicable for oleoresins; and (iii) forcing a gas through the solution for complexation to occur. This method is seldom employed. However, it should be emphasized that there are several variations to these basic techniques, but still in all methods both the cyclodextrin and the guest molecules must be solubilized. If the guest material is insoluble in water, it is necessary to dissolve it in another solvent such as alcohol.

The composition of the cyclodextrin complex formed depends greatly upon the molecular weight of the guest molecule in question. Because one molecule of cyclodextrin will normally include only one guest molecule, the loading depends upon the compounds included. It should be noted that the theoretical maximum loading is not always obtained. For example, Pagington [162] stated that dimethyl sulfide should be complexed at 5.5%, but only 2% loading has been observed.

It has been reported that cyclodextrins have a variable affinity for different guest compounds. This fact may be used advantageously in some applications, but at other times it can be a disadvantage. Some researchers have made use of the variable binding properties afforded by  $\beta$ -cyclodextrin to selectively remove bitter compounds from orange and grapefruit juices [163]. Variable binding properties can also be a disadvantage when it comes to the encapsulation of flavor compounds. Reineccius and Risch [31] formed 0% (isoeugenol) to 100% inclusions (ethyl hexanoate and linalool) when they added a model flavor system to  $\beta$ -cyclodextrin in an ethanol–water mixture. The losses of flavor compounds were due to the lack of inclusion rather than a loss during the subsequent complex recovery or drying steps. Once the complex was formed, it was quite stable to evaporation.

The variable inclusion properties of cyclodextrins can result in a dry flavor quite different from that of the original when the flavor comprises a broad range of molecules (e.g., an artificial flavor that contains short-chain esters and longer chain character impact compounds). However, flavors such as “orange” that have formed an inclusion complex with  $\beta$ -cyclodextrin may not be distinguishable from those of a fresh orange even by trained aroma panels [164].

There are substantial data in the literature documenting excellent protection for substances that have been treated with cyclodextrins [12,164–166]. As aforementioned, the cyclodextrin–guest complex formed is very stable to evaporation. Szente and Szejtli [166] reported only about a 5% loss of included volatiles after 2 years of storage at room temperature. More important, however, is the oxidative stability of the included guest compounds. Many reports have demonstrated that inclusion complexes are quite stable to oxidation [164,166].

As with all processes, there are limits to the application of cyclodextrin complexation in the formation of flavors [167], and these include the following:

1. There is a limited amount of flavor, which can be incorporated into a formulation (average 9%–14% by weight).
2. The size and polarity of flavors to be complexed limit the usefulness of the process.
3. Cyclodextrin can act as an artificial enzyme, sometimes enhancing the rate of hydrolysis of some ester-type flavor components. This can result in undesirable adulteration of the flavor.
4. The water solubility of  $\beta$ -cyclodextrin flavor complexes is generally much lower than that of spray-dried and other microencapsulated samples.

### 22.3.13 Nanoparticulate Delivery Systems

Definitions of nanotechnology vary greatly. For our purposes, nanotechnology deals with the capability to image, measure, model, control, and manipulate matter at dimensions roughly 1–100 nm, where novel interfacial phenomena introduce new functionalities [90]. Some nanoscale phenomena have been utilized in functional food and nutraceutical formulation, manufacturing, and processes. New concepts are being explored to improve the effectiveness and efficiency in the delivery of multiple bioactive compounds, which do not normally mix well, like water- and lipid-soluble vitamins; now, they can be released consecutively. Nanoparticles may be defined as being submicrometer colloidal systems generally, but not necessarily, made of polymers (biodegradable or not). Depending upon the process in question, two different types of nanoparticles are available, nanospheres and nanocapsules. Nanocapsules comprise a membrane-wall structure with an aqueous or oily core containing the bioactive substance, where as nanospheres are matrix systems where the bioactive substance is dispersed throughout the particles [168]. In other words, nanocapsules may be considered as a reservoir or envelope system. Nanospheres prepared by encapsulation can enhance solubility; facilitate controlled release; improve bioavailability; and protect the stability of micronutrients and bioactive compounds during food processing, storage, and distribution. Encapsulated nanospheres can also lead to the development of new flavor-targeted delivery systems to improve food quality and functionality. Controlled release may eventually lead to *in situ* flavor and color modification of products [90]. In recent years, the role of nanotechnology in delivery systems for bioactives and specialty gradients has advanced considerably, but owing to better delivery of the active ingredients, toxicity related to possible overdosing issues must be adequately investigated.

---

## 22.4 Encapsulated Ingredients and Their Application

Microencapsulation can potentially offer numerous benefits to the materials being encapsulated, particularly in the case of functional food ingredients and nutraceuticals. Various properties of active materials may be changed/modified by encapsulation. For example, handling and flow properties can be improved by converting a liquid to a solid encapsulated form. Hygroscopic materials can be protected from moisture. The stability of functional ingredients and bioactives that are volatile or sensitive to heat, light, or oxidation can be protected, thereby extending their shelf life. Materials that are otherwise incompatible can be mixed and utilized together safely. Using food fortification as an example, microencapsulation can mask the undesirable taste of some nutrients (i.e., minerals) that may be imparted in the free forms, thus enabling the production of functional foods, say a nutraceutical beverage, with desirable sensory properties [169]. Currently, there are several hundred types of microcapsules being utilized as food additives or as ingredients in functional food formulations throughout North America [12]. Some of these are described below.

### 22.4.1 Acidulants

Acidulants are added to foods for a variety of reasons. They can be employed as flavor modifiers, preservation aids, and processing acids. In addition, they facilitate the development of a wide variety of textural effects in foods because of their interaction with other macro- and micromolecules such as proteins, starches, pectins, and gums [170].

Unencapsulated food acids can react with food ingredients to produce many undesirable effects. These include decreased shelf life of citrus-flavored and starch-containing foods (e.g., pudding and pie fillings, in which the acid hydrolyzes the starch), loss of flavor, degradation of color, and separation of ingredients. Encapsulated food acids overcome these problems and others because they preclude oxidation and provide controlled release under specific conditions. Moreover, encapsulated acids reduce hygroscopicity and dusting, and provide a high degree of flowability without clumping.

Encapsulation of acids in a time-release matrix is suggested as a means of avoiding undesirable reactions of acidulants with other food ingredients. The matrix used for forming the encapsulating coat in the acid products is generally a partially hydrogenated vegetable oil, although maltodextrin and emulsifiers are also available for this purpose. The encapsulated acids can be released at the appropriate time in the

processing operation either by heating to the melting point of the coating material, by contact with water, or a combination of these methods. Several applications of encapsulated acidulants are described below.

#### **22.4.1.1 Meat-Processing Aids**

In the meat industry, encapsulated acids, such as lactic, citric, and glucono- $\delta$ -lactone (GDL), are used to assist in the development of color and flavor in meat emulsions, dry sausage products, restructured meat products, uncooked processed meats, and meat-containing products, such as pasta meals. Fat encapsulation allows the acid to survive the blending process, giving a uniform dispersion within the meat formulation. Later, the encapsulated acid controls the drop in pH and prevents the meat from prematurely setting [13]. In a meat preparation, encapsulated acids need to be released after later processing stages such as cooking. Early release causes protein binding, and the final texture of the product can become brittle and deemed as unacceptable.

Cured meat products, especially dry and semidry sausages (e.g., summer sausages, pepperoni, and salami), have historically been prepared using lactic acid-producing bacterial cultures to develop flavor and lower the pH. Bacteria is added to meat emulsions and allowed to proliferate until a sufficient amount of lactic acid has been generated. Upon its production, the pH drops, binding occurs, and flavor develops. However, such products often tend to have inconsistent flavor, color, and textural characteristics from batch to batch. Uncoated lactic and citric acids cannot be added to meat during curing because they react almost instantly with meat proteins, rendering them unsuitable for further processing. Contamination is especially troublesome when the meat processor uses fermented raw meat as the source of bacteria rather than frozen cultures. An encapsulated acid, which is formulated for delayed release under smokehouse temperatures, can be employed as an alternative to the cultures. Acidification by encapsulated acids can improve emulsification and protein binding of emulsified meat and poultry products and impart the “tangy” flavor associated with fermented sausages without the complicated use of lactic acid starter cultures. In effect, encapsulation permits addition of the acidulants prior to stuffing without premature denaturation/binding of meat.

More than 35 years ago, encapsulated acids in a heat-rupturable inert vehicle such as ethylcellulose were developed [171]. The prepared capsules were mixed with nitrite-treated comminuted meats, and upon thermal processing the encapsulated acid was released and brought about a lowering in the pH of the meat product and gave rise to rapid development and stabilization of the cured meat color. The more acidic conditions within the meat matrix assisted in the production of nitrous acid and dinitrogen trioxide from the exogenous sodium nitrite. Both nitrous acid and dinitrogen trioxide are potent nitrosating species, which interact with the prosthetic heme group of myoglobin, the main hemoprotein pigment of muscle tissue, to form the cooked cured-meat pigment (CCMP).

The effect of encapsulated food acids on restructured pork from prerigor sow meat was studied by Cordray and Huffman [172]. Results from sensory panels indicated that sodium acid pyrophosphate and encapsulated GDL treatments yielded products with a more intense flavor than that of the control sample. Objective analysis revealed no significant ( $P > 0.05$ ) difference in shear value, tensile strength, water-holding capacity, cooked yield, or chilled yield; however, significantly more of the total meat pigment was converted into nitrosohemochromogen in the GDL treatment than that of the control. Lactic acid can also be encapsulated by plating it onto a particle calcium lactate carrier and then encapsulating the carrier and acid with a molten edible lipid [173].

#### **22.4.1.2 Dough Conditioners**

The baking industry has long been aware of the need for stable acids and sodium bicarbonate for use in wet and dry mixes to control the release of carbon dioxide during processing and subsequent baking. Encapsulation of sodium bicarbonate is particularly important in such products when high moisture/low pH fruits are mixed into a batter or dough, as it prevents premature leavening and undesirable color changes in the fruit [174]. Products commonly encapsulated for bakery applications include a variety of leavening system ingredients as well as vitamin C, acetic acid, lactic acid, potassium sorbate, sorbic acid, calcium propionate, and sodium chloride.

Use of ascorbic acid (i.e., vitamin C) for the strengthening and conditioning of bread and roll doughs provides many positive effects to finished products. Examples include stronger sidewalls, uniform crust

color, and improved slicing, in addition to a stronger structure that supports the addition of other protein-rich ingredients (such as soybean flour, nonfat milk powder, and wheat germ). Because ascorbic acid degrades rapidly in the presence of water and oxygen, most of the acid is destroyed before it is needed. Encapsulation can delay the reactivity of ascorbic acid from the dough mixing stage to well into or after the proof stage. Encapsulated in an edible coating, ascorbic acid imparts some of the effect of an oxidizing agent when used alone in natural breads. In combination with bromate, it enables greater amounts of protein-rich ingredients to be utilized without disturbing the grain of the bread to any great extent [175]. Pan breads and flat breads are the most common applications for such an ingredient.

For yeast-raised doughs, encapsulated salt, potassium sorbate, and sorbic acid are employed because they do not allow the pH to drop too early in the baking process and therefore the yeast can grow. Once baked, however, the mold-inhibiting properties of these ingredients are released in the dough and help to extend the shelf life of the finished product [13].

### 22.4.1.3 Other Encapsulated Acidulants

Acids are frequently used as liquids but would be easier to handle if they could be supplied in solid forms. Seighman [176] developed a method for encapsulation of foodgrade phosphoric acid in a dispersion containing a film-forming agent (hydrogen octenylbutane dioate–amylodextrin) and a matrix-forming ingredient (modified and hydrolyzed starches). The dispersion is thermal processed and then extruded into cold aqueous alcohol to solidify the matrix-forming ingredients and allow the film-forming agent to harden to a vitreous structure.

### 22.4.2 Flavoring Agents

The development and production of artificial or natural flavors and spices is an ever-expanding field in the food industry. The vast majority of flavor compounds used are a liquid at room temperature, and constituents of the flavors tend to show sensitivity toward air, light, irradiation, and elevated temperatures. Moreover, these flavor concentrates are generally oily and lipophilic materials, which can be difficult to work with. It is therefore necessary to employ a process to convert these flavor compounds to a more useable form. One of the purposes behind encapsulation in the food industry is the conversion of liquid flavors to dry powders. Microencapsulated flavors provide the convenience of a solid form over a liquid one with reduced volatility and less oxidation [23,107,162]. Microencapsulation has become an attractive option to transform liquid food flavorings into stable and free-flowing powders, which are easier to handle and incorporate into a dry food system.

The flavor industry depends heavily on encapsulation as a means of providing solid flavor compounds that offer them protection until consumption. Flavoring agents and spices are encapsulated by a variety of processes and offer numerous advantages to food processors. Processes for flavor encapsulation and encapsulated flavorings prepared during the last 45 years are summarized in Table 22.5.

Examples of commonly used encapsulated flavors are citrus oils, mint oils, onion and garlic oils, spice oleoresins, and whole spices. Citrus oils are very susceptible to oxidation due to sites of unsaturation in their mono- and sesquiterpenoid structure. Oxidative deterioration results in the development of off-flavors described as painty or turpentine-like. Encapsulated citrus oil, prepared by spray drying in a maltodextrin matrix, has a greater stability than unprotected oil [27].

Because flavors are often volatile materials, the stability of the dry microcapsules is an important consideration. Microcapsules must be stable for an extended period. Many volatile liquids can be encapsulated and subsequently dried to form free-flowing powders with minimal loss of activity during storage. Table 22.6 illustrates the stability of encapsulated flavors as a function of storage time in microcapsules of various particle sizes under ambient conditions [18]. For example, flavors encapsulated by inclusion complexation in  $\beta$ -cyclodextrin were protected against volatilization and attack by oxidation [162,166]. Storage stability of flavors encapsulated in  $\beta$ -cyclodextrin under “nonstress” conditions at room temperature showed that molecular encapsulation, in most cases, provides an almost perfect preservation of flavors for up to 10 years [166] (Table 22.7).

There has been a great expansion in the development of techniques to encapsulate flavors. A spray-dried composition comprising a volatile and a liable component in a carrier can be further encapsulated

**TABLE 22.5**

Literature on Flavor Encapsulation

Subjects	Reference
Overall reviews	[12,14,16,106,177–181]
Spray drying	[107,116,117,123,177,182–184]
Coacervation systems synthetic film formers	[178,185]
Cheese flavor technology	[186–191]
Flavor oils	[192–196]
Lemon and citrus oils	[197,198]
Safflower oil	[199]
Essential oil for bakery mixes	[200]
Volatile flavorings (aroma)	[50,147,201–205]
Use of cyclodextrins	[206]
Use of extrusion coating	[48]
Use of fluidized bed by spraying	[207]
Use of sorbitol and other ingredients	[208]
Use of water-insoluble coatings	[63]
Flavor food ingredients encapsulation	[209–211]
Coffee and tea flavor encapsulation	[167,212,213]
Seasonings	[71,214]
Spray-dried spice oils	[124]
Artificial flavors	[31]
Flavors from microorganisms	[215]

Source: F. Shahidi and X.-Q. Han, *Crit. Rev. Food Technol.* 33: 501 (1993).

**TABLE 22.6**

Stability of Microencapsulated Flavors

Encapsulated Flavor	Average Capsule Size ( $\mu\text{m}$ )	Storage Period (days)	Flavor Content in Microcapsules (%)	
			Initial Cassia	Final
Cassia	750	730	87.8	86.1
	20	730	63.1	59.2
	600	400	90.2	89.9
Lemon	250	500	70.5	76.3
	40	730	74.0	67.9
	20	730	60.1	59.9
Lime	1000	409	92.5	89.6
Peppermint	500	732	75.3	74.6
	20	730	58.5	56.3

Source: F. Shahidi and X.-Q. Han, *Crit. Rev. Food Technol.* 33: 501 (1993).

in an extruded glassy matrix. Such a procedure of double encapsulation was developed by Levine et al. [216]. Excellent reviews of microencapsulation technology as it applies to food flavors have been written [14,23,106,123,177,179,182]. It should be noted, however, that details pertaining to these techniques are difficult to obtain since they tend to be of a proprietary nature.

### 22.4.3 Sweeteners

Sweeteners are often subjected to the effects of moisture or temperature. Encapsulation of sweeteners—namely sugars and other nutritive or artificial sweeteners—reduces their hygroscopicity, improves their flowability, and prolongs their sweetness perception. Sugar, that has been encapsulated with fat and incorporated in a chewing gum, requires more shear and higher temperatures to release its sweetness than uncoated sugar, which dissolves more rapidly in the mouth.



**TABLE 22.7**

Changes in the Flavor Content of Cyclodextrin–Spice Complexes after 10 Years under Normal Storage Conditions

Sample	Flavor Content of the Samples (%)	
	In 1977	In 1987
Garlic oil	10.2–10.4	10.0–10.3
Onion oil	10.4–10.6	10.2–10.4
Caraway oil	10.5	9.9–10.2
Thyme oil	9.4–9.8	9.0–9.2
Lemon oil	8.9–9.1	8.6–8.8
Anise oil	9.0–9.2	9.0–9.3
Peppermint	9.4–9.7	9.0–9.2
Marjoram	8.8–9.0	8.0–8.2
Orange	9.0–9.5	6.0–7.0
Tarragon	10.0–10.3	8.8–9.0
Mustard	10.8–11.0	11.0–11.2

Source: F. Shahidi and X.-Q. Han, *Crit. Rev. Food Technol.* 33: 501 (1993).

Patents awarded for the encapsulation of sweeteners emerged mainly during the 1980s, as the technical development of encapsulation allowed their commercial manufacture. Among these, aspartame is the most widely studied sweetener. It is the methyl ester of a dipeptide made from two amino acids, phenylalanine and aspartic acid (aspartate). Although this white, odorless, and crystalline powder has a very intense sweetness, ~180 to 220 times sweeter than sucrose, the potential for aspartame's usage in food has, in the past, been limited. At high temperatures, aspartame degrades into the amino acids, aspartic acid and phenylalanine, which is accompanied by a loss in sweetness. This internationally marketed sweetener has now been encapsulated by many methods.

Patents awarded to Cea et al. [217,218] are mainly on the encapsulation of APM (L-aspartyl-L-phenylalanine methyl ester) in a chewing gum composition. It has been claimed that the encapsulated APM overcomes difficulties experienced in the use of APM with respect to its stability in the presence of water or elevated temperature [217,218]. Yang and coworkers developed a process for encapsulating aspartame in a film composed of high molecular weight polyvinyl acetate and a hydrophobic plasticizer (mono- or diacylglycerol with fatty acid chains of 16–22 carbon atoms) [211,219,220]. By this process active ingredients, including soluble dietary fibers, flavoring agents, and drugs, can also be encapsulated. The product may be used to give chewing gum an extended shelf life, with highly controlled release of active ingredients [211].

A process developed by Cherukuri and coworkers can be used to produce a stable delivery system. It comprises a dipeptide or amino acid sweetener or flavorant or mixture thereof encapsulated in a mixture of fat and high melting point polyethylene wax [221–223].

Gas chromatographic analyses were employed to measure the retention of orange, synthetic peppermint, and natural lemon flavors, which had been cocrystallized and then stored in polyethylene bags under ambient conditions. Data indicated that there was no significant ( $P > 0.05$ ) change in flavor retention for up to 15 weeks of storage. Results from oxidation studies [224] showed that peanut-butter-flavored products had a very good shelf life, even after storage for an appreciable period of time. Chen et al. [51,52,224,225] published a number of patents in this area. Some typical examples of products encapsulated by cocrystallization are listed in Table 22.8.

#### 22.4.4 Colorants

Natural colors, such as annatto,  $\beta$ -carotene, and turmeric, present solubility problems during their use and may create dust clouds. Encapsulated colors are easier to handle and offer improved solubility, stability to oxidation, and control over stratification from dry blends. Synthetic colors, together with other food ingredients, can also be encapsulated to improve their stabilities [226].

**TABLE 22.8**

Examples of Products Encapsulated by Cocrystallization

Flavored sugar crystals	Brown sugar, chocolate, honey, molasses, and peanut butter granules
Fruit juice crystals	Cranberry, grape, orange, raspberry, and strawberry juices
Essential oil powders	Cinnamon, lemon, orange, and peppermint oils
Dry flavors	Barbecue, beef fat, butterscotch, chocolate, maple, and smoke flavors
Volatile substances	Acetaldehyde and diacetyl

A technique for solubilizing oily substances in micellar solutions of protein and carbohydrates was applied by Ono [227] to achieve encapsulation of two oil-soluble pigments, namely, paprika oleoresin and  $\beta$ -carotene. The pigment in oil was solubilized in an aqueous solution containing 60% (w/w) corn syrup solids and 1% (w/w) polypeptone. The solubilized mixture so obtained was solidified by vacuum drying at 60°C and formed into granules by crusting and sieving. These granules containing ~12% pigment-containing oil underwent virtually no discoloration during storage for 20 days at 60°C or when subjected to irradiation from a fluorescent lamp. Dispersibility of the pigments in water was improved by their encapsulation in the protein-carbohydrate matrix [227].

Ciliberto and Kramer [228] developed an encapsulation process for producing granular water-soluble food ingredients, which otherwise deteriorated on exposure to the atmosphere (such as coloring agent). It was claimed that the resulting coated particles had a long shelf life and were still substantially instantaneously soluble in water.

Studies for a nitrite-free meat curing system involving the preformed CCMP revealed that the pigment could be stabilized effectively by its encapsulation in food-grade starch-based wall materials. The encapsulated product was prepared from modified starches (e.g., N-LOK™) and  $\beta$ -cyclodextrin using a spray-drying technique. The powdered cooked cured-meat pigment (PCCMP) so obtained was stable under refrigeration conditions for up to 18 months in some preparations. The color stability of PCCMP-treated meat products was found similar to their nitrite-cured analog [229].

### 22.4.5 Lipids

Lipids contribute to more than 30% of the dietary energy of North Americans, and similar figures apply to many other affluent societies. Use of lipids/fats is commonplace in food processing practices, but the susceptibility of lipids to oxidative degradation during processing and storage is always a concern; particular attention must be paid to foodstuffs containing higher proportions of polyunsaturated fatty acids (PUFAs). One possible way to protect lipid moieties against oxidative deterioration is via encapsulation. Early research in this area focused mainly on the production of encapsulated lipids for animal feed [199,230–232], but more recently, encapsulated high-fat powders or shortenings have been available in food formulations for human [233].

Because of the prohealth benefits of fish oils, encapsulated oils have been available in health food stores, pharmacies, and supermarkets for a number of years. These fish oils contain long chain omega-3 PUFAs, such as EPA, DHA, and docosapentaenoic acid (DPA), whose beneficial effects have been ascribed to their ability to lower blood serum triacylglycerol and cholesterol levels [234,235]. While DHA is essential for proper functioning of the eye and may have a structural role in the brain, EPA serves as a precursor to eicosanoid compounds [236] and has therapeutic benefits for human cardiovascular diseases [237,238]. It should be noted that fish oils are exceptionally susceptible to autoxidation and can form complex mixtures of high molecular weight oxidation products. Shukla and Perkins [239] reported that because of the unknown health effects of the oxidative polymeric materials and their high level in some encapsulated oils, caution should be exercised when ingesting fish oil capsules on a regular basis. Nevertheless, encapsulation can enhance the oxidative stability of these oils.

Gejl-Hansen and Flink [240] freeze dried an aqueous emulsion of linoleic acid in a maltodextrin coating in the presence of detergents. The microencapsulated linoleic acid was not susceptible to oxidative deterioration even though more effective encapsulating wall materials could have been used. Ono and Aoyama [104] reported that vacuum-dried rice brain oil embedded in granules containing corn syrup solids and pork polypeptide did not undergo much oxidation upon exposure to air at high temperature for a few weeks. Taguchi et al. [241] reported the oxidative stability of sardine oil embedded in spray-dried egg white powder and use of the product as a source of omega-3 PUFAs for fortification of cookies. These authors reported that the employment of microencapsulated sardine oil in fortified cookies did not affect their sensory quality.

Iwami et al. [242] compared the antioxidative efficacies of spray-dried powders, at various water activities, prepared from alcoholic solutions of gliadin, linoleic acid, and palmitic acid against powders produced by simple mixing of these components in identical portions, and against gelatine or starch powders substituted for gliadin. The authors reported that the microcapsules so obtained from the experiment were highly resistant to oxidative deterioration during long-term storage at various  $a_{w,s}$  [242]. Shahidi and Wanasundara [243] spray dried an emulsion of seal blubber oil, which contained 21%–26% long chain omega-3 fatty acids, with either  $\beta$ -cyclodextrin, corn syrup solids, or maltodextrins. They found  $\beta$ -cyclodextrin to be the most effective entrapping agent as it prevented oxidative deterioration of the seal blubber oil.

#### 22.4.6 Vitamins and Minerals

Most vitamins cannot be synthesized by the body and must be supplied through the diet [244]. Because vitamins are such important nutritional and dietary factors, processed foods are often enriched or fortified with them. Table 22.9 presents the recommended daily allowances for vitamins A, D, E, K, C, B<sub>6</sub>, B<sub>12</sub>, folic acid, thiamine, riboflavin, and niacin as compiled by the National Academy of Sciences' Food Nutrition Board [245]. Vitamins and minerals are often added to dry mixes to fortify a variety of foods.

Encapsulation of vitamins and minerals offers many advantages as it reduces off-flavors contributed by certain vitamins and minerals, permits time release of the nutrients, enhances stability of vitamins to extremes in temperature and moisture, and reduces each nutrient's reaction with other ingredients. Encapsulation also improves flow properties and reduces dusting when nutrients are added to dry mixes. Both fat- and water-soluble vitamins may be encapsulated with a variety of coatings to provide many advantages. Hall and Pondell [246] developed a process to encapsulate vitamin or mineral particles. The coating matrix for this process is chiefly ethylcellulose together with propylene glycol monoester and acetylated monoglycerol. Vitamins and minerals can also be encapsulated in fat [247] or starch matrices [248].

**TABLE 22.9**

Recommended Dietary Vitamin Allowances

Vitamin	Men	Women	Children up to Age 11
<i>Fat soluble</i>			
Vitamin A (retinol, $\mu\text{g}$ )	1000	800	400–700
Vitamin D (cholecalciferol, $\mu\text{g}$ )	5–10	5–10	10
Vitamin E ( $\alpha$ -tocopherol, mg)	10	8	6–7
Vitamin K ( $\mu\text{g}$ )	45–80	45–65	15–30
<i>Water soluble</i>			
Vitamin C (mg)	60	60	40–45
Vitamin B <sub>1</sub> (thiamin, mg)	1.5	1.1	0.7–1.0
Vitamin B <sub>2</sub> (riboflavin, mg)	1.7	1.3	0.8–1.2
Niacin (mg)	19	15	9–13
Vitamin B <sub>6</sub> (pyridoxine, mg)	2.0	1.6	1.0–1.4
Vitamin B <sub>12</sub> ( $\mu\text{g}$ )	2.0	2.0	0.7–1.4
Folic acid ( $\mu\text{g}$ )	200	180	50–100

Source: J. Giese, *Food Technol.* 49(5): 110 (1995).

For encapsulation of water-soluble vitamins, ethylcellulose is useful because it is water insoluble, and coatings with increased thickness reduce the water permeability of the prepared capsules. Thiamine enrichment of some bakery products, such as devil's food cake, ginger snaps, and soda crackers, has always been unsuccessful owing to the vitamin destruction in the neutral or alkaline pH. A procedure for microencapsulating thiamine in an ethylcellulose coating to protect it from alkaline conditions experienced in bakery products, and mask its undesirable bitter taste, has been successfully developed [249].

Riboflavin, thiamine, and niacin are partially destroyed during processing and cooking of pasta products. Studies on unprotected versus encapsulated thiamine, riboflavin, and niacin in cooked enriched spaghetti showed that concentrations of the three B vitamins tested were higher in cooked pasta that contained encapsulated vitamins [250].

Lipid-soluble vitamins lose their activity due to isomerism, anhydrovitamin formation, oxidation, and photochemical reactions [162]. Losses of vitamins in fortified foods can be minimized if they are added as cyclodextrin complexes [162] or gelatine-encapsulated beadlets [251]. It was found that the stability of vitamin A in skim milk was substantially increased by its encapsulation in gelatine. Loss of the vitamin in fortified milk powder was minimal even when heated at 100°C for 9 min or stored at 28°C for 40 weeks [251]. Table 22.10 presents the stability data of vitamin A palmitate, of 325,000 units per gram potency, encapsulated in a modified gelatine film [18]. The data indicate that the rate of vitamin A degradation under the test conditions is significantly reduced by microencapsulation.

A well-designed phase-separation technique for the encapsulation of vitamin A was developed by Markus and Peleh [252]. The matrix components employed consisted of substituted cellulosic materials, fatty acids, or a variety of proteins. Antioxidants such as butylated hydroxytoluene and ethoxyquin were incorporated in the formulations. It has been claimed that the capsules prepared with substituted cellulosic materials gave the best protection to vitamin A from degradation [252].

Iron compounds have been encapsulated to improve the color, odor, and shelf life of fortified products. Encapsulation reduced the capability of iron to react with other food ingredients and also lightened the color of an unspecified type of electrolytic iron [253]. The process for encapsulation of ferrous sulfate was developed by Jackel and Belshaw [254] in the 1970s. It is reported that the encapsulated ferrous sulfate, a fine, white, free-flowing powder, can stand a 6-month storage without any deteriorative change. Harrison et al. [255] examined the effect of iron in various forms on the oxidation of lipids in white flour. When subjected to an accelerated stability test (i.e., stored at 50°C), flours enriched with ferrous sulfate, fat enriched with ferrous sulfate, electrolytic iron powder, and carbonyl iron powder developed an unacceptable oxidized flavor after 8 days. However, oxidation was not detected in flour stored at room temperature for 2 years [255].

Soy milk beverages are possible alternatives to cow's milk. The health benefits of soy isoflavones, namely daidzein, genistein, and glycitein, on account of their phytoestrogenic activity and importance to women's nutrition have grabbed the attention of consumers. Unfortunately, soy milk is nutritionally inferior to cow's milk with respect to its calcium content. Attempts to fortify soy milk with calcium have been unsuccessful since soy protein was coagulated and precipitated by calcium [256,257]. Hirotsuka et al. [257] found that calcium coated with lecithin to form liposomes could be added to soy milk without undesirable calcium-protein interactions. The technology has been successful in fortifying 100 g of soy milk with an additional 120 mg of calcium.

**TABLE 22.10**

Stability of Vitamin A Palmitate at 45°C and 75% Relative Humidity

Time (days)	Percentage of Potency Retained	
	Raw Oil	Microencapsulated
5	86.1	98.3
15	84.2	97.8
42	76.2	94.2
56	69.9	94.1

Source: J. A. Bakan, *Food Technol.* 27(11): 34 (1973).

### 22.4.7 Enzymes

Enzymes are increasingly utilized by the food industry in a wide variety of applications. Encapsulation of enzymes can enhance their properties in a number of different ways. Of these, the first and foremost concern is stability. The complex biochemical structure of the enzyme can make it highly vulnerable to inactivation by other components or conditions within the food matrix. By segregating the enzyme inside a microcapsule, it can be maintained in conditions that could otherwise be very harmful to it. A variety of other stabilizing materials can be encapsulated alongside the enzyme to protect them from different antagonistic effects. Inhibitory agents and harmful ions will be excluded from the capsule. Penetrating ions can be removed by buffers or chelating agents, and oxidative damage may be prevented by the use of antioxidants. Thermostabilizers, such as sugars, will protect against extreme processing conditions such as dehydration or freezing. Further stabilization may be achieved by simply maintaining the enzyme in a concentrated form rather than allowing it to become diluted into the bulk-food phase.

As long as it remains encapsulated, the enzyme will be isolated from its substrate and therefore latent and passive within the food matrix. By selecting a capsule with appropriate properties, we can choose when, where, and how to interact the enzyme with its intended substrate. By altering the surface properties of microcapsules, they can often be made to accumulate at a particular microscopic location within the food. When they eventually break down, the enzyme activity will be concentrated at the intended target site rather than nonspecifically dispersed throughout the food. In this way, enzymes can be utilized much more selectively, and with far greater efficiency than their normal usage would permit.

The timing of enzyme release can be controlled by selecting a microcapsule according to its stability properties within a particular food system. Low stability will lead to early release in the food process, whereas a more stable one will allow postponement of its release. This is a very useful where early release is undesirable and enzyme action is not needed until a later step of a multistage process.

Considerable progress in research for the control of cheese ripening using encapsulated enzymes has been achieved [186,187,189,258–264]. Principles involved in this application provide a good illustration of how encapsulation can be applied generally to the food industry, as it has been reviewed by Kirby and Law [190]. Other enzymes such as lipase [265,266] and invertase [267,268] have also been encapsulated for applications in food processing.

### 22.4.8 Microorganisms

Encapsulation of viable bacterial cells has several advantages over encapsulation of isolated cheese ripening enzymes. The stability of enzymes in intact cells is greater than in extracts. Production achieved by cells is also easily manipulated by controlling substrate concentration in the microcapsules [262].

Kim and Olson [263] reported that cells of *Brevibacterium linens* were successfully entrapped in milk-fat-coated microcapsules. It is believed that the bacteria using methionine to produce methanethiol and other sulfur compounds make a major contribution to cheddar cheese flavor of low-fat cheese products. Microencapsulated microorganisms may be helpful in reducing the ripening time of blue cheese or in imparting blue cheese flavor to other foods. Spores of *Penicillium roqueforti* were encapsulated in a milk-fat-coating matrix [181]. The microenvironment provided by the microcapsules enhanced methyl ketone production by spore enzymes.

Recently, intensive research efforts have been focused on protecting the viability of bacterial cultures, which demonstrate probiotic activity, during the product's manufacture, storage, and gastric transit. Studies have demonstrated that probiotic cultures can be significantly protected via encapsulation using a variety of carriers. In essence, microencapsulation has been at the forefront of the functional food and nutraceutical revolution, as it relates to probiotics.

Probiotics are described as "live microorganisms which when administered in adequate numbers confer a health benefit to the host" [269]. The concept of probiotics was first proposed by Nobel Prize-winning Russian scientist Elie Metchnikoff in 1908, who stated that live beneficial bacteria such as lactic acid bacteria needed to be ingested on a regular basis through fermented dairy products, such as yoghurt, to maintain a good equilibrium of the intestinal microflora and minimize putrefactive fermentations. Today, these supplements contain beneficial, friendly bacteria of the *Lactobacillus* and *Bifidobacterium* species, and are

formulated to reflect the composition of healthy gut flora; they have a direct impact on both the host's metabolism and physiology. For a microorganism to be classified as a probiotic, it must be (i) isolated from humans; (ii) compatible with humans; (iii) safe for humans; (iv) able to survive the acid conditions in the stomach; (v) able to grow and colonize in the gut; (vi) antagonistic to pathogenic bacteria; and (vii) shown to have scientifically proven efficacy. Moreover, probiotics share a number of common traits such as a generally regarded as safe (GRAS) status, acid and bile tolerance, and an ability to adhere to intestinal cells [270]. Though probiotics are commonly added to fermented milks, yoghurts, and cheeses (i.e., as functional foods), they are also available as dietary supplements, where the probiotic is in the form of a dried encapsulated product or capsule [271]. Clinical studies have shown beneficial health effects from the consumption of probiotics of the *Lactobacillus* and *Bifidobacterium* species, and these include reduction of rotavirus diarrhea, alleviation of lactose intolerance symptoms, reduction of harmful intestinal microbial enzyme activity, decrease in fecal mutagenicity, aid in digestion, prevention of illness by inhibiting the growth of pathogenic and putrefactive bacteria in gastrointestinal (GI) tract, and possibly assistance in the reduction of cholesterol [272–275]. The probiotics market offers great potential for manufacturers and continues to gain momentum despite the complex processing challenges of formulating products with these beneficial microorganisms.

In Japan, there is a long tradition that health is dependent on food and in particular that the maintenance of a population of beneficial bacteria is important. The addition of probiotics to foods is seen as an effective means of restoring some of the initial beneficial food-associated microflora that may be destroyed during microbial reduction treatments such as pasteurization. The Japanese have long believed that probiotic bacteria must arrive at the site of action in large enough numbers to exert their effect, and this might most easily be achieved by using resistant bacteria or by providing large numbers of live bacteria when consumed, to compensate for losses during passage through the upper GI tract. Mortality rates as high as 90%–99% are usually reported for unprotected probiotics exposed to the low-pH conditions of the stomach and to the bile acids in the duodenum. The “Fermented Milks and Lactic Acid Bacteria Beverages Association” in Japan has set a minimum of  $10^7$  bifidobacteria or CFU/mL of product [276,277]. Furthermore, the probiotic food product must be consumed regularly to ensure that a sufficient “dose” of live bacteria is delivered to the gut. Consequently, technological issues relating to the development of foods containing these bacteria in sufficient numbers throughout shelf life need to be overcome as well as a means of stabilization following ingestion; that is, during exposure to the adverse conditions of the human GI tract [271]. This is where encapsulation technology has stepped in to give a helping hand: microencapsulated probiotic products can overcome the major hurdles of the GI tract and offer better potencies than unprotected products. The probiotic food industry has also been increasingly utilizing encapsulation as a means of protecting live cells from extremes of heat or moisture, such as those experienced during drying and storage [278,279].

Spray dried powders possessing high numbers of viable probiotics are a convenient means of storage and transport of probiotic cultures and their subsequent application to functional foods. Most probiotic lactobacilli, however, do not survive well during the temperature and osmotic stresses they face when spray dried [280,281]. Thermal and dehydration damage to cell membranes and proteins lead to bacterial cell injury and eventually death. To overcome this problem, one approach has been the addition of thermoprotectants to the media prior to drying. Desmond et al. [282] reported that the incorporation of soluble fiber (as a prebiotic—an energy source for the probiotic) and gum acacia to a milk-based medium prior to spray drying of the probiotic, *Lactobacillus paracasei* NFBC 338, increased the culture's viability during drying and powder storage compared to that of milk powder alone. In this situation, the encapsulated product not only offered better probiotic viability, but it can also be regarded as a synbiotic given the presence of both probiotics and prebiotics. Other investigated prebiotics such as inulin and polydextrose did not enhance probiotic viability during drying or powder storage [283].

Several methods of microencapsulation of probiotic bacteria have been reported: these include spray drying, extrusion, emulsion, and phase separation [284,285]. In a study by Guerin et al. [286], *Bifidobacterium bifidum* cells encapsulated in gel beads composed of alginate, pectin, and whey proteins, and surrounded by two membranes exhibited good survival at pH 2.5 for up to 2 h, while free cells did not survive under these conditions. Furthermore, protection was afforded by this system when the cells were exposed to bile salt solutions. Selmer-Olsen et al. [287] reported that encapsulated lactobacilli in

calcium-alginate beads had improved heat tolerance, and O'Riordan et al. [279] demonstrated that this technology also prolonged the viability of spray-dried *Bifidobacterium ruminatum* during storage. Probiotic bacteria have also been microencapsulated in a matrix of vegetable fatty acids. This technique broadens the range of ingredients with which probiotics can be blended and formulated. Moreover, the passage through the GI tract is very stressful for probiotics, especially on an empty stomach where the pH can be as low as 1.5; thus, the hydrophobic coating surrounding the microencapsulated bacteria protects the fragile microbial cells and allows them to pass into the intestine. According to Frost & Sullivan Research Service [3], the future for probiotics is bright because their encapsulation in hydrocolloid beads is helping to improve their survival rate right through both processing and digestion. As the technology matures and improves, it is hoped in time that a mechanism for targeting the release of beneficial bacteria in specific sites of the human GI tract will be provided.

#### 22.4.9 Gases

Some hard candies can be made with entrapped carbon dioxide gas [265]. The confections made with encapsulated carbon dioxide produce a sizzling effect on the tongue as the candy melts in the mouth. The candy is produced by incorporating gas at a pressure of 50–1000 psi into the molten sugar. Concentrations of carbon dioxide in the candy range from 0.5 to 15 mL per g sugar [265]. Gas can also be injected to the encapsulation system and be coated together with the foaming and aromatic core mixtures [204].

#### 22.4.10 Other Food Additives and Ingredients

Almost all traditional food additives, functional food ingredients, and bioactives can theoretically and technically be encapsulated. Only a limited number of encapsulated ingredients are, however, commercially available owing to the fact that there are many factors that must be considered before a process/product can lead to commercial realization. Research has been done to encapsulate food preservatives such as monocapric acid [288] and oleic acid [289]. A process for preparing a coated-particle salt substitute composition was described by Meyer [290]. Studies have also suggested that encapsulated antioxidants might be beneficial to food preservation [291]. With the public's and industries' growing interest in functional foods and nutraceuticals, it is safe to assume that many new food ingredients offering health- and wellness-related benefits will be a reality in the coming years.

---

### 22.5 Controlled-Release Mechanism and Effects

Encapsulation allows reactive ingredients to be separated from the environment until their release is desired. Though separation is the goal of encapsulation, release mechanisms of the core material must be considered. In fact when designing a custom encapsulated food ingredient, one must determine the desired release mechanism and a method for ensuring quality control. For example, in home-baked pizza products, sodium bicarbonate can be encapsulated to prevent early release of the bicarbonate and delay the reaction of the leavening phosphate until the crust reaches a particular temperature in the oven. Controlled-release technology can help a wide variety of nutraceuticals/bioactives deliver their payloads more effectively while heightening produce resale frequency for brands and retailers. In essence, a well-controlled release of core material is a very important property of microcapsules. For example, a substance in formulated food may be released upon consumption but prevented from diffusing throughout the product during processing operations (e.g., flavors and nutrients). Similarly, an additive may be released in a specific processing step, but protected in preceding operations (e.g., acids, leavening agents, and crosslinking agents) [292].

Because the physical and chemical properties of volatile compounds are governed by their structures and cannot be changed, one has to manipulate the choice of the encapsulation matrix as well as the formulation of the flavor itself, if the flavor is a compound flavor. By picking a capsule matrix with limited selectivity, which may in fact be chosen to discriminate against vapor pressure differences and the desired flux rate (to release slowly or quickly but uniformly), flavor imbalances can be minimized. Additionally, if the flavor is a formulated one, there may be some opportunity to choose flavor compounds, which will

**TABLE 22.11**

Mechanisms of Release from Controlled-Release Delivery Systems in Consumer Products

Diffusion-controlled release	Membrane-controlled release
Pressure-activated release	Tearing or peeling release
Solvent-activated release	Osmotically controlled release
pH-sensitive release	Temperature-sensitive release
Melting-activated release	Hybrid release

Source: L. Brannon-Peppas, *Polymeric Delivery Systems* (M. A. El-Nokay, D. M. Piatt, and B. A. Charpentier, eds.), ACS Symposium Series No. 520, American Chemical Society, Washington, DC, 1993, p. 42.

**TABLE 22.12**

Parameters Affecting the Release Rate of Core Materials

Coating properties	Density, crystallinity, orientation, solubility, plasticizer level, cross-linking, pretreatments
Capsule properties	Size, wall thickness, configuration, conformity, coating layers, post-treatment
Experimental parameters	Temperature, pH, moisture, solvent, mechanical action, partial pressure differential (inside and outside of coating)

Source: F. Shahidi and X.-Q. Han, *Crit. Rev. Food Technol.* 33: 501 (1993).

have similar release rates. Such well-controlled release delivery systems present the food technologist with exciting opportunities for improving the performance of existing food processes as well as for the development of functional foods [191,292]. To adequately address the issue of controlled release, one needs to examine the basic principles of controlling the release of encapsulated materials and then consider which technologies can be applied in the food industry. The various mechanisms of release from controlled-release delivery systems in consumer products are provided in Table 22.11 [293].

### 22.5.1 Release Rate

Release rates that are achievable from a single microcapsule are generally zero, half, or first order. Zero order occurs when the core is a pure material, which may be released through the wall of a microcapsule as a pure material. Half-order release generally occurs with matrix particles, while first-order release occurs when the core material is actually a solution trapped within a solid matrix [292]. As the solute material releases from the capsule, a desired concentration of solute is reached.

A mixture of microcapsules will include a distribution of capsules varying in size and wall thickness. The effect, therefore, is to produce a release rate different from zero, half, or first order because of the ensemble of microcapsules. Thus, it is desirable to carefully examine the experimental basis of the release rate from an ensemble of microcapsules, and recognize the deviation from theory owing to the distribution in size and wall thickness [12]. Numerous factors affecting the release rate of core materials are summarized in Table 22.12.

### 22.5.2 Release Mechanisms

The coating not only protects the core material from moisture, light, oxygen, other food ingredients, and additional external agents [143], but it allows/assists in controlling the release of core materials. Thus, release of the core material is dependent upon the type and geometry of the particle and the wall material used to form the microcapsule. These factors dictate the mechanism of release for the capsule, which may be based on solvent effects, diffusion, degradation, or particle fracture [294]. A variety of release mechanisms, which have been proposed for microcapsules, are summarized below.



### 22.5.2.1 Fracturation or Pressure-Activated Release

A number of controlled-release systems prepared primarily by coacervation technology depend on pressure for release of the active core [295]. The coating can be fractured or broken open by external forces, such as pressure, shearing, ultrasonics, or by internal forces, as would occur in a microcapsule having a permeation-selective coating. Both fracturation and diffusion involve the controlled release of volatile materials; however, a slow release of core material from the capsule in the case of fracturation is a detriment rather than an attribute. A completely impermeable capsule is needed that releases only on rupture. For example, capsules made from hardened fats or waxes are insoluble in water but can be made to release their contents by mechanical breakage, e.g., shear, or by increasing the temperature to the melting point of the fat (see Section 22.5.2). The act of chewing is the most commonly used mechanical release means. It is also possible to get release of the core substance by incorporation of a swelling agent to the core substance or by an electromagnetic method using discharge or magnetic force. The force-fractured release is accomplished in a relatively shorter duration beginning at certain controlled conditions compared to the other release mechanisms.

### 22.5.2.2 Diffusion

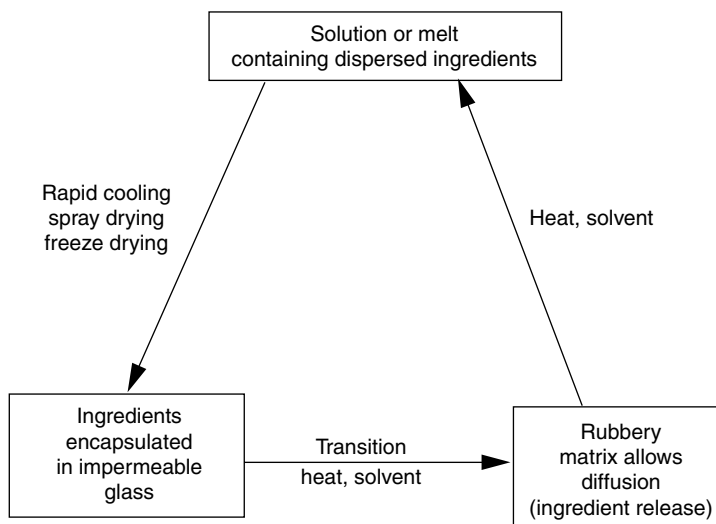
This mechanism acts to limit the release of core material from within the capsule to the surface of the particle by controlling the rate of diffusion of the active compound. The bulk of the capsule material itself may control release (i.e., matrix-controlled release) or a membrane may be added to the capsule for controlling release (i.e., membrane-controlled release). Most microcapsules have thin walls, which may function as a semipermeable membrane. Furthermore, because microcapsules have a very small size, they have a very large surface area per unit weight. Hence, controlled release is frequently accomplished through a diffusion-controlled process [296].

Diffusion release depends upon the kinetic relationship between the core and wall materials and the rate at which the core material is able to pass through the outer wall. It is strictly governed by the chemical properties of the microcapsule and by the physical properties of the wall material such as the matrix structure and pore sizes [294]. Diffusion is a permeation process driven by a concentration gradient or interchain attractive forces [297]. In other words, it is controlled by the solubility of a component in the matrix (this establishes a concentration gradient in the matrix for driving diffusion) and the permeability of the component through the matrix. In the absence of cracks, pinholes, or other flaws, the primary mechanism for core materials to flow through a wall or coating is by activated diffusion; that is, the penetrant dissolves in the film matrix at the high-concentration side, diffuses through the film driven by a concentration gradient (i.e., Fick's law,  $I_A = -D_{AB} dC_A/dy$ , where  $I_A$  is the flux of the core material in the  $y$  direction,  $D_{AB}$  the diffusivity, and  $dC_A/dy$  the concentration gradient), and evaporates from the other surface. It should be noted that if the food component were not soluble in the matrix, it would not enter the matrix to diffuse through, irrespective of the matrix' pore size.

Diffusion also depends upon the size, shape, vapor pressures, and polarity of the penetrating molecules as well as segmental motion of polymer chains [297,298]. This also includes interchain attractive forces such as hydrogen bonding and van der Waals' interactions, degree of crosslinking, and the amount of crystallinity [299]. In general, crosslinking of a matrix has little meaning in most food applications. This is because very few situations exist where the matrix can be crosslinked considering the limitations imposed by having food-approved materials [296]. Crosslinking of proteins as a consequence of Maillard reactions can, however, occur and possibly influence the diffusion of solutes in heated protein-based encapsulation matrices (e.g., gelatine). In effect, the greater the degree of crosslinking, the lesser the rate of diffusion through the matrix; hence, a readily controllable process of making a controlled-release capsule.

The problem of uniform releasing of the aroma of an encapsulated flavor in food should be noted. Because a flavor consists of aroma compounds with a range of volatilities, their release, for example, into the headspace of a food package will not be uniform and therefore a balanced characteristic food aroma may not be achieved [300]. The volatility or vapor pressures of these different compounds and their resistances to diffusion will affect their rate. Aromas could, therefore, become imbalanced as the constituents diffuse through the capsule.

For most physical methods, it is known that the success of encapsulation depends on the formation of a metastable amorphous structure, a glass, with a very low permeability to organic compounds, which



**FIGURE 22.13** Preparation and release of core ingredients from microcapsules. (From M. Karel and R. Langer, *ACS Symposium Series*, 370, 1988; M. El-Soda, L. Pannell, and N. Olson, *J. Microencap.* 6: 319, 1989.)

are encapsulated within it. In drying processes, the presence of sugar or polymers in the encapsulation system reduces the water content. Reduction of water content lowers the glass transition temperature and the resulting amorphous matrix is impermeable to organic compounds as well as to oxygen. However, permeability to water remains finite. This phenomenon, also known as the selective diffusion theory of Thijssen and Rulken [301], is the basis for encapsulation using spray and freeze drying [292]. In spray drying, upon droplet formation, rapid evaporation from the surface produces a surface layer in which the selective diffusion mechanism operates. In freeze drying, upon water crystallization, the nonfrozen solution is viscous and the diffusion of core materials is retarded. At the beginning of freeze drying, the surface of this solution becomes an amorphous solid in which selective diffusion comes into play.

The permeability of the coating structure can be changed by controlled conditions. The physical state of the food polymer has a considerable role in influencing diffusion and thus release of the core material. The physicochemical principles governing the softening or glass transition of the encapsulating materials have been studied by several researchers [302–305]. These investigations have shown that the release occurs when the glassy, impermeable structure undergoes a transition to a more mobile rubbery state (Figure 22.13). Thus, the glass/rubber transition of a matrix material is a relevant consideration when evaluating release properties. The relation of transition temperature to the composition of encapsulating formulations has been studied by To and Flink [306] and by Levine and Slade [303] for the case of starch-derived encapsulating agents. It must be noted however even after the critical moisture content or the critical temperature is exceeded, the rate of release is also a function of water content, temperature, and time [307]. This fact allows the generation of controlled-release delivery systems. The maltodextrins and similar materials with controlled collapse temperatures are important not only as encapsulating agents, but are also extremely useful in protecting enzymes and other sensitive biological materials during dehydration and subsequent storage. The principles are similar in that the sensitive materials are placed in a medium in which their mobility is restricted.

### 22.5.2.3 Solvent-Activated Release

Solvent-activated release is the most common controlled-release mechanism used in the food industry. Since most encapsulating matrices are water soluble, the water in the food product dissolves away the microcapsule thereby liberating its content to the food, or it causes the capsule to swell to either begin or enhance the release of the core material. However, water-insoluble coatings can also be dissolved by selecting an appropriate solvent. Encapsulated agents are often added to dry food products, such as dry beverages, and cake and soup mixes. The encapsulated flavors in these products are released upon

rehydration [296]. Their release may be a sudden burst, or a continued or delayed delivery regulated by controlling the rate of wall solubility, the swelling of the wall material, pH effects, or changes in the ionic strength of the surrounding medium [294].

Though most traditional wall materials will rapidly release the core material once they are rehydrated, microcapsule matrices may be modified to release the active material/bioactive at a desired point in time. Osmotically controlled release is similar to solvent-activated release in that the core of the particle adsorbs a solvent (usually water) over time and swells until the capsule bursts [293]. For any food ingredient, which is first encapsulated in a hydrophilic matrix and then coated with a lipophilic one, osmotically controlled release functions to a limited extent. The encapsulated product will eventually swell and either expand the surface coating causing cracks or fractures or rupture entirely.

#### **22.5.2.4 Melting-Activated Release**

The integrity of the coating can be destroyed by thermal means. This mechanism of release involves the melting of the capsule wall (or a protective coating that has been placed on the capsule wall) to release the active material. Because there are numerous meltable materials that are approved for food use (e.g., lipids, waxes, and modified lipids), this method of release is easily accomplished. Yet, the applications are limited. In general, salts, nutrients, leavening agents, and some water-soluble flavoring agents have been protected by hydrophobic coatings to curtail release of the active ingredient into the food until the baking process. The hydrophobic coating and core material must be immiscible with one another to avoid migration of the active ingredient through the wall material. This limits the usefulness of the technique for many flavor applications. However, an already encapsulated flavor prepared by spray drying can be coated with a hydrophobic matrix via centrifugal coating or the fluidized bed technique. In this manner, the secondary coating on the flavor provides melt release properties [308]. The major problem in this approach, however, is the dilution of the flavoring by additional wall material and the extra cost involved.

#### **22.5.2.5 Biodegradation and pH-Sensitive Release**

Release from microcapsules can be accomplished by biodegradation processes if the coatings lend themselves to such degradative mechanisms. Lipid coatings can be degraded by the action of lipases [309]. Karel and Langer [292] released enzymes from liposomes using pH as a stimulant to initiate release. They postulated that pH changes destabilized the phospholipid-based liposomal structure, thereby releasing the enzymes from the liposome core.

---

## **22.6 Conclusions**

This chapter has focused on the art of microencapsulation and has presented an up-to-date account of the process as it relates to the food industry. Although microencapsulation has been extensively used by pharmaceutical and chemical industries for many years, its applications to the food industry seem to be less frequent and may require further improvement. Food ingredients are encapsulated for a variety of reasons, including protection from volatilization during storage, protection from undesirable interactions with other food components, minimization of flavor interactions or light-induced deteriorative reactions, and protection against oxidation. More recently, the functional food and nutraceutical revolution has afforded new commercial opportunities for the employment of microencapsulation. Other benefits include ease of handling and mixing, uniform dispersion, and improved product consistency during and after processing. Yet compared with single living cells, the capsules prepared to date are too simplistic, and more development is needed before this technology can be widely applied to different facets of the food industry. Because the art of microencapsulation encompasses numerous research fields (e.g., chemistry, engineering, processing, and microbiology), innovative strategies, particularly in the areas of controlled release of encapsulated food ingredients, development of micro- and nanoencapsulated functional food ingredients, and the ever-changing technology, will offer the food scientist new and exciting avenues for research and development. The role of nanotechnology in delivery systems, including microencapsulation, nanospheres, and nanocapsules, will be prominent in the coming decades.

---

## References

1. N. Vasishta, Microencapsulation: Delivering a market advantage, *Prep. Foods* 50: 4989 (2002).
2. M. A. Augustin, L. Sanguansri, C. Margetts, and B. Young, Microencapsulation of food ingredients, *Food Aust.* 56: 220 (2001).
3. Frost & Sullivan Research Service. Opportunities in the microencapsulated food ingredients market, <<http://www.frost.com/prod/servlet/report-brochure.pag?id=B716-01-00-00-001957>> (2006).
4. J. A. Bakan, Microencapsulation, *Encyclopedia of Food Science* (M. S. Peterson and R. Johnson, eds.), AVI Pub. Co., Inc., Westport, CT, 1978, p. 499.
5. C. J. Kirby, Microencapsulation and controlled delivery of food ingredients, *Food Sci. Technol. Today* 5(2): 74 (1991).
6. S. M. Barlow, Toxicological aspects of antioxidants used as food additives, *Food Antioxidants* (B. J. F. Hudson, ed.), Elsevier Applied Science, London, 1990, p. 253.
7. P. Valentão, E. Fernandes, F. Carvalho, P. B. Andrade, R. M. Seabra, and M. L. Bastos, Antioxidative properties of cardoon (*Cynara cardunculus* L.) infusion against superoxide radical, hydroxyl radical, and hypochlorous acid, *J. Agric. Food Chem.* 50: 4989 (2002).
8. Y. S. Velioglu, G. Mazza, L. Gao, and B. D. Oomah, Antioxidant activity and total phenolics in selected fruits, vegetables, and grain products, *J. Agric. Food Chem.* 46: 4113 (1998).
9. A. H. King, Encapsulation of food ingredients: A review of available technology, focusing on hydrocolloids, *Encapsulation and Controlled Release of Food Ingredients* (S. J. Risch and G. A. Reineccius, eds.), ACS Symposium Series No. 590, American Chemical Society, Washington, DC, 1995, p. 26.
10. S. J. Risch, Encapsulation: Overview of uses and techniques, *Encapsulation and Controlled Release of Food Ingredients* (S. J. Risch and G. A. Reineccius, eds.), ACS Symposium Series No. 590, American Chemical Society, Washington, DC, 1995, p. 2.
11. C. Andres, Encapsulation ingredients: I, *Food Proc.* 38(12): 44 (1977).
12. R. J. Versic, Flavor encapsulation: An overview, *Flavor Encapsulation* (G. A. Reineccius and S. J. Risch, eds.), ACS Symposium Series No. 370, American Chemical Society, Washington, DC, 1988, p. 1.
13. T. J. DeZarn, Food ingredient encapsulation: An overview, *Encapsulation and Controlled Release of Food Ingredients* (S. J. Risch and G. A. Reineccius, eds.), ACS Symposium Series No. 590, American Chemical Society, Washington, DC, 1995, p. 74.
14. R. D. Todd, Microencapsulation and the flavor industry, *Flav. Ind.* 1: 768 (1970).
15. R. E. Sparks, Microencapsulation, *Kirk-Othmer Encyclopedia of Chemical Technology*, 3rd Ed., Vol. 15 (M. Grayson and E. David, eds.), Wiley, New York, NY, 1981, p. 470.
16. L. L. Balssa and G. O. Fanger, Microencapsulation in the food industry, *Crit. Rev. Food Technol.* 2: 245 (1971).
17. F. Shahidi and X.-Q. Han, Encapsulation of food ingredients, *Crit. Rev. Food Technol.* 33: 501 (1993).
18. J. A. Bakan, Microencapsulation of foods and related products, *Food Technol.* 27(11): 34 (1973).
19. A. Shefer and S. Shefer, Novel encapsulation system provides controlled release of ingredients, *Food Technol.* 57(11): 40 (2003).
20. M. A. Godshall, The role of carbohydrates in flavor development, *Food Technol.* 42(11): 71 (1988).
21. J. Flink and M. Karel, Effects of process variables on retention of volatiles in freeze-drying, *J. Food Sci.* 35: 444 (1970).
22. G. A. Reineccius and S. T. Coulter, Flavor retention during drying, *J. Dairy Sci.* 52: 1219 (1989).
23. G. A. Reineccius, Flavor encapsulation, *Food Rev. Int.* 5: 147 (1989).
24. G. A. Reineccius, Carbohydrates for flavor encapsulation, *Food Technol.* 46(3): 144 (1991).
25. M. O. Nisperos-Carriedo, Edible coatings and films based on polysaccharides, *Edible Coatings and Films to Improve Food Quality* (J. M. Krochta, E. A. Baldwin, and M. O. Nisperos-Carriedo, eds.), Technomic Publishing Co. Inc., Lancaster, PA, 1994, p. 305.
26. M. M. Kenyon, Modified starch, maltodextrin, and corn syrup solids as wall materials for food encapsulation, *Encapsulation and Controlled Release of Food Ingredients* (S. J. Risch and G. A. Reineccius, eds.), ACS Symposium Series No. 590, American Chemical Society, Washington, DC, 1995, p. 42.
27. S. Anandaraman and G. A. Reineccius, Stability of encapsulated orange peel oil, *Food Technol.* 40(11): 88 (1986).
28. W. E. Bangs and G. A. Reineccius, Influence of dryer infeed matrices on the retention of volatile flavor compounds during spray drying, *J. Food Sci.* 47: 254 (1982).

29. G. A. Reineccius, Part II—Flavor encapsulation, *Source Book of Flavors*, 2nd Ed. (G. A. Reineccius, ed.), Chapman & Hall, New York, NY, 1994, p. 605.
30. K. C. M. Raja, B. Sankarikutty, M. Sreekumar, A. Jayalekshmy, and C. S. Narayanan, Material characterization studies of maltodextrin samples for the use of wall material, *Stärke* 41: 289 (1989).
31. G. A. Reineccius and S. J. Risch, Encapsulation of artificial flavors by  $\beta$ -cyclodextrin, *Perf. Flav.* 11(4): 1 (1986).
32. J. Solms, Interaction of non-volatile and volatile substances in foods, *Interactions of Food Components* (G. G. Birch and M. G. Lindley, eds.), Elsevier, London, 1986, p. 189.
33. W. King, P. Trubiano, and P. Perry, Modified starch encapsulating agents offer superior emulsification, film forming and low surface oil, *Food Prod. Dev.* 10(10): 54 (1976).
34. P. C. Trubiano and N. L. Lacourse, Emulsion-stabilizing starches, *Flavor Encapsulation* (S. J. Risch and G. A. Reineccius, eds.), ACS Symposium Series No. 370, American Chemical Society, Washington, DC, 1989, p. 45.
35. T. A. Reineccius, G. A. Reineccius, and T. L. Peppard, Encapsulation of flavours using cyclodextrins: Comparison of flavour retention in alpha, beta and gamma types, *J. Food Sci.* 67: 3271 (2002).
36. D. French, The Schardinger dextrins, *Advances in Carbohydrate Chemistry*, Vol. 12 (M. L. Wolfram, ed.), Academic Press, New York, NY, 1957, p. 189.
37. A. R. Hedges, W. J. Shieh, and C. T. Sikorski, Use of cyclodextrins for encapsulation in the use and treatment of food products, *Encapsulation and Controlled Release of Food Ingredients* (S. J. Risch and G. A. Reineccius, eds.), ACS Symposium Series No. 590, American Chemical Society, Washington, DC, 1995, p. 60.
38. D. E. Pszczola, Production and potential food applications of cyclodextrins, *Food Technol.* 42(1): 96 (1988).
39. K. Lindner, Using cyclodextrin aroma complexes in the catering, *Nahrung* 26: 675 (1982).
40. S. Nagatomo, Cyclodextrins: Expanding the development of their functions and applications, *Chem. Econ. Eng. Rev.* 17: 28 (1985).
41. J. S. Pagington,  $\beta$ -Cyclodextrin and its uses in the flavor industry, *Developments in Food Flavors* (G. G. Birch and M. G. Lindley, eds.), Elsevier Applied Science Publishers Ltd., London, 1986, p. 131.
42. Anon., Vast range of potential uses for cyclodextrins, *Food Eng.* 59: 36 (1987).
43. W. Saenger, Cyclodextrin inclusion compounds in research and industry, *Angew. Chemie Int. Ed.* 19: 344 (1980).
44. M. W. Nicol, Sucrose in food systems, *Carbohydrate Sweeteners in Food and Nutrition* (P. Koivistoinen and L. Hyvonen, eds.), Academic Press, New York, NY, 1980, p. 151.
45. A. C. Chen, M. F. Veiga, and A. B. Rizzuto, Cocrystallization: An encapsulation process, *Food Technol.* 42(11): 87 (1988).
46. G. R. Huber, Carbohydrates in extrusion processing, *Food Technol.* 45(3): 160 (1991).
47. Anon., Encapsulated spice, seasoning extracts add flavor, color to dry-mix products, *Food Eng.* 53(8): 67 (1981).
48. Anon., Greater stability for encapsulated flavors, *Food Eng.* 54(11): 59 (1981).
49. J. W. Marvin, R. A. Berhard, and T. A. Nickerson, Interaction of low molecular weight adsorbents on lactose, *J. Dairy Sci.* 62: 1546 (1979).
50. J. A. Kitson and H. S. Sugisawa, Sugar captured flavor granules, *Can. Inst. Food Sci. Technol. J.* 7: 15 (1974).
51. A. C. C. Chen, C. E. Lang, Jr., C. P. Graham, and A. B. Rizzuto, Crystallized, readily water-dispersible sugar product, U.S. patent 4,338,350 (1982).
52. A. C. C. Chen, C. E. Lang, Jr., C. P. Graham, and A. B. Rizzuto, Crystallized, readily water-dispersible sugar product containing heat sensitive, acidic or high invert sugar substances, U.S. patent 4,362,757 (1982).
53. D. Knorr and R. A. Teutonico, Chitosan immobilization and permeabilization of *Amaranthus tricolor* cells, *J. Agric. Food Chem.* 34: 96 (1986).
54. D. Knorr and J. Berlin, Effects of immobilization and permeabilization procedures on growth of *Chenopodium rubrum* cells and amaranthine concentration, *J. Food Sci.* 52: 1397 (1987).
55. Y. Pandya and D. Knorr, Diffusion characteristics and properties of chitosan coacervate capsules, *Process Biochem.* 26(2): 75 (1991).
56. I. K. Greener and O. Fennema, Barrier properties and surface characteristics of edible, bilayer films, *J. Food Sci.* 54: 1393 (1989).

57. I. K. Greener and O. Fennema, Evaluation of edible, bilayer films for use as moisture barriers for food, *J. Food Sci.* 54: 1400 (1989).
58. J. J. Kester and O. Fennema, An edible film of lipids and cellulose ethers: Barrier properties to moisture vapor transmission and structural evaluation, *J. Food Sci.* 54: 1383 (1989).
59. F. Vojdani and J. A. Torres, Potassium sorbate permeability of polysaccharide films: Chitosan, methylcellulose and hydroxypropyl methylcellulose, *J. Food Proc. Eng.* 12: 33 (1990).
60. F. Vojdani and J. A. Torres, Potassium sorbate permeability of methylcellulose and hydroxypropyl methylcellulose coatings: Effect of fatty acids, *J. Food Sci.* 55: 841 (1990).
61. D. S. B. Poncelet, D. Poncelet, and R. J. Neufeld, Control of mean diameter and size distribution during formulation of microcapsules with cellulose nitrate membranes, *Enzyme Microb. Technol.* 11: 29 (1989).
62. M. Glicksman, Background and classification, *Food Hydrocolloids*, Vol. I (M. Glicksman, ed.), CRC Press, Boca Raton, FL, 1982, p. 3.
63. T. J. Carroll, D. Feinerman, R. J. Huzinec, and D. J. Piccolo, Gum composition with plural time releasing flavors and method of preparation, U.S. patent 4,485,118 (1984).
64. M. Glicksman, The hydrocolloids industry in the '80s—Problems and opportunities, *Gums and Stabilisers for the Food Industry. Interaction of Hydrocolloids* (G. O. Phillips, G. J. Wedlock, and P. A. Williams, eds.), Pergamon Press, Oxford, UK, 1982, p. 299.
65. M. Glicksman, Food applications of gums, *Food Carbohydrates* (D. R. Lineback and G. E. Inglett, eds.), AVI Publishing Co., Inc., Westport, CT, 1982, p. 270.
66. J. D. Dziezak, Focus on gums, *Food Technol.* 45(3): 116 (1991).
67. R. L. Whistler and J. R. Daniel, Functions of polysaccharides in foods, *Food Additives* (A. L. Branen, P. M. Davidson, and S. Salminen, eds.), Marcel Dekker, Inc., New York, NY, 1990, p. 395.
68. Meiji Seika Kaisha Ltd., Encapsulated liquid foods, Japanese patent 17,941/71 (1971).
69. M. Glicksman, Alginates, *Food Hydrocolloids*, Vol. II (M. Glicksman, ed.), CRC Press, Boca Raton, FL, 1983.
70. I. A. Veliky and M. Kalab, Encapsulation of viscous high-fat foods in calcium alginate gel tubes at ambient temperature, *Food Struct.* 9: 151 (1990).
71. Y. Tanaka, Encapsulated food stuffs and process for the production of same, British patent 1,489,539 (1977).
72. C. Hoashi, Food product with capsules containing meat soup or juice, U.S. patent 4,844,918 (1989).
73. R. L. Whistler and J. N. BeMiller, *Industrial Gums, Polysaccharides and Their Derivatives*, 2nd Ed., Academic Press, New York, NY, 1973.
74. F. Thevenet, Acacia gums: Stabilizers for flavor encapsulation, *Flavor Encapsulation* (S. J. Risch and G. A. Reineccius, eds.), ACS Symposium Series No. 370, American Chemical Society, Washington, DC, 1988, p. 37.
75. F. Thevenet, Acacia gums: Natural encapsulation agent for food ingredients, *Encapsulation and Controlled Release of Food Ingredients* (S. J. Risch and G. A. Reineccius, eds.), ACS Symposium Series No. 590, American Chemical Society, Washington, DC, 1995, p. 51.
76. M. Rosenberg and I. J. Kopelman, Microencapsulation of food ingredients—Process, application and potential, Proceedings of the 6th International Congress of Food Science and Technology, 1983, p. 142.
77. B. R. Bhandari, E. D. Dumoulin, H. M. J. Richard, I. Noleau, and A. M. Lebert, Flavor encapsulation by spray drying: Application to citral and linalyl acetate, *J. Food Sci.* 57: 217 (1992).
78. T. H. Schultz, J. C. Miers, and W. D. Maclay, Permeability of pectinate films to water vapor, *J. Phys. Colloid Chem.* 53: 1320 (1949).
79. S. L. Kamper and O. Fennema, Water vapor permeability of edible bilayer films, *J. Food Sci.* 49: 1478 (1984).
80. S. L. Kamper and O. Fennema, Water vapor permeability of an edible, fatty acid, bilayer film, *J. Food Sci.* 49: 1482 (1984).
81. Food and Drug Administration, United States of America, *Fed. Reg.* 45 (1980).
82. A. P. Tulloch, The composition of beeswax and other waxes secreted by insects, *Lipids* 5: 247 (1970).
83. A. P. Tulloch and L. L. Hoffman, Canadian beeswax: Analytical values and composition of hydrocarbons, free acids, and long-chain esters, *J. Am. Oil Chem. Soc.* 49: 696 (1972).
84. N. V. Lovergren and R. O. Feuge, Permeability of acetostearin products to water vapor, *J. Agric. Food Chem.* 2: 558 (1954).
85. H.-D. Belitz and W. Grosch, *Lipids*, Food Chemistry, Springer, Berlin, 1987, p. 128.

86. K. Koide and M. Karel, Encapsulation and stimulated release of enzymes using lecithin vesicles, *Int. J. Food Sci. Technol.* 22: 707 (1987).
87. M. Matsuzaki, F. McCafferty, and M. Karel, The effect of cholesterol content of phospholipid vesicles on the encapsulation and acid resistance of  $\beta$ -galactosidase from *E. coli*, *Int. J. Food Sci. Technol.* 24: 451 (1989).
88. W. F. Hopkins and T. J. Carroll, Encapsulated active ingredients, process for preparing them and their use in ingested products, European patent application EP 0,252,374 A1 (1988).
89. H. H. Hatanaka, Egg lecithin process, U.S. patent 4,844,926 (1989).
90. H. Chen, J. Weiss, and F. Shahidi, Nanotechnology in nutraceuticals and functional foods, *Food Technol.* 60(3): 30 (2006).
91. H.-H. Y. Kim and I. C. Baianu, Novel liposome microencapsulation techniques for food applications, *Trends Food Sci. Technol.* 2: 55 (1991).
92. G. Gregoriadis, Encapsulation of enzymes and other agents in liposomes, *Chemical Aspects in Food Enzymes* (A. J. Andrews, ed.), The Royal Society of Chemistry, London, 1987, p. 94.
93. T. M. Taylor, P. M. Davidson, B. D. Bruce, and J. Weiss, Liposomal nanocapsules in food science and agriculture, *Crit. Rev. Food Sci. Nutr.* 45: 587 (2005).
94. S. Gaysinsky, P. M. Davidson, B. D. Bruce, and J. Weiss, Stability and antimicrobial efficiency of eugenol encapsulated in surfactant micelles as affected by temperature and pH, *J. Food Protect.* 68: 1359 (2005).
95. L. M. Were, B. D. Bruce, P. M. Davidson, and J. Weiss, Size, stability, and entrapment efficiency of phospholipid nanocapsules containing polypeptide antimicrobials, *J. Agric. Food Chem.* 51: 8073 (2003).
96. F. Szoka and D. Papahadjopoulos, Comparative properties and methods of preparation of lipid vesicles (liposomes), *Annu. Rev. Biophys. Bioeng.* 9: 467 (1980).
97. D. W. Deamer and P. S. Uster, Liposome preparation: Methods and mechanisms, *Liposomes* (M. J. Ostro, ed.), Marcel Dekker, Inc., New York, NY, 1983, p. 27.
98. A. D. Bangham, M. W. Hill, and N. G. Miller, Preparation and use of liposomes as models of biological membranes, *Methods Memb. Biol.* 1: 1 (1974).
99. M. R. Niesman, Liposome encapsulated manganese chloride as liver specific contrast agent for magnetic resonance imaging, *Diss. Abstr. Int. B* 49: 3555 (1989).
100. S. A. Hogan, B. F. McNamee, E. D. O'Riordan, and M. O'Sullivan, Microencapsulating properties of whey protein concentrate 75, *J. Food Sci.* 66: 675 (2001).
101. A. Kondo, Microencapsulation utilizing phase separation from an aqueous solution system, *Microcapsule Processing and Technology* (J. Wade van Valkenburg, ed.), Marcel Dekker, Inc., New York, NY, 1979, p. 70.
102. W. N. Garrett, Y. T. Yang, W. L. Dunkley, and L. M. Smith, Energy utilization, feed-lot performance and fatty acid composition of beef steers fed protein encapsulated tallow or vegetable oils, *J. Animal Sci.* 42: 1522 (1976).
103. F. Ono, New encapsulation technique with protein-carbohydrate matrix, *J. Jap. Food Sci. Technol.* 27: 529 (1980).
104. F. Ono and Y. Aoyama, Encapsulation and stabilization of oily substances by protein and carbohydrate, *J. Jap. Food Sci. Technol.* 26: 13 (1979).
105. J. Uhlemann, B. Schleifenbaum, and H.-J. Bertram, Flavor encapsulation technologies: An overview including recent developments, *Perfum. Flavor.* 27(5): 52 (2002).
106. A. H. Taylor, Encapsulation systems and their applications in the flavor industry, *Food Flav. Ingrid. Packg. Proc.* 5(9): 48 (1983).
107. H. B. Heath, The flavor trap, *Food Flav. Ingrid. Packg. Proc.* 7(2): 21 (1985).
108. M. Meyers, High performance encapsulation (HPE). Applications in meat processing technology, *Agro-Food-Industry Hi-Tech* (September/October): 23 (1995).
109. N. H. Mermelstein, Spray drying, *J. Food Technol.* 55(4): 92 (2001).
110. D. Blenford, Fully protected, *Food Flav. Ingrid. Packg. Proc.* 8(7): 43 (1986).
111. W. E. Bangs, Development and characterization of wall materials for spray dried flavorings production, *Diss. Abstr. Int. B* 46(4): 1011 (1985).
112. P. J. A. M. Kerkhoff and H. A. C. Thijssen, Retention of aroma components in extractive drying of aqueous carbohydrate solutions, *J. Food Technol.* 9: 415 (1974).
113. P. J. A. M. Kerkhoff and H. A. C. Thijssen, The effect of process conditions on aroma retention in drying liquid foods, *Aroma Research*, Proceedings of the International Symposium, Wageningen Centre for Agricultural Publishing and Documentation, Wageningen, The Netherlands, 1975, p. 26.

114. L. C. Menting, B. Hoogstad, and H. A. C. Thijssen, Aroma retention during the drying of liquid foods, *J. Food Technol.* 5: 127 (1970).
115. J. L. Bomben, B. Bruin, H. A. C. Thijssen, and R. L. Merson, Aroma recovery and retention in concentration and drying of foods, *Adv. Food Res.* 20: 1 (1973).
116. G. A. Reineccius and W. E. Bangs, Spray drying of food flavors: III. Optimum infeed concentrations for the retention of artificial flavors, *Perf. Flav.* 10(1): 27 (1985).
117. M. M. Leahy, S. Anandaraman, W. E. Bangs, and G. A. Reineccius, Spray drying of food flavors: II. A comparison of encapsulating agents for the drying of artificial flavor, *Perf. Flav.* 8(5): 49 (1983).
118. J. Brenner, G. H. Henderson, and R. W. Bergensten, Process of encapsulating an oil and product produced thereby, U.S. patent 3,971,852 (1976).
119. R. Emberger, Aspects of the development of industrial flavor materials, *Flavour '81, Weurman Symposium* (P. de Gruyter Schreier, ed.), Berlin, 1981, p. 620.
120. S. J. Risch and G. A. Reineccius, Spray-dried orange oil: Effect of emulsion size on flavor retention and shelf stability, *Flavor Encapsulation* (S. J. Risch and G. A. Reineccius, eds.), ACS Symposium Series No. 370, American Chemical Society, Washington, DC, 1988, p. 67.
121. Y. I. Chang, J. Scire, and B. Jacobs, Effect of particle size and microstructure properties on encapsulated orange oil, *Flavor Encapsulation* (S. J. Risch and G. A. Reineccius, eds.), ACS Symposium Series No. 370, American Chemical Society, Washington, DC, 1988, p. 87.
122. D. M. Jones, Controlling particle size and release properties: Secondary processing techniques, *Flavor Encapsulation* (S. J. Risch and G. A. Reineccius, eds.), ACS Symposium Series No. 370, American Chemical Society, Washington, DC, 1988, p. 158.
123. J. Brenner, The essence of spray-dried flavors: The state of the art, *Perf. Flav.* 8(20): 40 (1983).
124. L. Y. Sheen and S. T. Tsai, Studies on spray-dried microcapsules of ginger, basil and garlic essential oils, *J. Chinese Agric. Chem. Soc.* 29: 226 (1991).
125. J. A. Bakan and J. L. Anderson, Microencapsulation, *The Theory and Practice of Industrial Pharmacy* (L. Lachman, H. A. Lieberman, and J. L. Kang, eds.), Lea and Febiger, Philadelphia, PA, 1970, p. 384.
126. R. Lamb, Spray chilling, *Food Flav. Ingrid. Packg. Proc.* 9(12): 39 (1987).
127. K. Dewettinck and A. Huyghebaert, Fluidized bed coating in food technology, *Trends Food Sci. Technol.* 10: 163 (1999).
128. T. H. Schultz, K. P. Dimick, and B. Makower, Incorporation of natural fruit flavors into fruit juice powders. I. Locking of citrus oils in sucrose and dextrose, *Food Technol.* 10(1): 57 (1956).
129. H. E. Swisher, Solid flavoring composition and method of preparing the same, U.S. patent 2,809,895 (1957).
130. H. E. Swisher, Solid essential oil flavoring composition and process for preparing the same, U.S. patent 3,041,180 (1962).
131. E. E. Beck, Essential oil composition and method of preparing the same, U.S. patent 3,704,137 (1972).
132. J. M. Barnes and J. A. Steinke, Encapsulation matrix composition and encapsulate containing same, U.S. patent 4,689,235 (1987).
133. D. H. Miller and J. R. Mutka, Process for forming solid juice composition and product of the process, U.S. patent 4,499,112 (1985).
134. D. H. Miller and J. R. Mutka, Preparation of solid essential oil flavor composition, U.S. patent 4,610,890 (1986).
135. W. Schlameus, Centrifugal extrusion encapsulation, *Encapsulation and Controlled Release of Food Ingredients* (S. J. Risch and G. A. Reineccius, eds.), ACS Symposium Series No. 590, American Chemical Society, Washington, DC, 1995, p. 96.
136. E. L. Anderson, W. W. Harlowe, L. M. Adams, and M. C. Marshall, Process and apparatus for the production and collection of microcapsules, European patent application EP 152,285 (1985).
137. I. J. Kopelman, S. Meydav, and P. Wilmersdorf, Freeze drying encapsulation of water-soluble citrus aroma, *J. Food Technol.* 12: 65 (1977).
138. I. J. Kopelman, D. J. Mangold, and S. Weinberg, Storage studies of freeze-dried lemon crystals, *J. Food Technol.* 12: 403 (1977).
139. C. J. Kirby and G. Gregoriadis, A simple procedure for preparing liposomes capable of high encapsulation efficiency under mild conditions, *Liposome Technology*, Vol. I (G. Gregoriadis, ed.), CRC Press, Boca Raton, FL, 1984, p. 19.
140. W. H. Rulkens and H. A. C. Thijssen, Retention volatile compounds in freeze-drying slabs of maltodextrin, *J. Food Technol.* 7: 79 (1972).



141. J. Flink and M. Karel, Retention of organic volatiles in freeze-dried solution of carbohydrates, *J. Agric. Food Chem.* 18: 295 (1970).
142. N. Yan and Y. Jin, Microcapsules having multiple shells and method for the preparation thereof, U.S. patent application US 2005/0067726 A1 (2005).
143. J. D. Dziezak, Microencapsulation and encapsulated ingredients, *Food Technol.* 42(4): 136 (1988).
144. L. A. Luzzi and R. J. Gerraughty, Effects of selected variables on the extractability of oils from coacervate capsules, *J. Phar. Sci.* 53: 429 (1964).
145. G. R. Chilvers, A. P. Gunning, and V. J. Morris, Coacervation of gelatin-XM6 mixtures and their use in microencapsulation, *Carbohydrate Polym.* 8: 55 (1988).
146. J. C. Soper, Utilization of coacervated flavours, *Encapsulation and Controlled Release of Food Ingredients* (S. J. Risch and G. A. Reineccius, eds.), ACS Symposium Series No. 590, American Chemical Society, Washington, DC, 1995, p. 104.
147. L. L. Balssa, Encapsulation of aromas and flavors, U.S. patent 3,495,988 (1970).
148. C. Arneodo, A. Baszkin, J.-P. Benoit, and C. Thies, Interfacial tension behavior of citrus oils against phases formed by complex coacervation of gelatin, *Flavor Encapsulation* (S. J. Risch and G. A. Reineccius, eds.), ACS Symposium Series No. 370, American Chemical Society, Washington, DC, 1988, p. 132.
149. A. H. King, Flavor encapsulation with alginates, *Flavor Encapsulation* (S. J. Risch and G. A. Reineccius, eds.), ACS Symposium Series No. 370, American Chemical Society, Washington, DC, 1988, p. 122.
150. D. S. Siscovick, T. E. Raghunathan, I. King, S. Weinmann, K. G. Wicklund, J. Albright, V. Bovbjerg, P. Arbogast, H. Smith, and L. H. Kushi, Dietary intake and cell membrane levels of long-chain n-3 polyunsaturated fatty acids and the risk of primary cardiac arrest, *JAMA* 274: 1363 (1995).
151. R. E. Sparks and N. S. Mason, Method for coating particles or liquid droplets, U.S. Patent 4,675,140 (1987).
152. R. E. Sparks, N. S. Mason, P. Autant, A. Cartillier, and R. Pigeon, Composition for feeding ruminants, U.S. patent 5,186,937 (1993).
153. R. E. Sparks, I. C. Jacobs, and N. S. Mason, Centrifugal suspension-separation for coating food ingredients, *Encapsulation and Controlled Release of Food Ingredients* (S. J. Risch and G. A. Reineccius, eds.), ACS Symposium Series No. 590, American Chemical Society, Washington, DC, 1995, p. 87.
154. A. Awad and A. C. Chen, A new generation of sucrose products made by cocrystallization, *Food Technol.* 47(1): 146 (1993).
155. J. W. Mullin, ed., Crystallisation kinetics, *Crystallisation*, Butterworth & Co. Ltd, London, 1972, p. 174.
156. A. B. Rizzuto, A. C. Chen, and M. F. Veiga, Modification of the sucrose crystal structure to enhance pharmaceutical properties of excipient and drug substances, *Pharm. Technol.* 8(9): 32 (1984).
157. G. A. Reineccius, Liposomes for controlled release in the food industry, *Encapsulation and Controlled Release of Food Ingredients* (S. J. Risch and G. A. Reineccius, eds.), ACS Symposium Series No. 590, American Chemical Society, Washington, DC, 1995, p. 113.
158. D. Chapman, R. M. Williams, and B. D. Ladbrook, Physical studies of phospholipids: VI. Thermotropic and lyotropic mesomorphism of some 1,2-diacylphosphatidylcholines (lecithin), *Chem. Phys. Lipids* 1: 445 (1967).
159. E. Mayhew, S. Conroy, J. King, R. Lazo, G. Nikolopoulos, A. Siciliano, and W. J. Vail, High-pressure continuous-flow system for drug entrapment in liposomes, *Drug and Enzyme Targeting*, Part B (R. Green and K. J. Widder, eds.), Academic Press, Inc., New York, NY, 1987, p. 64.
160. E. Mayhew, R. Lazo, W. J. Vail, J. King, and A. M. Green, Characterization of liposomes prepared using a microemulsifier, *Biochem. Biophys. Acta* 755: 169 (1984).
161. A. Kondo, Microencapsulation by interfacial polymerization, *Microcapsule Processing and Technology* (J. Wade van Valkenburg, ed.), Marcel Dekker, Inc., New York, NY, 1979, p. 35.
162. J. S. Patington, Molecular encapsulation with  $\beta$ -cyclodextrin, *Food Flav. Ingrid. Packg. Proc.* 7(9): 51 (1985).
163. P. E. Shaw, J. H. Tatum, and C. W. Wilson, Improved flavor of Navel orange and grapefruit juices by removal of bitter components with  $\beta$ -cyclodextrin polymer, *J. Agric. Food Chem.* 32: 832 (1984).
164. L. L. Westing, G. A. Reineccius, and F. Caporaso, Shelf life of orange oil: Effects of encapsulation by spray-drying, extrusion, and molecular inclusion, *Flavor Encapsulation* (S. J. Risch and G. A. Reineccius, eds.), ACS Symposium Series No. 370, American Chemical Society, Washington, DC, 1988, p. 110.
165. K. Lindner, L. Szente, and J. Szejtli, Food flavoring with  $\beta$ -cyclodextrin-complexed flavor substances, *Acta Aliment.* 10: 175 (1981).

166. L. Szente and J. Szejtli, Stabilization of flavors by cyclodextrins, *Flavor Encapsulation* (S. J. Risch and G. A. Reineccius, eds.), ACS Symposium Series No. 370, American Chemical Society, Washington, DC, 1988, p. 148.
167. L. Szente, M. Gal-Fuzy, and J. Szejtli, Tea aromatization with  $\beta$ -cyclodextrin complexed flavors, *Acta Aliment.* 17: 193 (1988).
168. Y. E. Shapiro, Nanoencapsulation of bioactive substances, *Dekker Encyclopedia of Nanoscience and Nanotechnology* (J. A. Schwarz, C. I. Contescu, and K. Putyera, eds.), Marcel Dekker, New York, NY, 2004, p. 2339.
169. F. LaBell, Energy drinks with electrifying flavor—Research efforts of Forbitech Inc. in developing vitamin-fortified juice drinks, *Prep. Foods* 171(7): 28 (1999).
170. L. E. Werner, Encapsulated food acids, *Cereal Foods World* 25(3): 102 (1980).
171. W. E. Delaney, Meat color stabilization, U.S. patent 3,560,222 (1971).
172. J. C. Cordray and D. L. Huffman, Restructured pork from hot processed sow meat: Effect of encapsulated food acids, *J. Food Prot.* 48: 965 (1985).
173. P. J. Percel and D. W. Perkins, Process of preparing a particulate food acidulant, U.S. patent 4,537,784 (1985).
174. K. V. Lukasik, Microencapsulating baked goods, *Functional Foods & Nutraceuticals* (May): 36 (2006).
175. Anon., Specially coated natural ingredient improves bread, *Food Proc.* 34(1): 10 (1973).
176. J. T. Seighman, Process for encapsulating liquid acids and product, U.S. patent 4,713,251 (1987).
177. W. M. McKernan, Microencapsulation in the flavor industry. I, *Flav. Industry* 3: 596 (1972).
178. W. M. McKernan, Microencapsulation in the flavor industry. II, *Flav. Industry* 4: 70 (1973).
179. S. Anandaraman and G. A. Reineccius, Microencapsulation of flavor, *Food Flav. Ingrid. Packg. Proc.* 1(9): 14 (1980).
180. U. Marquardt, Spices, flavors and aromas, *Eur. Food Drink Rev.* (Autumn): 101 (1990).
181. L. S. Jackson and K. Lee, Microencapsulation and the food industry, *Lebens. Wiss. Technol.* 24: 289 (1991).
182. J. R. Bedford and D. R. Ashworth, Encapsulated flavors—Their applications and development, *Food Flav. Ingrid. Packg. Proc.* 5(2): 13 (1983).
183. R. A. Youngs, Spray drying encapsulation—Today's review, *Food Flav. Ingrid. Packg. Proc.* 8(10): 31 (1986).
184. W. E. Bangs and G. A. Reineccius, Characterization of selected materials for lemon oil encapsulation by spray drying, *J. Food Sci.* 55: 1356 (1990).
185. C. I. Beristain, A. Vazquez, H. S. Garcia, and E. J. Vernon-Carter, Encapsulation of orange peel oil by co-crystallization, *Lebens. Wiss. Technol.* 29: 645 (1996).
186. E. L. Magee, Microencapsulation of cheese ripening systems in milk fat, *Diss. Abstr. Int. B* 40: 2103 (1979).
187. E. L. Magee and N. F. Olson, Microencapsulation of cheese ripening systems: Production of diacetyl and acetyl in cheese by encapsulated bacterial cell-free extract, *J. Dairy Sci.* 64: 616 (1981).
188. S. D. Braun, N. F. Olson, and R. C. Lindsay, Microencapsulation of bacterial cell-free extract to produce acetic acid for enhancement of cheese flavor, *J. Food Sci.* 47: 1803 (1982).
189. S. D. Braun and N. F. Olson, Encapsulation of proteins and peptides in milk fat: Encapsulation efficiency and temperature and freezing stabilities, *J. Microencap.* 3(2): 115 (1986).
190. C. J. Kirby and B. A. Law, Development in the microencapsulation of enzymes in food technology, *Chemical Aspects of Food Enzymes* (A. T. Andrews, ed.), The Royal Society of Chemistry, London, 1987, p. 106.
191. C. J. Kirby and B. A. Law, Recent development in cheese flavor technology: Application of enzyme microencapsulation, *Biotechnology in the Food Industry*, Proceedings of the Conference, Online International Ltd., London, 1986, p. 17.
192. Anon., Food additives: Microcapsules for flavoring oils, *Fed. Reg.* 33 (232, Nov. 28): 17752 (1968).
193. Anon., Food additives: Microcapsules for flavoring oils, *Fed. Reg.* 33 (242, Dec. 13): 18488 (1968).
194. L. L. Balssa and J. Brody, Microencapsulation—The balchem way, *Food Eng.* 40(11): 88 (1968).
195. E. R. Jensen, Encapsulated flavors, Canadian patent 866,713 (1971).
196. Anon., Microencapsulation extends shelf life of marginally stable ingredients, *Food Proc.* 42(7): 40 (1981).
197. Anon., Lemon flavor for fish survives frying, baking, *Food Proc.* 31(5): 24 (1970).
198. E. Palmer, Method for encapsulating materials, U.S. patent 3,989,852 (1976).

199. W. Abe, Y. Yamamoto, R. Uehara, K. Ogiwara, and T. Satoh, Studies on feeding encapsulated safflower oil to milking cows and fattening steers, *Jap. J. Zootechnol. Sci.* 47: 639 (1976).
200. Bush Boake Allen Ltd., Encapsulated flavors, British patent 1,327,761 (1973).
201. R. T. Darragh and J. L. Stone, Fats with encapsulated flavors, U.S. patent 3,867,556 (1975).
202. C. Andres, Encapsulated concentrates retain full-flavor profile balance, *Food Proc.* 42(12): 57 (1981).
203. Anon., How the flavor is sealed, *Food Proc. Ind.* 50(600): 36 (1981).
204. J. Tuot, Foamed capsules having edible shells enclosing aromatic components, UK patent application GB 2,144,701 A (1985).
205. R. T. Liu, W. R. Nickerson, and C. H. Anderson, Process for the preparation of flavorant capsules, U.S. patent 4,576,826 (1986).
206. J. Szejtli, L. Szente, and E. Banky-Elod, Molecular encapsulation of volatile, easily oxidizable labile flavor substances by cyclodextrins, *Acta Chim. Acad. Sci. Hung.* 101(1/2): 27 (1979).
207. R. S. Johnson, Encapsulation of volatile liquids, European patent 0.070,719 B1 (1985).
208. M. Glass, Sorbitol containing mixture encapsulated flavor, U.S. patent 4,388,328 (1983).
209. C. Andres, Unique encapsulation flavors maximize flavor/aromas—Instantly release oils of mustard, onion, spices, *Food Proc.* 33(5): 23 (1972).
210. Y. C. Wei, S. R. Cherukuri, F. Hriscisce, D. J. Piccolo, and K. P. Bilka, Elastomer encapsulation of flavors and sweeteners, long lasting flavored chewing gum compositions based thereon and process of preparation, U.S. patent 4,590,075 (1986).
211. R. K. Yang, Encapsulation composition for use with chewing gum and edible products, European patent application EP 0,229,000 A2 (1986).
212. J. Szejtli, L. Szente, and L. Szenta, Method for aromatizing tea, and the aromatizing product, Swiss patent CH 656,778 A (1986).
213. L. Szente and J. Szejtli, Molecular encapsulation of natural and synthetic coffee flavor with  $\beta$ -cyclodextrin, *J. Food Sci.* 51: 1024 (1986).
214. Anon., Heat glaze coating encapsulates flavor, *Food Proc.* 30(6): 32 (1969).
215. S. D. Braun, N. F. Olson, and R. C. Lindsay, Production of flavor compounds: Aldehydes and alcohols from leucine by microencapsulated cell-free extracts of *Streptococcus lactis* var. multigenes, *J. Food Biochem.* 7: 23 (1983).
216. H. Levine, L. Slade, B. Van Lengerich, and J. G. Pickup, Double-encapsulated compositions containing volatile and/or labile components, and processes for preparation and use thereof, U.S. patent 5,087,461 (1992).
217. T. Cea, J. D. Posta, and M. Glass, Encapsulated APM and method of preparation, U.S. patent 4,384,004 (1983).
218. T. Cea, J. D. Posta, and M. Glass, A chewing gum composition incorporating encapsulated L-aspartyl-L-phenylalanine methyl ester, European patent EP 0,067,595 B1 (1987).
219. A. M. Schobel and R. K. Yang, Encapsulated sweetener composition for use with chewing gum and edible products, U.S. patent 4,824,681 (1989).
220. R. K. Yang and A. M. Schobel, Chewing gum composition with encapsulated sweetener having extended flavor release, U.S. patent 4,911,934 (1990).
221. S. R. Cherukuri and G. Mansukhani, Sweetener delivery systems containing polyvinyl acetate, U.S. patent 4,816,265 (1989).
222. S. R. Cherukuri and G. Mansukhani, Multiple encapsulated sweetener delivery system, U.S. patent 4,933,190 (1990).
223. S. R. Cherukuri, G. Mansukhani, and K. C. Jacob, Stable sweetener delivery system for use with cinnamon flavors, U.S. patent 4,839,184 (1989).
224. A. C. C. Chen, A. B. Rizzuto, and M. F. Veiga, Cocrystallized sugar-nut product, U.S. patent 4,423,085 (1983).
225. A. C. C. Chen, S. J. Drescher, and C. P. Graham, Maple sugar product and method of preparing and using same, U.S. patent 4,159,210 (1979).
226. J. W. Kinnison and R. S. Chapman, Extrusion effects on colors and flavors, *Snack Food* 61(10): 40 (1972).
227. F. Ono, Solubilization of fats and oils by solid components of soy sauce: X. Encapsulation and stabilization of oil-soluble pigment in a protein-carbohydrate matrix, *J. Jap. Food Sci. Technol.* 26: 346 (1979).
228. P. Ciliberto and S. Kramer, Non-caking, water-soluble, granular coated food ingredient, U.S. patent 4,288,460 (1981).

229. F. Shahidi and R. B. Pegg, Encapsulation of the preformed cooked cured-meat pigment, *J. Food Sci.* 56: 1500 (1991).
230. J. Bitman, T. R. Wrenn, L. P. Dryden, and L. F. Edmondson, Feeding encapsulated vegetable fats to increase the polyunsaturation of milk, cheese, and meat, XIX International Dairy Congress, IE, 1974, p. 107.
231. L. F. Edmondson, R. A. Yoncoskie, N. H. Rainey, F. W. Douglas, and J. Bitman, Feeding encapsulated oils to increase the polyunsaturation in milk and meat fat, *J. Am. Oil Chem. Soc.* 51(3): 72 (1974).
232. V. F. Kristensen, Influence on the fatty acid composition of milk fat on feeding dairy cows increasing amounts of encapsulated soybean oil, XIX International Dairy Congress, 1E, 1974, p. 109.
233. Encapsulated ingredients, *Food Technol.* 42(4): 158 (1988).
234. A. P. Simopoulos, Omega-3 fatty acids in health and disease and growth and development. A review, *Am. J. Clin. Nutr.* 54: 438 (1991).
235. A. P. Simopoulos, Fatty acids, *Functional Foods: Designer Foods, Pharmafoods, Nutraceuticals* (I. Goldberg, ed.), Chapman & Hall, Glasgow, 1994, p. 355.
236. L. M. Branden and K. K. Carroll, Dietary polyunsaturated fats in relation to mammary carcinogenesis in rats, *Lipids* 21: 285 (1986).
237. J. Dyberg, Linolenate-derived polyunsaturated fatty acids and prevention of atherosclerosis, *J. Nutr. Rev.* 44: 125 (1986).
238. J. Mehta, L. M. Lopez, D. Lowton, and T. Wargovich, Dietary supplementation with omega-3 polyunsaturated fatty acids in patients with stable coronary disease. Effects on indices of platelet and neutrophil function and exercise performance, *Am. J. Med.* 84: 45 (1988).
239. V. K. S. Shukla and E. G. Perkins, The presence of oxidative polymeric materials in encapsulated fish oils, *Lipids* 26: 23 (1991).
240. F. Gejl-Hansen and J. M. Flink, Freeze-dried carbohydrate containing oil-in-water emulsions: Microstructure and fat distribution, *J. Food Sci.* 42: 1049 (1977).
241. K. Taguchi, K. Iwami, F. Ibuki, and M. Kawabata, Oxidative stability of sardine oil embedded in spray-dried egg white powder and its use in n-3 unsaturated fatty acid fortification of cookies, *Biosci. Biotech. Biochem.* 56: 560 (1992).
242. K. Iwami, M. Hattori, S. Nakatani, and F. Ibuki, Spray-dried gliadin powders inclusive of linoleic acid (microcapsules): Their preservability, digestibility and application to bread making, *Agric. Biol. Chem.* 51: 3301 (1987).
243. F. Shahidi and U. N. Wanasundara, Oxidative stability of encapsulated seal blubber oil, *Flavor Technology—Physical Chemistry, Modification, and Process* (C.-T. Ho, C.-T. Tan, and C.-H. Tong, eds.), ACS Symposium Series 610, American Chemical Society, Washington, DC, 1995, p. 139.
244. Hoffmann-La Roche, Inc., Vitamins, Part II: General considerations, *Encyclopedia of Food Science and Technology* (Y. H. Hui, ed.), Wiley, New York, NY, 1992, p. 2687.
245. J. Giese, Vitamin and mineral fortification of foods, *Food Technol.* 49(5): 110 (1995).
246. H. S. Hall and R. E. Pondell, Encapsulation of vitamin and mineral nutrients, U.S. patent 4,182,778 (1980).
247. C. Andres, Fat matrix encapsulation controls ingredients release-reactions are temperature-specific, *Food Proc.* 37(5): 72 (1976).
248. J. Eden, R. Trksak, and R. Williams, Starch-based particulate encapsulation process, U.S. patent 4,755,397 (1988).
249. L. D. Morse, P. A. Hammes, and W. A. Boyd, Devil's food cake and other alkaline bakery goods, U.S. patent 3,821,422 (1974).
250. P. T. Berglund, J. W. Dick, and M. L. Dreher, Effect of form of enrichment and iron on thiamin, riboflavin and niacinamide, and cooking parameters of enriched spaghetti, *J. Food Sci.* 52: 1376 (1987).
251. J. M. deMan, L. deMan, and T. Wygerde, Stability of vitamin A beadlets in nonfat dry milk, *Milchwissenschaft* 41: 468 (1986).
252. A. Markus and A. Pelah, Encapsulation of vitamin A, *J. Microencap.* 6: 389 (1989).
253. C. Andres, Fat matrix encapsulation controls ingredients release-reactions are temperature-specific, *Food Proc.* 37(1): 72 (1976).
254. S. S. Jakel and F. Belshaw, Encapsulated ferrous sulphate protects baking mixes, flour from rancid flavors, *Food Proc.* 32(5): 28 (1974).
255. B. N. Harrison, G. W. Pla, G. A. Clark, and J. C. Fritz, Selection of iron sources for cereal enrichment, *Cereal Chem.* 53(1): 78 (1976).
256. K. Weingartner, A. Nelson, and J. Erdman, Effect of calcium addition on stability and sensory properties of soy beverages, *J. Food Sci.* 48: 256 (1983).

257. M. Hirotsuka, H. Taniguchi, H. Narita, and M. Kito, Calcium fortification of soymilk with calcium-lecithin liposome system, *J. Food Sci.* 49: 111 (1984).
258. H. W. Schafer, Increasing the recovery of milk proteins in cheese made by direct acidification and encapsulation of enzymes for acceleration of cheese ripening, *Diss. Abst. Int. B* 36: 1127 (1975).
259. S. D. Braun, Microencapsulated multi-enzymes to produce flavors and recycle cofactors, *Diss. Abstr. Int. B* 46: 366 (1985).
260. C. J. Kirby, B. E. Brooker, and B. A. Law, Accelerated ripening of cheese using liposome-encapsulated enzyme, *Int. J. Food Sci. Technol.* 22: 355 (1987).
261. B. Law and C. Kirby, Microencapsulated enzymes for cheese technology, *North Eur. Food Dairy J.* 53(6): 194 (1987).
262. M. El-Soda, L. Pannell, and N. Olson, Microencapsulated enzyme systems for the acceleration of cheese ripening, *J. Microencap.* 6: 319 (1989).
263. S. C. Kim and N. F. Olson, Production of methanethiol in milk fat-coated microcapsules containing *Brevibacterium linens* and methionine, *J. Dairy Res.* 56: 799 (1989).
264. K. Kailasapathy and S. H. Liam, Application of encapsulated enzymes to accelerate cheese ripening, *Int. Dairy J.* 15: 929 (2005).
265. F. P. Colten, J. J. Halik, R. J. Ravallo, J. L. Hegadorn, and R. B. Hynson, Gasified candy enrobed with oleaginous material, U.S. patent 4,275,083 (1981).
266. M. Iso, T. Shirahase, S. Hanamura, S. Urushiyama, and S. Omi, Immobilization of enzyme by microencapsulation and application of the encapsulated enzyme in the catalysis, *J. Microencap.* 6: 165 (1989).
267. I. Garcia, R. B. Aisina, O. Ancheta, and C. Pascual, Action of gastric juice on microencapsulated invertase, *Enzyme Microb. Technol.* 11: 247 (1989).
268. J. Mansfeld, A. Foerster, A. Schellenberger, and H. Dautzenberg, Immobilization of invertase by encapsulation in polyelectrolyte complexes, *Enzyme Microb. Technol.* 13: 240 (1991).
269. FAO/WHO, Evaluation of health and nutritional properties of powder milk with live lactic acid bacteria, Report from FAO/WHO Expert Consultation, Cordoba, Argentina 2001.
270. C. Dunne, L. O'Mahony, L. Murphy, G. Thornton, D. Morrissey, S. O'Halloran, M. Feeney, S. Flynn, G. Fitzgerald, C. Daly, B. Kiely, G. C. O'Sullivan, F. Shanahan, and J. K. Collins, In vitro selection criteria for probiotic bacteria of human origin: correlation with in vivo findings, *Am. J. Clin. Nutr.* 73: 386S (2001).
271. R. P. Ross, C. Desmond, G. F. Fitzgerald, and C. Stanton, Overcoming the technological hurdles in the development of probiotic foods, *J. Appl. Microbiol.* 98: 1410 (2005).
272. J. M. Saavedra, N. A. Bauman, I. Oung, J. A. Perman, and R. H. Yolken, Feeding of *Bifidobacterium bifidum* and *Streptococcus thermophilus* to infants in hospital for prevention of diarrhoea and shedding of rotavirus, *Lancet*, 344: 1046 (1994).
273. C. Stanton, C. Desmond, M. Coakley, J. K. Collins, G. Fitzgerald, and R. P. Ross, Challenges facing development of probiotic-containing functional foods, *Handbook of Fermented Functional Foods* (E. R. Farnworth, ed.), CRC Press, Boca Raton, FL, 2003, p. 27.
274. C. Stanton, C. Desmond, G. Fitzgerald, and R. P. Ross, Probiotic health benefits—Reality or myth? *Aust. J. Dairy Technol.* 58: 107 (2003).
275. S. Plummer, M. A. Weaver, J. C. Harris, P. Dee, and J. Hunter, *Clostridium difficile* pilot study: Effects of probiotic supplementation on the incidence of *C. difficile* diarrhoea, *Int. Microbiol.* 7: 59 (2004).
276. N. Ishibashi and S. Shimamura, Bifidobacteria: Research and development in Japan, *Food Technol.* 47: 126 (1993).
277. Y. K. Lee and S. Salminen, The coming of age of probiotics, *Trends Food Sci. Technol.* 6: 241 (1995).
278. A. Millqvist-Fureby, M. Malmsten, and B. Bergenstahl, Surface composition of spray dried milk protein-stabilised emulsions in relation to pre-heat treatment of proteins, *Colloides Surf. B Biointerfacs* 21: 47 (2000).
279. K. O. O'Riordan, D. Andrews, K. Buckle, and P. Conway, Evaluation of microencapsulation of a *Bifidobacterium* strain with starch as an approach to prolonging viability during storage, *J. Appl. Microbiol.* 91: 1059 (2001).
280. G. E. Gardiner, E. O'Sullivan, J. Kelly, M. A. E. Auty, G. F. Fitzgerald, J. K. Collins, R. P. Ross, and C. Stanton, Comparative survival rates of human-derived probiotic *Lactobacillus paracasei* and *L. salivarius* strains during heat treatment and spray drying, *Appl. Environ. Microbiol.* 66: 2605 (2000).

281. J. Silva, A. S. Carvalho, P. Teixeira, and P. A. Gibbs, Bacteriocin production by spray-dried lactic acid bacteria, *Lett. Appl. Microbiol.* 34: 77 (2002).
282. C. Desmond, R. P. Ross, E. O'Callaghan, G. Fitzgerald, and C. Stanton, Improved survival of *Lactobacillus paracasei* NFBC 338 in spray-dried powders containing gum acacia, *J. Appl. Microbiol.* 93: 1003 (2002).
283. B. M. Corcoran, R. P. Ross, G. F. Fitzgerald, and C. Stanton, Comparative survival of probiotic lactobacilli spray-dried in the presence of prebiotic substances, *J. Appl. Microbiol.* 96: 1024 (2004).
284. P. Siuta-Cruce and J. Goulet, Improving probiotic survival rates, *Food Technol.* 55(10): 36 (2001).
285. K. Kailasapathy, Microencapsulation of probiotic bacteria: Technology and potential applications, *Curr. Issues Intest. Microbiol.* 3: 39 (2002).
286. D. Guerin, J.-C. Vullemard, and M. Subirade, Protection of bifidobacteria encapsulated in polysaccharide-protein gel beads against gastric juice and bile, *J. Food Prot.* 66: 2076 (2003).
287. E. Selmer-Olsen, T. Sorhaug, S.-E. Birkeland, and R. Pehrson, Survival of *Lactobacillus helveticus* entrapped in Ca-Alginate in relation to water content, storage and rehydration, *J. Indust. Microbiol. Biotechnol.* 23: 79 (1999).
288. Taiyo Chemical Industries Co., Ltd., Encapsulated preservative, Japanese patent 5,136,334 (1976).
289. J. Rozenblat, S. Magdassi, and N. Garti, Effect of electrolytes, stirring and surfactants in the coacervation and microencapsulation (of oleic acid) process in presence of gelatin, *J. Microencap.* 6: 515 (1989).
290. D. R. Meyer, Process for preparing a coated-particle salt substitute composition, U.S. patent 4,734,290 (1988).
291. D. J. Deeble, B. J. Parsons, and G. O. Phillips, Studies on food antioxidants encapsulated in  $\beta$ -cyclodextrin, *Food and Agriculture. Agricultural Research and Development in Wales*, 6th Conference, Cardiff, UK, 1989, p. 26.
292. M. Karel and R. Langer, Controlled release of food additives, *Flavor Encapsulation* (G. A. Reineccius and S. J. Risch, eds.), ACS Symposium Series No. 370, American Chemical Society, Washington, DC, 1988, p. 177.
293. L. Brannon-Peppas, Controlled release in the food and cosmetic industries, *Polymeric Delivery Systems* (M. A. El-Nokay, D. M. Piatt, and B. A. Charpentier, eds.), ACS Symposium Series No. 520, American Chemical Society, Washington, DC, 1993, p. 42.
294. C. Whorton, Factors influencing volatile release from encapsulation matrices, *Encapsulation and Controlled Release of Food Ingredients* (S. J. Risch and G. A. Reineccius, eds.), ACS Symposium Series No. 590, American Chemical Society, Washington, DC, 1995, p. 134.
295. D. Pendergrass, The use of controlled delivery in print materials, Second Workshop on the Controlled Delivery in Consumer Products, Controlled Release Society, Secaucus, NJ, May 13–15, 1992.
296. G. A. Reineccius, Controlled release techniques in the food industry, *Encapsulation and Controlled Release of Food Ingredients* (S. J. Risch and G. A. Reineccius, eds.), ACS Symposium Series No. 590, American Chemical Society, Washington, DC, 1995, p. 8.
297. C. Mellenheim and N. Passy, Choice of packages for foods with specific considerations of water activity, *Properties of Water in Foods* (D. Simatos and J. L. Multon, eds.), Martinus Nijhoff Publishing, Dordrecht, The Netherlands, 1985, p. 375.
298. B. Pascat, Study of some factors affecting permeability, *Food Packaging and Preservation: Theory and Practice* (M. Mathlouthi, ed.), Elsevier Applied Science Publishers, London, 1986, p. 7.
299. C. A. Kumins, Transport through polymer films, *J. Polymer Sci. Part C 10*: 1 (1965).
300. P. I. Lee, Controlled release of volatile multicomponent active agents: Physical considerations, Second Workshop on the Controlled Delivery in Consumer Products, Controlled Release Society, Secaucus, NJ, May 13–15, 1992.
301. H. A. C. Thijssen and W. H. Rulkens, Retention of aromas in drying food liquids, *De Ingenieur* 80(47): 45 (1968).
302. M. Karel and J. Flink, Some recent developments in food dehydration research, *Adv. Drying* 2: 103 (1983).
303. H. Levine and L. Slade, A polymer physico-chemical approach to the study of commercial starch hydrolysis products (SHPs), *Carbohydrate Polym.* 6(3): 213 (1986).
304. N. Peppas, Diffusional release from polymeric carriers, Second Workshop on the Controlled Delivery in Consumer Products, Controlled Release Society, Secaucus, NJ, May 13–15, 1992.
305. L. Slade and H. Levine, Glass transitions and water-food structure interactions, *Advances in Food and Nutrition Research*, Vol. 38 (J. Kinsella, ed.), Academic Press, San Diego, CA, 1994.

306. E. C. To and J. M. Flink, 'Collapse', a structural transition in freeze dried carbohydrates: I. Evaluation of analytical methods, *J. Food Technol.* 13: 551 (1978).
307. M. Karel, Effects of water activity and water content on mobility of food components, and their effects on phase transitions in food systems, *Properties of Water in Foods* (D. Simatos and J. L. Multon, eds.), Martinus Nijhoff Publishing, Dordrecht, The Netherlands, 1985, p. 153.
308. C.-T. Tan, Y. C. Kang, M. A. Sudol, C. K. King, and M. Schulman, Method of making controlled release flavors, U.S. patent 5,064,669 (1991).
309. K. Yazawa, F. Arai, M. Kitajima, and A. Kondo, Method of producing oil and fat encapsulated amino acids, U.S. patent 3,804,776 (1974).

## **Part 4**

# **Preservation Using Heat and Energy**





# 23

## *Pasteurization and Food Preservation*

M. N. Ramesh

### CONTENTS

23.1	Introduction .....	571
23.2	Purpose of Pasteurization .....	572
23.3	Types of Pasteurization .....	573
23.4	Pasteurization Testing .....	573
23.5	Achieving Desired Pasteurization .....	574
23.6	Pasteurization Equipment .....	574
23.6.1	Pasteurization of Packaged Foods .....	574
23.6.1.1	Water Bath Pasteurization.....	574
23.6.1.2	Continuous Steam or Water Spray Pasteurizer .....	574
23.6.1.3	Tunnel Pasteurization .....	575
23.6.2	Pasteurization of Unpacked Liquids .....	575
23.6.2.1	Long Hold or Vat Pasteurizing .....	575
23.6.2.2	Heat Exchanger Pasteurizer .....	575
23.6.2.3	High-Temperature-Short-Time Pasteurizers .....	576
23.6.2.4	Flash Pasteurization .....	577
23.6.2.5	Ultra-High-Temperature Pasteurizers .....	578
23.6.2.6	Vacreator .....	578
23.7	Quality of Pasteurized Foods .....	578
23.8	Packaging of Pasteurized Foods .....	580
23.8.1	Returnable Bottles .....	580
23.8.2	Glass Bottles .....	580
23.8.3	PET Bottles and Other Plastic Containers.....	580
23.8.4	Cans .....	581
23.8.5	Cartons .....	581
23.9	Energy Aspects of Pasteurization .....	581
	References .....	582

### 23.1 Introduction

Pasteurization is one of the most important steps in preservation and is essential for food safety. It greatly improves the product's "keeping" quality by effectively destroying virtually all disease-producing and most other bacteria ([www.fao.org](http://www.fao.org)). Pasteurization is a process of heat treatment to inactivate enzymes and kill relatively heat-sensitive microorganisms that cause spoilage, with minimal changes in food properties, for example, sensory and nutritional properties. It is also defined as "mild heat treatment" for avoiding microbial and enzymatic spoilage. It is used to extend the shelf life of food at low temperatures, usually 4°C for several days (e.g., milk) or for several months (e.g., bottled fruit). Heating liquid foods to 100°C is employed to destroy heat-labile spoilage organisms such as nonspore-forming bacteria, yeast, and molds.

## 23.2 Purpose of Pasteurization

The primary object of pasteurization is to free the food of any microorganism that might cause deterioration or endanger the health of the consumer. The severity of the heat treatment and the resulting extension of shelf life are determined mostly by the pH of the food. In low-acid foods (pH > 4.5), the main purpose is destruction of pathogenic bacteria, whereas below pH 4.5 destruction of spoilage microorganism or enzyme inactivation is usually more important. Table 23.1 shows the different pasteurization conditions for food. Pasteurization does not aim at killing the spore-bearing organisms, such as thermophilic *Bacillus subtilis*, but these organisms and most other spore-bearing bacteria cannot grow in acidic fruit juices and consequently their presence is of no practical significance. Pasteurization of carbonated juices needs only to be conducted at such a temperature and for such a time that yeasts and molds are destroyed. Yeast is killed by heating at 60°C–65°C and the resistant mold spores, negative in most cases, are heated up to 80°C for 20 min. But molds require oxygen for growth, and for this reason heavily carbonated juice can be pasteurized safely at 65°C, which destroys yeast cells. Most still (noncarbonated) juices must be pasteurized at 80°C. Juices of high acidity may be pasteurized at lower temperatures of 60°C–65°C.

Processing containers of food that have a naturally low pH (e.g., fruit pieces) or in which the pH is artificially lowered (e.g., pickles) is similar to canning. In acidic products such as tomatoes, mangoes, and bananas (pH 4.0–4.4), yeasts, molds, and bacteria (both thermophilic and mesophilic) grow. The main risk of spoilage is from spore-forming species other than *Clostridium botulinum*, especially *B. coagulans* among the aerobes, and *C. pasteurianum* and *C. thermosaccharolyticum* among the anaerobes. In high-acid foods (pH < 3.9) such as pineapple juice, the spoilage is generally caused by nonspore-forming bacteria (*Lactobacillus* and *Leuconostoc*), yeast, or molds. Fruits with a pH lower than 4.5 contain enzyme systems such as catalase, peroxidase, polyphenol oxidase, pectin esterase, etc. in addition to spoilage organisms. Unless inactivated, these enzymes are likely to cause undesirable changes in the canned products. Some of these enzymes, particularly peroxidases, have higher heat resistance than the spoilage organisms and have been used in evaluating the thermal processing of canned fruits.

**TABLE 23.1**

Purpose of Pasteurization for Different Foods

Food	Main Purpose	Subsidiary Purpose	Minimum Processing Conditions
pH < 4.5			
Fruit juice	Enzyme inactivation (pectinesterase and polygalacturonase) (yeasts, fungi)	Destruction of spoilage microorganisms	65°C for 30 min; 77°C for 1 min; 88°C for 15 s
Beer	Destruction of spoilage microorganisms (wild yeasts, <i>Lactobacillus</i> species) and (residual yeasts, <i>Saccharomyces</i> species)	—	65°C–68°C for 20 min (in bottle); 72°C–75°C for 1–4 min at 900–1000 kPa
pH > 4.5			
Milk	Destruction of pathogens: <i>Brucella abortus</i> , <i>Mycobacterium tuberculosis</i> , <i>Coxiella burnetti</i>	Destruction of spoilage microorganisms and enzymes	63°C for 30 min; 71.5°C for 15 s
Liquid egg	Destruction of pathogens <i>Salmonella seftenburg</i>	Destruction of spoilage microorganisms	64.4°C for 2.5 min; 60°C for 3.5 min
Ice cream	Destruction of spoilage microorganisms.	Destruction of pathogens	65°C for 30 min; 71°C for 10 min; 80°C for 15 s

---

### 23.3 Types of Pasteurization

There are several types of pasteurization: (i) in-package pasteurization: inside packages, heating to sterility level is not required. A gradual change in temperature is preferred in some containers, (ii) pasteurization prior to packaging: preheating is good for foods that are sensitive to high temperature gradients, (iii) batch pasteurization: this is also called low temperature short time process. Here, fluid foods such as milk are held in a tank where they are heated to 62.8°C for 30 min. A batch pasteurizer consists of a steam jacket kettle or a tank equipped with steam coils in which juice or milk is heated to the desired temperature, and (iv) continuous pasteurization: this is also called high-temperature-short-time (HTST) process. Foods such as milk are subjected to 71.7°C for about 15 s or more by flowing through different heat exchangers. In continuous pasteurization, generally, plate heat exchangers, tubular heat exchangers, and scraped surface heat exchangers are used, depending on the viscosity of the fluid food material. The heating medium is usually steam or water.

---

### 23.4 Pasteurization Testing

Over the past 60 years, the industry has used colorimetric tests to determine proper pasteurization. This manual inspection method is based primarily on a technician's subjective interpretation of the results. In 1990, a new rapid enzymatic assay was designed to confirm pasteurization. This test involves the use of an automated instrument and a fluorometric assay. Alkaline phosphatase (ALP) is an enzyme naturally present in raw milk, which is used as an indicator for proper milk pasteurization. Nonpasteurized or raw milk contains ALP, which causes intraabdominal bacterial infection after drinking the milk, whereas after pasteurization, ALP is denatured. Therefore, milk industries test the milk after pasteurization by ALP testing wherein the instrument interprets the results instead of a technician, dramatically reducing the evaluation process from 90 to 3 min. ALP testing, unlike the colorimetric method, can be used to confirm pasteurization of many different products, including bovine, sheep, and goat milk; flavored and cultured products; and cheeses. This test is revolutionizing the way the industry checks for pasteurization. Dairy processors are enjoying higher precision and reproducibility, and a tenfold sensitivity improvement. This enhances process improvement and troubleshooting while allowing immediate process validation following maintenance. The ALP method has been accepted in Europe as a reference method and dairy producers are beginning to implement the equipment. In the United States, the test's accuracy and sensitivity resulted in the FDA lowering its pasteurization acceptance criterion from 500 to 350 mU/L of ALP activity. By lowering the criterion with better technology, plants are able to improve HACCP programs and advance the cause of food safety to protect consumers ([http://www.dairyfoods.com/CDA/ArticleInformation/features/BNP\\_Features\\_Item/0,6775,106406,00.html](http://www.dairyfoods.com/CDA/ArticleInformation/features/BNP_Features_Item/0,6775,106406,00.html)).

Biostrips have become more popular for testing different chemical and biochemical parameters. Quick, simple, and economical tests using dry-reagent strips for the detection of ALP activity in milk have also been developed [1]. It is based on ALP reaction with *p*-nitrophenyl phosphate in the presence of water to liberate *p*-nitrophenol and inorganic phosphate. *p*-Nitrophenol on reacting with a specific chromogen changes the color of the strip from light blue to green, which can be visualized by the naked eye. The strip has a sensitivity >0.5 units/L. The strip may be used in dairy industries and remote areas where expensive instruments are not available. The strip is stable for more than a year at room temperature.

Processing methods have different effects on the nutritional and sensorial qualities of juices. Thermally treated juices produced by full or flash pasteurization are still the most widely marketed products. Acidophilic microorganisms have been shown to be the major contaminants of citrus juices, especially lactic acid bacteria and yeasts [2]. The redox potential (Eh) is a physicochemical parameter that determines the oxidizing or reducing properties of the medium, and it depends on the composition of the food (thiol-containing amino acids, peptides, proteins, and reducing sugars), pH, temperature, and, for a large part, concentration of the dissolved oxygen [3]. This parameter plays an important role in the cellular physiology of microorganisms, such as growth capacity [4,5], enzyme expression [6], and thermal resistance [7–9].

---

## 23.5 Achieving Desired Pasteurization

Broadly, pasteurization can be achieved by a combination of time and temperature such as (i) heating foods to a relatively lower temperature and maintaining it for a longer time, e.g., holding pasteurization and pasteurization by overflow method, and (ii) heating foods to a high temperature and holding it for a short time only. Pasteurization can be performed in two ways: (i) by first filling sterile containers with the product and then pasteurizing, or (ii) by pasteurizing the product first and then filling in sterile containers.

---

## 23.6 Pasteurization Equipment

### 23.6.1 Pasteurization of Packaged Foods

In packaged foods like beers and fruit juices, in-container processing is applied. When the container is made of glass, generally hot-water processing is used to reduce any damage due to thermal shock. After processing, the container is cooled to 40°C, which also facilitates evaporation of the surface water. This minimizes external corrosion of metal containers or caps, and accelerates setting of adhesives used in labels. Hot-water pasteurizers may be batch or continuous in operation. The simplest batch equipment consists of a water bath in which crates of packaged food are heated to a preset temperature and held for the required length of time. Cold water is then pumped in to cool the product. A continuous version consists of a long trough fitted with a conveyer belt to carry containers through the heating and cooling stages [10].

#### 23.6.1.1 Water Bath Pasteurization

For acidic food products that can be adequately pasteurized at temperatures of 100°C or below and non-sterile meat items, a water bath is one of the simplest methods of heating for pasteurization. The water bath may be either a rectangular steel tank or a 1–m-diameter vertical retort. The product is packed in retort crates or in racks and immersed in the bath. Cooling may be carried out in the same tank used for heating or the containers may be moved from the heating tank to a cooling tank. Heating and cooling also may be carried out in steps. Essentially, the same procedure is followed in processing meats, pickles, applesauce, and other acidic food products [11]. The continuous water bath is an improvement over the batch operation and is used by both pickle processors and fruit canners for pasteurization where high production rates are required. A conveyer belt moves through the tank at a selected speed to provide adequate time in the bath to accomplish pasteurization. The tank is usually divided into sections, each of which is heated and controlled separately. In continuous water bath pasteurizers, the jars and cans must proceed down an incline into the tank and up an incline when they come out of the tank. Since there is considerable hazard in conveying glass containers up or down an incline, plants that pasteurize glass-packed products have adopted water spray or steam pasteurizers.

#### 23.6.1.2 Continuous Steam or Water Spray Pasteurizer

The continuous water spray pasteurizer is extensively used for pasteurizing beer and acidic food products. In this type of unit, the bottles or cans are conveyed through the pasteurizer either by a walking beam or by a continuous belt conveyer. It is a common practice to have as many as six different temperature zones or sections through the pasteurizer to obtain maximum efficiency. The sections are: first preheat, second preheat, pasteurizing zone, precooling, cooling, and final cooling zone. Water spray units are designed such that the water in the first preheat zone is the water that drains off the jars in the precooling zone. In this way, a considerable amount of heat is recovered and reused, and also a reduced amount of cooling water is required. Cooling water is also recirculated [11].

Glass containers should not be subjected to excessive “thermal shock”; when heating products in glass containers, it is recommended that the thermal shock temperature difference be kept below 20°C and under no condition to exceed 40°C. When cooling a hot product in a glass container, temperatures are more critical; 10°C is a desirable maximum and under no conditions should the temperature change exceed 20°C. Several sections are necessary in both continuous steam and water spray pasteurizers to heat glass containers efficiently; however, metal containers may be pasteurized in the same equipment.

Through the use of sectionalized equipment, it is possible to have high-temperature heating and low-temperature cooling of glass containers with a minimum amount of “thermal shock” breakage. The water spray-type unit has been very successful in the pasteurization of beer and similar products where the operation proceeds under ideal conditions.

The steam pasteurizer is simply a tunnel that is open at both ends with a conveyer along the bottom. Cloth baffles are hung between each section, but these are not adequate to hold the steam in the pasteurizer against strong air currents. The rate of heat transfer from the steam–air mixture to the food container is not constant in the steam pasteurizer, but varies with the steam temperature and steam velocity.

### **23.6.1.3 Tunnel Pasteurization**

Hot-water sprays are used to heat containers as they pass through the different heating zones of the tunnel and provide an incremental rise in temperature until pasteurization is achieved. Cold water sprayed later on cools the containers as they continue through the tunnel. Steam tunnels have the advantages of faster heating, shorter residence time, and smaller equipment. Savings in energy and water are achieved from heat recovery from the hot products and recirculating water. Temperatures in the heating zone are gradually increased by reducing the amount of air in the steam–air mixtures, and cooling takes place using water sprays or by immersion in a water bath [10].

## **23.6.2 Pasteurization of Unpacked Liquids**

### **23.6.2.1 Long Hold or Vat Pasteurizing**

Vat or tank-type heat exchangers are used for the long-hold method of pasteurization. Here, the raw product is pumped into the vat, heated to the pasteurizing temperature, held for the required time, and pumped from the vat through the cooling equipment. With most vat pasteurizers, circulation of the heating medium can be started as soon as the filling of the vat commences. In this way, some heating of the product takes place during filling so that the heating time can be shortened. With some designs, cold water can be circulated over the outer part of the inner liner as soon as the holding period is completed, thus achieving part of the cooling in the vat [12]. It is considered a good practice, with all heat-exchange equipment, for dairy products to use a heating medium (hot water or steam vapor) only a few degrees warmer than the milk, for then there is less accumulation of milkstone on the heating surfaces and less danger of injury to the cream line or flavor.

#### *23.6.2.1.1 Advantages*

Vat pasteurizers are well suited for small plants and for low-volume products in larger operation. They can handle a variety of products with a wide range of physical characteristics. They are especially well adapted to the processing of cultured products such as buttermilk and sour cream, which, in addition to being pasteurized and cooled, require mixing for the incorporation of starter culture, several hours of quiescent holding for incubation, agitation for breaking the curd, and final cooling in the tank.

#### *23.6.2.1.2 Disadvantages*

There are several disadvantages to consider. Vat pasteurization is normally a batch operation and is inherently slow, although the flow can be made continuous by the use of three or more vats (depending upon the holding, heating, filling, and emptying times). The operation may even be made automatic by the use of complex and expensive controls. In the great majority of batch operations, manual controls are used and constant attention must be given by the operator to prevent overheating, over holding, and burning. Another disadvantage is that regenerative heating is not possible in the vat, so both heating and cooling are relatively expensive.

### **23.6.2.2 Heat Exchanger Pasteurizer**

Small-scale batch pasteurization is carried out in open boiling pans or scrapped surface heat exchangers are used for some liquid foods. Generally, less viscous liquids are pasteurized by a plate heat exchanger. Some

products, such as fruit juices and wines, require deaeration before pasteurization to prevent oxidative changes during storage. This can be achieved by spraying liquids into the vacuum chamber after which the dissolved air is removed [13]. The plate heat exchanger consists of a series of thin vertical stainless-steel plates. The plates form parallel channels that are held tightly together in a metal frame and separated by rubber gaskets to produce a watertight. The plates are corrugated to induce turbulence for a high heat transfer rate. The advantages of heat exchangers over in-bottle processing include (i) more uniform heat treatment, (ii) simpler equipment and lower maintenance costs, (iii) reduced space requirements and labor costs, (iv) greater flexibility for different products, and (v) greater control over pasteurization conditions.

A number of systems for pasteurizing milk have been used commercially. The first were batch systems employing holding tanks. The milk was heated in a jacketed tank to a temperature of 65°C and held for 30 min. This type of system is rarely found, but it can be suitable for small operations. Improvements on the batch system came with the advent of the continuous-holding or retarding systems. Holding times and temperatures are the same; however, the tanks automatically fill, hold, and empty in a timed cycle. The system of choice in most modern dairies is now the HTST process.

The heat exchanger offers the following advantages over the batch and continuous-holding systems: (i) lower initial cost due to elimination of holding tanks, (ii) less labor required as the system incorporates mechanized circulation cleaning, (iii) saving space (about 10,000 L/h can be pasteurized in 4.5 m<sup>2</sup>), (iv) increased flexibility (capacity of the plant and processing rate can be easily controlled), (v) ease of recording and safeguarding the pasteurization temperature requirements (milk can be readily diverted if it does not reach the minimum safe pasteurized temperatures), and (vi) lower operating costs (the plant can be almost entirely automatically controlled).

The capacity of the equipment varies according to the size and number of plates—up to 80,000 L/h. Other types of heat exchangers are also used for pasteurization. In particular, the concentric tube heat exchanger is suitable for more viscous food and is used with dairy products, mayonnaise, tomato ketchup, and baby food. It consists of a number of concentric stainless-steel coils, each made from double- or triple-walled tube. Food passes through the tube, and heating and cooling water is recirculated through the tube walls. Liquid food is passed from one coil to the next for heating and cooling, and the heat is regenerated to reduce energy costs. Pasteurized food is immediately deposited into cartons or bottles. Care with cleaning and hygiene is therefore necessary.

### 23.6.2.3 High-Temperature-Short-Time Pasteurizers

HTST pasteurizers are continuous flow systems using tubular, plate, swept surface, direct steam, in conjunction with a timing pump, a holder, and controls for temperature and flow rate. The great majority of HTST pasteurizers use plate-type heat exchangers with sections for regenerative heating and cooling. The schematic of a plate-type HTST pasteurizer is shown in Figure 23.1. This is also referred to as flash pasteurizer [12]. Continuous pasteurizers assure that all the products of an entire run receive uniform treatment. HTST pasteurizers employing regenerative heating are much more economical to operate than batch pasteurizers. In the application of controls, the general requirements for flow rate, temperature, and pressure must be considered, for these are the factors that govern proper operation and public health safety.

The flow rate through a continuous pasteurizer is regulated by a metering or timing pump. A positive displacement pump of the rotary or piston type is used almost exclusively for milk and milk products. Often, variable-speed drives are employed so that the flow rate can be changed when desired. A continuous pasteurizer must include synchronization of holding time and flow rate. Controlling temperature includes maintaining a uniform product temperature at some set value at or above the legal minimum; and diverting the flow, directing it back through the system if, at the end of the holder, it is below the legal minimum temperature. Usually, a safety thermal limit-recording controller is used, which keeps a continuous record of the temperature.

Pressure is especially important in two areas of continuous pasteurizers—the regenerator and the flow-diversion valve. Where product-to-product regeneration is used, it is necessary, for public health reasons, to maintain at least 7 kPa more pressure on the pasteurized side than on the raw side so that any leakage through the heat exchanger can be identified, thus eliminating the possibility of contaminating the pasteurized product. To prevent mixing of air into the product and inefficiency of the pump due to air leakage into the system, the entire system is operated at a positive pressure (above atmospheric pressure). A

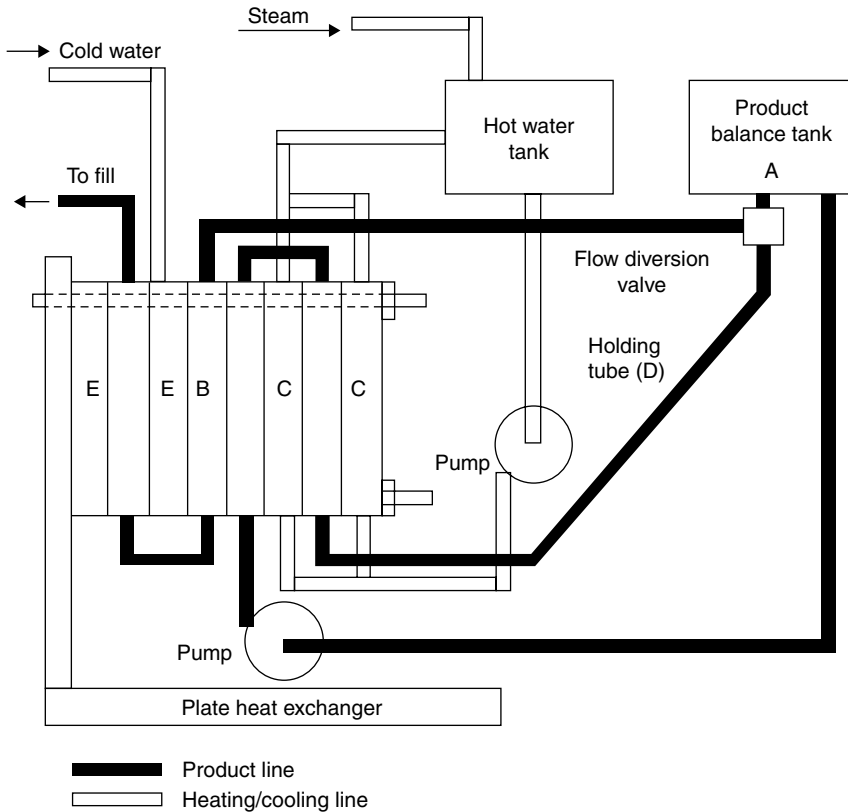


FIGURE 23.1 Plate heat exchanger pasteurizer.

centrifugal booster pump is employed between the product storage and the regenerator. This will ensure that the pasteurized product is always under a higher pressure than the raw product.

To facilitate this, it is necessary to: (i) size the booster pump correctly to deliver the rated capacity at a predetermined pressure, and (ii) equip the booster pump with a pressure-actuated switch located at the outlet of the pasteurized regenerator set so that the pump can run only when the pressure is at least 7 kPa greater than that on the raw product side. If the cooler section does not produce enough back pressure on the pasteurized regenerator to satisfy the minimum 7 kPa greater difference, it may be necessary to install a restrictor in the line. The other pressure requirement is that which is needed on the diverted milk line, since it may affect the holding time during diversion. If, upon testing, the holding time during diverted flow is shorter than that in forward flow, a restricting orifice should be placed in the diverted line.

#### 23.6.2.4 Flash Pasteurization

The process of heating fruit juices for only a short time at a temperature higher than the pasteurization temperature of the juice is called flash pasteurization. In this method, the juice is heated rapidly for about 1 min to a temperature just 5°C higher than the pasteurization temperature and filled into containers, which are sealed airtight under cover of steam to sterilize the seal and then cooled. This process can be used for orange juice, apple juice, grape juice, etc. The advantages of this process are that (i) it minimizes flavor loss, (ii) it aids in the retention of vitamins, (iii) it effects economy in terms of time and space, (iv) it helps to keep the juice uniformly cloudy, (v) it heats juice uniformly, thus reducing cooked taste to a minimum, and (vi) by this process beneficial enzyme inactivation is obtained in addition to the destruction of viable microorganisms.

*Deaerator and flash pasteurizer:* Freshly extracted and screened juices contain appreciable quantities of oxygen, which should be removed before packing. The special equipment used for this purpose is called



a deaerator. The deaerated juice is then heated in flash pasteurization equipment. Commercial deaerators and flash pasteurizers differ greatly in design, construction, and capacity. The deaerator and flash pasteurizer have been used successfully in case of fruit juices such as tomato, pineapple, and orange.

### 23.6.2.5 Ultra-High-Temperature Pasteurizers

The equipment for ultra-high-temperature (UHT) pasteurizers is much the same as for HTST units. The controls are similar but the operating temperature points are higher. The holder is, of course, much smaller for minimum pasteurizing time. Generally, with a holding time of the order of 3 s, it is impossible to determine the holding time accurately by tests similar to those used with HTST pasteurizers, and calculated holding times are preferred [12]. A UHT treatment is desired because of its greater bacterial destruction or its beneficial effects on texture in ice cream; and where confusion exists regarding requirements for UHT pasteurization. This may be accomplished with a direct-steam heater installed downstream from the flow diversion valve or with steam–vacuum flavor treating equipment.

### 23.6.2.6 Vacreator

The vacreator is a special type of pasteurizing apparatus used particularly in the butter industry. The product is fed into a steam-heated chamber where it is flashed at a temperature of 90°C–96°C under 13.5–30 kPa of vacuum. It then passes into a second chamber of higher vacuum (50–67 kPa) and is cooled to a temperature of 72°C–82°C. From here, it passes into a third chamber of high vacuum (91–95 kPa) and is further cooled down to a temperature of 38°C–46°C. This process is claimed to be very effective in pasteurization and at the same time removes undesirable odors and flavors. Also, the process employs a continuous-type machine and is especially adapted for use on high-viscosity material, although it can even operate on plain fluid milk [12].

## 23.7 Quality of Pasteurized Foods

Pasteurization is a relatively mild heat treatment, and even when combined with other unit operations (e.g., irradiation and chilling) there are only minor changes in the nutritional and sensory characteristics of most foods. However, the shelf life of pasteurized foods is usually only extended by a few days or weeks compared with several months for the more severe heat-sterilization methods.

In fruit juices, the main cause of color deterioration is enzymatic browning by polyphenol oxidase. This is promoted by the presence of oxygen, and fruit juices are therefore routinely deaerated prior to pasteurization. The difference between the whiteness of raw milk and that of pasteurized milk is due to homogenization, and pasteurization has no measurable effect. Other pigments in plant and animal products are also unaffected by pasteurization. A small loss of volatile aroma compounds during the pasteurization of juices causes a reduction in quality and may also unmask other “cooked” flavors. Volatiles recovery may be used to produce high-quality juices but this is not routinely used. Loss of volatiles from raw milk removes the hay-like aroma and produces a blander product.

In fruit juices, losses of vitamin C and carotene are minimized by deaeration. Changes to milk are confined to a 5% loss of serum proteins and small changes to the vitamin content (Table 23.2). Most of the pasteurized food products have a low pH either because the natural pH of the system is low or the product has been fermented to produce an acidic environment. Since most of the heat-labile nutrients are relatively stable in acidic conditions, nutrient losses in those products are relatively minor. Although thermal losses during pasteurization may be small, oxidative losses can be high. Thus, pasteurization of liquid foods such as fruit juices, beer, and wine is generally accomplished in

**TABLE 23.2**  
Vitamin Losses during Pasteurization of Milk

Vitamin	Method of Pasteurization	
	HTST	Holder
B <sub>6</sub>	0	0
Thiamin	6.8	10.0
C	10.0	20.0
B <sub>12</sub>	0	10

Source: J.E. Ford, et al. *J. Dairy Res.* **36** (1969), p. 447.

indirect heat exchangers like plate- or double-tube rather than open film-type pasteurizers. Often, fluids are deaerated prior to pasteurization. The most important nonacid liquid food is milk. The effect of pasteurization on the nutrients in milk has received considerable attention.

Ascorbic acid degradation of single-strength orange juice was lower than that of fully pasteurized orange juice under aerobic conditions with ca. 23% and 83%, respectively, after 7 weeks of storage. It is reported that unpasteurized orange juice exhibited significantly higher ascorbic acid retention than fully or lightly pasteurized juice during storage at 4°C for 36 days [14]. Similar results have also been reported for long-life commercial orange juice, which, when stored in open containers in the refrigerator for 1 month, lost 60%–67% of its ascorbic acid, whereas fresh orange juice lost 7%–13% [15]. These differences in the destruction rates of ascorbic acid during storage between single-strength and fully pasteurized orange juice may be due to (i) oxygen consumption by natural background flora in single-strength juice; (ii) the thermal oxidative destruction of several protectors of ascorbic acid such as bioflavonoids (anthocyanes, flavonols, etc.), vitamins P1 and P2, vitamin E, and phenols; and (iii) the production of oxidative molecules during the first steps of the Millard reaction. The ascorbic acid content of single-strength orange juice was found to be 41 mg/100 mL, and this decreased during pasteurization at 90°C for 1 min to 38 mg/100 mL. The ascorbic acid degradation rates of single-strength and fully pasteurized orange juice were high for the first 3 weeks of storage; they then stabilized up to the seventh week.

The ungasged juice sample exhibited higher browning than both the other conditions (nitrogen and gas mixture). Fully pasteurized orange juice, gassed by nitrogen or the gas mixture then stored under the same gas, showed a significantly lower browning index than that of ungasged juice (control). Oxygen elimination in the gassed samples (nitrogen and gas mixture) could decrease the evolution of browning because browning is considered as an oxidative reaction [16]. Furfural formation, which is due to the decomposition of ascorbic acid, has a similar effect to sugar and may combine with amino acids and contribute to juice browning. Storage temperature can also affect the evolution of browning. It is reported that 12°C was the critical storage temperature for furfural accumulation [17].

The pH of different samples of orange juice (uninoculated with the test microorganisms) was monitored during ascorbic acid and browning experiments. The pH value significantly decreased for control (unheated) samples. The consumption of oxygen by natural background flora and the production of acidic metabolites may account for this decrease in pH values. Storage under both oxygen-free and reducing conditions improves the microbial and organoleptic quality of pasteurized orange juice. Consequently, it might be proposed to adjust the redox potential by gas just after heat treatment to maximize thermal destruction of microorganisms and to stabilize the product during storage [18].

A comparative study between the aromatic profiles of fresh orange juice versus deaerated and pasteurized juices, respectively, was conducted to understand the evolution of volatile components after the deaeration and pasteurization processes. The aromatic fractions isolated by simultaneous distillation and extraction were analyzed by capillary gas chromatography–mass spectrometry. At the qualitative level, all the volatile components in fresh orange juice were also found in the counterparts after deaeration and pasteurization processes. According to statistical analyses, significant losses in the concentration of volatile components occurred during the deaeration process, while there were no significant differences determined among the concentrations of volatile components in deaerated and pasteurized juices. These results show that during the industrial processing of orange juice, the biggest losses in the concentration of volatile components occur during deaeration. The pasteurization process did not change the analytical composition of deaerated orange juice in a significant way for any of the 42 quantitated compounds [19].

Changes in carotenoid pigment content and juice color due to thermal pasteurization of Valencia orange juices have been studied [20]. Total carotenoid pigment content loss was significant ( $P < 0.05$ ) after thermal pasteurization at 90°C for 30 s. Thermal effects on carotenoid pigment contents, especially on violaxanthin (–46.4%) and antheraxanthin (–24.8%), were clearly observed. With the loss of violaxanthin and antheraxanthin, lutein became the major carotenoid, followed by zeaxanthin, in pasteurized Valencia orange juice. There was a perceptible color change after orange juice pasteurization, which led the juice color to become lighter and more saturated. Decreases in Commission International d'Eclairage (CIE)  $a^*$  value and increases in CIE  $L^*$ ,  $b^*$ ,  $h^*$ , and  $C^*$  are the major color changes after pasteurization. Overall, increases in reflected light might also influence the perception of color to a great extent in pasteurized orange juice. Total color difference ( $\Delta E^*$ ) compared to the fresh juice was  $2.92 \pm 0.97$  ( $P < 0.05$ ).

## **23.8 Packaging of Pasteurized Foods**

Both bottles and cartons take into account the properties of milk and provide packaging acceptable to consumers worldwide. Glass bottles have the advantage of being easily cleaned, transparent, and rigid, but have the great disadvantage of high weight and fragility. Increasingly, milk is being packaged in gable top (PurePak, Elopak) or other cartons (TetraBrik). Even though these equipment may be expensive to install, the advantages include a lower price per unit of milk and a lower risk of contamination from the air during filling [21]. Smaller quantities have been packaged in plastic pouches. A cylindrical milk carton with a reclosable pouring lid has been introduced [22]. While suitable for sterilized milk, glass bottles are a problem for “long-life” milk. The question of container is therefore of vital interest to the dairy industry, as about 50% of all milk produced is sold in liquid form [22]. Sunlight can destroy riboflavin and vitamin C in milk, producing a taint by the oxidation of fat [22] and protein. This led to the use of brown glass bottles, which holds back the responsible light rays. However, the taint is very rare and brown bottles are not very attractive. It has also been found that milk turns sour faster in brown bottles than in colorless ones [23].

### **23.8.1 Returnable Bottles**

For economic reasons, the use of returnable glass bottles has continued over many years. The glass bottle will take a long time to disappear because of its economic advantage, the traditions of the industry, and the attitude of the consumer. Other factors such as transport costs have led to the use of nonreturnable packaging, although more recently “green” considerations have led to the reintroduction of returnable bottles [22,24]. The advantages of nonreturnable containers are (i) elimination of returned empties, (ii) elimination of collecting, sorting, and washing, (iii) elimination of the foreign object problem, (iv) elimination of the glass fragment problem, and (v) reduction in transport costs. The disadvantages are (i) possible increases in packaging costs, (ii) lack of consumer acceptance, (iii) delivery problems resulting in lower total sales, (iv) hygiene problems, and (v) environmental considerations. Plastic containers and plastic-coated cartons are nearly sterile by virtue of their method of manufacture. No sterilizing process is necessary for pasteurized milk, but for the aseptic filling of milk, sterilization is essential. So far, TetraBrik has proved to be the most effective. The containers must be sterilized immediately before filling.

### **23.8.2 Glass Bottles**

The traditional glass bottles used for fruit juices and fruit juice beverages provide many advantages. Glass is not susceptible to mold growth and is impermeable to odorous vapors and liquids. Hot filling and in-bottle pasteurization are generally employed for pure fruit juices or products that do not contain preservatives. Hot filling is achieved by passing the liquid product through a heat exchanger and then filling above 70°C. The closure is then applied. Any microbiological contamination on the inner surfaces of the bottle and the closure is destroyed by the hot liquid, and adequate sterility is achieved without heating the container [22]. Glass bottles can also be covered with a polystyrene shield, which enables bottles to be reduced in weight without risking breakage of bottles. Sleeves give protection and graphics can be added easily. Some bottles are shrinkwrapped with plastic sleeves.

### **23.8.3 PET Bottles and Other Plastic Containers**

PET bottles are displacing those made from PVC for products such as edible oils and mineral waters, as well as glass bottles used for carbonated products. Improvements in processing technology have resulted in the appearance of stretch-blown PVC bottles. PET bottles have also become lighter than before (a 2 L bottle usually weighs less than 40 g) and can be coated externally with PVC to provide improved resistance to gas permeability. Polyethylene and PVC bottles are being used for squashes and cordials, but shelf life is restricted compared to glass [25]. Unlike glass the PET bottle will lose carbon dioxide with time, about 15% over 4 months [26,27]. Hence, PET is preferable for drinks with high carbon dioxide content in large bottles, whereas for lower carbonation levels, and small- or medium-sized bottles, other materials may be better. Other forms of plastic containers have also been used [25,28], for example, the Plasto-can, a coextruded

plastic container with conventional aluminum easy-open can ends; and the Rigello container, a multilayered polypropylene foil extrusion with a spherical bottom and tear-off cap assembled in a paperboard cylinder. New combinations of materials in can form are also being developed. Coca Cola has patented a PET/aluminum can with an easy open top [29]. High-barrier plastics cans, which can be recycled, are under investigation. Orange juice has also been packed in clear oriented polypropylene bottles, which provide good oxygen and moisture barrier properties [30]. Tamper-evident pull-tab closures are used on this container. Paperboard basket carriers, plastic clips (on bottle necks), and shrink films are used to provide multipacks holding three, four, or six units.

#### 23.8.4 Cans

Fruit juices and fruit juice concentrates are frequently distributed in cans [31]. The most common are standard tin-plate containers, but specially lacquered and coated cans are also used, especially for high-acid products. Cans are usually hot filled, but sometimes are aseptically filled. Cold filling after pasteurization is occasionally employed but refrigerated or frozen storage is then advisable. Products preserved with benzoic acid can also be filled cold after pasteurizing, but sulfated products are incompatible with cans. The juice tends to deteriorate in the cans due to corrosion and an increasing amount of tin and iron in the product.

In the normal hot-canning process, the juice is first deaerated to improve its flavor stability and then pasteurized to destroy microorganisms and inactivate enzymes. After hot-filling into the cans, the lids are applied and sealed immediately before cooling, which forms a slight vacuum in the headspace as the liquid contracts. This is desirable as the presence of oxygen encourages corrosion (cold-filling operations usually involve undercover gassing, in which the head space is replaced by carbon dioxide immediately before sealing the lid).

Carbonated beverages are susceptible to metal pick-up and are therefore packaged in lacquered two-piece aluminum cans or three-piece tin-plate with side seams having a special tab design to withstand the internal pressure. Warming the filled cans immediately before packaging is important, otherwise the cans when filled with cold carbonated liquid attract a layer of condensation from the atmosphere and may corrode on the outside. Frozen orange juice concentrate has been distributed in composite paperboard or plastic canisters of approximately 170 mL capacity [25]. There are many pack variations, including canisters with tear-off ends are frequently left unpasteurized to provide maximum freshness of flavor. Spoilage may result if it is left unfrozen.

Bulk frozen orange juice is packed in 200 L polyethylene drums or polyethylene-lined steel drums or transported in tankers. However, aseptically produced juice (e.g., in bag-in-box systems) is replacing bulk frozen juice. Beverage cans are also sold in multipacks of four, six, or more [32]. The most common form of over wrapping that assists handling and distribution is a plastic ring carrier that slips underneath the rim of the can and grips tightly throughout distribution. Paperboard multipacks are also popular as are shrink films.

#### 23.8.5 Cartons

Pasteurized fruit juice and soft drinks can be packaged very successfully in cartons with a polyethylene coating or in plastic containers [32]. These products have a limited shelf life when stored in a refrigerator. Materials selected must not absorb flavor components from the juice. In addition, acid diffusion into the plastic material can delaminate the package. Polyethylene is the most common surface-contact material and is regarded as chemically stable with most food products. Packaging materials must also provide the best possible barrier to light, which affects the color and nutritive value of fruit juices. Aseptic filling of fruit juices and other drinks into TetraPaks and other systems (e.g., Combibloc, PurePak, Elopak) has also become popular, giving the product an extended shelf life. Such products have advantages over hot-filled products or nonaseptically packaged products, which need a chilled distribution chain [33].

---

### 23.9 Energy Aspects of Pasteurization

Indirect heating through a heat exchanger involves much more energy than direct heating with infusion heating. To reduce the energy input and hence improve the efficiency of the system, a regenerative

**TABLE 23.3**

Steam and Electrical Requirements of a Pasteurizer

Percent regeneration	80	85	90	95
Steam (kg/L)	0.012	0.01	0.005	0.003
<b>Power (kWh/1000 L)</b>				
Pumping	0.66	0.88	1.54	2.86
Refrigeration cooling	3.52	2.64	1.76	0.88
<b>Primary Energy (MJ/L)</b>				
Steam	0.072	0.053	0.034	0.021
Electricity	0.059	0.050	0.047	0.053

Source: R.L. Upadhyaya, *Indian Dairyman* **39(1)** (1987), p. 1; P.S. Harris, *J. Soc. Dairy Technol.* **3(3)** (1978), p. 133.

method is adopted. For example, total energy difference between the 90% and 80% regeneration capacity of a system processing milk is about 62 and 131 kcal/h, respectively. This shows that even a 10% increase in the regenerative efficiency can save considerable energy [34]. Regeneration of heating and cooling streams is now an accepted conservation technique.

The heat energy consumption for pasteurization will be about 30 MJ per 1000 L milk and correspondingly the cooling energy is about 4 kWh. Normally, pasteurizers will have the facility of regeneration, with an efficiency of 75%–92%. Efficiency can be increased by increasing the number of plates in the regeneration section. But this increases the pumping pressure and hence the electrical energy. Hence, the maximum regeneration is about 90%. Table 23.3 gives the steam and electrical requirements of a large-size pasteurization unit [35,36]. Increasing regeneration decreases the steam and refrigeration requirement but increases the electricity required for pumping. These energy requirements have also been converted into their primary fuel equivalents. This facilitates checking of the processes on a uniform energy basis. The processing, storage, and distribution of pasteurized milk requires an estimated 2200 kJ/kg of milk [37].

## References

1. S.K. Sharma, N. Sehgal and A. Kumar, Dry-reagent strips for testing milk pasteurization. *Lebensmittel-Wissenschaft und-Technologie* **36(6)** (2003), pp. 567–571.
2. M.E. Parish and D. Higgins, Yeasts and molds isolated from spoiling citrus products and by products. *J. Food Prot.* **52** (1989), pp. 261–263.
3. B.M. Lund and G.M. Wyatt, The effect of redox potential, and its interaction with sodium chloride concentration, on the probability of growth of *Clostridium botulinum* type E from spore inoculum. *Food Microbiol.* **1** (1984), pp. 49–65.
4. I.J. Kligler and K. Guggenheim, The influence of vitamin C on the growth of anaerobes in the presence of air, with special reference to the relative significance of Eh and O<sub>2</sub> in the growth of anaerobes. *J. Bacteriol.* **35** (1938), pp. 141–149.
5. C.B. Pearson and H.W. Walker, Effect of oxidation–reduction potential upon growth and sporulation of *Clostridium perfringens*. *J. Milk Food Technol.* **39** (1976), pp. 421–425.
6. G. Unden, M. Trageser and A. Duchêne, Effect of positive redox potential (> +400 mV) on the expression of anaerobic respiratory in *Escherichia coli*. *Mol. Microbiol.* **4** (1990), pp. 315–319.
7. O. Reichart and C. Mohacsi-Farkas, Mathematical modeling of the combined effect of water activity, pH and redox on the heat destruction. *Int. J. Food Microbiol.* **24** (1994), pp. 103–112.
8. S.M. George, L.C.C. Richardson, I.E. Pol and M.W. Peck, Effect of oxygen concentration and redox potential on recovery of sub-lethally heat-damaged cells of *Escherichia coli* 0157:H7, *Salmonella enteritidis* and *Listeria monocytogenes*. *J. Appl. Microbiol.* **48** (1998), pp. 903–909.
9. C. Riondet, R. Cachon, Y. Wache, G. Alcaraz and C. Divies, Combined action of redox potential and pH on heat resistance and growth recovery of sublethally heat-damaged *Escherichia coli*. *Appl. Microbiol. Biotechnol.* **53** (2000), pp. 476–479.

10. P. Fellows, Processing by application of heat, In: *Food Processing Technology; Principles & Practice* (P. Fellows ed.) Ellis Horwood, England (1988), p. 221.
11. I.J. Pflug and W.B. Esselen, Heat sterilization, In: *Fundamentals of Food Canning Technology* (J.M. Jackson and B.M. Shinn eds.) Van Nostrand Reinhold, New York (1979), p. 71.
12. A.W. Farrall, Pasteurizing Equipments, In: *Engineering for Dairy Food Products* (A.W. Farrall ed.) Wiley, New York (1980), p. 363.
13. N.I. Barclay, J.D. Potter and A.L. Wiggins, Batch pasteurization of liquid whole egg. *J. Food Technol.* **19** (1984), p. 605.
14. G.D. Sadler, M.E. Parish and L. Wicker, Microbial, enzymatic, and chemical changes during storage of fresh and processed orange juice. *J. Food Sci.* **57** (1992), pp. 1187–1197.
15. D. Kabasakalis, D. Siopidou and E. Moshatou, Ascorbic acid content of commercial fruit juices and its rate of loss upon storage. *Food Chem.* **70** (2000), pp. 325–328.
16. A.J. McEvily and R. Lyengar, Inhibition of enzymatic browning in foods and beverages. *Crit. Rev. Food Sci. Nutr.* **32** (1992), pp. 253–273.
17. J. Kanner, J. Fishbein, P. Shalom, S. Harel and I. Ben-Gera, Storage stability of orange juice concentrate packaged aseptically. *J. Food Sci.* **47** (1982), pp. 429–431.
18. D. Alwazeer, C. Delbeau, C. Divies and R. Cachon, Use of redox potential modification by gas improves microbial quality, color retention, and ascorbic acid stability of pasteurized orange juice. *Int. J. Food Microbiol.* **89**(1) (2003), pp. 21–29.
19. M.J. Jordán, K.L. Goodner and J. Laencina, Deaeration and pasteurization effects on the orange juice aromatic fraction. *Lebensmittel-Wissenschaft und-Technologie* **36**(4) (2003), pp. 391–396.
20. H.S. Lee and G.A. Coates, Vitamin C in frozen, freshly squeezed, unpasteurized, polyethylene-bottled orange juice: a storage study. *Food Chem.* **65** (1999), pp. 165–168.
21. K.J. Burgess, Dairy products, In: *Food Industries Manual*, 2nd edition (M.E. Ranken ed.), Blackie, Glasgow (1988).
22. F.A. Paine and H.Y. Paine, Fresh and Chilled foods, In: *A Hand Book of Food Packaging*, 2nd edition (F.A. Paine and H.Y. Paine eds.), Chapman & Hall, New York (1993), p. 224.
23. G. Stehle, Trends in packaging techniques for milk products and fruit. *Neue Verpack* **41**(10) (1988), p. 56.
24. R.N. Hassen, A dressing down of the bottle freaks. *North Eur. Food Dairy J.* **55** (1989), p. 81.
25. A.J. Iversen, Cartons for liquids, In: *Modern Processing, Packaging and Distribution Systems for Food* (F.A. Paine ed.), Blackie, Glasgow (1987), p. 86.
26. A.J. Francis and P.W. Harmer, Fruit juices and soft drinks, In: *Food Industries Manual* (M.D. Ranken ed.), Blackie, Glasgow (1989).
27. B.I. Turtle, PET containers for food and drink. *Food Technol. Int.* **315** (1990).
28. L. Karjalainen, Packaging of carbonated beverages, In: *Modern Processing, Packaging and Distribution Systems for Food* (F.A. Paine ed.), Blackie, Glasgow (1987).
29. K. Kimura and G. Mitsu, Discussion on development and innovation of food packaging. *Food Policy (Jpn.)* **3** (1989), p. 65.
30. F.A. Paine and H.Y. Paine, Juices, Soft drinks and Alcoholic Beverages, In: *A Hand Book of Food Packaging*, 2nd edition (F.A. Paine and H.Y. Paine eds.), Chapman & Hall, New York (1982), p. 339.
31. J.A.G. Rees and J. Bettison, Heat preservation, In: *Food Industries Manual* (M.D. Ranken ed.), Blackie, Glasgow (1988), p. 477.
32. J.V. Bousom, Carriers; beverage, In: *The Wiley Encyclopedia of Packaging Technology* (M. Bakker ed.), Wiley, New York (1986), p. 129.
33. J.H. Briston, Recent developments in bag-in-box packaging. *Food Tech. Int.-Eur.* **319** (1990).
34. S. Mardon, Energy saving in European dairy Industry. *Dairy Ind. Int.* **47**(6) (1982), p. 9.
35. R.L. Upadhy, Recent developments in energy conservation in dairy industry. *Indian Dairyman* **39**(1) (1987), p. 1.
36. P.S. Harris, Energy conservation in the dairy industry. *J. Soc. Dairy Technol.* **3**(3) (1978), p. 133.
37. D.I. Chandarana, B.C. Frey, L.E. Stewart and J.F. Mattick, UHT milk processing-effect on process energy requirements. *J. Food Sci.* **49** (1984), p. 977.
38. J.E. Ford, J.W.G. Porter, S.Y. Thompson, J. Tootmill and J. Edwards-Webb, Effects of UHT processing and subsequent storage on the vitamin content of milk. *J. Dairy Res.* **36** (1969), p. 447.



# 24

## *Canning and Sterilization of Foods*

M. N. Ramesh

### CONTENTS

24.1	Introduction .....	586
24.2	Theory of Sterilization.....	586
24.3	Methods of Sterilization .....	587
24.4	Bulk Canning.....	587
24.4.1	Introduction .....	587
24.4.2	Processing Equipment .....	587
24.4.2.1	Methods of Processing the Containers .....	587
24.4.2.2	Methods of Heating Medium .....	588
24.4.3	Description of Processing Equipment .....	588
24.4.3.1	Batch/Still Retorts (Horizontal and Vertical) .....	588
24.4.3.2	Water Processing Retorts .....	591
24.4.3.3	Crateless Retort Systems .....	591
24.4.3.4	Agitating Retorts .....	592
24.4.3.5	Continuous Rotary Sterilizers.....	592
24.4.3.6	Cascading Water Retorts.....	592
24.4.3.7	Rotary, Full, Immersion, Hot-Water Sterilizers .....	594
24.4.3.8	“Hydrolock” Continuous Cooker/Cooler .....	594
24.4.3.9	Hydrostatic Pressure Sterilizer .....	595
24.4.3.10	Hydrostatic Helix .....	596
24.4.3.11	Continuous Pallet Sterilizer .....	596
24.4.3.12	Flame Sterilizers .....	596
24.4.3.13	Fluidized Bed Sterilization .....	597
24.4.3.14	Hot Sterilization .....	597
24.4.4	Temperature Distribution in the Retort Systems .....	597
24.4.5	Exhausting .....	598
24.4.6	Quality of Canned Foods .....	599
24.4.6.1	Plant Origin Foods .....	599
24.4.6.2	Animal Origin Foods .....	603
24.4.7	Packaging of Canned Foods .....	604
24.4.7.1	Tin-Plate Cans.....	604
24.4.7.2	Glass Containers and Metal Closures .....	605
24.4.7.3	Retortable Pouches .....	606
24.4.8	Energy Aspects of Canning .....	608
24.5	Aseptic Processing .....	609
24.5.1	Introduction .....	609
24.5.2	Sterilization Systems .....	609
24.5.3	Processing Equipment .....	609
24.5.3.1	Infusion Sterilization.....	609
24.5.3.2	Tubular Aseptic Sterilizer .....	610
24.5.3.3	Swept Surface Sterilizer .....	610
24.5.3.4	Plate Sterilizer.....	610



24.5.4	Packaging Systems.....	610
24.5.4.1	Sterilization of Packaging Materials.....	611
24.5.4.2	Aseptic Filling and Packaging Machines .....	612
24.5.5	Quality of Aseptically Processed Foods .....	616
24.5.6	Nutritional Aspects of Aseptically Processed Foods .....	616
24.5.7	Packaging of Aseptically Processed Foods .....	617
24.5.7.1	Introduction.....	617
24.5.7.2	Aseptic Packaging.....	618
24.5.8	Energy Aspects of Aseptic Processing.....	620
References	.....	620

---

## 24.1 Introduction

Sterilization is the complete destruction or elimination of all viable organisms in/on a food product being sterilized. Sterilization destroys yeasts, molds, vegetative bacteria, and spore formers, and allows the food processor to store and distribute the products at ambient temperatures, with extended shelf life. Sterilization procedures involve the use of heat, radiation, or chemicals, or physical removal of cells. The sterilization process consists of four distinct stages. First, the product must be heated to a temperature of 110°C–125°C to ensure sterilization. Second, the product requires a few minutes to equilibrate, since the surface will be hotter than the central portion of the container causing a temperature gradient. The equilibration stage allows reduction in the temperature gradient. Third, the product must be held at this temperature for a certain period to ensure a predetermined sterilization value designated by  $F_0$  value. Finally, the product has to be cooled mainly to arrest further heat treatment and avoid over cooking [1]. The basic principles of sterilization technology as applied to food processing are [2]:

- The processed product must be free from microorganisms capable of producing food-poisoning toxins and those microorganisms that cause food spoilage during product shelf life, until it is consumed.
- *Clostridium botulinum* spores are capable of growing in low-acid (pH > 4.6) products during storage and hence must be heat treated to the equivalent of at least 121.1°C for 3 min (an  $F_0$  value of 3) to achieve a 12-decimal reduction of the microorganism.
- The processing conditions should be applied to the slowest-heating point referred to as “cold point.” This facilitates the assumption that, when the slowest heating part is sterilized, by exposing it to the required time–temperature profile, the rest of the product will be sterilized.

Practically, complete sterilization will lead to deterioration in product quality and nutrients [3]. Hence, in practice, commercial sterility is targeted. Commercial sterility is defined as a product that has been optimally processed so that under normal conditions, the product will neither spoil nor endanger the health of the consumer and also retain the organoleptic properties and nutrients [4]. The pH of the product is an important factor in determining the severity of the sterilization process.

---

## 24.2 Theory of Sterilization

Thermal treatment of food products to render them free of pathogenic microorganisms is being practiced for several years. However, a method to quantify the microbial destruction that takes place during a thermal treatment has only been understood for the last 75 years. To determine the amount of microbial destruction that a thermal treatment delivers to a process requires both an understanding of the amount of heat delivered to every portion of the food product and the destruction kinetics of the microorganisms of interest. The amount of heat delivered by the sterilization process is dependent on the way in which the product is heated and on its physical nature. Process-dependent factors include processing equipment design, type of heating media, container, or food size and shape, product composition and viscosity

(conduction or convection heated). The thermal destruction kinetics of microorganisms or their ability to be killed within the food matrix is dependent on a number of factors. These factors include pH of the product, levels and types of preservatives, water activity, the previous growth conditions of the microorganisms of concern, product composition, and competitive microorganisms [5].

The two types of bacteria of concern in food preservation are organisms of public health significance and spoilage-causing bacteria. In low-acid foods with a pH greater than 4.6, the organism of public health significance is *Clostridium botulinum*. Canned foods are processed based on the survival probability for *C. botulinum* of  $10^{-12}$  or one survivor in  $10^{12}$  cans. The organism most frequently used to characterize low-acid food spoilage by mesophilic spore formers is PA 3679, a strain of *C. sporogenes*. Most food companies accept thermal inactivation of  $10^{-5}$  for mesophilic spore formers and  $10^{-2}$  for thermophilic spore formers. The processing time depends on the bioburden of the most resistant bacteria in a particular food, the spoilage risk involved, and whether food can support the growth of potential contaminating bacteria [6]. Though a lot of research work has been carried out on the influence of different factors on the processing time and the corresponding sterilization value, a number of uncertainties still exist on the application of these factors to scientifically arrive at the exact processing conditions. These uncertainties have been discussed in detail [7]. To avoid any risk due to these uncertainties, a safety factor is added to increase the processing time to completely sterilize the food product, which invariably reduces the nutrient content and the increase in energy cost.

---

### 24.3 Methods of Sterilization

The food sterilization methods are divided into two categories: sterilization by heating (thermal processing) and sterilization without heating (nonthermal processing). Thermal processing is widely practiced in spite of some problems such as that the process of heating might reduce nutrition or deteriorate the quality of foods and that it is ineffective against certain types of bacteria. Thermal processing is further divided into two categories as in-container sterilization (bulk canning) and aseptic sterilization (processing). The principles involved in thermal sterilization of foods remain the same for both the methods.

---

### 24.4 Bulk Canning

#### 24.4.1 Introduction

The thermal processing operation requires the heating of food products. For a low-acid food product (pH > 4.6), the product is heated to temperatures above 100°C usually in the range of 115°C–130°C for a time sufficient to achieve a 12-log reduction of the spores of *C. botulinum* as defined in the Department of Health Code of Practice No. 10. Current practices are, however, to move to even higher temperatures and consequently a shorter process time to maximize the organoleptic and nutrient retention within the product. The time–temperature procedure required to render a product commercially sterile must be carefully determined using established procedures. Canned foods might be described as full-moisture, ambient-temperature stable food products regardless of the package form employed.

#### 24.4.2 Processing Equipment

The food processing industry produces a wide range of products in a variety of containers. This requires the need of an equally wide range of processing techniques, retort designs, and operating procedures. Retorting systems can be subdivided in several ways.

##### 24.4.2.1 Methods of Processing the Containers

The two types of retorts are batch retorts and continuous retorts. In batch systems, the retort is filled with product, closed, and then put through a processing cycle. In continuous retorting systems, containers are continuously fed into and out of the retort. Batch retorts are available in a number of configurations for various applications, including static, rotary, steam heated, and water heated with or without air

overpressure. The air overpressure is necessary to maintain the integrity of the containers during retort operating cycles for glass and flexible containers.

#### **24.4.2.2 Methods of Heating Medium**

The heating medium used in retort are: steam, steam/air, water, direct flame or fluidized bed.

##### *24.4.2.2.1 Saturated Steam*

Latent heat is transferred to food when saturated steam condenses on the outside of the container. If air is trapped inside the retort, it forms an insulating boundary film around the cans, which prevents the steam from condensing and causes underprocessing of the food. It also produces a lower temperature than that obtained with saturated steam. It is therefore important that all air is removed from the retort by the incoming steam using a procedure known as venting [8]. After sterilization, the containers are cooled with water. Steam is rapidly condensed in the retort, but the food cools more slowly and the pressure in the containers remains high. An overpressure of air is therefore used to prevent strain on the container seams (pressure cooling). When the food has cooled to below 100°C, the overpressure of air is removed and cooling continues to approximately 40°C. At this temperature, moisture on the container dries to prevent surface corrosion, and label adhesives set more rapidly. Rigid polymer trays heat more rapidly than conventional container owing to their thinner cross section. Trays are processed in a conventional equipment using saturated steam at 121°C.

##### *24.4.2.2.2 Hot Water*

Foods are processed in glass containers or flexible pouches under hot water with an overpressure of air. Glass containers are thicker than metal cans to provide adequate strength, and this, together with lower thermal conductivity of glass, results in slower heat penetration and longer processing time than for cans and there is a higher risk of thermal shock to the container. Foods in flexible pouches heat more rapidly owing to the thin cross section of the container. This enables saving in energy and causes minimum overheating near the container wall. Liquid or semiliquid foods are often processed horizontally to ensure that the thickness of food is constant across the pouch. Vertical packs promote better circulation of hot water in the retort, but special frames are necessary to prevent the pouches from bulging at the bottom, which would alter the rate of heat penetration and hence the degree of sterilization achieved [8].

##### *24.4.2.2.3 Flames*

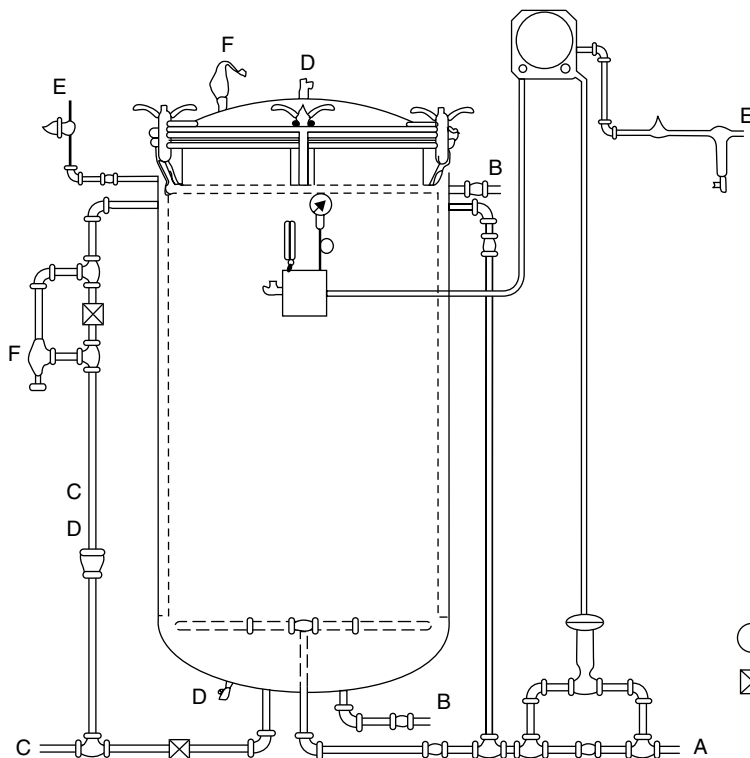
High rates of heat transfer are possible at flame temperatures of 1770°C. The consequent short processing times produce foods of high quality and reduce energy consumption by 20% compared with conventional canning. Each can is scanned by an infrared controller after processing, instead of the usual procedures. High internal pressures (275 kPa at 130°C) limit the application of this method to small cans [8].

### **24.4.3 Description of Processing Equipment**

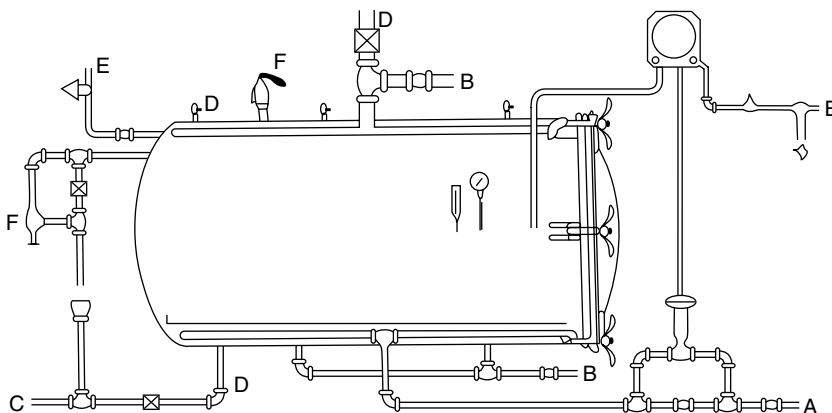
A variety of retorts, which use “pure” steam as the processing medium, i.e., steam free of air, are available. Steam retorts with batch container handling are vertical and horizontal still retorts, crateless retorts, and agitating retorts. Steam retorts with continuous containers handling include continuous rotary sterilizers and hydrostatic retorts. Retort operating procedures must ensure that uniform processing temperature is achieved and maintained throughout the location of containers during the process.

#### **24.4.3.1 Batch/Still Retorts (Horizontal and Vertical)**

Batch steam retorts are usually arranged either vertically (Figure 24.1) or horizontally (Figure 24.2) and are used for canned products that are placed into baskets immediately after seaming and are then placed inside the retort shell. The retort is made out of a metal shell pressure vessel that is fitted with inlets for steam (A), water (B), and air (E) and has outlet ports for venting (D) air during retort come up, and for draining (C) the retort at the end of the cycle. A pocket for thermometer or temperature recording probe/sensor and pressure gauge is located on the side of the vessel. To ensure adequate steam movement around the temperature sensors, the pocket is fitted with a constant steam bleed (D). On vertical retorts,



**FIGURE 24.1** Vertical batch retort. (From Paine, F.A. and Paine, H.Y., eds., *A Handbook of Food Packaging*, 2nd edn., Chapman & Hall, New York, 1982, p. 224.)



**FIGURE 24.2** Horizontal batch retort. (From Paine, F.A. and Paine, H.Y., eds., *A Handbook of Food Packaging*, 2nd edn., Chapman & Hall, New York, 1982, p. 224.)

the lid is hinged at the top and secured to the shell during processing by several bolts. In horizontal steam retorts, the door is usually on the end of these machines, which can swing open. A safety valve and a pressure relief valve (F) are also provided for safety of the equipment [9].

The operating cycle for this type of retort involves loading the sealed containers into the retort, bringing the retort up to a temperature of around 100°C, and then allowing steam to pass through the vessel into the atmosphere for sufficient time so that all air in the retort and in between the cans is removed (venting) before the retort is finally brought up to the operating pressure and processing

temperature. At the end of the processing time, the steam is turned off, and a mixture of cooling water and air is introduced into the retort to cool the cans. The purpose of the air is to maintain the pressure in the retort following the condensation of the residual steam after the initial introduction of cooling water. If this pressure is not maintained, the containers may deform due to the pressure imbalances between the internal pressure in the cans and the retort. As the temperature drops, the pressure in the retort may be controlled and gradually reduced until atmospheric pressure is reached and water can be allowed to flow through the retort, cooling the cans to a temperature of about 40°C before they are removed from the retort. Cans are removed from the retort at this temperature since this allows the surface of the cans to dry rapidly by evaporation thereby reducing the risk of leaker spoilage [10]. The water is preferably sprayed or alternatively the retort may simply be filled and allowed to stand for sufficient time for the cans to cool to 40°C before unloading the containers.

Both the systems are static in operation. For other types of product, it is possible to assist the rate of heat penetration by agitating the cans in the steam environment by rotation either about the horizontal axis in a horizontal retort or by rotation in the vertical plane in a vertical retort.

#### 24.4.3.1.1 *Steam/Air Retort Systems*

The use of glass and plastic containers has increased the use of alternative retorting systems. With these types of containers, it is usually not sufficient to rely on the strength of the containers alone to counteract the build up of internal pressure during heating, but a constant overpressure of air is required to ensure the integrity of the package during heating. Thus, the heating medium used in this type of retort is often a mixture of steam and air in proportions designed to provide the necessary steam temperature and air overpressure to maintain the package integrity. To ensure adequate mixing of the steam and air, these retorts are fitted with a fan system to disperse the steam and air and eliminate the development of cold spots in the processing chamber [9].

Control of this type of retort system can be difficult, particularly in ensuring an adequately uniform temperature distribution in the retort environment when the steam is being mixed with cold compressed air. Here, unlike in the case of saturated steam retorts, the presence of air must not permit a reduction in the partial pressure of the steam and hence retort temperature, but only provide the overpressure needed to ensure package integrity. However, the steam and air must be intimately mixed so that pockets of cold steam/air mix do not form in the retort and lead to inadequate processing of the cans.

Three major classifications of steam/air retorts may be identified on the basis of methods used to mix and circulate the gaseous media: air makeup, positive flow, and forced convection. In steam/air processing, heat is supplied primarily from the latent heat of condensing steam, in contrast to sensible heat transfer in superheated water systems. As a result, it is essential to have a homogeneous steam/air mixture reaching all product locations. Since air is present during the process, it is unnecessary to purge all the air from the retort by venting prior to the holding period. However, a venting procedure is advantageous for initial heating of the retort shell, retort cars, and product support racks, as well as for providing faster heating to low-viscosity, convection-heating products.

#### 24.4.3.1.2 *Air Makeup Systems*

These are designed such that after the desired temperature and pressure are reached, small valves along the top of the retort are left open to provide continuous venting of the retort during the heating period. The venting results in the pressure drop to less than the set point; this causes an air makeup valve to open to reestablish the retort pressure. As air enters the retort, the temperature tends to decrease; this signals for the addition of steam, which causes a further increase in pressure. Because of the repeated deviation from the temperature and pressure set point conditions, it may be difficult to maintain stable operating conditions using this methodology. Further, the addition of steam and air independently may produce a nonhomogeneous heating medium. In one system, activation of the air makeup valve also activated the steam valve such that steam and air, mixed outside the retort in the pipe connected to the spreader, flowed into the retort in response to a pressure drop; but this also could result in a pressure overshoot.

#### 24.4.3.1.3 *Positive-Flow Systems*

These are designed to improve retort control and stability by controlling pressure and temperature independently. A temperature controller operates a proportional valve on the steam line, adding steam to the

retort and maintaining the set temperature, while a pressure controller for the air inlet and vent lines maintains the retort pressure. Drop in the pressure to that below the set point causes the air supply valve vent to open and the vent valve to close. When the pressure exceeds the set point, the opposite occurs and the retort is vented. During processing, a constant flow of air is added to the retort, thereby causing the pressure to exceed the set point and the proportional flow vent valve to remain partially open during the process. Since steam and air are constantly vented under these conditions, temperature control would require the steam valve to remain partially open. Consequently, a continuous flow of steam and air would pass through the vessel to create a homogeneous mixture throughout the retort.

#### 24.4.3.1.4 Forced Convection Systems

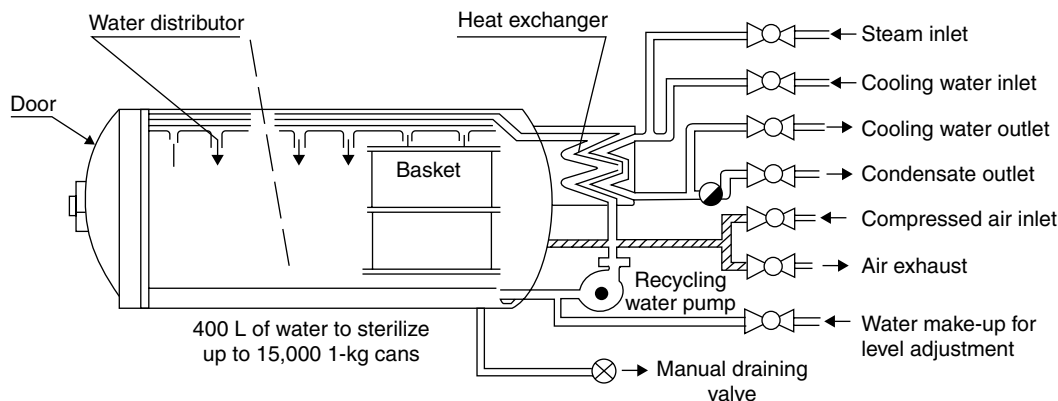
These, in contrast, utilize a powerful fan to circulate the heating medium through the retort and maintain a uniform mixture of steam and air throughout the vessel. During this process, steam is added to replace that which has condensed in heating the load, and, theoretically, after the process is established there should be no need to add air to the vessel until the cooling cycle begins [11].

#### 24.4.3.2 Water Processing Retorts

This system is mainly used for the processing of glass jars. Raining water techniques (Figure 24.3) require the use of either an external steam injection system or heat exchanger system outside the direct environment of the retort. In the latter case, the cold water feeding the system is combined with the recycled heating medium and raised to the temperature required in the retort before being admitted to the sterilization chamber through a spray arrangement. The containers are arranged to allow good contact between the hot water heating medium and the product either using spacer bars or distribution plates. It is imperative that a good distribution of the water occurs, as otherwise stratification may occur and certain containers will receive inadequate heating process. Control of the temperature in this system is difficult, but the safest practice is to base the thermal process received by the product on the outlet temperature of the retort, i.e., the temperature measured in the return line to the heat exchanger [9]. The velocity of water in these retorts when passing over the packages is of vital importance, as this will influence the rate of heat transfer to the product due to its effect on the heat transfer coefficient. This is unlike the saturated steam retort processes where the heat transfer coefficient can be considered infinite [11].

#### 24.4.3.3 Crateless Retort Systems

The vertical retort has grown in size, given up its crates, and become automated. These retorts are large and without crates and have been recognized as a universal symbol of low-acid food processing. They are usually 2.5 m high and 2 m in diameter with four to five times greater capacity than the conventional



**FIGURE 24.3** Water processing retorts. (From Richardson, R.S. and Selman, J.D., *Processing and Packaging of Heat Preserved Foods*, 1st edn., Rees, J.A.G. and Bettisson, J., eds., Chapman & Hall, 1990, p. 50.)

three-basket vertical retort. The crateless retort is filled with water, which acts as a cushion for cans filled from an automatic conveyor. After loading the cans a hydraulic lid is closed. Steam is admitted through the top opening and this forces the water out of the retort through the bottom opening. The hot water can be recycled in another retort or in the next cycle. After processing, cooling water is let in through the bottom and is discharged through overflow. After the cooling cycle, the retort is drained off and the bottom door is partially opened and the cans fall onto a shaker screen and are conveyed by a belt to the unscrambler [13,14]. It is critical that the steam condensate be removed from the bottom of the crateless retorts with top steam entry.

#### **24.4.3.4 Agitating Retorts**

There have been a number of different batch agitating retorts designed to provide product agitation by rotating the containers end over end or side over side. The one most used is the Orbital Rotary Pressure Stabilizer (FMC Corp., Madera, CA), also known as the Orbitort. The unique design of the orbital sterilizers allows for the simultaneous loading and unloading of containers by a reel and spiral assembly. This assembly consists of an inner reel with steps attached to a drum to hold the containers, and an outer reel, which holds a spiral. While the containers are being loaded, the outer reel (spiral) is locked to the shell, and the inner reel is rotated. This allows the containers to be indexed along the steps of the inner reel following the path of the spiral. After loading, the two reels are locked together, holding the containers in place. During the processing cycle, the locked reel assembly and containers are rotated at 15–35 revolutions per minute. Since the inner reel is constructed from a drum, the time required for venting of the orbital sterilizer is greatly reduced because of the reduced volume of air to be removed. Steam enters the shell through a slotted trough at the bottom of the shell, and air is exhausted through five 50-mm-diameter vent pipes located along the top. The retort drain valve is also open during the first portion of the venting cycle for condensate removal. Generally, the venting schedule is completed in 2–3 min [15].

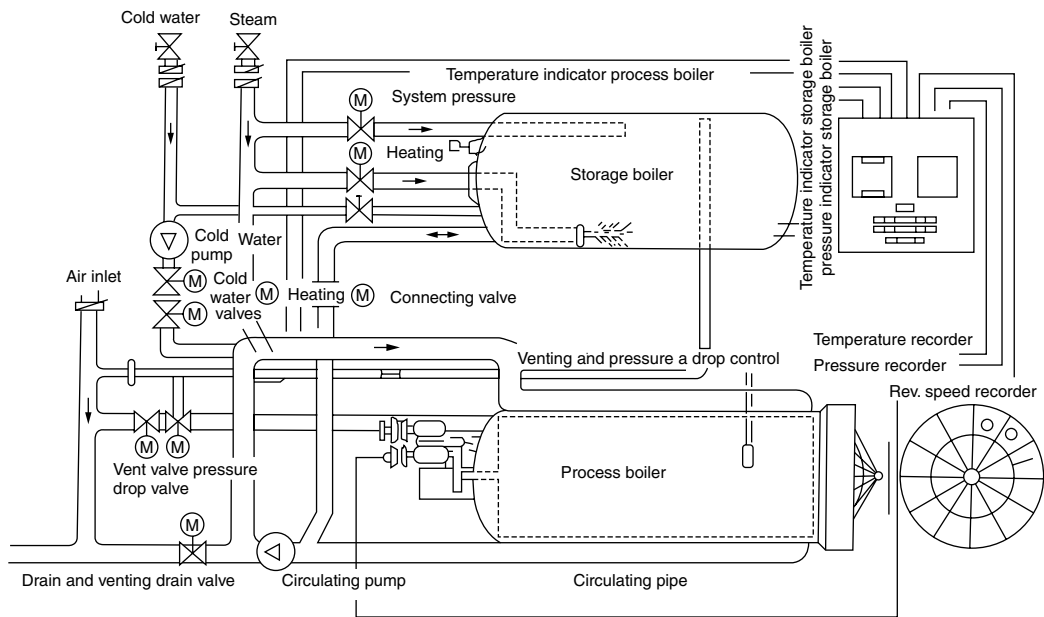
#### **24.4.3.5 Continuous Rotary Sterilizers**

These systems are composed of at least one heating shell and one cooling shell and are designed for continuous handling of containers up to 600 cans/min. Containers from the sealing machine enter the first shell through a self-sealing rotary valve, which maintains the pressure within the shell. Each shell is designed with a “Spiral T” permanently attached to the wall, and a reel assembly with steps to hold the containers. As the reel turns, the containers follow the path of the spiral through the shell. After a container travels the length of the shell, it is either transferred to another shell by a rotary transfer valve or exits through a discharged valve. The venting and come-up procedures are performed without containers present in the vessel. This allows more flexibility in the design of the operating procedures compared to batch systems. Continuous rotary sterilizers are fitted with two or three 50-mm-diameter vent lines. The typical venting schedule calls for venting the units for 7 min and to at least 105°C with the vent valves wide open and the drain valve at least partially open. Alternatively, the air may be removed through the bleeders, drain, and purge lines rather than through the main vent lines. While air removal in this manner does take more time than traditional venting methods, it requires less operator involvement [11].

#### **24.4.3.6 Cascading Water Retorts**

The Steriflow cascading water retorts are designed and manufactured by Barriquand, Paris, France. The company manufactures both stationary and end-over-end rotational systems, and they have been installed internationally for processing foods and pharmaceuticals. Cascading water retorts utilize high-velocity superheated water to sterilize containers of food. Heating and sterilization are achieved by superheated water steaming at a high flow rate over the containers. An overriding air pressure is available for glass jars and flexible and semirigid containers to protect the physical integrity of the container and seal.

A schematic of the retort is shown in Figure 24.4. Water is heated by a welded plate heat exchanger located at the back or along the side of the retort in the middle. On the single-door units, the heat exchanger is located at the end opposite to the door; on the retorts with the door on both ends, the heat exchanger is located on the side of the shell and water enters at the top center of the retort. The superheated water is fed



**FIGURE 24.4** Horizontal circulating water retort. (From Perkins, W.E., *Introductions to the Fundamentals of Thermal Processing*, Sleeth, R.B., ed., IFT, Chicago, November 15, 1979, p. 82.)

into the retort through a distribution manifold. This water is continually recycled through the heat exchanger. In the heat exchanger, steam transfers its latent heat to the internal water, which is then showered from the distribution manifold over the product. The water cascades over the containers, not touching the sides of the shell and only a portion of the shell bottom. Therefore, it is not necessary to heat the entire shell during the come-up time, which can save energy. The same water is successively used for sterilizing and cooling the product. Therefore, the cooling is achieved with sterilized water, which means that chlorine does not need to be added without cooling water.

After passing over the containers, water passes through filters that keep debris, such as pieces of glass or product, from recirculating through the system. Both the water manifold and the filters are designed to be easily cleaned. The water manifold has a hinged gate at the end or ends next to the door, which can be opened and cleaned regularly. Since the opening for cleaning is opposite the water entrance, all debris is pushed to that portion of the manifold. This design is important to prevent the distribution holes from becoming clogged and perhaps reducing the water flow through a portion of the manifold. The bottom filters are also easy to remove and clean.

The first step is usually a preheat step or a tempering step in the case of glass jars. Usually, a certain minimum time is specified to get a more uniform come-up time for each cook. The second step is an overshoot of both time temperatures. This step is inserted to make sure that the mercury thermometer is registering the scheduled temperature at the beginning of the sterilization phase. This step is critical because the controlling probe and the mercury thermometer are not located in the same place; the mercury thermometer lags behind the controlling probe. The third step is the sterilization phase. For this step, it is recommended that the operating temperature be  $1^{\circ}\text{C}$  above the schedule retort temperature. The reason, common to most restarting systems, is to make sure that the mercury thermometer is at or above the schedule retort temperature during the entire sterilization phase. Time, temperature, and pressure are controlled. If the control in temperature drops below the set point, the timer stops until the correct temperature is achieved again. The fourth step is a pressure cool step to protect plastic or semirigid containers from bucking or glass containers from losing their lids during the first few minutes of cooling. The final step is an atmospheric cool. The actual time, temperature, and pressure for each program depend on factors such as the product formulation, container material and shape, entrapped air, product quality considerations, and steam, water, and air supplies [16].



### 24.4.3.7 Rotary, Full, Immersion, Hot-Water Sterilizers

The typical rotary hot-water sterilizer consists of two hot-water drums—the upper (storage) drum and the lower (working) drum. Sterilization of the food takes place in the storage drum after it receives pre-heated hot water from the storage drum. During rotation, cages turn in the same vertical plane within a rotating framework called the “rotor insert.” Containers in the cages travel in end-over-end fashion in the hot water if loaded in a vertical orientation. Over pressure is usually supplied with steam in the storage drum, although steam or compressed air may be used with a slight installation modification.

As thermal energy in the lower drum is given up to the product, cages, and shell during the process, more energy is introduced into the working drum through an external steam mixing or distribution chamber. Steam is injected directly into the system’s circulating hot water from the working drum through a diffuser located within the chamber. There is no direct steam injection into the shell in these units. Water is pulled from bottom or side ports spaced equally along the shell of the working drum, where it is pumped through the mixing chamber for heating. Water travels through top or side water inlet ports into the working drums in a “top-to-bottom” or “side-to-side” circulation pattern. Rotating the cages during come-up, heating, and cooling cycles helps to distribute thermal energy in the system, and reduces the come-up and cool-down cycle times.

Temperature and pressure are independently controlled in these systems. Temperature and pressure sensor connections for the recorder system are located in the thermometer pocket at the horizontal center plane of the working drum. A resistance temperature device (RTD), sometimes referred to as a “PT-100,” is located near the right side of the front end of the storage drum and controls the storage drum water temperature. A second RTD controls temperature in the working drum and is positioned either before or after the mixing chamber in the circulation line or in the mercury-in-glass (MIG) thermometer well. After the heating phase is completed, a portion of the process water is pumped back into the storage drum, where it is heated to the required temperature set point for the next cycle. The circulation pumps are rated at approximately 400 gal/min with a 250 gal/min typical flow rate. The pumps use on/off, proportional valves, and valve actuators on the units [17].

### 24.4.3.8 “Hydrolock” Continuous Cooker/Cooler

Hydrolock is a continuous, agitating cooker/cooler for high-speed short-time sterilization of a wide variety of sizes and shapes of containers. The system is applicable for the processing of cans, glass jars, semirigid plastic and metal containers, and retortable pouches. It is also capable of processing plastic and metal containers with heat-sealed closures [13,18–21]. The basic parts of the system are (Figure 24.5) water lock, cooker/cooler, chain carrier system, cooling system, and water circulating

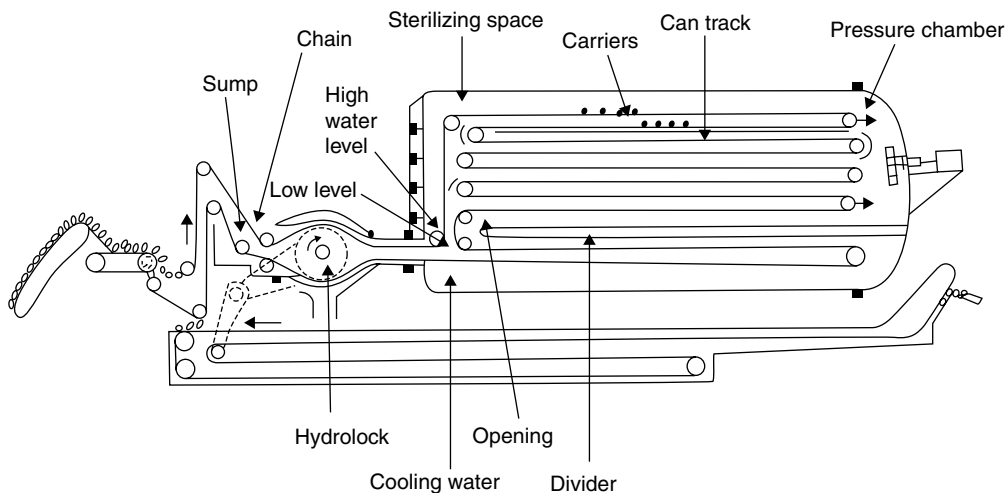
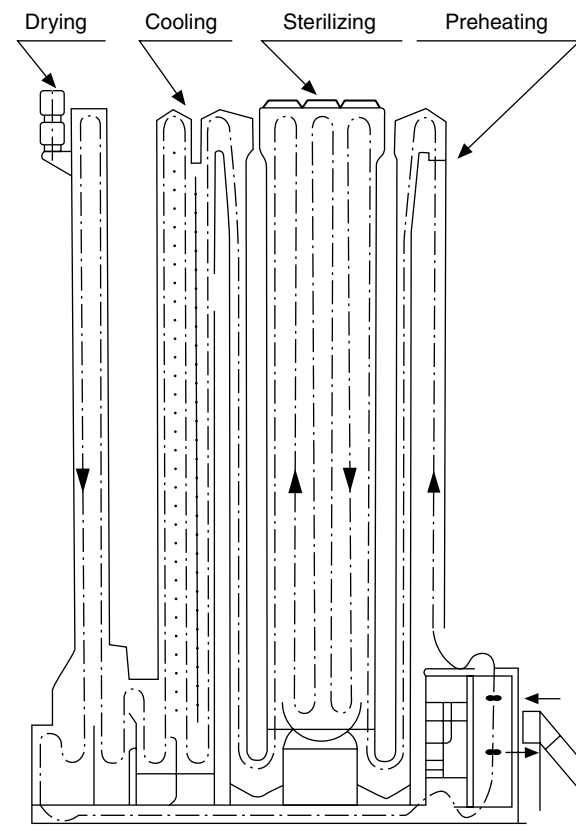


FIGURE 24.5 Hydrolock continuous cooker. (From Brody, A.L., *CRC Food Sci. Nut.*, 2, 187, 1971.)

system. Containers enter and travel through the process between two parallel conveyor chains. These chains enter and leave through water into a rotating pressure lock, sealed partly by water and partly by mechanical means. This facilitates preheating of incoming and precooling of outgoing containers. After loading through the lock, the containers are continuously conveyed through the steam chamber and finally into precooling water in which the conveyor passes. Containers exit through the same rotating pressure lock through which they entered and pass along a cooler conveyor. The hydrolock is equipped to provide overhead pressure during the cooling cycle to retain the container integrity. Final product cooling is completed in two passes of atmospheric cooling below the pressure vessel. Cans roll in shallow water in stainless-steel “pan” being pushed by stainless-steel rods attached at their ends to roller chains. Any heating medium can be used with the system: saturated steam, water, or steam–air mixture. When an overriding air pressure is required, as with glass containers, aluminum cans, plastic containers or flexible pouches, air is mixed with the steam by means of one or more turbo fans, which produce a homogenous mixture of the two gases.

#### 24.4.3.9 Hydrostatic Pressure Sterilizer

This sterilization method is more commonly known as “hydrostatic sterilization” because the steam pressure in these units is maintained by water pressure. Hydrostatic cookers are continuous pressure cookers in which the operating pressure is maintained by water pressure. The schematic of the cooker is shown in Figure 24.6. Hydrostatic cookers have two components: water chambers and steam chambers. The temperature of the steam in the steam chamber is controlled by pressure produced by the water legs and can be regulated by moving the level of water in the leg [13,20,22]. Containers are



**FIGURE 24.6** Hydrostatic pressure sterilizer (internal details). (From Perkins, W.E., *Introductions to the Fundamentals of Thermal Processing*, Sleeth, R.B., ed., IFT, Chicago, November 15, 1979, p. 82.)

conveyed into the cooker through a water leg at 80°C. This is the down traveling water leg and the container temperature begins to increase. As the containers move down this leg, it encounters progressively hotter water. In the lower part of this leg, the water temperature reaches about 100°C and then, near the water seal area next to the steam chamber, the water temperature is about 107°C. In the steam chamber, the can is exposed to a temperature of 115°C–130°C, the steam temperature being set to suit the product undergoing sterilization. Upon leaving the steam chamber, the can again goes through a water seal into water at a temperature of about 107°C where the cooling cycle commences, under pressure.

#### **24.4.3.10 Hydrostatic Helix**

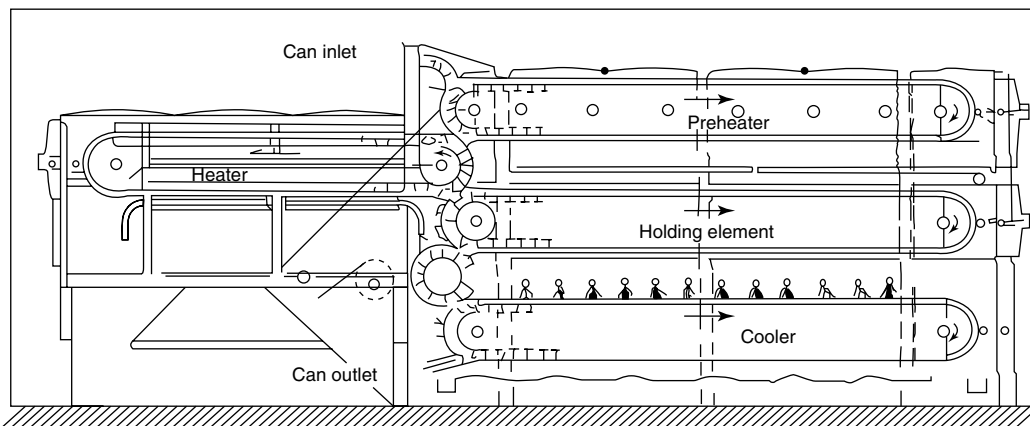
The major advantage of the hydrostatic cooker is its compact size. The hydrostatic cooker has no mechanical valves or locks and thus can be a truly continuous motion retort. The helical pump or hydrostatic helix consists of a rotating coiled tube, in which each turn of the coil is charged at the intake partly with liquid and partly with air. The coil rotates about a horizontal axis. With no pressure at the discharge, the rotating coil may meter liquid at a rate proportional to its rotational speed. With a discharge backpressure, the liquid in each coil turn forms a series of additive hydrostatic legs. The hydrostatic head developed is a function of the number of turns of the helix and the diameter. When the coil is rotated, liquid can enter the coil by gravity flow for one-half turn only, when the first turn (acting as a manometer) is in the upright position. As the coil continues to turn through the next half turn, only air can enter because the manometer is inverted. Thus, equal volumes of liquid and gas are alternately introduced into the helix in a repetitive cycle. The helical pump thus operates with many short columns of gas [23].

#### **24.4.3.11 Continuous Pallet Sterilizer**

Hydrostatic sterilizers, because of their size and complexity of their water recirculation systems, are very expensive to construct and erect [13]. The continuous pallet sterilizer is essentially a continuous vertical retort through which cans are transported on pallets. The feed and discharge of the pallets is affected, without pressure loss, through venting locks. Each filled, unprocessed pallet load is conveyed by a rack and pinion arrangement into the lock. After the outside pressure door of the infeed lock is closed, steam is introduced, first at atmospheric pressure to purge air from the pallet and the chamber and thereafter under pressure to equilibrate the lock with the retort. After the venting–equilibration cycle, the pallet is moved forward until it is at the base of the retort. Pallets slowly ride upward on their four railroad-like wheels. The processed pallets leave the top of the retort through a “let-down” lock. The flexibility of a retort, in terms of the container type, is shared by the continuous pallet retort by virtue of the capacity of a round vessel to withstand much higher pressures than a rectangular hydrostatic sterilizer tower. Hot water sprays, overpressured with air and steam, with superimposed air pressure may be used as the sterilizing media. This equipment can be used for continuous processing of pouches, semirigid aluminum containers, institutional half steam table trays, and glass jars.

#### **24.4.3.12 Flame Sterilizers**

Infrared radiation as an indirect heat source was developed into flame sterilizers/cookers. Flame cookers attempt to increase the temperature differential between the heating source and the food product, and the rate of heat penetration. By increasing the rate of agitation, the probability of burn-on is markedly reduced [14,21,23]. Gas burners at 1100°C provide the heat source to impart the high-temperature short-time effect. The cans are placed in very close proximity (just a few millimeters away) to the burners and are kept in constant rotation, with a temperature differential within can and contents not exceeding 1°C. Thus, even fully lithographed cans may be heated without damage. There is no possibility to impart counterpressure, so cans must be fairly rigid to withstand internal steam pressure. With low viscosity products, extremely high rates of temperature increase (e.g., 0.25°C/s) of contents are possible. The unit depends on continuous axial rotation (about 120 rpm) to move the cans along the burners and obtain the internal turbulence. Some units have a steam preheat section. A schematic of the unit is shown in Figure 24.7 [24]. The steriflame units consist of three sections. The first one is a steam preheater, where the cans are heated to a temperature of approximately 100°C. In



**FIGURE 24.7** Flame sterilizer (longitudinal section). (From Beauvois, M., Thomas, G., and Cheftel, H., *Food Technol.*, 15(4), 5, 1961.)

the second section, the cans roll through a series of open flames at  $1100^{\circ}\text{C}$  produced by specially constructed gas burners. Rolling motion of the cans increases the rate of heat transfer into the whole mass of the food. Next, the cans pass through an intermittently heated burner-holding section for about 4–5 min. Spray cooling follows the heating cycle. Total time elapsed in the cooker is generally less than that required for batch retorting.

#### 24.4.3.13 Fluidized Bed Sterilization

The fluidized bed retort is a cooker in which sand or ceramic pellets are used as the heat transfer medium. The medium is kept hot and fluid by a flame underneath and an air stream. The particles behave much like boiling liquid. Cans move through the bed, meeting the same resistance as they would if the medium were a thick liquid receiving some abrasive effect from the particles [21]. The main advantage of the system is the control of uniform temperature. The process is continuous and several sizes may be sterilized simultaneously. The main disadvantages are the possibility of burning and discoloration of the can surface and damage of the can seals.

#### 24.4.3.14 Hot Sterilization

Hot air with very high velocity (approximately 600 m/min) is employed to decrease the thickness of the nonturbulent air layer adjacent to the can surface. High-velocity air in excess of  $150^{\circ}\text{C}$  also creates a large temperature differential between the surface and the contents. Cans are axially rolled through to create forced convection within the can contents, thus reducing the possibility of burning or overcooking [14].

### 24.4.4 Temperature Distribution in the Retort Systems

Numerous critical tests must be performed to properly establish commercial sterility processes for any retorting application. The establishment of the “scheduled” (i.e., commercial sterility) process by a process authority depends not only on the ability of the food processor to properly control critical factors that relate to the preretort preparation of the product and the package in which the food is to be sterilized but also on those factors that specifically relate to the delivery of the thermal process to the packaged food. The manner in which the sterilizer is designed, installed, and operated is of critical importance. Failure to address these concerns will have direct and significant impact upon the lethality (sterilization value) designed into (and actually obtained in) the process. The FDA not only requires that temperature distribution tests be performed but also expects that certain data be collected and procedures followed. In addition, FDA [21CFR113.4 (b) (10) (i)] and USDA [9 CFR 318(381). 305(C)(2)(x)] regulations require that these data be evaluated by a “recognized competent process authority.”

The traditional means by which acceptable process delivery conditions are verified is to use thermocouples, RTDs, or thermostats to generate time–temperature histories at preassigned strategic locations inside the sterilizer. These data are collected from “zero time” (when the heating medium first contacts the containers in the working drum) until a “to-be-determined time” at which all temperature-measuring devices meet the readings after sterilizer temperature indicating and recording devices. Most importantly, the time at which the lowest temperature lead meets the true “set point” temperature of the control program is critical. This exact time–temperature condition is the traditional process calculation reference point from which process hold times are determined. The “official reference instrument” against which all other sterilizer temperature control devices are adjusted is the MIG thermometer. All thermocouple lead readings must be able to compare to the MIG thermometer readings. Temperature distribution is, then, the uniformity of sterilizer temperatures and the stability of sterilizer temperatures at any given time during the entire process cycle, including the come-up, holding, and cooling phases.

Temperature distribution in batch, rotary, or hot-water sterilizers is affected by numerous conditions and system features. (i) Product initial temperature: lower initial temperatures usually lengthen retort come-up time and worsen temperature uniformity and stability. (ii) Storage drum temperature: the storage drum temperature is usually programmed to be 15°C–20°C above the targeted control set point in the working drum. If the hot-water drop temperature is too high, some semirigid and flexible containers may be damaged and the temperature gradients between the outside and the inside of the container cage position can become excessive. If the hot-water drop temperature is too low, too much heating in the working drum will then occur, which creates wide temperature gradients. (iii) Working retort venting: venting the working retort for too long in sterilization removes excessive energy from the system, extends come-up time, and forces more mixing chamber steam injection during the come-up phase. Too short venting time does not allow the storage drum/working drum filling step to occur properly and causes pressure control problems in the working retort. Ideally, a venting time of approximately ½ min/cage is appropriate (i.e., 2 min for a 4-cage 1100 mm unit). (iv) Working retort RTD location: the control RTD may be located before or after the mixing chamber in the water circulation line. When the RTD is located after the mixing chamber, the control device measures the hottest water in the circulation system; this results in less aggressive steam valve response and a slower but smoother ramp to temperature in the come-up phase. If the RTD is located before the mixing chamber, the control device measures the coldest water in the system, and the steam valve to the mixing chamber experiences a “response lag” by being fully open for too long. This causes a temperature overshoot at the end of the come-up period. (v) Container type and geometry: low-profile containers (cans, pouches, plastic trays, or bowls) must be filled into racking systems, which may create a considerable number of cage layers. Increased layers create increased resistance to heating medium flow. Generally, fully loaded large cylindrical containers exhibit shorter come-up time and improved temperature uniformity in all process phases. (vi) Container handling system: the cages, dividers, and racks for handling the containers must be designed to provide maximum cross-sectional open area (CSA) created by slots or perforations in the sides and bottoms of the cages. Spacer mats or divider sheets between layers of containers must be designed for maximum open area to enhance water flow past container surfaces. (vii) Rotational speed: generally, as rotational speed increases come-up time decreases and temperature uniformity and stability improve. (viii) Number of cages: the larger the unit and the greater the number of cages, the slower the come-up time and the greater the temperature differences throughout that the drum must be overcome. (ix) Retort design and operating environment: regardless of the retort manufacturer, it is advisable to perform temperature distribution studies in each batch, full-immersion, rotary hot-water retort. Design modifications, valve settings, blocked ports, and the number of retorts operating simultaneously in conjunction with other steam demand in the plant will affect test results and should be monitored closely. Rotary retorts to be added to an existing line must also be tested for temperature distribution [17].

#### **24.4.5 Exhausting**

The exhausting of containers for the removal of air should be controlled to meet the conditions for which the process was designed. Vacuum in canned foods may be obtained by preheating foods prior to closing. In producing vacuum by this means, the product may be heated prior to filling, or it may be heated both

before and after filling. Heat in this case is employed to expand the product, expand and drive out the occluded and dissolved gases in the product, and reduce the air in the headspace before closure. The length of heating and the final temperature attained before closure has a very important relationship to the ultimate vacuum in the can. Heating may be accomplished by passing the filled can through a steam or hot-water exhaust box. It is common to refer to exhaust box treatment as “thermal exhaust” and to preheating before filling as “hot fill.” Exhaust boxes are generally best adapted for canned foods that can readily be heated, such as brine- and syrup-packed fruits and vegetables. The major disadvantages of exhaust boxes are in their bulkiness and their large steam requirements. In mechanical vacuum closure by high-speed vacuum-closing machines, the filled cans while cold or at a rather low temperature are passed into a clincher, which loosely clinches the covers without forming an air-tight seal. The cans are then transferred through a suitable valve into a vacuum chamber, subjected to vacuum for a while in the vacuum chamber, sealed, and then ejected through another valve. Vacuums drawn on the machine while the cans are in the vacuum chamber may be varied over a wide range, depending mainly on the desired final vacuum in the can and also on the temperature of the liquid contents. This method of exhausting air from canned foods subjects the contents to a vacuum for a rather short interval of time before closure. Therefore, the air is withdrawn mainly from the headspace and only partially from the product itself, and proper adjustment of the headspace is necessary for proper performance.

#### **24.4.6 Quality of Canned Foods**

##### **24.4.6.1 Plant Origin Foods**

The purpose of heat sterilization is to extend the shelf life of foods while minimizing the changes in nutritive value and eating quality. Differences between the heating characteristics of microorganisms, enzymes, and sensory or nutritional components of foods are exploited to optimize processes for the retention of nutritional and sensory qualities. This is achieved in practice by a reduction in size or cross-sectional area of containers, agitation during processing, or aseptic processing. The extent of thermal processing, which a food receives, is dependent upon the composition and physical characteristics of the product and is the result of a combination of time and temperature. Physicochemical changes occurring during processing and storage are the factors that determine the product quality in terms of both its sensory properties and its provision of nutrients to the consumer. Reactions take place during both the process itself and on subsequent storage. Generally, the changes that occur during storage are slow, particularly when compared with those occurring in an equivalent unprocessed material, and it is on this basis that heat preservation is effective in providing materials outside their normal seasons and in a conveniently prepared, often formulated, form ready for consumption or reheating and then consumption. The physical and chemical reactions that occur during processing can be desirable or undesirable, and are often more significant and certainly occur much more rapidly than those during storage. The degree of heat processing varies according to the product. In turn, the changes that occur on processing are influenced by the time and temperature of the process, the composition and properties of the food material [25], and its environment [26].

##### *24.4.6.1.1 Sensory Quality*

The heat process itself has a major effect upon the quality of a food product and is responsible for a range of changes taking place. Starch gelatinization and structural protein denaturation have a direct influence on the texture of a food. Heat-induced reactions such as the Maillard reaction affect the color and flavor as well as the nutritional status of the food [27,28]. In general, changes that occur before the heat process are less important than those during or after processing since it is the manipulative and thermal procedures of food production that have the greatest effect on tissue damage and the resultant mixing of cell contents from different materials.

##### *24.4.6.1.2 Texture*

The tissue damage that occurs during the heat process of plant material is of two types. These are destruction or damage to the semipermeable cell membranes, and disruption of the intercellular structures with resultant cell separation [29]. The effects of these types of tissue damage are a loss in cell

turgor and cellular adhesion, which give rise to loss of crispness and softening of the heat-processed product. Other major influences on the texture of heated foods arise from the denaturation of proteins. Even on relatively mild heating, conformational change affecting the tertiary structure of protein can be observed [30]. Denaturation of the proteins may follow. The hydrogen bonds maintaining the secondary and higher structure of protein rupture and predominantly random coil configuration occur [31]. This leads to considerable changes in chemical and physical properties of proteins due to losses in solubility, elasticity, and flexibility [30,32]. This mechanism also causes enzyme inactivation and breakdown of proteinaceous toxins and antinutrients. They cause turbidity leading to either a precipitate or gel, which will greatly alter their water-holding capacity and also lead to increased thermal stability [33]. In fruits and vegetables, softening is caused by hydrolysis of pectic materials, gelatinization of starches and partial solubilization of hemicelluloses, combined with a loss of cell turgor. Calcium salts may be added to blanching water or to brine or syrup, to form insoluble calcium pectate and thus increase the firmness of the canned product. Different salts are needed for different types of fruit (for example, calcium hydroxide for cherries, calcium chloride for tomatoes, and calcium lactate for apples) owing to differences in the proportion of demethylated pectin in each product.

#### 24.4.6.1.3 Color

The color of a food product is determined by the state and stability of any natural or added pigments, and development of any coloration during processing and storage. Natural pigments are generally unstable compounds that are broken down on heating but whose stability is dependent upon many factors. In fruits and vegetables, chlorophyll is converted into pheophytin, carotenoids are isomerized from 5,6-epoxides to less intensely colored 5,8-epoxides, and anthocyanins are degraded to brown pigments. Anthocyanins are fairly heat-stable compounds but take part in a wide range of reactions, e.g., with ascorbic acid, sugar breakdown products, such as hydroxymethyl furfural, and other reactive phenolics, which bring about their breakdown [34]. Factors that accelerate degradation include high levels of oxygen in the product and storage temperature. Conversely, anthocyanins can be undesirable in a product and can be produced on thermal treatment of leucoanthocyanidin [35,36]. They give rise to defects such as very dark broad beans and red gooseberries. Other problems can occur with anthocyanin pigments due to the formation of metal complexes, for example, the bluing of red fruits and the pinking of pears when exposed to tin [37,38]. The flavonoid rutin, present in asparagus, can also form a complex with iron causing dark discoloration in lacquered cans where iron dissolution can occur [39] and in which the colorless tin complex is not formed.

Carotenoids are mostly fat soluble and are responsible for yellow, orange, and red coloration. They are unsaturated compounds and are therefore susceptible to oxidation, giving rise to off-flavor and bleaching. In addition, two types of isomerization can occur, namely, *cis-trans* isomerization and epoxide isomerization, which can give rise to lightening of the color. The temperature of storage is considered to have a greater effect on the isomerization than on the heat process itself. The two major groups of porphyrin-based pigments are chlorophyll and the heme compounds, both of which are very sensitive to heat. On processing, chlorophyll is converted into pheophytin with an associated loss of green color [39]. Several approaches have been taken to try to reduce the color loss such as adjusting the pH [40,41] and the use of HTST treatments. In the latter case, although improvements were observed after processing these were lost during storage [42].

Betalins are water-soluble pigments, which are susceptible to oxidation and loss of red color. Browning of heat-preserved beetroot products is an example where residual oxygen in the product or headspace causes the appearance of a chocolate brown color. Heat processing itself in the presence of oxygen has a major effect on the end product quality, and this is demonstrated by the comparison of products packed in plain tin-plate cans with the identical material processed in lacquered cans or glass jars. In the plain tin-plate container, dissolution of the tin during processing removes a major proportion of oxygen from the pack and little is available to react with the food. Some products such as pale fruits, tomatoes and tomato formulations, mushrooms, and milk products are particularly susceptible to such heat-induced oxidative changes. It has been demonstrated that a brownish color develops in beans dipped in tomato sauce packed in different container types [43]. Ascorbic acid is often used as an antioxidant and can be effective in improving color in certain products, e.g., mushrooms. It can be degraded to produce reactive compounds, which further react to form brown pigments.

#### 24.4.6.1.4 Flavor

Generally, heat preservation does not significantly alter the basic flavors of sweetness, bitterness, acid, or salt. In fruits and vegetables, changes are due to complex reactions, which involve the degradation, recombination, and volatilization of aldehydes, ketones, sugars, lactones, amino acids, and organic acids. Major changes can occur in the volatile flavor components. One of the most important sources of volatile is lipid oxidation or oxidative rancidity. Three stages are involved: (i) initiation; (ii) propagation in which highly reactive hydroperoxides are formed, and (iii) termination. The initial uptake of oxygen is in the presence of catalyst, such as metal ions or metalloproteins, but can also be brought about by heat or light. The reaction does, however, have low activation energy (4–5 kcal/mol). The hydroperoxides formed take part in secondary reactions to give rise to a range of volatiles including aldehydes, ketones, and alcohols and it produces typical rancid or stale off-flavors.

Volatile flavor compounds are also produced via the Maillard reaction. Since the first scheme for the reaction was put forward [44], a great deal of research has been undertaken. The reaction occurs during heating and extended storage, is influenced by water activity, with an optimum for flavor generation at intermediate values of around 30% water [45], and is accelerated by high pH and buffers such as phosphates and citrates [46]. The first stage of the reaction is fairly well defined and involves the condensation between carbonyl groups of the reducing carbohydrates and the free amino acids or protein, and rearrangement to produce amatory compounds. This leads to a loss of protein nutritional quality but does not affect the sensory properties significantly [47]. The second stage is very complex and gives rise to numerous products, many of them volatile and is responsible for many characteristic flavors and off-flavors in food materials. Loss of volatile constituents can also present problems in heat-preserved foods. The breakdown of essential oils in citrus products can result from oxidation. Packaging can also have a direct influence on volatile scalping.

#### 24.4.6.1.5 Nutrients

Both physical and chemical reactions occur in heat-preserved foods, which influence nutritive value (Table 24.1). Physical factors such as the loss of soluble nutrients, or leaching, can be significant for

**TABLE 24.1**  
Effect of Heat Processing on Major Nutritional Components

Nutrient	Effect
Dry matter	Loss of total solids into canning liquor Dilution Dehydration
Protein	Enzymic inactivation Loss of certain essential amino acids Loss of digestibility Improved digestibility
Carbohydrate	Starch gelatinization and increased digestibility No apparent change in content of carbohydrate
Dietary fiber lipids	Generally no loss of physiological value Conversion of <i>cis</i> -fatty acids to <i>trans</i> by oxidation Loss of essential fatty acid activity
Water-soluble vitamins	Large losses of vitamins C and B, due to leaching and heat degradation Increased bioavailability of biotin and niacin due to enzyme inactivation
Fat-soluble vitamins	Mainly heat stable Losses due to oxidation of lipids Losses due to leaching
Minerals	Possible increase in sodium and calcium levels by uptake from canning liquor



products in which there is a carrying liquid discarded before consumption. Chemical reactions include heat damage to labile nutrients such as vitamins. One of the most fundamental changes, which can occur in a heat-preserved product, is the movement of water and solids within the food material during processing, storage, and reheating. In a formulated product or a product in which the entire pack contents are consumed, such changes can be largely disregarded, from the nutritional point of view, in that they do not alter the total amount of the nutrients consumed. Products that are packed in liquor, which is discarded before consumption, often exhibit dilution, dehydration, or loss of total solid materials from the edible portion. Sterilized soya-meat products may show an increase in nutritional value owing to an unidentified factor that decreases the stability of the trypsin inhibitor in soybeans.

**24.4.6.1.5.1 Proteins** Heat preservation can lead to both desirable and undesirable changes in the nutritive quality of proteins. They are susceptible not only to heat but also to oxidation, alkaline environment, and to reaction with other food constituents such as reducing sugars and lipids oxidative products. The total amount of crude protein, generally, appears relatively unchanged due to heat processing [48,49] but can suffer from leaching into the liquid component of some products [50]. The crude protein levels, however, appear to be stable during subsequent storage of canned vegetables [48,49]. The changes occurring are associated with tertiary structure, functionality, chemical changes related to digestibility, and amino acid availability. Canning of potatoes also leads to loss of amino acids though this has been shown to vary depending on the specific gravity of the potato [51]. Lysine is again particularly vulnerable with a reduction in its availability of about 40%. Some of the losses found in canned potatoes may be due to the leaching of the protein into the brine [50], although the major cause of loss of amino acids on heat preservation is the Maillard reaction. Soybeans and many other legumes also undergo improved protein digestibility and bioavailability, especially of the sulfur-containing amino acids on heating due to inactivation of trypsin inhibitors and unfolding of the major seed globulins.

**24.4.6.1.5.2 Vitamins** The effect of heat preservation on vitamins is generally detrimental although mild heating conditions can have beneficial effects on the bioavailability of certain vitamins, particularly biotin and niacin. This is due to enzyme inactivation and the inactivation of binding agents [52]. The stability of vitamins varies under different conditions with vitamin C and thiamin being most susceptible to degradation through heating. The fat-soluble vitamins are the more stable of the two sets, although these can be degraded by oxidation especially when heated. Loss of water-soluble vitamins during processing can be considerably higher. Vitamin C is the most labile of the vitamins and can be lost during storage of the fresh material, food preparation, washing, and blanching as well as by degradation on heating and leaching into a carrying liquor during the process. Studies on garden peas and carrots have shown that as much vitamin C can be lost on storage of the fresh produce for 7 days prior to cooking as that lost on canning. Much of the vitamin C lost during canning is leached into the canning liquor. Thiamin is the most heat sensitive of the B vitamins especially under alkaline conditions, and it is also susceptible to leaching during any washing or blanching stages. Thiamin, however, is less labile than vitamin C and retention of 60%–90% is usual in canning [53]. Folic acid and pyridoxine are also susceptible to degradation by heating and in the case of folic acid by oxidation. Canning of potatoes can lead to loss of vitamins up to 30% [54]. Both Riboflavin and niacin are relatively stable on heat preservation although riboflavin is very sensitive to light and will undergo degradation in the presence of both heat and light together [55]. Heat-preserved foods often require less cooking than fresh foods, and the differences in the vitamin content between the fresh and the processed food at the point of consumption can often be negligible. In canned fruits and vegetables, significant losses may occur in all water-soluble vitamins, particularly ascorbic acid/vitamin C.

**24.4.6.1.5.3 Minerals** Minerals are generally stable to most of the conditions encountered in heat preservations i.e., heat, air, oxygen, acid, or alkaline. Losses of minerals, however, can occur during processing, especially of vegetables, due to leaching into canning liquor. Conversely, certain minerals, for instance, sodium and calcium can be taken up by the food from the cooking or canning liquids.

Comparisons between fresh and canned vegetables have shown higher ash content in canned products in all cases. This is due to the uptake of sodium and to lesser extent of calcium from the brine. Between 15% and 50% of potassium can be lost primarily by leaching on the canning of vegetables. Slight leaching of zinc and negligible changes in iron content occurs during processing. Heating has been seen to increase the bioavailability of iron in spinach and the presence of fructose also leads to an increased iron bioavailability [56].

**24.4.6.1.5.4 Carbohydrates** Carbohydrates are less susceptible than most other food compounds to chemical changes during heat preservation. The levels of total and available carbohydrates in vegetables have been found to be very stable on canning and subsequent storage of the canned vegetables. However, there are some effects of heat on various carbohydrates. The effect of sugar on protein and iron bioavailability, and the relationship between starch, texture, and palatability are more important. Gelatinization of the starch also aids digestibility of foods. A good example of this [54,57] is the potato, which in raw state is largely indigestible. The exact effect of heat preservation on various types and constituents of dietary fiber has not been fully investigated. Cellulose, the main constituent of dietary fiber, hemicelluloses, and pectins are together responsible for structure and texture in plant foods [58,59] and can be disrupted by heating, which leads to a softening of the food and increased palatability as discussed earlier, generally, without any loss in the physiological value of the dietary fiber. Overheating can lead to a breakdown in the cells, enabling water-soluble nutrients, for instance, certain minerals, vitamins, and pectins to be leached out. Although dietary fiber is considered to be largely unaffected by heat processing, the exact relationship between time–temperature conditions, dietary fiber breakdown, and the extent of nutrient loss due to fiber breakdown requires further study.

**24.4.6.1.5.5 Lipids** Lipids, especially the unsaturated lipids, are prone to oxidation when heated in the presence of air or oxygen, resulting in losses in nutritional value of the food product. Although the major effect of lipid oxidation is in the flavors of foods, oxidation can lead to a conversion of the natural *cis*-fatty acids to *trans*-fatty acids [56]. The digestion and absorption of *trans*-fatty acids is comparable to that of the *cis*-fatty acids and their nutritional value as an energy source is not affected. However, *trans*-fatty acids do not generally possess essential fatty acid activity, i.e., as precursors of prostaglandins and thromboxanes. This activity is dependent on a *cis* 9, *cis* 12 methylene interrupted double bond system, but provided that sufficient linoleic acid is consumed, the *trans*-fatty acids do not appear to inhibit essential fatty acid metabolism [60,61]. The oxidation of lipids has also been implicated, as previously noted, in the loss of protein quality and can inhibit the activity of the fat-soluble vitamins A, D, and E as well as vitamins C and foliate. The oxidation of fats in processed foods, however, can be controlled by the exclusion or minimization of oxygen and the use of antioxidants. The effects of heat preservation on the nutritional value of fats can therefore generally be considered as negligible.

## **24.4.6.2 Animal Origin Foods**

### **24.4.6.2.1 Color**

The time–temperature combinations used in canning have a substantial effect on most naturally occurring pigments in meat foods. The red oxymyoglobin pigment is converted into brown metmyoglobin, and purplish myoglobin is converted into red-brown myohemichromogen. Maillard browning and caramelization also contribute to the color of sterilized meats. However, this is an acceptable change in cooked meats. Sodium nitrite and sodium nitrate are added to some meat products to reduce the risk of growth of *C. botulinum*. The resulting red-pink coloration is due to nitric oxide myoglobin and metmyoglobin nitrite. Loss of color is often corrected using permitted synthetic colors.

### **24.4.6.2.2 Flavor and Aroma**

In canned meats, there are complex changes (for example, pyrolysis, deamination and decarboxylation of amino acids, degradation, Maillard reactions and caramelization of carbohydrates to furfural and

hydroxymethylfurfural, and oxidation and decarboxylation of lipids). Interactions between these components produce more than 600 flavor compounds in 10 chemical classes [62,63]. Other volatiles have been identified as having a significant effect on the flavor of foods, and perhaps one of the most dramatic is the development of “catty taint.” This is an extremely unpleasant and potent odor produced by the reaction of unsaturated ketones, notably mesityl oxide, with natural sulfur-containing components of the food [62,63]. Heating is essential in the formation of the taint and incidents have been widespread due to the diverse availability of the unsaturated ketones. Examples include processed meat products using meat from cold store, painted with a material containing mesityl oxide as a solvent contaminant [64], canned ox tongues, which had been hung on hooks coated with a protective oil [65], and pork packed in cans with a side seam lacquer, which had been dissolved in impure solvent [65,66].

#### 24.4.6.2.3 *Texture*

In canned meats, changes in texture are caused by coagulation and a loss of water-holding capacity of proteins, which produces shrinkage and stiffening of muscle tissues. Softening is caused by hydrolysis of collagen, solubilization of the resulting gelatin, and melting and dispersion of fats through the product. Polyphosphates are added to some products to bind water. This increases the tenderness of the product and reduces shrinkage. Small changes in the viscosity of milk are caused by modification of K-casein, leading to an increased sensitivity to calcium precipitation and coagulation.

#### 24.4.6.2.4 *Nutrients*

Canning causes the hydrolysis of carbohydrates and lipids, but these nutrients remain available and the nutritive value of the food is not affected. Proteins are coagulated, and in canned meats, losses of amino acids are 10%–20%. Reductions in lysine content are proportional to the severity of heating, but rarely exceed 25%. The loss of tryptophan and to a lesser extent, methionine, reduces the biological value of the proteins by 6%–9%. Vitamin losses are mostly confined to thiamin (50%–75%) and pantothenic acid (20%–35%). However, there are large variations owing to differences in the types of food, the presence of residual oxygen in the container, and methods of preparation (peeling and slicing) or blanching. In some foods, vitamins are transferred into the brine or syrup, which is also consumed. There is thus a smaller nutritional loss. Heat sterilization of meat leads to a reduction in digestibility of the meat proteins and damage of amino acids, especially the essential sulfur-containing amino acids and lysine, with 10%–15% losses in beef [67]. The heat preservation on the quality of foods has two important effects. (i) Many of the changes (sensory or nutritional) that occur during the thermal process are not restricted to heat-preserved foods. In many instances, the process replaces the conventional cooking, which the food receives prior to consumption. Reheating the heat-preserved food is a relatively mild treatment, which does not significantly affect the quality. (ii) heat-preserved foods provide the consumer a wider choice of sensory experience and nutritional requirements without constraint of seasonality and the burden of preparation.

### 24.4.7 **Packaging of Canned Foods**

Under the regulations, “hermetically sealed container” means a container that is designed and intended to be secure against the entry of microorganisms and maintain the commercial sterility of its contents after processing. The container is an essential factor in the preservation of foods by canning. After canned foods are sterilized, it is the container that protects the canned food from spoilage by recontamination with microorganisms. It is then most important for the success of the canning operation to use good-quality, reliable containers and properly adjusted closing machines. Thus, the seams and closures produced will be within the guidelines necessary to prevent access to microorganisms into the container during the cooling operation and during the shelf life of the product.

#### 24.4.7.1 *Tin-Plate Cans*

Today the choice is from among [21]: (i) tin-plate body and ends, (ii) tin-plate body and one end, aluminum convenience end, (iii) three-piece aluminum can (rare, but available and used, with adhesive side seam, for alcoholic cocktails), (iv) tin-free steel with tin end, tin-free steel end, aluminum end, or a combination,

(v) tin-free steel body, (vi) adhesive joined side seam, (vii) welded side seam, (viii) draw and iron two-piece aluminum can, (ix) conventional top chime, (x) neck-in top flange so that chime is flush with body, (xi) draw and iron two-piece steel cans not commercially available except in small sizes for aerosol cans.

#### 24.4.7.1.1 *Two-Piece Cans*

All the major and secondary can making and can-handling equipment manufacturing firms produce two-piece draw and iron can. One of the significant commercial cans is a very small 28–57 g (1–2 oz.) unit. It is evident that a two-piece steel can would eliminate the long seam and one double seam, and thus preclude two sources of potential leakage. The amount of metal used would be reduced below that used for a three-piece. Two-piece steel cans offer the advantages of a two-piece aluminum can at a lower price [21].

#### 24.4.7.1.2 *Three-Piece Cans*

Three-piece “sanitary cans” consisting of a can body and two end pieces are used to seal heat-sterilized foods hermetically and also for other food products such as powders, syrups, and cooking oils. Presently, the three-piece cans are being widely used, and other cans such as two-piece cans, aluminum cans, and other flexible containers are slowly replacing them [21].

#### 24.4.7.1.3 *Aluminum Cans*

The main application of aluminum cans is where inherent advantage can be realized over the tin plate such as lower shipping expense, freedom from food and can black-sulfide discoloration or rust, easier puncture opening, and where special easy opening features are desirable [21]. Steel cans are so well established in the canning industry that exceptionally good reasons are required before a change of material is contemplated. The future use of aluminum for cans, for processed food use, to a great extent depends on the price at which it may be sold to the users, relative to that of an equivalent steel can. Aluminum cans offer advantages of product quality and economy for the canning of certain food products. The use of easy-open lids is also a significant point, which has a strong appeal. Aluminum cans do not rust and their appearance, always bright, can be an important sales argument. An important advantage of aluminum cans is that they are lead free. Nevertheless, aluminum cans dent easily, abrade, and are not interchangeable with steel cans.

#### 24.4.7.1.4 *Collapsible Tubes*

Aluminum may also be used in the form of collapsible tubes for packaging processed food products. Sterilized foods packaged in collapsible tubes for the feeding of astronauts and high-altitude aviators have been developed. The aluminum tube fitted with a hollow handled plastic spoon, which can be attached to the neck of the tube, should make a desirable and convenient package for feeding infants or bedridden patients [21].

#### 24.4.7.1.5 *Composite Cans*

Another development is the foil/fiber can, more commonly called the composite can. It was used earlier for refrigerated biscuit dough. This material is now being used for frozen concentrated orange juice. The composite spiral can made of fiber/polyethylene/aluminum foil and has the major share of the juice and juice drink frozen concentrate canning. Composite cans have been successfully employed for shortening and with polyvinylidene chloride coating for vacuum packaging of roasted and ground coffee. There has been considerable publicity on the use of composites, for beer, hot fills, pasteurized, and even retorted foods [21].

### 24.4.7.2 *Glass Containers and Metal Closures*

#### 24.4.7.2.1 *Containers*

The chemical and physical properties of glass make it an ideal container material for canned foods. It is a chemically stable material. However, in long-term storage against aqueous solutions, and most particularly against acid foods, a very small amount of alkali may extract from the glass, and in some instances, lesser

amounts of SiO<sub>2</sub> or silica. These materials are commonly found in all food products; therefore, the glass container is considered quite inert and is nonadditive in the packaging of most, if not all, food products. It does not support or facilitate microbial growth on its surface, and like metal it is impermeable to gases, liquids, bacteria, and odors. One very apparent characteristic of the glass container is its transparency. While the visibility of the product contained is attractive to the consumer, it does impose restrictions on the canner as to the appearance of the product [68]. Commercial glass jars are formulated and designed to withstand the thermal shocks normally encountered in the canning process. The maximum temperature shock as measured by the temperature differential is generally 45°C. However, they can withstand wider temperature differentials, but under certain conditions. They are also designed to resist the mechanical shocks normally encountered in a well-designed and, maintained filling and packaging line. Their resistance to vertical pressure allows the application of various capping methods and stacking [68].

#### 24.4.7.2.2 *Metal Closures (Caps)*

The various metal closures that are used in food canning are [68]: (i) twist-off or Eurotwist, (ii) Eurocap and EurocapX, (iii) pry-off, (iv) press-twist (PT), and (v) deep-press (DP). The metal closure along with the sealant is designed specifically for each type of glass finish to permit the attachment of a proper seal and efficient closure. For shipping and storage, the nonstackable caps are packed in bulk in cartons, with or without plastic liners, and the stackable caps in overwrapped rolls. The cartons are palletized and either shrouded or strapped. Each carton should be labeled to identify the contents and manufacturing lot. Staples should not be used to close the cartons because they may contaminate the closures [68].

#### 24.4.7.3 *Retortable Pouches*

Thermally processed laminate structures are made out as retortable pouches. Shelf life, toughness, resistance to puncture, and ability to withstand high temperature are some of the important characteristics for selecting materials for flexible containers. The retort pouch was designed to be a package that would offer the shelf stability of canned foods with the quality of frozen foods. The material configuration of this package has been enhanced over the past several years to bring the pouch even closer to this goal. Typically, the retort pouch consists of a 0.5-mil polyester film laminated to 0.000035 or 0.0007 in gauge aluminum foil. This is in turn laminated to a 3-mil modified polypropylene film. Each of these three substrates plays an important role in finished package [69]. On the outside, the polyester provides toughness, abuse resistance, and printability. The package can be printed with colors ranging from a simple one with two color instructions to full-color vignettes of the food product. The actual printing is applied to the “reverse” side of the polyester film, trapping the inks between laminates to protect against scuffing. In the middle, the aluminum foil is the key to the retort pouch’s being a completely shelf-stable food package, with no expensive freezing or refrigeration required. Aluminum is the lowest cost barrier to light, moisture, oxygen, and microorganisms. On the inside, the polypropylene film performs two important functions: first, it is inert and does not react with food, so that virtually the entire range of processed foods can be packaged in this one basic material. Second, it provides exceptionally strong heat seals that can withstand the pressure and temperature demands of retorting and contribute to a shelf life at least equal to that of cans [69].

##### 24.4.7.3.1 *Advantages of the Pouch*

The retort pouch is an integral component of the food distribution system with food product quality and package convenience. The thin profile and increased surface area of the retort pouch permit rapid heat penetration and much more efficient processing than with cans. Typical time savings in the cook cycle of a retort process are up to 40%. This reduction in heat exposure results in improved food product quality—better taste, color, and texture than similar products processed in cans. There is also a potential for nutritional advantage as well, particularly where heat-sensitive nutrients are concerned. Packing a food in the retort pouch results in better-tasting product [69].

##### 24.4.7.3.2 *Advantages to the Consumer*

From the consumer’s viewpoint, the retort pouch is certainly the most convenient food package. Completely shelf-stable, retort-pouched foods may be stored in the cupboard along with other dry

goods. Foods packed in retort pouches are sterilized and are ready to eat. Foods may be heated to serving temperatures before consumption. This can easily be accomplished by heating in boiling water for about 5 min. In this manner, a variety of foods may be conveniently prepared at the same time, with no messy pots and pans to scrub. With the advent of the microwave oven, the true convenience of food preparation in boiling water is now less utilized. All that boiling water does to a retort-pouched food product is heat it; since the temperature of the boiling water is reasonably constant, the pouch can remain in the pot for 6–8 min and still deliver a satisfactory result, while the consumer is occupied elsewhere. In addition, retort-pouched foods are easily prepared in microwave ovens. The contents are poured onto the serving plate and heated for about 1–2 min. The added stiffness of the aluminum foil makes the retort pouch easy to tear open, using the notches provided. Disposal of empty pouches after use is extremely convenient, as they are easily flattened and contain no dangerous sharp edges. This is particularly important in food service operations, where No. 10 takes more space [69].

#### 24.4.7.3.3 *Advantages to the Processor*

Retort pouches offer important advantages to the processor by cost savings. Packaging materials cost for retort pouches are lower than for steel cans (comparing total package cost for a pouch and outer carton versus a three-piece steel can, lid, and label). A roll of retort pouch stock takes up 85% less space than the equivalent number of empty cans, providing warehouse space savings on the front end of a packaging operation. The retort pouches offer savings in freight because it is lighter in weight than other packages. For example, 1000 numbers of 225 g (8 oz) steel cans weigh approximately 50 kg (109 lb), compared to just over 6 kg (12 lb) for equivalent pouches. With lighter package weight, more food product can be shipped per truck load in unrefrigerated trucks. One of the principal advantages of the retort pouch is that the package is sized to the food product, not vice versa as with cans. Thus, where liquid, or brine, is not essential to the food product, much of it may be eliminated, offering even more cost and freight savings [69].

#### 24.4.7.3.4 *Advantages to the Retailer*

Retort pouches can be merchandized anywhere in the store near the checkout counter or in end aisle displays. Initially, retort-pouched foods were marketed in paperboard cartons, for puncture resistance and product display. Soon, pouches may be marketed without cartons, printed with full-color illustrations, and merchandised on pegboards or special shelf units [69].

#### 24.4.7.3.5 *Other Advantages*

An environmental impact study has shown that the retort pouch, from package manufacture to consumer use, required less energy than canned food (in cans or glass) or frozen food. The pouch also made a more passive contribution to the waste-disposal systems than other packages [69].

#### 24.4.7.3.6 *Retort Pouch Technology*

A summary of the state of the retort pouch technology and its various aspects can be explained under the following headings [70]: (i) Films—for temperature range of 116°C–124°C, 9–25 micron polyester/9–25 micron foil/75 micron polyolefin (modified polyethylene or ethylene-propylene copolymers and blends) can be used. For temperatures up to 138°C, 12 micron polyester/9 micron foil/15 micron oriented nylon-6/50 micron polypropylene can be used. (ii) Products—over 100, ranging from commodity vegetables to “ready meals.” (iii) Package design—flat four seal, ranging from 10 to 100 mm × 5 to 175 × 20 mm for 150–300 g (5–10 oz.) contents to 300 mm × 450 mm × 25 to 12 mm for institutional packs, for 2.5–3.5 kg (5–7 lb) contents. With folding carton or polymer bag over wrap. (iv) Pouch packaging equipment—from roll stock, intermittent motion packager for 25–60 pouches per minute with steam flush and closure sealing, or could incorporate in-line vacuum sealing without transfer to separate machine. From roll stock, continuous motion packager for 250 pouches per minute. From preformed pouches, filler sealers for 25–60 per minute can with squeezing action or steam flush for air removal. (v) Retorts—horizontal batch, water or steam-air cook, modified to assure uniform distribution of heating media; use of retort racks, with separate heating media accumulation tank; suitable for high-temperature (135°C) cooks.

Continuous horizontal or vertical retorts for water or steam-air can also be used. (vi) Cartoning—standard folding carton equipment.

#### 24.4.8 Energy Aspects of Canning

The energy analysis of the operation of the food sterilization unit is useful in two respects. First, it provides quantitative information on energy requirements of use in designing the energy generating and delivery system; and second, it evaluates the modes of energy loss. Information obtained from the energy analysis can be used for quantifying energy conservation practices [71]. Energy required for manufacturing, transporting, and processing was estimated for two alternative systems (canning line and retort pouch line), each capable of producing about 45 metric tons of processed spinach per 8 h shift.

The following conclusions were drawn. (i) Container manufacturing required more than 80% of the energy required in each system. (ii) A pouch processing line will have much higher electrical requirements than a comparable canning line. However, costs associated with the electrical use are small compared to total costs. (iii) The total energy requirement for a retort pouch packaging system is significantly less than that for a can packaging system. (iv) Container and energy costs for a retort pouch packaging system are significantly lower than those for a comparable can packaging system. (v) A comprehensive economic analysis must be conducted before a decision to adopt retort pouch processing technology can be made.

A dominant factor influencing total energy use in the canning industry is the heat requirements of food sterilization. The continuous cookers used in canneries are typically more energy efficient than batch processing in retorts [72]. Energy consumption rates in operating various sterilizing equipment have been compared. The energy requirements of a rotary pressure retort, a rotary atmospheric retort, and a flame sterilizer were estimated and the overall heating efficiency was 47.7%, 31.2%, and 27.5%, respectively [73]. The comparative costs of the heat required for sterilization of canned products by different equipment (Table 24.2) have been reported. The thermal energy balance of a stationary retort was studied [75]. Only 16.7% of the steam supplied was used in heating the cans and contents and the remainder was lost during venting (36.4%), heating of the retort and crates (16.4%), along with the condensate in the bottom of the retort (11.2%), and through radiation (19.3%). The study indicates significant loss of steam during venting. Data from different canneries showed steam consumption to be quite consistent for the retorting operations, averaging 3 kg/min of steam per 24 numbers of No. 2 cans. During venting, the peak of steam consumption may vary between 1135 and 2720 kg/h for a standard 3–4 crate retort, depending upon the size of the steam inlet line. The peak demand drops off to an operating demand of 45–68 kg/h after the vent valve is closed and the retort reaches operating temperature. A novel fluidized-bed retort [76,77] involves heating and cooling of cans in a fluidized bed of sand or other granular material of high density. Fuel savings can be significant with a fluidized-bed retort, since the heating medium (usually air) does not go through a phase change and recycling of the heating medium improves the energy efficiency of the equipment.

**TABLE 24.2**

Energy Costs Required for Thermal Processing of Canned Foods by Different Equipment

Processing Equipment	Comparative Costs of Heat		
Static retort	100 <sup>a</sup>	100 <sup>b</sup>	100 <sup>c</sup>
Continuous rotary atmospheric retort	–	–	64
Continuous rotary pressure retort	–	–	46
Hydrostatic retort	20	56	–
Fluidized-bed retort	–	38	–
Microwave retort	1230	–	–
Flame sterilization	56	–	88

<sup>a</sup>= Values in this column from Ref. [74].

<sup>b</sup>= Values in this column from Ref. [76].

<sup>c</sup>= Values in this column from Ref. [73].

---

## 24.5 Aseptic Processing

### 24.5.1 Introduction

The development of the HTST processing methods for sterilizing in a continuous flow has brought about the need for aseptic packaging of the product. It is only through the use of aseptic packaging that the benefits of HTST treatment can be fully realized. Aseptic packaging will exhibit the greatest quality improvement over conventional canning when viscous low-acid products are processed. Many products can be commercially sterilized prior to packaging by continuous processes so that their organoleptic and nutritional quality is not significantly affected. Products such as puddings, sauces, dips, and pastes are currently aseptically processed. In the techniques applied to aseptic packaging, continuous heat exchangers can be designed so that any temperature profile may be applied. Aseptic packaging of foods is a process that enables products, sterilized in bulk or on-steam, to be filled and sealed into sterile containers, under aseptic conditions. There are two reasons for its use: (a) to enable containers to be used that are unsuitable for in-package sterilization and (b) to take advantage of HTST sterilization process, which is thermally efficient and generally give rise to products superior in quality compared with those processed at lower temperatures for longer times [78].

Application of the aseptic process involves (a) sterilization of the product, (b) sterilization of the packaging material, and (c) maintenance of the sterility during the filling and sealing operations. The advantages of aseptic packaging of food products are that it provides a higher quality product. A wide variety of packaging materials of different sizes and shapes can be used. There is minimum handling of the containers during the sterilization process. Also, it provides a high surface area for efficient heat transfer [79]. Aseptic processing and packaging, however, has limitations and it does not offer advantages with all products. Some of the disadvantages that are generally cited are large capital investment, applicability to limited range of products, requirement of a relative homogeneity of the fluid, and a need for sophisticated instrumentation [79].

### 24.5.2 Sterilization Systems

The production of a sterile product by continuous-flow sterilization involves (a) heating the product by passing it through a suitable heat exchanger to raise it to operating temperature, (b) passing the product through a holding section for a predetermined time to effect sterilization, and (c) cooling it to a temperature of 35°C or less prior to aseptic filling. The heat exchange process is limited to liquids containing small particles with a cross section of less than about 8 mm. For sterilization of large pieces, special equipment is required [80,81]. The ideal system would raise the temperature in the heat exchanger to the required value, thus eliminating the holder tube requirement. It is not possible to use a sufficiently high temperature and short residence time for this purpose with many products since (a) viscous products are difficult to heat uniformly and evenly to the operating temperature, (b) the presence of small particles makes it desirable to impose an unheated section to equilibrate temperatures, (c) the products may contain heat-resistant enzymes that are more likely to survive processes at the top end of the temperature range, and (d) the criticality of the process makes control difficult. The key components of the aseptic systems are the timing or metering pump, product heater, holding tube, cooler, and back-pressure valve. The type of aseptic processing equipment selected is dependent on the pH, the viscosity or consistency of the product, and on whether it contains particulate and their size.

### 24.5.3 Processing Equipment

#### 24.5.3.1 Infusion Sterilization

##### 24.5.3.1.1 Steam Injection Sterilization

This is the most rapid method of heating the product and facilitating the attainment of sterilization temperature within seconds. Combined with the rapid method of cooling by injection of the hot product into a vacuum chamber and evaporation of an equivalent amount of water, a very high quality product is obtained. The method is combined usually with heating and cooling in heat exchangers to the low temperature range (80°C) [82].



#### 24.5.3.1.2 *Liquid Infusion into Steam*

This system involves infusion of a thin film of liquid into a steam atmosphere, facilitating rapid heating. Cooling is also achieved by infusion of the liquid into vacuum chamber. The system is a versatile processing method designed primarily to heat and cool fluid foods within seconds. It produces the fastest heating methods, and this minimizes flavor changes and product damage normally associated with high processing temperatures. It is especially important for low-acid products, which require sterilizing up to 150°C. The system may be prepiped and packaged or field assembled to meet specific plant space requirements. Acquisition costs for infusion heating systems are low when high flow rates are being processed. There are few moving parts and the service costs are low. However, the method is suitable for particle-free liquids only. The heat recovery efficiency is only about 50%.

#### 24.5.3.2 *Tubular Aseptic Sterilizer*

Tubular aseptic sterilizing is an indirect heating/cooling method that uses stainless-steel coiled or straight tubular heat exchangers. The tubing diameter is relatively small compared to product flow. As a result, extremely high-flow velocities within the tubing maximize turbulence. High turbulence induces rapid heat transfer [21,82]. The tubing diameter is suited to the product flow and viscosity. Tubes are fabricated into coils or bundles, and placed along with special media baffles into stainless-steel jackets. Hot water, steam, or cold water pass through these jackets to heat or cool the product flowing within the tubes. A series of horizontal tubular heat exchangers and a vertical holder tube heat hold the product to the required sterilizing temperature and time. For low-acid products, 150°C with a holding time of 2–4 s is used. High-acid product would normally be heated to around 95°C and held for approximately 30 s. From the holding tube, the product flows to another series of vertical tubular heat exchangers for cooling. This system provides high heat transfer rates and a scrubbing action that reduces “burn off” or fouling in the tubes, resulting in a very short processing time. This helps to preserve the natural flavor of the product. The system has considerable flexibility in the range of products they can handle and the temperature range at which a specific product can be processed. They are completely self-contained, requiring only the product and utility hook-ups to be made during installation. There are no gaskets to replace on the high-temperature side. Most systems are available with regeneration as an option. Regeneration may be as high as 85% depending on flow rates, product characteristics, and the regeneration option used.

#### 24.5.3.3 *Swept Surface Sterilizer*

This type of heat exchanger is similar to the tube heat exchanger but is provided with a central rotating shaft carrying a scarping device for the heated surfaces. This prevents burning and fouling of foods at the surface and also provides a mixing action. The system is used when a viscous material or that containing small, discrete particles is to be processed. Swept surface sterilizing is an indirect heating/cooling method. With the continual removal of the product from the cylinder wall, the product film is reduced to an absolute minimum, permitting long processing runs without product build up on the heat exchanger wall [82]. Heat-sensitive products can be processed and the system is versatile for aseptic processing of different products. Products can be processed over a broad temperature range and viscosity with or without particulate. The various horizontal and vertical configurations allow this form of heat exchanger to be adapted to specific systems or plant requirements. It may be used in series with other types of heat exchangers for products such as starches that might increase in viscosity due to processing.

#### 24.5.3.4 *Plate Sterilizer*

Plate heat exchanger (described in the pasteurization section) can also be used for aseptic processing.

### 24.5.4 **Packaging Systems**

Aseptic packaging refers to the filling of a cold, commercially sterile product under sterile conditions into a presterilized container and closure under sterile conditions to form a seal that effectively excludes microorganisms. Aseptic literally means the exclusion of microorganisms from the environment. Aseptic

processing is really a method of packaging because foods are not sterilized or cooked or otherwise altered by aseptic methods. Rather, they are handled or moved by aseptic methods to assure they retain the microbiological quality with which they started. In general, aseptic packaging is coupled with HTST or UHT methods of food sterilization, and the two processes are joined in a complete system to produce what is referred to in the trade as aseptically processed foods. However, the total aseptic equipment is not an actual integrated system and the processor must purchase the sterilizer and the aseptic packager as separate units and then tie them together.

#### 24.5.4.1 Sterilization of Packaging Materials

Package sterilization has been accomplished by using a number of methods and its combinations [83]. The most common methods are based on the use of (a) superheated system, (b) hot, dry air, (c) hydrogen peroxide, (d) combination of hydrogen peroxide and ultraviolet light, (e) combination of hydrogen peroxide and heat, (f) heat of the coextrusion process, and (g) irradiation by gamma rays. These methods are given in Table 24.3 [84].

##### 24.5.4.1.1 Superheated Steam Systems

In this system, sterilization of the container and its closure is accomplished by the application of heat using superheated steam. The advantage of this system is that it can achieve high temperatures at the atmospheric pressure; however, microorganisms are more resistant to superheated steam than saturated steam.

##### 24.5.4.1.2 Dry Hot Air Systems

Hot air sterilization has similar advantages and disadvantages of superheated steam. There are currently no units of this type utilized in the production of low-acid foods, but the equipment has been used for the production of juices and beverages.

##### 24.5.4.1.3 Hydrogen Peroxide Systems

A number of systems utilize hydrogen peroxide in combination with heat and other adjuncts. In this system, the packaging material is not metal and it comes in rolls rather than in preformed containers.

**TABLE 24.3**

Methods for Sterilizing Aseptic Packages

Method	Application	Advantages/Disadvantages
Superheated steam	Metal containers	High temperature at atmospheric pressure; microorganisms are more resistant than in saturated steam
Dry hot air	Metal or composite juice and beverages containers	High temperature at atmospheric pressure; microorganisms are more resistant than in saturated steam
Hot hydrogen peroxide	Plastic containers, laminated foil	Fast and efficient method
Hydrogen peroxide/UV	Plastic containers (preformed cartons)	UV increases effectiveness of hydrogen peroxide
Ethylene oxide	Glass and plastic containers	Cannot be used where chlorides are present or where residual would remain
Heat from CO extrusion process	Plastic containers	No chemicals used
Radiation	Heat-sensitive plastic containers	Can be used to sterilize heat-sensitive packaging materials; expensive; problems with locations radiation source.

The system also utilizes a different sterilizing medium. The rolls are continuously fed into a vertical machine, which sterilizes, forms, fills, and seals the package. Sterilization is accomplished with a combination of hydrogen peroxide and heat. The heat necessary for sterilization may be obtained by a heated stainless-steel drum. Contact with the drum heats the peroxide and effects sterilization. Another system uses packaging material from rolls that are continuously fed into the machine, which forms, fills, and seals the package. The packaging material travels through a bath of hot hydrogen peroxide, which softens the material for forming. Cups are then formed, filled, and sealed with a lid, which also traveled through a hydrogen peroxide bath. Another system utilizes preformed cups to which a lid foil is heat sealed after filling. The cups are fed into the machine where they are sterilized by the peroxide spray followed by heating. The lid material is sterilized by being passed through a peroxide bath. All filling and sealing is done in a chamber that is kept sterile by maintaining a positive pressure with filtered sterilized air. Another system that utilizes preformed cartons, sprays the inside of the carton with low concentrations of hydrogen peroxide. This sprayed carton then passes under a UV light source, which acts synergistically with hydrogen peroxide in destroying microorganisms. Results of tests, using suspension of microorganisms, have shown this combination to be very effective.

#### *24.5.4.1.4 System Utilizing Heat of Extrusion Process for Sterilization*

This is a form, fill, seal packaging system and relies on the temperature reached by thermoplastic resin, during the co-extrusion process used to produce multilayer packaging material, to produce a sterile product surface. During production, the multilayer package material is fed into the machine where it is delaminated under sterile conditions. This removes a layer of material and exposes the sterile product's contact surface. The container material is then thermoformed into cups. The lid material, which is also delaminated, is then sealed onto the cup after filling. The sterility of the forming, filling, and sealing areas is maintained by sterile air under positive pressure.

#### **24.5.4.2 Aseptic Filling and Packaging Machines**

Aseptic filling and packaging systems can be classified into categories based on the type of packaging material and the method of forming the container (Table 24.4) [85].

##### *24.5.4.2.1 Form/Fill/Seal Machine for Pouches*

Figure 24.8 shows the principle of operation of an aseptic vertical form/fill/seal machine for three-sided sealed pouches [86]. The packaging material from a reel, usually a complex multilayer material, is sterilized by hydrogen peroxide in a heated bath, which is the siphon lock to a sterile chamber with a slight overpressure of sterile air. In this chamber, the film is dried, folded over a shoulder to form a tube, and sealed at the long seam. Then the tube, which is closed at the bottom by the cross seal, may be drawn to the nonsterile exterior of the chamber through a tightly fitting flexible lock. Sterile filling inside the chamber is performed using sine filler. In the tube, the contents are protected by a neutral atmosphere of sterile nitrogen, which maintains a very low oxygen concentration in the headspace of the packs. Grippers spread the sealing zones, and vertically reciprocating sealing bars with cutting knives outside the sterile cabinet transport down, seal, and cut off the pouches. The pack output is 15–35 pouches/min, depending on the size. Products that are, at present, filled by these machines include various tomato products, sauces such as cheese sauce and pizza sauce with particulate. Meal constituents and curries could also be filled [87]. The filling system has CIP and SIP characteristics. Presterilization of the filling system with pressurized steam and of the sterile chamber of the machine by condensed hydrogen peroxide vapors, and also heated air, is performed automatically.

##### *24.5.4.2.2 Thermoform/Fill/Seal Machine for Cups and Trays*

Films for both the cups and trays and the lid are drawn from rolls and are transported into the totally closed sterile cabinet through a heated hydrogen peroxide bath. The lower film is heated locally, thermoformed with plug assistance by pressurized sterile air, and the formed packs are then filled. Filling is performed by a special piston filler with reciprocating valves having cutting edges. This filler is able to deposit mixtures with particulate of a few millimeters in size. Shafts of the sliding valves and pistons

**TABLE 24.4**

Classification of Aseptic Filling and Packaging Systems

Category	Examples of Systems
I. Metal and rigid containers sterilized by heat	
A. Steam/metal containers	Dole hot-air system Drum fillers, e.g., Scholle, FranRica
B. Hot air/composite can	Dole canning systems
II. Webfired paperboard sterilized by hydrogen peroxide	Tetra Pak (BrikPak) International Paper
III. Preformed paperboard containers	Combibloc Liquipak
IV. Preformed, rigid/plastic containers	Metalbox Freshfill Gasti Crosscheck
V. Thermoform–fill–seal	Benco Asepack Bosch Servac Connofast Thermoforming USA
VI. Flexible plastic containers	
A. Bag-in-box type	Scholle Liquibox
B. Pouches	Asepack Prepac Prodopak Inpaco Bottlepack
C. Blow molded	Serac ALP

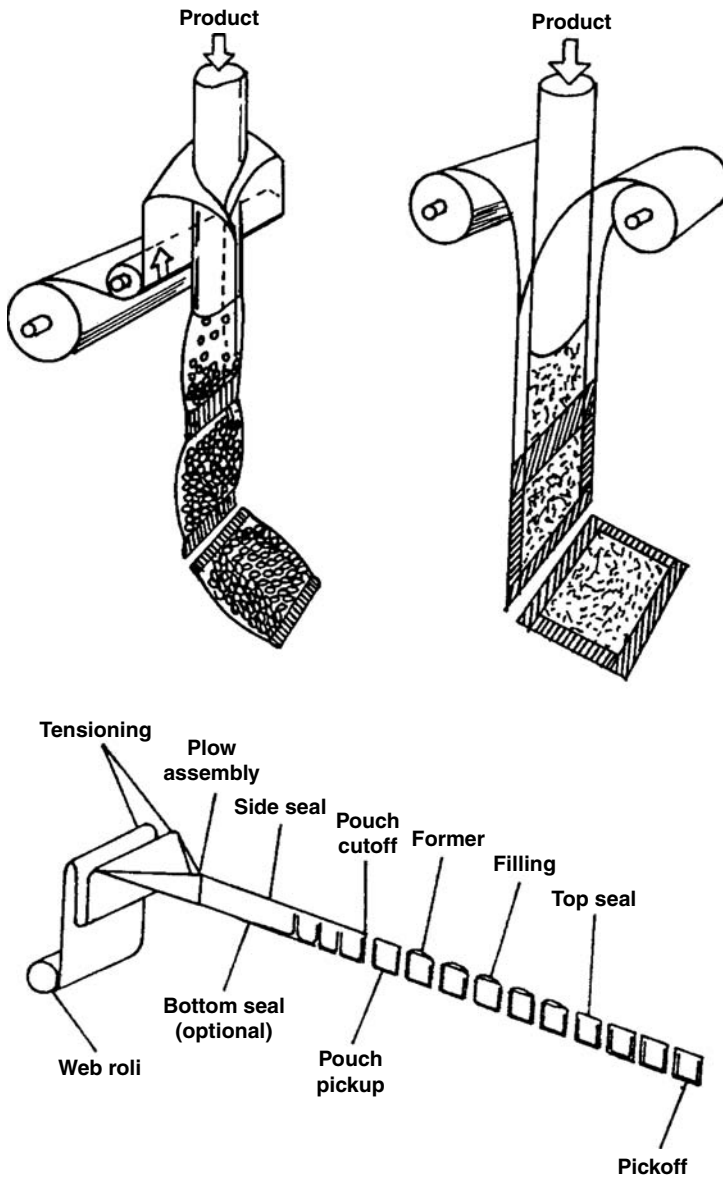
penetrate the vessel of the product that has to be filled. At the mechanical drive, external nonsterile air is separated from the sterile air above the product by rolling diaphragms. After filling, the lid is applied to the filled web and sealed at the rims. Headspace gas flushing may be performed. The webs are transported to the nonsterile outside through a contour lock without risk of infection, where the final sealing of the packs, notching, and cutting is carried out [87].

#### 24.5.4.2.3 *Filling and Closing Line for Bottles and Jars*

The containers, which are precleaned and heated by a special rinser, enter the sterilizing machine in one lane and they are sterilized in several lanes upside down, by treating the inside and the outside with hydrogen peroxide vapors and then drying with sterile air. The containers are inverted and then transported intermittently to the piston filler. In the next stage, the containers are closed with metal caps, which were sterilized with pressurized steam when entering the machine. For liquid products, magnetic-inductive metering devices are used for filling. For plastic bottles heat-seal closures from foil are applied [87].

#### 24.5.4.2.4 *The Tetra Pak System*

The principle of this system is to take the packaging material directly from the reel and to form it continuously into a tube. The tube is sealed below before filling and above after filling. The main advantage of this pack is that there is no headspace in the finished pack. The precreased web of packaging material unwinds over rollers, which soften the transverse crease. The web is immersed in hydrogen peroxide bath for sterilization. The packaging material is a lamination made of pare, foil, and polyethylene. This combination gives it lightness and a gas barrier, strength and heat-sealing properties [21,78].



**FIGURE 24.8** Form/fill/seal machines. (From Potter, N.N. and Hotchkirs, J.H., *Food Science*, 5th edn., Potter, H.H. and Hotchkirs, J.H., eds., Chapman & Hall, New York, 1995, p. 487, 491.)

#### 24.5.4.2.5 Conoffast System—Continental Can Co.

The system employs prefabricated, sealed pouches that may be internally sterilized by any one of the four methods. Empty pouches are fed through an ultraviolet chamber to minimize external pouch contamination and then filled using hypodermic needles in a superheated steam atmosphere. The needle is withdrawn and the puncture area is heat sealed. Ionizing radiation has been suggested to sterilize the pouch material surfaces. Steam-pressure sterilization restricts the packaging materials to those, which can resist the temperatures. To sterilize the filling and sealing area, and the needle, superheated steam at 145°C can be used [21,78]. The Conoffast system also utilizes the basic package forming–filling–sealing system. Sterilization -of the inside of the package in this system is based on the high temperatures generated within the thermoplastic resins during the extrusion process used to produce the multilaminated

packaging material. During the aseptic packaging operation, the top plastic sheet is delaminated, exposing a sterile surface of the packaging material to the food in a sterile environment within the Conoffast unit. Before filling, the packaging material is thermoformed into cup-shaped containers. Sterile food product is filled into the package under sterile conditions. Then the packages are sealed with packaging material from which one layer has been delaminated, again exposing a sterile surface in contact with the food. Sterility during the forming, filling, and sealing operations is maintained by performing these operations in a sterile environment under positive pressure.

#### 24.5.4.2.6 *The Combibloc System*

In this system, preformed carton blanks are used, which are die cut, creased, side seamed, and printed at the factory origin. This facilitates a more perfect flame-welded seam, thus ensuring good integrity of the seal and the packaging machinery can handle different sizes with a simple height adjustment. A carton blank is drawn from the magazine by suction pads and placed on a mandrel. The sealing surface at the bottom of the carton is softened by hot air. The bottom is folded, pressed, and sealed against the end face of the mandrel. The top is prefolded and then passed on to the aseptic zone where it is sterilized by a hydrogen peroxide spray. After filling, the package top is folded and sealed by ultrasonic welding [78].

#### 24.5.4.2.7 *The International Paper System*

In this system, the packaging material is taken from a reel. From the reel, the web passes through a series of scoring rollers into a hydrogen peroxide bath for sterilization. The horizontal seals are made by alternating jaws and an induction heater. Individual packages move to the final folding and sealing station for sealing of the top and bottom flaps [78].

#### 24.5.4.2.8 *The Gasti System*

This system operates with preformed cups made of plastic or aluminum. This facilitates greater flexibility to the operation and allows container quality to be approved in advance. In operation, preformed cups are dispensed from a magazine and are sterilized using hydrogen peroxide vapor. The cups are then filled in the sterile section and are sealed with presterilized lids [78].

#### 24.5.4.2.9 *The Liqui-Pak System*

This system uses a combination of two sterilizing methods to obtain aseptic packages, viz. hydrogen peroxide and ultraviolet light. This approach has a synergistic effect, which results in a more effective bactericidal action than high concentrations of hydrogen peroxide and ultraviolet light used individually. The cartons travel through the sterile area against a flow of filtered air. The filler is unique with plastic bellows mechanism for sterile dispensing of the product. After filling, the gable carton is heat sealed in a conventional manner [78].

#### 24.5.4.2.10 *The Metal Box "FreshFill" System*

This system uses preformed cups sterilized by hydrogen peroxide. The product is filled by a multihead filler, with the filling chamber isolated from other machine areas by sterile air overpressure generated by an ultrafilter. The filled cups are sealed using a presterilized foil material and stamped out in the conventional manner. Before start up, the filling chamber, fillers, and supply line are sterilized with steam at 130°C for 20 min [78].

#### 24.5.4.2.11 *Avoset System*

This system packs fluid products in glass and cans and then in aerosol containers. The system sterilizes containers and product separately and brings them together in a sterile environment. The entire equipment is placed in a controlled environment and all critical elements are sterilized. An operator is present to monitor the equipment. Although sterility is assured, distribution under refrigeration to retard biochemical changes is generally recommended [21,78,88].

#### 24.5.4.2.12 Manton-Gaulin (Pet Inc.)

The system is a glove box. Polyethylene bags are sterilized in the glove box with an ethylene oxide mixture and are heated to 49°C for 6 h. After sterilization, the gas is replaced by sterile air. Sterile mix is aseptically pumped to the filling nozzle within the glove box. Using glove box techniques, the operator fills one bag at a time through the rigid spout. The spout is heat sealed with a laminated foil material. The filled bag leaves the glove box through a chlorinated water trap and is dried outside of the aseptic filling area [21,78]. Scholle container with a semiautomatic aseptic system for filling 6 gallon polyethylene bags has been used. Sterile conditions are maintained by pressurized sterilized air and a continuous spray mist of chlorine solution over a hinged-cap fitment on the bag during filling.

### 24.5.5 Quality of Aseptically Processed Foods

The basic consideration for sterilizing at high temperatures for a short time is that each 10°C (18°F) increment in sterilization required for destruction of bacteria is reduced by a factor of 10, while the rate of destruction of nutrients and of other chemical reactions affecting product color and flavor decreased by a factor of approximately 3. This is called the *z* value. Higher is the sterilization temperature, larger is the difference between rates of destruction of reactions. This is the concept upon which the most important advantages of aseptic processing and packaging systems are based. Because of this, the organoleptic and nutritive characteristics of the products processed by aseptic processing systems are retained as compared to that processed by other systems, such as conventional canning [89]. Chemical and flavor changes during high-temperature heating are particularly severe in low-acid foods, which require more severe heat treatment to be sterile. At higher processing temperatures, bacterial spore destruction is much faster than the destruction of food constituents. Foods processed by aseptic processing are better in color and higher in thiamin than those made by conventional canning process. The aseptic processing is used commercially in the dairy industry and to fill fruit juices and purees, pea soups, sauces, and tomato paste.

The effect of HTST sterilization on the nutritive value of meat products has been a subject of great interest. Protein quality may be degraded by the destruction of one or more of the essential amino acids, formation of inter- and intramolecular bonds resistant to digestive enzymes, and alteration in the rate at which the various amino acids are released from protein. This results in a mixture of amino acids that may be less efficient for metabolism and assimilation. The essential amino acids tryptophan, methionine, and lysine are also destroyed by HTST sterilization. Destruction of methionine and accumulation of sulfur dioxide are the main chemical indices of the effect of cooking meat proteins at 120°C–150°C. Protein denaturation is not the only change that occurs during heat processing. Hydrolysis of proteins and polypeptides also takes place. Collagen, elastin, and reticulin compose the connective tissue of meat and are insoluble in water and salt solutions. Collagen is transformed by heating into soluble gelatin. In this conversion, some of the cross links are broken, resulting in shortening and disorganization of the protein chains. The conversion also accounts for higher protein solubility in the processed meat products. The aseptic strained meat has been shown to be more nutritious and higher in thiamin retention. Aseptically processed meat and vegetable products lose thiamin and pyridoxine but other vitamins are largely unaffected. There are negligible vitamin losses in aseptically processed milk and lipids, carbohydrates, and minerals are virtually unaffected. Riboflavin, thiamin, pantothenic acid, biotin, nicotinic acid, and vitamins B6 and B12 are unaffected. Nutrient losses also occur during periods of prolonged storage, and these should be considered when assessing the importance of sterilized foods in the diet.

### 24.5.6 Nutritional Aspects of Aseptically Processed Foods

The use of HTST processes is particularly adaptable to aseptic processing. The destruction of nutrients during the thermal processing is dependent on (1) time–temperature treatment used as the basis of the process, and (2) the rate of heat transfer into the product. In an aseptic processing system, as the processing temperature is about 150°C for a very short period, the nutrient retention is greatly enhanced. The effects of heat treatments of equal microbial lethality on selected food constituents, including nutrients, color, proteins, and flavor compounds, have been reported [90]. The retention of vitamin C in tomato juice improves during HTST processing. For natural products containing enzymes, the limitation

of the benefits of HTST processing occurs when the basis of the process shifts from microbes to enzymes at a temperature of 130°C–145°C for shorter periods.

In an evaluation of HTST aseptic processing [91], it was found that thiamin retention was significantly greater in HTST products than conventionally canned and retorted products. For pyridoxine, the benefit of HTST was not as evident, as destruction of pyridoxine is not much temperature-dependent as that of thiamin. HTST aseptic processing also results in the significant improvements in organoleptic qualities [92]. Most of the reports on the effect of thermal processing on nutrients only contain information on the content of a specific nutrient after the thermal process and give the percentage retention or loss of the nutrient. As there are numerous processing methods and the time–temperature possibilities for accomplishing commercial sterilization, it is improper to assume that the nutrient losses reported in the literature represent the average or normal for the industry. Hence, the data on such nutrient losses are of limited value but can be used as a guideline for selecting an optimum process schedule [92]. Nutrient losses range from 0% to 90%, depending on the nutrient and the product. These losses represent the sum of the losses during the entire processing including blanching. In some of the studies [93–95], the temperature for sterilization of foods has been optimized to maximize retention of nutrients or minimize the production of an undesirable product.

## 24.5.7 Packaging of Aseptically Processed Foods

### 24.5.7.1 Introduction

Packaging of aseptically processed food is the most critical key for a successful operation. The product has to be packaged in the form desired, which will yield the benefits anticipated after the product has been sterilized. This includes process design, process equipment, formulation, and raw material quality. Besides, the machinery used, the materials used for the container, and the closure and the sterilants that can be used with these materials are important. The aseptic packaging system must be capable of filling the product produced by the UHT or HTST system in an aseptic manner and sealing the container hermetically so that sterility is maintained throughout the handling and distribution process. Thus, the system must be capable of (a) being connected to the processing system in a manner that enables aseptic transfer of product to take place, (b) being effectively sterilized before use, (c) carrying out the filling, sealing, and critical transfer operations in a “sterile” environment, and (d) being cleaned properly after use. The packages in use vary from traditional tin-plate can and glass bottle to the nonrigid and semirigid containers based on thermoplastics or combinations of thermoplastics with paperboard and metal. The type of container used will be influenced by the nature of the contents, cost, and its acceptability to the consumer. The relatively low cost and wide acceptance by the consumer are the main reasons for the recent proliferation in the use of the carton-type packs for fruit juice, juice-based beverages, and dairy products. In addition to systems producing packages intended for sale directly to the public, bulk packaging installations are used for conserving raw materials or intermediates intended for reprocessing or for use in catering establishments.

Many systems have been proposed for the aseptic packaging of food, but some authorities consider that not all those proposed meet the criteria for full asepsis. Thus, they should be more accurately described as ultraclean fill machines and used as means of extending the shelf life of products distributed through the cold chain. Some systems, by their nature, restrict the packaging material to simple monolayer plastics, and many foods packaged in these materials have a limited shelf life due to their poor oxygen barrier characteristics. Others are able to employ multilayered barrier plastics or include aluminum foil as a component, and in such cases shelf life is much improved. Containers made from glass or metal of adequate thickness may be considered impermeable [78]. The method of sterilizing the package, or the material from which it is formed, is important in retaining the characteristics of the packaging material. Sterilizing processes may alter the characteristics of the package, or material, and render it undesirable for packaging the food product. Obviously, the material must perform and produce the results desired. Some of the factors that should be considered include [96]: (i) performance with the food (gas transmission, water transmission, absorbance—packaged product flavors, odors, colors, and vitamins being absorbed by the container material, adsorbance—a few molecules being extracted from the package material and being held by the product, combinations of absorbency and adsorbency, chemical inertness to the food, or desirable reactions with the food, sterilization, wet ability, temperature limitations,



and inertness to the sterilizing agents, can be laminated or special surfaces applied, material handling characteristics (empty)), (ii) cost, and (iii) form and mechanical characteristics (if it can be molded, size limitations, shape limitations, easy opening/closures available, tamper-proof closures or tamper-evident systems available, configuration after storage, material handling characteristics and suitability for use with conveyors, labelers, casers, and over cappers), (iv) shipping and handling (toughness or strength, type of over wrap or cases required, fillers between packages in the cases required) and (v) comply with regulations (food safety FDA, FSIS, 3A, and PMO).

The materials that are used for aseptic packages are practically infinite. This is because the use of laminated materials, using plastics as well as metals, and the development of new plastic materials and alloys, is occurring regularly. There are also variations within a defined product, so it may vary from different manufacturers, even though generically it is the same. For example, paper from one supplier may vary from paper that comes from another vendor. The same is true for metals such as steels and aluminum, plastics, and laminates. These variations can cause the product to change over a short or long period. Some of the common materials used for aseptic packages include the following [96]: (i) stainless steel (bins, tanks, and rail cars), (ii) carbon steel (cans and closures), (iii) aluminum (cans and closures), and (iv) plastics (cups and square/rectangular packages) (acetal, nylons [66 or others], polypropylene, polyester, polycarbonate, acrylic, ABS—acrylonitrile-butadiene-styrene, PVC—polyvinyl chloride, polystyrene, high-density polyethylene, low-density polypropylene, EVAL—ethyl vinyl acetate, EVOH—ethyl vinyl alcohol, PVDC—polyvinylidene chloride, paper, paper-based laminates, and plastic-based laminates).

It should be considered that new materials are constantly being proposed for approval by the FDA for aseptic packages with specified types of sterilants. Also, certain laminates that exist today are being made in a single polymer form; hence, a resin may contain three or four different polymers that have combined properties. The reason for manufacturing laminates out of various materials is to build into the packaging material(s), those properties that are most critical for the food product over a period of time (which may be short, medium, or long); and it will be either inert to the product or react with it in a favorable way, such as tin cans reacting with citrus juices. The problem of the food product compatibility with container materials over a period of time should be briefly addressed. This is an area that has not received the attention it should have from packaging manufacturers or food processors.

Materials can absorb desirable components from the food, thereby causing the food to have less flavor, color, odor, and nutrients. Another condition that exists is that the packaging materials can actually have certain molecules stripped from it, thereby changing the food product's color, flavor, odor, and vitamin content. Also, there are combinations of the two where the material used for package is reacting with the food to change its properties, and in turn the food is reacting with the packaging material and losing some of its desirable characteristics. This situation is never ending and may actually accelerate as color changes occur [96].

### **24.5.7.2 Aseptic Packaging**

In general, aseptic packaging is coupled with HTST/ UHT methods of food sterilization, and the two processes are joined in a complete integrated system to produce aseptically processed foods.

#### **24.5.7.2.1 Drums**

The drum is placed under the filling chamber and then raised up to seal against a gasket. Saturated steam is introduced into the drum and the interior of the drum is pressurized with steam. After a total 2.5-min cycle, a filling tube lowers into the drum and dispenses sterile product to fill the drum. The filling tube retracts and a sealing head with magnetically attached lid swings over the drum. Steam pressure is employed to apply pressure to crimping jaws to fix the gasketed lid into place. Alternatively, an empty drum and cover are placed in a filling retort, and both are steam sterilized under pressure. The sterile product is then filled into the drum, and the lid is placed. The drum is removed, and another cycle is initiated. The capacity of the system with two filling retorts is 24 drums per hour [21,97]. The advantage claimed of the drum system is lowered shipping weight because one large reusable container is used rather than 75 numbers of No. 10 cans plus 12–13 corrugated cases. Product recovery is higher because there is far less surface area to drain. Further, the labor cost of emptying one 200 L container is significantly less than the cost of opening 75 cans.

#### 24.5.7.2.2 Tanks

Instead of pulping, finishing, and concentrating into paste for bulk handling, tomatoes are simply chopped, sterilized, and filled aseptically into 380 L (100 gallon) tanks. Tomatoes are washed, chopped into chunks, heated in tubular heaters, cooled, deaerated, and subsequently filled into tanks under a nitrogen blanket. Storage tanks are galvanized steel, lined with a baked-on epoxy coating. Tanks are chemically sterilized before filling [21]. The basic objective is to provide tomato processors with a large source of raw material that can be converted into many different products over a long period. Among the products that can be made from chopped tomatoes are paste, puree, sauce, catsup, pizza sauce, juice, and chili sauce.

#### 24.5.7.2.3 Glass Containers

Aseptic packaging in glass containers has not been broadly successful on a commercial basis. Juice is heated to 93°C and held for 9 s and cooled to 20°C in a heat exchanger 1 and 2 L bottles are cleaned by rinsing with water. After washing, the bottles are discharged into a closed area blanketed with 99.9% sterile, dehumidified air. The filler is sterilized with boiling water prior to the operation. Closures are steam sterilized and taken into the clean room. Sterile juice is filled into the “sterilized jars” and capped in the clean area. The product, known as aseptic cold-pack juice, is reported to have long shelf life under 10°C [21]. At room temperature storage, hot-filled (conventional) juice has an acceptable shelf life of 1 month as compared to 3 months for cold-filled juice. The basic problem with glass is that the maximum temperature differential glass containers can withstand is approximately 15°C. Thermal shock between inner and outer surfaces leads to unequal thermal expansion sufficient to crack the glass.

#### 24.5.7.2.4 Plastic Containers

The concept of aseptic packaging holds that presterilized product is filled under aseptic conditions into a presterilized container. As long as the container can exclude microorganisms and prevent passage of gas, container material need not be rigid. Both Metal in heavy gages and glass are fabricated into rigid containers. No rigid plastics are employed commercially for sterile packaging. All plastic materials are partially permeable to moisture and gas. Because of implied low-strength characteristics, food products that have been sterilized are packaged in semirigid materials. Paperboard with appropriate coatings is also utilized to form semirigid packages [21]. Two basic types of semirigid systems are in commercial use [21]: (i) thermoform, fill, and seal, and (ii) preformed cups, fill, and seal.

#### 24.5.7.2.5 Flexible Packages

The Tetra Pak AB system is often considered as a flexible packaging system. Technically, it is not a flexible packaging system because it is made of paperboard rather than a true flexible material. The polyethylene pouching material is sterilized using a hydrogen peroxide bath. The vertical form, fill, and seal milk pouching equipment is converted for aseptic packaging [98].

#### 24.5.7.2.6 Reclosable Aseptic Packaging System

Reclosing is useful for products such as milk, fruit juice, and wine. Shaking is important for products such as pulpy fruit juices. The system consists of a closure with two parts. The visible part is a rectangular polypropylene chassis with a cap that snaps open and shut on a hinge. The device is glued to the top corner surface of the pack with hot-melt adhesive [99]. Underneath the cap is the second part of the system—an aluminum pull tab that covers the pouring hole and provides good tamper evidence. The pull tab, which is welded to the inner liner of the package, is easy to peel off. It reveals a long, pear-shaped hole that has excellent pouring characteristics. The reclosing system is extremely sanitary, unlike “punch”-style cap devices that require users to poke a finger into the product to open the package. High-quality long-life product is achieved by the aseptic filling process. This package provides easy stackability, is space saving in terms of transportation (both filled and unfilled cartons), has low weight, saves cost in carton material production, and has high level of environmental friendliness. The reclosable system increases the intrinsic value of the carton and provides the consumer with easy opening, spill-free pouring, and reliable reclosure as well as hygienic handling. After reclosure, the product is protected and

can be shaken as necessary. The product quality remains unimpaired and protected from foreign flavors. The carton with the system fitted is ideal for refrigerator storage. The new carton image is completed by the slim, elegant shape, suggestive of high quality.

#### 24.5.8 Energy Aspects of Aseptic Processing

The energy aspects of aseptic processing have been widely carried out on milk and most of the data available are on milk products. Energy requirement of aseptic processing units containing steam injection without regeneration, tube heat exchanger, as applied to the processing of milk, has been evaluated. For steam infusion, the system consumed about 1000 kJ/kg of milk [100]. For tube heat exchanger, the system consumed about 400 kJ/kg milk [101]. The total energy requirement in the HTST system for milk processing was about 225 kJ/kg of milk. The break-up of the energy was 98 kJ/kg milk thermal, 30 kJ/kg electrical, and 97 kJ/kg refrigeration. The steam infusion system requires about 360 kJ/kg of milk as it is a direct contact heating and is more compared to indirect heating like tube heat exchanger [102]. Cooling below 30°C is not required for aseptic processed milk. This saves more energy and is about 100 kJ/kg of milk. In addition, aseptic processing of products does not require postprocessing refrigeration resulting in further savings of 900 kJ/kg of product [102]. The most widely used heat exchangers in aseptic processing of foods are the plate and tubular type. If direct heating and cooling of product to sterilizing temperatures is used, the energy consumed is considerable. Therefore, use of regeneration of heat is important [103]. The plate heat exchanger holds a distinct edge in this regard; regeneration efficiencies of 90% (direct) or 85% (indirect) have been used. Tubular units can achieve regeneration by indirect methods, whereby a secondary water flow exchanges heat from the preheater tubes to the cooler tubes. Indirect regeneration requires four times the surface as does direct, for the same heat recovery. As a result, regeneration efficiencies over 70% are rare. Steam injection/infusion systems are not efficient: for example, with milk duties regeneration accounts for only slightly more than 50% of the total heat input. Regeneration with swept surface units, though possible, is not used due to capital cost consideration.

---

## References

1. Harlfinger, L., Microwave sterilization, *Food Technol.*, 57, 61, 1992.
2. Parrot, D.L., Use of Ohmic heating for aseptic processing of food particulates, *Food Technol.*, 46(1), 68, 1992.
3. Ramesh, M.N., Optimum sterilization of foods by thermal processing—a review, *Food Sci. Technol. Today*, 9(4), 217, 1995.
4. Hersom, A.C. and Hulland, E.D., *Thermal Processing and Microbiology*, 7th edn., Churchill Livingstone, Edinburgh, 1980.
5. IFT, Kinetics of microbial inactivation for alternative food processing technologies, *J. Food Sci. Special Suppl.*, ISSN: 0022-1147, 2001.
6. Teixeira, A., *Handbook of Food Engineering*, Heldman, D.R. and Lund, D.B., eds., Marcel Dekker, New York, 1992.
7. Ramesh, M.N., Prapulla, S.G., Kumar, M.A., and Mahadevaiah, M., Thermal processing of foods: A retrospective Part I, Uncertainties in thermal processing and statistical analysis, In: *Advances in Applied Microbiology*, New York, 44, 287, 1997.
8. Fellows, P., ed., *Food Processing Technology; Principles & Practice*, Ellis Horwood, England, 221, 1988.
9. Richardson, R.S. and Selman, J.D., *Processing and Packaging of Heat Preserved Foods*, 1st edn., Rees, J.A.G. and Bettisson, J., eds., Chapman & Hall, New York, 50, 1990.
10. Thorpe, R.H., Atherton, D., and Steele, D.S., *Technical Manual 2*, Campden Food Preservation Research Association, Chipping Campden, Glos, UK, 1975.
11. Tung, A.I., Britt, I.J., and Ramaswamy, H.S., Food sterilization in steam/air retorts, *Food Technol.*, 105, 1990.
12. Tucker, G. and Clark, P., Computer modeling for the control of sterilization processes, Technical Memorandum 529, Campden Food and Drink Research Association, Chipping Campden, Glos, UK, 1989.
13. Perkins, W.E., *Introductions to the Fundamentals of Thermal Processing*, Sleeth, R.B., ed., IFT, Chicago, November 15, 82, 1979.

14. Casimir, D.J., New equipment for the thermal processing of canned foods, *Food Technol. New Zealand*, 4, 290, 1969.
15. Kimball, R.N. and Heylinger, T.L., Verifying the operation of steam retorts, *Food Technol.*, 100, 1990.
16. Adams, H.W. and Hardt-English, K., Determining temperature distribution in cascading water retorts, *Food Technol.*, 41, 110, 1990.
17. Park, D.J., Cables Jr, L.J., and Collins, K.M., Determining temperature distributions in rotary, full immersion, hot water sterilizers, *Food Technol.*, 41, 113, 1990.
18. Manfre, B.L., Criteria for the selection of heat processing equipment, Part I. Equipment, *Canner/Packer* 138(10), 21, 1969.
19. Manfre, B.L., Criteria for the selection of heat processing equipment, Part II. Economics, *Canner/Packer* 138(12), 21, 1969.
20. Blanchett, R.D., Hickey, F.D., and Reimers, J., Controlled agitation retorting cuts heating time, retains high quality of cream-style corn, *Food Process.* 30(1), 16, 1969.
21. Brody, A.L., Food canning in rigid flexible packages, *CRC Food Sci. Nut.*, 2, 187, 1971.
22. Faasen, W. and Hoogzand, C., Aspects of technology, engineering and design of hydrostatic high-speed processing of foods in glass and metal containers, XXII International Congress of Food Science and Technology, Warsaw, 22–27 August, 1966.
23. Farkas, D.R., Lazar, M.R., and Rockwell, W.C.A., A rotating hydrostatic helix for transferring solid-liquid mixtures under pressure or vacuum, *Food Technol.*, 23, 180, 1969.
24. Beauvois, M., Thomas, G., and Cheftel, H., A new method for heat-processing canned foods, *Food Technol.*, 15(4), 5, 1961.
25. Niederauer, T., The influence of technological processes on the nutrient value of foods, *Riechstoffe, Aromen, Kosmetica*, 29(6), 118, 1979.
26. Fennema, O., *Chemical Changes in Food During Processing*, Richardson, T. and Finley, W.J., eds., AVI Publishers, Connecticut, 1, 1985.
27. Mauran, J., Effects of processing on proteins and food processing and nutrition: An overview, Proceedings of the XIII International Congress of Nutrition, Taylor and Jenkins, 762, 1985.
28. Hurrell, R.F. and Carpenter, K.J., *Physical, Chemical and Biological Changes in Food Caused by Thermal Processing*, Hoyem, T. and Kvale, O., eds., Applied Science, London, 168, 1977.
29. Matz, S.A., *Food Texture*, AVI publishing Co., 177, 1962.
30. Finley, J.W., *Chemical Changes in Food during Processing*, Richardson, T. and Finley, J.E., eds., 443, 1985.
31. Ledward, D.A., *Effects of Heating on Foodstuffs*, Priestley, J.R., ed., Applied Science, London, 1, 1979.
32. Bender, A.E., *Food Processing and Nutrition*. Academic Press, London, 1978.
33. Kinsella, J.E., *Food Proteins*, Fox, P.P. and Carden, J.J., eds., Applied Science, London, 51, 1982.
34. Simpson, K., *Chemical Changes in Food during Processing*, Richardson, T. and Finley, J.W., eds., AVI Publishing Co., 409, 1985.
35. Adams, J.B. and Blundstone, H.A.W., *The Biochemistry of Fruits and Their Products*, Hulme, A.C., ed., Vol. 2, Academic Press, London, 513, 1971.
36. Adams, J.B. and Ongley, M.M., The degradation of anthocyanins in canned fruit. Technical Bulletin No. 23, Campden Food and Drink Research Association, 1972.
37. Chandler, B.V. and Clegg, K.M., Pink discoloration in canned pears I: Role of tin in pigment formation, *J. Sci. Food Agric.*, 21, 315, 1970.
38. Timberlake, C.T. and Bridie, P., *Anthocyanins in Developments of Food Colours*, Wolford, J., ed., Applied Science, 115, 1980.
39. Woolfe, M.L., *Effects of Heating on Foodstuffs*, Priestly, R.J., ed., Applied Science, London, 77, 1979.
40. Malecki, G.J., British Patent No. 772, 062, 1957.
41. Malecki, G.J., British Patent No. 915,429, 1963.
42. Clydesdale, F.M., Chlorophyllase Activity in Green Vegetables with Reference to Pigment Stability in Thermal Processing. Ph.D. Thesis, University of Massachusetts, Amherst, 1966.
43. Rose, D.J. and Blundstone, H.A.W., The reproduction of the effects of plain tinplate in other forms of containers. Technical Memo No. 522, Campden Food and Drink Research Association, 1989.
44. Hodge, J.E., Chemistry of browning reactions, *J. Agric. Food Chem.*, 1, 928, 1953.
45. Wolfram, M.L. and Rooney, C.S., Chemical interactions of amino compounds and sugars VIII. Influence of water, *J. Am. Chem. Soc.*, 75, 5435, 1953.
46. Saunders, J. and Jervis, F., The role of buffer salts in non enzymatic browning, *J. Sci. Food Agric.*, 17, 245, 1966.

47. Hurrell, R.F. and Carpenter, K.J., Mechanisms of heat damage in proteins. 4-The reactive lysine content of heat damaged material as measured in different ways, *Fr. J. Nutr.*, 32, 589, 1974.
48. Hall, M.N., Edwards, M.C., Murphy, M.C., and Pither, R.J., A comparison of the composition of canned, frozen and fresh garden peas as consumed, Technical memo No. 553, Campden Food and Drink Research Association, 1989.
49. Bouhallab, S., Morgan, F., Henry, G., Molle, D., and Leonil, J. Formation of stable covalent dimmer explains the high solubility at pH of lactose- $\beta$ -lactoglobulin conjugates heated near neutral pH. *J. Agric. Food Chem.*, 47, 1489, 1999.
50. Choudhuin Roy, R.N., Joseph, A.A., Daniel, V.A., Narayana Rao, M., Swaminathan, M., Srinivasan, A., and Subramanyan, V., Effect of cooking, frying, baking and canning on the nutritive value of potato, *Food Sci. (Mysore)*, 12(9), 253, 1963.
51. Jaswal, A.S., Effects of various processing methods on free and bound amino acid content of potatoes, *Am. Pot. J.*, 50, 86, 1973.
52. Bender, A.E., *Food Processing and Nutrition*. Academic Press, London, New York, 786, 1985.
53. Benterud, A., *Physical, Chemical, and Biological Changes in Food Caused by Thermal Processing*, Hoyem, T. and Kvale, O., eds., Applied Science, London, 199, 1977.
54. Woolfe, J., ed., *Processing the Potato in the Human Diet*, International Potato Centre and Cambridge University Press, London, 139, 1987.
55. Priestley, R.J., ed., *Effects of Heating on Foodstuff*, Applied Science, London, 121, 1979.
56. Fennema, O., Food Processing and Nutrition: An Overview, Proceedings of the XIII International Congress of Nutrition, Taylor and Jenkins, 762, 1985.
57. Birch, G.G., *Physical, Chemical and Biological Changes in Food Caused by Thermal Processing*, Hoyem, T. and Kvale, O., eds., Applied Science, London, 152, 1977.
58. Greenwood, C.T. and Mann, D.N., *Effects of Heating on Foodstuffs*, Priestly, R.J., ed., 35, 1979.
59. Cottrell, R., *Nutrition in Catering*, Parthenon Publishing Group, 1, 1987.
60. Harwood, J.L., Cryer, A., and Gurr, M.I., *The Lipid Handbook*, Gunstone, F.D., Harwood, J.L., and Padley, F.B., eds., Chapman & Hall, London, 527, 1986.
61. Trans Fatty Acids, BNF Task Force Report.
62. Aylward, F., Coleman, G., and Haisman, D.R., Catty odours in food: The reaction between mesityl oxide and sulphur compounds in foodstuffs, *Chem. Ind.*, 5, 1563, 1967.
63. Aylward, F., Coleman, G., and Haisman, D.R., Catty taints in foodstuffs, Technical Memo No. 71, Campden Food and Drink Research Association, 1967.
64. Patterson, R.L.S., Catty odours in food: their production in meat stores from mesityl oxide in paint solvents, *Chem. Ind.*, 6, 584, 1968.
65. B.F.M.I.R.A., Catty taints in foods, *Food Trade Rev.*, 39(9), 47, 1969.
66. Goldenberg, N. and Mathesan, J.R., Off-flavours in foods: a summary of experience 1948-74, *Chem. Ind.*, 13, 551, 1975.
67. Czerenski, K. and Jarsabek, K., Changes in the biological value during thermal processing of meat under different conditions, measured by means of the fluorodinitrobenzol determination of available lysine, *Przenyol Spozywezy*, 18, 714, 1964.
68. Larouse, J. and Brown, B.E., eds., *Food Canning Technology*, Wiley-VCH Publication, 313, 1997.
69. Heintz, D.A., Marketing opportunities for the retort pouch, *Food Technol.*, 33, 32, 1980.
70. Lampi, R.A., Retort pouch: the development of a basic packaging concept in today's high technology era, *J. Food Process. Eng.*, 4, 1, 1980.
71. Steffe, J.F., Williams, J.R., Chinnan, M.S., and Black, J.R., Energy requirements and cost of retort pouch Vs can packaging systems, *Food Technol.*, 34(9), 39, 1980.
72. Unger, S.G., Energy utilization in the leading energy-consuming and processing industries, *Food Technol.*, 29(12), 33, 1975.
73. Ferrua, J.P. and Col, M.H., Energy consumption rates for steam equipment, *Canner/Packer*, 144(1), 44, 1975.
74. Casimir, D.J., Flame sterilization, *CSIRO Food Res. Quart*, 34, 1975.
75. Sampson, D.F., Some aspects of the technology of processing sterilization of canned foods, American Can Co., Ma, USA, 205, 1953.
76. Jowitt, R. and Thorne, S.N., Evaluates variables in fluid retorting, *Food Eng.*, 43(11), 60, 1971.
77. Thorne, S.N., Heat processing of canned foods in fluidized beds, *Food Technol. Aust.*, 24(3), 132, 1972.
78. Hersom, A.C., Aseptic processing and packaging of food, *Food Rev. Int.*, 1(3), 223, 1986.

79. Lopez, A., ed., *A Complete Course in Canning* Vol. 2, The Canning Trade Inc. Publ. 12th edn., USA, 62, 1987.
80. Hersom, A.C. and Shore, D.T., Aseptic processing of foods comprising sauce and solids, *Food Technol.*, 35(5), 53, 1981.
81. Anon, *Food Eng.*, 53(10), 108, 1981.
82. Buckner, N., *Aseptic Processing and Packaging of Particulate Food*, Willhoft, E.M.A., ed., Blackie Academic and Professional, London, 5, 1993.
83. Ito, K.A. and Stevenson, K.E., Sterilization of packaging materials using aseptic systems, *Food Technol.*, 38, 60, 1984.
84. Collier, C.P. and Townsend, C.T., The resistance of bacterial spores to superheated steam, *Food Technol.*, 10, 92, 1956.
85. Stevenson, K.E., Proceedings of National Food processors Association Conference-Capitalizing on Aseptic II, Food Processors Institute, Washington DC, 59, 1985.
86. Potter, N.N. and Hotchkirs, J.H., *Food Science*, 5th edn., Potter, H.H. and Hotchkirs, J.H., eds., Chapman & Hall, New York, 487 & 491, 1995.
87. Davis, R.B. and Maunder, D.T., New system for aseptic pouch packing, *Modern Packaging*, 40(10), 157, 1967.
88. Glaser, E., Recent directions for aseptically packaged fluids, *Food Prod. Dev.*, 2(3), 60, 1969.
89. Luh, B.S., Gonzalez-Acuna, C.G., Leonard, S., and Simone, M., Aseptic canning of foods—V, chemical and flavour changes in strained beef, *Food Technol.*, 18, 212, 1964.
90. Ammerman, G.R., The Effect of Equal Lethal Heat Treatment at Various Time and Temperature on Selected Food Components. Ph.D. Thesis, Purdue University, W. Lafayette, IN, 1957
91. Johnson, R., M.S. Thesis, University of Georgia, Athens, GA, 1973.
92. Everson, G.J., Chang, J., Leonard, S., Luh, B.S., and Simone, M., Aseptic canning of foods II & III: thiamine and pyridoxine retention as influenced by processing methods, storage time, temperature and type of container, *Food Technol.*, 18, 84, 1964.
93. Lund, D., ed., *Nutritional Evaluation of Food Processing*, 3rd edn., Van Nostrand Reinhold Co., New York, 341, 1988.
94. Hallstrom, B. and Dejmek, P., Optimization and comparative evaluation of UHT plants, *Milchwissenschaft*, 32(6), 447, 1977.
95. Lehniger, H.A. and Beverloo, W.A., eds., *Food Process Engineering*, Reidel Publishing Co., Dordrecht, Holland, 324, 1975.
96. Carlson, B., *Aseptic Processing and Packaging of Food*, David, J.R.D., Graves, R.H., and Carlson, V.R., eds., CRC Press, New York, 130, 1996.
97. Witmer, C.C., Malvick, A., Snyder, B., and Robe, K., Simplest aseptic drum filler-drum is pressure chamber, *Food Proc.*, 31(4), 44, 1970.
98. Wainess, H., Long-life dairy products, *Dairy Ice Cream Field*, 24, 1970.
99. Hawker, N., Reclosable packaging system, *Food Technol. Eur.*, 1(3), 62, 1994.
100. Biziak, R.B., Energy Use in UHT Sterile Milk Processing. M.S. Thesis, North Carolina State University, Raleigh, NC, 1981.
101. Biziak, R.B., Swartzel, K.R., and Jones, V.A., Energy evaluation of an UHT shell and tube processing system, *J. Food Sci.*, 47(6), 1875, 1982.
102. Chandarana, D.I., Frey, B.C., Stewart, L.E., and Mattick, J.F., UHT milk processing-effect on process energy requirements, *J. Food Sci.*, 49, 977, 1984.
103. Dinnage, D.F., Aseptic processing of liquid food, Proceedings of National Food Processors' Association Conference, October 11–12, Washington, 32, 1983.
104. Paine, F.A. and Paine, H.Y., eds., Fresh and chilled foods, *A Handbook of Food Packaging*, 2nd edn., Chapman & Hall, New York, 1982, pp. 224.



# 25

## *Cooking and Frying of Foods*

M. N. Ramesh

### CONTENTS

25.1	Cooking .....	625
25.2	Cooking Methods .....	626
25.2.1	Dry-Heat Methods .....	626
25.2.2	Moist-Heat Methods .....	626
25.2.3	Frying .....	627
25.2.4	Microwave Cooking .....	627
25.2.5	Slow Cooking .....	627
25.3	Application of Heat .....	628
25.4	Cooking Equipment .....	629
25.4.1	Batch Cookers .....	629
25.4.1.1	Steam Kettles .....	629
25.4.1.2	Steam Cookers .....	629
25.4.1.3	Vacuum Cookers .....	629
25.4.1.4	Rotary Cereal Cooker .....	630
25.4.2	Continuous Cookers .....	630
25.4.2.1	Pressure Cookers/Blanchers .....	630
25.4.2.2	Steam Cookers .....	630
25.4.2.3	Microfilm Cookers .....	631
25.5	Effects of Cooking on Nutrients .....	631
25.5.1	Fats .....	631
25.5.2	Carbohydrates .....	631
25.5.3	Proteins .....	632
25.5.4	Mineral Elements .....	632
25.5.5	Vitamins .....	632
	References .....	633

### 25.1 Cooking

Some foods are consumed raw while others are cooked. There are several reasons for this. Cooking improves the flavor of the food; for instance, the flavor of uncooked flour or sour apples is not very pleasant, but when the flour has been converted into bread and the apples stewed with sugar, their flavor is much improved. In contrast, fresh strawberries are not cooked, as this would spoil the delicious flavor of the raw fruit [4]. Cooking may also improve the attractiveness of food. Eating a raw chop is not much relished, but after cooking, it has an appetizing appearance and a good smell. Even more important, cooking may make a food more digestible. It would be difficult to eat the flesh of a raw chop (or uncooked flour) even if you wanted to, but after cooking, it is much tender and therefore easier to chew and digest. Finally, cooking may improve the keeping quality of a food and make it safe. For example, milk may be boiled to delay the souring process and kill bacteria. The preservation of food by heat treatment is quite distinct from cooking.



Cooking is only one part of food preparation. Apart from the actual cooking process, ingredients may have to be blended together and they may need special preparation by soaking, sieving, or chopping. Seasoning, spices, herbs, and sauces may be used to improve the flavor and color, and garnishes may be added to improve attractiveness, and texture may be improved by grinding, mashing, or mixing.

## 25.2 Cooking Methods

Cooked food is food that has been changed in various ways by heat treatment. The heat may be applied in a number of ways; it may be dry or moist, or it may be applied by means of fat or by infrared radiation [4] (Table 25.1).

### 25.2.1 Dry-Heat Methods

When food is cooked in an oven it is said to be baked. Baking is a rather slow method of cooking, but it has the advantage that large quantities of food can be cooked evenly. Sometimes the food to be cooked is put into the oven in a container containing a little fat; food cooked in this way is said to be roasted. Meat and potatoes are the foods most often cooked by roasting. Cooking temperatures used in an oven vary from below 100°C (very slow) to about 260°C (very hot). Broiling is another method of applying dry heat. The food to be broiled is placed beneath a red-hot source of heat, usually a glowing metal grid. Radiant heat is directed onto the surface of the food, which is rapidly heated. Broiling heat is applied to the top surface of the food, and the food should be turned from time to time. Infrared grilling makes use of heat rays that have longer wavelengths than visible light. Some of the radiation used in normal grilling is of this kind, but in infrared cookery the proportion of infrared radiation is much increased, and this reduces cooking time to such an extent that a steak, for example, may be cooked in a minute.

### 25.2.2 Moist-Heat Methods

Although cooking with water involves using low temperatures, it is a relatively quick method of cooking because water has a great capacity for holding heat and for transferring this heat rapidly to food by means of convection. In moist-heat cooking, food is heated by either water or steam. Boiling uses boiling water; simmering uses water near, but below, the boiling point and is similar to both stewing (for meat and juice) and poaching (for fish). Boil-in-the-bag cooking uses boiling water indirectly, but because the food is sealed in the bag this method prevents loss of flavor and soluble nutrients into the cooking water. In

**TABLE 25.1**

Summary of Cooking Methods

Method of Heating	Method of Cooking	Description
Dry heat	Baking	Cooking carried out in an oven
	Roasting	Baking with the addition of fat
	Grilling	Using direct radiant heat
Moist heat	Boiling	Using boiling water
	Stewing and poaching	Using hot water below its boiling point
	Steaming	Using steam from boiling water
	Pressure cooking	Using water boiling above its normal boiling point
Fat	Frying	Using hot fat
Infrared	Similar to rapid grilling	Using infrared radiation
Microwave	Similar to rapid grilling	Using microwaves

steaming, steam is used directly to heat the food or indirectly to heat the container. Although steaming is slower than boiling, cooking may be sped up by the use of a pressure cooker, in which steam is produced at higher than normal pressure. The increase in pressure raises the temperature at which water boils, so the cooking temperature is increased and the cooking time is reduced.

In essence, a pressure cooker is a pot with a well-fitting lid arranged so that steam can be safely generated under pressure. The pot and lid lock together by means of a groove to make the cooker pressure tight. The food to be cooked and the required amount of water are put into the pot, which is then closed. When the closed pot is heated, air is driven out through the air vent until the cooker is full of steam. In pressure cookers with a pressure indicator, the vent then closes and pressure builds up to the value required. Slow heating alone is then needed to maintain this pressure, which is shown by the pressure indicator. Should the pressure rise too much, steam automatically escapes through the air vent. The fusible plug is a second safety device; this will melt if the cooker overheats or boils dry.

### 25.2.3 Frying

In frying, food is cooked in hot fat. Fat has a much higher boiling point than water and can be heated almost to its boiling point without smoking. Frying is a quick method of cooking because of the high temperature used. In shallow frying, a shallow pan is used and enough fat is added to cover the bottom of the pan. Although such a method is quick, heating of the food is uneven and it should be turned from time to time. Lard, drippings, and vegetable oils (e.g., olive oil, corn oil, and cottonseed oil, often blended together) are best for shallow frying. In deep frying, a deep pan and plenty of fat are used, so that when the food is added it is completely covered by the fat, which is very hot. Temperatures between 150°C and 200°C are usually used, and the temperature of the fat may be checked with a thermometer. Such a method is quick and the food is cooked evenly on all sides. Refined vegetable oils or cooking fats, which are made by hardening a blend of vegetable, animal, and marine oils, are best for deep frying.

### 25.2.4 Microwave Cooking

In ordinary cooking, heat is applied to the outside of food and it gradually penetrates to the inside. In microwave cooking, the heat is generated within the food. In a microwave oven, microwaves penetrate the food and are converted into heat within the food. Thus, the whole food heats up very quickly. Microwaves can only penetrate food to a depth of 3–5 cm; thus, small pieces of food are cooked very quickly. Larger pieces of food are cooked more slowly, however, because where the microwaves cannot penetrate, the food is heated by conduction.

The great advantage of microwave cooking is its speed. For example, a fish fillet is cooked in only 30 s, a chop in 1 min, a chicken in 2 min, and a baked potato in 4 min. For this reason, microwave ovens can be especially useful in places such as canteens, snack bars, and hospitals, where food often has to be kept hot for long periods before it is eaten. Microwave ovens also have some disadvantages. For instance, cooking times must be carefully controlled. In addition, food does not turn brown or develop crispness in a microwave. Crispy bacon or conventional-looking brown crusty chops need to be finished off under the broiler.

### 25.2.5 Slow Cooking

The use of microwave ovens and pressure cookers is intended to speed up cooking, but recently, cookers designed to slow down the cooking process have been introduced. Slow cookers are electrically heated and made of a material with good insulating properties such as earthenware so that heat transfer to the food is slow and a steady temperature is maintained during cooking. Slow cookers work on low power (1 kW) so that the cooking temperature remains below 100°C. The result is that food is cooked at a low, even temperature over a long period, usually 4–6 h. Slow cookers are much more economical to operate than conventional ovens. Slow cooking is ideal for cooking casseroles, stews, and cheaper, tougher cuts of meat so that they become tender, facilitating reduction in weight loss by evaporation. It also prevents loss of juices because the slow cooker is sealed and no moisture escapes.

---

### 25.3 Application of Heat

The three common systems of heat application are [21]:

1. Indirect heating by combustion gases conducted through flues, radiators, or past surfaces of the baking chamber such as the underside and backside of the chamber
2. Semidirect heating in which a part of the combustion gases are forced into the baking chamber to create pronounced convection currents
3. Direct heating using electricity or gas with ribbon-type burners

A fourth, indirect method that utilizes high-pressure steam tubes is used to a very limited extent. The indirect firing system utilizes isolated combustion chambers from which the hot combustion gases are circulated by either suction or pressure through a bank of radiator tubes and are either returned to the combustion chamber or vented to an exhaust flue. The radiator tubes, which transverse the baking chamber, give up their heat by radiation and convection to the baking chamber. Depending upon the size of the oven, several combustion chambers or unit heaters may be used, each equipped with a burner, circulating fans, ducts, radiator tubes, and temperature controllers. The radiator tubes can be so arranged that radiated heat is applied to both the top and bottom of the pans. Because of the inherent limitation of the radiating heating surface that can be designed into an oven, the heating efficiency of indirect-fired ovens is generally less than that of direct-fired ovens.

The semidirect firing system resembles the indirect system in using a separate combustion chamber and relying on radiator tubes to carry the hot combustion gases to the baking chamber. Here, however, the radiators are provided with either thin slots or small holes so that the hot gases are forced into the oven chamber, thereby creating extensive convection chambers, which are further augmented by a forced draft. In this system, the baking effect is produced by convectional and radiational heat, and in this way advantage is taken of the special benefits offered by both methods of heat transfer.

In direct gas-fired ovens, ribbon burners are placed directly in the baking chamber, crosswise to the travel of the oven trays or conveyors. Originally, an air-gas mixture was supplied to the burners by an aspirator in which the combustion air was drawn into the mixing unit by the vacuum created when the gas was forced through the gas orifice under pressure. Each burner has its own gas control valve, which must be manipulated individually for heat control. The aspirator system has a number of disadvantages, principal among which is its tendency to flame out under certain operating conditions, thereby creating hazardous oven conditions.

A safer and more efficient firing method has been devised in which gas and air are mixed prior to being fed through a common header to the individual ribbon burners. In this system, filtered air is supplied to an air-gas mixing unit. One such unit is provided for each oven zone consisting of as many as 15 or more ribbon burners. In this way, all burners in one zone can be throttled uniformly by means of a single zone control valve. The unit mixer in which the air and gas are mixed is under pressure for each individual ribbon burner. With this system, the gas and air headers for each top and bottom heat zone are provided, respectively, with a zero gas regulator and an air valve controlled by an automatic temperature controller. The gas regulator and air valve operate together to uniformly supply the correct amounts of gas and air to the unit mixer in the zone. For balancing the heat distribution across the width of the oven, flame distributor-type burners are used, which provide a three-zone control of the burner flame across the oven.

The direct gas-fired system is the simplest and most efficient method of oven heating. By proper design and distribution of ribbon burners, uniform gas consumption can be obtained throughout the oven. The velocity of the combustion gases coming out of the burner ports, together with the natural convection currents created by the generated heat, supplies sufficient turbulence to produce fairly uniform temperatures throughout the chamber as long as the size, number, and location of the burners are adequate and the control equipment is correctly engineered and installed. In some direct-fired ovens, forced convection is applied to obtain a more efficient utilization of the heat energy by recirculating the chamber atmosphere past the ribbon burners rather than venting it to outside.

In the steam-tube system, oven heating is performed by a series of high-strength, hermetically sealed tubes, which are partially filled with water or a heat-stable liquid possessing a high boiling point. The tubes

are installed in the oven so that a short portion of each tube protrudes into the combustion chamber, where direct heat is applied to cause the water to vaporize into high-pressure steam. The balance of the tube extends into the baking chamber. The tubes are slightly inclined toward the firebox so that steam condensate returns to the heated ends to be revaporized. Because saturated steam at atmospheric pressure has a temperature of 100°C, and because baking temperatures are normally within the range of 182°C–232°C, it is evident that considerable pressure must be developed in the steam tubes to attain baking temperatures.

Heat transfer in this system is principally by radiation and is, hence, governed by the physical law that states that the heat rays radiated from any one source vary inversely to the square of their distance. Therefore, the steam tubes must attain much higher temperatures than the actual baking temperature. The magnitude of the pressure developed within the tubes is indicated by the fact that a temperature of 335°C requires a steam pressure of 13,800 kPa. The use of steam tubes as a method of oven heating has been largely discontinued, as it is relatively inefficient and lacks the necessary flexibility of heat control.

---

## 25.4 Cooking Equipment

The objectives of the cooking process are to reduce the moisture content of the product mixture, melt, solubilize, caramelize, if necessary, and invert. There are many types of cooking equipment, which may be classified in several ways for the convenience of discussion. According to the working mode, they are batch cookers, semicontinuous cookers, and continuous cookers. According to the method of heating, they come as direct-fired cookers or steam-jacketed cookers. According to the working pressure, they are atmospheric cookers, pressure cookers (steam-injection cookers), and vacuum cookers.

### 25.4.1 Batch Cookers

#### 25.4.1.1 Steam Kettles

Food preparation of liquids and pumpable foods (including particles) is carried out in kettles or heat exchangers. Kettles are used in batch operations. Heat is supplied to the foods through the kettle wall from condensing steam in the steam jacket covering most of the kettle wall. The jacket is equipped with an air-venting valve and a condensate-removal system with a steam trap. The food is transported to and from the wall into the bulk of the food by a flow created by the density differences between hot and cold product or by mechanical agitation [18]. The free convection flow develops easily when the heat supply is sufficient for a rapid steam pressure build-up in the jacket. In the flow pattern, only a thin layer of the fluid close to the wall will be involved in the heat transfer. The heated fluid will rise to the top of the volume and spread over the top surface. The major part of the volume will slowly fall toward the bottom, where it will contact the heat-transfer surface again.

Models of steam kettles differ in relation to (a) depth, which may be deep or shallow, (b) steamjacketing, which may be full or 2/3, (c) mounting, which may be on legs, a pedestal, or wall-mounted, (d) type, such as tilting or stationary, and (e) source of steam, which may be direct or self-generated. The materials commonly used are aluminum and stainless steel; the finish may be dull or polished. All steam equipment should have safety valves and pressure gauges. Those having self-generated steam should have an automatic low-water cutout and a thermostatically controlled cutout heat. Tilting kettles should have a secure device for stopping them at any desired degree of tilt.

#### 25.4.1.2 Steam Cookers

Steam cookers vary in (a) number of compartments (single or in stacks of two or three) and size, (b) source of steam, (c) type of base, and (d) design. Steamers should have heavy-duty gaskets. Cooking containers must be suitable for the material to be cooked, should minimize handling, and should permit suitable load size for workers to lift. The use of serving pans may often minimize transfer.

#### 25.4.1.3 Vacuum Cookers

This system is used for the production of hard candy, jelly, gum candies, and low-boiled sweets. The main components of the vacuum cooker consist of a cooking chamber, a kettle under it with a vacuum

facility, a stirrer inside the cooking chamber with a variable-speed drive, a vacuum pump with spray condenser and control system. The finished product is discharged into the kettle and hence is called draw off kettle [7]. The ingredients are fed into the cooking chamber manually or by dosing. The cooking temperature and time are controlled automatically. The product after cooling is discharged into the draw-off kettle through suction created by vacuum pump. During this process, the cooked mass will be evaporated under vacuum pump. The draw-off kettle is lowered after reversing the vacuum to unload the product.

#### **25.4.1.4 Rotary Cereal Cooker**

This is a single rotating pressure cooker, controlled either automatically or manually and mounted on a horizontal axis. The cooker consists of a stainless-steel barrier with slide valve or door for charging and discharging; steam is injected at 200 kPa working pressure through a flexible hose and rotary union [1]. The pressure cooker consists of an all-welded stainless-steel double-conical barrel with annular rings at each end to which are bolted end plates. The barrel has a centrally positioned opening fitted with door for charging and discharging. Steam injection is through a 50-mm-diameter stainless-steel braided flexible hose and rotary union mounted at the end of each stub shaft. Steam passes through the center of each shaft into a stainless-steel steam chest, which is integral with the shaft and end plate. Steam injection and exhaust are controlled through a system of stainless-steel ball valves. Pressure in the cooker is indicated at each end by a pressure gauge.

### **25.4.2 Continuous Cookers**

#### **25.4.2.1 Pressure Cookers/Blanchers**

*The Balfour continuous pressure cooker.* This cooker can handle particulate foodstuffs ranging from cereals and diced vegetables to regular whole beet roots and potatoes, including diced meat. It is designed for the continuous feeding of process materials into and removal from the cooking vessel, which utilizes steam under pressure. The retention time of the process material can be strictly controlled and varied according to requirements [1]. The main cooking section consists of a plain helical screw conveyor operating within a circular body—the body being designed to operate at the maximum steam pressure. Pressure lock systems are fitted at both the inlet and outlet ends. The size of the cooker is directly proportional to the required cooking time and inversely proportional to the total process time [8].

*The Turboflo blancher/cooker.* It uses a unique steam injection and energy-circulation system for blanching and cooking potatoes, vegetables, fruits, meats, and poultry. It combines the benefits of energy efficiency and improved product quality and saves processing time and also requires less floor space. The cooker achieves process time savings of up to 30%. The fully enclosed and insulated chamber prevents steam from escaping and saves energy cost. Products blanched in this cooker retain more nutrients and have both better color and taste, and thus customer appeal. The energy-circulation method features a fan-driven steam path, which penetrates the product mass evenly to assure thorough blanching/cooking of product. The modular section design provides maximum flexibility for food processors [27].

#### **25.4.2.2 Steam Cookers**

A continuous steam cooker has been developed at the Central Food Technological Research Institute (CFTRI). The equipment is a continuous conveyor with a facility for open steaming into the chamber. A water inlet is provided through a flow meter to add a measured quantity of water during processing. The chamber is steam jacketed for additional heating. A variable-speed drive is provided to vary the residence time of cooking. A rotary valve is fixed at the inlet end to control the material feed rate. The conveyor speed and the rotary valve speed are matched with sprocket and chain drive [22]. A stationary water-draining device having an SS trough and SS and nylon sieving screens is installed at the discharge of the machine, which greatly helps in the quick separation of water from the cooked product.

The product to be cooked is carefully washed and water is fed into the cooker at a measured rate (flow rate depending upon the output and variety). Steam is let into the system by opening the steam valves at controlled pressures. Steam supply is maintained at a constant rate for both the spreader and the jacket. The product is continuously fed from the hopper through the rotary valve at the required rate. At the end

of the set residence time, uniformly cooked product is discharged through the outlet chute. The product is collected from the mesh and is ready for consumption.

### 25.4.2.3 Microfilm Cookers

Microfilm cookers are available as atmospheric or vacuum cookers. They are suitable for all types of high boiling and can also be used for low boiling. They are very efficient cookers using the scraped-film principle, which results in extremely rapid cooking. This reduces process inversion to a minimum. The scraped film also means that confectionery containing milk products can be handled on this machine without the risk of burning or the need for frequent cleaning [1]. The principal use of this machine is for feeding depositing plant or continuous cooling bands. In the case where a depositor is to be fed, a vacuum cooker should be chosen. The plant starts with a freestanding stainless-steel reservoir for dissolved syrup. This is fitted with inlet filters. The syrup is pumped from the holding tank into the cooker by an infinitely variable syrup feed pump, which has a manually adjusted control. The preheater, rotor, syrup feed pump, discharge pump, vacuum pump, metering pumps, electrical control panel, and steam controls are all mounted on a column framework.

The rotor is a scraped film evaporator made up of a bronze steam-jacketed tube with a high-speed rotor fitted inside the center. The rotor has hinged blades, which wipe the inner surface of the tube. The sugar is spread in a very thin film and is moved through the cooking tube by a combination of gravity and the design of the hinged blades. The cooked sugar is discharged from the microfilm cooker in one of the two ways, either by gravity from the base of the rotor or by a discharge pump and delivery pipe. Gravity discharge can only be used in the case of atmospheric cooking. Where vacuum cooking is used, a discharge pump is necessary to withdraw the sugar from the vacuum. A discharge pump can also be used with an atmospheric cooker.

---

## 25.5 Effects of Cooking on Nutrients

During cooking, great changes take place in the nature of food. Different foods behave in different ways when cooked. These effects apply to all foods [4].

### 25.5.1 Fats

When fats are heated they melt, and if they contain water it is driven off as water vapor. At 100°C fats containing water appear to boil; this is caused by the water being given off as steam. Fats are stable to heat and can be heated almost to their boiling point before they start to break down. It is because of this fact—and also because they have high boiling points—that fats are used for cooking. When fats are heated too much, they break down, producing an unpleasant-smelling smoke. Fat on the outside of meat and in bacon darkens in color on strong heating, and if the temperature is too high some breakdown and charring may occur. Unsaturated fatty acids are more susceptible to oxidation than their saturated analogs and polyunsaturated content in aquatic species was demonstrated to decrease during storage and cooking [5,19,24,26]. It was found that polyunsaturated fatty acids content remained unchanged in some kinds of products under certain cooking methods [5,17]. Gladyshev et al. [14] studied the fatty acids in fillets of unfrozen, boiled, fried, roasted, and boiled in a small amount of water humpback salmon. Heat treatment in general did not decrease the content of polyunsaturated fatty acids of  $\omega$ -3 family (eicosapentaenoic [EPA] and docosahexaenoic [DHA]), except for a modest reduction during frying. Cooked humpback appeared to be the valuable source of essential  $\omega$ -3. It was hypothesized that the absence of significant reduction of polyunsaturated fatty acids in red flesh of fishes of salmon family during heat treatment may be due to a high level of natural antioxidants, which formed in the course of evolution as adaptation to their ecological niche [14].

### 25.5.2 Carbohydrates

When exposed to dry heat, carbohydrates are broken down and darken in color. For example, sucrose browns on caramelization and finally chars and becomes black, while starch is broken down into more easily

digested dextrin and also darkens and eventually chars. Many foods that contain both sugars and protein turn golden brown and change flavor on heating. These changes occur in the toasting of bread and the baking of bread, cakes, and biscuits, and contribute to the pleasant flavor and attractive color of these products.

When a mixture of starch and water is heated, the starch granules absorb water and swell and gelatinize, forming a thick white paste. This is why starchy material (e.g., flour) is used to thicken sauces. On cooling, the paste sets and forms a gel. Uncooked starchy foods are difficult to digest because the digestive juices cannot penetrate into the starch grains. Cooking causes the starch granules to swell and gelatinize.

The polysaccharides starch, cellulose, and pectin are important constituents of fruits and vegetables. On cooking, insoluble cellulose changes little, except to soften, whereas starch softens as it gelatinizes and pectin becomes more soluble and dissolves somewhat, allowing cells to separate and make the fruit and vegetable easier to eat. Fruits with a high pectin content, such as apples, become soft and pulpy on cooking.

### **25.5.3 Proteins**

Proteins undergo great changes when they are heated. Many proteins coagulate when heated, for example, egg white coagulates when it is heated above 60°C. As proteins coagulate they become solid. For example, when milk is heated a skin forms because some of the proteins have coagulated. Cheese is another important protein food, and when it is heated it softens and on further heating some of the proteins coagulate and the cheese becomes stringy and tough. Not all proteins coagulate on heating, which is important when considering how to cook protein foods. Collagen and elastin, for example, are two important insoluble proteins in meat, and because they are not soluble they are not easily digested. Their presence in meat makes it tough, and as the cheaper cuts of meat usually contain more collagen and elastin than more expensive ones, they are usually tougher. Tough meat must be cooked in a way that will make it tender. If such meat is cooked at high temperatures for long periods it remains tough or may even become tougher. Tough meat needs to be cooked slowly using low temperatures; both dry-heat and moist-heat methods may be used.

Tough meat is often cooked slowly using moist heat (e.g., stewing). This converts the tough collagen into gelatin. Gelatin is a soluble protein and so is easily digested. Slow cooking using dry heat is also effective in converting collagen into gelatin. Elastin softens on cooking, but not to the same extent as collagen. Bertram et al. [3] studied the thermal denaturation of meat protein by Nuclear Magnetic Resonance (NMR) and Differential Scanning Calorimetry (DSC). The denaturation of myosin rods and light chains occurred at 53°C–58°C, and heat-induced changes in myofibrillar water as well as between actin denaturation at 80°C–82°C and expulsion of water from meat.

### **25.5.4 Mineral Elements**

Heat does not affect mineral salts found in food because they are stable substances that do not break down at the temperatures used in cooking. Moist-heat methods of cooking, such as stewing and boiling, cause loss of salts, which are soluble in water. Boiled fish, for example, is rather tasteless because of the considerable loss of mineral salts that occurs during cooking. However, the salts are present in the water in which the fish has been boiled, and this liquid or stock can be used for making a tasty sauce to eat with the fish.

### **25.5.5 Vitamins**

Dry-heat cooking methods destroy those vitamins, which are unstable to heat. Vitamin C is destroyed at quite low temperatures, and so all methods of cooking cause some loss of this vitamin. To make the loss as small as possible, foods containing vitamin C should be cooked for as short a time as possible and should be eaten as soon as they are cooked. Two of the B vitamins, thiamine and riboflavin, are unstable at high temperatures. Riboflavin is the more stable of the two, and little is lost except at high cooking temperatures, such as those used in rapid grilling. Thiamine is largely destroyed at high temperatures, such as are used in grilling and roasting. Cooking with moist heat causes loss of water-soluble vitamins, as well as those that are destroyed at low temperatures. Vitamin C is both soluble in water and unstable to heat, and therefore some loss during cooking cannot be avoided. Vitamin C is also destroyed by

oxygen present in air and dissolved in cooking water. Leaching is also the main reason for high losses of ascorbic acid during cooking. The rate of destruction is hastened by enzymes present in the plant or fruit. These enzymes are set free by crushing or chopping. Different studies found a decrease of ascorbic acid by boiling up to 75% [15,20,25].

The B vitamins are soluble in water in varying degrees, thiamine being the most soluble. A considerable proportion of the thiamine in foods may be lost during cooking, especially if they are boiled in alkaline solutions. For this reason alkaline substance, such as sodium bicarbonate, are not added to green vegetables to prevent loss of green color during cooking. The amounts of the other B vitamins lost during cooking are small and not important. Vitamins A and D are insoluble in water and stable except at high temperatures. There is therefore little, if any, loss of these vitamins during cooking.

In green vegetables,  $\beta$ -carotene is incorporated in the carotenoid-protein complexes in the chloroplasts. These carotenoproteins have an inhibitory effect upon carotenoid digestion and absorption [2]. In orange or red fruits,  $\beta$ -carotene is dissolved in oil droplets in the chromoplasts and can be readily extracted during digestion [6,11,30]. Food preparation, e.g., mincing and cooking, can increase the extractability and therefore the bioavailability of  $\beta$ -carotene from the food matrix by softening or disruption of plant cell walls and the destruction of carotenoid-protein complexes [12,13,16,29]. Cooking can also lead to an isomerization of the natural mainly in the all-*trans*-form-occurring  $\beta$ -carotene to its *cis*-isomers. *cis*-Isomers are less bioavailable and the provitamin A activity is lower [9,10]. Bernhardt and Schlich [2] studied the influence of different domestic cooking methods (boiling, stewing, steaming, pressure steaming, and microwave) on the all-*trans*- and *cis*- $\beta$ -carotene as well as the  $\alpha$ -tocopherol content in fresh and frozen broccoli and red sweet pepper. In fresh broccoli, all cooking methods lead to a significant release of all-*trans*- $\beta$ -carotene. In frozen broccoli, no change of  $\alpha$ -tocopherol occurred. In fresh and frozen peppers, no change or a significant loss of  $\alpha$ -tocopherol and all-*trans*- and *cis*- $\beta$ -carotene was observed. A slight increase in the *cis*-isomers of  $\beta$ -carotene can only be found by cooking fresh broccoli. Oxidation promoted by the presence of light, heat, and oxygen is the main reason for destruction of carotenoids [23,28].

---

## References

1. Baker Catalogue, *Baker Perkins Catalogue on Microfilm Cookers and Cereal Cookers*, Baker Perkins, Westfield Road/Peterborough, England.
2. S. Berberhardt, E. Schlich, Impact of different cooking methods on food quality: retention of lipophilic vitamins in fresh and frozen vegetables, *Journal of Food Engineering* 77: 327–333 (2006).
3. H. C. Bertram, Z. Wu, F. van den Berg, H. J. Andersen, NMR relaxometry and differential scanning calorimetry during meat cooking, *Meat Science* 74(4): 684–689 (2006).
4. A. Cameron, Cooking. I. Methods and effects on nutrients, in *The Science of Food and Cooking*, 2nd ed. (A. Cameron, ed.), Edward Arnold Publishers, London, 1978, p. 187.
5. M. Candella, I. Astisaran, J. Bello, Deep-fat frying modifies high-fat fish lipid fraction, *Journal of Agricultural and Food Chemistry* 46: 2793–2796 (1998).
6. J. J. M. Castenmiller, C. E. West, Bioavailability and bioconversion of carotenoids, *Annual Reviews of Nutrition* 18: 19–38 (1998).
7. L. M. Cheng, Cooking machines, in *Food Machinery for the Production of Cereal Foods, Snack Foods and Confectionary* (L. M. Cheng ed.), Wood Head Publication, New York, 1992, p. 224.
8. Continuous pressure cooker, *Food Manufacture* 50(4): 68 (1975).
9. D. M. Deming, D. H. Baker, J. W. Erdman, The relative vitamin A value of 9-*cis*  $\beta$ -carotene is less and that of 13-*cis*  $\beta$ -carotene may be greater than the acceptable 50% that of all-*trans*  $\beta$ -carotene in gerbils, *Journal of Nutrition* 132: 2709–2712 (2002).
10. D. M. Deming, S. R. Teixeira, J. W. Erdman, All-*trans*- $\beta$ -carotene appears to be more bioavailable than 9-*cis* or 13-*cis*- $\beta$ -carotene in gerbils given single oral doses of each isomer, *Journal of Nutrition* 132: 2700–2708 (2002).
11. S. De Pee, C. E. West, D. Permaesih, S. M. Muhilal, J. Hautvast, Orange fruit is more effective than are dark-green, leafy vegetables in increasing serum concentration of retinol and  $\beta$ -carotene in schoolchildren in Indonesia, *American Journal of Clinical Nutrition* 68: 1058–1067 (1998).
12. J. M. Dietz, S. S. Kantha, J. W. Erdman, Reversed phase HPLC analysis of  $\alpha$ - and  $\beta$ -carotene from selected raw and cooked vegetables, *Plant Food for Human Nutrition* 38: 333–341 (1988).



13. J. W. Erdman, C. L. Poor, J. M. Dietz, Factors affecting the bioavailability of vitamin A, carotenoids, and vitamin E, *Food Technology* 42: 214–221 (1988).
14. M. I. Gladyshev, N. N. Sushchik, G. A. Gubanenko, S. M. Demirchieva, G. S. Kalachova, Effect of way of cooking on content of essential polyunsaturated fatty acids in muscle tissue of humpback salmon (*Oncorhynchus gorbuscha*), *Food Chemistry* 96: 446–451 (2006).
15. M. F. Gould, D. Golledge, Ascorbic acid levels in conventionally cooked versus microwave oven cooked frozen, *Food Sciences and Nutrition* 42F: 145–152 (1989).
16. L. A. Howard, A. D. Wong, A. K. Perry, B. P. Klein,  $\beta$ -Carotene and ascorbic acid retention in fresh and processed vegetables, *Journal of Food Science* 64: 929–936 (1999).
17. N. Montano, G. Gavino, V. C. Gavino, Polyunsaturated fatty acid contents of some traditional fish and shrimp paste condiments of Philippines, *Food Chemistry* 75: 155–158 (2001).
18. Ohlsson, Boiling in kettles and scraped surface heatexchangers, *Proceedings of IUFoST*, Sweden, June 8–11, 1968, p. 71.
19. T. Ohshima, K. Shozen, H. Usio, C. Koizumi, Effects of grilling on formation of cholesterol oxides in seafood products rich in polyunsaturated fatty acids, *Food Science and Technology* 29: 94–99 (1996).
20. M. A. Petersen, Influence of sous vide processing, steaming and boiling on vitamin retention and sensory quality in broccoli flowerets, *Food Science and Technology* 197: 375–380 (1994).
21. E. J. Pyer, Oven equipment, in *Baking Science and Technology*, Vol. 2 (E. J. Pyer, ed.), Siebel Publishing, Chicago, 1973, p. 1128.
22. M. N. Ramesh, P. N. S. D. Rao, Development and performance evaluation of a continuous rice cooker, *Journal of Food Engineering* 27: 377 (1996).
23. D. B. Rodriguez-Amaya, Carotenoids and food preparation: the retention of provitamin A carotenoids in prepared, processed, and stored food, USAID, OMNI Project.
24. L. S. Sant'Ana, J. Mancini-Filho, Influence of the addition of antioxidants in vivo on the fatty acid composition of fish fillets, *Food Chemistry* 68: 175–178 (2000).
25. M. Schnepf, J. Driskell, Sensory attributes and nutrient retention in selected vegetables prepared by conventional and microwave methods, *Journal of Food Quality* 17: 87–99 (1994).
26. C. R. T. Tarley, J. V. Visentainer, M. Matsushita, N. E. De Souza, Proximate composition, cholesterol and fatty acids profile of canned sardines (*Sardinella brasiliensis*) in soybean oil and tomato sauce, *Food Chemistry* 88: 1–6 (2004).
27. Turboflow blancher/cooker, *Food Technology in New Zealand* 10(4): 37 (1975).
28. J. H. Von Elbe, S. J. Schwartz, Colorants, in *Food Chemistry*, 3rd ed. (O. R. Fennema, ed.), Marcel Dekker, New York, 1996.
29. K. H. Van Her Hof, B. C. J. De Boer, L. B. M. Tijburg, B. Lucius, I. Zijp, C. E. W. West, Carotenoid bioavailability in humans from tomatoes processed in different ways determined from the carotenoid response in the triglyceride-rich lipoprotein fraction of plasma after a single consumption and in plasma after four days of consumption, *Journal of Nutrition* 130: 1189–1196 (2000).
30. M. Vishnevetsky, M. Ovadis, A. Vainstein, Carotenoid sequestration in plants: the role of carotenoid-associated proteins, *Trends in Plant Science* 4: 232–235 (1999).

# 26

## *Food Preservation by Freezing*

Mohammad Shafiur Rahman and Jorge F. Velez-Ruiz

### CONTENTS

26.1	Freezing in Biological Materials .....	636
26.2	Mode of Preserving Action .....	636
26.3	Quality of Frozen Foods .....	637
26.3.1	Freezing Rate and Quality .....	637
26.3.2	Microbial Aspects .....	638
26.3.3	Physical Changes and Quality .....	639
26.3.3.1	Free and Bound Water .....	639
26.3.3.2	Weight Loss.....	640
26.3.3.3	Recrystallization .....	640
26.3.3.4	Retrogradation.....	640
26.3.3.5	Protein Denaturation .....	640
26.3.3.6	Freezer Burn .....	641
26.3.3.7	Glass Formation .....	641
26.3.3.8	Functional Properties .....	641
26.3.4	Chemical Changes and Quality .....	643
26.3.4.1	Rancidity .....	643
26.3.4.2	Color, Flavor, and Vitamin Loss .....	644
26.3.4.3	Release of Enzymes .....	646
26.3.4.4	Hydrolysis .....	646
26.3.4.5	Acetaldehyde Formation .....	646
26.3.5	Processing and Packaging Factors .....	647
26.3.5.1	Pretreatments for Freezing .....	647
26.3.5.2	Storage and Display .....	651
26.3.5.3	Thawing .....	652
26.3.6	Cold Chain Tolerance and Quality.....	652
26.3.6.1	Temperature Cycling.....	652
26.3.6.2	Time-Temperature Tolerance Indicators .....	652
26.4	Freezing Methods .....	653
26.4.1	Freezing by Contact with a Cooled Solid: Plate Freezing .....	653
26.4.2	Freezing by Contact with a Cooled Liquid: Immersion Freezing.....	653
26.4.3	Freezing by Contact with a Cooled Gas .....	654
26.4.3.1	Cabinet Freezing .....	654
26.4.3.2	Air-Blast Freezing.....	654
26.4.4	Cryogenic Freezing .....	655
26.5	Emerging Freezing Techniques .....	655
26.6	Addition to Hurdle Technology.....	656
26.7	Future Research in Freezing Process .....	656
	References .....	657

---

## 26.1 Freezing in Biological Materials

Freezing provides a significant extended shelf life and has been successfully employed for long-term preservation of many foods. Freezing is still one of the most widely used methods of food preservation even though several new technologies, such as high pressure, infrared irradiation, pulsed electric field, and ultrasound, are gaining importance. Freezing processes are continuing to emerge. Freezing changes the physical state of a substance by changing water into ice when energy is removed in the form of cooling below freezing temperature. Usually, the temperature is further reduced to storage level (e.g.,  $-18^{\circ}\text{C}$ ). The freezing process can be clearly shown by using freezing or cooling curves and phase diagrams. The terminologies of the freezing process (e.g., precooling, supercooling, freezing, tempering, eutectic, ice nucleation, and glass transition) are discussed in Chapter 15.

---

## 26.2 Mode of Preserving Action

The freezing of foods slows down, but does not stop, the physicochemical and biochemical reactions that govern the deterioration of foods [69]. During storage, there is a slow progressive change in organoleptic quality, which does not become objectionable for some time [176]. The loss of quality of frozen foods depends primarily on storage temperature, length of storage time, and thawing procedure. Microbial growth is completely stopped below  $-18^{\circ}\text{C}$ , and both enzymatic and nonenzymatic changes continue at much slower rates during frozen storage [142].

The freezing process reduces the random motion and rearrangement of molecules in the matrix [88,111,142]. Freezing involves the use of low temperatures, and reactions take place at slower rates as temperature is reduced. The presence of ice and an increase in solute concentration can have significant effects on the reactions and the state of the matrix [167]. The final influence of temperature on chemical reactions due to freezing could be grouped as: (a) normal stability (a temperature decrease results in a slower reaction rate, thus better stability when foods are stored); (b) neutral stability (the temperature has no influence on the reaction rate); or (c) reversed stability (a temperature decrease results in an increased reaction rate) [159]. Regardless of the type of aqueous system, concentration during freezing causes the unfrozen portion to undergo marked changes in physicochemical properties such as ionic strength, pH, viscosity, water activity, surface and interfacial tension, and oxidation–reduction potential. It is important to note that oxygen is almost totally expelled from ice crystals as they are formed [159]. Reid [167] reviewed three types of cell damage due to freezing: osmotic damage, solute-induced damage, and structural damage.

In slow cooling, ice forms slowly in the external cells. If there is sufficient time, water from the cells migrates out by osmotic pressure. This results in cell shrinkage and some membrane damage. This water does not return to the cells on thawing due to the damage to the cell wall, and the consequence is drip loss [167]. The concentration of the solute increases as freezing progresses. Thus, high solute concentrations of the unfrozen matrix, in particular high salt, can cause damage to many polymeric cell components and may kill the cell [139]. This concentration effect is present irrespective of whether freezing is fast or slow. Cryoprotectants, such as sugars, are usually added to the aqueous phase to reduce salt-induced damage [167]. In addition to the concentration effect, the formation of ice within the cell may cause damage to the delicate organelle and membrane structure of the cell. As a consequence, enzyme systems may be released, leading to a variety of effects, including off-flavor production. This can be prevented by blanching, a prefreezing heat treatment that denatures enzymes [167].

Reid [167] maintains that it is possible to design and control a convenient freezing process through the knowledge of the mechanisms of damage for each particular food item. In general, freezing preservation is far from perfect, and awareness of this fact is needed if techniques are to be developed to overcome known shortcomings and assure that this method remains competitive with the other major methods of food preservation [54]. A strategic quality approach (quality enhancement) may provide a higher success rate for new frozen food products [178]. Product quality improvement and energy reduction or increased process efficiency are major issues related to the freezing process.

---

## 26.3 Quality of Frozen Foods

### 26.3.1 Freezing Rate and Quality

Controlling the freezing process, including careful prefreezing preparation and postfreezing storage of the product, is an important aspect of achieving a high-quality product [69]. An important factor in the quality of frozen foods is the freezing rate [186]. Generally, fast freezing produces better quality frozen food than slow freezing, although the reason for this is not as well understood as is sometimes stated. The rate of freezing of plant tissue is important because it determines the size of the ice crystals, cell dehydration, and damage to the cell walls. Ice crystal structure is crucial for the preservation of the quality of frozen products [211].

In the case of animal tissue, the concentration of salt within the cells is higher than that in the extracellular region. Consequently, freezing will start outside the cells due to the freezing point depression induced by the solute concentration in the cells. As soon as ice appears, the solute concentration rises. This is a characteristic phenomenon of freeze concentration. At some point, osmotic pressure difference causes water to flow through the semipermeable cells to the extracellular region to balance the chemical potentials. This dehydration of the cell is accompanied by shrinkage of the cell, which is not normally lethal. The freezing rate affects this process because rapid freezing results in less cell dehydration (since water has less time to diffuse out of the cell), less breakage of cell walls, and less textural damage. The more rapid the crystallization, the smaller the ice crystals, and the lesser the damage caused by the process of freeze concentration. Consequently, a reverse situation holds for thawing. Slow heating allows equilibrium to be reached as the melted water diffuses back through the cell wall.

In the case of plant tissue, there is evidence that large ice crystals can cause mechanical damage to cell walls in addition to cell dehydration. In agarose gels, large ice crystals (100–300  $\mu\text{m}$ ) with increasing interstitial spaces grow under slow freezing conditions at  $-25^{\circ}\text{C}$ , while small ice crystals (1–2  $\mu\text{m}$ ) form during rapid freezing in liquid nitrogen [12]. Bevilacqua et al. [16] measured the diameter of the intracellular dendrites and extracellular ice crystals for meat frozen under simulated conditions similar to industrial freezing. They correlate the ice crystal diameter with the characteristic freezing time. De Kock et al. [40] studied the effect of freezing rate (cryogenic, fast; mechanical, slow) on the quality of cellular and noncellular precooked starchy foods. Quality was determined immediately after freezing, as well as after frozen storage, by chemical, physical, microscopic, and sensory methods. The rapid freezing of cellular starchy food resulted in a better quality product than slow freezing immediately after freezing. Rapid freezing of noncellular starchy food, however, produced a product that was only slightly better in quality than the slowly frozen product. After storage, the rapidly frozen cellular product was still better in quality than the slowly frozen product, although the difference was smaller. The slight advantage gained by rapid freezing of the noncellular product was lost during storage [40].

Symons [187] expressed that undue emphasis on the importance of freezing speed is sometimes misleading. Unless freezing is excessively slow, days or weeks rather than hours, most products are comparatively insensitive to the speed of freezing. In any case, an increase in volume of around 10% is associated with freezing of most foods. Broadly speaking, faster is marginally better than slower in most of the food products. This is particularly true for fruit and vegetable products, but less so for animal tissue [187]. Moreover, the initial advantage obtained by fast freezing is lost during storage due to recrystallization [40]. Although fast freezing has advantages, some products will crack or even shatter if exposed directly to extremely low temperature for a long period of time. Hung and Kim [88] reviewed the fundamental aspects of freeze cracking and strategies for its prevention. The mechanisms to explain freeze cracking vary. The proposed mechanisms are

1. *Volume expansion*: The volume expansion due to the formation of ice and the amount of empty space in a microstructure are the primary factors affecting the degree of mechanical damage to cells during freezing. In addition, differences in moisture content, composition, or amount of unfreezable water may cause different degrees of cracks [55].
2. *Contraction and expansion*: Cracking may also occur to relieve the product of internal stress from nonuniform contraction during rapid cooling [165,209]. However, both contraction and expansion may cause freeze cracking [175].

3. *Internal stress*: Fast freezing will cause crust formation at the surface, which serves as a shell and prevents further volume expansion when the internal portion of the unfrozen material undergoes freezing. This process then contributes to the internal stress buildup later in the freezing process. The freeze cracking will occur if the internal stress exceeds the strength of the exterior frozen material during processing [105]. The distribution of the stress is the controlling factor, and it is governed by absorbing (dissipating) the stress into the structure or reflecting the stress to cause buildup of internal stress [106].

Miles and Morley [140] studied the internal pressures and tensions in meat during freezing, frozen storage, and thawing. A maximum stress of almost 6000 kPa is possible. They found that during freezing internal compression developed at a rate that increased as freezing progressed, and most of the pressure was developed after the center had started to freeze. Generally, the circumferential tension in the outer surface of the muscle reached a breaking point, and a shallow crack formed along the length of the muscle or the surface yielded, causing a bulge [140]. Kim and Hung [106] found that size, moisture content, density, modulus of elasticity, Poisson's ratio, and porosity all had significant influence on freeze cracking. However, no single property completely explained the development of freeze cracking [106]. Excessive freezing speeds can ruin a food product. The buildup of internal pressure during very rapid freezing shatters the already frozen external layers and produces very small crystals, leading to scattering of incident light [187]. The current practice of quick freezing is generally chosen to save processing time (cost) and factory space. Moreover, rapidly chilled muscles become tough on freezing and thawing, a phenomenon known as cold shortening, which is not a problem in poultry [187].

In foods containing microbial cultures, it is important to maintain their activity. Rapid freezing causes detrimental effects on yeast activity of frozen dough. This may be due to the formation of intracellular ice crystals invariably lethal to yeast cell membranes [138]. Yeast activity decreased significantly when the rate of cooling was increased from 0.98 to 1.57°C/min [146].

### 26.3.2 Microbial Aspects

The detrimental effects of freezing on microorganisms may be desirable or undesirable, depending on the types of food products. In frozen foods without any added beneficial cultures, microbial growth or spoilage is not desirable, whereas care must be taken to reduce the damage in cells during freezing of foods containing microbial cultures. The maximum recommended storage temperature at which microbiological spoilage ceases is registered between  $-9^{\circ}\text{C}$  and  $-12^{\circ}\text{C}$ . Although microbiological spoilage can be avoided at these temperatures, the enzymes present in the product will still play a part in spoilage. Hence, hygienic conditions or heat processing (blanched or cooked) will increase the shelf life [187]. Freezing causes the apparent death of 10%–60% of the viable microbe population, a percentage that gradually increases during frozen storage [142]. Microorganisms differ considerably in their sensitivity to freezing; thus, the main concern is organisms that are likely to survive the freezing treatment and grow when the product is thawed. There is considerable variation in the ability of bacteria to resist damage by freezing [4]. In general, Gram-negative bacteria are less resistant to freezing death than are Gram-positive bacteria. Nonsporulating rods and spherical bacteria are the most resistant, while bacterial spores, such as *Clostridium* and *Bacillus*, remain unaffected by freezing. Bacteria in the stationary phase are more resistant than those in the log phase [4,142,154,176]. Genera commonly encountered in frozen food include *Pseudomonas*, *Achromobacter*, *Flavobacter*, *Micrococcus*, *Lactobacillus*, *Corynebacterium*-like catalase-positive rods, enterococci, *Streptococcus lactis*, *S. lactis*-like streptococci, *Aerococcus*, and *Pediococcus* [142,184]. Gianfranceschi and Aureli [70] studied the survival of *Listeria monocytogenes* during freezing ( $-50^{\circ}\text{C}$ ) and frozen storage ( $-18^{\circ}\text{C}$ ) when inoculated into chicken breast, ground beef, spinach, mozzarella cheese, and codfish. They observed only a slight decrease in the viable population ranging from 0.1 to 1.6 log cycles after 57 min at  $-50^{\circ}\text{C}$ . Cells of *L. monocytogenes* were more resistant to death and injury when they were inoculated in ground beef and chicken breast, whereas they were less resistant in fish. A further reduction in viability of survival cells (up to 1.0 log) was detected after 240–300 days of storage at  $-18^{\circ}\text{C}$  [70].

The effects of freezing on several foodborne pathogens were reviewed by El-Kest and Marth [51]. The modes of damage to the bacterial cells were reviewed by Archer et al. [4]. The principal site of damage in

the bacterial cells during freezing has been shown to be the membrane. Very rapid cooling of cells from room temperature to  $-150^{\circ}\text{C}$  resulted in more lipid crystallization before any rearrangement of intramembrane particles could occur. This leads to damage being mainly limited to the area around the cytoplasmic membrane. In slowly frozen samples, phase separation of the outer and cytoplasmic membranes was induced, causing the outer membrane to be split off by extracellular ice crystal formation. This damage could be reduced by the addition of a cryoprotectant, which modifies ice crystal formation. Damage to membranes leads to the leakage of internal cell materials, such as potassium ions,  $\beta$ -galactosidase, low molecular solutes, amino acids, RNA, and single- and double-strand DNA. The release of these substances has been correlated negatively with cell viability [4]. Another type of damage is osmotic dehydration of cells caused by extracellular ice formation and the resulting increase in extracellular solute concentration. This process causes the intracellular macromolecules to move closer to the membranes. The development of repulsive forces gives rise to large anisotropic stresses in the membranes, resulting in deformation, phase separation, and formation of a nonlamellar phase. Moreover, salt addition and lowered pH also play a role in the complex nature of freeze injury and cell survival [4,208].

In fermented foods, such as yogurt, frozen storage should increase the viability of beneficial cultures incorporated for their potential health benefits and control of other spoiling microorganisms. The potential beneficial roles of bifidobacteria in the human intestine reported include antagonistic effects on enteropathogenic bacteria, breakdown of carcinogenic *N*-nitrosamines, and suppression of liver tumorigenesis [100]. Thus, bifidobacteria are incorporated in dairy products. Kebary [100] studied the viability of *Bifidobacterium bifidum* in the fermented dairy product Zabady. The number of bifidobacteria surviving after 5 weeks of frozen storage ( $-25^{\circ}\text{C}$ ) of Zabady was higher ( $>10^7$ ) than the minimum level necessary to achieve the beneficial effect of bifidobacteria ( $10^5$ – $10^6/\text{mL}$ ). The total bacterial count decreased as the amount of added bifidobacteria increased. This could be due to the effect of antimicrobial substances produced by bifidobacteria [100]. In eight strains of *Lactobacillus acidophilus*, higher rates and greater activity were always obtained by storing cultures at  $-80^{\circ}\text{C}$ , but most strains stored at  $-30^{\circ}\text{C}$  also survived well. The viability of frozen cultures was affected more by storage temperature than by cooling rate [59]. The plate counts decreased less than 1 log cycle and fermentation activity was 40%–70% when cultures of *Lactobacillus delbrueckii* subsp. *bulgaricus* were stored at  $-80^{\circ}\text{C}$  for 1 year. However, fermentation activity was less than 10% when cultures were stored for 1 year at  $-30^{\circ}\text{C}$  [58]. The fermentation activity of *Streptococcus salivarius* subsp. *thermophilus* was similarly reduced to 10%–60% after 1 year of storage at  $-30^{\circ}\text{C}$ . Protective solutes can be used to improve survival rates.

Yeast cells in bakery products do not withstand freezing well. This can be partially compensated for by increasing the amount of yeast used in the formulation or adding improved yeast strains having a better survival rate in freezing [187]. The freeze-thaw tolerant yeast should have high trehalose content in addition to reduced activity [145]. Trehalose has been reported to perform a cryoprotectant function in the yeast cell [148]. Although the amount of yeast in the formulation could be increased, much higher levels of yeast (6%–8%) have a detrimental effect on aroma and flavor of the baked product [124]. When dough pieces were made up and frozen immediately after mixing, yeast activity remained stable after prolonged storage periods. When fermentation was allowed to proceed after mixing and before freezing, the yeast became less tolerant to freezing temperature and its activity declined. This may be due to a change in the yeast cell membrane sensitivity [92].

### 26.3.3 Physical Changes and Quality

#### 26.3.3.1 Free and Bound Water

Different types of water are present in frozen foods. These can be broadly categorized as free and unfreezable water, which does not freeze even at very low temperatures. A major cause of product degradation is the amount of unfrozen water present in the frozen matrix. Unfrozen water is known to be reactive, particularly during frozen storage, rendering the product susceptible to deteriorative and enzymatic reactions and limiting its frozen shelf life. As given in Chapter 15, the concept of glassy state is being applied to frozen foods stability, since molecular mobility reduces the reaction rates of the unfrozen water matrix and other components [69]. Generally, unfreezable water molecules in aqueous solution are immobilized translationally or rotationally by solutes [141]. The amount of unfreezable water can be measured experimentally and mathematically computed for different types of foods.

### **26.3.3.2 Weight Loss**

Dehydration or weight loss should be regarded as an important quality parameter for frozen unpacked foods, mainly in animal tissue. Foods lose moisture during the freezing process because their surface is exposed to heat and a moisture gradient exists within the environment [23]. Campañone et al. [23] monitored weight loss of meat during freezing and frozen storage and found a range of 0.28%–2.98% during the freezing process; meanwhile the global values (values including freezing and storage to reach up to 20 h of refrigeration) corresponded to a range between 1.67% and 6.15%. Thus, they demonstrated the importance of the surface dehydration on the meat quality.

### **26.3.3.3 Recrystallization**

Ice recrystallization during frozen storage influences the product quality in different ways. Recrystallization of solutes and ice in frozen foods is also important to quality and shelf life. A polymer is least prone to crystallization at temperatures below glass. In general, the rate of recrystallization is highest at the midpoint between the melting and glass transition temperatures. Fluctuations in product temperature of 2°C–3°C, as are likely to be found in bulk cold stores kept at –18°C or colder, are unlikely to cause perceptible damage even over long periods [187]. However, frequent large fluctuations during retail display and during the carry-home period cause ice crystals to ripen or grow, coalesce, and move to the product surface. This leads ultimately to a freeze-dried product if packaging is permeable to moisture, allowing the sublimed or evaporated water vapor to escape. The loss of moisture results in toughening of animal tissue and greater exposure to any oxygen present.

### **26.3.3.4 Retrogradation**

Quality loss by staling and starch retrogradation occurs most rapidly at chill temperatures in baked goods. After baking, starch from the loaf progressively crystallizes and loses moisture. Until a critical point of moisture loss is reached, freshness can be restored by heating and reabsorbing starch crystals. A tight wrap helps to keep the moisture content high for a certain amount of time. The complete crystallization of starch produces the crumbly texture of stale bread. Slow freezing is to be avoided to reduce the time spent at chill temperatures. Amylase is a useful antidote to bread staling. In general, moisture migration during frozen storage is the principal cause of staling [5,187]. It has been reported that repeated freezing and thawing treatments favored starchy paste retrogradation, which is related to a mild hydrolysis of starch chains [31].

### **26.3.3.5 Protein Denaturation**

Some protein denaturation and solubility changes are known to occur as a result of freezing, but the practical significance of these changes is not clear [176]. Fish muscle has a unique arrangement of muscle fibers. It is divided into a number of segments called myotomes, which are separated from one another by a thin sheath of connective tissue called the myocomma or myoseptum [173]. Fish deterioration during frozen storage is associated with a decrease of protein solubility and extractability, diminishing the nutritional value [3]. Quality loss during cold storage of meat is characterized by an increase in loss of water-holding capacity, a decrease in protein extractability, a decrease in sulfhydryl groups, and a slight loss in ATPase activity [167,176]. In frozen meat, water losses are related to the denaturation of myofibrillar protein [53]. The water-holding capacity of the meat and the biochemical properties of actomyosin, such as enzymatic activity, viscosity, and surface hydrophobicity, are affected by freezing. The expressible moisture in adductor muscles increases during freezing and frozen storage. These changes are accompanied by actomyosin denaturation. The myosin and paramyosin of the actomyosin complex are most affected [150]. An amino group from some essential amino acids, such as lysine, can react with the carbonyl group of reducing sugars during processing or storage [72]. Peptides and amino acids are also increased in the drip fluid, as are nucleic acids, indicating protein changes and structural cellular damage [176]. During freezing, water molecules freeze out and migrate to form ice crystals, resulting in the disruption of the organized H-bonding system that stabilizes the protein structure, and the hydrophobic as well as the hydrophilic regions of protein molecules become exposed to a new environment. This may allow the formation of intermolecular cross-linkages either within a protein molecule or between two adjacent molecules [173].

### 26.3.3.6 Freezer Burn

Moisture loss by evaporation from the surface of a product leads to freezer burn, an unsightly white color that can be mistaken for mold but is resolved on rehydration during cooking unless it is severe [187]. It is usually in the form of patches of light-colored tissues, produced by evaporation of water, which leave air pockets between meat fibers [131]. Dehydration of the product or freezer burn may occur while freezing an unpackaged food item in blast freezers unless the velocity of air is kept to about 2.5 m/s and the period of exposure to air is controlled. This dehydration can be controlled by humidification, lowering of storage temperatures, or better packaging [5]. A single package of spinach and cauliflower experienced a 1.5-fold increase in loss of moisture per 2.8°C rise in temperature between  $-17.8^{\circ}\text{C}$  and  $-6.7^{\circ}\text{C}$  [45]. The loss of moisture occurs faster when held in a temperature cycle than when held at constant temperature during frozen storage [158].

### 26.3.3.7 Glass Formation

The glass transition has a dramatic effect on frozen food quality. The product is most stable below  $T_g'$ , and moisture has little influence on  $T_g'$ . The presence of low molecular weight (LMW) solutes lowers the  $T_g'$ , and high molecular weight (HMW) exerts little effect. This means that with increasing maturity, many vegetables display a decrease in sugars and an increase in starch, thus increasing the  $T_g'$  and the stability of frozen foods.

### 26.3.3.8 Functional Properties

Functional properties on any food product are normally affected by differences in freezing and thawing methods. Properties such as rheological (both flow and dynamic), textural, mechanical, consistency, appearance and sensory attributes and water-holding capacity have been correlated with freezing and thawing processes. The changes in specific functional properties become microscopically and qualitatively related to structural modifications or rearrangements of the food items. The rheological properties of fresh and frozen thawed okra dispersions were significantly different when measured at  $20^{\circ}\text{C}$ – $80^{\circ}\text{C}$ . The dispersions were pseudoplastic with both the consistency coefficient and the flow behavior index influenced by temperature. The consistency coefficient was higher for the unfrozen sample than the frozen thawed sample when measured at  $20^{\circ}\text{C}$  and  $50^{\circ}\text{C}$ , but the reverse was observed at  $80^{\circ}\text{C}$ . The flow behavior indices were not different at any temperature between  $20^{\circ}\text{C}$  and  $80^{\circ}\text{C}$  [149]. Navarro et al. [144] studied the effect of freezing rate on the rheological response of gelatinized starch pastes containing lipids. Low freezing rates increased the viscoelasticity, reduced the apparent viscosity, and led to higher structural changes of the pastes; in contrast, high freezing rates maintained the same rheological characteristics of the unfrozen samples. Graiver et al. [77] evaluated the viscoelastic behavior of refrigerated and frozen mozzarella cheese and found differences in the viscoelastic response. The storage modulus was higher for refrigerated samples in comparison with frozen cheese, in which modifications in cheese microstructure by freezing were observed with SEM methodology. Further, the freezing was correlated with casein hydrolysis, cheese matrix softening, and proteolysis acceleration.

Texture is important in frozen vegetables [63,130]. After freezing and thawing, firmness decreased, rupture strain increased, and consequently crispness decreased [62,63]. The rate of freezing was critical to tissue damage. The optimum freezing rate of carrots was established as  $-5^{\circ}\text{C}/\text{min}$  using a programmable freezer and was based on texture and histological structure [61,64]. Chinese cabbage leaves cracked when frozen rapidly with liquid nitrogen. The optimum freezing rate for Chinese cabbage was  $2^{\circ}\text{C}/\text{min}$  considering tissue softening and drip loss. Freezing and thawing accelerated release of pectin, but the freezing rate did not greatly affect pectin release [63]. Fruits, such as strawberries, apples, peaches, and citrus, contain thin-walled cells with a large proportion of intracellular water, which can freeze, resulting in extensive cell rupture and radical alteration of the mechanical properties of the material [42]. Maestrelli et al. [130] studied the effect of freezing on three quality parameters of transgenic parthenocarpic (parthenocarpic produces seedless fruits) eggplants, in which the firmness of the transgenic eggplants showed a decrease. Khan and Vincent [102] studied the mechanical damage induced by controlled freezing in apple and potato. As the tissue freezes, ice crystals are formed extra- or intracellularly, pushing the cells apart or rupturing cell walls and producing large voids within the tissue.



Changes in mechanical behavior (wedge penetration, tensile, and compression) of the material were directly related to the degree of cell damage by freezing.

Mashl et al. [133] studied the unidirectional freezing of a gelatinized corn starch–water mixture and found that at freezing velocities  $\leq 7.5 \mu\text{m/s}$ , starch granules were alternately pushed or entrapped by the advancing solid–liquid interface, producing a segregated structure consisting of alternating high-starch and low-starch bands. Thus, segregation of the starch within the product occurred, which is detrimental to consistency, texture, and appearance. At a velocity of  $10 \mu\text{m/s}$ , the frozen product was homogeneous.

The development of rancid flavors and progressive toughening accompanied by the development of cold store flavor are the principal sensory changes in seafood [187]. Deterioration in the texture and functionality of fish tissues by frozen storage become faster than in other animal muscles [3]. The firmness of soft texture characteristic of young fish with the early onset of protein denaturation is preferred by most taste panelists [101]. Flavor change is probably more critical than texture since this can occur early [35]. The denaturation of myosin increased in a frozen solution. The rate of formation of insoluble, HMW protein aggregates increased as the temperature decreased below the freezing point and reached a maximum near the eutectic point of the solution [22]. Because of the concentration effect, pH can also change during freezing. A decrease in pH to more favorable values for degradation results in faster protein denaturation [159]. Fish gradually loses its juiciness and succulence after freezing and subsequent frozen storage. In gadoids, the chemical breakdown of trimethylamine oxide (TMAO) to dimethylamine (DMA) and formaldehyde (FA) and the subsequent cross-linking of FA to muscle proteins produced textural breakdown and resulted in a cottony or spongy texture. In this case, free water exists loosely like in a sponge. When eaten, the fish muscle loses all its moisture during the first bite, and subsequent chewing results in a very dry and cottony texture [173]. In nongadoid species, such as crab, shrimp, and lobster, muscle fibers also tend to toughen and become dry during freezing and storage.

Thawing and refreezing could lead to quality deterioration [89]. Dyer et al. [50] reported accelerated deterioration for refrozen cod fillets stored at  $-23^\circ\text{C}$ . Changes in enzyme activities of  $\alpha$ -glucosidase and  $\beta$ -*N*-acetylglucosaminidase in rainbow trout on thawing, refreezing, and frozen storage were observed, but they did not relate to differences in sensory attributes [147]. Cowie and Little [36] reported no correlation between decreasing protein solubility and sensory attributes for cod stored at  $-29^\circ\text{C}$ . Thawed and refrozen fish muscle displayed a faster decline in myofibril protein solubility than once-frozen fish and had reduced water-holding capacity, but analysis of proton spin-spin relaxation times indicated no changes in water location. The decline in protein solubility was not caused by complete protein unfolding. Long thawing times of 30 h before refreezing and storage resulted in cooked fish having a gray appearance and stale flavor [89]. Whole fish when thawed exhibits less textural change than filleted fish due to the presence of the backbone, which provides structural support for the flesh [173]. Gaping in fish fillet may be observed to worsen if the fish is slowly frozen. Love and Haq [125] showed that the rate at which whole cod was frozen had little effect on the gaping of the fillets cut after thawing, although very slow freezing did cause a small increase.

The functional properties of cheese, which also changed after freezing and thawing, include meltability, stretchability, elasticity, free oil formation, cohesiveness, and others. Meltability is the capacity to flow together and form a uniform continuous melted mass. Stretchability is the tendency upon pulling to form fibrous strands that elongate without breaking. Elasticity is the capacity of the fibrous strands to resist permanent deformation. Free oil formation is the separation of liquid fat from the melted body into oil pockets. Viscosity is due to particle segregation or coagulation. Luck [127] concluded that frozen storage was suitable for cream cheese, unripened camembert, and brick cheese, but not for gouda or cheddar cheese. Mozzarella cheese, which originated in Italy, is consumed worldwide largely due to the popularity of pizza and similar foods. Mozzarella differs from most cheeses in that it is often consumed in a melted state. Consequently, the functional properties, such as meltability, stretchability, elasticity, and free oil formation, are important to the quality of the product. Cervantes et al. [28] concluded that freezing (1-week storage) and thawing did not affect the mozzarella cheese quality as assessed by compression, beam bending, and sensory evaluation. Dahlstrom [37] showed poor meltdown, acid flavor, fat leakage, free surface moisture, bleached discoloration, and poor cohesiveness immediately after thawing, but normal characteristics reappeared after the thawed cheese was aged for 1–3 weeks. Bertola et al. [14] studied the freezing rate and frozen storage (3 months at  $-20^\circ\text{C}$ )

of mozzarella cheese. The functional quality loss (meltability, apparent viscosity, and free oil formation) can be avoided as long as the product was aged from 14 to 21 days at 4°C before being consumed. Again freezing mozzarella cheese that had been ripened for about 14 days produced a product similar (hardness, adhesiveness, cohesiveness, springiness, and nonprotein nitrogen) to refrigerated cheese at the same stage of aging [15].

## 26.3.4 Chemical Changes and Quality

### 26.3.4.1 Rancidity

Oxygen is the bugbear of almost all frozen foods, leading to oxidative rancidity (if any unsaturated lipids are present), loss of color, and development of off-flavors. Freezing results in a concentration of solutes, which catalyze the initiation of oxidative reactions and disrupts and dehydrate cell membranes, exposing membrane phospholipids to oxidation. Membrane phospholipids are highly unsaturated and have been demonstrated to be the initiation point of oxidation in muscle tissue [176]. The degradation of lipids in frozen peas during storage at  $-18^{\circ}\text{C}$  led to flavor damage due to the formation of hydroperoxides, thiobarbituric acid, and fatty acids, particularly in unblanched samples [84]. The lipid oxidation was mainly due to lipoxygenase and lipohydroperoxidase breakdown products [32]. The hydrolyzed and oxidized products of lipids affect the quality of frozen vegetables [169].

Oxygen availability and tissue composition play important roles in the acceleration of lipid oxidation frozen fish. Lipid hydrolysis occurs in fish during storage, which may affect lipid oxidation. Free fatty acids are believed to be more readily oxidized than the equivalent esters when lipoxygenase is involved [79,153,174]. Lipid oxidation in mackerel minces occurred continually as long as the samples were exposed to air independent of hydrolytic activity, but was deactivated or retarded by cooking the sample or by lowering the storage temperature ( $-40^{\circ}\text{C}$ ). Lipid oxidation was observed not only in the free fatty acids, but also in the triacylglycerides and the phospholipids extracted from mackerel mince [91]. Mincing destabilizes the fish due to a high level of incorporated oxygen and cellular disruption, making the lipids susceptible to oxidation. Most methods for frozen fish mince stabilization are based upon one or more of the following three strategies: (i) removal of prooxidants, oxygen, or components susceptible to oxidation, (ii) alternation of prooxidants, antioxidants, or other components influencing the oxidation, or (iii) addition of components that can protect fish mince lipids against oxidation [193]. Washing of fish mince helps in the removal of various antioxidative components and the relative increase in both polarity and unsaturation in the remaining lipid fraction. Heating also affects the oxidative stability of fish mince by (i) altering prooxidative enzymes, such as lipoxygenases [200], lipoxidases [103], and microsomal enzymes [182]; (ii) changing the prooxidative properties of myoglobin and other hemoproteins [29]; and (iii) enhancing the production of aqueous [200] and lipid-soluble [68] antioxidants. Undeland et al. [194] studied the lipid oxidation stability of frozen minced herring at  $-18^{\circ}\text{C}$  by preheating and pre-washing. Stability increased due to heat inactivation of catalytic enzymes without activation of hemoproteins. Washing reduced the stability by removing prooxidative enzymes from cooking, and reduction of antioxidants as well as a relative increase in phospholipids and free fatty acids in the fat. In case of herring fillets, the removal of the skin prior to storage at  $-18^{\circ}\text{C}$  was shown to negatively affect the stability of underlying tissue. The abundance of hemoproteins, free metals, and enzymes in the under-skin layer resulted in very severe oxidative changes, especially when the fillets were stored without skin. The unfavorable composition of the under-skin layer includes a lot of dark muscle, the silver surface, the highest fat content, and the lowest level of  $\alpha$ -tocopherol. Such local productions of oxidation products can spoil the entire flavor of the fillet; protection or removal of unstable tissues at an early stage during processing can be an important factor to improve the frozen herring storage stability [194].

Poultry fat becomes rancid during very long storage periods or at extremely high storage temperatures. Rancidity in frozen whole poultry stored for 12 months is not a serious problem if the bird is packaged in essentially impermeable film and held at  $-18^{\circ}\text{C}$  or below. Danger of rancidity is greatly increased when poultry is cut up before freezing and storage because of the increased surface exposure to atmospheric oxygen [5]. Antioxidants (such as butylated hydroxyanisole (BHA), butylated hydroxytoluene [BHT], or tocopherols) and metal chelators (such as pyrophosphates, tripolyphosphates, or hexametaphosphates) are effective in reducing oxidation. The distribution of antioxidants in meat is difficult; thus, including

tocopherols in animal feed results in deposition of tocopherols in membrane locations. This is much more effective in preventing the initial step with phospholipids [176]. The frozen storage stability of antioxidant-treated beef heart surimi is reported [198,210]. Among various lipid- and water-soluble antioxidants, propyl gallate was found most protective and effective for inhibiting lipid and protein oxidation during short-term frozen storage [185]. Lipid and protein oxidation in beef surimi with propyl gallate and cryoprotectants (sucrose, sorbitol) was minimal at  $-70^{\circ}\text{C}$ . Lipid and protein oxidation in frozen samples occurred with a prefreezing-thawing process before storage at  $-15^{\circ}\text{C}$  and  $-29^{\circ}\text{C}$ . Oxidation increased rapidly after 4 weeks. Propyl gallate inhibited lipid oxidation but was ineffective against protein changes. After 12 weeks, cryoprotectants promoted lipid and protein oxidation in the absence of propyl gallate [199].

Malonaldehyde is one of the decomposition products of autoxidation of polyunsaturated lipid materials in food. Malonaldehyde is the main component in the TBA (2-thiobarbituric acid) value that is used to evaluate the degree of oxidation of lipids. Malonaldehyde reacts with myosin from trout. The rate of reaction of malonaldehyde with  $\alpha$ -amino groups of myosin was greater at  $-20^{\circ}\text{C}$  than at  $0^{\circ}\text{C}$  and almost equal to that of  $20^{\circ}\text{C}$  [159]. Oxidant levels should be increased in frozen dough formulations, as oxidants increase dough strength. A higher shortening level is recommended for frozen dough production. Generally, shortening protects dough structure from damage owing to ice crystallization [92].

### **26.3.4.2 Color, Flavor, and Vitamin Loss**

#### **26.3.4.2.1 Color Loss**

The most important color changes in fruits and vegetables are related to three biochemical or physicochemical mechanisms [25]: (a) changes in the natural pigments of vegetable tissues (chlorophylls, anthocyanins, carotenoids), (b) development of enzymatic browning, and (c) breakdown of cellular chloroplasts and chromoplasts. Pineapple for processing should be of optimum ripeness, with yellow color and good aroma and flavor, and free from blemishes, such as black heart, water blister, yeasty rot, or brown spot. For frozen pineapple slices, semitranslucent, highly colored slices are generally considered the most attractive and have the best flavor. Pineapple color is important because it is often the basis for judging product acceptability. The golden color of pineapple fruit is mainly due to carotenoids, which become more predominant with ripening as chlorophyll content decreases. Heat processing, freezing, and thawing lead to cell disintegration, pigment degradation, and isomerization of carotenoids [26,87,180]. Bartolome et al. [11] evaluated the influence of freezing (cold room  $-18^{\circ}\text{C}$  and air-blast freezer  $-50^{\circ}\text{C}$ ) and frozen storage ( $-18^{\circ}\text{C}$  for 0–12 months) on the color and sensory quality of pineapple slices (Smooth Cayenne and Red Spanish cultivars). No differences were found in sensory analysis (color and appearance) between the cultivars, frozen at different rates, compared with fresh product, or after 1 year frozen storage. However, both cultivars were suitable for freezing.

Color and flavor are important sensory attributes, and vitamin content is a functional attribute of frozen foods. The green color of vegetables is lost by chlorophyll degradation during freezing and frozen storage resulting from the conversion of chlorophyll to pheophytins or the destruction of both chlorophyll and pheophytins, giving a dull khaki color. During storage, chlorophyll is converted to pheophytin with a loss of green color and vitamin C; these can be used as objective indicators of quality [135,142,187].

Chlorophyll was bleached during fat peroxidation and oxidation of glycolic acid and by  $\alpha$ -hydroxy acid dehydrogenase and chlorophyllase, which hydrolyze the phytal ester group of chlorophylls and pheophytins [190]. Storage temperature and time, acidity, and blanching time affect the loss of chlorophyll in frozen vegetables. A 10-fold increase in the conversion rate occurred with an approximate  $8.3^{\circ}\text{C}$  increase in temperature. Blanching decreased the loss of chlorophyll during frozen storage [142]. Various inorganic salts, such as sodium chloride, potassium sulfate, sodium sulfate, and sodium or ammonium bicarbonate, have been used to reduce chlorophyll loss [25].

The maximum stability of carotenes in frozen spinach was 2 years at  $-28.9^{\circ}\text{C}$ , 1 year at  $-6.7^{\circ}\text{C}$ , and 7 days at  $4.4^{\circ}\text{C}$  [46]. Carotene retention curves were sigmoidal with three regions: initiation, acceleration, and retardation. They were typical of autocatalytic reactions. Lipoygenases were the major enzymes involved in carotene degradation [73]. Moharram and Rofael [142] reviewed carotene degradation in frozen vegetables. Martins and Silva [135] reported a high sensibility of chlorophylls (a and b color values) at  $-18^{\circ}\text{C}$ , and results showed that color a and b values retained only 10.96% and 10.82% for chlorophylls during 60 days of frozen storage.

In poultry, a light surface color for carcasses is considered important and is best achieved with rapid surface freezing, which generates a smooth chalky white surface. This is achieved by supercooling the product and forcing nucleation of a high number of small ice crystals. These crystals stay small because there is little water migration to already formed crystals during such a fast process. Numerous small ice crystals cause the surface to reflect light and appear white in color [176]. An alternative approach is to crust freeze the outer part of the carcass rapidly using liquid brine immersion, spray systems, or cryogenics such as liquid nitrogen or carbon dioxide, and then to move the partially frozen bird to air blast or cold storage for the remainder of the process. A freezing front migration rate of 2–5 cm/h is recommended to achieve fast freezing effects and 0.1–0.2 cm/h for slow freezing [131,176].

Darkening of bones is a condition that occurs in immature chickens and has become more prevalent as broilers are marketed at younger ages. Darkening may arise during chilled storage or during the freezing and defrosting process. It occurs because some of the heme pigment normally contained in the interior of the bones of particularly young chickens leaches out through spongy areas and discolors the adjacent muscle tissues [5,176]. Leaching only occurs in carcasses from relatively young birds because the bones are not completely calcified and are more porous than in mature birds [176]. The development of dark bones was greatly reduced by a combination of freezing and storage at  $-35^{\circ}\text{C}$  and immediate cooking after rapid thawing [20]. Apart from this combination, the freezing rate, time between slaughter and freezing, temperature and length of storage, and temperature fluctuations during storage have no marked influence in preventing this discoloration [5]. While taste qualities do not change, the appearance constitutes a negative factor in consumer acceptance [176].

In crustacean seafood, a dark discoloration defined as blackspot or melanosis is developed after the trauma of the capture, string, and thawing process; it is unattractive to consumers and reduces the market value. This oxidative enzyme reaction, followed by autoxidation and polymerization, may be prevented by applying sulfiting agents in combination with freezing [170]. Rotland et al. [170] carried out an experiment in which different concentrations of sodium metasilfite (included in HQ-Bacterol F), temperature and time of immersion, and subsequent freezing storage of rose shrimp were applied. They found that untreated shrimp showed melanosis after 19 h of remaining in ice and had a decreased market value at 27 h, whereas samples treated with 2% HQ-Bacterol F for 5 min maintained their market value. Further, quick freezing appeared as a good method in addition to the sulfiting agent to prevent the melanosis phenomenon, and following storage for 3 months did not affect the appearance of blackspots.

#### 26.3.4.2.2 Flavor and Aroma Loss

Freezing affects the flavor and aroma of frozen foods. For example, freezing of strawberries is usually associated with a reduction in aroma and the development of off-flavor. The decrease in aroma is due to a rapid decomposition and diffusion of esters [43,49], whereas the concentrations of franeol and mesofurane linked to strawberry flavor are not affected by freezing [49]. The off-flavor of frozen strawberries differs from that of frozen vegetables [99,137,192]. Off-flavor in frozen vegetables is usually due to insufficient blanching. Deng et al. [44] found that the development of off-flavor in frozen thawed strawberries was due to the chemical production of  $\text{H}_2\text{S}$  rather than enzymatic activity. The identity of  $\text{H}_2\text{S}$  was verified both chemically and using gas chromatography–mass spectroscopy analyses. The olfactory properties by sensory analysis indicated the presence of sulfurous compounds. Usually,  $\text{H}_2\text{S}$  is derived from the sulfur-containing amino acids cysteine or methionine during processing. Deng et al. [44] also showed that amino acid was not the main precursor of the off-flavor compounds, but the off-flavor development in frozen strawberries can be attributed to the breakdown of the cells by freezing, thereby decreasing the pH in the cytosol, which in turn leads to the release of sulfide ion as  $\text{H}_2\text{S}$ . The duration of the production of  $\text{H}_2\text{S}$  was longer in strawberries at  $-40^{\circ}\text{C}$  and  $-80^{\circ}\text{C}$  than at  $-20^{\circ}\text{C}$ . This may be due to the low boiling point of  $\text{H}_2\text{S}$  ( $-59.0^{\circ}\text{C}$ ). Vigorous crushing of fresh strawberries also gave rise to the production of  $\text{H}_2\text{S}$ . Thus, structural damage is one of the important factors.

In fish and seafood, FA is formed during cold storage by enzymatic decomposition of TMAO. It is a good objective criterion of time-temperature exposure in frozen gadoid species [18]. The FA reacts with proteins, thereby decreasing their solubility in salt and buffer solutions [166,187]. Santos-Yap [173] mentioned that changes in the flavor of fish and seafood generally occur in three distinct phases during frozen storage: (a) gradual loss of flavor due to the loss of or decrease in concentration of some flavor

compounds, (b) detection of a neutral, bland, or flat flavor, and (c) development of off-flavors due to the presence of compounds such as acids and carbonyl compounds that are products of lipid oxidation.

#### 26.3.4.2.3 *Vitamin Loss*

Retention of nutritional components in foods is a concern when any type of preservation method is used, but freezing is probably the least destructive [176]. The destruction of vitamin C (ascorbic acid) occurs during freezing and frozen storage. This loss is influenced by blanching conditions, types of freezing, package types, and time-temperature conditions [142]. The loss is mainly due to the oxidation or to the action of ascorbic acid oxidase [169]. There is a 10-fold increase in the rate of loss of ascorbic acid per 8.9°C rise in storage temperature of frozen vegetables [13]. Generally, frozen vegetables stored at  $-24^{\circ}\text{C}$  displayed better ascorbic acid retention than those at  $-12^{\circ}\text{C}$  and  $-18^{\circ}\text{C}$ , respectively [142]. Blanching improves ascorbic acid retention in vegetables. A combination of microwave energy and steam or water blanching yielded frozen products with better ascorbic acid retention than conventional procedures [47]. The reduction in vitamin C in frozen mashed potatoes could be overcome by the addition of encapsulated vitamin [164]. Vitamin B losses sometimes occur in frozen meat products. Vitamin B losses may be significant in frozen poultry products, but most losses are the result of the subsequent thawing and cooking treatments rather than of the freezing process [176]. Based on their studies, in which ascorbic acid and chlorophylls were measured in frozen green beans during storage, Martins and Silva [135] suggested that the shelf-life determination of frozen vegetables should importantly depend on the nutritional quality rather than only sensory attributes.

#### 26.3.4.3 *Release of Enzymes*

The disruption of plant or animal tissues by freezing leads to the release of enzymes bound to the structures. Beef and pig skeletal muscle contain two isozymes of glutamic-oxalacetic transaminase: one in the mitochondria and other in the sarcoplasm [108]. Hamm and Kormendy [80] found that freezing and thawing cause a remarkable increase of glutamic-oxalacetic transaminase activity in the muscle press juice. Fish contains malic enzymes in two forms: free and latent. The latter is solubilized by the disruption of the tissue caused by freezing and thawing [76]. Barbagli and Crescenzi [7] found that the activity of cytochrome oxidase in extracts of tissues after freezing and thawing was increased by 15 times in chicken's liver, 2.5 times in trout, and 4 times in beef muscle compared to extracts of unfrozen samples. Thus, a method was developed to distinguish between fresh and frozen meat based on the enzymes released [7,75,80,81]. Around  $0^{\circ}\text{C}$  enzymatic breakdown of protein becomes the principal cause of quality loss, and below  $-8^{\circ}\text{C}$  microbiological spoilage ceases and protein denaturation coupled with oxidative rancidity in fatty species becomes the chief factors affecting quality [187].

#### 26.3.4.4 *Hydrolysis*

Generally, starch in vegetables does not change significantly during frozen storage [109]. Rofael [169] observed no significant changes in starch of beans, peas, okra, or mallow during storage at  $-18^{\circ}\text{C}$  for 1 year. The reducing sugars of these frozen vegetables were increased during storage owing to the hydrolysis of both oligo- and polysaccharides of these products. Thus, the amount of reducing sugars is a good indicator of storage life [142]. Martins and Silva [135] found significant starch degradation rates for green bean at  $-6^{\circ}\text{C}$ ,  $-12^{\circ}\text{C}$ , and  $-18^{\circ}\text{C}$  during initial days of storage. In melons, total cell wall polysaccharides decreased more during the first 5 months than during the second 5 months of frozen storage. This suggested that pectins and hemicellulose fractions were modified and solubilized by either mechanical or enzyme-catalyzed changes in cell wall polymers [179]. However, freezing preservation of pineapple slices led to minimal changes in soluble solids and sugar content (fructose, glucose, and sucrose), pH, titratable acidity, and nonvolatile organic acids (citric and malic acids) after a year of frozen storage at  $-18^{\circ}\text{C}$  [9,10].

#### 26.3.4.5 *Acetaldehyde Formation*

The formation of acetaldehyde in frozen vegetables increases during storage and is thus an indication of shelf life [169]. Acetaldehyde is a product of aerobic fermentation of pyruvate in plant tissues [95]. The amount of acetaldehyde formation depends on the pretreatment, such as blanching time and storage

period [30,142,169]. Chow and Watts [30] found that acetaldehyde increased when fresh vegetables were heated beyond the minimum required for enzyme inactivation. DMA content, FA content, and shear force measurement correlated very well with sensory texture score of frozen red hake [117]. The enzymatic breakdown of triethylamine oxide to DMA and FA affects textural changes in fish species during frozen storage. Further, FA's contribution to protein changes in muscle during frozen storage would clarify the toughening mechanism. Frozen storage and fluctuation in temperature affect both DMA and FA formation in frozen fish [114].

### 26.3.5 Processing and Packaging Factors

#### 26.3.5.1 Pretreatments for Freezing

It is important to realize that successful freezing will only retain the inherent quality present initially in a food item and will not improve quality characteristics; thus, quality level prior to freezing is a major consideration. The use of high-quality initial materials based on standards and grades is essential to high-quality frozen products. The level of intrinsic product quality, such as freshness, suitability of variety or genetics for freezing, soil nutrients for foods of plant origin, dietary factors for foods of animal origin, harvesting or slaughtering methods, and processing such as blanching, cooking, chilling, and addition of antioxidants, have also profound effects. Microbiological quality prior to freezing remains a major determinant of postthaw quality. Although freezing can reduce some pathogens, there is also usually significant survival. Thus, other methods must be used to ensure elimination of pathogenic organisms from frozen poultry [96,176]. The commonly used pretreatments are discussed in the following sections.

##### 26.3.5.1.1 Blanching

Most vegetables and some fruits are blanched before freezing. Blanching destroys the permeability of cell membranes, destroys cell turgor, removes intercellular air, filling these spaces with water, and establishes a continuous liquid phase. As a result, ice crystallization can occur through the entire matrix of food without interruption during freezing process. It also affects texture, color, flavor, and nutritional quality by inactivating enzymes. Cell turgor is an important component of the eating quality of many fruits. It is produced by the internal pressure of cell contents. Reduced turgor is perceived as softness and lack of crispness and juiciness. When turgor is an important product characteristic, blanching and freezing may not be acceptable. If the product is cooked before consumption, retention of turgor through earlier processing is not necessary since thermal treatment is more severe than blanching or freezing [142,167]. Blanching has also other advantages, such as destruction of microorganisms, and wilting of leafy vegetables assisting packaging [25]. Further, blanching favors reductions of some undesired compounds being present in some leafy vegetables, such as nitrates, nitrites, and oxalates [110]. The effect of blanching, 70°C for 15 or 30 s, and frozen storage on the stability of  $\beta$ -carotene and capsanthin in red pepper was elucidated by Morais et al. [143]. Both time of blanching and frozen storage were simultaneously included in two multilinear equations describing the concentration of  $\beta$ -carotene and capsanthin. There were significant differences in the decomposition rate of pigment related to cultivars and process conditions.

Properly blanched vegetables have a long shelf life at frozen food temperatures, enabling them to be exported all over the world and span the seasons [187]. Blanching of fruits may be detrimental in many cases, resulting in (a) rapid discoloration by enzymatic browning [187], (b) loss of texture, (c) formation of cooked taste, (d) some loss of soluble solids, especially in water blanching, and (e) adverse environmental impact due to energy requirements and disposal of used water [25]. Blanching at 70°C–105°C is associated with the destruction of enzyme activity. Hot-water blanching is usually carried out between 75°C and 95°C for 1–10 min, depending on the size of the individual vegetable pieces. High-pressure steam blanching is more energy efficient than water blanching. It is important that cooling be carried out shortly after blanching, especially for products to be frozen [25].

The enzymes involved in the production of off-flavor are catalase, lipoxygenase, and peroxidase, and their heat stability varies with the types of vegetables and fruits. Peroxidase and catalase seem to be the

most heat stable; thus, they could be used as an index of adequate blanching for vegetables. A 95% loss of enzyme activity following blanching is considered adequate. The quality of blanched frozen vegetables was improved if some peroxidase activity remained at the end of the blanching process. The activities of most enzymes are greatly dependent on pH of the tissue or the blanching water. Additives, such as citric acid, sodium chloride, and carbonates, can be used in water depending on the purpose [25,34,142]. Bottcher [19] reported that the highest-quality products were obtained when the following percentages of peroxidase activity remained: peas, 2%–6.3%; green beans, 0.7%–3.2%; cauliflower, 2.9%–8.2%; and brussels sprouts, 7.5%–11.5%. It was concluded that the complete absence of peroxidase activity was indicated over blanching [25].

#### 26.3.5.1.2 Heat Treatments

Texture is an important quality attribute of frozen fruits and vegetables. Loss of tissue firmness, disruption of the cell membrane, and excessive softness are the major consequences to be avoided [162]. Low temperature and long-time pretreatment were useful in improving the texture of frozen vegetables by avoiding excessive softness. Carrots heated for 30 min at 60°C and frozen above  $-5^{\circ}\text{C}/\text{min}$  (optimum rate) should escape both cell damage and excessive softening [61,114,188]. The deesterification of pectin by pectin methylesterase during preheating prevented transelimination of pectin [8,60,116,160]. Fuchigami et al. [65] found that preheating followed by quick freezing was effective in improving excessive softness and cell damage. The optimum preheating occurred with 30 min at 60°C or 5 min at 70°C, and the optimum freezing was  $-5^{\circ}\text{C}$  to  $-50^{\circ}\text{C}$ . Preheated carrots retained a firmer texture than those blanched in boiling water. After preheating, the amount of high methoxyl pectin decreased and low methoxyl pectin increased. Quick freezing process resulted in better texture than slow freezing. Loss of texture was accompanied by the release of pectin. Slow freezing accelerated the release of pectin as compared to quick freezing. Preheated carrots were slower to release pectin. The degree of esterification of pectin substances in raw carrots decreased during preheating, freezing, and thawing. Cell damage in quick-frozen carrots was slight. Product preparation prior to freezing may include cutting, deboning, slicing, and other operations to provide greater convenience. A greater variety of products cooked prior to freezing is becoming popular with consumers. These include breaded and fried portions, cured and smoked products, and items in marinades or broths [176]. The freezing rate of precooked chicken affects the quality of the product. Breaded precooked drumsticks frozen with liquid nitrogen are susceptible to cracking, separation of meat from the bone, and developing small areas of white freezer burns next to the surface [5]. Cooked products are likely to exhibit greater increases in lipid oxidation than raw products during storage. This is due to the oxidative change and higher TBA values making the product more susceptible to further oxidative changes during frozen storage. Antioxidants are very effective in cooked chicken during frozen storage [94,114,156,202].

#### 26.3.5.1.3 Dipping Pretreatments

In many cases, foods are dipped or soaked in different solutions before freezing and the type of solute used depends on the desired purpose. Apple slices are commonly treated by soaking it in 1% salt solution to remove intercellular air. Fruits are also dipped in ascorbic acid and sugar solutions to minimize browning or blanched for a short time to inactivate enzymes [167]. Paredi et al. [150] studied the effect of dipping in polyphosphates on the biochemical properties of adductor muscles when frozen and stored at  $-30^{\circ}\text{C}$ . Immersion in polyphosphates solution was effective in reducing water loss in stored muscle. In addition, it delayed the decrease in enzymatic activity ( $\text{Mg}^{2+}$ -ATPase) and provided some protections for the myosin light chains without affecting either the extractability or the viscosity of actomyosin from frozen stored muscles.

In many cases, the frozen product is protected by a suitable glazing compound. A glaze acts as a protective coating against the two main causes of deterioration during storage: dehydration and oxidation. It protects against dehydration by preventing moisture from leaving the product, and against oxidation by mechanically preventing air contact with the product. Oxidation can also be minimized if the glaze carries a suitable antioxidant [5]. For products intended for short-term storage, glazing can be practically utilized as a viable alternative to storage without a protective covering [173]. Moreover, glazing treatment could be a cheaper alternative to expensive packaging systems for fish stored at  $-20^{\circ}\text{C}$  [93]. The different glazes available include inorganic salt solutions of sodium acid phosphate, sodium carbonate, and calcium lactate,

alginate solution (also known as *Protan glaze*), antioxidants (such as ascorbic and citric acids, glutamic acid, and monosodium glutamate), and other edible coatings (such as corn syrup solids) [205].

#### 26.3.5.1.4 *Bacterial Ice Nucleators or Antifreeze Proteins*

The application of bacterial ice nucleators to the freezing of some model food systems and real foods (such as salmon, egg white protein, and cornstarch gels) elevates nucleation temperatures, reduces freezing times, and improves the quality (such as flavor and texture). These can also be used in freeze concentration of fresh foods for modification of their properties [201]. The use of bacterial ice nucleators is a unique application of biotechnology, as it directly improves freezing processes [118]. When bacterial cells were added to isotropic aqueous dispersions of hydrogels composed of proteins and polysaccharides, the bulk of the water was converted into directional ice crystals at subzero temperatures not lower than  $-5^{\circ}\text{C}$ , and resulted in the formation of anisotropically textured products [118]. Details of this topic are reviewed by Wolber [207] and Li and Lee [118]. Antifreeze proteins, found in polar fish and cold-tolerant insects and plants, can affect freezing in several different ways: (a) by lowering the freezing temperature, (b) by retarding recrystallization on frozen storage, and (c) by promoting ice nucleation causing supercooled solutions to freeze more rapidly [69,74]. Mizuno et al. [141] studied the effect of solutes on the antifreeze and immobilizing activities of water. The antifreeze activities of saccharides that consisted of glucose were higher than others, and in salts those that possessed a higher ionic charge had higher antifreeze activities. In water-soluble amino acids, a few amino acids that formed no eutectic mixture above  $-20^{\circ}\text{C}$  had especially high antifreeze activities. The high antifreeze activity is caused by immobilizing activity for water molecules, and the immobilizing mechanism varied with the type of solute [141]. The antifreeze proteins depress the freezing point by attaching to ice crystals and interfering with water molecules joining the ice lattice. Computer modeling suggests that at least for one antifreeze peptide, the molecules are arranged in an antiparallel fashion with cooperative side-to-side binding [121]. There are two groups of antifreeze proteins: antifreeze glycoproteins and antifreeze proteins. The primary structure of the antifreeze glycoproteins is a repeating (Ala-Ala-Thr) sequence with a disaccharide attached to the threonine residue. The antifreeze proteins have various structures. Type I proteins have an  $\alpha$ -helical structure, whereas type II and III proteins have some unusual secondary structures. Synthetic antifreeze peptides may have also practical applications in foods [121]. In a recent report, it is mentioned that phenomenon of cold acclimation in carrots was related with biochemical and physiological changes in the fresh plant [74]. The presence of antifreeze protein within the roots was related to cold acclimation and its quality enhancement through freezing.

#### 26.3.5.1.5 *Osmotic Concentration*

Partial removal of water by osmotic treatment to freezing is recognized as convenient for reducing cellular damage of fruits and vegetables, which causes softness after thawing [183]. Osmotic concentration of vegetables prior to freezing is a pretreatment that can improve final product quality [25,183]. It is well established that osmotic dehydration improves the product quality in terms of color, flavor, and texture. The merits of osmotic dehydration for product-quality improvement and process efficiency were reviewed earlier [161,163,191]. The effects of sugar on the quality of frozen fruits have been reviewed by Skrede [181]. However, in the literature there is not much fundamental information about the mechanisms of flavor entrapment in the food matrix, color retention, and physics of textural improvement. In the frozen food industry, high energy levels are used for freezing because a large quantity of water is present in fresh foods. A significant proportion of this energy could be saved if plant materials were concentrated prior to freezing [90]. A reduction in the moisture content of food can reduce refrigeration load during freezing. Partially concentrating fruit and vegetables prior to freezing saves packaging and distribution costs [17]. The product quality is comparable with that of conventional products. The process is referred to as dehydrofreezing.

#### 26.3.5.1.6 *Cryoprotection*

Meat and fish muscle is susceptible to freeze denaturation, which decreases gel-forming potential, water-holding capacity, and protein solubility. Cryoprotectants are generally added to protect fish myofibrillar proteins from freeze denaturation during frozen storage [152]. Polydextrose, sucrose, and sorbitol have



been reported to protect against freeze denaturation of Alaskan pollack surimi [151]. These are low in cost, safe, and have good solubility and beneficial functional effects [107,128]. Sucrose is usually combined with sorbitol to reduce sweetness. The cryoprotective effect of sugar is enhanced by adding polyphosphate [115]. Polydextrose proved to be an effective cryoprotectant for both pre- and postrigor beef. Arakawa and Timasheff [6] found that cryoprotectants increase the surface tension of water as well as the binding energy, preventing withdrawal of water molecules from the protein and thus stabilizing the protein. Phosphates had no cryoprotective effect but did increase pH and enhanced protein extractability, which may enhance gel-forming and water-holding properties [131].

Park et al. [152] found that cooked gel strength was unaffected by freezing of beef or pork surimi-like materials for 48 h, and addition of cryoprotectants (3% or 6% sorbitol, 3% glycerol, or 3% sucrose) before freezing had no effect on gel-forming ability. The washed myofibrillar proteins from beef muscle were quite stable during freeze-thaw treatment up to 6% sodium chloride. No difference in gel-forming ability after freezing with or without added salt was found. Wierbicki et al. [206] also reported no detrimental effects on water-holding capacity due to salting of meat prior to freezing. The interaction between salt ions and muscle proteins occurs rapidly, compared to the normal process of shrinking or coagulation of muscle proteins [39]. Dondero et al. [48] studied the cryoprotective effects of 18, 20, 25, and 36 DE (dextrose equivalents) maltodextrins at 8% (w/w) in surimi from jack mackerel stored at  $-18^{\circ}\text{C}$  for 27 weeks. They found that 20 and 25 DE maltodextrins as well as sucrose or sorbitol mixtures were most effective in stabilizing surimi proteins during frozen storage [48].

Poultry meat showed little deterioration upon freezing and isolated myofibrillar systems made by the surimi procedure are less stable [128]. Kijowski and Richardson [104] found that mechanically recovered meat from broilers had reduced functionality when no cryoprotectants were used. Sorbitol or sucrose showed some protection of gel-forming ability of frozen samples, and sorbitol or sucrose with tripolyphosphate gave stronger gels after freezing or freeze drying than fresh samples. The combined presence of sorbitol, sucrose, and tripolyphosphate restored most functional properties of frozen or freeze-dried material to that of the fresh material. Most of the loss of functionality during freezing or freeze-drying was caused by the loss of solubility of myosin and, to a lesser extent, actin. Freeze drying had a greater effect when no additive or NaCl was present. The blast-frozen and freeze-dried samples with no cryoprotectants had a very coarse structure with no obvious fine network system. In the presence of sorbitol or sucrose, there was a finer meshwork for freeze-dried material, which was finer for frozen material. In the presence of sorbitol or sucrose with tripolyphosphate, the network was even finer but with less obvious spaces in the matrix for both freeze-dried and frozen material. These were observed by scanning electron microscope.

Whole egg and yolk products are fortified with salt or sugar before freezing to prevent coagulation during thawing. The selection of additive depends upon the finished product specifications. Salt (10%) is added to yolks used in mayonnaise and salad dressings, and sugar (10%) is added to yolks used in baking, ice cream, and confectionary. Egg whites are not fortified as they do not have gelation problems during defrosting [5]. Table 26.1 shows the effects of freezing on the functional properties of liquid egg products. HMW polymer cryoprotectants have the following advantages over LMW cryoprotectants [105]:

1. HMW polymers do not generally penetrate the cell membrane and remain in the extracellular suspensions and/or outer surface of the cell.
2. HMW polymers do not produce a significant freezing point depression within the range of concentrations that can be applied in practice.
3. There is no binary eutectic effect, i.e., the hydrated polymer does not crystallize from aqueous solution as LMW agents do.
4. HMW polymers have the ability to keep a substantial portion of the solution from freezing.

Although the presence of HMW polymeric cryoprotectants is limited to the extracellular suspension medium, HMW additives affect the intracellular composition by the efflux of intracellular water due to chemical potential change across the membrane when extracellular ice is formed [105].

**TABLE 26.1**

General Effects of Freezing Rate, Storage Time, Storage Temperature, Thawing Rate, and Additives on Functional Properties of Liquid Egg Products

Factor	Effect on Functional Properties		
	Egg Albumen <sup>a</sup>	Egg Yolk <sup>b</sup>	Whole Egg <sup>c</sup>
Freezing rate	Slower rate causes: reduced viscosity and increased foam stability	Slow rate causes: increased viscosity and gelation	Same as liquid egg yolk but less severe
Storage time	Longer time causes: reduced viscosity and increased foam stability	Longer time causes: increased viscosity and gelation	Same as liquid egg yolk but less severe
Storage temperature	Lower temperature causes: reduced viscosity and increased foam stability	−18°C results in maximum increase in viscosity and gelation	Same as liquid egg yolk but less severe
Thawing rate	Faster rate causes: some protein denaturation	Slower rate causes: increased viscosity and gelation	Same as liquid egg yolk but less severe
Additives	None normally needed	2% NaCl and 8% sucrose inhibit gelation; 10% used commercially	None normally needed

<sup>a</sup>Freezing usually has only a slight effect on egg albumen properties.

<sup>b</sup>Freezing often has a drastic effect on egg yolk viscosity.

<sup>c</sup>Freezing has a greater effect on whole egg properties than albumen but less than the effect on egg yolk.

Source: P. L. Dawson, *Freezing Effects on Food Quality* (L. E. Jeremiah, ed.), Marcel Dekker, New York, 1996, p. 337.

#### 26.3.5.1.7 Irradiation

High-dose irradiation can produce changes in the chemical composition and taste of fish and seafood. A combination of irradiation and freezing can be used in foods. A combination treatment involving freezing in conjunction with irradiation has recently been proposed as a means of retarding spoilage. It has been reported that some European countries irradiated frozen seafoods from Asia to eliminate microbial pathogens such as *Salmonella* [172].

#### 26.3.5.2 Storage and Display

Packaging, storage, and display also affect the frozen food quality. Loss of quality in frozen foods is a gradual process; the changes being slow or very slow, cumulative, and irreversible [187]. Optimum quality requires care in every stage of processing, packaging, storage, and marketing sequence. Storage temperature is important for frozen food. Symons [187] mentioned that the speed of freezing was not as important to product quality as the maintenance of adequately cold temperatures (−18°C or less) during distribution. A package for frozen product should (a) be attractive and appeal to the consumer, (b) protect the product from external contamination during transport and handling, and from permeable gases and moisture vapor transfer, (c) allow rapid, efficient freezing and ease of handling, and (4) be cost effective. To provide the greatest protection, a package must be well evacuated of air (oxygen) using a vacuum or gas-flushed system and provide an adequate barrier to both oxygen and moisture [5,176]. Since cost is involved in vacuum or modified-atmosphere packaging, these should be used when necessary for quality. For example, vacuum packaging need not be used if lipid oxidation is not the limiting factor affecting the shelf life of a product.

The shelf life of frozen foods kept in open display cabinets at −15°C packed in 23 different types of plastic, cardboard, and laminate was studied. It was found that aluminum foil-laminated and metallized packages gave the best results. This is due to low levels of oxygen permeability, water vapor transmission, and light transparency, and less fluctuating temperatures [2]. Two terms used to describe the shelf life of frozen foods are practical storage life (PSL) and just noticeable difference (JND). PSL is the level of quality expected for the product by the ultimate consumer. JND is usually determined by a trained taste panel,

and then multiplied by an arbitrary figure, generally between 2 and 5, to arrive at a PSL [187]. In some sensitive products, such as peaches, cauliflower, red-pigmented fish, the PSL may be close to the JND [187]. Most frozen products enjoy a shelf life of many months or even years [187].

Quality losses of frozen food increase log linearly with the storage temperature when greater than  $-18^{\circ}\text{C}$  [113]. The rate of quality loss increases about 2–2.5 times for every  $5^{\circ}\text{C}$  increase over  $-18^{\circ}\text{C}$  [72,111,112]. In poultry, it has been suggested that shelf life is likely to change by a factor of 3.5 for each  $10^{\circ}\text{C}$  change, up or down [176]. In seafood kept at around  $0^{\circ}\text{C}$ , enzymatic breakdown of protein becomes the main cause of quality loss, below  $-8^{\circ}\text{C}$  microbiological spoilage ceases, and protein denaturation coupled with oxidative rancidity in fatty species becomes the chief factor affecting quality [168, 187]. Some types of foods, such as fish, pork, animal organs, fried chicken, and spinach, can be maintained in a high-quality state for only 3–7 months at  $-20^{\circ}\text{C}$ , whereas other foods, such as beef, sugared fruits, many bakery products, and many vegetables, can be maintained in a high-quality state for more than 12 months at  $-20^{\circ}\text{C}$  [54]. Fish stored at  $-29^{\circ}\text{C}$  will have a shelf life of more than a year [5]. Some PSL values determined by the International Institute of Refrigeration (IIF) are reported by Symons [187].

### **26.3.5.3 Thawing**

Thawing as a final and obligatory step of the freezing process is quite important. Thawing properly is essential to maximize quality retention and safety of frozen foods. Microbiologically safe thawing process includes: (a) inside a refrigerator at temperatures below  $5^{\circ}\text{C}$ , (b) microwave oven, or (c) as part of the cooking treatment [135]. Although thermal processing in microwave and cooking assures a better microbial destruction when compared with thawing inside a refrigerator, sensory retention is compromised. In a study on green beans' quality loss upon thawing, Martins and Silva [135] found that sensory parameters, such as flavor and color, were more sensitive to thawing at refrigeration temperature ( $3^{\circ}\text{C}$ – $7^{\circ}\text{C}$ ) than nutritional properties, such as vitamin C and starch contents. In a study of Virtanen et al. [197], the thawing time of a model food system based in wheat flour was reduced to a seventh part, when they combined microwave energy and cold air in comparison to convective thawing at ambient temperature, but no quality changes were quantified. High-pressure, microwave, ohmic, and acoustic thawing are innovative applications that are being explored to improve the conventional thawing methods. High pressure preserves food quality and reduces the necessary time for thawing; but some inconvenient characteristics have been mentioned, such as high costs, protein denaturation, and meat discoloration [119]. Similarly, microwave, ohmic, and acoustic thawing may require shorter thawing times, but some limitations have been found. Heterogeneous heating, controlled frequencies, and much more investigations need to be considered with these new thawing methods [120].

## **26.3.6 Cold Chain Tolerance and Quality**

### **26.3.6.1 Temperature Cycling**

The steps in the frozen food cold chain are freezing, transport by refrigerated vehicle or container, distribution store, retail display cabinet, the unrefrigerated period between retail outlet and home, and time in a home freezer before being consumed in the frozen state, thawed or end cooked. Temperature abuse at any of the above steps causes quality deterioration. Time-temperature indicators have been proposed to monitor the lack of adequately cold temperatures during the cold chain. Fluctuations in storage temperature may contribute to deterioration of frozen foods [142].

### **26.3.6.2 Time-Temperature Tolerance Indicators**

The concept of time-temperature tolerance (TTT) to describe frozen food stability is important. Physicochemical, chemical, or biological reactions give an irreversible indication (usually visible) of the history of the product. These indicators are placed on the outside of the packages and combine the time and temperature conditions to which they have been exposed [25]. Temperature history indicators do not provide a precise record of temperature as it changes with time, as do time-temperature recorders or digital data acquisition systems, but are less costly [203]. Indicators that respond

continuously for all temperature conditions are said to be full-history indicators, whereas devices that respond only for the period of time during which a temperature threshold has been exceeded are called partial-history indicators [204]. More detailed review of time-temperature indicators is given by Taoukis et al. [189]. The applicability and effectiveness of time-temperature integrators (TTI) as monitors and controlling tools for frozen chain and distribution of frozen vegetables, green peas, and mushrooms were assessed by Giannakourou and Taoukis [71]. In this analysis, TTI response provided a reliable indication of the relative quality status of the frozen products, in which these TTI tools may be utilized as base to optimize the management system and consequently to improve consumer acceptance [71].

---

## 26.4 Freezing Methods

The overall cost of freezing preservation is lower than that of canning or drying if the freezer can be kept full [82]. If the material enters the freezer at just above the freezing point, a more controlled crystallization occurs compared to material at ambient temperature. Different types of freezing systems are available for foods. No single freezing system can satisfy all freezing needs because of a wide variety of food products and process characteristics [88]. The selection criteria of a freezing method are the type of product, reliable and economic operation, easy cleaning ability, hygienic design, and desired product quality [5]. Although all commercial freezing processes are operated at atmospheric conditions, there are potential applications of high-pressure assisted freezing and thawing of foods. The pressure-induced freezing point and melting point depression enables the sample to be supercooled at low temperature (e.g.,  $-22^{\circ}\text{C}$  at 207.5 MPa), resulting in rapid and uniform nucleation and growth of ice crystals on release of pressure. Other results include increased thawing rates, the possibility of non-frozen storage at subzero temperatures, and various high-density polymorphic forms of ice [97]. Details of the applications of this process are reviewed by Kalichevsky et al. [97]. In the food industry, plate contact, immersion, air blast, fluidized-bed, and cryogenic freezing are common methods. The freezing rate in these methods is achieved by controlling the convective or surface heat transfer coefficient with a typical range of 5–2000  $\text{W}/\text{m}^2\text{K}$  [196]; and the thermal conductivity of foods ranged from 0.5 to 1.5  $\text{W}/\text{m K}$  [186]. On the other side, heat to be removed from the foods (i.e., refrigeration load) mainly depends on the specific heat and latent heat. Some data of these important physical properties are included in Table 26.2 [27,195,196].

### 26.4.1 Freezing by Contact with a Cooled Solid: Plate Freezing

In this method, the product is sandwiched between metal plates and pressure is usually applied for good contact. Plate freezers are only suitable for regular shaped materials or blocks. When the product has been frozen, hot liquid is circulated to break ice seal and defrost. Spacers should be used between the plates during freezing to prevent crushing or bulging of the package.

### 26.4.2 Freezing by Contact with a Cooled Liquid: Immersion Freezing

In this method, food is immersed in a low-temperature brine to achieve fast temperature reduction through direct heat exchange [88]. The fluids usually used are salt solutions (sodium chloride), sugar solutions, glycol and glycerol solutions, and alcohol solutions. The solutes used must be safe to the product in terms of health, taste, color, and flavor, and the product must be denser than fluids. Dilution from the foods may change the concentration, thus it is necessary to control the concentration to maintain a constant bath temperature. To ensure that the food does not come into contact with liquid refrigerants, flexible membranes can be used to enclose the food completely while allowing rapid heat transfer [69]. The water loss and salt gain, were less than 2 and 1 g/100 g respectively of the initial gelatin gel in immersion freezing with sodium chloride solution. The salt penetration was hindered by formation of an ice barrier [126]. A mixture of glycerol and glycol is liquid–liquid medium, thus it can also be used since there is no eutectic point. As the temperature is lowered, a point is reached where ice crystals are formed as slush. The temperature

TABLE 26.2

Physical Properties of Some Freezing Systems and Food Products

Typical Surface Heat Transfer Coefficient and Foods Thermal Conductivity			
Freezer Type	Conditions	$h$ (W/m <sup>2</sup> K)	Example Foods Preserved by the Method
Cold room	Still air	5–10	Beef carcass, chicken, fruits, vegetables.
Air-blast	Air velocity: 2.5–5 m/s	15–30	Fruits, vegetables, fish fillets.
Tunnel	Counterflow of food item and air	15–60	Grains, soybean, fish fillets.
Fluidized-bed	Suspending airstream	80–120	Carrot cubes, peas, shrimp, strawberries.
Plates	Contact to solid	50–120	Meat steaks, fish fillets, leafy vegetables.
Cryogenic	Gas zone/spray zone	40–60/100–140	Ice cream, shrimp, berries.
Liquid immersion	Circulating brine	60–90	Chicken, turkey, canned foods.
	Specialized refrigerant	500–1200	Fruits, tomato slices, orange segments.

Food Item	$k$ (W/m K)	$C_p$ above and below Freezing (kJ/kg K)		Latent Heat of Fusion (kJ/kg)
Apples	0.513 (before freezing, water 84.9%)	3.65	1.90	281
Bananas	0.481 (before freezing, water 75.7%)	3.35	1.78	251
Chicken		3.32	1.77	247
Ice cream	0.460 (before freezing, at 0°C)	2.95	1.63	210
Milk (whole)	0.473 (before freezing, water 87.0%)	3.79	1.95	294
Oranges	0.580 (before freezing, water 85.9%)	3.75	1.94	291
Shrimp	0.490 (before freezing, water 75.3%, fat 1.2%)	3.62	1.89	277
Strawberries	0.462 (before freezing/1.125 (at –15.5°C)	3.86	1.97	301
Tomato (ripe)	0.571 (before freezing, water 92.3%)	3.99	2.02	314
Turkey	0.343 (before freezing, water 92.8%, fat 12.4%)	2.98	1.65	214
	1.437 (water 92.8%, fat 12.4%, at –9.4°C)			
	1.627 (water 92.8%, fat 12.4%, at –23.3°C)			
Water	0.594 (before freezing, at 0°C)	4.23 (at 0°C)	2.01	334
Watermelon	0.571 (before freezing, water 92.8%)	3.96	2.01	311

at which slush ceases to flow is called the flow point. Methanol or ethanol can also be used. Although the methanol will be removed during cooking, it is poisonous whereas ethanol is safe. Alcohols also pose a fire hazard in processing plants.

### 26.4.3 Freezing by Contact with a Cooled Gas

#### 26.4.3.1 Cabinet Freezing

In this method, cold air is circulated in a cabinet where product is placed in a tray. The moisture pick-up from the product surface may deposit on the cooling coils as frost, which acts as an insulation. A cabinet freezer with air velocity at least 5 m/s generates high heat-transfer rates [88].

#### 26.4.3.2 Air-Blast Freezing

In this method, the temperature of food is reduced with cold air flowing at a relatively high speed. Air velocities between 2.5 and 5 m/s give the most economical freezing. Lower air velocities result in slow product freezing, and higher velocities increase unit-freezing costs considerably [5]. This method can be further divided into tunnel freezing, belt freezing, and fluidized bed freezing, depending on how air interacts with the product [88].

##### 26.4.3.2.1 Fluidized Bed Freezing

A fluidized bed freezer consists of a bed with perforated bottom through which refrigerated air is blown vertically upward. The air velocity must be greater than the fluidization velocity. This freezing method is suitable for small particulate food bodies of fairly uniform size, e.g., peas, diced carrots and potatoes,

corns, and berry fruits. The high degree of fluidization improves the heat-transfer rate and results in good use of floor space.

#### 26.4.3.2.2 *Belt Freezing*

The first mechanized air-blast freezers consisted of a wire mesh belt conveyor in a blast room for continuous product flow. Uniform product distribution over the entire belt is required to achieve uniform product contact and effective freezing. Controlled vertical airflow forces cold air up through the product layer, thereby creating good contact with the product particles and increasing the efficiency. The principal current design is the two-stage belt freezer. Temperatures used usually are  $-10^{\circ}\text{C}$  to  $-4^{\circ}\text{C}$  in the precool section and  $-32^{\circ}\text{C}$  to  $-40^{\circ}\text{C}$  in the freezing section [5].

#### 26.4.3.2.3 *Spiral Freezing*

A spiral belt freezer consists of a long belt wrapped cylindrically in two tiers, thus requiring a minimal floor space. The spiral freezer uses a conveyor belt that can be bent laterally. It is suitable for products with a long freezing time (generally 10 min to 3 h), and for products that require gentle handling during freezing. It also requires a spatial air-distribution system [5].

#### 26.4.3.2.4 *Tunnel Freezing*

In this process, products are placed in trays or racks in a long tunnel and cool air is circulated over the product.

### 26.4.4 **Cryogenic Freezing**

In cryogenic freezing, liquefied gases are placed in direct contact with the foods. Food is exposed to an atmosphere below  $-60^{\circ}\text{C}$  through direct contact with liquid nitrogen or liquid carbon dioxide or their vapor [88]. This is a very fast method of freezing; thus, adequate control is necessary for achieving quality products. It also provides flexibility by being compatible with various types of food products and having low capital cost [69]. The rapid formation of small ice crystals greatly reduces the damage caused by cell rupture, preserving color, texture, flavor, and nutritional value. The rapid freezing also reduces the evaporative weight loss from the products, provides high product throughput, and has low floor space requirements [69]. Thermal diffusivity of the food will, however, restrict the heat transfer of heat from the product to the freezing medium [69]. Cryogenic gases can also be advantageously applied to produce a hard, frozen crust on a soft product to allow for easier handling, packaging, or further processing [122]. The cryomechanical technique utilizes a cryogenic gas to create a frozen crust on a fluid product, after which the product may then be conveyed to a conventional mechanical freezer. Combination of these processes offers advantages of both systems [69]. The advantages of liquid nitrogen are that it is colorless, odorless, chemically inert, and boils at  $-195.8^{\circ}\text{C}$  [177]. It is usually used for high-value products due to the high capital cost for gas compression. The product can be exposed to a cryogenic medium in three ways: (a) the cryogenic liquid is directly sprayed on the product in a tunnel freezer, (b) the cryogenic liquid is vaporized and blown over the food in a spiral freezer or batch freezer, or (c) the product is immersed in cryogenic liquid in an immersion freezer [78,177].

---

## 26.5 **Emerging Freezing Techniques**

Some new freezing techniques or combinations are being developed for their potential benefits, technical and economical advantages, and quality enhancements. Several kinds of high-pressure ices with different chemical structures and physical properties are reported [57,86]. A pressure-shift or high-pressure freezing process can generate small and uniform ice crystals [119,211]. Improved

structures by pressure-shift freezing are reported for tofu (soybean curd) [67,98] and carrots [66]. In case of the tofu, the texture was almost same for pressure above 200 MPa as in the case of the untreated tofu [67]. Similarly, in case of carrots above pressure 100 MPa, the damage could be reduced significantly [66]. The freezing point of water from 0°C at 101.3 kPa can be shifted to -21°C under  $2.1 \times 10^5$  kPa [211]. Zhu et al. [211] carried out a comparative study on pork muscle applying pressure-shift, air-blast, and liquid-immersion freezing methods. They found differences in size and distribution of ice crystals and consequent muscle damage, in which the pressure-shift freezing prevented the muscle disruption. A cryomechanical or combined freezing with cryogenic freezing followed by air-blast freezing was utilized to improve frozen food product quality. It is recommended for delicate products with poor mechanical resistance, such as shrimp, raspberries, strawberries; or chicken and mushrooms when significant changes occurred in the product [1]. In this combined process, a protective crust is formed through the immersion in the liquid N<sub>2</sub>, which is characteristic of the products. A dehydrofreezing method is a combined method of a controlled dehydration previously to the freezing stage, which is mainly promising for fruits and vegetables preservation due to the high moisture content. This technique reduces refrigeration loads and packaging, storage, and distribution costs; and provides a comparable quality [119].

---

## 26.6 Addition to Hurdle Technology

Freezing process can be used as one of the hurdles in combined methods of food preservation. Piotrowski et al. [157] carried out a study with osmotic dehydration, freezing, and microwave convective drying to preserve strawberries. In case of apple cubes, an osmotic dehydration treatment followed by freezing provided good quality and acceptance. The optimum conditions were found to be 55°Brix, 35°C for the solution, and 60 min of osmotic dehydration time with a fast freezing [21]. Sun and Li [186] and Li and Sun [120] applied ultrasound with freezing to potato tissues, which resulted in an improved freezing rate. Higher freezing rates produced better cellular structure, less intercellular void formation, and less cell disruption when studied by cryoscanning microscopy analysis. The application of power ultrasound was effective in improving the structure of frozen-then-thawed potatoes. A combination of dehydration in concentrated solutions and freezing was applied to muskmelons [129] and strawberry slices [183] to identify improvement in texture and structure. Moisture reduction of muskmelon, prior to the freezing process, improved the quality by reduction in the exudates' loss and texture after thawing [129]. Also after thawing, the predehydrated strawberry samples exhibited a better tissue organization than the frozen slices without pretreatment, being the best texture that corresponded to air-dried and the osmotic concentrated-air-dried strawberry samples [183]. Fagan et al. [52] utilized a modified-atmosphere packaging, with different N<sub>2</sub>/CO<sub>2</sub> ratios, combined with freeze chilling to extend the shelf life of raw whiting, mackerel, and salmon, finding that these combined technologies confer logistic benefits not only during frozen storage but also in product distribution and retailing.

---

## 26.7 Future Research in Freezing Process

Further research needs to be targeted in the following areas: (i) heat and mass transfer phenomena involved during freezing, storage, and thawing; (ii) measurement and prediction of food properties during freezing and thawing, such as enthalpy changes, convective heat transfer coefficients, nutrient, and quality kinetics; and (iii) prediction of freezing and thawing time, and freezing rates. Concepts based on engineering principles, mathematical knowledge, and modeling as well as computer simulation need to be included as part of a good process development, equipment design, and optimization of food freezers. Quality kinetics need to be included in optimization of freezing process. A short list of studies related to the aforementioned engineering aspects is presented in Table 26.3. Implementing hazard analysis and critical control point, and compliance with all aspects of good manufacturing practice could be properly applied to ensure the quality and safety of frozen foods.

TABLE 26.3

Engineering Concepts Importantly Related to Freezing Process, Frozen Storage, and Thawing

Engineering Concept	Comment	Tested Food	Reference
Freezing time	Combination of plank and unsteady heat transfer equations	Beef	[136]
Freezing time	Comparison of existing approaches, analytical and numerical	Strawberries	[83]
Freezing and thawing times	Experimental and predicted freezing and thawing times	Lean beef	[33]
Thermophysical properties	Computer program developed to predict freezing and thawing times: Method based on enthalpy formulations	Codfish	
Freezing and thawing times	Analytical method developed for high water foods	Fishes, meats	[171]
Properties, freezing time, and heat load	Prediction of enthalpy–temperature curves of foods over a range –40°C to 40°C	Cheese, fish, fruits, meats	[155]
Enthalpy and properties	Industrially processed food materials except fatty foods	Lean beef	[56]
Freezing processes	Update of freezing time predictive models based on heat	Meat balls	
Weight loss kinetics	Mathematical model based on heat and mass balances, and mass transfer phenomenon	Meat, potato Beef	[24] [41]
Freezing and thawing times	Comparison of predictive models with experimental data	Fish, potato	[123]
Thermal-physical properties	Experimental and computer properties' comparison	Green peas	[134]
Heat transfer rates and	Numerical model based on energy equation with the	Beef, egg	
Enthalpy change	Navier–Stokes equations		[85]
Quality loss kinetics	Computational evaluation of frozen quality profile	Green beans	[135]

## References

1. M. E. Agnelli and R. H. Mascheroni, Quality evaluation of foodstuffs frozen in a cryomechanical freezer, *J. Food Engng.* 52: 257 (2002).
2. P. Ahvenainen and Y. Malkki, Influence of packaging on the shelf life of frozen carrot, fish and ice cream, *Thermal Processing and Quality of Foods* (P. Zeuthen, J. C. Cheftel, C. Eriksson, M. Jul, H. Leniger, P. Linko, G. Vos, and G. Varela, eds.), Elsevier Applied Science, London, 1984, p. 528.
3. C. Alvarez, A. Huidobro, M. Tejada, I. Vázquez, E. De Migel, and I. A. Gómez de Segura, Consequences of frozen storage for nutritional value of hake, *Food Sci. Tech. Int.* 6: 493 (1999).
4. G. P. Archer, C. J. Kennedy, and A. J. Wilson, Position paper: Towards predictive microbiology in frozen food systems—A framework for understanding microbial population dynamics in frozen structures and in freeze-thaw cycles, *Int. J. Food Sci. Technol.* 30: 711 (1995).
5. ASHRAE Handbook, *Refrigeration Systems and Applications*, American Society of Heating, Refrigerating, and Air-conditioning Engineers, Atlanta, GA, 1994.
6. T. Arakawa and S. N. Timasheff, Stabilization of protein structure by sugars, *Biochem.* 21: 6536 (1982).
7. C. Barbagli and G. S. Crescenzi, Influence of freezing and thawing on the release of cytochrome oxidase from chicken's liver and from beef and trout muscle, *J. Food Sci.* 46: 491 (1981).
8. L. G. Bartolome and J. E. Hoff, Firming of potatoes: Biochemical effects of preheating, *J. Agric. Food Chem.* 20: 266 (1972).



9. A. P. Bartolome, P. Ruperez, and C. Fuster, Non-volatile organic acids, pH and titratable acidity changes in pineapple fruit slices during frozen storage, *J. Sci. Food Agric.* 70: 475 (1996).
10. A. P. Bartolome, P. Ruperez, and C. Fuster, Changes in soluble sugars of two pineapple fruit cultivars during frozen storage, *Food Chem.* 56: 163 (1996).
11. A. P. Bartolome, P. Ruperez, and C. Fuster, Freezing rate and frozen storage effects on color and sensory characteristics of pineapple fruit slices, *J. Food Sci.* 61: 154 (1996).
12. P. S. Belton and I. J. Colquhoun, Nuclear magnetic resonance spectroscopy in food research, *Spectroscopy* 4(9): 22 (1989).
13. G. Bennett, J. F. Cone, M. L. Dodds, J. C. Garrey, N. N. Guerrant, J. G. Heck, J. F. Murphy, J. E. Nicholas, J. S. Perry, R. T. Piercf, and M. D. Show, *Some Factors Affecting the Quality of Frozen Foods*, Bull. of Penn. State Univ., State College, PA, No. 580, 1954.
14. N. C. Bertola, A. N. Califano, A. E. Bevilacqua, and N. E. Zaritzky, Effect of freezing conditions on functional properties of low moisture mozzarella cheese, *J. Dairy Sci.* 79: 185 (1996).
15. N. C. Bertola, A. N. Califano, A. E. Bevilacqua, and N. E. Zaritzky, Textural changes and proteolysis of low-moisture mozzarella cheese frozen under various conditions, *Food Sci. Technol.* 29: 470 (1996).
16. A. Bevilacqua, N. E. Zaritzky, and A. Calvelo, Histological measurements of ice in frozen beef, *J. Food Technol.* 14: 237 (1979).
17. R. N. Biswal, K. Bozorgmehr, F. D. Tompkins, and X. Liu, Osmotic concentration of green beans prior to freezing, *J. Food Sci.* 56: 1008 (1991).
18. R. I. Boeri, M. E. Alamandos, A. S. Ciarlo, and D. H. Gianni, Formaldehyde instead of dimethylamine as a measure of total formaldehyde formed in frozen Argentine hake (*Merluccius hubbsi*), *Int. J. Food Sci. Technol.* 28: 289 (1993).
19. H. Bottcher, Enzyme activity and quality of frozen vegetables. I. Remaining residual activity of peroxidase, *Nahrung* 19: 173 (1975).
20. A. W. Brant and G. F. Stewart, Bone darkening in frozen poultry, *Food Technol.* 4: 168 (1950).
21. A. Bunger, P. C. Moyano, R. E. Vega, P. Guerrero, and F. Osorio, Osmotic dehydration and freezing as combined processes on apple preservation, *Food Sci. Tech. Int.* 10: 163 (2004).
22. H. Buttkus, Accelerated denaturation of myosin in frozen solution, *J. Food Sci.* 35: 559 (1970).
23. L. A. Campañone, L. A. Roche, V. O. Salvadori, and R. H. Mascheroni, Monitoring of weight losses in meat products during freezing and frozen storage, *Food Sci. Tech. Int.* 8: 229 (2002).
24. L. A. Campañone, V. O. Salvadori, and R. H. Mascheroni, Weight loss during freezing and storage of unpackaged foods, *J. Food Eng.* 47: 69 (2001).
25. M. P. Cano, *Vegetables, Freezing Effects on Food Quality* (L. E. Jeremiah, ed.), Marcel Dekker, New York, 1996, p. 247.
26. M. P. Cano and M. A. Marin, Pigment composition and color of frozen and canned kiwi fruit slices, *J. Agric. Food Chem.* 40: 2141 (1992).
27. Y. A. Cengel and M. A. Boles, *Thermodynamics. An Engineering Approach*, McGraw-Hill, New York, 2002, p. 829.
28. M. A. Cervantes, D. B. Lund, and N. F. Olson, Effects of salt concentration and freezing on mozzarella cheese texture, *J. Dairy Sci.* 66: 204 (1983).
29. S. Y. Cho, Y. Endo, K. Fujimoto, and T. Kaneda, Autoxidation of ethyl eicosapentanoate in a defatted model system. *Nippon Suisan Gakkai Shi* 53(3): 545 (1989).
30. L. Chow and B. M. Watts, Origin of off odors in frozen green beans, *Food Technol.* 23: 113 (1969).
31. H. J. Chung, H. Y. Jeong, and S. T. Lim, Effects of acid hydrolysis and defatting on crystallinity and pasting properties of freeze-thawed high amylase corn starch, *Carbohydr. Polym.* 54: 449 (2003).
32. H. M. Churchill, A. O. Scott, and C. K. Erb, *A Study of the Biochemical and Chemical Causes of Quality Changes in Frozen Vegetables*, Campden Food and Drink Research Association, Technical Memorandum, No. 517, 1989.
33. D. J. Cleland, A. C. Cleland, R. L. Earle, and S. J. Byrne, Experimental data for freezing and thawing of multi-dimensional objects, *Int. J. Refrig.* 10: 22 (1987).
34. J. K. Collins, C. L. Biles, E. V. Wann, P. Perkins-Veazie, and N. Maness, Flavour, qualities of frozen sweetcorn are affected by genotype and blanching, *J. Sci. Food Agric.* 72: 425 (1996).
35. J. J. Connell and P. Howgate, Consumer evaluation of fresh and frozen fish, *Inspection and Quality* (R. Kreuzer, ed.), Fishing News (Book), Surrey, 1971, p. 155.
36. W. P. Cowie and W. T. Little, The relationship between the toughness of cod stored at  $-29^{\circ}\text{C}$  and its muscle protein solubility and pH, *J. Food Technol.* 1: 335 (1966).

37. D. G. Dahlstrom, Frozen storage of low moisture part skim mozzarella cheese, *M.S. Thesis*, Univ. Wisconsin, Madison (1978).
38. P. L. Dawson, Effects of freezing, frozen storage, and thawing on eggs and egg products, *Freezing Effects on Food Quality* (L. E. Jeremiah, ed.), Marcel Dekker, New York, 1996, p. 337.
39. F. E. Deatherage and R. Hamm, Influence of freezing and thawing on hydration and changes of the muscle proteins, *Food Res.* 25: 623 (1960).
40. S. De Kock, A. Minnaar, D. Berry, and J. R. N. Taylor, The effect of freezing rate on the quality of cellular and non-cellular par-cooked starchy convenience foods, *Food Sci. Technol.* 28: 87 (1995).
41. A. E. Delgado and D.-W. Sun, Heat and mass transfer models for predicting freezing processes- a review, *J. Food Eng.* 47: 157 (2003).
42. J. M. DeMan, P. W. Voisey, V. F. Rasper, and D. W. Stanley, *Rheology and Texture in Food Quality*, Van Nostrand Reinhold/Avi, New York, 1976.
43. H. Deng and Y. Ueda, Effects of freezing methods and storage temperature on flavor stability and ester contents of frozen strawberries, *J. Japan Soc. Hort. Sci.* 62: 633 (1993).
44. H. Deng, Y. Ueda, K. Chachin, and H. Yamanaka, Off-flavor production in frozen strawberries, *Postharv. Biol. Technol.* 9: 31 (1996).
45. W. C. Dietrich, M. D. Nutting, R. L. Olson, F. E. Lindquist, M. M. Boggs, G. S. Bohart, H. I. Neumann, and H. J. Morris, Time-tolerance of frozen foods. XVI. Quality retention of frozen green snap beans in retail packages, *Food Technol.* 13: 136 (1959).
46. W. C. Dietrich, M. M. Boggs, M. D. Nutting, and N. E. Weinstein, Time-tolerance of frozen foods. XVI. Quality retention of frozen foods. XIII. Quality changes in frozen spinach, *Food Technol.* 14: 155 (1960).
47. W. C. Dietrich, C. C. Huxsoll, and D. G. Guadagni, Comparison of microwave, conventional and combination blanching of brussels sprouts for frozen storage, *Food Technol.* 24: 613 (1970).
48. M. Dondero, C. Sepulveda, and E. Curotto, Cryoprotective effect of maltodextrins on surimi from jack mackerel (*Trachurus murphyi*), *Food Sci. Technol. Int.* 2: 151 (1996).
49. C. Douillard and E. Guichard, The aroma strawberry (*Fragaria ananassa*): Characterisation of some cultivars and influence of freezing, *J. Sci. Food Agric.* 50: 517 (1990).
50. W. J. Dyer, D. I. Fraser, D. G. Ellis, and D. R. Idler, Quality changes in stored refrozen cod fillets, *Supp. Bull. Inst. Inter. Froid Annexe 1*: 515 (1962).
51. S. El-Kest and E. H. Marth, Freezing of *Listeria monocytogenes* and other microorganisms: A review, *J. Food Prot.* 55: 639 (1992).
52. J. D. Fagan, T. R. Gormley, and M. M. Uí Mhuirheartaigh, Effect of modified atmosphere packaging with freeze-chilling on some quality parameters of raw whiting, mackerel and salmon portions, *Innovative Food Sci. Emerg. Technol.* 5: 205 (2004).
53. O. R. Fennema, Comparative water holding capacity of various muscle foods, *J. Muscle Food 1*: 363 (1990).
54. O. Fennema, Frozen foods: Challenges for the future, *Food Australia* 45: 374 (1993).
55. O. R. Fennema and W. D. Powrie, Fundamentals of low temperature food preservation, *Adv. Food Res.* 13: 220 (1964).
56. K. A. Fikiin and A. G. Fikiin, Predictive equations for thermophysical properties and enthalpy during cooling and freezing of food materials, *J. Food Eng.* 40: 1 (1999).
57. N. H. Fletcher, *The Chemical Physics of Ice*, Cambridge University Press, New York, 1970.
58. R. Foschino, C. Beretta, and G. Ottogalli, Study of optimal conditions in freezing and thawing for thermophilic lactic cultures, *Industria del Latte* 28: 49 (1992).
59. R. Foschino, E. Fiori, and A. Galli, Survival and residual activity of *Lactobacillus acidophilus* frozen cultures under different conditions, *J. Dairy Res.* 63: 295 (1996).
60. M. Fuchigami, Relationship between maceration and pectic change of Japanese radish roots during cooking, *J. Home Econ. Jpn.* 37: 1029 (1986).
61. M. Fuchigami, N. Hyakumoto, K. Miyazaki, T. Nomura, and J. Sasaki, Texture and histological structure of carrots frozen at a programmed rate and thawed in an electrostatic field, *J. Food Sci.* 59: 1162 (1994).
62. M. Fuchigami, N. Hyakumoto, and K. Miyazaki, Texture and pectic composition differences in raw, cooked, and frozen-thawed Chinese cabbages due to leaf position, *J. Food Sci.* 60: 153 (1995).
63. M. Fuchigami, K. Miyazaki, N. Hyakumoto, T. Nomura, and J. Sasaki, Chinese cabbage midribs and leaves physical changes as related to freeze-processing, *J. Food Sci.* 60(6): 1260 (1995).
64. M. Fuchigami, N. Hyakumoto, and K. Miyazaki, Programmed freezing affects texture, pectic composition and electron microscopic structures of carrots, *J. Food Sci.* 60: 137 (1995).

65. M. Fuchigami, K. Miyazaki, and N. Hyakumoto, Frozen carrots texture and pectic components as affected by low-temperature-blanching and quick freezing, *J. Food Sci.* 60: 132 (1995).
66. M. Fuchigami, K. Miyazaki, N. Kato, and A. Teramoto, Histological changes in high-pressure-frozen carrots, *J. Food Sci.* 62(4): 809–812 (1997).
67. M. Fuchigami and A. Teramoto, Structural and textural changes in kinu-tofu due to high-pressure-freezing, *J. Food Sci.* 62: 828 (1997).
68. Y. Fujita, T. Oshima, and C. Koizumi, Increase in the oxidative stability of sardine lipids through heat treatment, *Fish. Sci.* 60(3): 289 (1994).
69. R. M. George, Freezing processes used in the food industry, *Trends Food Sci. Technol.* 4: 134 (1993).
70. M. Gianfranceschi and P. Aureli, Freezing and frozen storage on the survival of *Listeria monocytogenes* in different foods, *Ital. J. Food Sci.* 8: 303 (1996).
71. M. C. Giannakourou and P. S. Taoukis, Application of TTI-based distribution as management system for quality optimization of frozen vegetables at the consumer end, *J. Food Sci.* 68: 201 (2003).
72. S. A. Goldblith, Food processing, nutrition and the feeding of man during the next 25 years, *Symposium of World Food Supply and Refrigeration*, Frigoscandia, Stockholm, 1975.
73. M. Goldman, B. Horev, and I. Saguy, Decolorization of beta-carotene in model systems simulating dehydrated foods. Mechanisms and kinetic principles, *J. Food Sci.* 48: 751 (1983).
74. F. Gomez and I. Sjoholm, Applying biochemical and physiological principles in the industrial freezing of vegetables: A case of study on carrots, *Trends Food Sci. Technol.* 15: 39 (2004).
75. E. Gould, Observations on the behaviors of some endogenous enzyme systems in frozen-stored fish flesh, *The Technology of Fish Utilization* (R. Kreuzer, ed.), Fishing News (Books) Ltd., London, 1965, p. 126.
76. E. Gould, An objective test for determining whether “fresh” fish have been frozen and thawed, *Fish Inspection and Quality Control* (R. Kreuzer, ed.), Fishing News (Books) Ltd., London, 1971, p. 72.
77. G. Graiver, N. E. Zaritzky, and A. N. Califano, Viscoelastic behavior of refrigerated and frozen low-moisture mozzarella cheese. *J. Food Sci.* 69: 123 (2004).
78. R. Gupta, Use of liquid nitrogen to freeze in the freshness, *Seafood Export J.* 24: 33 (1992).
79. R. J. Hamilton, The chemistry of rancidity in foods, *Rancidity in Foods* (J. C. Allen and R. J. Hamilton, eds.), Elsevier Applied Science, New York, 1989, p. 1.
80. R. Hamm and L. Kormendy, Transaminase of skeletal muscle. 3. Influence of freezing and thawing on the subcellular distribution of glutamic-oxalacetic transaminase in bovine and porcine muscle, *J. Food Sci.* 34: 452 (1969).
81. R. Hamm and D. Masic, Routinemethode zur unterscheidung zwischen frischer leber und aufgetauter gefrierleber, *Fleischwirtschaft* 55: 242 (1975).
82. R. S. Harris and E. Kramer, *Nutrition Evaluation of Food Processing*, 2nd edition, Avi Publishing Co., Westport, CT, 1975.
83. D. Heldman, Factors influencing food freezing rates, *Food Technol.* 37(4): 103 (1983).
84. H. M. Henderson, J. Kanhai, and N. A. M. Eskin, The enzymic release of fatty acids from phosphatidylcholine in green peas (*Pisum sativum*), *Food Chem.* 13: 129 (1983).
85. S. Y. Ho, A turbulent conjugate heat transfer model for freezing food products, *J. Food Sci.* 69: E224 (2004).
86. P. V. Hobbs, *Ice Physics*, Oxford University Press, London, 1974.
87. A. S. Hodgson and L. R. Hodgson, Pineapple juice, *Fruit Juice Processing Technology* (S. Nagy, C. S. Chen, and P. E. Shaw, eds.), AgScience, Inc., Auburndale, 1993, p. 378.
88. Y. C. Hung and N. K. Kim, Fundamental aspects of freeze-cracking, *Food Technol.* 50: 59 (1996).
89. R. Hurling and H. McArthur, Thawing, refreezing and frozen storage effects on muscle functionality and sensory attributes of frozen cod (*Gadus morhua*), *J. Food Sci.* 61: 1289 (1996).
90. C. C. Huxsoll, Reducing the refrigeration load by partial concentration of foods prior to freezing, *Food Technol.* 35: 98 (1982).
91. K. T. Hwang and J. M. Regenstien, Lipid hydrolysis and oxidation of mackerel (*Scomber scombrus*) mince, *J. Aquatic Food Product Technol.* 5: 17 (1996).
92. Y. Inoue and W. Bushuk, Effects of freezing, frozen storage, and thawing on dough and baked goods, *Freezing Effects on Food Quality* (L. E. Jeremiah, ed.), Marcel Dekker, New York, 1996, p. 367.
93. M. Jadhav and N. Magar, Preservation of fish by freezing and glazing. II. Keeping quality of fish with particular reference to yellow discoloration and other organoleptic changes during prolonged storage, *Fish Technol.* 7: 146 (1970).

94. P. P. Jantawat and L. E. Dawson, Stability of broiler pieces during frozen storage, *Poultry Sci.* 56: 2026 (1977).
95. M. A. Joslyn, *Cryobiology*, 9th edition, Academic Press, London, 1966.
96. M. Jul, *The Quality of Frozen Foods*, Academic Press, London, 1984.
97. M. T. Kalichevsky, D. Knorr, and P. J. Lillford, Potential food applications of high-pressure effects on ice-water transitions, *Trends Food Sci. Technol.* 6: 253 (1995).
98. Y. Kanda, M. Aoki, and T. Kosugi, Freezing of tofu (soybean curd) by pressure-shift freezing and its structure, *J. Jap. Soc. Food Sci. Tech.* 39(7): 608 (1992).
99. K. Kaneko, K. Hashizume, Y. Ozawa, and R. Masuda, Change in quality of strawberries by freezing and freeze storage, *Rep. Natl. Food Res. Inst.* 52: 18 (1988).
100. K. M. K. Kebary, Viability of *Bifidobacterium bifidum* and its effect on quality of frozen Zabady, *Food Res. Int.* 29: 431 (1996).
101. T. R. Kelly, Quality in frozen cod and limiting factors on its shelf life, *J. Food Technol.* 4: 95 (1965).
102. A. A. Khan and J. F. V. Vincent, Mechanical damage induced by controlled freezing in apple and potato, *J. Text. Stud.* 27: 143 (1996).
103. A. Khayat and D. Schwall, Lipid oxidation in seafood, *Food Technol.* 37(7): 130 (1983).
104. J. Kijowski and R. I. Richardson, The effect of cryoprotectants during freezing or freeze drying upon properties of washed mechanically recovered broiler meat, *Int. J. Food Sci. Technol.* 31: 45 (1996).
105. N. K. Kim, Mathematical modeling of cryogenic food freezing, Ph.D. Dissertation, Univ. of Georgia, Athens, 1993.
106. N. K. Kim and Y. C. Hung, Freeze-cracking in foods as affected by physical properties, *J. Food Sci.* 59: 669 (1994).
107. C. Korber, K. Wollhover, and M. W. Scheiwe, The freezing of biological cells in aqueous solutions containing a polymeric cryo-protectant, *Properties of Water in Foods* (D. Simatos and J. L. Multon, eds.), Martinus Nijhoff Publishers, Dordrecht, 1985, p. 511.
108. L. Kormendy, G. Gantner, and R. Hamm, Isozyme der glutamat-oxalacetat transaminase im skelettmuskel von schwein und rind, *Biochem. Z.* 342: 31 (1965).
109. Z. Kosmala, M. A. Urbaniak, and G. A. Rydz, Some chemical and sensory properties of green peas and French beans frozen without blanching and stored in a frozen state, *The XVI International Congress of Refrigeration*, 1983, p. 623.
110. W. Kmiecik, Z. Lisiewska, and J. Slupski, Effects of freezing and storing of frozen products on the content of nitrates, nitrites, and oxalates in dill (*Anethum graveolens* L.), *Food Chem.* 86: 105 (2003).
111. A. Kramer, Effects of freezing and frozen storage on nutrient retention of fruits and vegetables, *Food Technol.* 33: 58 (1979).
112. A. Kramer and J. W. Farquhr, Testing of time-temperature indicating and defrost devices, *Food Technol.* 30: 50 (1976).
113. T. P. Labuza, Drying food: technology improves on the sun, *Food Technol.* 30: 34 (1976).
114. E. L. Leblanc and R. J. Leblanc, Effect of frozen storage temperature on free and bound formaldehyde content of cod (*Gadus morhua*) fillets, *J. Food Process. Preserv.* 12: 95 (1988).
115. C. M. Lee, Surimi process technology, *Food Technol.* 38: 69 (1984).
116. C. Y. Lee, M. C. Bourne, and J. P. Van Buren, Effect of blanching treatment on the firmness of carrots, *J. Food Sci.* 44: 615 (1979).
117. J. J. Licciardello, E. M. Ravesi, R. C. Lundstrom, K. A. Wilhelm, F. F. Correia, and M. G. Allsup, Time-temperature tolerance of frozen red hake, *J. Food Quality* 5: 215 (1982).
118. J. Li and T. Lee, Bacterial ice nucleation and its potential application in the food industry, *Trends Food Sci. Technol.* 6: 259 (1995).
119. B. Li and D.-W. Sun, Novel methods for rapid freezing and thawing of foods: A review, *J. Food Eng.* 54: 175 (2002).
120. B. Li and D.-W. Sun, Effect of power ultrasound on freezing rate during immersion freezing of potato, *J. Food Eng.* 55: 277 (2002).
121. P. J. Lillford and C. B. Holt, Antifreeze proteins, *J. Food Eng.* 22: 475 (1994).
122. G. Londahl and B. Karlsson, *Food Technol. Int. Eur.* 90–91 (1991).
123. M. Lopez-Leiva and B. Hallstrom, The original Plank equation and its use in the development of food freezing rate predictions, *J. Food Eng.* 58: 267 (2003).

124. K. Lorenz and W. C. Bechtel, Frozen dough variety breads: Effect of bromate level on white bread, *Bakers Dig.* 39(4): 53 (1965).
125. R. M. Love and M. A. Haq, The connective tissues of fish. IV. Gaping of cod muscle under various conditions of freezing, cold-storage and thawing, *J. Food Technol.* 5: 249 (1970).
126. T. Lucas and A. L. Raoult-Wack, Immersion chilling and freezing: Phase change and mass transfer in model food, *J. Food Sci.* 61: 127 (1996).
127. H. Luck, Preservation of cheese and perishable dairy products by freezing, *S. Afr. J. Dairy Technol.* 9: 127 (1977).
128. G. A. MacDonald and T. Lanier, Carbohydrates as cryoprotectants for meats and surimi, *Food Technol.* 45: 150 (1991).
129. A. Maestrelli, R. Lo Scalzo, D. Lupi, G. Bertolo, and D. Torregiani, Partial removal of water before freezing: Cultivar and pre-treatments as quality factors of frozen muskmelons (*Cucumis melo*, cv reticulatus Naud.), *J. Food Eng.* 49: 255 (2001).
130. A. Maestrelli, R. Lo Scalzo, G. L. Rotino, N. Acciarri, A. Spena, G. Vitelli, and G. Bertolo, Freezing effect of transgenic parthenocarpic eggplants, *J. Food Eng.* 56: 285 (2003).
131. R. W. Mandigo and W. N. Osburn, Cured and processed meats, *Freezing Effects on Food Quality* (L. E. Jeremiah, ed.), Marcel Dekker, New York, 1996, p. 135.
132. J. D. Mannapperuma and P. Singh, A computer-aided method for the prediction of properties and freezing/thawing times in foods, *J. Food Eng.* 9: 275 (1989).
133. S. J. Mashl, R. A. Flores, and R. Trivedi, Dynamics of solidification in 2% corn starch-water mixtures: Effect of variations in freezing rate on product homogeneity, *J. Food Sci.* 61: 760 (1996).
134. R. C. Martins and C. L. M. Silva, Inverse problem methodology for thermal-physical properties estimation of frozen green peas, *J. Food Eng.* 63: 383 (2004).
135. R. C. Martins and C. L. M. Silva, Frozen green beans (*Phaseolus vulgaris*, L.) quality profile evaluation during home storage, *J. Food Eng.* 64: 481 (2004).
136. R. H. Mascheroni and A. Calvelo, A simplified model to freezing time calculations in foods, *J. Food Sci.* 47: 1201 (1982).
137. R. Masuda, K. Kaneko, K. Hashizume, Y. Ozawa, K. Iono, and I. Yamashita, Effects of freezing method and the following storage condition of strawberries on the quality of jam and juice drink, *Rep. Natl. Food Res. Inst.* 52: 25 (1988).
138. P. Mazur, Physical and temporal factors involved in the death of yeast at sub-zero temperatures, *Biophys. J.* 1: 247 (1963).
139. P. Mazur, The role of intracellular freezing in the death of cells cooled at superoptimal rates, *Cryobiology* 14: 251 (1977).
140. C. A. Miles and M. J. Morley, Measurement of internal pressures and tensions in meat during freezing, frozen storage and thawing, *J. Food Technol.* 12: 387 (1977).
141. A. Mizuno, M. Mitsuiki, S. Toba, and M. Motoki, Antifreeze activities of various food components, *J. Agric. Food Chem.* 45: 14 (1997).
142. Y. G. Moharram and S. D. Rofael, Shelf life of frozen vegetables, *Shelf Life Studies of Foods and Beverages* (G. Charalambous, ed.), Elsevier Science Publishers B. V., Amsterdam, 1993.
143. H. Morais, P. Rodrigues, C. Ramos, V. Almeida, E. Forgács, T. Cserháti, and J. S. Oliveira, Note. Effect of blanching and frozen storage on the stability of  $\beta$ -carotene and capsanthin in red pepper (*Capsicum annuum*) fruit, *Food Sci. Tech. Int.* 8: 55 (2002).
144. A. S. Navarro, M. N. Martino, and N. E. Zartitzky, Effect of freezing rate on the rheological behaviour of systems based on starch and lipid phase, *J. Food Eng.* 26: 481 (1995).
145. O. Neyreneuf and J. B. Van Der Plaat, Preparation of frozen French bread dough with improved stability, *Cereal Chem.* 68: 60 (1991).
146. O. Neyreneuf and B. Delpuech, Freezing experiments on yeasted dough slabs. Effects of cryogenic temperatures on the baking performance, *Cereal Chem.* 70: 109 (1993).
147. K. Nilsson and B. Ekstrand, Enzyme leakage in muscle tissue of rainbow trout (*Onchorynchus mykiss*) related to various thawing treatments, *Z. Lebs. Unters. Forsch.* 198: 253 (1994).
148. Y. Oda, K. Uno, and S. Otha, Selection of yeasts for bread making by the frozen dough method, *Appl. Environ. Microbiol.* 52: 941 (1986).
149. A. O. Olorunda and M. A. Tung, Rheology of fresh and frozen okra dispersions, *J. Food Technol.* 12: 593 (1977).

150. M. E. Paredi, N. A. De Vido de Mattio, and M. Crupkin, Biochemical properties of actomysin and expressible moisture of frozen stored striated adductor muscles of *Aulacomya ater ater* (molina): Effects of polyphosphates, *J. Agric. Food Chem.* 44: 3108 (1996).
151. J. W. Park, T. C. Lanier, and D. P. Green, Cryoprotective effects of sugar, polyols and/or phosphates on Alaska pollack surimi, *J. Food Sci.* 53: 1 (1988).
152. S. Park, M. S. Brewer, F. K. McKeith, P. J. Bechtel, and J. Novakofski, Salt, cryoprotectants and pre-heating temperature effects on surimi-like material from beef or pork, *J. Food Sci.* 61: 790 (1996).
153. H. B. W. Patterson, Safeguarding quality and yield, *Handling and Storage of Oilseeds, Oils, Fats, and Meal*, Elsevier Applied Science, New York, 1989, p. 1.
154. A. C. Peterson, *Proceeding Low Temperature Microbiological Symposium*, Campbell Soup Co., Campden, NJ, 1961.
155. Q. T. Pham, Prediction of calorimetric properties and freezing time of foods from composition data, *J. Food Eng.* 30: 95 (1996).
156. J. Pikul, D. E. Lesczynski, P. J. Bechtel, and F. A. Kummerow, Effects of frozen storage and cooking on lipid oxidation in chicken meat, *J. Food Sci.* 49: 838 (1984).
157. D. Piotrowski, A. Lenart, and A. Wardzynski, Influence of osmotic dehydration on microwave-convective drying of frozen strawberries, *J. Food Eng.* 65: 519 (2004).
158. F. Pizzocaro, E. Senesi, and R. Monteverdi, Stability of lipids in frozen cauliflower in relation to heat pretreatment, *Ind. Alimentari* 25: 372 (1986).
159. K. Porsdal and F. Lindelov, Acceleration of chemical reactions due to freezing, *Water Activity: Influences on Food Quality* (L. B. Rockland and G. F. Stewart, eds.), Academic Press, New York, 1981.
160. A. Quintero-Ramos, M. C. Bourne, and A. Anzaldúa-Morales, Texture and rehydration of dehydrated carrots as affected by low temperature blanching, *J. Food Sci.* 57: 1127 (1992).
161. M. S. Rahman and C. O. Perera, Osmotic dehydration: a pretreatment for fruit and vegetables to improve quality and process efficiency, *The Food Technologist* 25: 144 (1996).
162. A. R. Rahman, W. L. Henning, and D. E. Wescott, Histological and freeze drying and compression, *J. Food Sci.* 36: 500 (1971).
163. A. L. Raoult-Wack, Recent advances in the osmotic dehydration of foods, *Trends Food Sci. Technol.* 5: 255 (1994).
164. G. A. Redmond, A. M. Decazes, T. R. Gromley, and F. Butler, The vitamin C status of freeze-chilled potato, *J. Food Eng.* 56: 219 (2003).
165. R. M. Reeve and M. S. Brown, Historical development of the green bean pod as related to culinary texture. 2. Structure and composition at edible maturity, *J. Food Sci.* 33: 326 (1968).
166. H. Rehbein, Does formaldehyde from cross-links between myofibrillar proteins during frozen storage of fish muscle? *Fish Inspection and Quality* (R. Kreuzer, ed.), Fishing News, Surrey, 1971.
167. D. S. Reid, Fruit freezing, *Processing Fruits: Science and Technology. Vol. 1. Biology, Principles and Applications* (L. P. Somogyi, H. S. Ramaswamy, and Y. H. Hui, eds.), Technomic Publishing, Lancaster, CA, 1996, p. 169.
168. D. S. Reid, N. F. Doong, A. Foin, and M. Snider, Studies on the frozen storage of fish, *Refrigeration Science and Technology. Storage Lives of Chilled and Frozen Fish Products*, International Institute of Refrigeration, Paris, 1985.
169. S. D. Rofael, Effect of storage time, food processing plants and marketing conditions on the quality of some frozen vegetables, Ph.D. Thesis, Alex University Alexandria, Egypt, 1992.
170. G. Rotllant, F. Arnau, J. A. García, N. García, M. Rodriguez, and F. Sarda, Note. Effect of metaspulphite treatments and freezing on melanosis inhibition in rose shrimp *Aristeus antennatus* (Risso, 1816), *Food Sci. Tech. Int.* 8: 243 (2002).
171. V. O. Salvadori and R. H. Mascheroni, Prediction of freezing and thawing times of foods by means of a simplified analytical method, *J. Food Eng.* 13: 67 (1991).
172. B. Salvage, *Frozen Food Rep.* 3: 28–33 (1992).
173. E. E. M. Santos-Yap, Fish and seafood, *Freezing Effects on Food Quality* (L. E. Jeremiah, ed.), Marcel Dekker, New York, 1996, p. 109.
174. S. Schwimmer, Enzyme involvement in off-flavor from the oxidation of unsaturated lipids in nondairy foods, *Source Book of Food Enzymology*, AVI Publishing, Westport, CT, 1981, p. 421.
175. A. Sebok, I. Csepregi, and G. Beke, Cracking of fruits and vegetables during freezing and the influence of precooling, *International Congress of Refrigeration*, Montreal, Canada, Aug. 10–17, 1991.

176. J. G. Sebranek, *Poultry and Poultry Products, Freezing Effects on Food Quality* (L. E. Jeremiah, ed.), Marcel Dekker, 1996, p. 85.
177. Z. Sham and M. Marpaung, The application of liquid nitrogen in individual quick freezing and chilling, *Development of Food Science and Technology in South East Asia* (O. B. Liang, A. Buchanan, and D. Fardiaz, eds.), IPB Press, Bogor, 1993, p. 80.
178. R. L. Shewfelt, M. C. Erickson, Y. C. Hung, and T. M. M. Malundo, Applying quality concepts in frozen food development, *Food Technol.* 51: 56 (1997).
179. V. Simandjuntak, D. M. Barrett, and R. E. Wrolstad, Cultivar and frozen storage effects on muskmelon (*Cucumis melo*) colour, texture and cell wall polysaccharide composition, *J. Sci. Food Agric.* 71: 291 (1996).
180. K. L. Simpson, Chemical changes in natural food pigments, *Chemical Changes in Food during Processing* (T. Richardson and J. W. Finley, ed.), The AVI Publishing Co., Inc., Westport, 1985, p. 409.
181. G. Skrede, Fruits, *Freezing Effects on Food Quality* (L. E. Jeremiah, ed.), Marcel Dekker, New York, 1996, p. 183.
182. B. M. Slabyj and H. O. Hultin, Lipid peroxidation by microsomal fractions isolation from light and dark muscle of herring (*Clupea harengus*), *J. Food Sci.* 47: 1395 (1982).
183. A. Sormani, D. Maffi, G. Bertolo, and D. Torreggiani, Texture and structural changes of dehydrofrozen-thawed strawberry slices: Effects of different dehydration pretreatments, *Food Sci. Tech. Int.* 5: 479 (1999).
184. D. F. Splittstoesser and W. P. Wettergreen, The significance of coliforms in frozen vegetables, *Food Technol.* 18: 134 (1964).
185. S. Srinivasan, Y. L. Xiong, and E. A. Decker, Inhibition of protein and lipid oxidation in beef heart surimi by antioxidants or a combination of pH, NaCl, and buffer type in the washing media. *J. Agric. Food Chem.* 44: 119 (1996).
186. D. W. Sun and B. Li, Microstructural change of potato tissues frozen by ultrasound-assisted immersion freezing, *J. Food Eng.* 57: 337 (2003).
187. H. Symons, Frozen foods, *Shelf Life Evaluation of Foods* (C. M. D. Man and A. A. Jones, eds.), Blackie Academic & Professional, London, 1994, p. 298.
188. S. Tamura, Effects of pretreatment on firmness, morphological structure and loss of a taste substance of frozen carrot, *J. ARAHE 1*: 61 (1991).
189. P. S. Taoukis, B. Fu, and T. P. Labuza, Time-temperature indicators, *Food Technol.* 44: 70 (1991).
190. N. E. Tolbert and R. H. Hurris, Light activation of the plant enzyme which oxidizes glycolic acid, *J. Biol. Chem.* 186: 791 (1950).
191. D. Torreggiani, Osmotic dehydration in fruit and vegetable processing, *Food Res. Int.* 26: 59 (1993).
192. Y. Ueda and T. Iwata, Off-odor of strawberry by freezing, *J. Jap. Soc. Hort. Sci.* 51: 219 (1982).
193. I. Undeland, B. Ekstrand, and H. Lingnert, Lipid oxidation in minced herring (*Clupea harengus*) during frozen storage. Effect of washing and precooking, *J. Agric. Food Chem.* 46: 2319 (1998).
194. I. Undeland, M. Stading, and H. Lingnert, Influence of skinning on lipid oxidation in different horizontal layers of herring (*Clupea harengus*) during frozen storage, *J. Sci. Food Agric.* 78: 441 (1998).
195. J. F. Velez-Ruiz and A. L. Soriano-Morales, Evaluation of physical properties using a computer program, *Información Tecnológica 14*: 23 (2003).
196. J. F. Velez Ruiz, Notes of Food Engineering II, Unpublished document (2004).
197. A. J. Virtanen, D. L. Goedeken, and C. H. Tong, Microwave assisted thawing of model frozen food using feed/back temperature control and surface cooling, *J. Food Sci.* 62: 150 (1997).
198. L. Wan, Y. L. Xiong, and E. A. Decker, Inhibition of oxidation during washing improves the functionality of bovine cardiac myofibrillar protein, *J. Agric. Food Chem.* 41: 2267 (1993).
199. B. Wang, Y. L. Xiong, and S. Srinivasan, Chemical stability of antioxidant-washed beef heart surimi during frozen storage, *J. Food Sci.* 62(5): 939 (1997).
200. Y. J. Wang, L. A. Miller, and P. B. Addis, Effect of heat inactivation of lipoxygenase on lipid oxidation in lake herring (*Coregonus artedii*), *J. Am. Oil Chem. Soc.* 68(10): 752 (1991).
201. M. Watanabe and S. Arai, Bacterial ice-nucleation activity and its application to freeze concentration of fresh foods for modification of their properties, *J. Food Eng.* 22: 453 (1994).
202. J. E. Webb, C. C. Brunson, and J. D. Yates, Effects of feeding antioxidants on rancidity development in pre-cooked, frozen broiler parts, *Poultry Sci.* 51: 1601 (1972).
203. J. H. Wells and R. P. Singh, Performance evaluation of time-temperature indicators for frozen food transport, *J. Food Sci.* 50(2): 369 (1985).

204. J. H. Wells and R. P. Singh, Response characteristics of full-history time-temperature indicators suitable for perishable food handling, *J. Food Process. Preserv.* 12: 207 (1988).
205. F. Wheaton and A. Lawson, *Processing Aquatic Food Products*, Wiley, New York, 1985.
206. E. Wierbicki, L. E. Kunkle, and F. E. Deatherage, Changes in the water holding capacity and cationic shifts during the heating and freezing and thawing of meat as revealed by a simple centrifugal method for measuring shrinkage, *Food Technol.* 11: 69 (1957).
207. P. K. Wolber, Bacterial ice nucleation, *Adv. Microbial Physiol.* 34: 203 (1993).
208. J. Wolfe, Z. J. Yan, and J. M. Pope, Hydration forces and membrane stresses- cryobiological implications and a new technique for measurement, *Biophys. Chem.* 49: 51 (1994).
209. E. R. Wolford and M. S. Brown, Liquid-nitrogen freezing of green beans, *Food Technol.* 19: 1133 (1965).
210. Y. L. Xiong, E. A. Decker, G. H. Robe, and W. G. Moody, Gelation of crude myofibrillar protein isolated from beef heart under antioxidative conditions, *J. Food Sci.* 58: 1241 (1993).
211. S. Zhu, A. Le Bail, H. S. Ramaswamy, and N. Chapleau, Characterization of ice crystals in pork muscle formed by pressure-shift freezing as compared with classical freezing methods, *J. Food Sci.* 69: 190 (2004).





## *Freezing–Melting Process in Liquid Food Concentration*

Mohammad Shafiur Rahman, Mushtaque Ahmed, and Xiao Dong Chen

### CONTENTS

27.1	Introduction .....	667
27.2	State of the Art in Freezing–Melting Process .....	668
27.2.1	General Description .....	668
27.2.2	Historical Development .....	668
27.2.3	Classification of Freezing–Melting Process .....	669
27.2.3.1	Direct-Contact Freezing .....	669
27.2.3.2	Indirect-Contact Freezers .....	677
27.2.3.3	Comparison between Direct and Indirect Freezing–Melting Processes.....	681
27.2.3.4	Vacuum Freezing .....	683
27.3	Applications in Food Industry.....	685
	Acknowledgment.....	686
	References .....	686

### 27.1 Introduction

The general claim of the freezing–melting (FM) process is essentially that it is capable of removing water by freezing it out from a solution as ice crystals. Ideally, the ice formed should be free of solutes. First, the solution is partially frozen, the ice crystals are physically separated from the residual solution (concentrated solution), and the ice is melted to form the product water. Ice crystals formed under the appropriate conditions can be very pure. The FM process or freeze–concentration (FC) has the following potential advantage: the very low energy requirement compared to that of distillation processes [21,65]. The reduction in energy costs results as the latent heat of fusion of ice is only one-seventh the latent heat of vaporization of water. FM separation could save 75%–90% of the energy required by conventional thermal processes [54]. The costs of concentration by evaporation and FM are listed in Table 27.1. FM processes have the advantage of a low operating temperature, which minimizes scaling and corrosion problems [1,21,50]. Inexpensive plastics or low-cost materials can be used at low temperature [1,63,64]. In case of liquid foods, the other advantages are less thermal damage of the components, avoidance of off-flavor development, and minimal loss of volatile components. A very high surface area and high heat transfer coefficient can be achieved by facilitating direct contact between the brine and refrigerant. It requires little or no pretreatment, has low chemicals requirements and is insensitive to fouling and nature of solution [64,101], and low ecological impact.

Traditionally, the disadvantages of FM process compared with evaporation and reverse osmosis have included higher capital and operating costs during the ice separation [84]. Other disadvantages are [133]: (i) in case of desalination, retention of undesirable flavors and aromas (initially present in the feed saline water) that may come into the produced fresh water (18), (ii) the freezing process should include the

TABLE 27.1

Comparison of Operating Costs of Various Concentration Processes

Application	Cost Per 1000 kg Water Removed (\$)	
	Evaporation	Freezing–Melting
Fruit juice concentration	5.40	1.98
Sugar production	8.47	1.32
Desalting seawater	1.85 <sup>a</sup>	0.93
Caustic soda concentration	2.23	1.06
Black liquor concentration (for paper-pulp processing)	3.15	1.52

<sup>a</sup>Now it is \$0.84 in new plants in UAE.

Source: Chen, P. 1999. Ph.D. thesis, University of Auckland, New Zealand.

growing, handling, and washing steps for ice crystals in case of desalination, and the need for mechanical vapor compressors; (iii) compressors represent an expensive method of furnishing the energy requirements of the system [21]; (iv) probably the greatest deterrent to general acceptance of the freezing process is the fact that large plants cannot be designed and optimized with confidence, owing to the complexity of the unit operations in the freezing unit, melting unit, and wash-separation column; (v) in case of desalination, the trapping of salt solution in the ice during crystallization involves crushing and recrystallization of ice; (vi) a progressive increase in the concentrations of the dissolved substance and noncondensable gases; (vii) high-quality energy is required for crystallization compared to low-quality energy used in many evaporation processes; in case of desalination, a certain amount of fresh water is required to wash ice for reducing salt content in the product water; and limited knowledge of ice crystallization and growth in a slurry system, practicalities of handling ice slurries, good methods for complete separation of ice from brine, and hydration behavior. At present, no commercial FM plant is available for the desalination of seawater [129].

## 27.2 State of the Art in Freezing–Melting Process

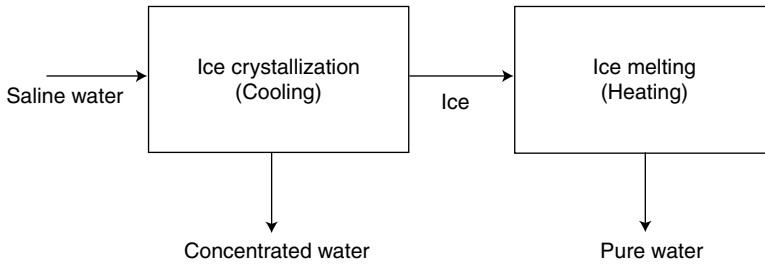
### 27.2.1 General Description

A refrigeration system is required to remove the heat of fusion of the ice from the solution. The quantity of heat, which must be removed from the freezing unit, is essentially equal to that which must be added to the melting unit [21,63]. The FM process is accomplished in two major stages: ice crystallization (stage I), and separation and melting (stage II) (Figure 27.1). In stage I, nucleation occurs at a suitable supercooling temperature. The nuclei in solution grow to become large ice crystals in a crystallizing unit. In stage II, the crystals are separated from the concentrate by a separator (mechanical) and then melted to produce pure water.

In general, the components of FM process are (i) pre-cooler to cool the feed solution; (ii) a crystallizing unit, where sufficient heat is removed from the process fluid to crystallize up to 15% of the mass; and (iii) a *crystal separator and purifier*, where the crystal is separated from the unfrozen concentrate and washed with a few percentage of the melted product to remove any adhering concentrate from the surface of the crystal. The separated concentrate is recycled to the freezer to provide for any desired recovery. A *heat pump* takes heat out of the freezer and transfers it either to the cooling water or to the melted crystal (melting-unit) that is removed from the purification section. A *feed heat exchanger* usually employed to pre-cool the feed by using the cold product and the concentrate reduces the load on the freezer.

### 27.2.2 Historical Development

The Danish physician Thomas Bartholinus (1616–1680) was apparently the first to report that water obtained by the melting of ice formed in seawater was fresh. Almost at the same time, Robert Boyle (1627–1691) reported the same observation, foreseeing the phenomenon as a source of fresh water, and the Jesuit Athanasios Kircher (1602–1680) discussed the reason why ice formed in the sea is fresh [86].



**FIGURE 27.1** Freezing–melting process.

The reason behind getting fresh water from ice is due to the rejection of salts at the interface. Freezing in large bodies of water occurs in nature on the surface of oceans, lakes, and bays. The combined heat transfer associated with heat removal by the environment, and latent heat release at the water–ice interface results in natural convection flows of water. Freezing seawater releases fluid at the water–ice interface, which is denser than the ambient water. The resulting solute buoyancy force therefore acts downward. This solute buoyancy force is in addition to the thermal buoyancy force. Flow visualization revealed that the flow was downward, below the freezing surface. Also, convection heat transfer rate was strongly affected by solute rejection upon freezing [20]. At the end of the eighteenth century, the Italian scientist Anton Maria Lorgna (1735–1796) described a method to purify seawater and impure waters by freezing and then the melting of ice. In 1786 Lorgna published his first paper on water desalination by freezing, wondering why nobody had previously applied it in an artificial process initiating what nature does so well and easily in the cold seas; producing blocks of fresh water ice from seawater. He also identified that a single freezing of seawater produced an ice block having salinity, although much less than that of seawater, thus there was a need for multistage FM process [86].

The method of water purification by FM was not of practical interest before the development of refrigerating machines. It was only possible in the coldest regions and seasons. The interest in the process for obtaining fresh water from seawater by freezing was revived in the late 1930s, and an experimental desalting plant had been operated for some years near Rome by the Istituto Superiore di Sanita. The plants operated by the indirect freezing process later revealed themselves to be of limited practical interest in comparison with direct freezing desalination procedures. FM process was first used commercially in the 1950s. Research in the 1960s and 1970s for desalination, petroleum, and food processing applications provided many technical innovations [97].

### 27.2.3 Classification of Freezing–Melting Process

A wide variety of FM systems are currently on the market [29]. Further details of the different types are available in Ettouney et al. [41], Heist [54], Deshpande et al. [36], Maguire [76], UNEP [124], Thampy et al. [117], Singh and Tembrock [109], Hassan et al. [52], and Chowdhury [29]. Hanafi [49] identified different possible desalination techniques in association with wind, tidal, and solar energy sources. In general, FM process occurs in a crystallizer, although control of ice formation and growth has been obtained in numerous ways. A classification of the FM process is given in Table 27.2 based on whether there is direct or indirect contact of the refrigerant with the solution.

#### 27.2.3.1 Direct-Contact Freezing

Direct-contact crystallizers provide for intimate mixing between the refrigerant (such as Freon and butane) and the product to be frozen. The refrigerant (in the liquid form and maintained under pressure) is expanded through a nozzle into the product liquid, where it vaporizes at lower pressure. This vaporization provides a refrigeration effect and causes the formation of ice and solutes crystals within the product. A typical direct FM system (shown in Figure 27.2) is composed of an ice nucleation unit, a crystallizer allowing subsequent growth of these nuclei up to a size suitable for separation, an ice crystal separator, a washing unit, and a melting unit [50,57].

### 27.2.3.1.1 Conventional Direct-Contact Freezing

Direct-contact freezer use spray of refrigerant by jet impact through a nozzle. The main advantages of this method are a high production rate per unit volume at a low driving force, power consumption is small, absence of moving parts, and the unit is compact and efficient [44]. The successful design of a direct-contact freeze desalination plant significantly depends upon the availability of a suitable refrigerant [10,11]. There are certain thermodynamic, chemical, physical, and economic requirements, which the refrigerant must meet to be suitable for use in the process. These are (i) the refrigerant should have a normal boiling point of  $-4^{\circ}\text{C}$  or less and have a vapor pressure below  $2.8 \times 10^5$  Pa at room temperature; (ii) the refrigerant should be nontoxic, preferably nonflammable and chemically stable in solution; (iii) the fluid should be virtually immiscible with water and possess such molecular size factors so as to not form a hydrate under the freezing conditions employed in the process; and (iv) the refrigerant should be cheap and readily available from commercial suppliers [112]. The refrigerants that could be used are butane, carbon dioxide, nitrous oxide, Freon-114, and Freon-318. The details of thermodynamic properties of normal butane at refrigeration temperatures are compiled by Kurnik and Barduhn [68]. Freon-114 and Freon-318 are a better choice based on the above factors; however, these materials are relatively expensive when compared to other refrigerants such as butane. Antonelli [3] developed a process wherein liquefied natural gas (LNG) evaporates and generates power, part of the seawater is frozen and the ice produced is melted at ambient temperature. It is possible to couple an FM process to an LNG vaporizer [101]. In many cases, gas companies import huge quantities of LNG, which is vaporized from low temperature to the ambient temperature at the terminals, and then transported through gas pipelines. In this case, seawater could be used as a source of heat for vaporization of LNG. The cost would be substantially reduced if seawater could be cooled from the ambient to near freezing.

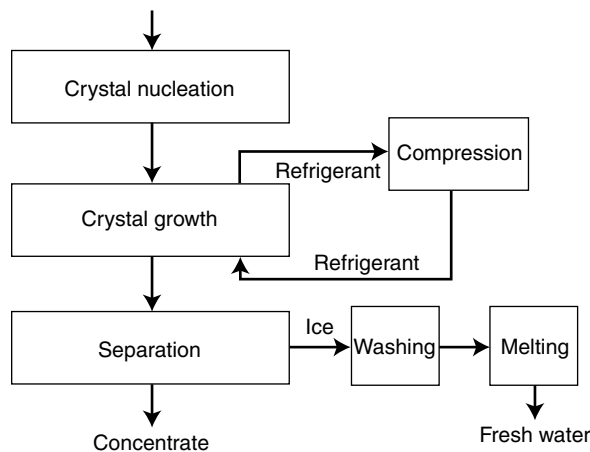
Butane evaporation involves at least three phases—butane liquid, butane vapor, and liquid brine—and its mechanism is correspondingly complex. Simpson et al. [108] studied the evaporation process of refrigerant by describing the dynamics of the bubble motion in a more meaningful way,

**TABLE 27.2**

Possible Classification of the Freezing–Melting Process

- |    |   |
|----|---|
| A. | Direct Contact Freezing                     |
| B. | Indirect Contact Freezing                   |
| a. | Internally cooled                           |
| 1. | Static layer growth system                  |
| 2. | Layer crystallization unit on rotating drum |
| 3. | Progressive crystallization unit            |
| 4. | Dynamic layer growth system                 |
| 5. | Suspension crystallization                  |
| b. | Externally cooled                           |
| 1. | Supercooled feed                            |
| 2. | Ripening vessels                            |
| C. | Vacuum freezing                             |

Source: Buros, O. K. 2001. *The ABCs of Desalting*, Second Edition. International Desalination Association, MA.



**FIGURE 27.2** Schematic of basic Direct Contact FM process. (From Hartel, R. W. 1992. In: *Handbook of Food Engineering*. Marcel Dekker, New York, pp. 341–392.)

and recorded this more readily with the visual evidence of the bubble's motion. It was found that the rate of evaporation of butane droplets increased rapidly with a diameter ratio compared with the initial one, up to a critical value, and then gradually with the 1/6 power, implying that evaporation was controlled by the heat transfer through the transient liquid butane film on the inside surface of the bubble [108].

Orcutt and Hale [88] used mathematical models to study the operational-design economics of a freezing process and predict the best operating conditions. Optimization computations showed that the economics of process operation depend largely on the temperature maintained in the freezer and the overall difference in the refrigerant and equilibrium freezing temperature. An analysis of the linearized freezer dynamic equations showed the freezer to be stable and did not indicate regions of difficult control. The cost of the washer–melter is influenced by the operation of the freezer, which determines the value of the crystal size. The freezer operating costs depend on the brine temperature, which influences both the crystal size and the refrigerant vaporization rate.

The choice of a suitable refrigerant for the process is important. From the viewpoint of cost and stability, hydrocarbons with four carbon atoms have been recommended. When *n*-butane is used, the operation is to be carried out carefully because it is at a vapor pressure lower than the atmospheric pressure, while *i*-butane has a considerably higher vapor pressure than atmospheric pressure and can form solid hydrate in contact with aqueous phase under specific conditions. Formation of hydrates results in the elimination of the ice crystals formed. The mixture with less than 73.8% *i*-butane cannot form a hydrate at  $-0.7^{\circ}\text{C}$  with 1.6% NaCl aqueous solution, and this limiting ratio increases with increasing temperature [123].

**27.2.3.1.1.1 Ice-Crystallization Unit** Direct FM process could be of either continuous or batch type. Energy recovery is one of the important aspects of the process. Butane FM process employs butane as the immiscible refrigerant (Figure 27.3). The refrigerant in the liquid form under pressure is expanded through a nozzle into the product liquid, where it boils at lower pressure. The vaporization of butane in the freezer removes heat from the brine, causing a portion of it to freeze as tiny ice crystals (Figure 27.4). Another option is to use high vacuum to vaporize a portion of the water, which then provides the refrigeration effect for lowering the temperature of the product and causing ice crystallization to occur. This process is able to reduce the residence time in the crystallization unit by at least half compared to flash freezing [10]. These types of processes are mainly utilized for the concentration of chemicals and sea-water desalination [21,69]. It is rarely used in the food industry for a number of reasons. The major reason for not using direct-contact freezers in food concentration is that a vapor–liquid interface is created, resulting in subsequent loss of volatile flavors and aromas. The product then has no superior quality advantages over that produced by evaporation [50].

The ice nucleation unit produces small ice crystals, which are transferred into the crystallization unit and grown by ripening (i.e., larger in size) at the expense of smaller ones. In the crystallization unit, the formation and growth of ice crystals should be controlled in such a way that a uniform distribution of large ice crystals suitable for separation is formed. The optimum size distribution for most separators is

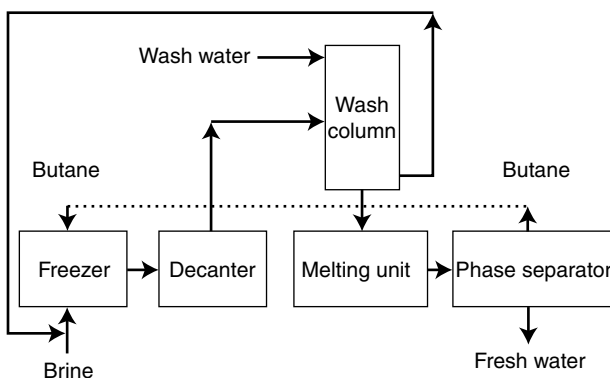


FIGURE 27.3 Simplified flow diagram of a butane FM process.

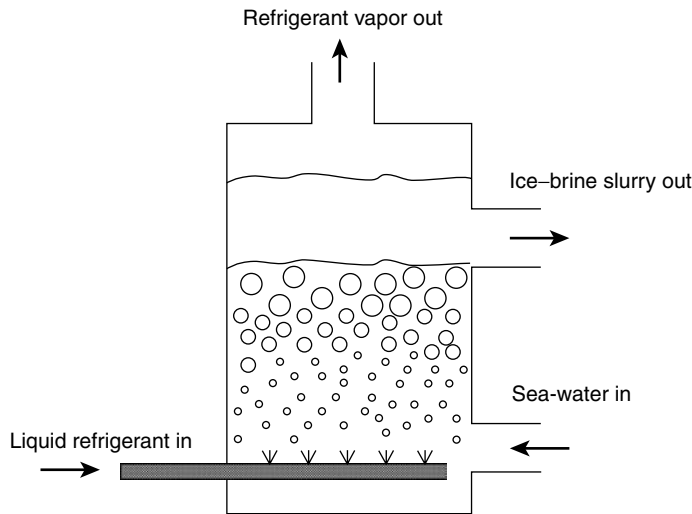


FIGURE 27.4 Schematic diagram of a direct freezing unit. (From Rice, W., Chau, D. S. C. 1997. *Desalination*. 109: 157–164.)

a monodisperse distribution (narrow range of sizes) with a large mean size. This facilitates the washing step and reduces the amount of product carryover into the separated ice stream. The more efficient the separation process, the less carryover of solute into the separated ice stream, and the more economical the overall process is. The ice crystals are then collected and transferred to the ice crystal separator and washed with water to remove the brine or solution from the ice crystal surface. The key technology in this system is how to grow ice crystals in the crystallization unit large enough to facilitate the separation of the ice crystals and solutes [72].

From a separation point of view, the formation of a few large ice crystals is desirable. Supercooling and secondary nucleation were identified to be major factors preventing ice crystals from growing large [51,87,104]. Very rapid supercooling can create a large number of smaller new crystals. Lower rates of supercooling are, therefore, desirable to prevent excessive nucleation. Lower nucleation rates are required to produce reasonably large ice crystals at an acceptable residence time [36]. Thijssen [119,121,122] suggested increasing the agitation rates, within certain limits, to lower the nucleation rates, since high mixing rates may promote smaller size due to mechanical damage. Garabedian and Strickland-Constable [43] found that fluid shear does not produce crystal breeding, and collision of a single crystal in pure water produces high rates of nucleation. Polycrystals may well be formed by agglomeration or growing together of fine crystals, but little is understood about agglomeration. The nucleation rate at low stirring rates is determined primarily by the cooling rate, while with intensive stirring it depends primarily on the hydraulic factor [78]. Polymers could suppress the secondary nucleation of ice crystals, thus larger crystal size could be achieved. The suppression depends on the types of polymer and concentration, and also is related to the increase in viscosity [104].

The circulation pattern of the ice slurry in the freezing unit by direct-contact vaporization of an immiscible refrigerant can profoundly affect the quality of the product crystals [132]. Stripping of butane from products has been accomplished in a packed tower with liquid effluents containing less than 0.2 ppm butane, which meets some standard for desalinated water [10]. Landau and Martindale [69] reported initial bench-scale studies of novel butane freezers, the most promising of which used a draft tube. The butane introduced at the bottom gave good vertical movement to the slurry and 25% ice suspensions could be handled. It was found quite unnecessary to use a mechanical agitator and the unit operates satisfactorily without any additional agitation, and a comparatively small flow of butane vapor, purged near the bottom of the crystallizer, greatly improves the mixing and ensures reliable operation under all circumstances. This small flow of vapor (containing a negligible amount of incondensable gas and little super heat) is still effective in causing circulation even when the pressure in the bottom half of the crystallizer is above the vapor pressure of butane [34].

Barduhn [10] concluded that the following points should be considered in designing secondary refrigerant freezers: (i) adequate dispersion of the liquid refrigerant into the solution is of paramount importance, (ii) normal butane is the cheapest and probably the best refrigerant that does not hydrate, (iii) a short residence time does not necessarily lead to small crystals and poor washability, (iv) the plant should be designed to handle short contact times, and (v) several methods of agitation should be included in the design.

Some of the best possible ways of mixing include: (i) using fine spray nozzles to introduce the liquid refrigerant under the brine, (ii) pumping vapor from the vapor space through spargers that reintroduces it under the brine, (iii) pumping the entire liquid content of the freezer rapidly around a closed path, and (iv) using conventional mechanical agitators. The latter method is the most difficult to scale up and, furthermore, multiple mixers appear to complicate the design and increase costs in large plants. The combination of (i) and (ii) could be a viable option [10].

The ice production rates in a spray freezer can be 10–30 times those in stirred tanks. Refrigerants and salt water are sprayed into a low-pressure space and slurry forms virtually instantaneously, but the particle size averages only 40  $\mu\text{m}$ , and the  $\Delta T$  (temperature gradient between refrigerant and slurry) is very large, 18°C [56]. In case of RC-318 ( $\text{C}_4\text{F}_8$ ), the ice crystal size was a strong function of salinity and a marked size maximum occurred at about 0.5% NaCl. Similar phenomenon is also seen in single crystal growth rates from many aqueous solutions [62]. At least two factors, namely diffusion and surface adsorption, could be controlling the rate in a continuous crystallizing unit [19]. Depending on the liquid depth and temperature conditions in the freezer, several liquid refrigerant zones may exist [75]. Refrigerant at depths sufficient to suppress vaporization is said to be in the *inactive* zone. Vaporizing refrigerant is in the *active* zone, and if liquid refrigerant accumulates on the surface of the slurry, it is said to form an *excess* zone. Nucleation occurs mainly in the active zone, while crystal growth proceeds throughout the entire brine. The depth of the active zone can be calculated from the relationship between the refrigerant vapor pressure and temperature. It is good to prevent the formation of an excess zone, which generally interferes with freezer control [88].

Exchange FM process was developed by Johnson et al. [63]. The crystallizing unit is a horizontal vessel, operating at atmospheric pressure, consisting of three distinct sections: (i) an ice–brine and hydrocarbon disengaging section, (ii) an agitated or contacting section, and (iii) a brine and hydrocarbon disengaging section. The brine entering the agitated section is broken up into small droplets by turbine agitators and countercurrently contacted with a partially solidified stream of normal straight chain hydrocarbons. The melted hydrocarbon, which contains entrained brine, flows into the disengaging section where separation is effected by gravity and electrostatic coalescence. The electrical coalescer is a horizontal unit consisting of three vertically stacked grids.

Applying ultrasound to crystallizing systems offers a significant potential for modifying and improving the process. The most important mechanism by which ultrasound can influence crystallization is ultrasonic cavitation, which is particularly effective for inducing nucleation. Using ultrasound to generate nuclei in a relatively reproducible way offers a well-defined starting point for the crystallization process and allows the focus to be on controlling the crystal growth for the remainder of the residence time in the crystallizing unit. This approach can successfully manipulate crystal size distribution and hence modify solid/liquid separation behavior, washing, and fresh water purity [79]. Adding an ultrasonic system in the crystallizing unit could be tested although it has not yet been applied in FM process.

**27.2.3.1.1.2 Ice Separation** Separation devices can be classified as presses, gravity drainage, centrifuges, filters, and wash columns [106,118,120–122]. Filtration has proven to be less effective for crystal separation and it also cannot be used for washing the crystals. In many cases, screens or filters showed a history of freezing up (brine freezing in the openings of the weave) [54]. Arulampalam et al. [5] investigated the effect of various physical parameters on the efficiency of separation and purification. The important factors controlling the separation efficiency of the columns were the axial diffusion of impurity and the mass transfer between the adhering and free liquids around the crystal phase. Modification of the screw conveyer was necessary to facilitate crystal removal. Conventional methods used for the separation of crystals from their mother liquor prove to be either too slow or too expensive [106].



**27.2.3.1.1.3 Wash Columns** In case of FM desalination, washing is important to attain certain degree of purity. In case of food solution, washing could recover the adhered solution from ice. After the crystals are formed in the crystallizing unit, the crystal/liquid slurry is separated into concentrated liquid and other crystalline components and impurities are washed from the crystal surface, producing pure crystals. To perform the separation, a wash column is used. There are two types of wash columns—pressurized and gravity. In the pressurized wash column, the crystals rise to the top and hydraulic pressure forces a wash liquid, derived from the melted pure crystals, to flow down. The applied pressure also squeezes the concentrate through a filter at the bottom of the column. As the wash liquid flows down the column, it removes impurities from the surface of the crystals. At the interface between washed and unwashed crystals, called the wash front, the wash liquid comes in contact with colder crystals and crystallizes on them. In this way, the wash liquid does not mix with the concentrated liquid. Effective washing of ice is one of most difficult unit operations in an FM process.

The gravity wash column is simpler in design but larger than the pressurized wash column. Its greater height creates the pressure needed to compact the ice bed. It works in much the same way as the pressurized column but at lower pressures. An ice pack is still formed and moved hydraulically up the column. The performance of wash columns depends on the crystal size and shape, and also on the viscosity of the mother liquid. Uniformity of crystal size and shape is important to avoid having the wash water seek the path of least resistance and channel through the crystals unevenly.

To overcome the difficulties associated with surface tension forces, clean fresh water can serve as a displacing liquid. The displacement process can best be pictured by considering a gravity drainage separation process. The separation by drainage is greatly improved when in addition to draining the brine from the bottom of a batch of ice crystals, one adds pure water to the top of the batch and lets it filter through the interstices of the ice bed to displace the remnants of brine. Bosworth et al. [17] suggested a continuously operating separation device based on the displacement principle. In this device, the slurry of brine and ice crystals is introduced into the bottom of a vertical column from which the brine drains through screens at the bottom. The ice crystals move upward by virtue of their own buoyancy force forming a porous ice plug at the top of the column where wash water is added from the top. As the ice plug moves upward through the layer of wash water, the brine is displaced from the interstices of the porous ice plug and the salt-free ice crystals are harvested at the top of the column and transferred to the melting unit. The rise of the ice crystals in the column is, however, rather slow, being a limiting velocity for a particle moving through a fluid by buoyancy (or gravity) forces alone. This limiting velocity determines an upper limit to the production rate for such a gravity wash column, a value that is much too low for economic desaline water conversion. Hahn et al. [48] modified the wash column separator described above to allow the moving brine to provide the driving force for moving the ice particles upward. The discharge screens are located in the vertical walls of the column, about midway between the top and bottom.

Wash columns have been successfully used for both separating the crystals produced in the crystallization section as well as purifying them. These are classified as the flooded column and the drained column. The ice crystal slurry is fed to one end of the column and the mother liquor withdrawn from the same side. The compacted ice bed is forced toward the other end of the column, where it is melted by means of a grid of internally heated pipes. A portion of the melt water is used to wash the crystals moving countercurrently in the column [36].

Ice wash column could be of drained and flooded types with either rectangular or cylindrical shape. Tall screens are desirable, and contouring of the ice surface with the scraper can be very useful. Much higher production rates were possible by cutting out a slot in the center of the column, which fills with wash water, or by cutting a deep V-shaped trough in the ice with the scraper [10]. In a typical hydraulic piston washer-separator column, the ice-brine slurry is fed to the bottom of the column and moves upward. The ice builds up a porous plug until it fills the entire top of the column; the brine flows out of the column through filter screens situated laterally part way up the column walls. As slurry is fed to the column, ice is added to the bottom of the porous plug and the brine flows through the plug. The pressure drop of the brine flowing through the plug causes the ice to move upward, and is harvested at the top of the column, usually by scraping. The washed ice is melted and a portion recycled to the top of the washer separator as wash water. This wash water moves downward by gravity and some of it leaves the column through the filter screens along with brine from the slurry, but the greater part clings to and is harvested

with the washed ice [88,107]. The production of fresh water increases with the increase in ice crystal size, the ice plug length above the screens, concentration of ice crystals in the slurry, and the external mechanical restraining forces on the ice plug. It is also found to increase with a decrease in the ice plug length below the screens, where this length is shown to be an independent parameter for certain slurry feed conditions, such as gravity feed. Shwartz and Probst [106] provided the design criteria for minimizing the capital cost for a given production rate. The theoretical analysis helped to establish the optimal operating conditions for high production rates, sufficiently low salt content in the product, and minimum loss of fresh water. At pressures below about  $1.05 \times 10^5$  Pa, the driving force in the melting unit becomes so low that the required melting-unit cross-sectional area increases to large values, which are uneconomical [88].

Centrifuges have also been used to separate ice crystals from the concentrated liquid. Filtering centrifuges utilize the difference in specific gravity between the ice crystal and liquid concentrate to separate ice from liquid, with the liquid being forced through the filter basket by centrifugal force. Generally, water rinsing is required to assure that there is no salt carryover. For food liquids, there is some loss of volatile flavors and aromas due to the airspace created during separation. It is important to have large ice crystals to ease the ice–crystal separation from the concentrated solution phase [65,103,105].

Ice particles from liquids during the FM process can be separated by a filter. To increase efficiency, a vacuum is normally applied to pull the liquid across the filter. Vacuum filters have been used for separating ice slurry made by direct freezing and vacuum FM systems [32,39,80]. Solids carryover is one of the problems associated with the wash column; however, the Gresco system for separation can achieve up to 100 ppm purity [115]. This wash column operates continuously with countercurrent flow of ice and concentrate. The ice crystals are transported to the upper levels of a vertical column by some natural or applied force, where they are then separated by a scraping device. A small portion of the ice is melted and allowed to pass back down the column, giving the washing effect. The concentrate is removed through a filter at the bottom of the column.

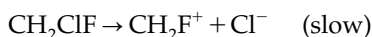
The slurry of the ice crystals in brine is pumped to a wash separation column, where the brine and ice crystals are separated with the consumption of a small amount of wash water. The washed ice is then sent to the melter–condenser, where it is melted by direct-contact condensation of the compressed butane vapor. The primary compressor must compress the butane vapor to attain its condensation temperature between the brine freezing point and ice melting point. The two liquid phases formed in the melting–condensing unit are separated by a decanter, the liquid butane being returned to the freezer and the liquid water representing the product, except for a small amount that is used as wash water and leaves the wash–separation column with the reject brine stream. The net wash water consumption is about 2% [21].

*27.2.3.1.1.4 Melting Unit* The melting unit is difficult to characterize although it appears to be a straightforward process. Direct-contact melting is easy to achieve; however, up scaling is difficult. In case of dumped bed, the characterization of heat transfer data is difficult due to drainage of water and refrigerant from the bed. An indirect melting unit requires a heat transfer surface, which reduces the attainable efficiency when compared with the direct-contact melting unit [63].

Lloyd [73] applied the concept of integration to facilitate high utilization of space and permits adjacent processes to share boundaries. A commercial design using two integral vessels for four main processing steps has been formulated. It showed that the capital cost could be reduced by around 20%. Different commercial equipment are available based on this concept.

*27.2.3.1.1.5 Refrigerant–Brine Interactions* The refrigerant is contaminated by brine spray carry-over from the crystallizing unit, which adversely affects compressor performance. Thus, it is necessary to develop separation devices between the crystallizing unit and compressor. These separators must remove ice containing an evaporating refrigerant, thus simple demisters are not permissible because of ice plugging problems attendant to this condition. The dissolved refrigerant is rather easily removed by vacuum stripping of the effluent stream, which can be polished to meet environmental effluent standards by carbon absorption if necessary.

It is important to make certain that during operation of the process, excessive losses of refrigerant do not occur as a result of entrainment and solubility of Freon in the water, and from irreversible processes such as hydrolysis. In addition, if the rate of hydrolysis of the Freon refrigerant is too large, undesirable levels of soluble fluoride could build up in the product water. Stepakoff and Modica [112] developed the solubility data of Freon to predict the rate of hydrolysis, which is a function of dissolved Freon in water. They found that the economic loss of hydrolysis is less than 0.26 cents/m<sup>3</sup> of water. The solubility of refrigerants decreases with the increase in salinity, which is termed as salting out. The hydrolysis rate decreased to half for a 3% saline solution relative to pure water at the same temperature and pressure. Completely halogenated hydrocarbons are much less soluble than their partially halogenated counterparts. For example, Freon 142b (CH<sub>3</sub>CClF<sub>2</sub>) is 10 times as soluble as Freon 114 at 1 atm, -4°C. The solubility of Freon 14 (CF<sub>4</sub>) is about three orders of magnitude less than that of Freon 23 (CHF<sub>3</sub>). The fact that hydrogen-containing Freons are much more soluble than their completely halogenated counterparts can be understood on the basis of hydrogen bonding between the CH group in the halocarbon and the oxygen dipole of the water molecule [14]. The simplest mechanism for describing the hydrolysis of Freon is to assume that the rate-determining step is the slow ionization to a carbonium ion and a halide ion followed by a faster reaction of the carbonium ion with dipolar water molecules [16]. The essential feature of this mechanism is that every carbonium ion that is formed in the primary step is attacked by water at a much faster rate than by halide ions, i.e., the reverse rate of the primary step is very slow. In the case of Freon 31, the mechanism of hydrolysis can be described by the following equations [30]:



The presence of formaldehyde (HCHO) in the hydrolysis of Freon 31 was confirmed by chemical tests, and the rate of formation of chloride and fluoride was found to be identical [30]. Stepakoff and Modica [112] pointed that a similar effect could occur during the hydrolysis of Freon 114. Stepakoff and Modica [113] determined the hydrolysis rate constants for Freon 21 (CHCl<sub>2</sub>F), Freon 31 (CH<sub>2</sub>ClF), and Freon 114 (CClF<sub>2</sub>CClF<sub>2</sub>) based on the three adjustable parameters—the Arrhenius collision frequency, hydration energy of the carbonium ion, and the ionic distance of closest approach.

#### 27.2.3.1.2 Eutectic Freezing

Eutectic FM process was first proposed at Syracuse University. Barduhn [9] devised the process and Pangborn [91] tested the idea. In eutectic FM process, salts separate as solids and fresh water as ice from brine. By freezing the water out of these aqueous solutions until they are adequately concentrated to precipitate the salt simultaneously, one ends up with a brine-free product. The ice and salt crystals nucleate and grow independently, and are easily separated since the ice floats and the salt sinks. Using the simple system of sodium chloride and water, the essential feature is that at -20°C both ice and NaCl·2H<sub>2</sub>O crystals precipitate from solution as heat is removed. Laboratory investigation of the eutectic temperatures of various proportions of the ions commonly found in natural waters (Na, K, Ca, Mg, Cl, SO<sub>4</sub>, HCO<sub>3</sub>) shows that the process operated well at temperatures no lower than -25°C [12]. This approach could avoid brine disposal problem as well as production of by-products as salts. The main difference between this and the normal freezing process is the presence of the ice-salt separator and the salt filter. Several important variations of this have been proposed. Another important difference between normal and eutectic freezing is the crystallizing unit. In normal freezing, where the product water is the only goal, the freezer operates at about -5°C and the temperature lift for the primary compressor is thus about 6°C.

Two-stage eutectic FM is more economical [12,100,114]. The costs are generally much lower than the alternative of reverse osmosis followed by deep-well injection of the reject brine. Actually, deep-well injection could be ecologically unsound. Eutectic FM process may be one of the meaningful solutions to brine disposal [114]. Schroeder et al. [100] pointed that eutectic FM processes are likely to become very important in the future when they are better developed. A stirred-tank crystallizing unit, hydrocyclone separator, and a floating wash column are used [114]. The hydrocyclone splits the slurry into a light and heavy cut. The light cut, called the overflow, contains the ice crystals and brine. The heavy cut, called the underflow, contains

the salt solids and brine. The salt solids can be separated from the brine, utilizing conventional solid–liquid separators such as filters, and then dried in conventional dryers. The brine filtrate is essential for the functioning of the crystallizer. [100]. Hydrocyclones are compact, simple devices, and have a low pressure drop. Washing is different due to small ice crystal size and low slurry temperature. Schroeder et al. [100] identified the possibility of combining eutectic freeze and distillation processes, and membrane and eutectic freeze processes. The product stream of eutectic freezing would be a brine of low salinity, which would be returned to the distillation plant or membrane process in an actual operation. The cost of membrane processing depends solely on the brine concentration. The melted ice water from a single freezing without a wash step has 3–6 times less salt than the feed [130]. Usually, a conventional direct-contact FM process operates at around  $-5^{\circ}\text{C}$ , whereas the eutectic FM process operates at  $-25^{\circ}\text{C}$ , thus the latter needs more energy for cooling. The main advantage of the eutectic FM process is that it can separate both ice and salts at the same time and avoids the brine disposal problems. For the precipitate salts, different by-products could also be possibly produced. Different ways for disposal handling are adopted, including pumping into lined evaporation ponds, injection into underground rock formation, and spreading on unusable arid land. All these are short time solutions due to the large amount of rejected brine to be disposed of [2].

### 27.2.3.2 Indirect-Contact Freezers

In indirect-contact FM process, the energy for refrigeration must be passed through the walls of some form of heat exchanger, and heat transfer occurs through a solid barrier [31,122]. It was found that the growth rate of dendrite type ice in supercooled water cannot be completely understood on the basis of heat-flow controlled-growth mechanism, but has to be explained on the basis of the combined mechanisms of heat dissipation and molecular-growth kinetics [92,93]. Indirect-contact systems can be classified into those that are internally cooled and those that are externally cooled. Internally cooled crystallizers can be further subdivided into static layer growth system, layer crystallization unit on rotating drum, progressive crystallization unit, dynamic layer growth system, and suspension crystallization processes.

#### 27.2.3.2.1 Internally Cooled

**27.2.3.2.1.1 Static Layer Growth System** In layer growth systems, the liquid from which the crystal mass is grown is stagnant and it is termed as static layer crystallization. The static operation of solution crystallization in this process is very reliable and requires very simple equipment without moving parts or the need for a solid–liquid separation device. The residence time in this process is large because the mass transfer is only promoted by free convection. Large equipment volumes are required due to the batch-wise operation and slow crystallization rate [53,96]. The crystal–solution interface per unit equipment volume can be increased by using plate-type contact surface, but static growth cannot be avoided [59]. High purification efficiency can only be obtained when relatively low rates of growth ( $<10^{-7}$  m/s) are established since no stirring is applied. The capital cost of the equipment is high and more economic use can be obtained by carrying out more than one relatively rapid crystallization in series. Muller and Sekoulove [85] pointed that layer-freezing process is easier to manage, but the crystal growth upon a cooled surface induces fast crystallization rates and under these conditions rather impure crystal film may be produced. In spite of this moderate crystal purity, the disadvantages are compensated by the ease of operation, because there are no moving parts and no slurry handling is required. Two mechanisms of crystal growth were found in a batch crystallizer with an external cooler, which contained a large amount of ice crystals. With the first mechanism, the ice crystals grew larger by the usual kind of growth, governed by heat or mass transfer resistance, and with the second, the ice crystals agglomerated and the agglomerate fused into a very large ice crystal (1–3 mm in diameter). The second mechanism occurred not because of the high concentration of ice crystals in the crystallizer but because of long residence time. Large ice crystal agglomerates were not produced when extremely small ice crystals were formed in the crystallizer at the start [105].

**27.2.3.2.1.2 Layer Crystallization Unit on Rotating Drum** In layer crystallization with a rotating drum FM process, ice forms in thin layers on the heat exchange surface, and after a suitable period of time for the ice layer to build up, the ice is removed from the surface and is separated by a press from

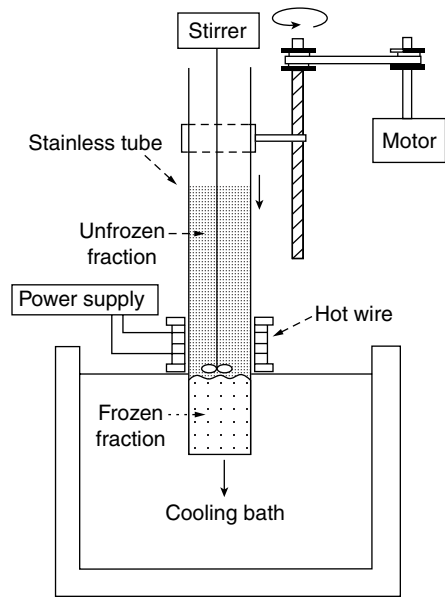
the concentrated liquid remaining. One form of layer crystallizer utilizes a rotating drum immersed in the fluid to be concentrated. Refrigerant is circulated within the drum and causes ice to form on the surface of the drum, which is then scraped free as the drum rotates past a knife [50].

#### 27.2.3.2.1.3 Progressive Crystallization Unit

A progressive crystallization FM process is a method of separating solvent from solution based on a concept completely different from the conventional method of layer crystallization described above [6]. Progressive FM process utilizes the concentration phenomenon of a solute at the ice–solution interface moving from one end of a vessel to the other end [45]. It is characterized by having only a single ice crystal in the system so that the separation of the ice crystal from the concentrated solution is very easy compared with the conventional FM method (Figure 27.5).

The concentration efficiency in the progressive freeze concentration was related to the ice structure of the freezing front. High freeze-concentration efficiency was obtained under the conditions at which a smooth solid–liquid interface is formed. Distribution coefficient depends on the ice structure at the freezing front and the operating conditions are represented by the moving speed of the freezing front and the speed of stirring in the solution phase [6,82]. Liu et al. [72] studied the operating conditions of this process on freeze-concentration ratio and apparent partition coefficient of a solute between the ice and the solution phases (glucose and blue dextran). They found that the efficiency of the process is strongly dependent on the moving speed of the freezing front and the agitation or stirring speed at the ice–solution interface. A lower moving speed of the freezing front and a higher stirring speed produced a better freeze-concentration ratio. A concentration polarization model was useful to describe the effects of the operating conditions on the effective partitioning coefficient [82]. Matsuda and Kawasaki [77] investigated the effects of supersonic radiation and dissolved air concentration in the liquid on the efficiency of separation and concentration of glucose and sodium chloride under various freezing rates. They found that the efficiency was greatly improved by supersonic radiation and increasing dissolved air concentration. In progressive freeze concentration, the major part of the impurity in the ice phase occurs when supercooling occurred before the initial crystallization at the bottom of the sample vessel. Different mechanisms of solute rejection at the interface were observed [71]. Ice-nucleating protein (types of antifreeze proteins) could be used to suppress initial supercooling [72,131]. Curran [31] studied the effects of container geometry on the recovery of product water from indirectly frozen salt water. Salt water was frozen in containers having circular or rectangular cross-section, then allowed to melt and drain until the residual ice was potable. Thin rectangular cross-sections were found to be more effective than circular cross-sections. The product water recovery was found to increase with increasing ice height of up to 60 cm, beyond which the effect of height was negligible.

The growth rates of ice depend on the ionic salts, surfactants, and water-soluble polymers. Michaels et al. [81] identified that both growth-rate enhancements (up to a factor of about 5) and retardations (up to a factor of about 3) could be possible in the presence of additives. The type of effect and its magnitude were dependent on the nature of the additive, its concentration, and upon the degree of supercooling. The effect of solutes may result in dislocations being introduced in the crystal during growth. Recently, Miyawaki et al. [83] showed that a tubular ice system with a large cooling surface area was effective as a method for scale-up of progressive freeze concentration, with increased productivity and high yield. In this method, the slower growth rate of ice and the higher circulation rate gave the lower



**FIGURE 27.5** Apparatus for progressive FM process. (From Liu, L., et al. *Food Science and Technology International Tokyo*. 3(4): 348–352.)

effective partition constant as was expected theoretically by the concentration polarization model. The effective partitioning constant was also dependent on the initial solute concentration; higher concentration gave higher partitioning constant of solute. By the tubular ice system, coffee extract, tomato juice, and sucrose solution were very effectively concentrated to high concentrations with good yields, showing the high potential of progressive freeze concentration for practical applications.

#### 27.2.3.2.1.4 *Dynamic Layer Growth System*

27.2.3.2.1.4.1 *Falling-Film Type* In this type, solution flows down over the wall of the heat exchanger (well-mixed). Crystals are formed on the wall surface under the falling film. Shear caused by solution flow at the crystal–solution interface increases the mass transfer coefficient and promotes the transport of impurities from the interface to bulk. This process is easy to scale-up because of its modular design. Currently, most of the layer growth processes are used in the chemical industry and seldom in the food industry.

Local equilibrium at the interface exists and solute trapping occurs based on the rate of crystal growth [8]. Solutes are distributed between brine and ice crystals. Adsorption on the ice crystal surface and entrapment within the ice may be the major reason for the presence of solutes in ice. Distribution or coefficient of salt (ratio of salt in brine and ice) is used to determine the solids in the ice and slurry [15].

27.2.3.2.1.4.2 *Circular-Tube Type* In this process, ice is formed from a solution flowing through a tube cooled from the outside [35,74,89,134]. Supercooling can be achieved in a liquid before it solidifies when forced to flow inside circular tubes. The maximum supercooling depends on the local tube wall temperature, the tube's internal diameter, Reynolds number, and a dimensional constant depending on the process [4]. Salt entrainment in the ice layer is one of the major problems in indirect FM process. Janzow et al. [60] studied the salt entrainment in ice crystallized from brine on a flat pellet. The thickness of the ice layer first increases rapidly, reaches a maximum, and then decreases. This phenomenon corresponds to the growth and subsequent melting of dendrites. It was believed that brine adhering to the thin plates of ice and perhaps being retained in the interstices by capillary forces is responsible for the relatively high salt concentration found in the melted ice. Rinsing operation could be applied to reduce brine content in the ice layer.

27.2.3.2.1.5 *Suspension Crystallization Unit* In suspension crystallization unit, the product to be concentrated is agitated in a vessel cooled by heat transfer through the walls of the jacketed vessel. This vessel may be either a scraped-surface heat exchanger or simply a jacketed kettle vessel. The result of this process is a pumpable suspension of ice crystals in the concentrated product, which must then go to a separation device. Independent control of ice nucleation and crystal growth is very difficult in this type of crystallizer [50]. Many variations have been investigated to develop a process that allows independent control of ice nucleation and crystal growth [122].

A modification of the process above involves the recycling of all or part of the mass in the main vessel. One process recycles the entire crystal slurry through an external heat exchanger, similar to a forced-circulation evaporator, to provide cooling. Nucleation occurs mainly in the heat exchanger, usually scraped-surface, while most of the growth occurs in the main vessel. In a slight variation of this system, only the liquid product from the main vessel is recycled by withdrawing the liquid through a filter. This ice-free liquid is then pumped through a scraped-surface heat exchanger operating at high subcooling temperature to promote nucleation of small crystals (50  $\mu\text{m}$ ). These fines are then pumped back into the main vessel, where a ripening process occurs. The difference in equilibrium conditions between the fine nuclei and the existing seeds provides the driving force for ripening, which results in the dissolution of the fines and the growth of the seeds as the equilibration process occurs. Large mono-disperse crystals may be formed in this way [50]. In the ripening tank, the unstable subcritical ice crystals melt and the latent heat they absorb in melting causes freezing on the surface of the large ice crystals in the ripening tank [102]. As small crystals have a lower melting temperature in solution than larger crystals, the small crystals melt and recrystallize on the surface of the larger ones.

### 27.2.3.2.2 *Externally Cooled*

Externally cooled crystallizers employ a heat transfer device external to the main crystallization vessel. One type of externally cooled crystallizing unit employs a heat exchanger to supercool the liquid feed so that the cold feed provides the cooling effect in the main vessel. Both nucleation and subsequent crystal growth occur in the main vessel. Conditions in the heat exchanger must be closely controlled to prevent nucleation from occurring where it is not wanted [50].

A modification of the external cooling process involves recycling all or part of the mass in the crystallizer. One process recycles the entire crystal slurry through an external heat exchanger to provide cooling. Nucleation occurs mainly in the heat exchanger, usually a scraped surface heat exchanger, while most of the growth occurs in the crystallizer. Ideally, ice-free liquid is cooled to promote nucleation and generate small crystals by being pumped through a scrap surface heat exchanger operating at high supercooling. These fine crystals are then transported with the product into the crystallizer, where the ripening process occurs.

**27.2.3.2.2.1 *Supercooled Feed*** A solution is supercooled in a heat exchanger without ice formation. Ice crystals are formed instantly in a nucleation device before transport to a separate vessel for growth. The primary aim is to avoid heterogeneous crystallization within the crystallizing unit. The inside wall of the heat exchanger has to be highly polished or coated with a hydrophobic plastic to minimize changes of minimum nucleation and crystallization within the heat exchanger. The concentrated solution is filtered to effect ice separation. Low energy consumption is claimed to be one of the benefits [70]. Janzow and Chao [61] identified that within a relatively narrow range of supercooled brine temperatures, large plate-like free ice crystals of up to several inches in length were formed in the bulk of slowly traversing brine simultaneously with the growth of dendrite ice on a cold surface.

**27.2.3.2.2.2 *Ripening Vessels*** It has been reported that ice crystals with 1 mm diameter could be produced by applying the process of ripening [57,116] with long residence time of the ice crystals. Smith and Schwartzberg [110] examined ice crystal size change during ripening. A method of producing large ice crystals, which uses the Ostwald ripening effect, was developed and is now widely used in the industry. Shirai et al. [105] and Kobayashi [65] proposed another strategy to make large ice crystals by agglomerating the small ice crystals produced. Theoretical analysis of certain FM systems was also carried out by Bayindirli et al. [15] and Ratkje and Flesland [94].

### 27.2.3.2.3 *Comparison of Different Types of Indirect Freezing–Melting Processes*

The performance of suspension growth systems can be improved by adopting a multistage design [47]. The main advantages of the multistage plants include lower energy consumption and approximately 50%–70% lower operating costs than the single-stage process. The loss of soluble solids usually is less than 100 ppm after the washing step in the Gresco system.

The drawbacks of dynamic growth system are: needs large solution circulation rate; large crystallizer volume; multistage operation required to attain high purity (sometimes 8–9 stages may be needed); optimization of some variables, such as number of stages, reflux ratio, and maximum thickness of crystal layer; and the cost and energy efficiency are adversely affected by the need for repeated operation of the batch procedure. A continuous commercial dynamic layer growth process using a countercurrent layer crystallization technique is called the Bremband belt crystallizer [58]. The main problem of this process is that it is uneconomical.

A comparison of layer and suspension crystallization growth is given in Table 27.3. The same crystallization laws govern both layer and suspension processes. This means that the results obtained with both process types will, in principle, be the same when the operating conditions are identical.

In practice, the main advantages of layer growth in comparison with suspension growth come from simple technology with simple design and scale-up. High growth rate can be achieved in layer growth processes because heat is transferred through the solid layer. However, a large growth rate usually results in limited effective distribution coefficient in a single stage. By adding a sweating step and repeating the operation, high purity can be attained, but at higher costs.

TABLE 27.3

Comparison between Layer and Suspension Growth Methods

Feature	Layer Growth	Suspension Growth
Purity attainable	Limited per stage (repetition needed)	High in one single stage
Crystal–solution interface	Small (10~100 m <sup>2</sup> /m <sup>3</sup> )	Large (10,000 m <sup>2</sup> /m <sup>3</sup> )
Growth rate	Large (10 <sup>-5</sup> ~ 10 <sup>-7</sup> m/s)	Small (10 <sup>-7</sup> ~ 10 <sup>-8</sup> m/s)
Purification	Solid–liquid separation, sweating and reprocessing in same unit	Solid–liquid separation, sweating and reprocessing in separate devices
Production rate/volume of equipment	Small	Large
Way of operation	Batch, possible continuous	Usually continuous
Technical feasibility	Proven technology	Force transport columns: demonstration phase
Heat transfer coefficient	Small (50~400 W/m <sup>2</sup> K)	Large (1000~4000 W/m <sup>2</sup> K)
Design	Simple	More complicated
Scaling up	Simple	More complicated
Crystal size (distribution)	Not important	Important
Solid–liquid separation	Simple, by draining followed by melting	Extra device needed
Pieces of equipment	One single	Several
Moving parts	Only pumps	More moving parts needed
Transport problems	No suspension handling	Pumping of suspension
Incrustation	No, layer is product	Yes, may be hampering
Flexibility	Multipurpose	More tailor made
Reliability	Restart without loss of product	Loss of product in case of interruption, which has to be recycled

Source: Chen, P. 1999. Freeze concentration of food liquids using layer crystallisers. Ph.D. thesis, University of Auckland, New Zealand.

The main features of suspension growth option combined with wash column technology are large single-stage efficiency and large net production per volume of equipment and time period. The suspension option also offers a continuous operation, which may result in lower energy consumption.

The progressive FM process can be easily run at atmospheric pressure and is less complex. It gives only one block of ice, thus separation and melting process is easy. However, the main disadvantage is that it requires greater processing times and large temperature differentials [31].

### 27.2.3.3 Comparison between Direct and Indirect Freezing–Melting Processes

Water from direct-refrigerant FM process contains excessive amounts of volatile refrigerant, which is undesirable in most cases. This process could keep 80–140 ppm of butane and up to 3% CH<sub>2</sub>ClF, CF<sub>2</sub>Cl<sub>2</sub>, or other halogenated hydrocarbons [67]. These gases must be recovered and recycled down to about 1–10 ppm to recover their economic value or prevent explosion hazards, and probably to the 0.1 ppm range to meet public health standards for drinking water [7,21]. When the dissolved gas is to be recovered after removal, it is important that the process be uncomplicated to keep the cost low. Simple flashing of the product streams at reduced pressures is useful, and probably necessary, but not sufficient since the approach to equilibrium in a single-stage flash is not very close because of the very short residence times in spray chambers. In this case, lowering the flashing pressure is the key to maintaining the low ppm of the refrigerants.



Bajolle et al. [7] designed a system for stripping butane from water in a packed column down to concentrations as low as 0.6 ppm. The mass transfer of butane from the melted water was experimentally shown to be liquid-diffusion controlled. The results obtained are expected to be valid as long as the thermal effects are not significant, i.e., as long as the column is operated at a total pressure not below the vapor pressure of water.

The hydrate formation consisted of two phenomena, which were almost always observed when the freezer was being tested at low driving forces. First, the ice becomes oily, somewhat impalpable, and washing becomes poor. Operators called this rotten ice. Second, the inventory of butane in the storage tanks dropped steadily. This accumulation of butane in freezer, washer, or melter could be due to hydrate formation. Insufficient agitation at the low-temperature gradient can lead to accumulation of liquid butane in the freezer, and it will then carryover into the washer reducing the porosity of the ice bed and thus resulting in poor washing. In some cases, when the refrigerant is well dispersed, it shows no hydrate formation even with 80-20 mixtures of *iso*- and *n*-butane. Mixed refrigerants for which the vapor-liquid equilibrium is normal (i.e., the temperature-composition diagram is lens-shaped) have a disadvantage, since the bubble and dew points differ. In the case of *iso*- and *n*-butane, this difference at the compositions used is about 1°F. Thus, 1°F is added to the total temperature lift of the heat-pumping cycle, which adds about 10% to the energy requirement for primary compression beyond what is needed for a pure or an azeotropic refrigerant. Hydrates may also cause channeling in the wash column.

Hydrate formation is one of the problems of direct FM process. The rate of heat transfer among the four phases present in a butane freezer controls the rate of ice production, and this in turn is determined mainly by the liquid-liquid interfacial area and the intensity of turbulence in the freezer. The lack of proper liquid dispersion and adequate agitation in the freezer has led them to produce at low rates per unit volume and has probably caused all the trouble with butane hydrates.

Formation of hydrates is one of the problems that occur in direct-freezing process. *Iso*- and *n*-butane may form hydrates. Having two crystal species present (ice and hydrate) is uneconomical for the process since heat must be removed at the lower of the two formation temperatures and rejected at the higher of the two. In the case of ice and *iso*-butane hydrate, this increases the total temperature lift for the primary compressor by about 1.9°C, which may increase the energy requirement by 30%. Even more serious than this is the fact that the hydrate substantially reduces the permeability of the crystal bed in the wash column. Butane-1 usually shows less hydration compared to normal butane. Operation on butane-1 was similar to that with the butane mixture, and hydrates and rotten ice still appeared under certain conditions. In addition, the smell of the commercial hydrocarbon bothers many people, and it costs about 31 cents per gallon as compared to 11 cents for normal and 14 cents for *iso*-butane [10]. Fernandez et al. [42] found similar rates of formation in hydrates in the case of propane, F-12 (CCl<sub>2</sub>F<sub>2</sub>), and methyl bromide (CH<sub>3</sub>Br). Roux [98] found that F-31 (CH<sub>2</sub>ClF) formed hydrate 6-10 times as fast as the above refrigerants. The F-31 hydrate crystals were compact rough spheres with average diameters of 150-190 μm. Both propane and methyl bromide hydrates are smaller and much more dendrite type, and probably more compressible in beds. Hydrate properties depend on the type of refrigerant.

Homogeneous nucleation of ice crystals requires a subcooling of several degrees and does not occur in the direct-contact freezing process for which brine temperatures are much closer to the freezing point. All new crystals are formed from existing crystals by secondary nucleation processes such as breaking of crystals by collisions or removal of fragile dendrites by fluid shear [132].

The refrigerant compressor limitations and problems is one of the important limitations for direct FM process. However, it can be eliminated by the use of a new type of compressor known as the hydraulic refrigerant compressor [95]. The hydraulic refrigerant compressor does not need any lubrication (therefore lubricant contamination is avoided), and water and water vapor carried into the compressor inlet have no detrimental effect on the compressor. This compressor is highly efficient, thus it avoids the problem of freeze desalination caused by conventional compressors. At the freezer and melting unit temperatures, the pressure of the two-phase *n*-butane refrigerants is very close to atmospheric pressure, which is a large advantage in the freeze-desalination system since the pressure vessels need to only withstand very small pressure differences and can be of minimal strength and cost. The advanced technical skills associated with the design, installation, and maintenance of conventional refrigerant compressors are not needed, nor are expensive spare part stores. The hydraulic refrigerant compressor is simple, low cost, and maintenance is minimal. It is compatible with the other components of an FM process.

### 27.2.3.4 Vacuum Freezing

Vacuum-freezing and vapor-compression systems have been used for seawater desalination. Water can itself serve as the refrigerant in vacuum freezing according to Dickey [37]. In this option, a high vacuum is employed to vaporize a portion of water, which then provides the refrigeration effect for lowering the temperature of the product and causing ice crystallization to occur. The washed ice is melted by direct-contact condensation of the water vapor in the melting–condensing unit. All vacuum freezing processes contain a crystallizing unit, which is a vessel in which ice crystals and vapor are formed simultaneously by maintaining the vessel close to the triple point (when the material could not be considered either as solid, liquid, or gas) (0.61 kPa). Based on the method by which the vapors are removed, these may be further classified as (i) vacuum-freeze and vapor-compression systems, (ii) absorption-freeze and vapor-compression systems, and (iii) vacuum-freeze and ejector–absorption systems. In *vacuum-freeze and vapor-compression method*, a mechanical compressor is used to remove the vapor phase. The vapor is compressed so as to permit it to condense either directly as pure crystals or on a heat-transfer surface. In case of *absorption-freeze and vapor-compression*, water vapor is absorbed in a material that has a vapor pressure below the triple point and the absorbent has to be regenerated. A conventional refrigeration cycle can be used to provide the heat necessary to drive off the absorbed vapor. The *vacuum-freeze and ejector–absorption* method uses mechanisms to remove the vapor by an absorption cycle or low-pressure steam ejector. The steam that drives the ejector is also used to regenerate the absorbent. The ejector acts as a thermal compressor to raise the quality of the removed vapor so that the vapor can be condensed [36].

In vacuum freezing, the compressor must handle a very large volume of low-density water vapor due to the very low vapor pressure of water. Whereas when a relatively volatile refrigerant such as butane is used, the freezer pressure is raised to approximately the atmospheric pressure and the volume of vapor to be compressed is greatly reduced. Furthermore, compressor technology for butane from  $0.85 \times 10^5$  to  $1.05 \times 10^5$  Pa is much better developed than that for water vapor compression from around 400 Pa. On the other hand, in vacuum freezing, no butane is added to the system, and therefore the complexity and expense of butane recovery, butane make-up, and fire and explosion protection measures are avoided. Hence, the relative simplicity of vacuum flash freezing recommends its use, especially for plants of small size [21]. In case of vacuum freezing, the residence time is not an important variable and the process is more heat-transfer controlled requiring agitation. Moreover, it needs more efficient designing of the melting unit for removal of noncondensable gas in the system [10].

#### 27.2.3.4.1 Vapor-Compression System

In the vacuum-freezing vapor-compression process, a large multiblade compressor is used to compress vapor from the freezer to the melting unit. For a plant having a capacity of 227 m<sup>3</sup>/day, the compressor was more than 3 m in diameter and needed a fairly high moment of inertia for starting. For larger desalting plants of perhaps 4000 m<sup>3</sup>/day and above, it is difficult to find a practical compressor [40]. There are two components of a vacuum-freezing system: the vapor removal unit to keep the slurry at or below its triple point, and a freezing/evaporation unit to keep ice particles suspended with a fluid slurry/vapor interface. An economical system will have the freezer and vapor removal units of nearly the same capacity, both are expensive. In principle, a balance between the size of evaporation and condensation units could be calculated from existing correlations when standard thermodynamics are known, which is difficult. The primary compressor must compress the water vapor from a pressure somewhat below the vapor pressure of water in equilibrium with the brine at its freezing point up to a pressure somewhat above the vapor pressure of pure water at 0°C. An auxiliary refrigeration cycle is needed to remove the excess energy from the system, such as a standard ammonia cycle removing the heat of condensation of the excess water vapor and rejecting heat to ambient cooling water. Pachter and Barak [90] identified the following module for increasing the compressor efficiency: multicompressor modules, direct contact and evaporative feed precoolers, and multistage heat removal compressors of flexible blade type. Burton and Lloyd [23] examined the design considerations of the primary and secondary compressors. Additionally two other aspects, safety and environment, affecting component specifications were discussed.

#### 27.2.3.4.2 Vapor Absorption

To realize the low energy consumption advantage of FM, it is necessary to seek a different solution, for example, vacuum-freezing ejector-absorption process (VFEA) [17,55,66]. In an absorptive vacuum-freezing process, water evaporates from the freezing solution and condenses on a cold salt solution. Condensing on a flowing cold NaCl solution was found to be an inexpensive water vapor removal method. In this process, water vapor is compressed by a combination of steam ejector and absorber loop with the primary energy source being thermal rather than mechanical. The process incorporates an absorption loop, which raises the pressure and temperature of a portion of the vapor evolved in the freezer to a level sufficient to drive the steam ejector. Primary and secondary steam discharged from the ejector is at the stoichiometric temperature required to melt the ice. The absorption loop, in raising the freezer vapor from a level slightly more than 400 Pa to that of the primary steam, acts as a compressor. The ejector has the advantage of no moving parts and is capable of being designed for larger plants. The real novelty lies in the fact that the water vapor generated in the freezer is recycled through the system to act as the primary steam for the ejector. The addition of heat was completely separated from the process cycle. For a media to absorb water vapor, a solution of sodium hydroxide is usually chosen as being most appropriate to the pressures and temperatures in the VFEA process. It is also an inexpensive chemical in comparison to alternate choices and is readily available in large quantities. The average vapor pressure in the absorber is maintained below the crystallizing-unit pressure to provide the driving force for vapor absorption. The dilute sodium hydroxide solution from the absorber is heated by the concentrated solution in the absorber heat exchanger before it enters the concentrator. The main feature of the VFEA process is that it can use low-grade thermal energy, which may be generated by flat-plate solar collectors. This combination would seem to be attractive in remote coastal or inland communities [40].

Low operating pressures below 611 Pa make the effectiveness of this method dependent on keeping the fraction of noncondensable gas in the vapor phase. Air introduced with the feed and from equipment leaks will accumulate near the condensing interface unless removed by a mechanical pump downstream from the condenser. Noncondensable gas entering the vapor space between the freezing slurry and absorbent will be pushed to the absorbent surface by the water vapor flow, impeding water vapor condensation [37,54]. In many cases, feed saline water intake is first pumped to a vacuum deaerator to remove air and other gases before it is pumped into the crystallizing unit [40].

The advantage that offsets the cost of the low pressure compared to the more usual indirect FM is that the freezing slurry is chilled uniformly, without a stationary interface between the coolant and the freezing slurry. Stationary interfaces require constant, costly removal of ice or special interface treatment to keep the ice from reducing heat transfer to the coolant. Cost-effective absorber design is often sufficiently complicated that published models and theories are of limited use in predicting performance [38].

#### 27.2.3.4.3 High-Pressure Melting

Vacuum freezing with high-pressure ice-melting process was introduced by Cheng and Cheng [26], and improvements were proposed by Cheng et al. [27]. In this process, high-pressure ice-melting (washed ice) and desublimation of the low-pressure water vapor are conducted simultaneously inside and outside of heat-conductive conduits respectively. Thus, fresh water is formed inside the conduits and a desublimated (ice) deposit is formed on the outside, which is then melted. In some cases, *in situ* desublimation dissolution operation is used. In this case, an aqueous solution is brought in contact with the desublimated mass and the conduits are depressurized. The desublimation dissolves in the aqueous solution and an equivalent amount of ice is formed inside of the conduits. It is noted that in the *in situ* desublimation dissolution operation, desublimation is not recovered as product water. The advantages are it neither requires a compressor or absorption solution for the low-pressure vapor, nor a regeneration loop or a heat pump (a refrigeration loop) to reuse the heat released in the condensation or desublimation of low-pressure water vapor in supplying the latent heat of melting ice, the process uses commercially available components and can be operated reliably [25]. An extended surface freezer, such as rotating tray freezer, used in this process is found to have several advantages over the conventional spray freezer or agitated jet evaporator. These advantages are lost driving force due to back mixing of brine is less, need of a demister is eliminated,

power input in the refrigeration is saved although a portion of the power is used by the stirrer, and larger crystals can be made so that the crystal-washing operation can be facilitated [25].

#### 27.2.3.4.4 Vacuum-Freezing Multiple-Phase Transformation Freezing–Melting Process

In case of low pressure below the triple point ( $< 610$  Pa), sublimation occurs and it is called subtriple point vapor. When a subtriple point vapor is cooled at constant pressure, it condenses as solid solvent as ice and this operation is called desublimation. Cheng et al. [28] proposed a vacuum freezing multiple-phase transformation (VFMPT) that consisted of vacuum evaporation freezing, subtriple point vapor desublimation, desublimation melting, supertriple point vapor generation, crystal washing, and crystal melting. A preliminary economic analysis shows that VFMPT process can be more competitive than reverse osmosis and distillation/evaporation in the range of solute concentrations represented by seawater desalination both in terms of equipment and operating cost, and in many applications when concentration is higher VFMPT can be more suitable for reverse osmosis process, which required very high pressure. Advantages identified for VFMPT process are high heat transfer rates, low energy input, insensitivity to fouling and corrosion, and the ability to handle highly concentrated as well as acidic and alkaline solutions.

### 27.3 Applications in Food Industry

The use of FM is more common (instead of evaporation) to concentrate liquid foods due to the reduced loss of volatiles, aromas, and thermal degradation of the product [18,71]. The juice and dairy industries have used the technology successfully. It has been utilized commercially for the concentration of citrus fruit juices, vinegar, and beer and wines. This technology has also been used for concentrating coffee and tea extracts, sugar syrups, maple sugar syrups, dairy products such as milk and whey, and aroma extracts [128]. More common to the food industry are the indirect-contact crystallizers, where the refrigeration energy must pass from the aqueous liquid food through the walls of an appropriate heat exchanger. The most common ones are static layer growth system, layer crystallization on rotating drum, dynamic layer growth system, and suspension crystallization unit. Grenco [46] reported about 50 plants in commercial operation using the FM process in food industry. Some commercial applications of FM processes in the food industry are listed in Table 27.4. The commercially successful applications of this technology in the food industry have been identified. The food industry has tailored the technology in its areas of applications and has taken the advantages of the process.

**TABLE 27.4**

Applications of the Commercial FM Systems for Food Liquids

Liquid Food	Product Concentration	System	References
Fruit juice	40 ~ 55 wt%	Grenco in the United States, Japan, and Italy	[46,84,36]
Vinegar	12.8 ~ 40 wt% acid content	Girder in the United States	[111]
	up to 40 wt%	Votator	[126,127]
	48 wt%	Grenco in the United States	[128]
Beer and wine	12.5 wt%	Phillips	[36]
	32% by volume	Grenco	[128]
	fourfold	Grenco in UK	[46]
Coffee extract	35 ~ 48 wt%	Grenco in Brazil, Japan, UK, and Switzerland	[46,128]
Sugar solution	up to 50 wt%	Grenco	[128]
Whey	up to 40 wt%	CSI	[99,33]
Skim milk	up to 36 wt%	Grenco	[36,128,13]
Whole milk	up to 38 wt%	Grenco	[125,13]
Tea extract	up to 35 wt%	Grenco	[128]

---

## Acknowledgment

This chapter was written based on the report of a project funded by the Middle East Desalination Research Center, Muscat, Sultanate of Oman (Project No. 98-BS-032A).

---

## References

1. Agnew, C., Anderson, E. 1992. *Water Resources in the Arid Realm*. Routledge, London.
2. Al-Mutaz, I. 1987. Water resources development in Riyadh, Saudi Arabia. *Desalination Journal* 64: 193–202.
3. Antonelli, A. 1983. Desalinated water production at LNG-terminals. *Desalination* 45: 383–390.
4. Arora, A. P. S., Howell, J. R. 1973. An investigation of the freezing of supercooled liquid in forced turbulent flow inside circular tubes. *International Journal of Heat and Mass Transfer* 16: 2077–2085.
5. Arulampalam, G. T., Bates, C., Khaw, L. F., McGrath, L. 1981. Investigation of purification mechanism in a column crystalliser operating under total reflux and continuous conditions. *Desalination* 36: 87–97.
6. Bae, S. K., Miyawaki, O., Arai, S. 1994. Control of freezing front structure and its effect on the concentration-efficiency in the progressive freeze-concentration. *Cryobiology and Cryotechnology* 40: 29–32.
7. Bajolle, J., Rice, P. A., Barduhn, A. J. 1971. Vacuum stripping of butane from water in a packed column. *Desalination* 9: 351–366.
8. Baker, J. C., Cahn, J. W. 1969. Solute trapping by rapid solidification. *Acta Metallurgica* 17: 575–578.
9. Barduhn, A. J. 1963. Waste water renovation—Part 1. A design study of freezing and gas hydrate formation. AWTR-4, Environmental Health Series, US Department of HEW, Public Health Service, October.
10. Barduhn, A. J. 1968. The state of the crystallization processes for desalting saline waters. *Desalination* 5: 173–184.
11. Barduhn, A. J. 1968. The freezing process for water conversion in the United States. In: *Selected Papers on Desalination and Ocean Technology*. Levine, S. N., Ed. Dover, New York, p. 414.
12. Barduhn, A. J., Manudhane, A. 1979. Temperatures required for eutectic freezing of natural waters. *Desalination* 28: 233–241.
13. Basta, N., Fouhy, K. 1993. A cold solution. *Chemical Engineering* 100: 43–44.
14. Battino, R., Clever, H. L. 1966. The solubility of gases in liquids. *Chemical Review* 59: 395.
15. Bayindirli, L., Ozilgen, M., Urgan, S. 1993. Mathematical analysis of freeze concentration of apple juice. *Journal of Food Engineering* 19: 95–107.
16. Benson, S. 1960. *The Foundations of Chemical Kinetics*. McGraw-Hill, New York.
17. Bosworth, C. M., Carfagno, S. S., Sandell, D. J. 1959. Development of a direct-freezing continuous sash-separation process for saline water conversion. Office of Saline Water Research Development, Progress Report No. 23.
18. Braddock, R. J., Marcy, J. E. 1987. Quality of freeze concentrated orange juice. *Journal of Food Science* 52(1): 159–162.
19. Bransom, S. H. 1960. Factors in the design of continuous crystallisers. *British Chemical Engineering* 5: 838–844.
20. Brewster, R. A., Gebhart, B. 1994. The effects of supercooling and freezing on natural convection in seawater. *International Journal of Heat and Mass Transfer* 37(4): 543–552.
21. Brian, P. L. T. 1971. Potential advantages and development problems in water desalination by freezing. *Chemical Engineering* May: 191–197.
22. Buros, O. K. 2001. *The ABCs of Desalting*, Second Edition. International Desalination Association, MA.
23. Burton, W. R., Lloyd, A. I. 1974. Design features of secondary refrigerant freezing plants. *Desalination* 14: 151–161.
24. Chen, P. 1999. Freeze concentration of food liquids using layer crystallisers. Ph.D. thesis, University of Auckland, Auckland, New Zealand.
25. Cheng, C., Su, Y., Hopkins, D. N. 1982. Desalination by the improved vacuum freezing high pressure ice melting process. *Desalination* 42: 141–151.
26. Cheng, C. Y., Cheng, S. W. 1972. *US Patent 3690116*, issued September 12.

27. Cheng, C. Y., Chang, S. W., Cheng, W. C. 1980. *US Patent 4235382*, issued December 1.
28. Cheng, C. Y., Cheng, W. C., Yang, M. D. 1987. The vacuum freezing multiple phase transformation process. *Desalination* 67: 139–153.
29. Chowdhury, J. 1988. CPI warmup to freeze concentration. *Chemical Engineering* 95(6): 24.
30. Colten, S. L., Lin, F. S., Tsao, T. C., Stern, S. A., Barduhn, A. J. 1972. Hydrolysis losses in the hydrate desalination process, rate measurement and economic analysis. *Desalination* 11: 31.
31. Curran, H. M. 1970. Water desalination by indirect freezing. *Desalination* 7: 273–284.
32. Dallmer, M. F., Dickey, L. C., Radewonuk, E. R. 1998. Horizontal cross flow filtration and rinsing of ice from saline slurries – has a slurry inlet, a filter plate with two slotted sections, a heater, and two pumps to induce flow through the slots, *US Patent 5816057*.
33. Davis, H. E. 1983. The Status of Freeze Crystallization as an Industrial Separation Process, *Bulletin. Concentration Specialists, Inc.*, Andover, MA.
34. Denton, W. H., Smith, M. J. S., Klaschka, J. T., Forgan, R., Diffey, H. R., Rumary, C. H., Dawson, R. W. 1974. Experimental studies on washing and melting ice crystals in the immiscible refrigerant freezing process. *Desalination* 14: 263–290.
35. Depew, C. A., Zenter, R. C. 1969. Laminar flow heat transfer and pressure drop with freezing at the wall. *International Journal of Heat and Mass Transfer* 12: 1710.
36. Deshpande, S. S., Cheryan, M., Sathe, S. K., Salunkhe, D. K. 1984. Freeze concentration of fruit juices. *CRC Critical Review Food Science and Nutrition* 20(3): 173.
37. Dickey, L. C. 1996. Evaporation of water from agitated freezing slurries at low pressure. *Desalination* 104: 155–163.
38. Dickey, L. C., Craig, J. C. 1990. Determination of a liquid state from that of liquid solution coupled to it by a common vapor phase. *Desalination* 78: 397–401.
39. Dickey, L. C., Craig, J. C., Radewon, E. R., McAloon, A. J., Holsing, V. H. 1995. Low temperature concentration of skim milk by direct freezing and vacuum evaporation. *Journal of Dairy Science* 78: 1369–1377.
40. El-Nashar, A. 1984. Solar desalination using the vacuum freezing ejector absorption (VFEA) process. *Desalination* 49: 293–319.
41. Ettouney, H. M., El-Dessouky, H. T., Alatiqi, I. 1999. Understand thermal desalination. *Chemical Engineering Progress* 95(9): 43–54.
42. Fernandez, R., Pangborn, J. B., Colten, S. L., Barduhn, A. J. 1968. OSW Progress Reports No. 230 and 333, Syracuse University.
43. Garabedian, H., Strickland-Constable, R. F. 1974. Collision breeding of ice crystals. *Journal of Crystal Growth* 22: 188–192.
44. Gibson, W., Emmermann, D., Grossman, G., Johnson, R., Modica, A., Pallone, A. 1974. Spray freezer and pressurized counter washer for freeze desalination. *Desalination* 14: 249–262.
45. Gouw, T. H. 1968. Normal freezing. In: *Progress in Separation and Purification*. Vol. 1. Perry, E. S., Ed. Wiley, New York, pp. 57–82.
46. Grenco. 1990. Freeze concentration, internal report. *Brewers' Guardian*.
47. Grenco. 1991. Current large-scale commercial application of freeze concentration in the food industry. PR-VA-21, Publication from the technical library of Grenco Process Technology, The Netherlands.
48. Hahn, W. J., Burns, R. C., Fullerton, R. S., Sandell, D. J. 1964. OSW R&D Progress Report N. 113, US Department of Interior, Washington, DC.
49. Hanafi, A. 1994. Desalination using renewable energy sources. *Desalination* 97: 339–352.
50. Hartel, R. W. 1992. Evaporation and freeze concentration. In: *Handbook of Food Engineering*. Heldman, D. R., Lund, D. B., Eds. Marcel Dekker, New York, pp. 341–392.
51. Hartel, R. W., Chung, M. S. 1993. Contact nucleation of ice in fluid dairy products. *Journal of Food Engineering* 18: 281–296.
52. Hassan, A. M., Al-Sofi, M. A., Al-Amoudi, A., Jamaluddin, T. M., Dalvi, A. G. I., Kitner, N. M., Mustafa, G. M., Al-Tisan, I. A. 1998. A new approach to membranes and thermal seawater desalination processes using nanofiltration membranes: Part 1. *The International Desalination and Water Reuse Quarterly* 8(1): 53–59.
53. Hassence, M. 1993. MSC offers purity advantages. *Asia-Pacific Chemicals* 10: 30–32.
54. Heist, J. A. 1979. Freeze crystallization. *Chemical Engineering* 86(10): 72–82.
55. Hittman Associates. 1969. Vacuum freezing vapor compression desalting state-of-the-art. Office of Saline Water, Research Development Progress Report No. 491.

56. Hubbard, D. S., Leinroth, J. P., Wiegandt, H. F. 1968. Spray freezing of brine with an immiscible refrigerant. Report to OSW on Control No. 1141, Cornell University.
57. Huige, N. J. J., Thijssen, H. A. C. 1972. Production of large crystals by continuous ripening in a stirred tank. *Journal of Crystal Growth* 13/14: 483–487.
58. Hunken, I., Ozoguz, Y., Ulrich, J. 1991. A new apparatus for a continuous directed crystallization process. In: *Proceedings BIWIC 1991*, Ulrich, J., Ed. Aachen, Verlag Mainz, pp. 42–49.
59. Jancic, S. J., Ehrsam, C. 1988. Kristallsationsvorrichtung und deren verwendung. Patent Application, Switzerland CH667816.
60. Janzow, E. F., Chao, B. T. 1973. Salt entrainment in ice crystallized from brine. *Desalination* 12: 141–161.
61. Janzow, E. F., Chao, B. T. 1973. Induced crystallization of large free ice crystals in slowly flowing brine. *Desalination* 12: 163–175.
62. Johnson, C. A., Moore, S. J., Wagman, N. D., Sandell, D. J. 1967. Freezing process using R-C318. OSW Progress Report No. 256.
63. Johnson, W. E. 1976. State-of-the-art of freezing processes, their potential and future. *Desalination* 19: 349–358.
64. Johnson, W. E. 1979. Indirect freezing. *Desalination* 31: 417–425.
65. Kobayashi, T. 1991. Freeze concentrations and their application. *Reitou* 66: 1008–1018.
66. Koretchko, J., Hafela, G. 1971. Bench-scale study of the vacuum freezing ejector absorption process. Office of Saline Water, Research Development, Progress Report No. 744.
67. Kreshneck, G. C., Schneider, H., Scherage, H. A. 1965. *Journal of Physical Chemistry* 69: 3132.
68. Kurnik, R. T., Barduhn, A. J. 1978. Thermodynamic properties of normal butane at refrigeration temperatures. *Desalination* 26: 211–283.
69. Landau, M., Martindale, A. 1967. Assessment of crystallization designs for a butane freeze desalination process. *Desalination* 3: 318.
70. Liang, B., Shi, Y., Hartel, R. W. 1999. Freeze concentration of aqueous solutions with high efficiency. *IFT Annual Meeting*, July 1999, Chicago, IL.
71. Liu, L., Miyawaki, O., Hayakawa, K. 1999. Progressive freeze-concentration of tomato juice. *Food Science and Technology research* 5(1): 108–112.
72. Liu, L., Miyawaki, O., Nakamura, K. 1997. Progressive freeze-concentration of model liquid food. *Food Science and Technology International Tokyo* 3(4): 348–352.
73. Lloyd, A. I. 1977. An integral design for desalination plant using the secondary refrigerant freeze process. *Desalination* 21: 137–146.
74. Lock, G. S. H., Nyren, R. H. 1971. Analysis of fully developed ice formation in a convectively cooled circular tube. *International Journal of Heat and Mass Transfer* 14: 825.
75. Lupu, D. M. 1979. The dynamics of sea water desalting through zone-freezing. *Desalination* 31: 415.
76. Maguire, J. B. 1987. Fresh water from the sea, a new process. *Desalination* 67: 155–162.
77. Matsuda, A., Kawasaki, K. 1997. Concentration and separation of impurities in liquid by freezing with supersonic radiation. *Journal of Chemical Engineering of Japan* 30(5): 825–830.
78. Matusevich, L. N., Blinova, N. P. 1964. Isohydic crystallization at different solution cooling rates. *Journal of Applied Chemistry of the USSR* 37(10): 2310–2314.
79. McCausland, I. J., Cains, P. W., Martin, P. D. 2001. Use the power of sonocrystallization for improved properties. *Chemical Engineering Progress* 97(7): 56–61.
80. McKay, D. L. 1970. Crystal separation and purification, *US Patent 3487652*.
81. Michaels, A. S., Brian, P. L. T., Sperry, P. R. 1966. Impurity effects on the basal plane solidification kinetics of supercooled water. *Journal of Applied Physics* 37(13): 4649–4661.
82. Miyawaki, O., Liu, L., Nakamura, K. 1998. Effective partitioning constant of solute between ice and liquid phases in progressive freeze-concentration. *Journal of Food Science* 63(5): 756–758.
83. Miyawaki, O., Liu, L., Shirai, Y., Sakashita, S., Kagitani, K. 2005. Tubular ice system for scale-up of progressive freeze-concentration. *Journal of Food Engineering* 69: 107–113.
84. Muller, J. G. 1967. Freeze concentration of liquids: theory, practice and economics. *Food Technology* 21: 49–60.
85. Muller, M., Sekolov, I. 1992. Waste water reuse by freeze concentration with a falling film reactor. *Water Science and Technology* 26(7,8): 1475–1482.
86. Nebbia, G., Menozzi, G. N. 1968. Early experiments on water desalination by freezing. *Desalination* 5: 49–54.

87. Omran, A. M., King, C. J. 1974. Kinetics of ice crystallization in sugar solutions and fruit juices. *AIChE Journal* 20: 795–803.
88. Orcutt, J. C., Hale, F. J. 1970. The secondary refrigerant freezing process: a modeling study. *Desalination* 7: 201–227.
89. Ozisik, M. N., Mulligan, J. C. 1969. Transient freezing of liquids in forced flow inside circular tubes. *Journal of Heat Transfer* 91: 385.
90. Pachtter, M., Barak, A. 1967. The vacuum freezing vapor compression (Zarchin) process present status and future trends. *Desalination* 2: 358–367.
91. Pangborn, J. B. 1963. Observations of the eutectic freezing of salt solutions. Report to A. J. Barduhn, Syracuse University, Department of Chemical Engineering.
92. Pruppacher, H. R. 1967. Interpretation of experimentally determined growth rates of ice crystals in supercooled water. *The Journal of Chemical Physics* 47(5): 1807–1813.
93. Pruppacher, H. R. 1967. Some relations between the structure of the ice–solution interface and the free growth rate of ice crystals in supercooled aqueous solutions. *Journal of Colloid and Interface Science* 25: 285–294.
94. Ratkje, S. K., Flesland, O. 1995. Modeling the freeze concentration process by irreversible thermodynamics. *Journal of Food Engineering* 25: 553–567.
95. Rice, W., Chau, D. S. C. 1997. Freeze desalination using hydraulic refrigerant compressors. *Desalination* 109: 157–164.
96. Rittner, S., Steiner, R. 1985. Die schmelzkristallization von organischen stoffen und ihre grobtechnische anwendung. *Chemie Ingenieur Technik* 57(2): 91–102.
97. Rosen, J. 1990. Freeze concentration beats the heat. *Mechanical Engineering* 112(12): 46–50.
98. Roux, G. 1968. M. S. thesis, Syracuse University.
99. Saal, H. 1980. Freezing can cut whey concentration cost 45%. *Food Processing* December: 62–63.
100. Schroeder, P. J., Chan, A. S., Khan, A. R. 1977. Freezing processes—the standard of the future. *Desalination* 21: 125–136.
101. Schroeder, P. J. 1980. Freezing processes—the standard of the future—an update. *Desalination* 33: 299–310.
102. Schwartzberg, H. G. 1977. Energy requirement for liquid food concentration. *Food Technology* 31(3): 67–76.
103. Shimoyamada, M., Shibata, M., Ishikawa, K., Asanuma, K., Watanabe, K. 1997. Preparation of large ice crystals by controlling the difference between solution and coolant temperatures, and its application to freeze concentration. *Nippon Shokuhin Kogaku Kaishi* 44: 59–61.
104. Shirai, Y., Nakanishi, K., Matsuno, R., Kamikubo, T. 1985. Effects of polymers on secondary nucleation of ice crystals. *Journal of Food Science* 50: 401–406.
105. Shirai, Y., Sugimoto, T., Hashimoto, M., Nakanishi, K., Matsuno, R. 1987. Mechanism of ice growth in a batch crystallizer with an external cooler for freeze concentration. *Agricultural Biology and Chemistry* 51: 2359–2366.
106. Shwartz, J., Probststein, R. F. 1968. An analysis of counterwashers for freeze-distillation desalination. *Desalination* 4: 5–29.
107. Shwartz, J., Probststein, R. F. 1969. Experimental study of slurry separators for use in desalination. *Desalination* 6: 239–266.
108. Simpson, H. C., Beggs, G. C., Nazir, M. 1974. Evaporation of butane drops in brine. *Desalination* 15: 11–23.
109. Singh, R., Tembrock, J. 1999. Effectively control reverse osmosis systems. *Chemical Engineering Progress* 95(9): 57–64.
110. Smith, C. E., Schwartzberg, H. G. 1985. Ice crystal size changes during ripening in freeze concentration. *Biotechnology Progress* 1(2): 111–120.
111. Staff, F. E. 1961. Continuous process freeze-concentrates vinegar. *Food Engineering* March: 82–83.
112. Stepakoff, G. L., Modica, A. P. 1973. The hydrolysis of halocarbon refrigerants in freeze desalination processes. *Desalination* 12: 85–105.
113. Stepakoff, G. L., Modica, A. P. 1973. The hydrolysis of halocarbon refrigerants in freeze desalination processes, Part II: Theoretical prediction of hydrolysis rates and comparison with experimental data. *Desalination* 12: 239–250.



114. Stepakoff, G. L., Siegelman, D., Johnson, R., Gibson, W. 1974. Development of a eutectic freezing process for brine disposal. *Desalination* 14: 25–38.
115. Swinkels, W. J. 1985. Recent developments in freeze concentration. *New Dairy Products via New Technology Proceedings of IDF Seminar*. Georgia World Congress Centre, October, Atlanta, USA, pp. 173–187.
116. Tavare, N. S. 1987. Simulation of Ostwald ripening in a reactive batch crystallizer, *AIChE Journal* 33: 152–156.
117. Thampy, S. K., Rangarajan, R., Indusekhar, V. K. 1999. 25 years of electrodialysis experience at Central Salt and Marine Chemicals Research Institute Bhavnagar, India. *The International Desalination and Water Reuse Quarterly* 9(2): 45–49.
118. Thijssen, H. A. C. 1969. Freeze concentration of food liquids. *Food Manufacture* 44(7): 49–54.
119. Thijssen, H. A. C. 1970. Freeze concentration of food liquids. *Proceedings SOS/70*, 3rd International Congress of Food Science and Technology, Washington, DC, p. 491.
120. Thijssen, H. A. C. 1974. Freeze concentration. In: *Advances in Preconcentration and Dehydration of Foods*, Spicer, A., Ed. Wiley, New York, pp. 115–149.
121. Thijssen, H. A. C. 1975. Apparatus for separation and treatment of solid particles from a liquid suspension, *US Patent 3872009*.
122. Thijssen, H. A. C. 1975. Current developments in the freeze concentration of liquid foods. In: *Freeze Drying and Advanced Food Technology*. Goldblith, S. A., Rey, L., Rothmayr, W. W., Eds. Academic Press, New York.
123. Tuchida, I. 1967. Hydrate formation in i-butane, n-butane, or a butane isomer water system at a given temperature. *Desalination* 3: 373–377.
124. UNEP. 1996. *Groundwater: A Threatened Resource*. UN Environment Program, Nairobi, Kenya.
125. van Mil, P. J. J. M., Bouman, S. 1990. Freeze concentration of dairy products. *Netherlands Milk and Dairy Journal* 40: 21–31.
126. Votator. 1965. Votator “cleanwall” scraped surface heat exchanger. *Technical Bulletin 7*, Votator Division, Chemetron Corp., Louisville, KY.
127. Votator. 1965. Votator continuous freeze concentration process. *Process Bulletin 153-345C*, 02.1265, Votator Division, Chemetron Corp., Louisville, KY.
128. Wagner, J. N. 1983. Improvement in freeze concentration. *Food Engineering* 55: 98.
129. Wangnick, K. 2004. IDA worldwide desalting plants inventory. Report No. 18. Wangnick Consulting, Germany.
130. Wankat, P. C. 1973. Desalination by natural freezing. *Desalination* 13: 147–157.
131. Watanabe, M., Arai, S. 1987. Freezing of water in the presence of the ice nucleation active bacterium, *Erwinia ananas*, and its application for efficient freeze-drying of foods. *Agricultural Biology and Chemistry* 51: 557–563.
132. Wiegandt, H. F., Madani, A., Harriott, P. 1987. Ice crystallization developments for the butane direct-contact process. *Desalination* 67: 107–126.
133. Wiegandt, H. F., Von Berg, R. L. 1980. Myths about freeze desalting. *Desalination* 33: 287–297.
134. Zerkle, R. D., Sunderland, J. E. 1968. The effect of liquid solidification in a tube upon laminar-flow heat transfer and pressure drop. *Journal of Heat Transfer* 90: 183.

---

## *Microwave Pasteurization and Sterilization of Foods*

---

Jasim Ahmed and Hosahalli S. Ramaswamy

### CONTENTS

28.1	Introduction .....	692
28.2	Principles of Microwave Heating.....	692
	28.2.1 Microwave Generation.....	693
28.3	Advantages of Microwave Heating .....	693
28.4	Factors Affecting Microwave Heating .....	694
	28.4.1 Frequency.....	694
	28.4.2 Dielectric Properties.....	694
	28.4.3 Moisture Content .....	695
	28.4.4 Mass .....	695
	28.4.5 Temperature .....	695
	28.4.6 Geometry and Location of Foods .....	695
	28.4.7 Thermal Properties.....	696
	28.4.8 Secondary Flow in Curved Pipe .....	696
28.5	Industrial Applications of Microwave Heating .....	696
	28.5.1 Tempering of Fish, Meat, and Poultry.....	697
	28.5.2 Precooking of Bacon .....	697
	28.5.3 Cooking Sausage .....	697
	28.5.4 Baking .....	698
	28.5.5 Drying .....	698
	28.5.6 Blanching of Vegetables.....	698
	28.5.7 Microwave Effects on Enzyme .....	699
	28.5.8 Puffing and Foaming .....	699
	28.5.9 Concentration.....	699
28.6	Recent Development in Microwave Food and Packaging .....	699
28.7	Microwave Pasteurization and Sterilization .....	699
28.8	Kinetics of Microbial Destruction .....	700
	28.8.1 Come-Up Time and Come-Down Profile Corrections .....	701
	28.8.2 Microwave Heating Systems .....	701
	28.8.2.1 Batch Heating .....	701
	28.8.2.2 Continuous-Flow Heating .....	702
	28.8.3 Application to Food Systems.....	702
	28.8.3.1 Milk.....	702
	28.8.3.2 Effect on Milk Nutrients .....	703
	28.8.3.3 Effect on Microbial Inactivation.....	704
	28.8.3.4 Fruit Juices .....	704
	28.8.3.5 Ready-to-Eat Meals .....	705
28.9	Sterilization Systems .....	705
28.10	Marker Formation as an Index of Microwave Sterilization .....	707
28.11	Limitations and Future of Microwave Heating .....	708
28.12	Recommendations for Microwave Pasteurization and Sterilization .....	708
28.13	Conclusions .....	709
	References .....	709

---

## 28.1 Introduction

Thermal processing has been a major processing technology in the food industry ever since the discovery of the process by Nicholas Appert and its subsequent commercialization. The purpose of thermal processing was to extend the shelf life of food products without compromising food safety. Various thermal treatments such as pasteurization and sterilization can be selected on the basis of severity of the heat treatment and the intended purpose [1]. Apart from inactivation of pathogens, thermal treatment can also result in some other desirable changes, such as protein coagulation, texture softening, and formation of aromatic components. However, the process has also got some limitation by way of partial destruction of quality attributes of food products, especially heat-labile nutrients, and sensory attributes. The technological revolution, nutritional awareness, and continuous demand of the new generation have necessitated search for new or improved food processing technologies. Presently, several new food processing technologies, including microwave and radio frequency heating, pulse-electric field treatment, high-pressure processing, ultrasonic applications, irradiation, and oscillating magnetic fields, are being investigated to improve, replace, or complement conventional processing technology.

Microwave heating of foods is attractive due to its volumetric origin, rapid increase in temperature, controllable heat deposition, and the easy clean-up opportunities. It is currently being used for a variety of domestic and industrial food preparations and processing applications. It has been used successfully for finish drying of potato chips, precooking of chicken and bacon, proofing and frying doughnuts, tempering of frozen foods, and drying pasta products. Microwave processing for fresh filled pasta has become common in Italy since the 1990s, and the technology has been applied to ready-to-eat meals, pasta-based products, and a variety of other foods throughout Europe, Japan, and South America [2]. Recently, microwaves have been used to heat foods in commercial pasteurization and sterilization applications to enhance microbial destruction and promote better product quality. Some European and Japanese food processing companies have utilized the technology for commercial pasteurization and sterilization of foods, while their North American counterparts have been still hesitating to accept these processes [3].

Microwave heating is preferred for pasteurization and sterilization over the conventional heating for the basic reason that the process is fast and requires minimum come-up time (CUT) to the desired process temperature. To process liquid foods, high-temperature short-time (HTST) processes have been accepted by the food processing industry to reduce the adverse thermal degradation in food quality while ensuring food safety [4]. However, the HTST process is not suitable for solid foods processed by conventional methods due to slow heat conduction, which often causes overheating at the solid surface during the time needed for the heat to be transferred to the slowest heating point of the food [4,5]. Microwave heating has the advantage to overcome the limitation imposed by the slow thermal diffusion process of conventional heating [5]. The volumetric heat generated by microwaves can significantly reduce the total heating time and severity at the elevated temperatures needed for commercial sterilization [6] whereby bacterial destruction is enhanced, but thermal degradation of the desired components is reduced.

Study of the destruction kinetics of microorganisms by microwave heating has had considerable interest since the 1940s when the first work by Fleming [7] was reported and the argument between nonthermal and thermal effects was born. Several theories have been proposed to explain how electromagnetic fields might kill microorganisms without heat as summarized in a review by Knorr [8]. On the contrary, some researchers [9] refute any molecular effects of electric fields compared with thermal energy using classical axioms of physics and chemistry. Palaniappan and Sastry [10] advocated that the effects of microwave and dielectric heating are clearly the fields where there is a knowledge gap, and further studies are needed.

---

## 28.2 Principles of Microwave Heating

Microwaves are electromagnetic radio waves that are within a frequency band of 300 MHz to 300 GHz. Microwave heating refers to dielectric heating due to polarization effects at a selected frequency band in a nonconductor. It differs from capacitive heating by the placement of sample. In capacitive heating the sample is placed between the electrodes, while the food material is commonly housed inside a closed cavity in the microwave heating. Microwave heating applications have been limited to a few narrow frequency bands (Table 28.1) for industrial, scientific, and medical use to avoid interference with the

**TABLE 28.1**

Frequencies Assigned by the Federal Communications Commission for Industrial, Scientific, and Medical Use

Frequency
13.56±6.68 kHz
27.12±160 kHz
40.68±20 kHz
915±25 MHz
2450±50 MHz
5800±75 MHz
24125±125 MHz

radio frequencies used for telecommunication purposes. The typical bands are  $915 \pm 25$  MHz and  $2450 \pm 50$  MHz with penetration depths ranging from 8 to 22 cm at 915 MHz and 3–8 cm at 2450 MHz depending on the moisture content [6]. The latter, in particular, is used more often in domestic microwave ovens while both frequencies are used for industrial purposes. It is worthwhile to note that outside of the United States, frequencies of 433.92, 896, and 2375 MHz are also used.

Microwave heating in foods occurs due to coupling of electrical energy from an electromagnetic field in a microwave cavity with the food and its

subsequent dissipation within food product. This results in a sharp increase in temperature within the product. Microwave energy is delivered at a molecular level through the molecular interaction with the electromagnetic field, in particular, through molecular friction resulting from dipole rotation of polar solvents and from the conductive migration of dissolved ions [11]. The principal mechanisms involved in microwave heating are therefore dipole rotation and ionic polarization. Water in the food is the primary dipolar component responsible for the dielectric heating. In an alternating current electric field, the polarity of the field is varied at the rate of microwave frequency and molecules attempt to align themselves with the changing field. Heat is generated rapidly as a result of internal molecular friction. The second major mechanism of heating with microwaves is through the polarization of ions as a result of the back and forth movement of the ionic molecules trying to align themselves with the oscillating electric field. Microwave heating is also affected by the state of the constituents, whether they are bound or free, e.g., bound ions have much lower microwave absorptivities [12,13].

The volumetric heating rate ( $Q$ ) of microwave at a particular location is related to the electric field strength by

$$Q = 2\pi f \epsilon_0 \epsilon'' E^2 \quad (28.1)$$

where  $f$  is the frequency of microwaves,  $E$  the strength of electric field of the wave at that location,  $\epsilon_0$  the permittivity of free space (a physical constant), and  $\epsilon''$  the dielectric loss factor (a material property called dielectric property) representing the material's ability to absorb the wave. In addition to  $\epsilon''$ , there is another dielectric property parameter called the dielectric constant ( $\epsilon'$ ), which affects the strength of the electric field inside the food.

### 28.2.1 Microwave Generation

The magnetron is the heart of the microwave oven. Microwaves are generated by a magnetron, which is attached to the applicator controlled by a waveguide. The magnetron consists of the two elements of an electron tube—a cathode and an anode—each of which is in a circular form with anode resonant cavities (anywhere from four to eighty). A magnet (permanent or temporary) is placed around the anode to provide a magnetic field. When the cathode is heated by means of an electrical filament, it gives off negatively charged electrons, which are attracted by the positively charged anode. The magnetic field around the anode causes the electrons to move in an orbital fashion rather than a straight line as they jump from the cathode to the anode under an electrical pressure of 4000–6000 volts. As the electrons approach the anode, they pass by the resonator cavities of the anode, and this causes the electrons to oscillate at a very high frequency (2450 or 915 MHz). The high-frequency oscillations of the electrons in the magnetron are picked up by a small antenna on the top the magnetron tube. These oscillations are transmitted through a waveguide to a feed box from where they are distributed into the oven cavity.

## 28.3 Advantages of Microwave Heating

Microwave has been successfully used to heat, dry, and sterilize many food products. Compared with conventional methods, microwave processing offers the following advantages: (i) microwave penetrates

inside the food materials and, therefore, cooking takes place throughout the whole volume of food internally, uniformly, and rapidly, which significantly reduces the processing time and energy; (ii) since the heat transfer is fast, nutrients and vitamins contents, as well as flavor, sensory characteristics, and color of food are well preserved; (iii) ultrafast pasteurization or sterilization of pumpable fluids minimizes nutrient, color, and flavor losses; (iv) minimum fouling depositions, because of the elimination of the hot heat transfer surfaces, since the piping used is microwave transparent and remains relatively cooler than the product; (v) high heating efficiency (80% or higher efficiency can be achieved); (vi) perfect geometry for clean-in-place (CIP) system; (vii) suitable for heat-sensitive, high-viscous, and multiphase fluids; (viii) low cost in system maintenance; (ix) heating is silent and does not generate exhaust gas; (x) flat radial temperature profile for most products; and (xi) can be combined with other technologies, such as regenerative heat exchangers and infrared heating for better process performance.

## 28.4 Factors Affecting Microwave Heating

Some physical, thermal, and electrical properties determine the absorption of microwave energy and simultaneous heating behavior of food materials in microwave processing. These properties/factors are briefly discussed below.

### 28.4.1 Frequency

For food application, only two frequencies are allocated for microwave heating (915 and 2450 MHz) and, therefore, these frequencies are of special interest. The corresponding wavelengths of these frequencies are 0.328 and 0.122 m, respectively. The wavelength has special significance as most interactions between the energy and materials take place in that region and generate instantaneous heat due to molecular friction. Food constituents except moisture, lipids, and ash are relatively inert to prescribed microwave frequencies. In addition, frequency (or wavelength) dictates equipment components such as magnetron, waveguide, and to some extent heating volume.

### 28.4.2 Dielectric Properties

The electrical properties of materials in the context of microwave and radiofrequency heating are known as dielectric properties, which provide a measure of how food materials interact with electromagnetic energy. Biological materials may be viewed as nonideal capacitors in that they have the ability to store and dissipate electrical energy from an electromagnetic field and the properties can be expressed in terms of a complex notation. The complex notation is characterized by dielectric permittivity with a real component, dielectric constant, and an imaginary component, dielectric loss [13]. The dielectric properties of materials are governed by the following equations:

$$\varepsilon = \varepsilon' - j\varepsilon'' \quad (28.2)$$

$$\tan \delta = \frac{\varepsilon''}{\varepsilon'} \quad (28.3)$$

where  $\varepsilon'$  is the dielectric constant,  $\varepsilon''$  the dielectric loss factor of the material, and  $j$  the complex constant. The dielectric constant is a measure of a material's ability to store electric energy, and the loss factor is a measure of its ability to dissipate the electrical energy in the form of heat. Complex permittivity is a measure of a material's ability to couple electrical energy from a microwave power generator (magnetron). The dielectric properties of materials mostly govern the heating behavior of food materials during microwave heating. The power dissipated per unit volume in the dielectric field is directly related to loss factor (Equation 28.1); however, it may also be dependent on the dielectric constant subject to geometry and field configuration [14]. The ratio of the dielectric loss to the dielectric constant, defined as the loss tangent (Equation 28.3), is related to the material's susceptibility to be penetrated by an electrical field and dissipate (attenuate) electrical energy as heat. Materials are classified on the basis of loss tangent. Those that are highly lossy absorb microwave energy efficiently, while highly transparent materials, such as Teflon, glass, and kerosene, have low loss factors.

### 28.4.3 Moisture Content

The moisture content significantly affects the dielectric properties of the food product and consequently the penetration depth of the microwave. Uneven heating rate is observed in high-moisture foods because of low microwave penetration depth. Low-moisture foods will have more uniform heating rate because of the deeper microwave penetration [15]. The initial moisture content of the product and the rate of moisture evaporation play important roles during microwave heating. The heating behavior of water is phase dependent (liquid water versus solid ice phase) and also depends on the available free water content. At constant temperature, the dielectric behavior of free water remains constant in the lower frequency range (static region) and water dipoles have enough time to reorient themselves with not much absorption of energy, while a significant decrease in dielectric behavior can be observed at the higher frequency (optical region) with no field reversal by the water dipoles. Dielectric constant decreases exponentially with frequency (critical frequency) in between the static and optical regions. Phase change results in a significant change in the dielectric properties and, therefore, these properties for water and ice largely differ in their magnitude.

### 28.4.4 Mass

A direct relationship exists between the mass and the amount of absorbed microwave power, which should be applied to achieve the desired heating. For a smaller mass, batch oven is suitable, while a larger throughput would often be better in large capacity conveyorized equipment. Such equipment have the added advantage of providing greater heating uniformity by moving the product through the microwave field. Each microwave oven has a critical (minimum) sample mass for its efficient operation. It is usually around 250 mL water load in a 1 kW oven. Below this level, significant amount of microwave power is not absorbed into the product, and at very low loads they may damage the magnetron.

### 28.4.5 Temperature

Microwave heating is significantly affected by the level of sample temperature. Dielectric properties may vary with temperature, depending upon the material. Both temperature and moisture content can change during heating and, therefore, those may have a combined effect on the dielectric constant, dielectric loss factor, loss tangent, and subsequently on the heating behavior. Freezing has a major effect on a material's heating ability because of the vastly different dielectric properties of ice and water. Water has significantly higher magnitudes of dielectric constant and loss as compared to ice, and these properties are also dependent on the microwave frequency [16].

The initial temperature of the food product being heated by microwaves should either be controlled or known, so that the microwave power can be adjusted to obtain uniform final temperatures. If the microwave oven is preset to increase the product temperature from 20°C to 80°C, it will practically reach a target temperature of 95°C with an initial product temperature of 35°C. To compensate the effect of higher initial temperature, the power of MW oven should be reduced or a higher sample mass should be used or the product should be heated for a shorter duration.

### 28.4.6 Geometry and Location of Foods

The shape of the food product does play an important role in the distribution of heat within the product heated in a microwave oven. It affects the depth of microwave penetration, and the heating rate and uniformity. Irregular-shaped products are subjected to nonuniform heating due to the difference in product thickness [15]. The closer the size (thickness) is to the wavelength, the higher will be the center temperature. Smaller particulates require less heat than larger ones. In addition, the more regular the shape, the more uniform will be the heat distribution within the product. A food of a spherical or cylindrical shape heats more evenly than a square. A higher surface-to-volume ratio enhances the heating rate. Therefore, the heating rate for a sphere will be different from that of a cylinder with the same volume. The relationship between load geometry, load orientation, and oven cavity parameters such as cavity size and geometry, however, is not fully established. For most foods, size and geometry in combination with energy of a relatively small wavelength such as 2450 MHz would result in nonhomogeneous but

predictable heating profiles. Recently, it has been advocated that microwave heating uniformity of multicomponent foods is dependent on food component, placement, and geometry of products and packages [17]. Placement has the most significant effect. The temperature distribution could be balanced partly by taking advantage of edge and corner heating intensification.

#### 28.4.7 Thermal Properties

The heating characteristics of foods are dependent to a greater or lesser extent on some thermal properties such as thermal conductivity, density, and heat capacity. Thermal conductivity of food plays a significant role in microwave heating. Materials with higher thermal conductivity dissipate heat faster than the ones with lower conductivity during microwave heating. Food with high thermal conductivity will take lesser time to attain uniform temperature during holding period. The thermal conductivity of frozen food is higher due to high thermal conductivity of ice, while freeze-dried foods have lower thermal conductivity. Heat capacity of food measures the temperature response of food as a result of heat input or removal. Heat capacity can be raised by increasing solid content by adding components like salt and protein. Heat capacity along with thermal conductivity and thermal diffusivity constitutes thermal properties of the material. Combination of heat capacity with thermal conductivity and density is represented by thermal diffusivity, defined as the ratio of thermal conductivity to the product's volumetric heat capacity

$$\alpha = \frac{k}{\rho c_p} \quad (28.4)$$

#### 28.4.8 Secondary Flow in Curved Pipe

Thermal processing requires the coldest point to experience a target minimum temperature for a specified residence time. The coldest point in a continuous-flow process is the region where fluids exhibit the maximum velocity, which is the central axial position in a straight tube. The maximum velocity can vary in a helical coil; therefore, the flow characteristics should be determined. The use of helical coils creates a secondary flow due to the momentum transfer in the radial direction, which ensures better mixing and stabilizes the laminar flow [18]. Dean number (De) quantifies this phenomenon and therefore is the dimensionless parameter to characterize flow in helical coils [18].

$$De = Re \sqrt{D_{\text{tube}}/D_{\text{coil}}} \quad (28.5)$$

$$Re = \frac{VD_{\text{tube}}\rho}{\mu} \quad (28.6)$$

where Re is the Reynolds number,  $\rho$  the density of the fluid,  $\eta$  the viscosity of the fluid,  $D_{\text{tube}}$  the inside diameter of tube, and  $D_{\text{coil}}$  the coil diameter. The secondary flow enhances heat and mass transfer rates in addition to the rate of momentum transfer, the latter one resulting in an increased pressure drop [18]. The heat transfer rates are found to increase by few percentage to several-fold in a helical coil; however, they are a function of the types of flow regime (laminar or turbulent), fluid properties, and helix configuration. Recently, the concept of Dean number has been used in microwave heating of fluid foods and Dean number exceeding 100, normally exhibiting a plug-flow behavior, has been found to be suitable for heating liquids in a microwave oven where fluid particles with maximum velocity span across most of the tube [19].

---

### 28.5 Industrial Applications of Microwave Heating

The major industrial applications of microwave heating are tempering of frozen meat and poultry products; precooking of bacon for foodservice; sausage cooking; drying of various foods; baking of bread, biscuit, and confectionery; thawing of frozen products; blanching of vegetables; heating and sterilizing of fast food, cooked meals, and cereals; and pasteurization and sterilization of various foods. Brief accounts of individual applications are given below followed by a detailed account on pasteurization and sterilization applications.

### 28.5.1 Tempering of Fish, Meat, and Poultry

The largest use of industrial microwave processing of food has been for tempering of meat for further processing [3]. Microwave tempering is the process where the temperature of the product is raised from storage temperature (generally below  $-18^{\circ}\text{C}$ ) to a temperature just below freezing point.

In meat processing industry, the meat used is usually obtained in thick frozen blocks below  $-18^{\circ}\text{C}$ . The first operation on the frozen meats usually is to dice, slice, or separate individual sections into smaller pieces. The mechanical operation requires that the blocks be tempered from their solid frozen state to a point where cutting or separation can be carried out easily without damage to the product. Conventional tempering techniques either with water or air, subject the outer surfaces of the product bulk to warmer temperatures for long periods, for the heat to penetrate to the center. This results in large temperature gradients. In addition, the conventional tempering process takes a long time (several days) with considerable drip loss especially resulting in loss of protein, which represents an economic loss. Microwaves can easily penetrate the whole frozen product, thus effectively reaching the inner regions within a short time. The microwave tempering can be performed in few minutes for a large amount of frozen products (5–10 min for 20–40 kg). The temperature to which a product must be tempered depends upon the type of cutting, slicing, and chopping, and also upon product compositions such as the combinations of water, salts, proteins, and fats.

As microwaves are absorbed by the material, its intensity is attenuated by the penetration depth. Surface layers retain more energy and heat up faster compared to the inner regions of the product. The loss factor increases with the temperature, the product surface heats up faster and faster, and the penetration depth simultaneously decreases. The lower frequency (915 MHz band) has an advantage for tempering of thick products because of its deeper penetration and longer wavelength compared to the higher frequency (2450 MHz) microwave. Presently, most food industries use microwave at 915 MHz for tempering purposes except where the law does not permit the use of this frequency. Tempering of frozen foods is carried out either in batch- or continuous-type microwave system (25–120 kW). Presently, manufacturers design the system as per customers' choice, type of food products, and applications. The process has been successfully used by meat, fish, and poultry industries for further processing while the dairy industry has exploited the technology to reduce the chances of rancidity during bulk freezing of butter.

### 28.5.2 Precooking of Bacon

Precooking of bacon is the second-largest application of microwave heating in the food industry [3]. Microwave heating is found to be an ideal system for cooking bacon compared to conventional grilling. It is reported that about half of the total bacon usage is in foodservice and virtually all foodservices bacon is precooked in microwave ovens. In addition, about 10% of the bacon sold in the supermarket is microwave precooked.

As two-component food, bacon loses the fat component, and the desirable characteristics<sup>s</sup>quality, rapidly during grilling. Microwave heating of bacon produces better structure with less shrinkage. Bacon cookers have changed with time and demand. Earlier, a combination of microwave energy and hot air was used in a microwave environment [6]. Hot air was used to trap the moisture evaporated during cooking of bacon. A combination of steam, hot air, and microwave energy is also used to cook the bacon. Sufficient amount of fat along with trapped moisture is removed during heating of the bacon at temperatures in the range of  $70^{\circ}\text{C}$ – $80^{\circ}\text{C}$  using steam. The trapped moisture does not convert to steam and is, therefore, removed along with fat. A complete microwave system has also been used for bacon cooking where series of magnetrons (equal input) are used to heat and cook the bacon. The placement of the magnetrons varies among manufacturers.

### 28.5.3 Cooking Sausage

The third largest application of microwave processing is sausage cooking [3]. The sausage patty quality could be improved along with better yield by using the microwave process. In sausage cooking also, microwave processing is used to reduce drip loss—loss of water, fat, nutrients, and flavor. Various laboratory-scale systems have been developed for microwave processing of sausage, but not with much commercial success.



#### 28.5.4 Baking

The first commercial success of microwave/radio frequency energy was in the baking industry [6]. Baking ovens use radiant energy and operate in an unspecified frequency to dry the surface and make porous crust of bread. The first bread baking (proofing) was reported by Fetty (1966) [20] at 2450 MHz. A combination of microwave and thermal energy was also used to produce brown and crusted loaf in a short time. Schiffmann et al. [21] patented a bread-baking technique in which a conventional heat source along with microwave energy was used and it was claimed to reduce the baking time by 50%. The unit operations associated with baking, especially proofing and baking, led themselves toward microwave processing since the heat transfer problems encountered by conventional means were easily overcome by microwave heating. Numerous reports are available on baking of cakes, doughnut processing, and frying.

#### 28.5.5 Drying

Microwave heating offers distinct benefits in dehydration because of its penetration depth, and the uniform heating results in water vaporizing from throughout the product. This induces an inner pressure that maintains puffed character of the dried product and preserves color, flavor, and nutritional value. Microwave drying is rapid and more energy-efficient compared with conventional hot-air drying [6]. In microwave drying, the removal of moisture is accelerated and, furthermore, heat transfer to the solid is slowed down significantly owing to the absence of convection. The usual practice of applying microwaves to drying of food materials is at the falling rate period where the migration of water from the center of the products is significantly reduced and the drying rate is comparatively slow in conventional drying process. A two-stage drying process involving initial forced-air convective drying followed by microwave finish drying has been reported to give better product quality with considerable savings in energy and time. The bakery industry conventionally uses the microwaves for finish drying of biscuits and cookies. Moreover, the moist bakery products exhibit higher loss factor ( $\epsilon''$ ), resulting in more heat generation compared to drying at a later stage with minimum water content.

Potato chips have been recognized as a global fast food. The first large-scale application of microwave energy in food processing industry was in finish drying of potato chips. Conventional drying technology cannot rapidly achieve the desired low moisture levels of potato chips and, in addition, browning creates another quality problem for the product due to presence of sugars. Drying of potato chips up to 6%–8% followed by finish drying by microwave overcomes the difficulty of the process industry.

Application of microwave energy in vacuum results in an increase in product temperature; however, the temperature rise is limited to the boiling point of the water at the lowered pressure. At a pressure of 3 kPa, free water boils at 22°C. This maintains a product temperature at a level below the temperature used under atmospheric conditions. Microwave vacuum dehydration was first used for concentration of citrus juice in France [6]. Microwave vacuum drying of agricultural commodities includes various cereal grains, and further this technology has been adapted to grapes for production of Grape Puffs™ using zoned microwave vacuum dehydration [22]. Applications of microwaves for drying of fruits and vegetables are plenty in the literature. The drying of pasta products and noodles at 915 MHz is a commercial success in many countries.

#### 28.5.6 Blanching of Vegetables

Blanching, a unit operation practiced in canning, dehydration, and freezing industry, involves short-time exposure of the product to boiling water, steam, or microwave for the primary purpose of inactivating the oxidative enzymes, which otherwise would cause undesirable change in color, flavor, and texture of the product during storage. In canning, it also serves to reduce the microbial load, eliminate dissolved oxygen from the product, and facilitate better packing of the product into cans. It has also been shown to improve color, flavor, and sensory characteristics of the product. Water and steam are the media commonly used for blanching. Convective steam blanching is currently the most commonly used method in the food industry. It is relatively energy intensive, and retains minerals and water-soluble vitamins better than water blanching. The first microwave blanching was reported by Proctor and Goldblith [23] using 3000 MHz for some green vegetables, and it was found to retain maximum amounts of vitamin C. Most of the results indicate that microwave blanching was more effective in retaining water-soluble vitamins in vegetables compared to conventional blanching methods.

### 28.5.7 Microwave Effects on Enzyme

Enzymes are probably the simplest system to consider for studying bioelectromagnetic effects in living systems. The effect of microwaves (0.3–300 GHz frequency range) on living matter has been widely studied, and most of the observed effects have been generally explained on the basis of purely bulk heating, i.e., temperature increase induced by the electromagnetic field, according to the classical theory of lossy dielectrics [13]. On the other hand, evidence of microwave effects not only related to temperature, as measurable by ordinary means, has accumulated over recent years, but the mechanisms involved are still largely unknown due to experimental and modeling difficulties. Inactivation of various enzymes such as wheat germ lipase and soybean lipoxygenase, and pectin methylesterase (PME) at various temperatures using conventional and microwave batch heating have been studied and found to have higher enzyme destruction rates under microwave heating conditions [24–26]. This difference is believed to be due to some contributory enhanced thermal effects of microwaves for enzyme inactivation.

### 28.5.8 Puffing and Foaming

Ultrarapid internal heating by microwaves causes puffing or foaming when the rate of heat transfer is made greater than the rate of vapor transfer out of the product's interior. Microwaves are ideal for producing puffed snack foods.

### 28.5.9 Concentration

Microwave heating has also been used to concentrate heat-sensitive solutions and slurries at relatively low temperatures. The process is also applicable to highly corrosive or viscous solutions.

---

## 28.6 Recent Development in Microwave Food and Packaging

Recently, food processors have developed many new-generation microwaveable foods with suitable packaging materials to meet these demands. The foods are microwaveable and for use at home as well as away from home, via convenience store or office microwave. In many cases, the products' success hinges on a combination of product reformulation and package redesign.

High-density polypropylene (HDPP) is a low-cost solution for microwave process over other materials that can withstand the target temperature. For sterilization, PET, HDPP, and various polyester-based materials are available as high-quality trays, pouches, and bags. Glass also is a possibility. The metal cap in glass jar actually proved to be an advantage.

Some of the new products now available in the market include Eggology's On-the-go 100% egg whites, and Marks and Spencer's Steam Cuisine [29]. The microwaveable product expands during cooking and the lid automatically pops up. Steam Cuisine fresh prepared meal requires 6 min to cook from raw stage. Another claim is to develop "intelligent double pressure cooking technology," where in the first cooking steps the microwave passes through the specially developed packaging and the frozen food materials. The frozen water becomes steam and cooks the food from inside out. In the next phase, as the steams comes out of the food tissues, it is held and retained inside the packaging. During the steam pressure builds, the food cooks from the outside in.

Packaging has played a significant role in microwave processing of foods. Big names like Kraft have developed many new packaging materials that can be used in microwave heating of pizza [29]. Another development in microwave foods has been reported by introducing aroma in the packaging material. The aroma is released during microwave heating of packaged material. In the future, we may expect more revolution in microwave package design to satisfy the never-ending demands of the consumer.

---

## 28.7 Microwave Pasteurization and Sterilization

Pasteurization is the process that uses relatively mild heat treatment to foods to kill key pathogens, and inactivate vegetative bacteria and enzymes to make food safe for consumption. Most frequently, milk and fresh fruit juices are pasteurized where minimum process is necessary to eliminate health-associated

hazards. However, the thermal treatment given does not kill bacterial spores, and hence the product is not stable at room temperature. Under refrigerated storage conditions, one can expect 2–6 weeks of shelf life. Recently, the process has been upgraded to remove the potential health hazards due to *Salmonella*, *Escherichia coli*, and *Listeria monocytogenes*. Pasteurization of milk is achieved by 30 min heating at 63°C or 15 s at 72°C. Much higher temperatures have also been used for a shorter period in HTST and ultra-high temperature (UHT) processes. The temperatures and times are determined by what is necessary to destroy pathogenic, heat-resistant, disease-causing microorganisms that may be found in the food. Subsequent to pasteurization, the product is then quickly cooled to 4°C. Pasteurization temperatures and times vary, depending on the product nature and the target organism.

Sterilization is a more severe thermal treatment of foods. Traditionally, the process is designed to achieve commercial sterility of the products, giving it long-term shelf stability. The magnitude of thermal treatment is a function of pH, and it accounts for the effects of pH on the thermal resistance of the microbial spores. Foods with high pH (>4.5) support the growth of *Clostridium botulinum* that produces an exotoxin. It is generally recognized that a thermal process sufficient to eliminate toxin-producing *C. botulinum* from the food should make the food commercially sterile if adequately packaged under vacuum, recontamination prevented, and appropriately stored at room temperature (at <30°C to prevent the growth of thermophilic bacterial spores). Commonly, saturated steam at elevated pressures (135°C–140°C) and steam-heated hot water are used as heating media for food sterilization. Microwave sterilization has been studied for potential commercial applications. However, the commercialization has faced several problems with some limited success [27].

Both pasteurization and sterilization are based on time–temperature combination processes applied to food products to achieve intended target lethality. In most cases, target microorganisms are chosen for specific types of food. The death kinetics of the microorganisms play a major role in selecting the target lethality, and therefore the quantification and accommodation of microbial destruction kinetics are important steps in establishing the thermal process.

## 28.8 Kinetics of Microbial Destruction

The destruction of microorganisms and inactivation of enzymes are generally expressed by the  $n$ th-order chemical reaction as

$$\frac{dC}{dt} = -kC^n \quad (28.7)$$

where  $dC/dt$  is the change in concentration  $C$  or microbial population (change  $C$  to  $N$ ) with time  $t$ ,  $k$  the reaction rate constant, and  $n$  the order of reaction. Generally, the destruction of microorganisms is described by a first-order reaction kinetics. The thermal resistance of microorganisms is also conventionally characterized in food processing by means of a decimal reduction time ( $D$  value, which is the heating time at a given temperature that achieves 90% destruction of the existing microbial population) and the thermal resistance constant ( $z$  value, the temperature range between which the  $D$  values change by an order of 10) [30].

$$D_{T_{\text{ref}}} = \frac{2.303}{k} \quad (28.8)$$

$$z = \frac{T_2 - T_1}{\log D_1/D_2} \quad (28.9)$$

The equivalent time necessary for thermal treatment with known thermal resistance of a microorganism is calculated by integration of the time–temperature history using Equation 28.10

$$F = \int_0^t 10^{\frac{T(t)-T_R}{z}} dt \quad (28.10)$$

This approach has been commonly used in the thermal process calculations. A similar concept can be applied for determining kinetics parameters during microwave heating; however,

nonisothermal heating conditions are involved in this case. Resulting  $D$  values can be computed using Equation 28.11

$$D = \frac{t_{\text{eff}}}{\log(C_0/C)} \quad (28.11)$$

where  $t_{\text{eff}}$  is an effective time (similar to  $F$  as in Equation 28.10) with  $T_R$  as exit temperature of the product, obtained using either model predicted or experimentally determined time–temperature profiles; and  $C_0$  and  $C$  are initial and final concentrations of microbial cells. The use of this approach is rather limited in studies relating to microwave effects. Only few studies reported in the literature describing kinetics during microwave heating make use of the transient temperature profiles [26]. However, as in thermal destruction, microwave destruction kinetics of food constituents such as quality characteristics, enzymes, and microorganisms are required for establishing microwave processing.

### 28.8.1 Come-Up Time and Come-Down Profile Corrections

Continuous-flow microwave heating has advantages over batch processing where the presence of nonuniform temperature in the product has seriously limited its use. Continuous-flow liquid systems allow maintaining the time and temperature achieved in steady state, record average temperatures during heating, minimize temperature gradient by mixing of the liquid, and cool liquid immediately at the exit. Microwave heating involves a nonisothermal CUT inside the oven or cavity. The holding and come-down phases take place generally outside the MW oven. More details on evaluating kinetic parameters during nonisothermal continuous-flow heating are detailed in Tajchakavit and Ramaswamy [25]. From a regression of log residual numbers of survivors versus residence time (uncorrected heating time), a first estimate of  $D$  values at the exit temperatures can be obtained, and using them at different temperatures one can get an estimate of  $z$  value. Using this estimated  $z$  value and the time–temperature profile, a more effective heating can be computed from Equation 28.10. These effective times can then be used to recalculate  $D$  and  $z$ . These two steps are repeated several times for the convergence of  $z$  value. The come-down period contribution occurs outside the microwave oven and this should be subtracted from total destruction to estimate the destruction due to MW heating. To do this, the effective cooling time ( $t_c$ ) can be computed using the same Equation 28.10 with the  $z$  value obtained from conventional thermal destruction studies. The extent of logarithmic thermal destruction (LTD) during cooling can be estimated following the relationship

$$\text{LTD} = \frac{t_c}{D} \quad (28.12)$$

where  $D$  is the  $D$  value at the exit temperature obtained from thermal destruction studies. This calculated value is then subtracted from the combined destruction of microbial population due to microwave heating and cooling. Microbial destruction data of test samples can thus be corrected for both come-up and come-down period contribution to lethality. This approach has been used in some studies for comparative evaluation of microbial lethality under conventional and microwave heating.

### 28.8.2 Microwave Heating Systems

#### 28.8.2.1 Batch Heating

In the batch process, the magnetron-based microwave ovens are commonly used for the heating purpose. The food sample is placed in the oven for a predetermined time to achieve a target temperature. The power level is normally adjusted to achieve a certain desired temperature difference in a given time frame. The volumetric heat absorbed by the food material during microwave heating can be calculated by using the following relationship assuming that there is no surrounding heat loss

$$Q = mC_p(T_f - T_i) \quad (28.13)$$

where  $m$  is the mass of food (kg);  $C_p$  the specific heat (kJ/kg°C);  $T_f$  the final temperature (°C), and  $T_i$  the initial temperature (°C). The absorbed microwave power ( $P$ ) can be calculated by volumetric heat divided by heating time.  $P$  is compared with the nominal microwave output to compute the efficiency, and generally over 90% of the nominal power can be accounted by a large sample.

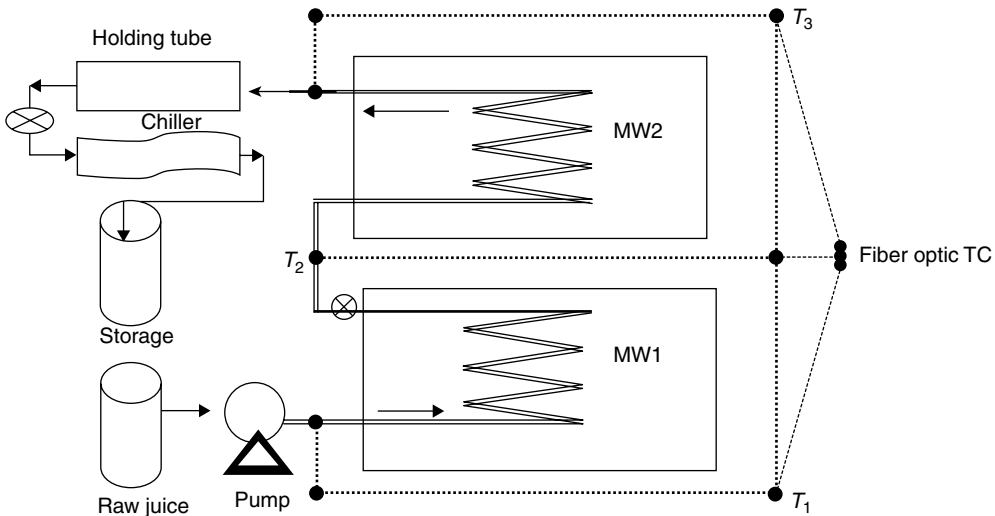


FIGURE 28.1 Continuous-flow microwave pasteurizer.

### 28.8.2.2 Continuous-Flow Heating

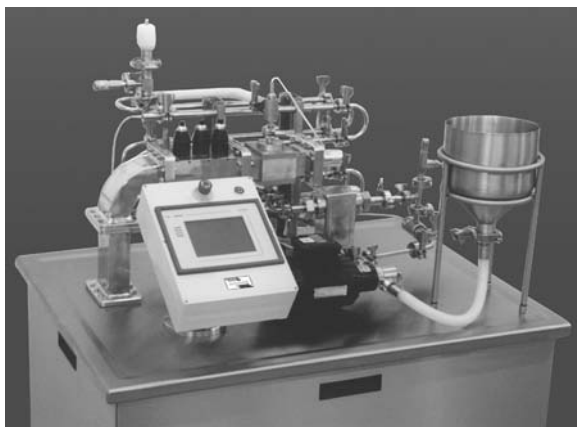
The thermal processing using microwaves has been reported to offer potential benefits to the food processing industry due to rapid heating and the ability of microwaves to penetrate the food and thereby achieve more effective bulk heating. Continuous systems have advantages over batch ones with increased productivity, easier clean up, and automation. Several laboratory-based continuous-flow microwave heating systems have been used for fluid foods with different configurations [19,25,31–33]. The schematic diagram of a basic continuous-flow microwave heating is shown in Figure 28.1. The raw fluid is pumped (peristaltic pump) through Teflon or glass helical coils placed inside one or several microwave ovens connected in series for heating (alternately several magnetrons can be arranged in one oven). Outside the microwave oven, the fluid then passes through a holding section to allow a predefined holding time followed by chilling in some form of a tubular heat exchanger. Thermocouples are used for gathering sample temperatures at the entry and exit sections (external to the oven), while fiber-optic probes are used to monitor the temperature inside the cavity/oven.

To establish steady-state flow conditions for microwave heating, the fluid food is precirculated in the system after which the microwave ovens are turned on. The volumetric flow rates are determined for various pump settings. For pasteurization process, the flow rate is generally set so that the exit temperature of the fluid in the microwave oven maintains the required temperature in holding section. The temperature of the fluid in the holding section is maintained by external means [25], or in some cases the exit temperature is elevated to a slightly higher level than required to allow for the heat loss through the insulated holding tubes [19]. However, time–temperature profiles of most of the cases are generated by transit time–temperature measurement at selected regions.

## 28.8.3 Application to Food Systems

### 28.8.3.1 Milk

Milk is traditionally pasteurized in a heat exchanger before distribution. The application of microwave heating to pasteurize milk has been well studied and has been a commercial practice for quite a long time. The success of microwave heating of milk is based on established conditions that provide the desired degree of safety with minimum product quality degradation. Since the first reported study on the use of a microwave system for pasteurization of milk [31], several studies on microwave heating of milk have been carried out. The majority of these microwave-based studies have been used to investigate the possibility of shelf-life enhancement of pasteurized milk, application of microwave energy to inactivate milk pathogens, assess the



**FIGURE 28.2** A typical microwave pasteurizer.

(12 cm/0.635 cm) placed across a 2450 MHz microwave guide. The system had a 15 s holding time. The adequacy of pasteurization was considered on the basis of inactivation of phosphatase enzyme, standard plate, and coliform counts.

HTST sterilization of raw milk has also been tested under microwave field at 2450 MHz. A typical microwave pasteurizer is shown in Figure 28.2. The process was done in free-falling stream of milk with pressure application. Heating was reported to be extremely rapid with a temperature rise of 200°C; holding was less than a second while the cooling was done by turbulent mixing with cold sterilized milk. However, the process was not considered economically feasible. Kudra et al. [35] used a domestic microwave oven for continuous-flow pasteurization of milk and its constituents. The protein in milk was found to be the contributing component to dictate the heating pattern in milk pasteurization, while effects of fat and lactose were considered negligible. Lopez-Fandino et al. [40] reported the effects of thermal treatment of milk in a continuous-flow microwave system by studying the denaturation of  $\beta$ -lactoglobulin and the inactivation of alkaline phosphatase and lactoperoxidase using a modified microwave oven at 2450 MHz. The results were compared with those obtained by conventional thermal treatment in a plate-type heat exchanger, and the degree of inactivation caused by the thermal treatment in both cases was found to be similar. Microwave pasteurization of milk was reported to result in lower levels of denaturation of whey proteins compared to conventional thermal processes and that the denaturation of  $\beta$ -lactoglobulin was almost similar in both processes [41]. Moreover, the process yielded lower microbial counts and lower lactose isomerization. The sensory characteristics of microwave-pasteurized milk were considered comparable to those achieved by traditional pasteurization after 15-day storage.

To overcome the nonuniformity of temperature distribution caused by microwave heating, Coronel et al. [42] experimented on continuous-flow microwave heating of milk at 915 MHz using a cylindrical microwave applicator. The microwave field inside the applicator generated a parabolic field distribution inside the tube for a fluid with constant dielectric properties, like those of milk at 25°C. The system was designed in such a fashion that the fastest moving particles residing at the center would receive maximum power for a shorter period, whereas the slowest moving particles at the wall side would receive minimum power for a larger period. The system was reported to exhibit a relatively even distribution of temperature for milk in the cross-sectional area of the tube at the exit of the applicator. Temperature distributions data revealed that the hottest temperature was found at the center of the tube, while the cooler temperature was close to the walls of the tube.

### 28.8.3.2 Effect on Milk Nutrients

Milk is a rich source of vitamins and heat treatment affects some of these nutrients. The effects of microwave heating on several vitamins in cows' milk have been studied by many researchers [40]. Most studies report an insignificant loss in vitamin A,  $\beta$ -carotene, vitamin B<sub>1</sub> or B<sub>2</sub> in microwave-pasteurized milk, while a loss of approximately 17% for vitamin E and 36% for vitamin C have been found.

influence on the milk nutrients or the nonuniform temperature distribution during the microwave treatment [31,34–39].

Continuous-flow microwave treatment has been proposed for milk pasteurization due to its potential advantages over the conventional tubular and plate heat exchangers. Continuous milk pasteurization at 2450 MHz using a simple waveguide heat exchanger was first reported by Hamid et al. [31]. Raw milk was passed through a glass tube fitted across a waveguide, and milk was exposed to microwave energy during gravity falling. The plate counts were found to be negative while the temperature reached 82.2°C. Jaynes [34] developed an experimental continuous-flow microwave pasteurizer using a Teflon tube

Sierra et al. [43] compared the heat stability of vitamins B<sub>1</sub> and B<sub>2</sub> in milk between continuous microwave heating and conventional heating having the same heating, holding, and cooling steps. No significant losses in the vitamins were reported during microwave heating at 90°C without holding period, while vitamin B<sub>2</sub> was found to decrease by 3%–5% during 30–60 s of holding. The authors concluded that the microwave process does not offer any additional advantage with respect to vitamin retentions as compared to conventional heating process. Microwave heating of milk does not affect protein or fat components. Volatile components of conventionally treated and microwave-treated (continuous flow) milk have differed significantly.

### 28.8.3.3 Effect on Microbial Inactivation

The inactivation of *Streptococcus faecalis*, *Yersinia enterocolitica*, *Campylobacter jejuni*, and *Listeria monocytogenes* in milk by microwave energy has been reported by Choi et al. [37,38]. The complete inactivation of *Y. enterocolitica*, *C. jejuni*, and *L. monocytogenes* occurred at 8, 3, and 10 min when the cells were heated at a constant temperature of 71.1°C using microwaves with initial microbial loads of 10<sup>6</sup>–10<sup>7</sup> K/mL [37,38].

### 28.8.3.4 Fruit Juices

Generally, acidic products like fruit juices are not considered vehicles for foodborne illness; however, recent reports demonstrate that three pathogens, namely, *Salmonella enterica*, *E. coli* O157:H7, and *Cryptosporidium parvum* have been associated with foodborne illness in fruit juices. Pasteurization of fruit juices is traditionally carried out by HTST heating process using plate heat exchanger followed by a brief holding period and cooling. However, fouling is the major problem in such processes. Inactivation of microorganisms and enzymes of fruit juices, e.g., citrus juices by microwave pasteurization, especially in continuous-flow systems, has created interest among juice processor manufacturers due to lower thermal exposure, elimination of fouling in the pipe line, and retention of juice quality.

In orange juice, pectin methyl esterase (PME), an undesirable enzyme, causes spoilage and cloud loss during storage. In addition, the enzyme is more heat resistant than spoilage microorganisms and, therefore, has been considered as an index of the adequacy of pasteurization. Nikdel et al. [44] described a continuous-flow microwave system to pasteurize orange juice using PME inactivation and microbial count as indices. However, the system did not consider the time requirement for achieving the microwave exit temperature, or the CUT and come-down time (CDT) contributions. The inactivation of PME and *Lactobacillus plantarum* was found to be more pronounced using microwaves as compared to conventional heating. The kinetics of PME inactivation in orange juice during microwave heating in continuous as well as batch mode were compared with those during conventional heating by Tajchakavit and Ramaswamy [25,26], and they found largely enhanced inactivation of PME while employing microwave heating. In batch process, orange juice in glass beakers, with good mixing, was heated in a microwave oven for a preselected time to achieve the desired temperature. In the continuous-flow system, the juice was pumped through a helical glass coil placed inside the microwave oven under full power heating conditions, and a target exit temperature was achieved based on juice flow rate and initial temperature. Under steady-state conditions, the increment of fluid temperature between inlet and outlet in continuous flow was found to be nonlinear along the tube length. Under both batch and continuous-flow microwave heating conditions, PME inactivation rate was significantly higher than in conventional thermal treatment at selected temperatures (*D* values at 60°C: batch microwave = 7.37 s; continuous microwave = 22 s and conventional = 150 s). The authors claimed some enhanced thermal effects during microwave heating largely contributing to greater PME inactivation.

Microwave pasteurization of apple juice has also been investigated by several researchers [19,45]. Tajchakavit et al. [45] studied destruction kinetics of *Saccharomyces cerevisiae* and *Lactobacillus plantarum* in apple juice under continuous-flow microwave heating conditions and compared it with conventional batch heating in a water bath. The *z* values under microwave heating for *S. cerevisiae* and *L. plantarum* were found to be 7 and 4.5°C, respectively, while the corresponding batch conventional heating values were 13.4 and 15.9°C, respectively. Microbial destruction thus was much more temperature sensitive under microwave heating than under thermal heating. Based on the computed *D* values, the authors again suggested some contributory enhanced effects to be associated with microwave heating.

However, Canumir et al. [46] reported that exposure of *E. coli* to microwave treatments at 2450 MHz resulted in a reduction of the microbial population in apple juice and that the inactivation is solely due to heat. The pasteurization was carried out at different power levels (270–900 W), and it was reported that 2–4 log reduction in the microbial population was achieved at 720–900 W for 60–90 s with *D* values ranging from 0.42 min at 900 W to 3.88 min at 720 W. Recently, Gentry and Roberts [19] developed a continuous-flow microwave pasteurizer using helical coils distributed through a large cavity oven to produce uniform and reproducible heating of apple cider. Process lethality of apple cider was verified on the basis of inoculation of *E. coli* 25992 and 5D reduction was reported.

### 28.8.3.5 Ready-to-Eat Meals

Frozen ready-to-eat food processing technology is enormous and has been rapidly expanding over the years. The growth of the industry has been generated by the consumer demand for ready-to-eat meals, which can be reheated easily before eating. Pasteurization schedule of ready-to-eat meals needs to be established through the same guidelines that are used for commercial sterilization and cannot be simply specified in terms of a time–temperature combination. Pasteurization of ready-to-eat meals using microwaves to enhance their shelf life has been recognized for many years, and the potential of the method has been verified in pilot-scale systems [47]. Pilot- and commercial-scale microwave pasteurizers are available presently for this purpose. However, the adoption of the technology by the food processing industry has been slow due to the uncertain trends in the markets for chilled foods with extended shelf life and also because of the technical limitations linked to the process. Ideally, the product should be heated to specified levels without overcooking, then cooled quickly, and properly stored and distributed. All along, the product should remain microbiologically safe while its shelf life is extended.

Various procedures of overcoming the technical problems have been considered, including the use of a liquid circulating around the packs of food to restrict edge heating, pressurized systems for elevating temperatures, or using partially open packs to prevent the bursting of packages, moving the waveguides, hot filling of product components to produce more uniform product temperatures, or incorporating metallic structures into the cavity to modify the field distribution. Many of these changes increase the complexity and cost of the equipment and may impede flexibility of product types. Improving the design procedures for microwave systems, including the design of the microwave cavity, food packaging, and food composition should lead to better processes. An efficient engineering approach requires methods that are capable of predicting the electric and magnetic fields and temperature distributions in foods during microwave heating. Heat processing at 80°C–85°C for a few minutes is considered sufficient, with a margin of safety, to inactivate vegetative pathogenic microorganisms such as *Salmonella* and *Campylobacter*, but not bacterial spores. However, most bacterial spores do not multiply at low temperatures below 4°C. The growth from spores needs to be considered only when they are known to be present in the product ingredients and prolonged storage periods are expected.

Effect of various combinations of microwave ovens (domestic, pilot-scale tunnel) and frequencies (2450, 896 MHz) has been studied for pasteurization of ready-to-eat spaghetti bolognaise meals in retail packaging to extend the shelf life [48]. It was reported that mean product temperatures above 80°C could be achieved using any of the systems, but only the tunnel operating at 896 MHz heated all the products in a pack above that temperature.

Ryynanen and Ohlsson [17] studied the importance of chemical and physical modifications in four-component chilled ready meals during uniform microwave heating. The food component placement and geometry of products and packages were reported to play a significant role in providing microwave heating uniformity of multicomponent food systems. The temperature distribution could be balanced partly by taking advantage of edge and corner heating intensification. In contrast, chemical modifications, such as saltiness, did not notably affect the heating uniformity. However, interaction effects could sometimes be important.

---

## 28.9 Sterilization Systems

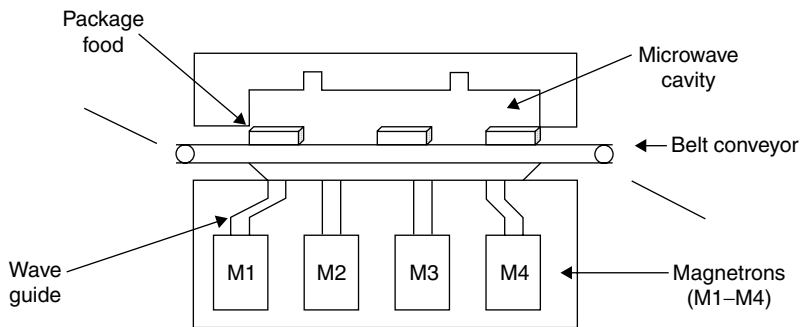
Pasteurization of packaged bread, pasta, and pizza has been reported. In some European countries, the whole loaf of the packaged bread is treated with microwave energy to enhance the shelf life. Microwave-treated



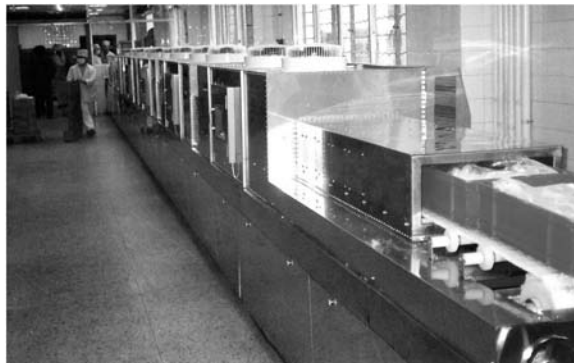
fresh pasta in pack further needs controlled-atmosphere storage to increase shelf life. Microwave processing for fresh filled pasta became common in Italy in the 1990s, and the technology has been applied to ready-to-eat meals, pasta-based products, and a variety of other foods. Some of the leading global food manufacturers are applying the technology, including Unilever and Barilla SpA in Italy and Morinaga in Japan. However, both the products have limited success due to excessive cost of the process.

In the 1970s, Kenyon developed a high-quality shelf-stable ration as a replacement for the U.S. Army's C-ration by using a fiberglass-reinforced polyester pipe, which was installed in a 10 kW microwave oven. The system was similar to the equipment shown in Figure 28.3. A pair of butterfly valves at the product entry allowed pouches to be introduced into the processing system on a narrow conveyor belt through the microwave field. The pouches dropped off at the end of the belt into a cold-water tank from which they could be removed periodically. Radiation heat losses were minimized by wrapping the pouches in microwave transparent insulation. However, the temperature difference from the edge to the center of the pouches was reduced to 5°C or less from 30°C or more. Another contemporary study of microwave packaged food carried out by Alfa Laval, Sweden, was found to establish a decreasing temperature gradient from edge to center by introducing a cooling step to lower the temperature at the edges. Another modification of microwave sterilizer was carried out based on microwave heating of water by conveying packages of product through water. The water temperature was progressively adjusted by conventional heating means to provide edge heating control without expending too much energy in microwave heating of the water. The system was installed in a Swedish food plant [6].

HTST processing of pouches by conventional retorting has clearly proven the benefit of such processing on a number of quality parameters. According to Ohlsson and Bengtsson [49], there is no reason to believe a microwave HTST process would be any less successful. The authors [49] made a comparison of canning, retorting foil pouches, and microwave sterilization of plastic pouches in terms of the cook value (in an integrate value describing the effect of time and temperature on product quality). The quality of a variety of products processed using microwave sterilization was clearly superior. A typical commercial microwave reheating and sterilization system is shown in Figure 28.4.



**FIGURE 28.3** Multimode microwave tunnel cavity for packaged food pasteurization and sterilization.



**FIGURE 28.4** Microwave pasteurizer.

Limited publications of data on processing two- and three-component ready meals are available. Processing meals presents a more complex problem—differential heating pattern of various components. The problem could be solved by accounting for the energy requirements of each component. Several patented references are available on the topic while public information is generally lacking. Data availability on the effect of storage time at room temperature on the quality factors of microwave-sterilized foods is scarce. However, there are some results in which microwave-sterilized (2450 MHz) vegetables were compared with foil pouch sterilization at 121°C and a frozen reference. The microwave product was comparable with the frozen product for sensory characteristics even after 6 months at 25°C [50]. In another study with chicken a la king, the appearance of microwave-sterilized product compared favorably with the frozen reference even after 12 months' storage.

---

### 28.10 Marker Formation as an Index of Microwave Sterilization

The implementation of microwave sterilization process can vary significantly among process design and manufacturers. The applicability of the process in the food industry, especially in the United States, depends on the FDA approval of the dielectric sterilization process as a reliable procedure to establish and validate the required lethality for heat treatments to ensure microbiological safety. To design a new thermal process, which ensures adequate sterility for shelf-stable foods, it is necessary to locate the cold spot in packaged foods [51]. Once the cold spot is determined, accurate time–temperature data can then be gathered from the slowest heated point and used for developing suitable thermal processes.

Numerous biological integrators have been found in the literature and most of these have been used as relative indicators for food safety. None of these are really adequate for identification of the coldest point of thermally processed foods. Microbiological assays are good indicators to determine effectiveness of a process; however, the procedure has limitations, as the process is time consuming, expensive, subject to recovery and contamination problems, and requires large population changes as evidence of the process. The use of effective chemical marker techniques developed by the U.S. Army Natick Research Center has been reported to be an alternative technique to quantify the time–temperature history of food products to assess heating uniformity in sterilized foods. Three markers have been in use for food systems, namely, 2,3-dihydro-3,5-dihydroxy-6-methyl-(4H)-pyran-4-one (M-1), 4-hydroxy-5-methyl-3(2H)-furanone (M-2), and 5-hydroxymethylfurfural (M-3) [52]. The marker yield can be correlated with the time–temperature effect within food systems, provided the kinetic information is obtained. Formation of intrinsic chemical markers is described as first-order reaction kinetics considering an excess source of either the protein or ribose/glucose precursor in food materials [52]. Since both marker formation and the bacterial destruction are functions of time–temperature profile, verification of calculated marker formation using experimental studies is analogous to verification of bacterial destruction in sterilization. The marker formation kinetics of ham and whey proteins has been well compared between experimental and mathematical models by Zhang et al. [28].

The yield of M-2 in whey protein gels as model foods was used to quantitatively assess the heating uniformity of microwaves at 915 and 2450 MHz [53]. M-2 predicted the HTST process well, while M-1 was found to be more relevant for longer thermal processes [54]. Kim and Taub [52] evaluated the kinetics of M-1 in broccoli extract at sterilization temperatures (116°C–131°C) practiced in the food industry. Zhang et al. [28] evaluated concentration of marker compound formed (M-2) during heating of whey protein concentrate solution and ham, and experimental data combined with numerical analysis were reported to result in an accurate and comprehensive study of the sterilization process. The marker yield increased beyond a temperature of 100°C and was maximum at 121°C. Lau et al. [54] studied the chemical marker formation of 4-hydroxy-5-methyl-3(2H)-furanone (M-2) in a model food system (20% whey protein gel) to identify cumulative time–temperature effects in HTST processes at 915 MHz. The formation of M-2 occurs from D-ribose and amines through nonenzymatic browning reactions and enolization under low acid conditions (pH > 5). M-2 formation follows the first-order reaction kinetics and can be used for determining the cumulative heating effect in a model food system subjected to microwave heating.

However, the main limitation of using chemical marker technique in real foods is the inconsistency of food composition in the food system leading to potentially large variations in the measurements of the marker yields. In addition, heating pattern changes with food materials, placement of foods in ovens,

oven design and therefore a combination of coupled thermo-electromagnetic model along with experimental measurement of marker formation could provide a better picture of microwave sterilization.

---

### **28.11 Limitations and Future of Microwave Heating**

Microwave sterilization has been studied extensively in academic and industrial sectors. However, the commercialization of the process has only limited success [27]. The major drawback in the microwave sterilization is the nonavailability of actual temperature profiles. Measurement of temperatures at few locations does not guarantee the real temperature distribution of the product during microwave heating, as the heating pattern can be uneven and difficult to predict, and change during heating. Therefore, researchers in the field have found inconsistent outcomes.

Secondly, it is not always true that the microwave-assisted process results better quality retention of food products. The degradation kinetics of either quality, sensory, or nutrients depend upon many factors like nature of the food products, food geometry, dielectric properties, and oven designs as compared to conventional thermal processing. The dielectric properties of the food product significantly vary during heat processing and especially at above 80°C for protein and starches, and simultaneously the heat absorption process. These changes in dielectric properties could affect the heating pattern qualitatively, while such factors are not serious in conventional thermal processing. Coupling of heat transfer and electromagnetics could serve to account for changes in dielectric properties during thermal treatment [28].

The novelty of the microwave sterilization process depends on the proper selection of equipment and packaging, which could assure its success in food processing industries. Laboratory processing equipment is also essential for process refinement and to study the effect of process and storage time on product quality attributes, and microbiological safety factors. It is well recognized that microwave sterilization can produce high-quality shelf-stable food products. Only the most recent work had the benefit of suitable barrier packaging material. However, the earlier work recognized the need for suitable barrier material. Recently, few packaging material suppliers showed serious interest in this process.

---

### **28.12 Recommendations for Microwave Pasteurization and Sterilization**

Based on views and research outcome of several experts in the field of microwave technology applied to food, the U.S. Food and Drug Administration published the following recommendations in 2002 for better heat transfer and temperature management in microwave heating:

1. Temperature distribution in food during and after microwave heating is different from that using conventional heating method. Therefore, temperature should be measured with various techniques for a more reliable record of temperature distribution. The temperature should be measured in as many places as possible to predict more accurate information and time-temperature history of the product during microwave thermal processing.
2. Information on the coldest point and its location is of primary importance for the microbial safety of sterilized food. As heating patterns can change dramatically for various food materials, different placements in the oven, and different oven designs and, since, the patterns can also change during heating, a combination of a coupled thermal-electromagnetic model complemented with experimental measurement of marker formation are needed for comprehensibility and repeatability of microwave sterilization.
3. Microwave heating uniformity of multicomponent food systems is dependent on food component placement and geometry of products and packages. Placement has the most significant effect. The temperature distribution should be balanced partly by taking advantage of edge and corner heating intensification.
4. A combination of thermal-electromagnetic model and marker formation kinetics should be used to describe microwave sterilization in a comprehensive way. Coupling of heat transfer and electromagnetics is important while considering significant changes in dielectric properties during

heating of foods. The model predictions should be verified by obtained experimental data involving chemical marker yields that are functions of the time–temperature history in the material.

5. The time–temperature history and thus the sterilization vary spatially in a very significant way. Additionally, the heating changes the relative spatial variation in sterilization. The spatial nonuniformity of sterilization and its transient changes can be improved significantly by changing the material's dielectric properties, which are a function of its composition. The effect of salt content was found to be particularly pronounced.
6. To improve the microwave heating efficiency and desirable sensory characteristics of foods, combining microwaves with other modes of heating such as infrared heating (IR) and jet-impingement can be used.
7. Applying microwave energy at a lower frequency e.g., 900 MHz would show higher penetration depths in materials such as foodstuffs.

---

### 28.13 Conclusions

Microwave energy has advantages over conventional heating. The application of microwave energy for pasteurization and sterilization has been studied for about half a century with some commercial success. Some researchers have claimed nonthermal or enhanced thermal effects to be associated with microwave heating on the destruction of microorganisms and inactivation of enzyme, but the issue still remains controversial. Continuous-flow microwaveable pasteurizers could be used for milk and juice processing. Microwave pasteurization of ready-to-eat meals has also been found to be a commercial success in the European countries although US industries are still reluctant to adopt the technology. Replacement of conventional heating by microwave energy source is not possible before fully understanding the real heating and inactivation mechanisms, temperature distribution in multilayered foods, and other critical factors. The qualitative and significant change in heating pattern has to be taken into consideration in the calculations of marker yields by coupling the electromagnetics with energy transfer in microwave sterilization. Currently, more emphasis has been given on sterilization of solid foods using microwave energy. Commercial size microwave equipment is now readily available for pasteurization and sterilization applications. Some reasons cited for the lack of commercial success in the operation are complexity, high expenditure, nonuniformity of heating, inability to ensure sterilization of the entire package, lack of suitable packaging materials, and unfavorable economics when compared to prepared frozen foods in the developed countries.

---

### References

1. Karel, M. and Lund, D.B., *Physical Principles of Food Preservation*. 2nd ed. Marcel Dekker, New York, 2003, Chap. 6.
2. Higgins, K.T., Engineering R&D: Microwave muscles into processing mainstream. *Food Eng.* 68–76, 2003.
3. Schiffmann, R.F., Microwave processes for the food industry, in *Handbook of Microwave Technology for Food Applications*. Datta, A.K. and Ananteswaran, R.C., Eds. Marcel Dekker, New York, 2001, pp. 299–335.
4. Lund, D.B., Design of thermal processes for maximizing nutrient retention. *Food Technol.* 31, 71–78, 1977.
5. Meredith, R.J., *Engineers' Handbook of Industrial Microwave Heating*. Institute of Electrical Engineers, UK, 1998.
6. Decareau, R.V., *Microwaves in the Food Processing Industry*. Academic Press, New York, 1985, Chap. 1.
7. Fleming, H., Effect of high frequency on microorganisms. *Electrical Eng.* 63, 18, 1944.
8. Knorr, D., Geulen, M., Grahl, T. and Stitzman, W., Food application of high electric fields pulses. *Trends Food Sci Technol.* 5, 71–75, 1994.
9. Stuerga, D.A.C. and Gaillard, P., Microwave athermal effects in chemistry: A myth's autopsy. *J. Microwave Power EME* 31, 87–113, 1996.
10. Palaniappan, S. and Sastry, S., Effects of electricity on microorganisms: A review. *J. Food Proc. Preserv.* 14, 393–414, 1990.
11. Oliveira, M.E.C. and Franca, A.S., Microwave heating of foodstuff. *J. Food Eng.* 53, 347–359, 2002.

12. Decareau, R.V. and Peterson R.A., *Microwave Processing and Engineering*. Ellis Horwood Ltd. & VCH Publishers, Deerfield Beach, FL, 1986.
13. Von Hippel, A.R., *Dielectric Materials and Applications*. MIT Press, Cambridge, Massachusetts, 1954.
14. Nelson, S.O. and Datta, A.K., Dielectric properties of food materials and electric field interactions, in *Handbook of Microwave Technology for Food Applications*. Datta, A.K. and Anatheswaran, R.C., Eds. Marcel Dekker, New York, 2001, pp. 69–107.
15. Mudgett, R.E., Microwave food processing. *Food Technol.* 43(1), 117, 1989.
16. Mudgett, R.E., Dielectrical properties of food, in *Microwaves in the Food Processing Industry*. Decareau, R.V., Ed. Academic Press, New York, 1985, Chap. 2.
17. Ryyänen, S. and Ohlsson, T., Microwave heating uniformity of ready meals as affected by placement, composition, and geometry. *J. Food Sci.* 61, 620–624, 1996.
18. Sandeep, K.P., and Puri, V.M., Aseptic processing of liquids and particulate foods, in *Food Processing Operations Modeling: Design and Analysis*. Irudayaraj, J., Ed. Marcel Dekker, New York, 2001, pp. 37–81.
19. Gentry, T.S. and Roberts, J.S., Design and evaluation of a continuous flow microwave pasteurization system for apple cider. *Lebensm.-Wiss. u.-Technol.* 38, 227–238, 2005.
20. Fetty, H., Microwave baking of partially baked products. *Proceedings of the 42nd Annual Meeting. Am. Soc. Bak. Eng.* 144–152, 1966.
21. Schiffmann, R.F., Method of baking firm bread. U.S. Patent 4,318,931, 1982.
22. McKinney, H.F. and Wear, F.C., Zoned microwave drying apparatus and process. U.S. Patent 4,640,020, 1987.
23. Proctor, B.E. and Goldblith, S.A., Radar energy for rapid cooking and blanching and its effect on vitamin content. *Food Technol.* 2, 95–104, 1948.
24. Kermasha, S., Bisakowski, B., Ramaswamy, H.S. and Van de Voort, F.R., Comparison of microwave, conventional and combination treatments inactivation on wheat germ lipase activity. *Int. J. Food Sci. Technol.* 28, 617–623, 1993.
25. Tajchakavit, S. and Ramaswamy, H., Continuous-flow microwave heating of orange juice: Evidence of non-thermal effects. *J. Microwave Power Electromag. Energy* 30, 141–148, 1995.
26. Tajchakavit, S. and Ramaswamy, H.S., Continuous-flow microwave inactivation kinetics of pectin methyl esterase in orange juice. *J. Food Process. Preserv.* 21, 365–378, 1997.
27. Tops, R., Industrial implementation: Microwave pasteurized and sterilized products, *Symposium on Microwave Sterilization, IFT Meeting*, Dallas, TX, IFT, Chicago, IL 2000.
28. Zhang, H., Datta, A.K., Taub, I.A. and Doona, C., Electromagnetics, heat transfer, and thermokinetics in microwave sterilization. *Assoc. Int. Chem. Eng. J.* 47, 1957–1968, 2001.
29. Bertrand, K., Microwavable foods satisfy need for speed and palatability. *Food Technol.* 59, 30–34, 2005.
30. Stumbo, C.R., *Thermobacteriology in Food Processing*. 2nd ed. Academic Press, New York, 1973.
31. Hamid, M.A.K., Boulanger, R.J., Tong, S.C., Gallop, R.A. and Pereira, R.R., Microwave pasteurization of raw milk. *J. Microwave Power*, 4, 272–275, 1969.
32. LeBail, A., Koutchma, T. and Ramaswamy, H.S., Modeling of temperature profiles under continuous tube-flow microwave and steam heating conditions. *Food Process Eng.* 23, 1–24, 1999.
33. Koutchma, T., LeBail, A. and Ramaswamy, H.S., Modeling of process lethality in continuous-flow microwave heating-cooling system, in *Proc. Int. Microwave Power Institute*, Chicago, 74–77, 1998.
34. Jaynes, H.O., Microwave pasteurization of milk. *J. Milk Food Technol.* 38, 3867, 1975.
35. Kudra, T., Van De Voort, F.R., Raghavan, G.S.V. and Ramaswamy, H.S., Heating characteristics of milk constituents in a microwave pasteurization system. *J. Food Sci.* 56, 931–934, 1991.
36. Chiu, C.P., Tateishi, K., Kosikowski, F.V. and Armbruster, G., Microwave treatment of pasteurized milk. *J. Microwave Power* 19, 269–272, 1984.
37. Choi, H.K., Marth, E.H. and Vasavada, P.C., Use of microwave energy to inactivate *Yersinia enterocolitica* and *Campylobacter jejuni* in milk. *Milchwissenschaft* 48, 134–136, 1993.
38. Choi, K., Marth, E.H. and Vasavada, P.C., Use of microwave energy to inactivate *Listeria monocytogenes* in milk. *Milchwissenschaft* 48, 200–203, 1993.
39. Sieber, R., Eberhard, P. and Gallmann, P.U., Heat treatment of milk in domestic microwave ovens. *Int. Dairy J.* 6, 231–246, 1996.
40. Lopez-Fandino, R., Villamiel, M., Corzo, N. and Olano, A., Assessment of the thermal treatment of milk during continuous microwave and conventional heating. *J. Food Prot.* 59, 889–892, 1996.
41. Villamiel, M., Corzo, N., Martinez-Castro, I. and Olano, A., Chemical changes during microwave treatment of milk. *Food Chem.* 56, 385–388, 1996.

42. Coronel, P., Simunovic, J. and Sandeep, K.P., Temperature profiles within milk after heating in a continuous-flow tubular microwave system operating at 915 MHz. *J. Food Sci.* 68, 1976–1981, 2003.
43. Sierra, I., Vidal-Valverde, C. and Olano, A., The effects of continuous flow microwave treatment and conventional heating on the nutritional value of milk as shown by influence on vitamin B1 retention. *Eur. Food Res. Technol.* 209, 352–354, 1999.
44. Nikdel, S., Chen, C.S., Parish, M.E., Mackellar, D.G. and Friedrich, L.M., Pasteurization of citrus juice with microwave energy in a continuous-flow unit. *J. Agric. Food Chem.* 41, 2116–2119, 1993.
45. Tajchakavit, S., Ramaswamy, H.S. and Fustier, P., Enhanced destruction of spoilage microorganisms in apple juice during continuous flow microwave heating. *Food Res. Int.* 31, 713–722, 1998.
46. Canumir, J.A., Celis, J.E., de Bruijn, J. and Vidal, L.V., Pasteurisation of apple juice by using microwaves. *Lebensm.-Wiss. u.-Technol.* 35, 389–392, 2002.
47. Burfoot, D., Griffin, W.J. and James, S.J., Microwave pasteurisation of prepared meals. *J. Food Eng.* 8, 145–156, 1988.
48. Burfoot, D., Foster, A.M., Self, K.P., Wilkins, T.J. and Philips, I., Reheating in domestic microwave ovens: testing uniformity and reproducibility. Microwave Science Ser. Rep. no. 3, Food Safety Directorate, Ministry of Agriculture, Fisheries and Food, London SE99 7TP, 1991.
49. Ohlsson, T. and Bengtsson, N.E., Dielectric food data for microwave sterilization processing. *J. Microwave Power Electromag. Energy* 10, 93–108, 1975.
50. Ohlsson, T., Sterilization of foods by microwaves, in *International Seminar on New Trends in Aseptic Processing and Packaging of Foodstuffs*. Munich, October 22–23, 1987.
51. U.S. Food and Drug Administration. 1977. [http:// www.cfsan.fda.gov/](http://www.cfsan.fda.gov/).
52. Kim, H.J. and Taub, I.A., Intrinsic chemical markers for aseptic processing of particulate foods. *Food Technol.* 47, 91–97, 99, 1993.
53. Prakash, A., Kim, H.-J. and Taub, I.A., Assessment of microwave sterilization of foods using intrinsic chemical markers. *J. Microwave Power Electromag. Energy* 32, 50–57, 1997.
54. Lau, M.H., Tang, J., Taub, I.A., Yang, T.C.S., Edwards, C.G. and Mao, R., Kinetics of chemical marker formation in whey protein gels for studying microwave sterilization. *J. Food Eng.* 60, 397–405, 2003.



# 29

## *Ultrasound in Food Processing and Preservation*

P.J. Torley and Bhesh R. Bhandari

### CONTENTS

29.1	Introduction .....	713
29.1.1	Sound Waves .....	714
29.1.2	Wave Characteristics .....	715
29.1.3	Cavitation .....	716
29.1.4	Liquid Flow and Bubble Movement .....	717
29.1.5	Sonochemistry .....	717
29.2	Ultrasound Instrumentation .....	718
29.2.1	Transducers .....	718
29.2.2	Ultrasonic Equipment .....	718
29.3	Ultrasound in Food Processing .....	719
29.3.1	Antimicrobial Treatment .....	719
29.3.1.1	Sensitivity of Different Microorganisms .....	719
29.3.1.2	Effectiveness as an Antimicrobial Treatment .....	719
29.3.1.3	Ultrasound Combined with Heat and Pressure .....	720
29.3.1.4	Processing Medium .....	721
29.3.1.5	Decontamination of Food Surfaces .....	722
29.3.1.6	Decontamination of Processing Surfaces .....	722
29.3.2	Enhancement of Mass Transfer .....	723
29.3.2.1	Drying .....	723
29.3.2.2	Osmotic Dehydration .....	724
29.3.2.3	Cheese Brining .....	724
29.3.2.4	Curing Meat Products .....	724
29.3.2.5	Membrane Filtration .....	725
29.3.3	Enhancement of Heat Transfer .....	726
29.3.3.1	Freezing .....	726
29.3.3.2	Thawing .....	726
29.3.3.3	Cooking .....	727
29.3.4	Processing of Protein Foods .....	727
29.3.4.1	Enzyme Inactivation .....	727
29.3.4.2	Changes in Protein .....	728
29.3.5	Ultrasound as a Processing Aid .....	728
29.3.6	Homogenization and Emulsification .....	729
29.3.7	Meat Tenderization .....	730
	References .....	732

### 29.1 Introduction

The effect that high-power ultrasound waves have on physical, biochemical, and microbial properties of food has attracted a great deal of interest in the recent years. This is because ultrasound can produce a variety of effects depending on the combination of ultrasound wave characteristics and product characteristics



that can be used to nondestructively characterize or to produce physical transformations. Ultrasound is important in many situations, including natural systems (e.g., communication by rats at ultrasonic frequencies (Brudzynski, 2005); echolocation by bats and dolphins; detection of ultrasound signals by fish and moths to avoid predators (Waters, 2003; Popper et al., 2004), engineering design to minimize cavitation (e.g., erosion of impellers in pumps (Bartz, 1993), nondestructive evaluation of manufactured products (Kundu, 2004), enhancing the efficiency of industrial processes (Shoh, 1988; Abramov, 1998), detection of underwater vessels and oceanography (Waite, 2002), identifying fish stocks (Horne, 2000), medical imaging (Wells, 1999), surgery (Kennedy et al., 2003), and physiotherapy (van der Windt et al., 1999). Many of the techniques used in these situations have parallels in food processing, where ultrasound can either be used to monitor processes while minimizing any effects on product characteristics, or to become directly involved in the process, helping bring about physical transformations in the product. This chapter will focus on the later aspect, and will include an overview of the history of ultrasound development, the basic principles underlying the effects of sonication on properties of food systems and the use of ultrasound in food processing, particularly microbial inactivation, heat and mass transfer, and homogenization.

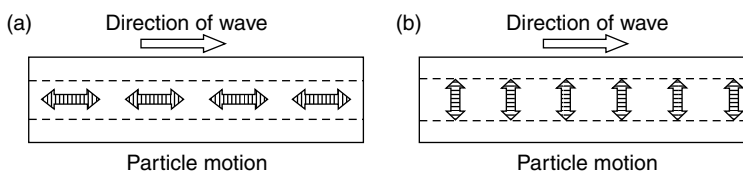
With such a broad range of applications, the history of ultrasound research, development, and application is extremely complex. Systematic studies of physical, chemical, and biological effects produced by ultrasound began in early 1900s. In 1917, Lord Raleigh developed a mathematical model for cavitation bubble collapse while investigating the problem of high-speed propeller erosion (Alliger, 1975). Also in 1917, Langevin discovered that sound rays killed fish while studying sonar for antisubmarine warfare. The late 1920s was also an important time in ultrasound research with potential application in the food industry, with a number of important ultrasound effects identified (Nyborg, 2000; Nyborg, 2001). During this time, various researchers reported that ultrasound could be used to rupture microorganisms; emulsify oil and water; atomize liquids; cause agitation inside individual plant, animal, and amoebae cells; accelerate chemical reactions; and degas liquids. Mechanisms to explain the effects of ultrasound were identified including: heating, agitation, aggregation, and cavitation (Nyborg, 2001). There are a number of reviews available that can be consulted for a more complete history of ultrasound development (Alliger, 1975; Nyborg, 1987; Nyborg, 2000; Wade, 2000; Nyborg, 2001).

### 29.1.1 Sound Waves

Ultrasonic waves are similar to sound waves, but their frequencies are far too high for perception by the human ear. Transmission of sound occurs due to ordered and periodical movements of the molecules of the media, with motional energy passed on to adjacent molecules without transfer of matter. Typically, the range of frequencies perceived by humans is 20 Hz to 20 kHz, while ultrasound is from about 20–1.2  $\times 10^{10}$  kHz (the highest frequency that can be transmitted by solids or liquids). Ultrasound has the properties of sound waves, such as reflection, interference, adsorption, and scattering, and can be propagated through solids, liquids, and gases [99,131].

Sound waves can be either parallel or perpendicular to the direction of travel through the material, and are termed as longitudinal and transverse waves, respectively (shear waves) (Figure 29.1). In transverse (shear) waves, particle motion is perpendicular to the direction of wave propagation. As liquids and gases do not support shear stress under normal conditions, transverse waves can only propagate through solids. The velocity of these waves depends on the material (Table 29.1) and is relatively low compared to longitudinal waves.

In longitudinal waves, the direction of particle motion is the same as the wave motion. These waves are capable of traveling in solids, liquids, or gases, and are thus widely used in ultrasonic applications.



**FIGURE 29.1** Types of sound wave: (a) longitudinal waves, (b) transverse (shear) waves.

**TABLE 29.1**

Velocity of Transverse and Longitudinal Ultrasound Waves in Different Materials

Material	Wave Type	State	Velocity (m/s)
Air	Longitudinal	Gas, 20°C	344
Aluminum	Longitudinal	—	6374
	Transverse	—	3111
Water	Longitudinal	Water vapor	500
		Water, 25°C	1498
		Ice	3760
		Ice	2000
Orange juice [69]	Longitudinal	Liquid, 20°C	1540
		Frozen, -20°C	3310
Beef (direction of ultrasound signal either parallel or perpendicular to muscle fiber orientation) [101]	Longitudinal	Warm, 37°C	
		Perpendicular	1595
		Parallel	1605
		Chilled, 0°C	
		Perpendicular	1525
		Parallel	1531
Fat content of meat mixtures [8]	Longitudinal	Frozen, -9°C	
		Perpendicular	2870
		Parallel	2930
		100% Lean meat	1543
Olive oil [102]	Longitudinal	50% Lean meat/50% fat	1584
		100% Fat	1617
		Liquid, 60°C	1490
		Solid, -30°C	1990

Longitudinal waves have short wavelength with respect to the transducer dimensions producing sharply defined beams, and have a high velocity (Table 29.1). The longitudinal velocity is dependent on the state of the material and so can be used to follow processes such as freezing of orange juice [69], meat [100], or solidification of fats [102]. It is also sensitive to differences in structure, such as fiber orientation in meat [101] and comminuted meat composition [8].

**29.1.2 Wave Characteristics**

The fundamental parameters that characterize ultrasound waves are velocity (*c*), wavelength (*λ*), frequency (*f*), amplitude (*A*), and intensity (*I*). Velocity is the propagation speed of a sound in a medium and is related to wavelength and frequency:

$$c = \lambda f \tag{29.1}$$

It depends on the physical properties of the medium through which waves propagate. For solids and liquid, velocity is related to density (*ρ*) and Young’s modulus of a solid, or bulk modulus of elasticity for a liquid (*K*):

$$c = \sqrt{\frac{K}{\rho}} \tag{29.2}$$

For gases, the relationship includes the pressure (*P*) and the specific heat at constant pressure (*C<sub>p</sub>*) and specific heat at constant volume (*C<sub>v</sub>*):

$$c = \sqrt{\frac{C_p P}{C_v \rho}} \tag{29.3}$$

Wavelength is the distance between adjacent wave crests (Figure 29.2), while frequency refers to the number of wave crests that pass a point in a unit time, and resembles the vibration of the wave generator. The ultrasound wavelength at 20 kHz frequency in water at 25°C is around 7.5 cm, whereas in more dense system (such as in muscle or bone) it will be higher and in the air it is around 1.65 cm.

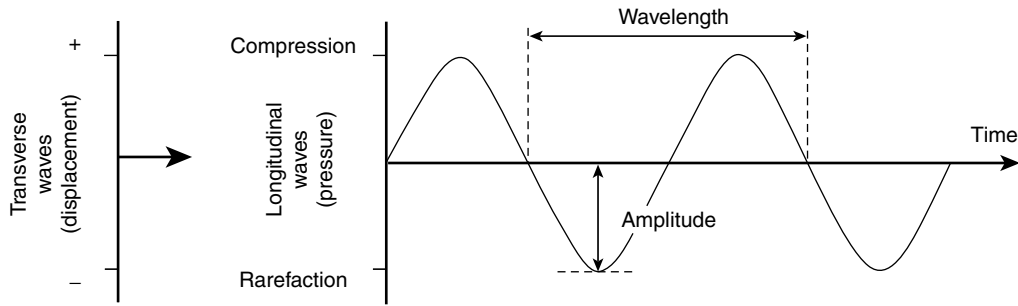


FIGURE 29.2 Transverse and longitudinal wave characteristics of ultrasound.

Amplitude is the height of the wave, and it determines the wave strength. Amplitude ( $A$ ) is related to the energy contained in the wave:

$$E \propto A^2 \quad (29.4)$$

Amplitude refers to the motion of the ultrasonic source, the motion of the receiver of the sound, or the motion of the media through which the sound wave is passing.

Intensity is a measure of the flow of acoustic energy through a unit area of the media in a unit time. As sound waves pass through any real medium or a biological tissue, the intensity of the signal decreases with distance of travel due to scattering of the sound waves and absorption of part of the sound energy by the material. The absorption of sound is due to a number of mechanisms: viscous losses, heat condition losses, and losses due to molecular exchange of energy [131]. Scattering is caused by interfaces between materials with differing acoustic impedances (sound reflection properties). The heterogeneity in a material can greatly increase attenuation when there are large differences in the density of the two materials, such as gas bubbles suspended in a starch water gel. The decrease in intensity ( $I$ ) follows an exponential pattern that depends on the initial intensity at the transducer ( $I_0$ ), distance from the transducer ( $x$ ), and the amplitude attenuation coefficient of the material ( $\alpha$ ):

$$I = I_0 e^{-2\alpha x} \quad (29.5)$$

The sound energy absorbed is converted into heat causing an increase in temperature. The heat production ( $Q_v$ ) is related to the intensity of the sound ( $I$ ) and the amplitude attenuation coefficient of the material ( $\alpha$ ):

$$Q_v = 2\alpha I \quad (29.6)$$

The amplitude attenuation coefficient varies between materials and with the frequency of the sound. Generally, the absorption coefficient increases with increasing frequency and in biological systems can vary markedly between materials [130].

### 29.1.3 Cavitation

In the liquid media, the best-known effect of ultrasound is cavitation. When an intense sound wave passes through a liquid, it creates regions of compression (positive pressure) and rarefaction (negative pressure). If the negative pressure during rarefaction is high enough, a cavity or bubble can form in the liquid. There are two main types of cavities: transient (also called “inertial”) and stable (also called “noninertial”). Each of them demonstrates a different type of behavior of a gas bubble that is subjected to an ultrasonic field [70].

Transient cavitation occurs when a cavity experiencing vibration increases in size progressively over a number of compression and rarefaction cycles, until it reaches a size where it collapses violently [124]. The bubbles grow during rarefaction and collapse during compression cycle when a critical bubble size is reached for that particular condition. During cavity collapse, there are occurrences of very high, but localized temperatures (theoretically estimated at up to 10,000 K), pressures (theoretically estimated at up to 100 MPa; experimentally estimated at 0.01–0.5 MPa) [1], and cooling rates ( $10^{10}$  K/s) [161]. It is also reported that an electrical field can occur at the interface when a cavity fragments [89].

Long-lived gas bubbles are called stable cavities and exist for many compression and rarefaction cycles [93]. They are produced at relatively low ultrasound intensities ( $1\text{--}3\text{ W/cm}^2$ ) and will oscillate for a number of cycles often nonlinearly about some equilibrium size without collapsing [92]. While the conditions within stable cavities are not as extreme as transient cavities, relatively high pressures and temperatures (estimated at about 1650 K) still occur, which allows them to contribute to influence chemical reactions.

Whether or not cavitation occurs depends on a variety of factors, including the frequency of the vibration (increasing frequency increases the power required to produce cavitation), intensity of the vibration (related to amplitude), solvent viscosity, surface tension and vapor pressure, attenuation of the vibration by the medium (greater attenuation at higher frequency), the presence of gas bubbles as cavitation nuclei, and the ambient temperature and pressure [92].

#### 29.1.4 Liquid Flow and Bubble Movement

Both the large and localized agitation produced by ultrasound is of considerable practical importance. Ultrasound agitation is the origin of at least part of the beneficial effect of ultrasound in processes such as heat and mass transfer, emulsification, cleaning of surfaces, and polymer degradation.

Microstreaming occurs due to the growth and shrinkage of the cavitation bubbles during cycles of rarefaction and compression [67]. The rapid movement of liquid caused by changing bubble size causes shear; however, the effect is limited to about one bubble diameter. Microstreamers are bubbles that form at a nucleation site, and then move through the acoustic field to a pressure antinode (if the bubble diameter is less than resonance size) or pressure node (if larger than resonance size) [45,67,70]. Resonance size is determined by the properties of the liquid and acoustic wave frequency, and is the size where the applied frequency produces large changes in bubble diameter. Owing to differences in the speed of bubble movement depending on whether they are in the compression or rarefaction part of the acoustic wave, microstreamers are able to move faster than the average liquid velocity.

When transient cavitation bubble collapses, there is a rapid inflow of liquid from all sides causing high localized shear rates and shock waves in the surrounding liquid [92]. If a transient cavitation bubble collapses when it is close to a solid surface, a microjet is formed. In this situation, the solid surface means the liquid is not able to flow in from all sides, creating nonsymmetrical flow that directs a microjet of liquid at the solid surface [11,70,90]. The jet of liquid has a relatively high velocity (about 100 m/s), though it is a relatively short-range effect (about a bubble diameter) [67]. Depending on the circumstances, microjets may have advantageous effects (e.g., cleaning surfaces, pitting, and increasing surface area for reaction), while in other situations they may be damaging (e.g., pitting of ultrasound probe tips and erosion of propellers). An analogous situation occurs at the interface between two immiscible liquids, where microjets can form an emulsion.

There can also be movement of bubbles in acoustic fields due to the density difference between the gas bubble and the liquid medium. When the cavity forms, gas can progressively diffuse into it from the surrounding medium, or the bubble can coalesce with other bubbles, progressively increasing size until it floats to the surface. This is the basis of ultrasound degassing of liquids [91].

#### 29.1.5 Sonochemistry

Sonochemistry is the term for chemical reactions performed under an acoustic field, commonly ultrasonic. The field has developed as it has been found that ultrasound produces a range of effects on chemical reactions in treated materials, including free radical formation, increased reaction rates, less extreme processing conditions (e.g., lower bulk temperature and pressure), reduced induction period, easier initiation of difficult reactions, improved catalyst efficiency, permit use of less refined raw materials, reduced number of processing steps, alteration of the reaction pathway, and sonoluminescence [45,88,90,92]. Sonoluminescence is the light emitted during the collapse of either stable or transient cavities due to the pressures and temperatures generated [187].

Within the collapsing cavity there are extreme pressures, temperatures, and cooling rates, along with gas or vapor from the liquid medium. These conditions are capable of creating hydroxyl radicals from water, which can react with other chemicals in the cavity, or diffuse into the liquid medium where they

can react with other compounds. Other reactions are possible if there is a volatile compound present in the liquid medium. The volatile compound can diffuse into the cavity during expansion and can undergo chemical reactions during collapse of the cavity.

In addition to chemical reactions caused by the diffusion of reactive species or reaction products into the liquid medium, cavity collapse can affect the chemical reactions in the liquid medium. The high shear created by cavity collapse may also cause breaks in polymer chains, increase reaction rates due to an increase in the kinetic energy of molecules, or alter interaction within the solvent.

Ultrasound waves can alter chemical processes at surfaces, with different effects depending on whether they are large, small, or liquid surfaces. There can be mechanical damage to the solid material, with shock waves and microjets causing surface damage, including pitting of solid surfaces, fragmentation of brittle materials, deaggregation of groups of particles, and high-velocity collisions between small particles accelerated by ultrasound causing, in some instances, abrasion and in others, fusion. Changes such as these can alter chemical reactivity, for example, through increased surface area, removal of contamination from the solid surface such as oxidation from metals. With immiscible liquids, cavitation at their interface can create emulsions greatly increasing the area of contact between the two materials.

While the main focus of sonochemistry is the cavitation-related effects, the noncavitation-related effects of ultrasound can play a role in chemical reactions. Ultrasound agitation of liquids improves mass transfer and heating of the material due to energy absorbed from the ultrasound waves can both increase the rate of chemical reactions.

---

## **29.2 Ultrasound Instrumentation**

### **29.2.1 Transducers**

A transducer is a device that converts one form of energy into another form. In ultrasonic applications, the transducers are designed to convert mechanical or electrical energy into high-frequency sound. There are two main types of transducers: mechanical and electroacoustic [1]. Mechanical transducers rely on either the flow of a liquid or gas through a siren, rotor, turbine, or whistle to generate ultrasound. Electromechanical transducers are widely used in modern ultrasonic applications and are based on the inherent electrostrictive phenomenon in certain materials to produce piezoelectric or magnetostrictive transducers [1].

### **29.2.2 Ultrasonic Equipment**

There are different types of ultrasonic apparatus commercially available for small- or large-scale power ultrasound applications, including whistle reactors, ultrasonic baths, and probe systems [91,92]. A whistle reactor uses a mechanical ultrasonic source that relies on a stream of liquid flowing past a metal blade to cause vibration [91,92]. The frequency of the vibration depends on the liquid flow rate, with flow rates high enough to be able to generate ultrasound, which can cause cavitation in the liquid. These sorts of systems can be used for high-power liquid processes such as homogenization, emulsification, and dispersion.

Ultrasonic baths are cheap, simple, and versatile, being made up of a metal bath with one or more transducers attached to the walls of the tank [90–92]. Items can be directly immersed in the bath for ultrasound treatment, though the maximum power input is generally relatively low (about 1–5 W/cm<sup>2</sup>).

Probe systems consist of a metal horn coupled to ultrasonic transducer, with the metal horn used to amplify the vibration produced by electrostrictive material (normally piezoelectric) in the transducer [1,124]. Amplifying the vibration produced by the transducer is necessary as the amplitude of waves produced by piezoelectric materials is too small to have a useful effect. An appropriate horn design will increase the amplitude of the vibration at the face of the horn. Probe systems have the advantages that they can be placed directly in or against the material being processed; their power can be controlled and can produce ultrasound intensities of up to several hundred W/cm<sup>2</sup> [90,91,93]. Disadvantages of the probe system include erosion of the horn tip by cavitation, free radical formation, and heating of the material exposed to ultrasound. Tip erosion by cavitation can cause contamination of the material by metal from the horn as well as a gradual change in horn length, which will affect its efficiency.

A number of systems have been developed to overcome some of these limitations, including the cup horn, flow cell, and tube reactor. The cup horn system contains an ultrasound probe that incorporates a cooling

system [90], with the cooling liquid (typically water) used as the coupling medium to transmit vibrations from the probe tip to the reaction vessel. This approach allows better temperature control than bath or simple probe systems, though the reaction vessel size is limited and power input into the reaction vessel is reduced compared to a probe placed directly in the material being processed. The flow cell is a continuous system where the ultrasound probe is placed directly in a liquid that is being pumped through a cell, with treatment only occurring while the liquid is inside the cell [90,92]. This allows high-intensity treatment and control over the temperature rise by controlling the residence time of the liquid. In tube reactors, the liquid is treated with ultrasound as it is pumped through a zone fitted with some form of ultrasound generator [92].

---

### 29.3 Ultrasound in Food Processing

Application of ultrasound in food processing has been of interest for many years, with researchers investigating its potential as a means of monitoring a process or product, or as a way of altering the properties of a process or product.

Low-power, high-frequency ultrasound ( $<1 \text{ W/cm}^2$ ;  $>100 \text{ kHz}$ ) is normally used to monitor food products or processes. The use of ultrasound monitoring has been evaluated in a wide range of food systems, including meat, fats and oils, milk, bread, fruit, and sauces [64,99,130,131], with various parameters, particularly velocity (m/s), attenuation (dB/m), and impedance (kg m/s) or related parameters, used to measure characteristics such as composition, phase changes, and particle size distribution.

High-power, low-frequency ultrasound ( $10\text{--}1000 \text{ W/cm}^2$ ;  $20\text{--}100 \text{ kHz}$ ) is normally used to alter the properties of a material or affect the progress of a process. It does this through physical, chemical, and mechanical effects (Table 29.2). Ultrasound can affect food properties; however, it is common to use it in combination with other processing technologies to improve the efficiency of the process.

#### 29.3.1 Antimicrobial Treatment

The use of ultrasound as an antimicrobial treatment, either alone or in combination, has been of interest for many years for use in food products, or to remove contaminating microorganisms from foods and processing surfaces [31,32,86,125,134,142]. The antimicrobial effect of ultrasound is largely due to the localized, but extreme, pressures and temperatures ( $50 \text{ MPa}$ ,  $5500^\circ\text{C}$ ) produced during cavitation leading to damage to cell walls [86], with possible contributory effects due to direct thermal effects from the localized heating, production of free radicals causing damage to DNA, and microstreaming causing thinning of cell membranes [31,32,86,125,134,142].

##### 29.3.1.1 Sensitivity of Different Microorganisms

Ultrasound treatment has been shown to be an effective antimicrobial treatment, destroying a variety of microorganisms, including bacteria [2,125,149], bacterial spores [41,123,135], yeasts [19,79,166], fungi [34,48,149], fungal spores [80], protozoa [119], and viruses [149].

Comparative studies of the sensitivity of different microorganisms show that the effectiveness of ultrasound varies widely, with even closely related microorganisms showing differences in sensitivity. In general, spores [2,41,112,123,135] and some viruses [149] are difficult to inactivate with ultrasound. Gram-positive bacteria are less sensitive to ultrasound than Gram-negative bacteria [2,122,173], though no difference between Gram-positive and Gram-negative bacteria has been reported [149]. It has also been observed that rod-shaped bacteria tend to be more susceptible than coccus-shaped bacteria [122], and that larger cells are more susceptible than smaller cells [32].

##### 29.3.1.2 Effectiveness as an Antimicrobial Treatment

While ultrasound used by itself can kill microorganisms, it is a relatively inefficient process, with extended processing times required to produce a significant reduction in microbial numbers. As a result, research into ultrasound as an antimicrobial treatment has largely focused on combining ultrasound with other treatments, particularly heat treatment (also termed thermosonication), pressure treatment (manosonication),

TABLE 29.2

Some Applications of High-Power, Low-Frequency Ultrasound in the Food Industry

Application	Description	References
Anti-microbial Effects	Microbial destruction, microbial removal from surfaces	[25,32,44,54,73,75,86,118,125,132,134,151,152]
Heat transfer	Increase the rate of freezing, thawing, and cooking	[12,61,71,72,103,126,128,160,191]
Mass transfer	Increase the rate of mass transfer in drying (solid, liquid, and osmotic drying), brining, membrane separation, dewatering, and bed filtration	[5,20,22,27,28,33,36,38,39,40,47,62,63,66,95,98,107,108,109,110,111,136,139,145,146,147,156,163,164,176,180,188,189]
Meat processing	Meat tenderisation	[26,27,28,43,81,82,83,84,126,127,128,158]
Homogenization, emulsification and encapsulation	Homogenise and emulsify milk, mayonnaise	[14,50,53,57,91,141,174,175,182]
Fermentation and aging	Increase rate of fermentation and aging (e.g., wine)	[15,16,17,18,96,97]
Crystallization	Control of nucleation and crystal growth	[91,94,143,154]
Cutting	Cut fresh and frozen food products, including composite or multilayer foods	[138]
Defoaming, defrothing, and degassing	Defoam carbonated drinks, beer and other liquids during canning; defoam microbial fermenters; remove dissolved gasses from liquids	[1,38,91]
Cell disruption and extraction	Enhance extraction of compounds (e.g., enzymes, proteins, fruit juices, essential oils)	[3,34,58,59,60]
Enzyme activity and protein denaturation	Enzyme inactivation; protein denaturation; enhance enzyme activity	[6,21,24,35,76,77,78,120,137,144,168,170,171,172,174]
Polymerisation and depolymerisation	Polymerisation and depolymerisation of polymers	[93,161,162]

and combined heat and pressure treatments (manothermosonication) [31,32,134], with less attention paid to its use with other treatments such as pulsed electric fields, antimicrobial chemicals, and pH [2,142].

The lengthy processing required to destroy some microorganisms and particularly spores at temperatures well below the temperatures used for conventional thermal treatment makes ultrasound an unattractive treatment. As for example, the D value of vegetative *Staphylococcus aureus* treated with ultrasound (20 kHz, 150 W, 40 mL sample volume) was 36.5 min at 11.2°C in phosphate buffer, and 187 min at 13.5°C when suspended in ultraheat-treated milk [116].

Ultrasound treatment of bacterial spores can have little effect at low temperature, with no reduction in *Bacillus stearothermophilus* spore numbers by an extended ultrasound treatment at 12°C (20 kHz, 120 W, 50 mL sample volume), though there is the release of low-molecular-weight materials [123]. *Clostridium sporogenes* and *Bacillus cereus* spores suspended in Ringer solution survived sonication (20 kHz, 500 W, 35°C) for 30 min, though combining ultrasound and 6% H<sub>2</sub>O<sub>2</sub> proved an effective treatment [2]. Ultrasound was also reported to have no significant effect on the survival of *Clostridium botulinum* spores in honey [112].

Ultrasound produces a variety of effects that can be applied in dairy processing [175]. One effect that has been examined closely is its ability to inactivate microorganisms when used in combination with a heat treatment to give an effective method for the destruction of microorganisms present in milk [117,173,184,190].

### 29.3.1.3 Ultrasound Combined with Heat and Pressure

Combining ultrasound with either pressure, temperature, or pressure and temperature treatments has proven a particularly popular approach as the length of ultrasound treatment can be substantially reduced [31,32,134].

Simply combining ultrasound with mild heat treatments has been found to increase the rate of microbial inactivation in a variety of microorganisms. *Streptococcus faecium* and *Streptococcus durans* had D value at 62°C (heat only) of 11.2 and 10.3 min, respectively, while simultaneous heat and ultrasound (62°C, 20 kHz, 160 W) reduced D values by 84% and 91%, respectively [114]. Yeast cells are destroyed more rapidly by a combined ultrasound and temperature treatment [19]. The D time for *Saccharomyces cerevisiae* was reduced by up to 63% by combined ultrasound (20 kHz, up to 180 W, 300 mL sample volume) and heat treatment (50°C or 55°C) compared to heat only treatment [19]. The combined treatment was also successful with bacterial spores. The D value of *Bacillus subtilis* spores at 100°C was reduced by 38%–84% (depending on strain and medium) by a combined heat and ultrasound treatment [41].

A limitation of combined ultrasound and thermal processing is that its effectiveness decreases with increasing temperature, as the increase in vapor pressure and the decrease in liquid surface tension [41] reduce the cavitation effect [32]. To overcome this problem, processes combining ultrasound and pressure treatment, or ultrasound, pressure, and thermal treatments have been developed [32]. By pressurizing the material, cavitation can occur at higher temperatures increasing the efficiency of microbial inactivation.

Even at temperatures well below the boiling point of the medium, using pressure during ultrasound treatment will affect microbial destruction. When different bacteria were treated by ultrasound (20 kHz, 117  $\mu\text{m}$  amplitude, 40°C), increasing the pressure from 0 to 400 kPa produced substantial different decreases in D value for *Streptococcus faecium* (D value about 11 min at 0 kPa; 5 min at 100 kPa, 1.8 min at 400 kPa), *Listeria monocytogenes* (3.5, 2, and 0.8 min), *Salmonella enteritidis* (2, 1, and 0.4 min), and *Aeromonas hydrophila* (1.3, 0.8, and 0.4 min) [122]. However, when the results are expressed as a percentage, the variation in decrease in D value is somewhat smaller, with decrease in D value of 39%–55% between 0 and 100 kPa, and 72%–84% between 0 and 400 kPa [122].

Even closely related microorganisms show some difference in response to combined pressure and ultrasound treatment. When three *Salmonella* serotypes were ultrasound treated (20 kHz, 117  $\mu\text{m}$  amplitude) at 40°C, increasing pressure from 0 to 50 kPa, the D value was reduced by 24%–48% (depending on serotype), though at higher pressures the variation between serotypes was smaller. Increasing treatment pressure from 0 to 250 kPa decreased D value by 65%–72% [87].

Combining pressure and thermal treatments further increases the antimicrobial effect of ultrasound. A combined pressure, thermal, and ultrasound treatment (20 kHz, 117  $\mu\text{m}$  amplitude, 175 kPa) of *Salmonella enteritidis* gave D values that were lower than a combined thermal and ultrasound treatment at the same temperature [4]. The improvement from the combined pressure, thermal, and ultrasound treatment gave D values 68%–91% lower at or below 60°C than the combined thermal and ultrasound treatment, but only 0%–44% above 60°C.

The sensitivity of bacterial spores can also be increased by a combined pressure, thermal, and ultrasound treatment. When *Bacillus subtilis* spores were pressure- and ultrasound-treated (200 kHz, 117  $\mu\text{m}$  amplitude, 300 kPa) at 55°C and 70°C, only about 20% of the spores survived, while the heat-only treatment saw about 100% survival at the same temperatures [135].

#### 29.3.1.4 Processing Medium

The processing medium also plays an important role in determining the effectiveness of ultrasound as an antimicrobial treatment. When *Staphylococcus aureus* suspended in phosphate buffer received combined heat and ultrasound (20 kHz, 150 W, 40 mL sample volume) treatment, the D value was reduced by 60%–65.5%, while the same treatment was less effective when suspended in milk, reducing the D value by 41%–47% compared to a heat-only treatment [116]. A similar effect was seen with *Salmonella typhimurium*, where the number of survivors after ultrasound treatment was substantially higher in liquid egg (50% survival after treatment at 20°C for 15 min and 32% at 40°C) than skim milk (87% at 20°C and 19% at 40°C) or brain heart infusion broth (6% at 20°C and 16% at 40°C) [184].

Water activity can affect the effectiveness of ultrasound, with ultrasound proving more effective at higher water activity. When *Salmonella enteritidis* was treated with ultrasound (20 kHz, 117  $\mu\text{m}$  amplitude, 58°C), the D value increased with decreasing water activity, from 0.22 min at a water activity above 0.99, to 1.53 min at water activity of 0.98 and 4.56 min at a water activity of 0.96 [4]. A similar pattern of increasing D value with decreasing water activity was also seen in samples exposed to a combined pressure, thermal, and ultrasound treatment (20 kHz, 117  $\mu\text{m}$  amplitude, 175 kPa) [4]. While the water



activity was not reported, incorporating 57% sucrose into the broth used to suspend *Listeria monocytogenes* before pressure and ultrasound treatment (20 kHz, 117  $\mu\text{m}$  amplitude, 200 kPa, 40°C) increased the survival time, though adding 3% NaCl had no effect on survival time [121].

The pH of the medium can alter the effect of ultrasound treatment, with decreasing pH tending to reduce the survival of bacteria and yeasts [142]. Differences in the pH range of the ultrasound medium may help explain the relative small variation in ultrasound's effectiveness against *Escherichia coli* suspended in UHT milk (pH 6.7), carrot juice (pH 5.9), or phosphate buffer (pH 7.0), and greater variation for *Lactobacillus acidophilus* suspended in either orange juice (pH 3.7) or phosphate buffer (pH 7.0) [190]. The survival of *Listeria monocytogenes* also decreased with a decrease in medium pH when treated with ultrasound (20 kHz, 117  $\mu\text{m}$  amplitude, 200 kPa, 40°C), going from about  $3.7 \times 10^5$  cfu/mL to  $2.6 \times 10^3$  cfu/mL at pH 7, and from about  $3.8 \times 10^5$  cfu/ml to  $6.6 \times 10^2$  cfu/mL at pH 4 [121]. However, the decrease in pH had a much greater effect on the survival of *Listeria monocytogenes* when the samples were treated with heat (62°C) instead of ultrasound.

Differences in the viscosity of different mediums may also explain some of the differences seen. The relatively higher survival of microorganisms in more viscous liquids is observed due to their high viscosity protecting the microorganism by reducing cavitation. Ultrasound treatment was much less effective at reducing the level of *Salmonella eastbourne* suspended in milk chocolate than in peptone water [68]. Other studies have also shown that more viscous media can improve microbial survival, with slower destruction of *Bacillus subtilis* spores in glycerol than milk [41], and in egg than other media [87,116,184].

### 29.3.1.5 Decontamination of Food Surfaces

Raw fruit and vegetables used in some types of minimally processed foods have spoilage and possibly pathogenic microorganisms adhering to or entrapped in their surfaces. It is common to wash in water or water containing a sanitizer (typically 50–100 ppm chlorine) to reduce this microbial load. However, effective sanitizing is difficult as the bacteria can be difficult to destroy or remove as they are attached or entrapped in the uneven surface of the plant matter. Ultrasound can be incorporated in the sanitizing process to improve the effectiveness of the washing process, with combined ultrasound (32–40 kHz, 10 W/L of water) and chlorinated water giving a larger reduction (1.7 logs) in *Salmonella typhimurium* numbers on iceberg lettuce than ultrasound alone (1.7 logs), chlorinated water alone (1.6 logs), or washing in sterile water (0.7 logs) [152]. Larger scale trials found that the product (parsley, strawberries, cabbage, and lettuce) and washing medium (water only, chlorinated water, or chlorinated water with a surfactant) had an effect on decontamination, while ultrasound frequency (0 kHz, 1.0 log reduction; 25 kHz, 1.4 logs; 32–40 kHz, 1.3 logs; and 62–70 kHz, 1.3 logs) had no effect on decontamination [152].

Ultrasound treatment was found to be effective at reducing the concentration of *Salmonella typhimurium* on chicken breast skin [73]. Decontamination treatments in a chlorine solution (0.5 ppm free residual chlorine) reduced *Salmonella typhimurium* contamination by 0.2–0.9 logs, while ultrasound treatment (20 kHz, 100 W) reduced counts by 1–1.5 logs. A combination of 0.5% ppm chlorine and ultrasound treatment was the most effective, reducing *S. typhimurium* by 2.4–3.9 logs.

Combined chemical (acetic acid) and ultrasound treatments (frequency not given; 240 W; up to 320 s), have also been used to clean eggshells [44]. The ultrasound and acetic acid treated eggs were as clean as commercially washed eggs, and ultrasound- and acetic acid-treated eggs had the same sensory properties and foaming ability, and gave cakes with the same height as eggs cleaned in acetic acid without ultrasound.

### 29.3.1.6 Decontamination of Processing Surfaces

Cleaning of surfaces used for food processing is also important, as they can be a cause of cross-contamination. Ultrasound treatment can improve the removal of microbial spores from surfaces [25,54]. However, the effectiveness of ultrasound recovery is affected by factors, including the material, treatment time, type of microorganism, and presence of surfactants [25,54,75]. The material can affect recovery substantially, with the recovery of fungal (*Aspergillus niger*) spores from PVC (50%), frosted glass (60%), and plain glass (80%) being higher than stainless steel (10%) or HDPE (10%) [54]. There was similar variation in recovery of bacterial (*Bacillus subtilis*) spores, with high recovery from glass (96%),

and lower recoveries from the plastics (polystyrene, 24%; polypropylene, 53%; polyethylene, 41%; and polycarbonate, 46%) [25]. Addition of a surfactant (Tween 80) enhanced ultrasound recovery for polystyrene (42%) and polyethylene (75%), but had little effect on glass (92%), polypropylene (51%), and polycarbonate (43%).

Ultrasound treatment has also been shown to be effective at removing protein contamination from knives in abattoirs [151] and milk biofilms on stainless steel and polypropylene dairy processing equipment [118]. A number of studies have demonstrated the use of ultrasound in cleaning cheese molds [179]. In a practical investigation in a commercial chicken processing plant, ultrasound-assisted cleaning of plastic trays, steel baskets, and steel shackles was effective at reducing microbial and other contamination [132].

### 29.3.2 Enhancement of Mass Transfer

Mass transfer plays an important role in many industrial processes, such as drying, dewatering, filtration, membrane separation, salting, and osmotic dehydration. Ultrasound has been shown to improve the efficiency of many mass transfer processes either through a direct involvement in the process (e.g., cavitation, microstreaming or acoustic streaming causing agitation to improve mass transfer, cavitation creating voids in the material), or support of the process (e.g., agitation or microjet formation to assist cleaning). There has been substantial research into the ultrasound-assisted drying, membrane filtration, and osmotic dehydration, along with the related processes of cheese brining and meat curing. There has also been substantial research into industrial applications of ultrasound-assisted bed filtration and dewatering [33,39,109,164,188], where it has been shown that ultrasound can substantially improve the efficiency of dewatering or filtration systems.

#### 29.3.2.1 Drying

Drying is a mass transfer process involving the removal of liquid from a material, with the rate of drying dependent on factors such as the structure of the material, temperature, relative humidity of the air, and air velocity. In selecting drying conditions, it is necessary to find a balance between conditions that maximize the drying rate and minimize any undesirable changes these conditions will cause in the product.

As a result of the effects of ultrasound on material properties, incorporating ultrasound into the drying process can increase the rate of drying by reducing external barriers causing agitation in the drying medium close to the solid surface that reduces the thickness of the boundary layer [107,109] and internal barriers by enhancing internal liquid movement from the core of the material to the surface due to repeated compression and expansion or the creation of microchannels in solid that permit liquid movement [107]. Combining ultrasound and air drying has been shown to enhance the rate of drying in various products, including carrots slices [40], onion slices [22], potato cylinders [5], wheat [47], corn [47], rice [108], and walleye pollack surimi (washed fish mince) [111].

While ultrasound is normally used with solids or liquids, as they provide a good medium for the propagation of ultrasound, various systems have been developed that will generate ultrasound in gases, such as the Galton whistle or a siren [93], or a piezoelectric transducer with radiating plate. Stepped-plate radiating plate designs have been developed, which improve the efficiency of ultrasound generation when compared to conventional flat plate designs [38].

The effectiveness of sound or ultrasound frequency and intensity tend to depend on the particular combination of material, drying conditions, and ultrasound system. For example, in some instances in onion rings, drying rate increased with an increase in sound frequency from 1.6 to 3.2 kHz (both at 140 dB) [22], while for green rice there was little difference between 12 and 19 kHz, though relatively low intensities were used (132 and 128 dB, respectively) [108]. With potato cylinders dried with combined hot air (120°F) and sound (0.7–10.25 kHz), a sound frequency of 8.1 kHz was found to be most effective [5]; however, due to the experimental setup used, the sound intensity decreased with increasing frequency (142 dB at 0.7 kHz and 102 dB at 10.25 kHz), making the results more difficult to interpret.

The greatest benefit from combining ultrasound and air drying occurs at lower temperatures. In carrot slices, a combination of ultrasound and 60°C air took about 25 min to reduce carrot slice weight by 80%, while 60°C air alone took about 35 min [40]. By contrast, combined ultrasound and 115°C air drying gave no benefit over drying in 115°C air alone. In walleye pollack surimi drying, combined ultrasound

and air-drying rate reduced the time to dry from 73% moisture to 60% moisture at 20°C from 260 min (0 dB) to 70 min (155.5 dB), while at 50°C drying time reduced from 100 min (0 dB) to 40 min (155.5 dB) [111]. A similar pattern, where the benefit from ultrasound treatment (11.7 kHz; 165 dB) decreased with increasing drying temperature, was also seen in whole and crushed wheat and crushed corn [47].

Another application of ultrasound in drying has been to assist the drying of liquid droplets. Incorporating ultrasound in a spray-drying tower reduced the maximum temperature of the material during drying and reduced the size of the dried particles [189]. Ultrasound has also been used to further reduce the size of droplets originally produced by spraying a liquid through a nozzle, reducing the drying time required [20].

### **29.3.2.2 Osmotic Dehydration**

Osmotic dehydration is a food preservation technology that involves soaking food products (generally fruits and vegetables, though also with cheese and meat) in a concentrated solution (e.g., NaCl and sugar). In a relatively slow process, water moves from the product into the high-concentration solution, solutes move from the solution into the product, and there is movement of solutes from the plant cells into the high-concentration solution [107,133,136,153]. Osmotic dehydration can improve sugar-to-acid balance, texture, and color stability and is typically used as a pretreatment before freezing or drying [136].

Ultrasound treatment has proven to be an effective technique at increasing the rate of osmotic dehydration. When apple cubes were dehydrated in a 70°Bx sucrose solution, the rates of water loss and sucrose gain were higher than in samples agitated in an oscillating water bath [156]. Ultrasound treatment was also able to increase the rate of osmotic dehydration of strawberry halves [163]. In strawberries that had been pretreated with high pressure, a combination of osmotic dehydration and ultrasound treatment (35 kHz water bath) increased the water loss and solids gain compared to osmotic dehydration alone, though a combination of osmotic dehydration and vacuum was the most effective treatment.

Not all products respond in the same way to ultrasound-assisted osmotic dehydration. Differences in water loss or solids gain in products treated with osmotic dehydration or a combination of ultrasound and osmotic dehydration has been attributed to differences in the structure of the food product [107].

### **29.3.2.3 Cheese Brining**

The manufacture of some types of cheese and cured meats relies on the penetration of brine into the food product, as the salt alters the flavor and texture development, reduces water content, improves microbial safety, and contributes to the maturation of the product [145]. When brining is used with larger items, the process can be time consuming as mass transfer can be relatively slow. Various methods can be used to improve the rate of brine penetration, such as agitation or tumbling, vacuum, increased brine concentration, increased brining temperature, ratio of brine to product, and needle injection. However, it is important to maintain finished product quality. For example, injection of brine directly into meat using multineedle injectors is common in meat processing, but the path where the needle penetrated is sometimes obvious in the cooked product.

Ultrasound can improve the brining process in cheese, increasing the rate of water loss and NaCl gain from small cheese blocks (cylinders 34 mm in diameter and 30 mm high; parallelepipeds of 60 mm × 25 mm × 12.5 mm) [145]. The benefit of ultrasound occurred over a range of temperatures (5°C–20°C), and when compared to static or agitated brining. In larger samples (parallelepipeds of 140 mm × 140 mm × 90 mm), ultrasound treatment increased the initial NaCl penetration particularly at the surface [147]. However, the moisture content diffusion rate was lower in ultrasound-treated cheese than conventionally treated cheese, and both ultrasound and conventionally brined cheeses reached a consistent NaCl distribution after the same maturation time [147]. The use of ultrasound brining can affect other characteristics, with more rapid formation of free amino acids and free fatty acids [146] during maturation of acoustically brined cheeses, and differences in the sensory texture, aroma, odor, and taste between ultrasound and conventionally brined cheeses [146], though no differences were found in cheese microstructure [147].

### **29.3.2.4 Curing Meat Products**

The functional properties of many processed meats rely on the partial solubilization of muscle protein in the raw meat (generally by NaCl or a combination of NaCl and polyphosphate) to increase the cook yield and hold meat pieces together after cooking. One common approach used to make restructured meat

products containing large pieces of meat is to tumble (mix) the meat chunks with the salts (added either the dry salts, or dissolved to form a brine), relying on the mechanical action to distribute the salts through the meat and solubilize part of the meat protein. The tumbling process is time consuming, requiring several hours, and ultrasound has been used to reduce or eliminate the tumbling process.

A combination of treatment with ultrasound and tumbling gives products with equal or higher bind strengths and cook yields than meat tumbled without ultrasound [139,176]. The increase produced by the combined ultrasound and tumbling treatment varies, with the largest increases occurring in meat with no added salt, with the effectiveness of ultrasound progressively decreasing [139] or disappearing [176], and with increasing level of salt addition. Ultrasound also proved effective in meat when used without any tumbling. In meat injected with a brine, either a conventional tumbling process or ultrasound treatment (22 kHz) was used to distribute the brine through the meat [28]. The ultrasound-treated meat was more tender and juicy, with a higher production yield, than tumbled meat.

In all studies, ultrasound treatment affected the microstructure of the product, with greater separation of myofibrils occurring in the ultrasound-only [27], or combined ultrasound and tumbling samples [139,176] than in the tumbling-only samples.

### 29.3.2.5 Membrane Filtration

Membrane separation techniques such as microfiltration, ultrafiltration, and reverse osmosis are widespread in food processing to concentrate or purify materials for the dairy, beverage, and egg industries [23,42,55]. A disadvantage of membrane separation techniques is that they show a progressive decrease in flow rate due to fouling and concentration polarization. Fouling is a result of components from the feed being deposited on the surface or pores of the membrane, while concentration polarization occurs due to concentration gradients that develop due to accumulation of retained components near the membrane [66]. Membrane system are operated to minimize these problems so that they maintain their flow rate over the course of a day's processing (e.g., periodic flushing to remove fouling and feed flow velocity and turbulence to minimize concentration polarization) [42], and many strategies are employed to clean membrane systems [29]. Ultrasound can be used to improve the efficiency of both the membrane filtration process [36] and cleaning of fouled membranes [66]. Ultrasound-assisted membrane processing has been used successfully with a variety of food-related systems, including solutions of salt, polysaccharides and proteins, and yeast cell suspensions.

Membrane distillation is a process involving membrane separation of a vapor and liquid, for example, in desalination or concentration of solutions. Ultrasound increased permeate flux during membrane distillation by 5%–30% compared to the conventional process [193,194]. In addition to ultrasound's effect on concentration polarization and fouling found in other membrane separations, combining ultrasound with membrane processing also reduces temperature polarization (temperature gradient between bulk liquid and membrane).

The filtration of suspended solids can also be enhanced by ultrasound treatment. There was a higher flux when ultrasound was used in conjunction with microfiltration to dewater yeast cells suspended in water [30]. The benefit of ultrasound decreased as the liquid feed velocity increased, and at 0.53 m/s there was no additional increase in flux due to ultrasound [30]. Ultrasound treatment improved permeate flux during the microfiltration of baker's yeast suspensions with either continuous pump pressure and ultrasound, or intermittent pump pressure and ultrasound, and was also effective at cleaning a membrane that had been fouled during no ultrasound processing [98].

The use of ultrasound in preventing or removing fouling of membranes [66] depends on ultrasound parameters (e.g., ultrasound frequency and intensity), the filtration system (e.g., intermittent or continuous ultrasound application during filtration, conditions during cleaning cycle, and acoustic properties of the filtration membrane), attenuation of the ultrasound signal by the feed material, size of colloidal particles in the feed material, and the cavitation threshold of the feed material (viscosity, temperature, surface tension, pressure, dissolved gases, and concentration). Ultrasound treatment does not affect membrane permeability, rather it helps prevent the decrease in permeate flow rate by breaking up fouling at the membrane surface or reducing the concentration polarization, though it may be less effective at removing material stuck in membrane pores [66].

One limitation of ultrasound in membrane processing is the potential for damage to the membrane through processes such as cavitation-induced erosion, acoustic streaming, and microstreaming. Some

studies have shown that ultrasound affects membranes altering both permeability and microstructure, while others have found no effect [66]. This may be due to differences in susceptibility to ultrasound depending on membrane material and ultrasound parameters [95,180].

### **29.3.3 Enhancement of Heat Transfer**

Sound and ultrasound can be used to enhance the rate of heat transfer during freezing [71,110,160,191], thawing [72], and cooking [126,128]. In the case of thawing and cooking, ultrasound assists the process by increasing the rate of heat transfer with the surrounding medium and by absorption of sonic energy by the material. By contrast, in samples being frozen, the absorption of energy from sound waves, which will reduce the cooling rate, needs to be balanced against the improved heat transfer coefficient and also improved product quality produced by increasing ice crystal nucleation.

#### **29.3.3.1 Freezing**

Ultrasound can assist in the freezing process, both through decreasing the time required to freeze the food and improving the quality of the frozen food [191]. Ultrasound can be used to increase the convective heat transfer coefficient [74,148,191] between the food being frozen and the refrigerant. Ultrasound also affects crystallization, increasing the nucleation rate and crystal growth rate [91]. As the freezing of water in food is a crystallization process, ultrasound can alter this process, possibly through cavitation bubbles being nuclei for ice crystal formation, or through collapsing cavitation bubbles shattering existing ice crystals creating more nuclei [71,191]. Since reducing the size of ice crystals in frozen food helps reduce damage to the food microstructure and improve the quality of the food when consumed, using ultrasound to assist freezing may improve the freezing rate and quality of the frozen product.

A disadvantage of using ultrasound to improve the freezing process is that ultrasound also generates heat, so the benefits of improved heat transfer and nucleation must be balanced against heating. In a study of freezing potato pieces ( $76 \times 17 \times 17$  mm) in an ultrasonic bath (25 kHz), a power input of 7.3 W did not substantially affect the freezing rate (compared to no ultrasound), while both 15.9 and 25.9 W decreased the time to go from 0 to  $-7^{\circ}\text{C}$ , though 15.9 W gave a greater reduction in 0 to  $-7^{\circ}\text{C}$  time than 25.9 W [71]. The limited effectiveness of 7.3 W was ascribed to the low intensity of agitation produced, causing little increase in heat transfer. The greater effect on cooling rate at 15.9 W than 25.9 W was attributed to the balance between the improved heat transfer between the refrigeration medium and the potato due to greater agitation, and the more heat production due to greater energy input by the more intense ultrasound [71].

Selecting appropriate ultrasound intensity also affected the microstructure of frozen potato [160]. The ultrasound treatment found to give the best freezing rate (15.9 W) was also found to minimize microstructural change. Immersion freezing combined with a 15.9 W ultrasound treatment gave tightly packed cells, with no observed cell wall damage, compared to no ultrasound immersion freezing, which caused cell wall damage and caused separation of the potato cells. Compared to the other ultrasound treatments, 15.9 W caused less damage than 7.3 W ultrasound treatment (prominent cell wall separation and intercellular voids), with a 25.9 W ultrasound treatment causing an intermediate level of damage compared to the 7.3 and 15.9 W treatments [160].

#### **29.3.3.2 Thawing**

Large-scale thawing of frozen food is traditionally done with air or water thawing, though there is interest in emerging technologies such as high-pressure, microwave, ohmic, and acoustic or ultrasonic thawing [72]. Thawing techniques should minimize the thawing time and the formation of hot spots in the food that can damage quality (e.g., partial cooking or increased microbial growth) while maintaining product quality.

Early attempts at ultrasound or acoustic thawing were not particularly successful, with the formation of hot spots, poor penetration, and high power consumption [12]. More recently, an improved understanding of the interaction between sound waves and food products has improved the results of acoustic or ultrasound thawing, including either using ultrasound to assist thawing [61], or as the only energy source for thawing [103].

It has been proposed that the absorption of ultrasound energy depends on the thermoelastic relaxation of ice crystals in the food, and is affected by ice crystal orientation and size, impurities present in the ice

crystals, and temperature [61]. Studies in meat found differences in ultrasound attenuation depending on food temperature, with greater attenuation in frozen meat than thawed [155], and increasing attenuation as the temperature of frozen meat increased markedly above about  $-10^{\circ}\text{C}$  reaching a maximum near its freezing point (about  $-2^{\circ}\text{C}$ ) before decreasing rapidly at higher temperatures [104], making ultrasound particularly suitable for controllable thawing of foods [103].

Effective acoustic or ultrasound thawing relies on the selection of an appropriate frequency and intensity to defrost the food efficiently without excessive heating near the surface [103]. When ultrasound was applied directly to meat (beef, pork, or fish), excessive heating near the surface was particularly a problem at high intensities ( $1\text{--}3\text{ W/cm}^2$ ) and over a range of frequencies (220 kHz to 3.3 MHz), with cavitation causing problems at lower frequencies, while high attenuation caused excessive heating at higher frequencies [103]. A combination of 500 kHz and  $0.5\text{ W/cm}^2$  was found to offer effective thawing while minimizing surface heating.

Acoustic defrosting (1500 Hz) of fish blocks in an agitated water bath ( $18^{\circ}\text{C}$ , 3.8 m/s water velocity at block surface) reduced the time to go from  $-29^{\circ}\text{C}$  to  $-1^{\circ}\text{C}$  by approximately 25%–70% (depending on ultrasound power input level), while larger reductions were seen going from  $-5^{\circ}\text{C}$  to  $-1^{\circ}\text{C}$  (approximately 32%–82%) [61]. Some rapid thawing techniques can cause excessive heating at the product surface leading to loss of product quality. However, combined acoustic and water bath thawing gave the same surface temperature as water bath thawing alone [61].

### 29.3.3.3 *Cooking*

Some use of ultrasound has been made for cooking of meat, taking advantage of the increase in temperature due to the absorption of the ultrasound energy. Several ultrasound cooking processes have also been developed for meat products [150,157], and similar process may be useful with other foods.

Ultrasound cooking (1000 W, 20 kHz) of beef samples in a water bath reduced the cooking time (6.7 min), and energy consumption (0.08 W/g), and gave a higher yield (85.3%) than convection cooking in a broiler (12.3 min; 0.22 W/g; 76.1%) [128]. An important disadvantage of substituting ultrasound cooking for other methods is the poorer flavor [128]. The flavors formed during dry-heat cooking of meat (e.g., roasting and grilling) are an important part of the sensory characteristics, with different volatiles' profiles forming during moist cooking (e.g., boiling and microwave) [85,106].

In addition to using ultrasound in isolation to cook food, ultrasound-assisted water bath cooking is also likely to prove effective, due to the higher increased heat transfer coefficient produced by ultrasound [74,148] and agitation of the liquid by ultrasound mixing helping ensure an even temperature throughout the cooking medium [128].

## 29.3.4 *Processing of Protein Foods*

Ultrasound can be used to enhance the processing of materials containing proteins, such as the tenderization of raw meat, destruction of microorganisms, homogenization, protein extraction from cells, and enhancement of membrane filtration. The ultrasound mechanisms that can enhance these processes, such as localized or bulk heating, microjet formation, high shear, liquid agitation, polymer chain lysis, and free radical formation, can also denature the proteins present. In some instances this can be desirable, such as the denaturation of proteins responsible for undesirable texture, color, or flavor changes, while in other situations it can be undesirable, for example, giving a cooked appearance to raw meat during tenderization or loss of activity in enzymes being extracted from cells and purified. As a consequence, each process must be developed to maximize or minimize the effect of ultrasound on the proteins present.

### 29.3.4.1 *Enzyme Inactivation*

Ultrasound increases the effectiveness of heat inactivation of enzymes and has been demonstrated in enzymes derived from plants (soybean lipoxygenase [78], horseradish peroxidase [24,77,78], watercress peroxidase [21], mushroom polyphenol oxidase [78], orange pectinmethylesterase [171], tomato pectinmethylesterase, and polygalacturonase [172]), animal tissues (porcine heart malate dehydrogenase [120], rabbit muscle L-lactic dehydrogenase [120], bovine intestinal mucosa alkaline phosphatase [120], porcine

pancreas phospholipase A2, trypsin and lipase [168], bovine pancreas  $\alpha$ -chymotrypsin [168], and trypsin, [192]), microorganisms (*Pseudomonas fluorescens* lipase and protease [168], alcohol dehydrogenase and glucose-6-phosphate dehydrogenase from bakers' yeast [120],  $\beta$ -galactosidase from *Escherichia coli* [120]), and milk (bovine lactoperoxidase and alkaline phosphatase [35], alkaline phosphatase,  $\gamma$ -glutamyltranspeptidase and lactoperoxidase [174]). The ultrasound stability of individual proteins varies between enzymes [78,120,168,170] and also depends on ultrasound treatment conditions [137], the composition of the treatment medium [120], treatment pH [170], and whether they are bound (e.g., membrane-bound proteins) or free (e.g., cytoplasmic proteins). Enzyme inactivation generally increases with increasing ultrasound power, ultrasound frequency, exposure time, amplitude, cavitation intensity, processing temperature, and processing pressure, but decreases as the volume being treated increases [120,137,168,170].

A combined heat and ultrasound treatment can produce a markedly greater effect on enzyme inactivation than heat alone. Orange pectinmethylesterase in orange juice was inactivated relatively slowly by heat alone (72°C, D value of 500 min), while the combined heat and ultrasound treatment (72°C, 20 kHz, 117  $\mu$ m, 350 kPa) gave a much lower D value (1.2 min) [171]. Ultrasound was also effective at a temperature (38°C) where thermal inactivation is insignificant, giving a pectinmethylesterase D value of 11 min. The rate of inactivation of tomato pectinmethylesterase was also greatly increased by a combination of heat and ultrasound, with increasing cavitation intensity (measured via H<sub>2</sub>O<sub>2</sub> production) dramatically increasing the rate of inactivation [137]. Similarly for *Pseudomonas fluorescens* heat-resistant lipase, a combined ultrasound and thermal treatment (110°C–140°C, 20 kHz, 117  $\mu$ m, 350 kPa) reduced lipase D values by 25%–86% (average of 58%) and protease D values by 15%–67% (average of 42%) compared to the heat-only treatment at the same temperature [170]. Generally, the reduction in D value tended to decrease with increasing treatment temperature. In milk, ultrasound alone is not very effective at inactivating milk enzymes (alkaline phosphatase,  $\gamma$ -glutamyltranspeptidase, and lactoperoxidase) and other milk proteins ( $\alpha$ -lactalbumin and  $\beta$ -lactoglobulin), but a combination of ultrasound and heat is more effective than heat treatment alone [174].

Studies with buffers show that making small changes in the treatment medium composition, such as adding calcium salts, or whey protein hydrolysate, can markedly alter the rate at which an ultrasound treatment denatures enzymes [168]. For example, in a salt buffer adding calcium increased the stability of  $\alpha$ -chymotrypsin by 62%, while in a whey protein and salt buffer adding calcium increased the D value by 146% [168]. There was a marked difference between the salt buffer and the whey protein and salt buffer (511% no calcium and 826% with calcium). By contrast, there was little difference in trypsin inactivation between the salt buffer or whey protein buffer either with or without added calcium.

#### 29.3.4.2 Changes in Protein

Ultrasound-induced changes in milk also affect the characteristics of products made from the milk. Yogurt manufactured from milk processed with ultrasound (40°C, 20 kHz, 2 kg/cm<sup>2</sup>, 12 s ultrasound exposure time) took 10%–20% longer to ferment (slower pH fall), lost less serum, and had a different texture (higher compression force and higher viscosity) than yogurt made from conventionally processed milk [170]. These differences may be due to ultrasound-induced protein modification. In another study, milk treated with ultrasound (20 kHz, 15°C–20°C, 6 min ultrasound exposure time) before a yogurt starter culture was added fermented at effectively the same rate (indicated by pH fall) as a conventionally homogenized milk [185]. In contrast, fermentation was faster when samples were treated with ultrasound during fermentation, which may have been due to faster lactose hydrolysis as a result of ultrasound causing the release of  $\beta$ -galactosidase from bacterial cells [179]. Some ultrasound treatments also increased yogurt viscosity and water-holding capacity, and reduced syneresis compared to yogurt made with conventionally homogenized milk, which are likely to be the result of changes in protein conformation caused by ultrasound. Some depolymerization of collagen is also reported [52].

#### 29.3.5 Ultrasound as a Processing Aid

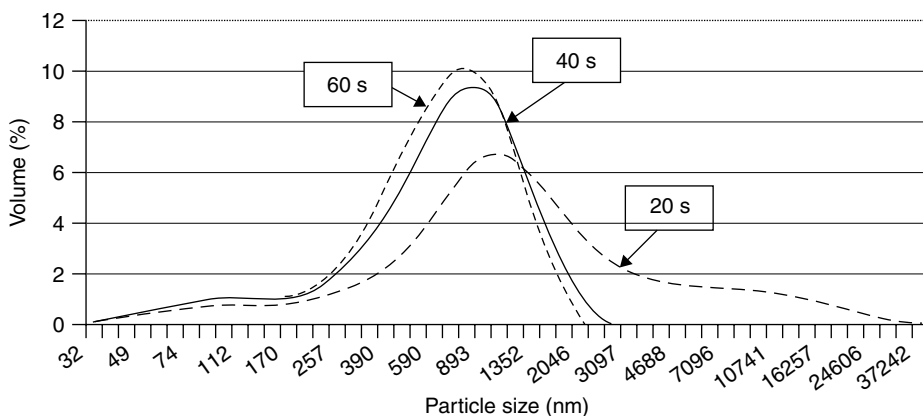
Ultrasound has been used to enhance the efficiency of food-related enzymatic processes, including enhancing the esterification of glucose [186], hydrolysis of olive oil [9], and proteolysis of casein by  $\alpha$ -chymotrypsin [49]. Ultrasound increased the rate of invertase-catalyzed hydrolysis of sucrose,  $\alpha$ -amylase and glucoamylase hydrolysis of starch, and  $\alpha$ -amylase hydrolysis of glycogen [6,144].

These studies show that ultrasound power levels can be found that give a balance between enhanced rates of enzyme activity, and while maintaining enzyme activity over an extended period. Ultrasound has also proven effective when lactose in milk is hydrolyzed by fermentation with *Lactobacillus bulgaricus* [179]. Ultrasound increased the rate and extent of lactose hydrolysis, and also altered the hydrolysis process giving markedly higher levels of residual glucose in the milk. When lactose is hydrolyzed within the cell, the glucose produced is consumed by the bacteria.

### 29.3.6 Homogenization and Emulsification

Homogenization or emulsification is one of the important unit operations in the food industries. Homogenization is a common term used when the size of a nonuniform dispersed system is reduced to a required size and distributed uniformly in the bulk product. In the homogenized product, the particle size distribution of the dispersed phase is narrow. Milk is the common food that is homogenized. In the emulsification process, two immiscible components are mixed and uniformly distributed. The examples are oil-in-water or water-in-oil type of emulsions. The equipment used to homogenize or emulsify the product are high-pressure homogenizers and colloid mills. Ultrahigh pressure homogenizers (can go up to 5000 bars) and microfluidizers are recent techniques that are gaining popularity to prepare submicron emulsions. Ultrasonication has also been proved as another way of mixing two immiscible liquids and used successfully in cosmetic, pharmaceuticals, chemical, and textile industries [94].

Ultrasonic emulsification is mainly driven by cavitation, wherein the bubbles collapse at the interface of two immiscible continuous and dispersed phases. A straightforward way to produce an emulsion by ultrasound is by immersion of a sonotrode either into the mixture of all components or into the continuous phase and adding gradually the phase to be dispersed during sonication. This procedure works well for small batches, but scale-up is difficult [37]. As the intensity of ultrasound in a liquid decreases rapidly with the distance to the sonotrode, it may be difficult to process larger volumes [37]. In some cases, the liquid whistle type of ultrasound device is used [94]. This can give much more throughput (up to 12,000 L/h) than the sonotrodes such as in the case of manufacturing fruit juices, ketchups, and mayonnaise [94]. Ultrasound treatment is also an effective method for homogenizing the fat globules present in milk [53,174,185]. Wu et al. [185] reported that the high amplitude homogenization not only gave good homogenization effect on milk but also significantly improved the water-holding capacity and viscosity and also reduced syneresis of yoghurt produced from ultrasonicated milk. The ultrasound was also very effective in producing submicron size of emulsion of essential oil (limonene) for the purpose of encapsulation by spray drying. The particle size and distribution were the function of ultrasonication period (Figure 29.3). Ultrasonication was found much easier to operate, control, and clean as compared to microfluidizer.



**FIGURE 29.3** Size distribution of the emulsion produced by ultrasound at various time periods (dispersed phase-limonene, continuous phase Hi-Cap/Maltodextrin mixture aqueous solution). (From Jafari, S.M., et al. (2006). *International Journal of Food Properties*, 9: 475–485.)



One of the issues of ultrasound emulsion is the critical product contamination of the metal alloys, which are used to make the sonotrodes. This contamination can result in the oxidation of the product and development of off-flavor. Attempts have been made to make the device transmit ultrasonic waves through other material (double jacket filled with pressurized water) in a flow-through cell where there will be no direct contact between the sonotrode and product [50].

### 29.3.7 Meat Tenderization

Tenderness is the most important consumer quality attribute in cooked meat [10,105]. Meat tenderness is influenced by a multitude of factors, including animal characteristics (e.g., genetics, animal age, and muscle function), preslaughter handling of the animal (e.g., stress and muscle glycogen), and post-slaughter handling of the carcass (e.g., chilling rate, electrical stimulation, and carcass suspension technique) [165]. There are myriad techniques available to tenderize meat, including many conventional approaches (e.g., aging time, treatment with proteases, injection with salt solutions, mechanical treatment, and cooking technique), including some emerging techniques, such as hydrodyne (explosive shock), ultrahigh pressure, and injection of calcium salts [165]. Ultrasound also offers potential as a tenderizing treatment in meat as it can be applied without causing the changes in appearance that occur with some other treatments (Table 29.3).

The ultrasound conditions used to treat meat vary widely, and correspondingly the effectiveness of ultrasound for meat tenderization varies. The intensity of ultrasound treatment appears to play an important role in the tenderizing effect, with studies using relatively low intensity ( $<2 \text{ W/cm}^2$ ) producing little effect, even though the samples received extended exposure (up to 70 min) [83,127]. Higher intensity ultrasound proved effective in some cases at tenderizing meat [26,27,51,128,158], though a number of other studies found that the treatment conditions had no effect on tenderness [82,84,126,128] or even decreased tenderness [126]. The

**TABLE 29.3**

Some of the Studies on the Tenderization of Meat by Ultrasound Treatment

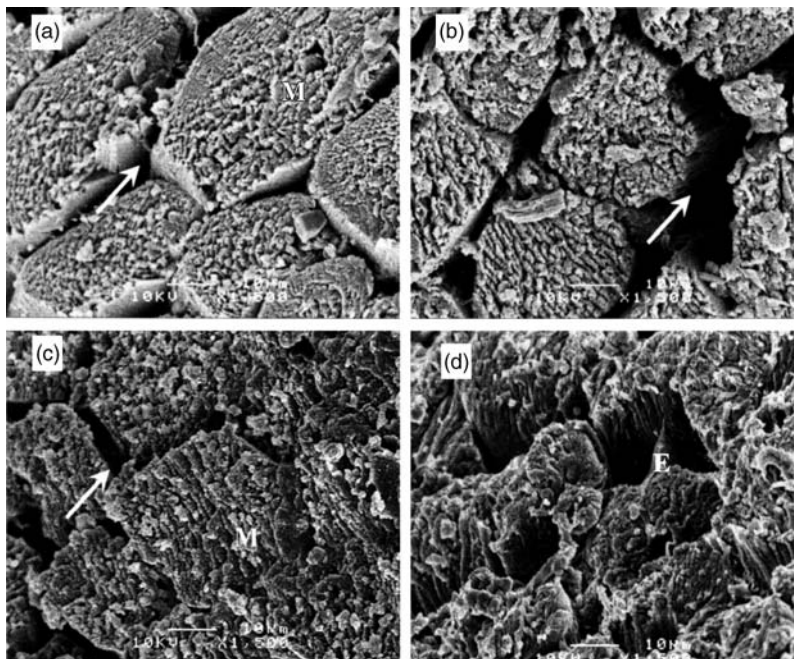
Muscle	Frequency (kHz)	Power Input	Treatment Time (min)	Tenderness Effect	References
Horse <i>semimembranosus</i>	22	1500 W	Five sessions totalling 50 min	Ultrasound-treated meat had lower shear force ( $25.2 \text{ kg/cm}^2$ ) than conventionally processed (injected and tumbled) meat ( $31.5 \text{ kg/cm}^2 \text{ N}$ )	[27,28]
Chicken <i>pectoralis major</i>	40	2400 W	15	At 24 h postmortem, ultrasound-treated muscles gave a lower shear force (4.4 N) than untreated muscles (5.0 N)	[26]
Beef <i>semitendinosus</i>	25.9	1000 W	Up to 16	Ultrasound-treated meat had lower shear force than untreated at 2 and 4 min, but equal or higher after 8 or 16 min	[158]
Beef <i>longissimus</i> <i>semitendinosus</i> <i>biceps femoris</i>	30–47	0.29–0.62 $\text{W/cm}^2$	Up to 30	Ultrasound did not affect instrumental tenderness	[83]
Lamb <i>longissimus</i>	20	63 $\text{W/cm}^2$	Average of 2.5 per steak	Ultrasound did not affect instrumental or sensory tenderness	[82]

frequency chosen does not appear to be responsible for the variation in results as these studies have been performed in a narrow range (20–47 kHz; most studies between 20 and 30 kHz). The use of high-frequency ultrasound (2.4 MHz) to treat prerigor meat initially increased the firmness (compression force) of raw meat compared to untreated or postrigor ultrasound-treated meat [43]. After 14 days' aging, no difference was found between untreated, prerigor, or postrigor ultrasound-treated meat [43].

The microstructure of ultrasound-treated meat shows that there can be significant disruption to the structure. In beef *longissimus*, there was greater sarcomere shattering and myofibril disruption from ultrasound cooking than convection, though in the *pectoralis*, no difference with cooking method was found [128]. This may be due to the greater collagen concentration and differences in connective tissue distribution between *pectoralis* than *longissimus*. In another study, both *semimembranosus* and *longissimus* showed damage to their microstructure caused by ultrasound [51] (Figure 29.4). By contrast, in chicken *pectoralis* ultrasound treatment did not affect microstructure [26]. There was also greater myofibril damage in ultrasound-treated cured meat products [27,139].

In beef *semimembranosus* treated with high-frequency ultrasound (2.4 MHz) prerigor ultrasound-treated meat initially had longer sarcomeres than untreated meat, though there was no difference in myofibril fragmentation after 6 days' aging [43]. There were no differences in microstructure between postrigor ultrasound-treated and untreated samples.

In addition to the physical disruption shown by microstructural studies, ultrasound could increase meat tenderness through an increase in proteolysis that contributes to meat tenderization during aging [140,159], for example, through increased release of cathepsin (muscle protease) [159]. Ultrasound treatment of lamb muscle fibers was found to activate proteolysis, with SDS-PAGE analysis showing greater appearance of bands around 30 and 83 kDa, and the disappearance of an 87 kDa band, in samples that had been ultrasound treated and aged at 4°C for 2 days, compared to the much smaller changes in samples that had only been aged at 4°C for 2 days [140]. However, this effect is not found consistently, as when beef or lamb muscles



**FIGURE 29.4** Scanning electron micrograph of bovine *Semitendinosus* muscle treated with ultrasound (24 kHz) for various treatment times. (a) 0 s, tightly packaged and intact fiber bundles are shown; (b) 60 s, fiber bundles are intact but increased spaces between fiber bundles are shown; (c) 120 s, disintegrated fiber bundles are evident; and (d) 240 s, integrity of the fiber bundles are lost and myofibrils and connective tissue appeared to be denatured. M = fiber bundle; → = intermyofibrillar spaces; E = endomysium. (From Jayasooriya, S. D. (2005). *High Power Ultrasound in Meat Processing*, MPhil, The University of Queensland: Brisbane, Australia.)

were treated with ultrasound, there was no effect on the SDS-PAGE profile, with the appearance of a 30 kDa band (a marker of proteolysis in aged meat) occurring at the same rate in ultrasound-treated and untreated meat [82,84]. Ultrasound could also damage cell walls and membranes [3] and physically disrupt proteins through bubble pulsation, cavitation, free radical formation [3], including fragmentation of collagen [113]. An effect on collagen in treated meat has been shown, with meat cooked by ultrasound having a lower total and soluble collagen content than convection-cooked meat [128], though in raw meat, ultrasound treatment had no effect on total and soluble collagen contents [82,84] or insoluble collagen [43].

---

## References

1. Abramov, O. V. (1998). *High-Intensity Ultrasonics—Theory and Industrial Applications*. Gordon and Breach Science Publishers: Amsterdam, The Netherlands.
2. Ahmed, F. I. K., & Russell, C. (1975). Synergism between ultrasonic waves and hydrogen peroxide in killing of microorganisms. *Journal of Applied Bacteriology*, *39*, 31–40.
3. Alliger, H. (1975). Ultrasonic disruption. *American Laboratory*, *10*, 75–85.
4. Alvarez, I., Manas, P., Sala, F. J., & Condon, S. (2003). Inactivation of *Salmonella enterica* serovar *Enteritidis* by ultrasonic waves under pressure at different water activities. *Applied and Environmental Microbiology*, *69*, 668–672.
5. Bartolome, L. G., Hoff, J. E., & Purdy, K. R. (1969). Effect of resonant acoustic vibrations on drying rates of potato cylinders. *Food Technology*, *23*, 321–324.
6. Barton, S., Bullock, C., & Weir, D. (1996). The effects of ultrasound on the activities of some glycosidase enzymes of industrial importance. *Enzyme and Microbial Technology*, *18*, 190–194.
7. Bartz, W. J., (Ed.), (1993). *Avoidance of Cavitation Damage: Principles, Methods of Test, Applications, Experience*. London: Mechanical Engineering Publications.
8. Benedito, J., Carcel, J. A., Rossello, C., & Mulet, A. (2001). Composition assessment of raw meat mixtures using ultrasonics. *Meat Science*, *57*, 365–370.
9. Blackburn, P., & Robinson, E. (1993). The application of ultrasonics to oil hydrolysis using an immobilised lipase. *Chemistry and Industry*, *15*, 205–206.
10. Boleman, S. J., Miller, R. K., Taylor, J. F., Cross, H. R., Wheeler, T. L., Koohmaraie, M., Shackelford, S. D., Miller, M. F., West, D., Johnson, D., & Savell, J. W. (1997). Consumer evaluation of beef of known categories of tenderness. *Journal of Animal Science*, *75*, 1521–1524.
11. Bourne, N. K. (2002). On the collapse of cavities. *Shock Waves*, *11*, 447–455.
12. Brody, A. L., & Antonevich, J. N. (1959). Ultrasonic defrosting of foods. *Food Technology*, *13*, 109–112.
13. Brudzynski, S. M. (2005). Principles of rat communication: quantitative parameters of ultrasonic calls in rats. *Behavior Genetics*, *35*, 85–92.
14. Canselier, J. R., Delmas, H., Wilhelm, A. M., & Abismail, B. (2002). Ultrasound emulsification—an overview. *Journal of Dispersion Science and Technology*, *23*, 333–349.
15. Chang, A. C. (2004). The effects of different accelerating techniques on maize wine maturation. *Food Chemistry*, *86*, 61–68.
16. Chang, A. C. (2005). Study of ultrasonic wave treatments for accelerating the aging process in a rice alcoholic beverage. *Food Chemistry*, *92*, 337–342.
17. Chang, A. C., & Chen, F. C. (2002). The application of 20 kHz ultrasonic waves to accelerate the aging of different wines. *Food Chemistry*, *79*, 501–506.
18. Chang, A. C., & Hsu, J. P. (2006). A polynomial regression model for the response of various accelerating techniques on maize wine maturation. *Food Chemistry*, *94*, 603–607.
19. Ciccolini, L., Taillandier, P., Wilhem, A. M., Delmas, H., & Strehaiano, P. (1997). Low frequency thermo-ultrasonication of *Saccharomyces cerevisiae* suspensions: effect of temperature and of ultrasonic power. *Chemical Engineering Journal*, *65*, 145–149.
20. Cohen, J. S., & Yang, T. C. S. (1995). Progress in food dehydration. *Trends in Food Science and Technology*, *6*, 20–25.
21. Cruz, R. M. S., Vieira, M. C., & Silva, C. L. M. (2006). Effect of heat and thermosonication treatments on peroxidase inactivation kinetics in watercress (*Nasturtium officinale*). *Journal of Food Engineering*, *72*, 8–15.
22. Da-Mota, V. M., & Palau, E. (1999). Acoustic drying of onion. *Drying Technology*, *17*, 855–867.

23. Daufin, G., Escudier, J. P., Carrere, H., Berot, S., Fillaudeau, L., & Decloux, M. (2001). Recent and emerging applications of membrane processes in the food and dairy industry. *Food and Bioproducts Processing*, 79, 89–102.
24. De Gennaro, L., Cavella, S., Romano, R., & Masi, P. (1999). The use of ultrasound in food technology I: inactivation of peroxidase by thermosonication. *Journal of Food Engineering*, 39, 401–407.
25. Dewhurst, E., Rawson, D. M., & Steele, G. C. (1986). The use of a model system to compare the efficiency of ultrasound and agitation in the recovery of *Bacillus subtilis* spores from polymer surfaces. *Journal of Applied Bacteriology*, 61, 357–363.
26. Dickens, J. A., Lyon, C. E., & Wilson, R. L. (1991). Effect of ultrasonic radiation on some physical characteristics of broiler breast muscle and cooked meat. *Poultry Science*, 70, 389–396.
27. Dolatowski, Z. J. (1988). Ultraschall. 2. Einfluss von ultraschall auf die mikrostruktur von muskelgewebe bei der poekelung. *Die Fleischwirtschaft*, 68, 1301–1303.
28. Dolatowski, Z. J. (1989). Ultraschall. 3. Einfluss von ultraschall auf die produktionstechnologie und qualitaet von kochschinken. *Die Fleischwirtschaft*, 69, 106–111.
29. D'Souza, N. M., & Mawson, A. J. (2005). Membrane cleaning in the dairy industry: a review. *Critical Reviews in Food Science and Nutrition*, 45, 125–134.
30. Duriyabunleng, H., Petmunee, J., & Muangnapoh, C. (2001). Effects of the ultrasonic waves on micro-filtration in plate and frame module. *Journal of Chemical Engineering of Japan*, 34, 985–989.
31. Earnshaw, R. G. (1998). Ultrasound: a new opportunity for food preservation. In *Ultrasound in Food Processing*, Povey, M. J. W., & Mason, T. J., (Eds.), Blackie Academic and Professional: London, pp. 183–192.
32. Earnshaw, R. G., Appleyard, J., & Hurst, R. M. (1995). Understanding physical inactivation processes: combined preservation opportunities using heat, ultrasound and pressure. *International Journal of Food Microbiology*, 28, 197–219.
33. Ensminger, D. (1988). Acoustic and electroacoustic methods of dewatering and drying. *Drying Technology*, 6, 473–499.
34. Entezari, M. H., Nazary, S. H., & Khodaparast, M. H. H. (2004). The direct effect of ultrasound on the extraction of date syrup and its micro-organisms. *Ultrasonics Sonochemistry*, 11, 379–384.
35. Ertugay, M. F., Yuksel, Y., & Sengul, M. (2003). The effect of ultrasound on lactoperoxidase and alkaline phosphatase enzymes from milk. *Milchwissenschaft*, 58, 593–595.
36. Floros, J. D., & Liang, H. (1994). Acoustically assisted diffusion through membranes and biomaterials. *Food Technology*, 48, 79–84.
37. Freitas, S., Rudolf, B., Merkle, H. P., & Gander, B. (2005). Flow-through ultrasonic emulsification combined with static micromixing for aseptic production of microspheres by solvent extraction. *European Journal of Pharmaceutics and Biopharmaceutics*, 61, 181–187.
38. Gallego-Juarez, J. A. (1998). Some applications of air-borne power ultrasound to food processing. In *Ultrasound in Food Processing*, Povey, M. J. W., & Mason, T. J., (Eds.), Blackie Academic and Professional: London, pp. 127–143.
39. Gallego-Juarez, J. A., Elvira-Segura, L., & Rodríguez-Corral, G. (2003). A power ultrasonic technology for deliquoring. *Ultrasonics*, 41, 255–259.
40. Gallego-Juarez, J. A., Rodríguez-Corral, G., Galvez-Moraleda, J. C., & Yang, T. S. (1999). A new high-intensity ultrasonic technology for food dehydration. *Drying Technology*, 17, 597–608.
41. Garcia, M. L., Burgos, J., Sanz, B., & Ordonez, J. A. (1989). Effect of heat and ultrasonic waves on the survival of two strains of *Bacillus subtilis*. *Journal of Applied Bacteriology*, 67, 619–628.
42. Girard, B., & Fukumoto, L. R. (2000). Membrane processing of fruit juices and beverages: a review. *Critical Reviews in Food Science and Nutrition*, 40, 91–157.
43. Got, F., Culioli, J., Berge, P., Vignon, X., Astruc, T., Quideau, J. M., & Lethiecq, M. (1999). Effects of high-intensity high-frequency ultrasound on ageing rate, ultrastructure and some physico-chemical properties of beef. *Meat Science*, 51, 35–42.
44. Heath, J. L., Owens, S. L., & Goble, J. W. (1980). Ultrasonic vibration as an aid in the acetic acid method of cleaning eggs. *Poultry Science*, 59, 737–742.
45. Henglein, A. (1987). Sonochemistry: historical developments and modern aspects. *Ultrasonics*, 25, 6–16.
46. Horne, J. K. (2000). Acoustic approaches to remote species identification: a review. *Fisheries Oceanography*, 9, 356–371.
47. Huxsoll, C. C., & Hall, C. W. (1970). Effects of sonic irradiation on drying rates of wheat and shelled corn. *Transactions of the ASAE*, 13, 21–24.

48. Idrissi, F. Z., Agut, M., Larrondo, J., & Calvo, M. A. (1996). Effect of ultrasound on fungal cells. *Cytobios*, 88, 119–122.
49. Ishimori, Y., Karube, I., & Suzuki, S. (1981). Acceleration of immobilized  $\alpha$ -chymotrypsin activity with ultrasonic irradiation. *Journal of Molecular Catalysis*, 12, 253–259.
50. Jafari, S. M., He, Y., & Bhandari, B. (2006). Nano-emulsion production by sonication and microfluidization—a comparison. *International Journal of Food Properties*, 9, 475–485.
51. Jayasooriya, S. D. (2005). Effect of high power ultrasound treatment on ultrastructural properties of bovine Semitendinosus and Longissimus dorsi muscle. In *High Power Ultrasound in Meat Processing*, MPhil, The University of Queensland: Brisbane, Australia.
52. Jayasooriya, S. D., Torley, P. J., D'Arcy, B. R., & Bhandari, B. R. (2007). Effect of high power ultrasound and ageing on the physical properties of bovine *Semitendinosus* and *Longissimus* muscles. *Meat Science*, 75, 628–639.
53. Jena, S., & Das, H. (2006). Modeling of particle size distribution of sonicated coconut milk emulsion: effect of emulsifiers and sonication time. *Food Research International*, 39, 606–611.
54. Jeng, D. K., Lin, L. I., & Hervey, L. V. (1990). Importance of ultrasonication conditions in recovery of microbial-contamination from material-surfaces. *Journal of Applied Bacteriology*, 68, 479–484.
55. Jiao, B., Cassano, A., & Drioli, E. (2004). Recent advances on membrane processes for the concentration of fruit juices: a review. *Journal of Food Engineering*, 63, 303–324.
56. Kennedy, J. E., ter Haar, G. R., & Cranston, D. (2003). High intensity focused ultrasound: surgery of the future? *British Journal of Radiology*, 76, 590–599.
57. Kim, H. H. Y., & Baianu, I. C. (1991). Novel liposome microencapsulation techniques for food applications. *Trends in Food Science and Technology*, 2, 55–61.
58. Kim, S. M., & Zayas, J. F. (1989). Processing parameters of chymosin extraction by ultrasound. *Journal of Food Science*, 54, 700–703.
59. Kim, S. M., & Zayas, J. F. (1991). Comparative quality characteristics of chymosin extracts obtained by ultrasound treatment. *Journal of Food Science*, 56, 406–410.
60. Kim, S. M., & Zayas, J. F. (1991). Effects of ultrasound treatment on the properties of chymosin. *Journal of Food Science*, 56, 926–930.
61. Kissam, A. D., Nelson, R. W., Ngao, J., & Hunter, P. (1981). Water-thawing of fish using low frequency acoustics. *Journal of Food Science*, 47, 71–75.
62. Kobayashi, T., Chai, X., & Fujii, N. (1999). Ultrasound enhanced cross-flow membrane filtration. *Separation and Purification Technology*, 17, 31–40.
63. Kobayashi, T., Kobayashi, T., Hosaka, Y., & Fujii, N. (2003). Ultrasound-enhanced membrane-cleaning processes applied water treatments: influence of sonic frequency on filtration treatments. *Ultrasonics*, 41, 185–190.
64. Krasaekoopt, W., Bhandari, B., & Deeth, H. (2005). Comparison of gelation profile of yoghurts during fermentation measured by RVA and ultrasonic spectroscopy. *International Journal of Food Properties*, 8, 193–198.
65. Kundu, T. (2004). *Ultrasonic Nondestructive Evaluation—Engineering and Biological Material Characterization*. CRC Press: Boca Raton.
66. Kyllonen, H. M., Pirkonen, P., & Nystrom, M. (2005). Membrane filtration enhanced by ultrasound: a review. *Desalination*, 181, 319–335.
67. Lamminen, M. O., Walker, H. W., & Weavers, L. K. (2004). Mechanisms and factors influencing the ultrasonic cleaning of particle-fouled ceramic membranes. *Journal of Membrane Science*, 237, 213–223.
68. Lee, B. H., Kermasha, S., & Baker, B. E. (1989). Thermal, ultrasonic and ultraviolet inactivation of Salmonella in thin films of aqueous media and chocolate. *Food Microbiology*, 6, 143–152.
69. Lee, S., Pyrak-Nolte, L. J., Cornillon, P., & Campanella, O. (2004). Characterisation of frozen orange juice by ultrasound and wavelet analysis. *Journal of the Science of Food and Agriculture*, 84, 405–410.
70. Leighton, T. G. (1998). The principles of cavitation. In *Ultrasound in Food Processing*, Povey, M. J. W., & Mason, T. J., (Eds.), Blackie Academic and Professional: London. pp. 151–182.
71. Li, B., & Sun, D. W. (2002). Effect of power ultrasound on freezing rate during immersion freezing of potatoes. *Journal of Food Engineering*, 55, 277–282.
72. Li, B., & Sun, D. W. (2002). Novel methods for rapid freezing and thawing of foods—a review. *Journal of Food Engineering*, 54, 175–172.
73. Lillard, H. S. (1993). Bactericidal effect of chlorine on attached Salmonellae with and without sonification. *Journal of Food Protection*, 56, 716–717.

74. Lima, M., & Sastry, S. K. (1990). Influence of fluid rheological properties and particle location on ultrasound-assisted heat transfer between liquid and particles. *Journal of Food Science*, *55*, 1112–1115, 1119.
75. Lindsay, D., & von Holy, A. (1997). Evaluation of dislodging methods for laboratory-grown bacterial biofilms. *Food Microbiology*, *14*, 383–390.
76. Lopez, P., & Burgos, J. (1995). Lipoxigenase inactivation by manothermosonication: effects of sonication physical parameters, pH, KCl, sugars, glycerol, and enzyme concentration. *Journal of Agricultural and Food Chemistry*, *43*, 620–625.
77. Lopez, P., & Burgos, J. (1995). Peroxidase stability and reactivation after heat treatment and manothermosonication. *Journal of Food Science*, *60*, 451–455, 482.
78. Lopez, P., Sala, F. J., de la Fuente, J. L., Condon, S., Raso, J., & Burgos, J. (1994). Inactivation of peroxidase, lipoxigenase, and polyphenol oxidase by manothermosonication. *Journal of Agricultural and Food Chemistry*, *42*, 252–256.
79. Lopez-Malo, A., Guerrero, S., & Alzamora, S. M. (1999). *Saccharomyces cerevisiae* thermal inactivation kinetics combined with ultrasound. *Journal of Food Protection*, *62*, 1215–1217.
80. Lopez-Malo, A., Palou, E., Jimenez-Fernandez, M., Alzamora, S. M., & Guerrero, S. (2005). Multifactorial fungal inactivation combining thermosonication and antimicrobials. *Journal of Food Engineering*, *67*, 87–93.
81. Lopp, A., & Weber, H. (2005). Research into the optimising the tenderness of beef from parts of the forequarter. *Die Fleischwirtschaft*, *85*, 111–116.
82. Lyng, J. G., Allen, P., & McKenna, B. (1998). The effects of pre- and post-rigor high-intensity ultrasound treatment on aspects of lamb tenderness. *Lebensmittel Wissenschaft und Technologie*, *31*, 334–338.
83. Lyng, J. G., Allen, P., & McKenna, B. M. (1997). The influence of high intensity ultrasound baths on aspects of beef tenderness. *Journal of Muscle Foods*, *8*, 237–249.
84. Lyng, J. G., Allen, P., & McKenna, B. M. (1998). The effect on aspects of beef tenderness of pre- and post-rigor exposure to a high intensity ultrasound probe. *Journal of the Science of Food and Agriculture*, *78*, 308–314.
85. MacLeod, G., & Coppock, B. M. (1977). A comparison of the chemical composition of boiled and roasted aromas of heated beef. *Journal of Agricultural and Food Chemistry*, *25*, 113–117.
86. Manas, P., & Pagan, R. (2005). Microbial inactivation by new technologies of food preservation. *Journal of Applied Microbiology*, *98*, 1387–1399.
87. Manas, P., Pagan, R., Raso, J., Sala, F. J., & Condon, S. (2000). Inactivation of *Salmonella enteritidis*, *Salmonella typhimurium*, and *Salmonella senftenberg* by ultrasonic waves under pressure. *Journal of Food Protection*, *63*, 451–456.
88. Margulis, M. A. (2004). Sonochemistry as a new promising area of high energy chemistry. *High Energy Chemistry*, *38*, 135–142.
89. Margulis, M. A., & Margulis, I. M. (2004). Mechanism of sonochemical reactions and sonoluminescence. *High Energy Chemistry*, *38*, 285–294.
90. Mason, T. J. (1990). A survey of commercially available sources of ultrasound suitable for sonochemistry. In *Sonochemistry: The Uses of Ultrasound in Chemistry*, Mason, T.J., (Ed.), The Royal Society of Chemistry: Cambridge, pp. 60–68.
91. Mason, T. J. (1998). Power ultrasound in food processing—the way forward. In *Ultrasound in food processing*, Povey, M. J. W., & Mason, T. J., (Eds.), Blackie Academic and Professional: London, pp. 105–126.
92. Mason, T. J. (1999). *Sonochemistry*. Oxford University Press: Oxford.
93. Mason, T. J., & Lorimer, J. P. (1988). *Sonochemistry: Theory, Applications and Uses of Ultrasound in Chemistry*. Ellis Horwood: Chichester.
94. Mason, T. J., Paniwnyk, L., & Lorimer, J. P. (1996). The uses of ultrasound in food technology. *Ultrasonics Sonochemistry*, *3*, S253–S260.
95. Masselin, I., Chasseray, X., Durand-Bourlier, L., Lainé, J.-M., Syzaret, P.-Y., & Lemordant, D. (2001). Effect of sonication on polymeric membranes. *Journal of Membrane Science*, *181*, 213–220.
96. Masuzawa, N., & Ohdaira, E. (2002). Attempts to shorten the time of lactic fermentation by ultrasonic irradiation. *Japanese Journal of Applied Physics—Part 1*, *41*, 3277–3278.
97. Masuzawa, N., Ohdaira, E., & Ide, M. (2000). Effects of ultrasonic irradiation on phenolic compounds in wine. *Japanese Journal of Applied Physics—Part 1*, *39*, 2978–2979.
98. Matsumoto, Y., Miwa, T., Nakao, S., & Kimura, S. (1996). Improvement of membrane permeation performance by ultrasonic microfiltration. *Journal of Chemical Engineering of Japan*, *29*, 561–567.

99. McClements, D. J. (1997). Ultrasonic characterization of foods and drinks: principles, methods, and applications. *Critical Reviews in Food Science and Nutrition*, 37, 1–46.
100. Miles, C. A., & Cutting, C. L. (1974). Changes in the velocity of ultrasound in meat during freezing. *Journal of Food Technology*, 9, 119–122.
101. Miles, C. A., & Fursey, G. A. J. (1977). Measurement of the fat content of meat using ultrasonic waves. *Food Chemistry*, 2, 107–118.
102. Miles, C. A., Fursey, G. A. J., & Jones, R. C. D. (1985). Ultrasonic estimation of solid/liquid ratios in fats, oils and adipose tissue. *Journal of the Science of Food and Agriculture*, 36, 215–228.
103. Miles, C. A., Morley, M. J., & Rendell, M. (1999). High power ultrasonic thawing of frozen foods. *Journal of Food Engineering*, 39, 151–159.
104. Miles, C. A., & Shore, D. (1978). Changes in the attenuation of ultrasound during freezing. *24th European Meeting of Meat Research Workers*, Germany: Kulmbach, D.4:3–D.4:6.
105. Miller, M. F., Carr, M. A., Ramsey, C. B., Crockett, K. L., & Hoover, L. C. (2001). Consumer thresholds for establishing the value of beef tenderness. *Journal of Animal Science*, 79, 3062–3068.
106. Mottram, D. S. (1985). The effect of cooking conditions on the formation of volatile heterocyclic compounds in pork. *Journal of the Science of Food and Agriculture*, 36, 377–382.
107. Mulet, A., Carcel, J. A., Sanjuan, N., & Bon, J. (2003). New food drying technologies—use of ultrasound. *Food Science and Technology International*, 9, 215–221.
108. Muralidhara, H. S., & Ensminger, D. (1986). Acoustic drying of green rice. *Drying Technology*, 4, 137–143.
109. Muralidhara, H. S., Ensminger, D., & Putnam, A. (1985). Acoustic dewatering and drying (low and high frequency): state of the art review. *Drying Technology*, 3, 529–566.
110. Muthukumar, S., Kentish, S. E., Ashokkumar, M., & Stevens, G. W. (2005). Mechanisms for the ultrasonic enhancement of dairy whey ultrafiltration. *Journal of Membrane Science*, 258, 106–114.
111. Nakagawa, S., Yamashita, T., & Miura, H. (1996). Ultrasonic drying of walleye pollack surimi. *Nippon Shokuhin Kagaku Kogaku Kaishi*, 43, 388–394.
112. Nakano, H., Okabe, T., Hashimoto, H., Yoshikuni, Y., & Sakaguchi, G. (1989). Changes in *Clostridium botulinum* spores in honey during long-term storage and mild heating. *Japanese Journal of Food Microbiology*, 6, 97–101.
113. Nishihara, T., & Doty, P. (1958). The sonic fragmentation of collagen macromolecules. *Proceedings of the National Academy of Science*, 44, 411–417.
114. Nyborg, W. L. (2000). Biological effects of ultrasound: development of safety guidelines. Part I: personal histories. *Ultrasound in Medicine and Biology*, 26, 911–964.
115. Nyborg, W. L. (2001). Biological effects of ultrasound: development of safety guidelines. Part II: general review. *Ultrasound in Medicine and Biology*, 27, 301–333.
116. Ordóñez, J. A., Aguilera, M. A., Garcia, M. L., & Sanz, B. (1987). Effect of combined ultrasonic and heat treatment (thermoultrasonication) on the survival of a strain of *Staphylococcus aureus*. *Journal of Dairy Research*, 54, 61–67.
117. Ordóñez, J. A., Sanz-Perez, B., Hernandez, P. E., & Lopez-Lorenzo, P. (1984). A note on the effect of combined ultrasonic and heat treatments on the survival of thermotolerant streptococci. *Journal of Applied Bacteriology*, 56, 175–177.
118. Oulahal-Lagsir, N., Martial-Gros, A., Bonneau, M., & Blum, L. J. (2000). Ultrasonic methodology coupled to ATP bioluminescence for the non-invasive detection of fouling in food processing equipment—validation and application to a dairy factory. *Journal of Applied Microbiology*, 89, 433–441.
119. Oyane, I., Furuta, M., Stavarache, C. E., Hashiba, K., Mukai, S., Nakanishi, M., Kimata, I., & Maeda, Y. (2005). Inactivation of *Cryptosporidium parvum* by ultrasonic irradiation. *Environmental Science and Technology*, 39, 7294–7298.
120. Ozbek, B., & Ulgen, K. O. (2000). The stability of enzymes after sonication. *Process Biochemistry*, 35, 1037–1043.
121. Pagan, R., Manas, P., Alvarez, I., & Condon, S. (1999). Resistance of *Listeria monocytogenes* to ultrasonic waves under pressure at sublethal (manosonication) and lethal (manothermosonication) temperatures. *Food Microbiology*, 16, 139–148.
122. Pagan, R., Manas, P., Raso, J., & Condon, S. (1999). Bacterial resistance to ultrasonic waves under pressure at nonlethal (manosonication) and lethal (manothermosonication) temperatures. *Applied and Environmental Microbiology*, 65, 297–300.
123. Palacios, P., Burgos, J., Hoz, L., Sanz, B., & Ordóñez, J. A. (1991). Study of substances released by ultrasonic treatment from *Bacillus stearothermophilus* spores. *Journal of Applied Bacteriology*, 71, 445–451.

124. Perkins, J. P. (1988). Power ultrasound. In *Sonochemistry: The Uses of Ultrasound in Chemistry*, Mason, T. J., (Ed.), The Royal Society of Chemistry: Cambridge, pp. 47–59.
125. Piyasena, P., Mohareb, E., & McKellar, R. C. (2003). Inactivation of microbes using ultrasound: a review. *International Journal of Food Microbiology*, 87, 207–216.
126. Pohlman, F. W., Dikeman, M. E., & Kropf, D. H. (1997). Effects of high intensity ultrasound treatment, storage time and cooking method on shear, sensory, instrumental color and cooking properties of packaged and unpackaged beef *pectoralis* muscle. *Meat Science*, 46, 89–100.
127. Pohlman, F. W., Dikeman, M. E., & Zayas, J. F. (1997). The effect of low-intensity ultrasound treatment on shear properties, color stability and shelf life of vacuum packaged beef *semitendinosus* and *biceps femoris* muscles. *Meat Science*, 45, 329–337.
128. Pohlman, F. W., Dikeman, M. E., Zayas, J. F., & Unruh, J. A. (1997). Effects of ultrasound and convection cooking to different end point temperatures on cooking characteristics, shear force and sensory properties, composition, and microscopic morphology of beef longissimus and pectoralis muscles. *Journal of Animal Science*, 75, 386–40.
129. Popper, A. N., Plachta, D. T. T., Mann, D. A., & Higgs, D. (2004). Response of clupeid fish to ultrasound: a review. *ICES Journal of Marine Science*, 61, 1057–1061.
130. Povey, M. J. W. (1989). Ultrasonics in food engineering. II. Applications. *Journal of Food Engineering*, 9, 1–20.
131. Povey, M. J. W., & McClements, D. J. (1988). Ultrasonics in food engineering. I. Introduction and experimental methods. *Journal of Food Engineering*, 8, 217–245.
132. Quartly-Watson, T. (1998). The importance of power ultrasound in cleaning and disinfection in the poultry industry—a case study. In *Ultrasound in Food Processing*, Povey, M. J. W., & Mason, T. J., (Eds.), Blackie Academic and Professional: London, pp. 144–150.
133. Raoult-Wack, A. L. (1994). Recent advances in the osmotic dehydration of foods. *Trends in Food Science and Technology*, 5, 255–260.
134. Raso, J., & Barbosa-Canovas, G. V. (2003). Nonthermal preservation of foods using combined processing techniques. *Critical Reviews in Food Science and Nutrition*, 43, 265–285.
135. Raso, J., Palop, A., Pagan, R., & Condon, S. (1998b). Inactivation of *Bacillus subtilis* spores by combining ultrasonic waves under pressure and mild heat treatment. *Journal of Applied Microbiology*, 85, 849–854.
136. Rastogi, N. K., Raghavarao, K. S. M. S., Niranjan, K., & Knorr, D. (2002). Recent developments in osmotic dehydration: methods to enhance mass transfer. *Trends in Food Science and Technology*, 13, 48–59.
137. Raviyan, P., Zhang, Z., & Feng, H. (2005). Ultrasonication for tomato pectinmethyl-esterase inactivation: effect of cavitation intensity and temperature on inactivation. *Journal of Food Engineering*, 70, 189–196.
138. Rawson, F. F. (1998). An introduction to ultrasonic food cutting. In *Ultrasound in Food Processing*, Povey, M. J. W., & Mason, T. J., (Eds.), Blackie Academic and Professional: London, pp. 254–269.
139. Reynolds, J. B., Anderson, D. B., Schmidt, G. R., Theno, D. M., & Siegel, D. G. (1978). Effects of ultrasonic treatment on binding strength in cured ham rolls. *Journal of Food Science*, 43, 866–869.
140. Roncales, P., Cena, P., Beltran, J. A., & Jaime, I. (1992). Ultrasonication of lamb skeletal muscle fibre enhances postmortem proteolysis. *38th International Congress of Meat Science and Technology*, Clermont-Ferrand, France, pp. 411–414.
141. Rooney, J. A. (1988). Other nonlinear acoustic phenomena. In *Ultrasound—Its Chemical, Physical, and Biological Effects*, Suslick, K. S., (Ed.), VCH Publishers: New York, pp. 65–96.
142. Ross, A. I. V., Griffiths, M. W., Mittal, G. S., & Deeth, H. C. (2003). Combining nonthermal technologies to control foodborne microorganisms. *International Journal of Food Microbiology*, 89, 125–138.
143. Rucroft, G., Hipkiss, D., Ly, T., Maxted, N., & Cains, P. W. (2005). Sonocrystallization: the use of ultrasound for improved industrial crystallization. *Organic Process Research and Development*, 9, 923–932.
144. Sakakibara, M., Wang, D., Takahashi, R., Takahashi, K., & Mori, S. (1996). Influence of ultrasound irradiation on hydrolysis of sucrose catalyzed by invertase. *Enzyme and Microbial Technology*, 18, 444–448.
145. Sanchez, E. S., Simal, S., Femenia, A., Benedito, J., & Rossello, C. (1999). Influence of ultrasound on mass transport during cheese brining. *European Food Research and Technology*, 209, 215–219.
146. Sanchez, E. S., Simal, S., Femenia, A., Benedito, J., & Rossello, C. (2001). Effect of acoustic brining on lipolysis and on sensory characteristics of Mahon cheese. *Journal of Food Science*, 66, 892–896.
147. Sanchez, E. S., Simal, S., Femenia, A., & Rossello, C. (2000). Effect of acoustic brining on the transport of sodium chloride and water in Mahon cheese. *European Food Research and Technology*, 212, 39–43.
148. Sastry, S. K., Shen, G. Q., & Blaisdell, J. L. (1989). Effect of ultrasonic vibration on fluid-to-particle convective heat transfer coefficients. *Journal of Food Science*, 54, 229–230.



149. Scherba, G., Weigel, R. M., & O'Brien, W. D. (1991). Quantitative assessment of the germicidal efficacy of ultrasonic energy. *Applied and Environmental Microbiology*, *57*, 2079–2084.
150. Schiffmann, R. F., & Manna, R. (2001). Skinless sausage or frankfurter manufacturing method and apparatus utilizing reusable deformable support. United States of America Patent 6,326,039.
151. Schuett-Abraham, I., Trommer, E., & Levetzow, R. (1992). Ultraschall im 'steri-becken'. Zum ein-satz von ultraschall in einrichtungen zur reinigung und desinfektion von messern am arbeitsplatz in schlacht- und zerlegebetrieben. *Die Fleischwirtschaft*, *72*, 864–867, 900.
152. Seymour, I. J., Burfoot, D., Smith, R. L., Cox, L. A., & Lockwood, A. (2002). Ultrasound decontami-nation of minimally processed fruits and vegetables. *International Journal of Food Science and Technology*, *37*, 547–557.
153. Shi, J., & Le Maguer, M. (2002). Osmotic dehydration of foods: mass transfer and modeling aspects. *Food Reviews International*, *18*, 305–335.
154. Shoh, A. (1988). Industrial applications of ultrasound. In *Ultrasound—Its Chemical, Physical, and Biological Effects*, Suslik, K. S., (Ed.), VCH Publishers: New York, pp. 97–122.
155. Shore, D., Woods, M. O., & Miles, C. A. (1986). Attenuation of ultrasound in post rigor bovine skele-tal muscle. *Ultrasonics*, *24*, 81–87.
156. Simal, S., Benedito, J., Sanchez, E. S., & Rossello, C. (1998). Use of ultrasound to increase mass trans-fer rates during osmotic dehydration. *Journal of Food Engineering*, *36*, 323–336.
157. Skene, G., Martin, J. M., Delaney, D., Paluch, L., & Capodieci, R. A. (2004). Method and system for forming a cooked product using ultrasonic energy. United States of America Patent 6,783,784.
158. Smith, N. B., Cannon, J. E., Novakofski, J. E., McKeith, F. K., & O'Brien, W. D. (1991). Tenderization of semitendinosus muscle using high intensity ultrasound. *Proceedings of the IEEE Ultrasonics Symposium*, Orlando, Florida, USA, Volume 2, pp. 1371–1374.
159. Stagni, N., & de Bernard, B. (1968). Lysosomal enzyme activity in rat and beef skeletal muscle. *Biochimica et Biophysica Acta*, *170*, 129–139.
160. Sun, D. W., & Li, B. (2003). Microstructural change of potato tissues frozen by ultrasound-assisted immersion freezing. *Journal of Food Engineering*, *57*, 337–345.
161. Suslick, K. S. (1988). Homogenous sonochemistry. In *Ultrasound—Its Chemical, Physical, and Biological Effects*, Suslik, K. S., (Ed.), VCH Publishers: New York, pp. 123–163.
162. Suslick, K. S., & Price, G. J. (1999). Applications of ultrasound to materials chemistry. *Annual Review of Materials Science*, *29*, 295–326.
163. Taiwo, K. A., Eshtiaghi, M. N., Ade-Omowaye, B. I. O., & Knorr, D. (2003). Osmotic dehydration of strawberry halves: influence of osmotic agents and pretreatment methods on mass transfer and product characteristics. *International Journal of Food Science and Technology*, *38*, 693–707.
164. Tarleton, E. S., & Wakeman, R. J. (1998). Ultrasonically assisted separation processes. In *Ultrasound in Food Processing*, Povey, M. J. W., & Mason, T. J., (Eds.), Blackie Academic and Professional: London, pp. 193–218.
165. Tarrant, P. V. (1998). Some recent advances and future priorities in research for the meat industry. *Meat Science*, *49*, S1–S16.
166. Tsukamoto, I., Yim, B., Stavarache, C. E., Furuta, M., Hashiba, K., & Maeda, Y. (2004). Inactivation of *Saccharomyces cerevisiae* by ultrasonic irradiation. *Ultrasonics Sonochemistry*, *11*, 61–65.
167. van der Windt, D. A. W. M., van der Heijden, G. J. M. G., van den Berg, S. G. M., ter Riet, G., de Winter, A. F., & Bouter, L. M. (1999). Ultrasound therapy for musculoskeletal disorders: a systematic review. *Pain*, *81*, 257–271.
168. Vercet, A., Burgos, J., Crelier, S., & Lopez-Buesa, P. (2001). Inactivation of proteases and lipases by ultrasound. *Innovative Food Science and Emerging Technologies*, *2*, 139–150.
169. Vercet, A., Burgos, J., & Lopez-Buesa, P. (2001). Manothermosonication of foods and food-resembling systems: effect on nutrient content and nonenzymatic browning. *Journal of Agricultural and Food Chemistry*, *49*, 483–489.
170. Vercet, A., Burgos, J., & Lopez-Buesa, P. (2002). Manothermosonication of heat-resistant lipase and protease from *Pseudomonas fluorescens*: effect of pH and sonication parameters. *Journal of Dairy Research*, *69*, 243–254.
171. Vercet, A., Lopez, P., & Burgos, J. (1999). Inactivation of heat-resistant pectinmethyl-esterase from orange by manothermosonication. *Journal of Agricultural and Food Chemistry*, *47*, 432–437.

172. Vercet, A., Sanchez, C., Burgos, J., Montanes, L., & Lopez-Buesa, P. (2002). The effects of manothermosonication on tomato pectic enzymes and tomato paste rheological properties. *Journal of Food Engineering*, *53*, 273–278.
173. Villamiel, M., & de Jong, P. (2000). Inactivation of *Pseudomonas fluorescens* and *Streptococcus thermophilus* in Trypticase<sup>®</sup> Soy Broth and total bacteria in milk by continuous-flow ultrasonic treatment and conventional heating. *Journal of Food Engineering*, *45*, 171–179.
174. Villamiel, M., & de Jong, P. (2000). Influence of high-intensity ultrasound and heat treatment in continuous flow on fat, proteins, and native enzymes of milk. *Journal of Agricultural and Food Chemistry*, *48*, 472–478.
175. Villamiel, M., van Hamersveld, E. H., & de Jong, P. (1999). Review: effect of ultrasound processing on the quality of dairy products. *Milk Science International*, *54*, 69–73.
176. Vimini, R. J., Kemp, J. D., & Fox, J. D. (1983). Effects of low frequency ultrasound on properties of restructured beef rolls. *Journal of Food Science*, *48*, 1572–1573.
177. Wade, G. (2000). Human uses of ultrasound: ancient and modern. *Ultrasonics*, *38*, 1–5.
178. Waite, A. D. (2002). *Sonar for Practising Engineers* (3rd Edition). Wiley: Chichester.
179. Wang, D., Sakakibara, M., Kondoh, N., & Suzuki, K. (1996). Ultrasound-enhanced lactose hydrolysis in milk fermentation with *Lactobacillus bulgaricus*. *Journal of Chemical Technology and Biotechnology*, *65*, 86–92.
180. Wang, X. L., Li, X. F., Fu, X. Q., Chen, R., & Gao, B. (2005). Effect of ultrasound irradiation on polymeric microfiltration membranes. *Desalination*, *175*, 187–196.
181. Waters, D. A. (2003). Bats and moths: what is there left to learn? *Physiological Entomology*, *28*, 237–250.
182. Watwe, R. M., & Bellare, J. R. (1995). Manufacture of liposomes—a review. *Current Science*, *68*, 715–724.
183. Wells, P. N. T. (1999). Ultrasonic imaging of the human body. *Reports on Progress in Physics*, *62*, 671–722.
184. Wrigley, D. M., & Llorca, N. G. (1992). Decrease of *Salmonella typhimurium* in skim milk and egg by heat and ultrasonic wave treatment. *Journal of Food Protection*, *55*, 678–680.
185. Wu, H., Hulbert, G. J., & Mount, J. R. (2000). Effects of ultrasound on milk homogenization and fermentation with yogurt starter. *Innovative Food Science and Emerging Technologies*, *1*, 211–218.
186. Xiao, Y. M., Wu, Q., Cai, Y., & Lin, X. F. (2005). Ultrasound-accelerated enzymatic synthesis of sugar esters in nonaqueous solvents. *Carbohydrate Research*, *340*, 2097–2103.
187. Yasui, K., Tuziuti, T., Sivakumar, M., & Iida, Y. (2004). Sonoluminescence. *Applied Spectroscopy Reviews*, *39*, 399–436.
188. Yin, X., Han, P., Lu, X., & Wang, Y. (2004). A review on the dewaterability of bio-sludge and ultrasound pretreatment. *Ultrasonics Sonochemistry*, *11*, 337–348.
189. Zayas, Y. F., & Pento, V. B. (1973). Ultrasonic spraying of thermolabile materials and their drying in the acoustic field. *19th European Meeting of Meat Research Workers Conference*, *3*: 1265–1284.
190. Zenker, M., Heinz, V., & Knorr, D. (2003). Application of ultrasound-assisted thermal processing for preservation and quality retention of liquid foods. *Journal of Food Protection*, *66*, 1642–1649.
191. Zheng, L., & Sun, D. W. (2006). Innovative applications of power ultrasound during food freezing processes—a review. *Trends in Food Science and Technology*, *17*, 16–23.
192. Zhong, M. T., Ming, X. W., Su, P. W., & Ju, Q. K. (2004). Effects of ultrasound and additives on the function and structure of trypsin. *Ultrasonics Sonochemistry*, *11*, 399–404.
193. Zhu, C., & Liu, G. (2000). Modeling of ultrasonic enhancement on membrane distillation. *Journal of Membrane Science*, *176*, 31–41.
194. Zhu, C., Liu, G. L., Cheung, C. S., Leung, C. W., & Zhu, Z. C. (1999). Ultrasonic stimulation on enhancement of air gap membrane distillation. *Journal of Membrane Science*, *161*, 85–93.



# 30

## *Food Preservation Aspects of Ohmic Heating\**

Marybeth Lima

### CONTENTS

30.1	Overview .....	742
30.2	General Information on Ohmic Heating .....	742
30.2.1	Advantages .....	742
30.2.2	Applications .....	742
30.2.3	Design .....	743
30.2.4	Cost .....	743
30.3	Parameters of Importance in Ohmic Heating .....	744
30.3.1	Product Properties .....	744
30.3.2	Texture Analysis.....	744
30.3.3	Gelatinization .....	744
30.3.4	Heat Generation .....	745
30.4	Modeling of Ohmic Heating Processes.....	745
30.4.1	Basic Equations .....	745
30.4.2	Microbial Death Kinetics.....	746
30.4.3	Vitamin Degradation Kinetics .....	746
30.5	Novel Uses of Ohmic Heating .....	746
30.5.1	Background .....	746
30.5.2	Blanching .....	747
30.5.3	Evaporation .....	747
30.5.4	Dehydration .....	747
30.5.5	Fermentation .....	747
30.5.6	Extraction .....	748
30.5.7	Summary of Novel Processes .....	748
30.6	Future Research Directions .....	748
	References .....	748

\* This publication has been approved by the Director of the Louisiana Agricultural Experiment Station as manuscript number 04-22-0716. Reference to commercial products or trade names does not imply endorsement or discrimination by the LSU AgCenter.

This chapter was an invited rewrite for the second edition of the *Handbook of Food Preservation*. The original chapter was written by M. Shafiur Rahman and was entitled “Preserving Foods with Electricity: Ohmic Heating,” and Figure 30.1 is from the original work. This chapter also draws significantly from a chapter entitled “Ohmic and Inductive Heating” (by R. Bengtson, E. Birdsall, S. Feilden, S. Bhattiprolu, S. Bhale, and M. Lima) published by CRC Press in the *Handbook of Food Engineering*. CRC Press has provided copyright permission for significant portions of the chapter to be used in this CRC Press publication.

---

## 30.1 Overview

Ohmic heating, also known as Joule heating, electric resistance heating, direct electric resistance heating, electroheating, and electroconductive heating, is a process in which alternating electric current is passed through food material; heat is internally generated within the material owing to its resistance to the applied electrical current. In conventional heating, heat transfer occurs from a heated surface to the product interior by means of convection and conduction and is time consuming, especially with longer conduction or convection paths that may exist in the heating process. Electroresistive or ohmic heating is volumetric in nature and thus has the potential to reduce overprocessing by virtue of its inside–outside heat transfer pattern.

Ohmic heating is not a new technology; it was used as a commercial process in the early twentieth century for the pasteurization of milk [28]. However, the “electropure process” was discontinued between the late 1930s and 1960s, ostensibly because of the prohibitive cost of electricity and a lack of suitable electrode materials. Interest in ohmic heating was rekindled in the 1980s, when investigators were searching for viable methods to effectively sterilize liquid–large particle mixtures, a scenario for which aseptic processing alone was unsatisfactory.

The purpose of this chapter is to present general information about ohmic heating, especially with regard to food preservation. This chapter is separated into several sections: (1) general information on ohmic heating, (2) modeling of ohmic heating preservation processes, (3) novel uses of ohmic heating, and (4) future research directions.

---

## 30.2 General Information on Ohmic Heating

### 30.2.1 Advantages

Ohmic heating exhibits several advantages with respect to conventional food processing technologies as follows:

- i. Particulate foods up to 1 in.<sup>3</sup> are suitable for ohmic heating; the flow of a liquid–particle mixture approaches plug flow when the solids content is considerable (20%–70%).
- ii. Liquid–particle mixtures can heat uniformly under some circumstances (for example, if liquids and particles possess similar electrical conductivities, or if properties such as solids concentration, viscosity, conductivity, specific heat, and flow rate are manipulated appropriately).
- iii. Temperatures sufficient for ultra high temperature (UHT) processing can be rapidly achieved.
- iv. There are no hot surfaces for heat transfer, resulting in a low risk of product damage from burning or overprocessing.
- v. Energy conversion efficiencies are very high.
- vi. Relatively low capital cost.

### 30.2.2 Applications

Ohmic heating can be applied to a wide variety of foods, including liquids, solids, and fluid–solid mixtures. Ohmic heating is being used commercially to produce liquid egg product in the United States. It is also being used in the United Kingdom and Japan for the processing of whole fruits such as strawberries. Additionally, ohmic heating has been successfully applied to a wide variety of foods in the laboratory, including fruits and vegetables, juices, sauces, stews, meats, seafood, pasta, and soups. In 1997, there were 19 plants operating worldwide using ohmic heating technology [5].

Widespread commercial adoption of ohmic heating in the United States is dependent on regulatory approval by the FDA, a scenario that requires full understanding of the ohmic heating process with regard to heat transfer (temperature distributions), mass transfer (concentration distributions, which are influenced by electricity), momentum transfer (fluid flow), and kinetic phenomena (thermal and possibly electrothermal death kinetics, and nutrient degradation). Currently, there are no ohmic heating units available for household use.

Larkin and Spinak [20] examined safety considerations for ohmically heated, aseptically processed, multiphase low-acid food products, and discussed the need for providing information on equipment design, product specification, process design, and process validation for regulators. Full knowledge of these areas is critical to ensure that the food product receives adequate thermal treatment. Significant research strides toward widespread commercial use have been made, though more work remains to be done.

### 30.2.3 Design

Ohmic heating devices consist of electrodes, a power source, and a means of confining the food sample (e.g., a tube or vessel). Appropriate instrumentation, safety features, and connections to other process unit operations (e.g., pumps, heat exchangers, and holding tubes) may also be important. Ohmic heaters can be static (batch) or continuous. Figure 30.1 is a schematic diagram of a static ohmic heating process.

Important design considerations include electrode configuration (current flows across product flow path or parallel to product flow path), the distance between electrodes, electrolysis (metal dissolution of electrodes, particularly at low frequencies), heater geometry, frequency of alternating current (AC), power requirements, current density, applied voltage, and product velocity and velocity profile. Additional factors regarding the food system used in an ohmic heater include the type of product and its properties, especially electrical conductivity and heating rate; others include percent solids, acidity, product viscosity, specific heat, and density, and solid particle size, shape, and orientation to the electric field. Substantial literature has been devoted to these topics [2,7,15,27,31,33,34,50].

Coated electrodes can minimize or eliminate electrolytic reactions; temperature measurement remains an area of concern because many measurement methods influence the electric field during ohmic heating. Some success has been seen with thermocouples that are coated with material such as Teflon; however, noninvasive temperature measurements that do not interfere with the electric field remain a challenge, particularly with regard to temperature measurement inside particles.

### 30.2.4 Cost

Investigators [1] compared the cost of installation and operation of ohmic food processing systems to that of conventional retorting, freezing, and heating in a conventional tubular heat exchanger. The components included in the cost analyses were labor, energy, packaging, equipment maintenance and repairs, plant supplies, and interest and depreciation on the processing and filling equipment. Ohmic operational costs were found to be comparable to those for freezing and retort processing of low-acid food products. Though ohmic heating was found to be more costly than conventional methods for processing high-acid foods, the authors believed that ohmic heating was still be viable in these cases because of its potential to produce superior product quality.

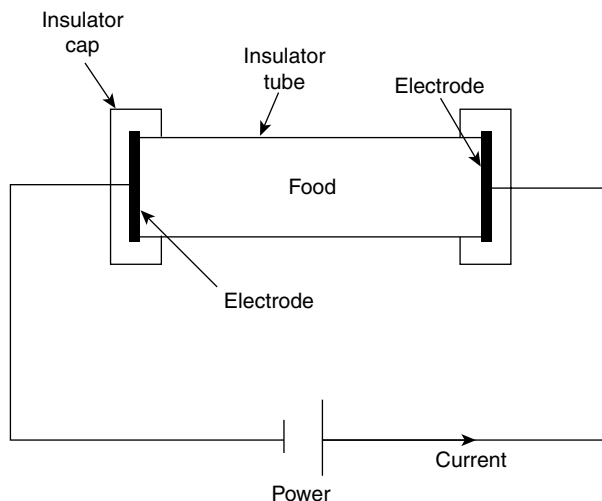


FIGURE 30.1 Schematic diagram of an ohmic heating process.

### 30.3 Parameters of Importance in Ohmic Heating

#### 30.3.1 Product Properties

The most important parameter of interest in ohmic heating is the electrical conductivity of the food and food mixture. Substantial research was conducted on this property in the early 1990s because of the importance of electrical conductivity with regard to heat transfer rate and temperature distribution. The electrical conductivity is determined using the following equation [27]:

$$\sigma = \frac{L}{AR}$$

where  $\sigma$  is the specific electrical conductivity (S/m),  $A$  the area of cross section of the sample ( $\text{m}^2$ ),  $L$  the length of the sample (m), and  $R$  the resistance of the sample (ohm). General\* findings of numerous electrical conductivity studies are as follows. The electrical conductivity is a function of food components: ionic components (salt), acid, and moisture mobility increase electrical conductivity, while fats, lipids, and alcohol decrease it. Electrical conductivity is linearly correlated with temperature when the electrical field is sufficiently high (at least 60 V/cm). Nonlinearities (sigmoidal curves) are observed with lower electrical field strength [23,27]: (i) electrical conductivity increases as temperature and applied voltage increases, and decreases as solids content increases, (ii) lowering the frequency of AC during ohmic heating increases the electrical conductivity, (iii) the waveform can influence the electrical conductivity; though AC is usually delivered in sine waves, sawtooth waves increased the electrical conductivity in some cases, while square waves decreased it [23], (iv) electrical conductivity increases by heating cycle; preheated samples showed increased electrical conductivity as opposed to raw samples when both were subsequently subjected to ohmic heating [40].

The electrical conductivity of solids and liquids during ohmic heating of multiphase mixtures is also critically important. In an ideal situation, liquid and solid phases possess essentially equal electrical conductivities and would thus (generally) heat at the same rate. When there are differences in the electrical conductivity between a fluid and solid particles, the particles heat faster than the fluid when their conductivities are lower than the fluid. Also, solid particulates heat more slowly than a fluid when the electrical conductivity of the solid is higher than that of the fluid. Fluid motion (convective heat transfer) is also an important consideration when there are electrical conductivity differences between fluids and particles.

Other product properties that may affect temperature distribution include the density and specific heat of the food product. When solid particles and a fluid medium have similar electrical conductivities, the component with the lower heat capacity will tend to heat faster. High densities and specific heats are conducive to slower heating. Fluid viscosity also influences ohmic heating; higher viscosity fluids tend to result in faster ohmic heating than lower viscosity fluids.

#### 30.3.2 Texture Analysis

Sensory evaluation is critically important to any viable food process. Numerous publications have cited the superior product quality that can be obtained through decreased process time, though few published studies specifically quantify sensory and texture issues. Six stew formulations sterilized using ohmic heating before and after 3 years of storage were analyzed; the color, appearance, flavor, texture, and overall food quality ratings were excellent, "indicating that ohmic heating technology has the potential to provide shelf-stable foods closely equivalent to those prepared from scratch" [45]. Ozkan et al. [26] showed that the quality and mechanical properties of hamburgers cooked with a combination of conventional and ohmic heating were not different from hamburgers cooked with conventional heating.

#### 30.3.3 Gelatinization

Starch gelatinization is an important parameter in food processing and can be either advantageous or disadvantageous depending on the desired product formulation. The electrical conductivity of a food product is

\* These findings are true in general; some exceptions may exist depending on the situation.

influenced significantly by starch gelatinization [40]. These investigators found that electrical conductivity decreased with the degree of gelatinization and suggested that ohmic heating can be used in the development of a sensor to detect starch gelatinization. Ohmic heating was used to maximize the gel functionality of a seafood product [48]. The ohmic heating process was superior to the conventional heating process because of rapid heating that deactivated enzymes, which in turn enabled strong gel formation.

### 30.3.4 Heat Generation

Heat is generated internally during ohmic heating and is not necessarily uniform. Thus, prediction equations to estimate the heat generation are an important issue in ohmic heating to address questions like [20]: (i) Where is the cold spot in the medium? (ii) What is the lethal treatment delivered to the cold spot? (iii) How is the lethal treatment ensured? Keys to the ohmic process include the rate of heat generation, the electrical conductivity of the food material, and the way in which food flows through the ohmic heater. More specific information on handling these issues can be found in Sections 30.3.1 and 30.4.1.

## 30.4 Modeling of Ohmic Heating Processes

### 30.4.1 Basic Equations

Considerable effort has been expended to model the heat transfer mechanisms and microbial death kinetics involved during ohmic heating. Models are of interest in the analysis and design of ohmic heating processes to provide information about the temperature distribution throughout the process, especially “the cold spot,” and provide accurate predictions of the minimum lethal processing time. Complexities in modeling heat transfer processes during ohmic heating arise when the liquid and particle possess different electrical conductivities, and because electrical conductivity is a (sometimes nonlinear) function of temperature and frequency of AC. Basic equations regarding ohmic heating are included below. The temperature distribution in a fluid during ohmic heating is based on an energy balance as follows:

$$\rho C_p v_z \frac{\partial T_f}{\partial z} = \nabla \cdot (k_f \nabla T_f) - n_p A_p h_{fp} (T_f - T_{ps}) + \dot{u}_f$$

where  $\rho$  is the density ( $\text{kg/m}^3$ ),  $C_p$  the specific heat ( $\text{J/kg K}$ ),  $T$  the temperature ( $^{\circ}\text{C}$ ),  $z$  the distance (m),  $v_z$  the fluid velocity (m/s), f the fluid, p the particle, ps the particle surface,  $k$  the thermal conductivity ( $\text{W/m K}$ ),  $n_p$  the number of particles,  $A$  the surface area of particles ( $\text{m}^2$ ),  $h_{fp}$  the fluid to particle heat transfer coefficient ( $\text{W/m}^2 \text{K}$ ), and  $\dot{u}_f$  the internal energy generation rate of the fluid. The temperature distribution in a particle during ohmic heating can be predicted with the conduction heat transfer equation with internal energy generation:

$$\nabla \cdot (k \nabla T) + \dot{u} = \rho C_p \frac{\partial T}{\partial t}$$

where  $k$  is the thermal conductivity.

The internal energy generation is

$$\dot{u} = |\nabla V|^2 \sigma$$

where  $V$  is the voltage,  $\sigma$  the electrical conductivity, and  $\dot{u}$  the energy generation rate per unit volume. The voltage field is determined by solving

$$\nabla \cdot (\sigma \nabla V) = 0$$

Numerous models have been developed based on numerical solution of these equations with appropriate boundary conditions and assumptions and also from dimensional groupings. Though these models have contributed significantly to the understanding of heat transfer in ohmic heating, none have completely described the ohmic heating process to date.

The voltage field (Laplace) equation for a single solid particle in a static heater has been solved [8]. Numerical solutions and experimental simulations to more complex ohmic heating situations have been developed [10,35,36]. Thermal-hydraulic aspects of ohmic heating were studied, and it was found that the temperature distribution can vary significantly even when ohmic heating rates are uniform [30]. Davies et al. [6] quantified the effects of a nonuniform electric field on temperature distributions during



ohmic heating, while others [32,46,47] used magnetic resonance imaging to rapidly map and model the temperature of solid–liquid particle mixtures during ohmic heating.

### 30.4.2 Microbial Death Kinetics

In terms of microbial death kinetics, considerable attention has been paid to the following question: does electricity result in microbial death, or is microbial death caused solely by heat treatment? The challenge in modeling microbial death kinetics is precise matching of time–temperature histories between ohmic and conventional processes. The FDA has published a comprehensive review of microbial death kinetics data regarding ohmic heating [9].

Initial studies in this area showed mixed results, though the experimental details were judged insufficient to draw meaningful conclusions [28]. Researchers compared death kinetics of yeast cells under time–temperature histories as identical as possible and found no difference between conventional and ohmic heating [29]. More recent work in this area has indicated that decimal reduction times of *Bacillus subtilis* spores were significantly reduced when using ohmic heating at identical temperatures [4]. These investigators also used a two-step treatment process involving ohmic heating, followed by holding and heat treatment, which accelerated microbial death kinetics; they hypothesized that electroporation may positively influence microbial death kinetics. The inactivation of yeast cells in phosphate buffer by low-amperage direct current (DC) electrical treatment and conventional heating at isothermal temperatures was examined [11]. These researchers concluded that a synergistic effect of temperature and electrolysis was observed when the temperature became lethal for yeast.

Further research regarding microbial death kinetics, survivor counts subsequent to treatment, and the influence of electricity on cell death kinetics are necessary to address regulatory issues. At the present time, assuming that microbial death is only a function of temperature (heat) results in an appropriately conservative design assumption.

### 30.4.3 Vitamin Degradation Kinetics

Limited information exists regarding product degradation kinetics during ohmic heating. Researchers measured vitamin C degradation in orange juice during ohmic and conventional heating under nearly identical time–temperature histories and concluded that electricity did not influence vitamin C degradation kinetics [24]. This study was conducted at one electrical field strength ( $E = 23.9$  V/cm). Others found that the ascorbic acid degradation rate in buffer solution during ohmic heating was a function of power, temperature, NaCl concentration, and products of electrolysis [2]. Further research in this area could include the influence of electrical field strength, endpoint temperature, and frequency of AC on the degradation of food components during ohmic heating. The characterization of electrolysis is also a critical need in this area.

---

## 30.5 Novel Uses of Ohmic Heating

### 30.5.1 Background

Early research on ohmic heating was conducted on heat transfer and sterilization of liquid–particle mixtures. In executing such studies, investigators observed unanticipated phenomena. For example, ohmically heating beetroot resulted in enhanced diffusion of betanin from the beetroot tissue when compared to beetroot tissue heated conventionally [12]. These investigators hypothesized that the enhanced mass transfer could be caused by electroosmosis.

Investigators expanded on the aforementioned work and found that diffusion of beet dye from beetroot into a carrier solution was enhanced as much as 40% during heating from 20°C to 80°C and that the concentration of diffused dye was proportional to particle surface area and a linear function of electric field strength [37]. Other researchers ohmically heated Japanese white radish and found that the ohmic heating rate was influenced by frequency; as the frequency of AC decreased, the heating rate increased [13]. These investigators used H-NMR analysis and hypothesized that at low frequency (50 Hz), rapid heating is caused by electroporation of radish tissue membrane, which resulted in a decrease of electrical impedance. Subsequent studies [18,34] have concluded that electroporation is the most likely mechanism for enhanced mass transfer effects during ohmic heating.

Electroporation is defined as the formation of holes in a cell membrane resulting from local pressure of ions, which cannot initially permeate the cell membrane, but are forced against it by the electric field [43]. The relatively low alternating frequencies employed during ohmic heating enable this charge buildup to occur on the cell wall, resulting in the formation of pores. This also suggests that the lower the frequency of ohmic heating, the more pronounced the mass transfer effect; this concept has been demonstrated in the literature [18,19,21]. It was found that DC resulted in less mass transfer enhancement than low AC frequency ohmic heating (at 15 V/cm, 250 Hz < DC < 50 Hz), and postulated that a monopolar electric charge (DC) is not as effective as a bipolar electric charge at creating stress on the cell membrane, thus yielding less of an effect than low-frequency AC [18].

Electrically heating foods influences their mass transfer properties. This phenomenon has important implications for food processing operations that involve mass transfer. In 2001, the FDA reported that “a large number of potential future applications exist for ohmic heating, including its use in blanching, evaporation, dehydration, fermentation, and extraction” [9]. In this section, we report on some of the research regarding these novel uses.

### 30.5.2 Blanching

Because blanching requires large volumes of water during processing and often requires dicing vegetables, studies to increase the efficiency of blanching using ohmic heating are important. Wigerstrom [44] found that electric fields enhanced moisture loss during the blanching of potato slices. Mizrahi [25] determined that ohmic heating was an effective method for blanching because the rapid, uniform heating exhibited by ohmic heating eliminated the need for dicing vegetables. The quick process time and reduction in surface area (no dicing) reduced solute losses by an order of magnitude during blanching. Sensoy and Sastry [38] found that using ohmic heating during the blanching of mushrooms resulted in the shrinking of mushrooms at a lower temperature and with less water use as compared to conventional blanching. Lakkakula et al. [19] showed significant lipase deactivation in rice bran during ohmic heating, with and without a corresponding temperature increase. Taken collectively, these studies show that ohmic heating can increase process efficiency in blanching.

### 30.5.3 Evaporation

Wang and Chu [39] studied the effect of ohmic heating on the vacuum evaporation of orange juice and found that the evaporation rate could be increased as much as three times using ohmic heating, and resulted in enhanced product quality. The authors conclude that ohmic heating has potential as a fast evaporation method and recommend further development in this area.

### 30.5.4 Dehydration

Ohmic heating has also been used to enhance the drying rate of vegetable tissue. Wang and Sastry [41] showed that ohmically treating sweet potato prior to dehydration accelerated the hot-air drying rate significantly compared to raw, conventionally treated, and microwaved samples. Lima and Sastry [21] found that the lower the frequency of AC used in ohmic heating, the faster the hot-air drying rate. Maximum drying benefits were seen when drying to initial or intermediate moisture contents. Zhong and Lima [49] showed that ohmic pretreatment accelerated the vacuum drying rate of sweet as much as 24%; these investigators also demonstrated that minimal ohmic treatment (electrical field strength of 50 V/cm and an endpoint temperature of 40°C) resulted in the maximal or near-maximal acceleration of drying rate. These investigators suggested that because ohmic heating enhances drying rates and enhances extraction yields, the process could be ideal for the recovery of high-value, heat-labile components from biological materials using unit operations such as supercritical fluid extraction.

### 30.5.5 Fermentation

Cho et al. [3] found that mild electrical treatment significantly decreased the lag time of *Lactobacillus acidophilus*, possibly due to electroporation, which could enhance the transport of substrates across the cell membrane. These investigators also found that electricity applied later in the microbial growth cycle proved detrimental, possibly because of the enhanced transport of inhibitory substances across the cell membrane.

### 30.5.6 Extraction

Ohmic heating has been used to enhance the extraction of components from foods. Katrokha et al. [14] used an electric field to extract sugar from sugar beets. Kim and Pyun [16] extracted soymilk from soybeans. Lima and Sastry [21] and Wang and Sastry [42] found that ohmically heating apple tissue prior to mechanical juice extraction significantly increased apple juice yields with respect to nontreated apple tissue, and that the lower the frequency of AC, the higher the extraction yield.

Several studies have examined the diffusion of beet dye from beetroot; in addition to the pioneering work mentioned above, Lima et al. [22] found that the diffusion enhancement of beet dye owing to ohmic heating was especially pronounced at lower temperatures (42°C versus 58°C and 72°C) and could be related to the difference in electrical conductivity of beet tissue between conventional and ohmic cases at the same temperature. Kulshrestha and Sastry [17] showed that significant leaching of beet dye occurs with temperature increases of 1°C–2°C in ohmic heating. Lakkakula et al. [19] used ohmic heating to significantly increase the extraction of rice bran oil from rice bran (with moisture addition), especially at low (1 Hz) frequency.

### 30.5.7 Summary of Novel Processes

There exists a strong potential to enhance mass transfer operations using ohmic heating, particularly because mild ohmic treatment has been shown to significantly increase dehydration and extraction efficiencies. Future work in these areas includes establishing a more complete body of knowledge regarding the mechanisms for mass transfer effects, and process design to establish industrial processes that take advantage of this technology.

---

## 30.6 Future Research Directions

Although there has been a proliferation of published research on ohmic heating during the past 15 years, there exist many opportunities for contributing to the body of knowledge regarding ohmic heating. Areas of future work include the following:

1. Developing temperature measurement methods that are (preferably) noninvasive and that do not interfere with the electrical field for the internal monitoring of solid particles during ohmic heating.
2. Developing models that correlate process parameters and process design with properties of the product (physical, electrical, chemical, biological, microbial) to standardize ohmic heating design and analysis, and accurately quantify changes in process or product.
3. Determining the influence of temperature and electrical field on the degradation kinetics of key pathogenic microorganisms.
4. Developing the knowledge necessary to quantify the effects of electrical field on mass transfer properties to optimize promising applications of ohmic heating, including drying, extraction, blanching, fermentation, evaporation, and gelatinization.
5. Quantifying electrolytic effects during ohmic heating, particularly the minimization of electrolysis at low frequencies, where several novel process options exist.

---

## References

1. Allen, K., Eidman, V., and Kinsey, J. 1996. An economic-engineering study of ohmic food processing. *Food Technology*, May: 269–273.
2. Assiry, A., Sastry, S., and Samaranayake, C. 2003. Degradation kinetics of ascorbic acid during ohmic heating with stainless steel electrodes. *Journal of Applied Electrochemistry*, 33: 187–196.
3. Cho, H.-Y., Sastry, S. K., and Yousef, A. E. 1996. Growth kinetics of *Lactobacillus acidophilus* under ohmic heating. *Biotechnology and Bioengineering*, 49(3): 334–340.

4. Cho, H.-Y., Sastry, S. K., and Yousef, A. E. 1999. Kinetics of inactivation of *Bacillus subtilis* spores by continuous or intermittent ohmic and conventional heating. *Biotechnology and Bioengineering*, 62(3): 368–372.
5. Conferences. 1997. Events to come. *Food Australia*, 49: 224.
6. Davies, L., Kemp, M., and Fryer, P. 1999. The geometry of shadows: Effects of inhomogeneities in electrical field processing. *Journal of Food Engineering*, 40: 245–258.
7. de Alwis, A. and Fryer, P. 1992. Operability of the ohmic heating process: electrical conductivity effects. *Journal of Food Engineering*, 15: 21–48.
8. de Alwis, A. and Fryer, P. 1990. A finite element analysis of heat generation and transfer during ohmic heating of food. *Chemical Engineering Science*, 45(6): 1547–1559.
9. FDA, 2001. Kinetics of Microbial Inactivation for Alternative Food Processing Technologies: Ohmic and Inductive Heating. Available at <http://www.cfsan.fda.gov/~comm/ift-ohm.html>.
10. Fu, W. and Hsieh, C. 1999. Simulation and verification of two-dimensional ohmic heating in static system. *Journal of Food Science*, 64(6): 946–949.
11. Guillou, S. and Murr, N. 2002. Inactivation of *Saccharomyces cerevisiae* in solution by low-amperage electric treatment. *Journal of Applied Microbiology*, 92: 860–865.
12. Halden, K., de Alwis, A., and Fryer, P. 1990. Changes in the electrical conductivity of foods during ohmic heating. *International Journal of Food Science and Technology*, 25: 9–25.
13. Imai, T., Uemura, K., Ishida, N., Yoshizaki, S., and Noguchi, A. 1995. Ohmic heating of Japanese white radish *Rhaphanus sativus* L. *International Journal of Food Science and Technology*, 30: 461–472.
14. Katrokha, I., Matvienko, A., Vorona, L., Kupchik, M., and Zaets, V. 1984. Intensification of sugar extraction from sweet sugar beet cosettes in an electric field. *Sakharnaya Promyshlennost*, 7: 28–31.
15. Kim, H., Choi, Y., Yang, T., Taub, I., Tempest, P., Skudder, P., Tucker, G., and Parrott, D. 1996. Validation of ohmic heating for quality enhancement of food products. *Food Technology*, May: 253–261.
16. Kim, J. and Pyun, Y. 1995. Extraction of soy milk using ohmic heating. Abstract, 9th Congress of Food Science and Technology, Budapest, Hungary.
17. Kulshrestha, S. and Sastry, S. 1999. Low frequency dielectric changes in vegetable tissue from ohmic heating. Abstract No. 79 B-3, 1999 IFT Annual Meeting, Chicago, IL, July 24–28, 1999.
18. Kulshrestha, S. and Sastry, S. 2003. Frequency and voltage effects on enhanced diffusion during moderate electric field (MEF) treatment. *Innovative Food Science and Emerging Technologies*, 4: 189–194.
19. Lakkakula, N., Lima, M., and Walker, T. 2004. Rice bran stabilization and rice bran oil extraction using ohmic heating. *Bioresource Technology*, 92: 157–161.
20. Larkin, J. and Spinak, S. 1996. Safety considerations for ohmically heating, aseptically processes, multiphase low acid food products. *Food Technology*, May: 242–245.
21. Lima, M. and Sastry, S. 1999. The effects of ohmic heating frequency on hot-air drying rate and juice yield. *Journal of Food Engineering*, 41: 115–119.
22. Lima, M., Heskitt, B., and Sastry, S. 2001. Diffusion of beet dye during electrical and conventional heating at steady-state temperature. *Journal of Food Process Engineering*, 24(5): 331–340.
23. Lima, M., Heskitt, B., and Sastry, S. 1999. The effect of frequency and wave form on the electrical conductivity-temperature profiles of turnip tissue. *Journal of Food Process Engineering*, 22: 41–54.
24. Lima, M., Heskitt, B., Burianek, L., Nokes, S., and Sastry, S. 1999. Ascorbic acid degradation kinetics during conventional and ohmic heating. *Journal of Food Processing and Preservation*, 23(5): 421–434.
25. Mizrahi, S. 1996. Leaching of soluble solids during blanching of vegetables by ohmic heating. *Journal of Food Engineering*, 29: 153–166.
26. Ozkan, N., Ho, I., and Farid, M. 2004. Combined ohmic and plate heating of hamburger patties: quality of cooked patties. *Journal of Food Engineering*, 63: 141–145.
27. Palaniappan, S. and Sastry, S. 1991. Electrical conductivities of selected solid foods during ohmic heating. *Journal of Food Process Engineering*, 14: 221–236.
28. Palaniappan, S., Richter, E. R., and Sastry, S. K. 1990. Effects of electricity on microorganisms: A review. *Journal Food Processing and Preservation*, 14: 393–414.
29. Palaniappan, S., Sastry, S., and Richter, E. 1992. Effects of electroconductive heat treatment and electrical pretreatment on thermal death kinetics of selected microorganisms. *Biotechnology and Bioengineering*, 39(2): 225–232.
30. Quarini, G. 1995. Thermallyhydraulic aspects of the ohmic heating process. *Journal of Food Engineering*, 24: 561–574.

31. Reznick, D. 1996. Ohmic heating of fluid foods. *Food Technology*, May: 250–251.
32. Ruan, R., Chen, P., Chang, K., Kim, H., and Taub, I. 1999. Rapid food particle temperature mapping during ohmic heating using FLASH MRI. *Journal of Food Science*, 64(6): 1024–1026.
33. Sastry, S. 1996. Ohmic heating. *McGraw-Hill Yearbook of Science and Technology*, McGraw-Hill, New York, pp. 127–130.
34. Sastry, S. and Barach, J. 2000. Ohmic and inductive heating. *Journal of Food Science*, 65(4): 42–46.
35. Sastry, S. and Li, Q. 1993. Models for ohmic heating of solid-liquid mixtures. In *Heat Transfer in Food Processing, HTD*, M. Karwe, T. Bergman, and S. Paolucci (Eds.), American Society of Mechanical Engineers, New York, Vol. 254, pp. 25–33.
36. Sastry, S. and Li, Q. 1996. Modeling the ohmic heating of foods. *Food Technology*, May: 246–248.
37. Schreier, P., Reid, D., and Fryer, P. 1993. Enhanced diffusion during the electrical heating of foods. *International Journal of Food Science and Technology*, 28: 249–260.
38. Sensoy, I. and Sastry, S. 2004. Ohmic blanching of mushrooms. *Journal of Food Process Engineering*, 27: 1–15.
39. Wang, W. and Chu, C. 2003. Study of vacuum evaporation by using ohmic heating. Abstract No. 92 B-59, 1999 IFT Annual Meeting, Chicago, IL, July 12–16, 2003.
40. Wang, W. and Sastry, S. 1997. Starch gelatinization in ohmic heating. *Journal of Food Engineering*, 34: 225–242.
41. Wang, W. and Sastry, S. 2000. Effects of thermal and electrothermal pretreatments on hot air drying rate of vegetable tissue. *Journal of Food Process Engineering*, 23(4): 299–319.
42. Wang, W. and Sastry, S. 2002. Effects of moderate electrothermal treatments on juice yield from cellular tissue. *Innovative Food Science and Emerging Technologies*, 3: 371–377.
43. Weaver, J. 1987. Transient aqueous pores: A mechanism for coupling electric fields to bilayer and cell membranes. In *Mechanistic Approaches to Interactions of Electric and Electromagnetic Fields with Living Systems*, M. Blank and E. Findl (Eds.), Plenum Press, New York, pp. 249–270.
44. Wigerstrom, K. 1976. Passing an electric current of 50-60 Hz through potato pieces during blanching. U.S. Patent No. 3,997,678.
45. Yang, T. C. S., Cohen, J. S., Kluter, R. A., Tempest, P., Manvell, C., Blackmore, S. J., and Adams, S. 1997. Microbiological and sensory evaluation of six ohmically heated stew type foods. *Journal of Food Quality*, 20: 303–313.
46. Ye, X., Ruan, R., Chen, P., and Doona, C. 2004. Simulation and verification of ohmic heating in static heater using MRI temperature mapping. *Lebensmittel Wissenschaft und Technologie*, 37: 49–58.
47. Ye, X., Ruan, R., Chen, P., Chang, K., Ning, K., Taub, I., and Doona, C. 2003. Accurate and fast temperature mapping during ohmic heating using proton resonance frequency shift MRI thermometry. *Journal of Food Engineering*, 59: 143–150.
48. Yongsawatdigul, J., Park, J., and Kolbe, E. 1995. Electrical conductivity of Pacific whiting surimi paste during ohmic heating. *Journal of Food Science*, 60(5): 922–925, 935.
49. Zhong, T. and Lima, M. 2003. The effect of ohmic heating on vacuum drying rate of sweet potato tissue. *Bioresource Technology*, 87: 215–220.
50. Zoltai, P. and Swearingen, P. 1996. Product development considerations for ohmic processing. *Food Technology*, May: 263–266.

# 31

## *Light Energy in Food Preservation*

Mohammad Shafiur Rahman

### CONTENTS

31.1	Ultraviolet Radiation .....	751
31.2	UV in Food Preservation and Deterioration .....	751
31.2.1	Food Preservation Enhancement by UV.....	751
31.2.1.1	Juice .....	752
31.2.1.2	Fruits and Vegetables .....	753
31.2.1.3	Meat .....	754
31.2.1.4	Fish and Seafood.....	755
31.2.2	Quality Defects by UV .....	755
31.2.2.1	Oxidation.....	755
31.2.2.2	Effects on Flavors .....	755
31.2.2.3	UV in Sanitation .....	756
31.2.2.4	UV Mode of Action .....	756
31.3	Visible Light Radiation .....	756
31.4	Photoreactivation .....	757
	References .....	757

### 31.1 Ultraviolet Radiation

Ultraviolet (UV) radiation has been known for a long time as the major factor in the bactericidal value of sunlight. Because of its low penetration depth, it is mainly used to sterilize air and thin films of liquid. When used at high dosages, there is a marked tendency toward flavor and odor deterioration before satisfactory sterilization is achieved. But low levels of radiation at carefully applied doses usually extend the shelf life of foods without serious quality effects [3]. The technique of UV radiation to kill off bacteria in water is well known. UV is safe, environment friendly, and more cost-effective (Table 31.1) to install and operate than conventional chlorination. Unlike chlorine, it does not affect the taste of water. High intensity UV-C lamps can increase the potential of destroying surface bacteria on foods [8]. UV radiation has been used in dairy plants for many years. It is also being used in the ice cream industry, and in meat- and vegetable-processing plants [22]. More applications of UV irradiation are presented by Silliker et al. [45].

### 31.2 UV in Food Preservation and Deterioration

#### 31.2.1 Food Preservation Enhancement by UV

UV irradiation is being applied commercially in the food processing industry through the use of bactericidal UV lamps for tenderizing or aging of meat, curing and wrapping of cheeses, prevention of surface mold growth on bakery products, air purification in bottling and food processing establishments, and over pickle vats [4]. It is generally agreed that the optimal wavelength for maximum germicidal effect is 2600 Å. Low-pressure mercury vapor lamps have a maximum output of 2537 Å, a value close to the peak

TABLE 31.1

Cost Comparison of Different Juice Processing Methods

Process	Mode of Action	Cost (US cents/gal)
Carbon dioxide	Biochemical	5
High pressure	Mechanical	15
Pasteurization	Heat	5
Conventional UV	Light energy	0.2

Source: Updated from L. J. Forney and J. A. Pierson, *Resource* 11(1):7–8 (2004).

wavelength for bactericidal effectiveness. The lethal action varies with the time of exposure and intensity of light. Other influential factors include temperature, hydrogen ion concentration, and the number of organisms per unit area exposed. The relative humidity also affects the death rate of bacteria suspended in air, this being most noticeable at relative humidity values greater than 0.50, at which point an increase in relative humidity results in a decreased death rate [4].

Spores of bacteria are generally more resistant to UV light than vegetative bacteria; *Bacillus subtilis* is reported to be 5–10 times more resistant than *Escherichia coli*. Molds are more resistant than vegetative bacteria, while yeasts differ less from bacteria in this respect. It has been suggested that fatty or waxy secretions on the cell surface of some mold species may protect them from UV rays. Pigments apparently also afford some protection, dark-pigmented spores are more resistant to UV irradiation than nonpigmented types [4]. Short exposures, long enough to cover one or more life cycles of the organism, are more efficient than higher radiation intensities for brief periods. This presumably is due to the fact that during certain stages of the life cycle susceptibility to UV radiation is increased.

### 31.2.1.1 Juice

The lethal action of UV light on microorganisms has been well documented. The practical application of UV technology has been controversial because of the type and intensity of radiation, methods of estimating lethality, and other factors. A study of the germicidal powers of UV light shows that 30%–83% of yeasts and 33%–72% of molds were killed in apple cider through layers varying from 2 to 25 mm in thickness [4]. Coloring matter absorbed a greater part of the light. Incident energy levels of 253.7 nm inhibited 90% of *Bacillus megatherium* at 1100 mW s/cm<sup>2</sup> and 90% of *Sarcina lutea* at 19,800 mW s/cm<sup>2</sup> [2]. There was a 90% reduction in the microbial count of apple juice. Coupled with effective refrigeration, UV technology could be of commercial significance.

Maple sap is susceptible to microbial infection, which, when it occurs, lowers the quality of the syrup. Schneider et al. [43] studied the effects on the reduction of living cells of bacterial (*Pseudomonas-25* and *Pseudomonas-11*) and yeast (*Cryptococcus albidus*) strains suspended in maple sap when exposed to UV radiations of different intensities and for different lengths of time. It was observed that the two bacterial strains were equally more sensitive than the yeast. Increase in exposure time had the same effect regardless of the method of irradiation employed.

Freshly pressed apple juice or fresh cider contains many microorganisms that cause deterioration within 2 days at room temperature unless they are inhibited or destroyed. The microbial population of fresh cider was greatly reduced and storage life prolonged without affecting the flavor by specially designed UV lamps [18]. Harrington and Hills [18] found that percentage reduction of microbial count was affected by the clarity of the cider, the length of UV exposure, and the presence of potassium sorbate. This is very suitable where the initial microbial count is high and adequate refrigeration is not available. Hoyer [21] reported the UV dosage values for 90% reduction of *E. coli* ATCC 11229 and *E. coli* ATCC 23958 as 25 and 12.5 J/m<sup>2</sup>, respectively, and a value of 15 J/m<sup>2</sup> for a 1 log reduction of *E. coli* O157:H7 in drinking water. UV doses for 90% reduction, in model juices with dose distribution in annular UV reactors were determined and varied from 4500 to 6500 J/m<sup>2</sup> in a vertical setup [28]. The UV dose distribution must be taken into consideration when calculating the microbial inactivation achieved by the reactor and designing a continuous UV reactor [28].

Current UV reactors for juice processing use either very long tubes (up to 91 m) with UV-transparent walls or very thin films to ensure sufficient exposure to UV radiation. The reactor design with long tubes requires turbulent flow and over 38 L of juice exposed to a large number of UV lamps. In contrast, the

design with thin films operates in laminar flow but is restricted to low-viscosity juices with no pulp. Reactor is also designed with pumping fluid through the annular gap between two concentric cylinders. To provide sufficient exposure and reduce the fluid boundary layer thickness next to the radiation source contained within the outer stationary cylinder, the smaller inner cylinder rotates at a low rpm. Rotation of the inner cylinder establishes a complex flow field called Taylor–Couette flow, which consists of laminar vortices that both fill the annular gap of several millimeters and circumscribe the inner cylinder. UV is one of the nonthermal processes capable of providing the Food and Drug Authority (FDA) requirement of a 5 log reduction in viable pathogens [15]. A numerical dispersed phase model has been developed to describe the particle phase flow patterns and particle residence times in the thin-film UV reactor Cider Sure 1500 [50]. This model was used to simulate the processing of apple cider.

### 31.2.1.2 Fruits and Vegetables

The effect of UV on bacteria and fungi such as *Penicillium* and *Aspergillus* has been reported by Kleczkowski [27]. UV has been reported to inhibit fungal development in grape berries [9], kumquat, and orange fruits [40]. Moy et al. [34] combined UV and gamma radiation for the preservation of papaya. Combined methods can avoid high doses of gamma and UV radiations. UV irradiation exhibits a hormic effect in disease resistance and control of diseases for postharvest crops [1].

Lu et al. [29] studied the efficacy of gamma rays (0.1–3 kGy), electron beams (0.1–5.0 kGy), and UV radiation (4.4–73.3 kerg/mm<sup>2</sup>) to preserve Walla Walla onions for up to 4 weeks at 20°C–25°C. UV-radiated onions exhibited the greatest percentage of marketable onions and reduction in postharvest rots. Sprouting was observed with control, UV, and electron beam irradiated onions but not with those irradiated by gamma rays. No significant total sugar, pH, moisture, ascorbic acid, color, texture, and sensory quality changes were observed in onions irradiated with UV. The optimum UV doses were in the range of 35.8–73.3 kerg/mm<sup>2</sup>. In addition, UV is much more economical and safer to use than gamma or electron beam irradiation.

Ranganna et al. [37] studied the efficacy of UV radiation treatment in the control of both soft rot and dry rot diseases of potato tuber for a short-term storage period of 3 months and to understand the tuber quality changes when exposed to UV radiation. They tried four UV radiation dose levels (75, 100, 125, and 150 kerg/mm<sup>2</sup>) and three incubation levels each for the fungi *Fusarium solani* (0, 1, and 2 days) and the bacteria *Erwinia carotovora* var. *carotovora* (0, 6, and 12 h). The highest UV dose level was found to be more effective compared with the other three radiation dosages. Visual observations of potato quality showed that there was no significant change in the tuber quality such as firmness and color.

The effect of hormic dosage of UV radiation in delaying the senescence of tomato was investigated [32]. Mature green tomato fruits were irradiated (UV-C, 200–280 nm) corresponding to 0,  $3.7 \times 10^3$ , and  $24.4 \times 10^3$  J/m<sup>2</sup> and stored at 16°C, under high relative humidity for a period of 35 days. Attributes of senescence such as weight loss, color, texture, respiration rate, ethylene production, and putrescine were monitored periodically throughout the storage period. A dose of  $3.7 \times 10^3$  J/m<sup>2</sup> was found to be beneficial (hormic) in delaying ripening and senescence, while the higher dose impaired ripening and caused abnormal browning, manifested as sun scalding of the fruit's surface. The development of color and the softening of the tissue were significantly retarded during storage in response to the treatment with the hormic dose. In addition to a delay in the climacteric response by at least 7 days, the respiration rate and ethylene production of the treated fruit were also reduced. The delay in senescence was attributed, in part, to the maintenance of a high level of putrescine (antisenescence agents exerting opposite physiological effect to ethylene) [32].

UV-C irradiation could be used as an effective and rapid method to preserve the postharvest life of ripe mangoes without adversely affecting certain quality attributes [17]. Gonzalez-Aguilar et al. [17] used 10 and 20 min exposure sessions prior to storage to achieve a shelf-life period of 14 days at 5°C or 20°C and 7 days at 20°C. The treated fruits maintained better visual appearance, suppressed decay symptoms, maintained firmness, showed greater levels of putrescine and spermidine, and kept higher levels of sugars and lower levels of organic acids during storage at 5°C or 20°C.

Mau et al. [33] found that UV irradiation increased vitamin D<sub>2</sub> content in edible mushrooms. After UV-C irradiation for 2 h, vitamin D<sub>2</sub> contents in common and high-temperature mushrooms increased from 2.20 and 4.0 µg/g of dry weight to 7.30 and 5.32 µg/g, respectively. UV-B irradiation resulted in higher vitamin D<sub>2</sub> conversion for common mushrooms; after UV-B irradiation for 2 h, the vitamin D<sub>2</sub>



content reached 12.48 µg/g. Following UV-B irradiation for 2 h, vitamin D2 contents in shiitake and straw mushrooms increased from 2.16 and 3.86 µg/g to 6.58 and 7.58 µg/g, respectively. However, the ratio of increase in shiitake and straw mushrooms was not as high as in common mushrooms.

UV irradiation (6–48 h, 13.0–103.7 J/m<sup>2</sup>) showed potential for increasing the mechanical strength of cast soy protein films [16]. Besides increasing tensile strength, the appearance of immobile bands in electrophoretic patterns suggested further development of covalent cross-links in UV-treated films. Individual proteins may exhibit different degrees of response to UV radiation due to varying amino acid compositions and molecular structures. UV treatment is not expected to render soy protein films unsuitable for use as edible films or food wraps. UV treatment increased the tensile strength of gluten, zein, and albumin films suggesting the occurrence of UV radiation-induced cross-linking within the film structures. In the case of caseinate films, UV curing did not affect tensile strength but substantially reduced total soluble matter. Small but significant decreases in total soluble matter were also noticed for UV-treated zein and albumin films. UV irradiation reduced water vapor permeability of albumin films but did not affect water vapor permeability of the other types of films. Gluten, albumin, and caseinate films had increased yellowness as a result of UV treatment. In contrast, UV treatment decreased the yellowness of zein films, possibly due to the destruction of zein pigments [39]. The gel strength of minced mackerel with transglutaminase alone at a concentration of 0.47 unit/g was three times more than that of the control [24]. When transglutaminase-supplemented minced mackerel was exposed to UV light for the optimal irradiation time of 20 min, the gel strength was further increased by 25%. This suggested that UV irradiation accelerated transglutaminase to catalyze the cross-linking of myosin heavy chains in mackerel actomyosin [24]. With increasing exposure times, the molecular weight of proteins in water solutions decreased, with the excluded volume increases for the two kinds of proteins (pepsin and albumin) studied by Maciejewska et al. [31]. The denaturing effect of dimethyl sulfoxide on the solid samples of both starch components (amylase and amylopectin) was demonstrated by its spectral similarity [36]. Fiedorowicz et al. [13] studied a suspension of cornstarch in water that was irradiated by UV light with wavelengths greater than 250 nm at 25°C, under a stream of nitrogen or air, and for time intervals ranging from 5 to 25 h. They found that the molecular size distribution profiles confirmed the oxidative photodegradation in the early stage (up to 5 h), and cross-linking reactions in the late stage (5–15 h) of irradiation under aeration.

### 31.2.1.3 Meat

After killing, meat becomes tender upon storage as a result of enzymic activity. This process is speeded up at relatively high temperatures, which favor the growth of surface microorganisms. By controlling such growth with UV light, the advantage of high storage temperature can be better utilized, thereby resulting in less loss of meat. In this particular case, irradiation alone is the less likely active factor. The lamps employed emit rays not only in the germicidal 2537 Å range but also in the 1850 Å range. The shorter wavelength radiations convert atmospheric oxygen into ozone, which sterilizes the irregular and shaded areas of an irradiated surface. UV is also used in storage vats and other tanks, over conveyers and for final treatment of both caps and stoppers [4].

Putrefaction spoilage of fresh meat can occur in a few hours as a result of the action of spoilage bacteria. UV at a wavelength of 253.7 nm is effective in destroying surface bacteria on fresh beef meat by a 2-log cycle (99% reduction) decrease after a radiation dose of 150 mW s/cm<sup>2</sup> on smooth-surface beef meat. Further increase in the dose level to 500 mW s/cm<sup>2</sup> reduced bacteria by a 3-log cycle. Since UV radiation does not penetrate most opaque materials, it is less effective on rough surface cuts of meat, such as round steak, because bacteria are partly shielded from the radiation. No deleterious effects on color (redness) or general appearance were observed, and UV irradiation of meat carcasses could also effectively increase the lag phase of bacteria until adequate cooling of the surface has occurred [47].

The physical appearance of a retail cut in the display case is the most important factor determining consumer selection of beef products. Reagan et al. [38] mentioned that significant increases in case life might be obtained by exposure of beef muscle and fat surface to UV light (maximum wave of 3660 Å for 2 min). Decreases in initial count or attenuation of the bacteria present on retail cuts via the use of UV resulted in increased consumer acceptability, higher muscle color ratings, and increased shelf life of beef [38].

Kaess and Weidemann [26] found that continuous UV (0.2–24 µW/cm<sup>2</sup>) irradiation of psychrophilic microorganisms growing on muscle slices at 0°C and 0.993 equilibrium relative humidity resulted in an

extension of the lag phase of *Pseudomonas* and of the molds *Thamnidium* and *Penicillium*, but not the yeast *Candida scottii*. A minimum intensity of  $2 \mu\text{W}/\text{cm}^2$  at the meat surface is necessary to prolong storage life substantially. Lower equilibrium relative humidity did not substantially increase UV effects. The relative extension of storage life at  $10^\circ\text{C}$  was comparable to that obtained at  $0^\circ\text{C}$ . Simultaneous use of UV ( $0.2 \mu\text{W}/\text{cm}^2$ ) and ozone ( $0.5 \text{ mg}/\text{m}^3$ ) produced synergistic effects with molds, but not with bacteria [26].

#### 31.2.1.4 Fish and Seafood

The use of UV radiation is effective in inhibiting the action of spoilage bacteria on fish and seafood [8]. UV at 254 nm and doses of  $300 \text{ mW s}/\text{cm}^2$  from a photochemical reactor or  $4.8 \text{ W s}/\text{cm}^2$  from a high intensity UV-C lamp (40 s at  $120\text{--}180 \text{ mW}/\text{cm}^2$ ) reduced surface microbial count on mackerel by 2–3 log cycles [22]. Huang and Toledo [22] mentioned that the shelf life of Spanish fresh mackerel was extended by 7 days over the untreated sample when the skin surface was treated with high-intensity UV and stored in ice at  $-1^\circ\text{C}$ . When UV irradiated and packed in  $0^\circ\text{C}$  ice, surface microbial counts on vacuum-packaged mackerel lagged by 4 days than those on mackerel wrapped in 1 mil polyethylene [22].

The use of UV has some disadvantages, such as it does not penetrate most opaque materials and is less effective on rough surfaces [8]. Huang and Toledo [22] found that rough surface fish such as croaker and mullet had little bacterial count reduction on its surface with a UV-C-13 lamp at treatment doses of  $120\text{--}180 \text{ mW}/\text{cm}^2$  for up to 50 s. They found that spray washing with water containing 10 ppm chlorine by itself or in combination with UV was necessary to reduce surface counts on rough surface fish to the same extent as that on smooth surface fish.

### 31.2.2 Quality Defects by UV

UV radiation may also cause quality defects (such as fat oxidation and flavor changes) if it is not used properly.

#### 31.2.2.1 Oxidation

The oxidation of fat by photochemical action results in off-flavors, such as rancidity, tallowiness, fishiness, cardboard flavor, and oxidized flavor [12]. Coe and Le-Clerc [7] attributed rancidity to the UV light range of the spectrum. The defects of milk as fishiness [5] and cardboard-like flavor [3], butter fat [46], processed cheese [49] by light oxidation were identified. Thus, packaging materials with the ability to screen UV light have been developed for food products. Ellickson and Hasenzahl [12] observed that processed cheese in normal cellophane-wax-coated wrappers gets oxidized within 12 h and within 48 h the top slice becomes inedible. The degradation process can be retarded by incorporating a substituted benzophenone within the wax coating normally applied to certain types of cheese wrappers. Hirsch [19] mentions that the meaty portion of bacon starts to fade when exposed to UV light. This fading can be reduced appreciably through vacuum packaging and a UV barrier on the packaging material. A good vacuum-packaging operation will deliver a bacon package with no less than 28 in of vacuum pressure. By incorporating polyvinylidene chloride into the packaging material, both oxygen and UV light are screened and the product survives for a considerably longer period of time without fading.

Generally, retinoids are very susceptible to oxidation because of their alkyl chains with highly conjugated double bonds [44]. Shimoyamada et al. found that retinol and retinoic acid bound to  $\beta$ -lactoglobulin were less susceptible to light-induced oxidation by UV light irradiation than those that were free or bound to bovin serum albumin. They found a different mechanism of protection against light-induced oxidation compared to enzymatic oxidation. Jung et al. [25] found that the addition of ascorbic acid greatly inhibited the light-induced reduction of all-trans-retinyl palmitate and 13-*cis* isomer in skim milks. Ascorbic acid also greatly increased the formation of 9-*cis*-retinyl palmitate in skim milks during storage in light.

#### 31.2.2.2 Effects on Flavors

Iwanami et al. [23] studied the effect of UV radiation on lemon flavor composed of lemon oil, water (pH 6 phosphate buffer), and ethanol. Three new compounds of aldehyde were identified as photoreaction products of citral. Limonene, terpinolene, and nonanal decreased while P-cymene increased after UV

radiation. Other components such as sesquiterpene hydrocarbons, citronellal, linalool, and terpineols were slightly altered. These results suggest that citral is a more UV-unstable component in lemon flavor, and the photolysis of citral could affect other components in lemon flavor during UV radiation [23].

### 31.2.2.3 UV in Sanitation

UV rays (nonionizing radiation) have been used extensively in the disinfection of equipment, glassware, and air by industries for many years [14]. The bactericidal effect of UV light is widely used for sanitation purposes. It is particularly effective in destroying airborne organisms and, consequently, is an important sanitary aid to in-plant installations. It may eliminate detrimental contamination and keep away objectionable invaders. Cerny [6] found that high-intensity UV irradiation may be used in the sterilization of packing materials for aseptic packaging. The penetrating power of UV rays is very low, so that lethal action is confined to organisms on or near the surface of the irradiated materials. Aerial disinfection is severely limited by the presence of dust particles in the atmosphere. Several different UV lamps are available commercially for food industry applications such as processing or disinfection.

### 31.2.2.4 UV Mode of Action

A number of conflicting theories have been proposed with regard to the mode of action of UV light. These include indirect lethal action resulting from the production of hydrogen peroxide, and various chemical and physiochemical changes in the constituents of the cell. The production of hydrogen peroxide is not generally considered to be the mechanism by which UV light induces its effect, although organic peroxides may be involved. It has been suggested that substances of the cell nucleus are involved in the destruction action by UV light. UV wavelengths of 200–290 nm penetrate cell membranes to disrupt DNA molecules, preventing cell replication [4]. Also, degradation of the bacterial cell walls can cause the germicidal effect [2,51].

---

## 31.3 Visible Light Radiation

The germicidal effect of sunlight is largely due to the UV radiation received at the earth's surface. The wavelength is in the range of 290–300 nm. Altitude and latitude, and clarity of the atmosphere affect its effectiveness. Visible light having electromagnetic radiation of wavelengths 400–750 nm is absorbed by relatively few of the compounds present in nonphotosynthetic organisms. Light without being absorbed has little or no effect. This is also true for the longer ultraviolet wavelengths of 300–400 nm. UV radiation with a wavelength less than 300 nm is strongly absorbed by proteins and nucleic acids. Relatively small doses of such radiation can cause chromosome breakage, genetic mutation, inactivation of enzymes, or death [4].

Cool white fluorescent illumination (14.5 W/m<sup>2</sup> for 72 h) of apples at 2°C enhances the fruit's red color without hampering fruit quality and storability potential [42]. Saks et al. [41] studied the Dorit and Ofra cultivars of strawberry by illuminating them to 14.5 and 17.5 W/m<sup>2</sup> in white fluorescent light at 2°C. A 2 h treatment was sufficient to overcome the genetic limitation of white shoulders in Dorit and the poor red color in Ofra. Illumination enhanced both external and internal fruit color, with no effect on quality attributes (freshness of calyx, fruit firmness, and fruit decay) when treated and placed in storage simulating air or sea transport, followed by storage at 18°C. The treatment reduced fruit rot in both cultivars. In fruit inoculated with *Botrytis cinerea*, the most common storage pathogen of strawberry, the appearance of disease symptoms was delayed. Germinated pea seeds showed that red light decreased water uptake by the seeds compared to seeds germinated in darkness [35]. The significant factors influencing this process are the light dose as well as the state of water in the seeds.

Pulsed light kills high levels of all microorganisms exposed to it, including bacteria, fungi, spores, viruses, protozoa, and cysts [10,11]. The white light pulse is generated by electrically ionizing a xenon gas-filled lamp for a few hundred millionths of a second with a high-power, high-voltage pulse. The high-voltage pulse is produced by storing electricity in a high-energy-density capacitor and releasing it in short, high-intensity, high-peak power pulses. The electrical energy used to energize the lamp is converted with high efficiency (>50%) to broadband white light emission. The emitted light flash has wavelengths in the far-UV (200–300 nm), near-UV (300–380 nm), visible (380–780 nm), and infrared (780–1100 nm) regions [11]. Pulsed light treatment of foods has been approved by the FDA. A single pulsed light flash

at 1–2 J/cm<sup>2</sup> killed 6 log cfu of bacterial spores per square centimeter of the inoculated surface. Treatment with a few flashes to total fluences of about 4–6 J/cm<sup>2</sup> killed more than 7–8 log cfu/cm<sup>2</sup> of bacteria or mold spores and more than 9 log cfu/cm<sup>2</sup> of vegetative bacteria. This killing effect is significantly greater than that of conventional UV sources or high-intensity mercury vapor lamps.

MacGregor et al. [30] used a novel pulsed power energization on the survival of bacterial populations of verocytotoxigenic *E. coli* and *Listeria monocytogenes*. They used many megawatts of peak electrical power dissipated in the light source in an extremely short energization time (about 1 μs). In the exposure experiments, predetermined bacterial populations were spread onto the surface of tryptone soya yeast extract agar and then treated to a series of light pulses (spectral range of 200–530 nm) with an exposure time ranging from 1 to 512 μs. Results showed that as few as 64 light pulses of 1 μs duration were required to reduce *E. coli* populations by 99.9% and *Listeria* populations by 99%; the greater the number of light pulses, the larger the reduction in cell numbers. Cell populations of *E. coli* and *Listeria* were reduced by as much as 6 and 7 log orders at the upper exposure level of 512 μs, respectively. Survival data revealed that *E. coli* was less resistant to the lethal effects of radiation. Dunn et al. [10,11] discussed different applications to treat packaging materials, bulk transmissible products, water, air, and surfaces.

---

### 31.4 Photoreactivation

If microorganisms are treated with various dyes (e.g., erythrosin), they may become sensitive to damage by visible light. This effect is known as *photoreactivation*. Some food ingredients could possibly induce the same reaction. Such dyes are said to possess photodynamic action [4]. Spores may occasionally fail to show photoreactivation when inactivated with UV light, whereas the corresponding vegetative cells sometimes show photoreactivation. The simplest explanation of these data is to assume that radiation damages genetic material in the spore and that certain bacteria may produce diploid spores as a result of specific disruptions. Such bacterial spores exhibit two types of radiation inactivation curves: *B. subtilis*, *B. brevis*, and *B. mesentericus* are inactivated in a single-hit fashion whereas *B. megaterium*, *B. cereus*, and *B. mycoides* are affected by a multiple hit. In all these cases there is no effect on spore survival if the postirradiation medium is changed from yeast extract to a purely chemically defined medium [4].

When surface microbial contamination is the major cause of spoilage in the case of selected seafood, the application of intense, short pulses of incoherent, continuous, broad-spectrum light can be used to increase the shelf life. The extension is achieved through two processes: (i) by the destruction of spoilage-causing microorganisms, and (ii) by the inactivation of enzymes. This destruction or inactivation is achieved through a complex photothermal and photochemical mechanism mediated by the use of wavelengths less than 300 nm. The pulsed light waves transfer thermal energy to a thin surface layer without raising the interior temperature of the product [8]. Colby and Flick [8] concluded that increased efficiency is possible by the use of dyes or other chemical compounds that selectively bind to either microorganisms or enzymes, thereby increasing their susceptibility to the pulsed electromagnetic waves.

Photoinduced (light-induced) off-flavors also result from lipid oxidation and protein degradation. Linoleic acid is highly susceptible to photooxidation and can lead to the formation of high levels of hexanal. Cabbage, burnt-protein, and burnt-feather notes are associated with protein degradation. Amino acid degradation is catalyzed by riboflavin photooxidation and results in thiols, sulfides, disulfides, and 3-methylthiopropionamide of riboflavin and oxygen generates methional, which further degrades to methanethiol, dimethyl sulfide, and dimethyl disulfide, all of which contribute to a cabbage- or burnt-feather-type aroma. Maillard reaction heterocyclic intermediates 2-ethylpyrrole, 2-ethylfuran, and 2,4,5-trimethyloxazole decrease in concentration as a result of photooxidation in the presence of chlorophyll [20,48].

---

### References

1. J. Arul, M. T. Charles, J. Mercier, M. Baka, and S. Kalantari, UV hormesis in the preservation of fresh fruits and vegetables: control of postharvest diseases, *Proceedings of the 5th International Food Convention (IFCON)*, December 5–8, Mysore, India, pp. 202–204 (2003).
2. R. Bachman, Sterilization by intense UV radiation, *Brown Boveri Rev.* 62:206 (1975).

3. H. Barkworth, Taints and off-flavors of milk, *Dairy Inds.* 3:367 (1938).
4. G. Borgstrom, *Principles of Food Science*, Macmillan, London (1968).
5. L. Buruiana, Action of sunlight on milk, *Biochem. J.* 31:1452 (1937).
6. G. Cerny, Sterilization of packaging materials for aseptic packagings. 2. Investigation of the germicidal effects of UV-C rays, *Verpackungs-Rundschau* 28:77 (1977).
7. M. R. Coe and Le Clerc, Photochemical action, a cause of rancidity, *Cereal Chem.* 9:519 (1932).
8. J. Colby and G. J. Flick, Shelf life of fish and shellfish, In: *Shelf Life Studies of Foods and Beverages* (G. Charalambous, Ed.), Elsevier Science Publishers B. V., Amsterdam, p. 85 (1993).
9. L. L. Creasy and M. Coffee, Phytoalexin production potential of grape berries, *J. Am. Soc. Hort Sci.* 113:230 (1988).
10. J. Dunn, A. Bushnell, T. Ott, and W. Clarke, Pulsed white light food processing, *Cereal Foods World* 42(7):510–515 (1997).
11. J. Dunn, T. Ott, and W. Clark, Pulsed-light treatment of food and packaging, *Food Technol.* 49(9):95–98 (1995).
12. B. E. Ellickson and V. Hasenzahl, Use of light-screening agent for retarding oxidation of process cheese, *Food Technol.* 12:577 (1958).
13. M. Fiedorowicz, P. Tomasik, S. You, and S. Lim, Molecular distribution and pasting properties of UV-irradiated corn starches, *Starch* 51(4):126–131 (1999).
14. M. L. Fields, *Fundamentals of Food Microbiology*, AVI Publishing, Westport, CT (1978).
15. L. J. Forney and J. A. Pierson, Ultraviolet disinfection, *Resource* 11(1):7–8 (2004).
16. A. Gennadios, J. W. Rhim, A. Handa, C. L. Weller, and M. A. Hanna, Ultraviolet radiation affects physical and molecular properties of soy protein films, *J. Food Sci.* 63(2):225 (1998).
17. G. A. Gonzalez-Aguilar, C. Y. Wang, J. G. Buta, and D. T. Krizek, Use of UV-C irradiation to prevent decay and maintain postharvest quality of ripe 'tommy atkins' mangoes. *Int. J. Food Sci. Technol.* 36:767–773 (2001).
18. W. O. Harrington and C. H. Hills, Reduction of the microbial population of apple cider by ultraviolet irradiation, *Food Technol.* 22:117 (1968).
19. A. Hirsch, *Flexible Food Packaging*, Van Nostrand Reinhold, New York (1991).
20. C. T. Ho, Flavor stability of processed foods. Personal communication. Rutgers University, New Brunswick, NJ (cited by Sukan, 2004) (1997).
21. O. Hoyer, Testing performance and monitoring of UV systems for drinking water disinfection, *Water Supply* 16(1/2):424 (1998).
22. Y. W. Huang and R. Toledo, Effect of high doses of high and low intensity UV irradiation on surface microbiological counts and storage life of fish, *J. Food Sci.* 47:1667 (1982).
23. Y. Iwanami, H. Tateba, N. Kodama, and K. Kishino, Changes of lemon flavor components in an aqueous solution during UV irradiation, *J. Agric. Food Chem.* 45:463 (1997).
24. S. Jiang, S. Leu, and G. Tsai, Cross-linking of mackerel surimi actomyosin by microbial transglutaminase and ultraviolet irradiation, *J. Agric. Food Chem.* 46:5278–5282 (1998).
25. M. Y. Jung, K. H. Lee, and S. Y. Kim, Retinyl palmitate isomers in skim milk during light storage as affected by ascorbic acid, *J. Food Sci.* 63(4):597–600 (1998).
26. G. Kaess and J. F. Weidemann, Effects of ultraviolet irradiation on the growth of micro-organisms on chilled beef slices, *J. Food Technol.* 8:59 (1973).
27. A. Klezkowski, Methods of inactivation by ultraviolet radiation, *Methods in Virol.* 4:93 (1968).
28. T. Koutchma and B. Parisi, Bidosimetry of *Escherichia coli* UV inactivation in model juices with regard to dose distribution in annular UV reactors, *J. Food Sci.* 69(1):14 (2004).
29. I. Y. Lu, C. Stevens, P. Yakubu, and P. A. Loretan, Gamma, electron beam and ultraviolet radiation on control of storage rots and quality of Walla Walla onions, *J. Food Process. Preserv.* 12:53 (1987).
30. S. J. MacGregor, N. J. Rowan, L. McIlvaney, J. G. Anderson, R. A. Fourance, and O. Farish, Light inactivation of food-related pathogenic bacteria using a pulsed power source, *Lett. Appl. Microbiol.* 27:67–70 (1998).
31. W. Maciejewska, G. Hoffmann, and S. Surma, The effect of UV radiation on macrostructure of globular proteins in water environment, In: *Properties of Water in Foods* (P. P. Lewicki, Ed.), Warsaw Agricultural University Press, Warsaw, p. 21 (1998).
32. R. Maharaj, J. Arul, and P. Nadeau, Effect of photochemical treatment in the preservation of fresh tomato (*Lycopersicon esculentum* cv. Capello) by delaying senescence, *Postharvest Biol. Technol.* 15:13–23 (1999).

33. J. Mau, P. Chen, and J. Yang, Ultraviolet irradiation increased vitamin D2 content in edible mushrooms, *J. Agric. Food Chem.* 46:5269–5272 (1998).
34. I. H. Moy, T. McElhandy, and C. Matsuzaki, Combined treatment of UV and gamma radiation of papaya for decay control, *Food Preservation by Irradiation Proceedings at an IAEA, FAO, WHO Symposium*, Wageningen (1977).
35. G. Plenzler, Changes in dynamic of pea seeds sorption under red light treatment, In: *Properties of Water in Foods* (P. P. Lewicki, Ed.), Warsaw Agricultural University Press, Warsaw, p. 73 (1999).
36. K. Polewski, Vacuum ultraviolet circular dichroism study of starch components in aqueous and desolvated samples, In: *Properties of Water in Foods* (P. P. Lewicki, Ed.), Warsaw Agricultural University Press, Warsaw, p. 36 (1999).
37. B. Ranganna, G. S. V. Raghavan, and A. C. Kushalappa, Effect of ultraviolet radiation on control of diseases for short-term storage of potatoes (*Solanum tuberosum* L.), In: *Harvest and Postharvest Technologies for Fresh Fruits and Vegetables* (L. Kushwaha, R. Serwatowski, and R. Brook, Eds.), American Society of Agricultural Engineers, Michigan, p. 293 (1995).
38. J. O. Reagan, G. C. Smith, and Z. L. Carpenter, Use of ultraviolet light for extending the retail caselife of beef, *J. Food Sci.* 38:929 (1973).
39. J. W. Rhim, A. Gennadios, D. Fu, C. L. Weller, and M. A. Hanna, Properties of ultraviolet irradiated protein films, *Food Sci. Technol.* 32:129–133 (1999).
40. V. Rodov, S. Ben-Yehoshua, J. J. Kim, B. Shapiro, and Y. Ittah, Ultraviolet illumination induces scoparone production in kumquand and orange fruit and improves decay resistance, *J. Am. Soc. Hort. Sci.* 117:788 (1992).
41. Y. Saks, A. Copel, and R. Barkai-Golan, Improvement of harvested strawberry quality by illumination: colour and *Botrytis* infection, *Postharvest Biol. Technol.* 8:19 (1996).
42. Y. Saks, L. Sonogo, and R. Ben-Arie, Artificial light enhances red pigmentation, but not ripening, of harvested 'Anna' apples, *HortSci.* 25:547 (1990).
43. I. S. Schneider, H. A. Frank, and C. O. Willits, Maple syrup. XIV. Ultraviolet irradiation effects on the growth of some bacteria and yeasts, *Food Res.* 25:654 (1960).
44. I. Shimoyamada, H. Yoshimura, K. Tomida, and K. Watanabe, Stability of bovin  $\beta$ -lactoglobulin/retinol or retinoic acid complexes against tryptic hydrolysis, heating and light-induced oxidation, *Food Sci. Technol.* 29:763 (1996).
45. J. H. Silliker, R. P. Elliott, A. A. Baird-Parker, F. L. Bryan, J. H. B. Christian, D. S. Clark, J. C. Olson, and T. A. Roberts, *Microbial Ecology of Foods. Volume 1: Factors Affecting Life and Death of Microorganisms*, Academic Press, New York, (1980).
46. V. C. Stebnitz and H. H. Sommer, The oxidation of butterfat. I. The catalytic effect of light, *J. Dairy Sci.* 20:181 (1937).
47. R. A. Stermer, M. Lasater-Smith, and C. F. Brasington, Ultraviolet radiation—An effective bactericide for fresh meat, *J. Food Protect.* 50:108 (1987).
48. M. K. Sukan, Identifying and preventing off-flavors, *Food Technol.* 58(11):36–40 (2004).
49. H. L. Templeton and H. H. Sommer, Wrappers for processed cheese, *J. Dairy Sci.* 20:231 (1937).
50. S. K. Unluturk, H. Arastoopour, and T. Koutchma, Modeling of UV dose distribution in a thin-film UV reactor for processing of apple cider, *J. Food Eng.* 65:125–136 (2004).
51. S. Varga, R. A. Keith, P. Michalik, G. G. Sims, and L. W. Regier, Stability of lean and fatty fish fillets in hypobaric storage, *J. Food Sci.* 6:1487 (1980).



# 32

## *Irradiation Preservation of Foods*

Mohammad Shafiur Rahman

### CONTENTS

32.1	Food Irradiation Process .....	762
32.1.1	Action of Ionization Irradiation .....	762
32.1.2	Sources of Ionization Irradiation .....	762
32.1.3	Dose and Dosimetry.....	762
32.1.4	Scope of Irradiation .....	763
32.1.4.1	Disinfestation .....	763
32.1.4.2	Shelf Life Extension .....	763
32.1.4.3	Decontamination .....	763
32.1.4.4	Product Quality Improvement.....	763
32.1.5	Advantages of Irradiation .....	763
32.1.5.1	Minimize Food Losses .....	763
32.1.5.2	Improve Public Health .....	764
32.1.5.3	Increase International Trade .....	764
32.1.5.4	An Alternative to Fumigation of Food .....	764
32.1.5.5	Increase Energy Saving.....	764
32.2	Effects on Microorganisms and Food Components .....	765
32.2.1	Effects on Microorganisms .....	765
32.2.1.1	Mode of Action .....	765
32.2.1.2	Level of Dose .....	765
32.2.2	Effects of Irradiation on Food Components .....	767
32.2.2.1	Effect on Proteins .....	767
32.2.2.2	Effects on Carbohydrates .....	767
32.2.2.3	Effect on Lipids.....	767
32.2.2.4	Effect on Vitamins.....	768
32.2.2.5	Effects on Enzymes.....	768
32.3	Applications of Irradiation in Foods .....	768
32.3.1	Plant Foods.....	768
32.3.1.1	Spices .....	769
32.3.1.2	Fruits and Vegetables .....	769
32.3.1.3	Cereals and Grains .....	771
32.3.2	Animal Foods.....	771
32.3.2.1	Poultry.....	772
32.3.2.2	Mutton.....	772
32.3.2.3	Beef .....	773
32.3.2.4	Pork .....	773
32.3.2.5	Processed Meats .....	774
32.3.2.6	Fish and Fish Products .....	774
32.4	Technological Problems and Limitations of Irradiation .....	775
32.4.1	Major Problems of Irradiation .....	775
32.4.2	Legal Aspects and Safety Issues .....	776
32.4.3	Consumers' Attitude.....	777
	References .....	777



## 32.1 Food Irradiation Process

The irradiation process involves exposing the food, either prepackaged or in bulk, to a predetermined level of ionization radiation. In this process, it is important to know sources of ionization radiation, how energy is quantified, and its scope with advantages and limitations.

### 32.1.1 Action of Ionization Irradiation

Ionization radiation interacts with an irradiated material and ionizes molecules by creating positive and negative ions by transferring energy in the electrons [87]. The radiation effects on biological materials are direct and indirect. In direct action, the chemical events occur as a result of energy deposition by the radiation on the target molecule, and the indirect effects occur as a consequence of reactive diffusible free radicals formed from the radiolysis of water, such as hydroxyl radical  $\text{OH}^\cdot$ , hydrated electron ( $e_{\text{aq}}^-$ ), H atom, hydrogen peroxide ( $\text{H}_2\text{O}_2$ ), and hydrogen [87]. Hydrogen peroxide is a strong oxidizing agent and a poison to the biological systems, while hydroxyl radical is a strong oxidizing agent and hydrogen radical is a strong reducing agent. These two radicals can cause several changes in the molecular structure of organic matter [34].

### 32.1.2 Sources of Ionization Irradiation

There are two classes of ionizing radiation: electromagnetic and particulate. These are  $\gamma$ -rays from radionuclides  $^{60}\text{Co}$  or  $^{137}\text{Cs}$ , X-rays generated from machine sources operated at or below 5 MeV, and electrons generated from machine sources operated at or below an energy level of 10 MeV [73,87]. The characteristics of different irradiation sources are summarized in Table 32.1. Mitchell [86] mentioned that although both isotopic and machine sources result in identical impacts on foods, consumers would react more favorably to machine sources than isotope sources because of the association of isotopes with the nuclear industry. All these three source types require a large plant for economic viability. Much of the high cost is associated with the need for heavy concrete shielding to protect the external environment when the source is in use. In addition, the plant must comply with the relevant hygiene and safety legislation [57].

### 32.1.3 Dose and Dosimetry

The radiation dose (level of treatment) is defined as the quantity of energy absorbed during exposure [136]. Traditionally, the dose of ionizing radiation absorbed by irradiated material has been measured in terms of *rad*, but recently it has been superseded by *gray* (Gy), which is equal to 100 rad [87]. One Gy represents 1 J of energy absorbed per kilogram of irradiated product and the energy absorbed depends on mass, density, and thickness of food [136].

Food irradiation doses are generally characterized as low (less than 1 kGy), medium (1–10 kGy), and high (greater than 10 kGy). Different levels of dose are required to achieve desired results for the products [136]. The energy level used for food irradiation, to achieve any technological purpose, is normally extremely low, e.g., 0.1 or 1.0 kGy, which would be equivalent to a heat energy of 0.024°C or 0.24°C. The Codex Alimentarius Commission recommended 10 Gy as the

**TABLE 32.1**

Characteristics of Irradiation Sources

Radiation Source	Characteristics
Cobalt-60	<ol style="list-style-type: none"> <li>1. High penetrating power</li> <li>2. Permanent radioactive source</li> <li>3. High efficiency</li> <li>4. Source replenishment needed</li> <li>5. Low throughput</li> </ol>
Electron beams	<ol style="list-style-type: none"> <li>1. Low penetrating power</li> <li>2. Switch on–switch off capability</li> <li>3. High efficiency</li> <li>4. High throughput</li> <li>5. Power and cooling needed</li> <li>6. Technically complex</li> </ol>
X-rays	<ol style="list-style-type: none"> <li>1. High penetrating power</li> <li>2. Switch on–switch off capability</li> <li>3. Low efficiency</li> <li>4. High throughput</li> <li>5. Power and cooling needed</li> <li>6. Technically complex</li> </ol>

Source: D. Kilcast, *Int. Biodeter. Biodegra.* 36:279 (1995).

maximum energy level or dose of ionizing radiation [15]. One Gy is equivalent to 1 J of energy absorbed per kilogram of material [86]. Loaharanu and Murrell [73] calculated on the basis that 10 kGy of ionizing energy is equivalent to a heat energy of 10 J/g and the heat capacity of water is 4.2 J/g °C, i.e.,  $10/4.2 = 2.4^{\circ}\text{C}$ . Thus, it is a cold method of food preservation. The absence of noticeable change and small rise in temperature lead to difficulty in detecting whether food has been irradiated or not [57,86].

#### **32.1.4 Scope of Irradiation**

The potential applications of irradiation are [17,88] disinfestation, shelf-life extension, decontamination, and product quality improvement.

##### **32.1.4.1 Disinfestation**

Disinfestation is one of the important postharvest treatments in food processing, and chemicals are usually used for this purpose. Disinfestation, the control of insects, in fruits can be achieved by doses up to 3 kGy [136]. A low dose of 0.15–0.50 kGy can damage insects at various stages of development that might be present on the food. Irradiation can damage insect's sexual viability or its capability of becoming an adult [88].

##### **32.1.4.2 Shelf Life Extension**

One form of shelf life extension is to inhibit sprouting of potatoes, yams, onions, and garlic at 0.02–0.15 kGy [79]. Another form is to delay the ripening and senescence of some tropical fruits such as bananas, litchis, avocados, papayas, and mangoes at 0.12–0.75 kGy [3]. The irradiation also extends the shelf life of perishable products such as beef, poultry, and seafood by decontamination of spoilage microorganisms. Usually, fruits progressively lose their resistance to phytopathogens with ripening. When a low dose is used to delay ripening, a higher level of resistance is retained in fruits, and microbial development is also delayed as an added benefit [136].

##### **32.1.4.3 Decontamination**

Irradiation can reduce microbial load and destruction of pathogens. One form of decontamination could be the use of a low dose (1.0–2.0 kGy) to pasteurize seafoods, poultry, and beef. Another form could be a higher dose (3.0–20 kGy), such as sterilization of poultry, spices, and seasonings [88].

##### **32.1.4.4 Product Quality Improvement**

A higher juice yield could be obtained if fruits are first irradiated at a dose level of several kGy, thus improving product recovery. Another study showed that the gas-producing factors in soybeans could be markedly decreased with a sequence of soaking, germination, irradiation, and subsequent drying of the beans. This required a dose of 7.5 kGy for maximum effect [43]. It also facilitates reduction of the need for chemicals used in food, such as nitrite, and salts. Moreover, irradiation does not leave any chemical residues in foods [130]. The extent of doses and their purposes are summarized in Table 32.2.

#### **32.1.5 Advantages of Irradiation**

Hasegawa and Moy [43] identified at least three distinct benefits of using irradiation to preserve foods. Five advantages of irradiation are discussed below.

##### **32.1.5.1 Minimize Food Losses**

Radiation disinfestation and shelf-life extension can reduce the food losses of fresh foods. A great deal of the postharvest losses due to insect infestation can be controlled and minimized by irradiating foods such as grains, pulses, tubers, and fruits. Also, shelf life of tubers and some fruits can be extended through sprout inhibition or delayed ripening. Especially in the Third World, irradiation has high potential where in many cases food is spoiled during postharvest stage [43]. A potential added benefit of the application of irradiation to fruits is the increase in juice yield during processing of several commodities [136].

TABLE 32.2

Extent of Dose and Purpose of Food Irradiation

Dose Limit	Purpose	Dose Limit (kGy)	Examples
Low dose (<1 kGy)	Sprouting inhibition	0.05–0.15	Potatoes, onions, garlic
	Insect and parasite disinfection	0.15–0.50	Cereals, pulses, dried fruit, pork
	Delay of ripening	0.50–1.00	Fresh fruits and vegetables
Medium dose (1–10 kGy)	Reduction of spoilage microorganisms	1.0–3.0	Fish, strawberries
	Reduction of nonspore pathogens	2.0–7.0	Poultry, shellfish
	Microbial reduction in dry products	7.0–10.0	Herbs, spices
High dose (10–50 kGy)	Sterilization	25–50	Sterile diet meals
Very high dose (10–100 kGy)	Reduces or eliminates virus contamination	10–100	

Source: P. Kurstadt and F. Fraser, *Food Irradiation Technology Overview*, Nordion International, 1994; WHO, Wholesomeness of Irradiated Food: Summaries of Data considered by the Joint FAO/IAEA/WHO Expert Committee on the Wholesomeness of Irradiated Food, EHE/81.24, Geneva, Switzerland, 1980.

### 32.1.5.2 Improve Public Health

Foods, especially muscle foods, are contaminated with pathogenic microorganisms or parasites. The decontamination of these fresh foods by irradiation can improve public health concern. *Salmonella* is a prime source of foodborne illness from poultry products. The use of irradiation up to 3.0 kGy to decontaminate poultry, and up to 1.0 kGy to control *Trichinella spiralis* in pork carcasses is approved in the United States [88]. Irradiation is also a method to ensure hygienic quality of solid food [71].

### 32.1.5.3 Increase International Trade

Many fresh foods are not candidates or are disqualified for international trade due to (i) infestation by insects, (ii) infection by microorganisms, and (iii) their limited shelf life, which restricts long-distance shipments. Irradiation can increase or improve the trade of fresh foods over international markets by providing an effective quarantine procedure for infested or infected foods, or help to prolong the shelf life [71,88].

### 32.1.5.4 An Alternative to Fumigation of Food

Various chemicals, such as ethylene dibromide, methyl bromide, and ethylene oxide, are used for fumigation of food and food ingredients. The use of chemical disinfestation treatments is rapidly diminishing due to their toxic nature and environmental impact, e.g., the toxic nature of ethylene oxide and the ozone-depleting effect of fumigant ethylene dibromide [57,71]. Low-dose irradiation of 0.2–0.7 kGy can control insect infestation of grain and other stored products [71].

### 32.1.5.5 Increase Energy Saving

The energy used for irradiation of food is small compared to canning, refrigeration, or frozen storage. The total energy used for refrigerated raw cut-up chicken is 17,760 kJ/kg, for frozen chicken 46,600 kJ/kg (3–5 weeks frozen storage), and for canned chicken meat 20,180 kJ/kg. In comparison, refrigerated and irradiated raw cut-up chicken requires a total of 17,860 kJ/kg [12]. Moreover, ban on CFC refrigerants could result in higher cost of refrigerated food in the future, thus a combination of irradiation and chilling has high potential in energy saving during food processing [71]. The reduction of energy requirements can also contribute toward overall reduction of the pollution caused by combustion products of traditional fuels [130].

## 32.2 Effects on Microorganisms and Food Components

### 32.2.1 Effects on Microorganisms

Similar to other preservation methods, irradiation affects microbial growth and changes the food components. Ionization irradiation affects microorganisms, such as bacteria, yeasts, and molds, by causing lesions in the genetic material of the cell, effectively preventing it from carrying out the biological processes necessary for its continued existence [90]. Stability of food components also needs to be known for determining its functionality and safety.

#### 32.2.1.1 Mode of Action

The principal targets of irradiation are nucleic acids and membrane lipids. Alteration in membrane lipids, particularly polyunsaturated lipids, leads to perturbation of membranes and deleterious effects on various membrane functions, such as permeability. The activity of membrane enzymes may be affected as a secondary effect of membrane lipid degradation [136]. Ionization radiations act through changes induced in the DNA structure of the irradiated cells, which result in prevention of replication or other functions [73]. The energy levels used are sufficient to disrupt certain bonds in the molecules of DNA, thereby making cell reproduction impossible [86]. Nucleic acids, because of their large size, are the main targets of free radicals generated by irradiation [136]. Chromosomes of bacteria are intrinsically very sensitive and lethal damage occurs as a result of exposure to irradiation. The ability of bacteria to repair a limited amount of such damage gives them considerably greater resistance to such radiations. The efficiency with which different bacteria repair the radiation-induced damage to their DNA varies considerably. The most sensitive vegetative bacteria is *Pseudomonas*, and the most resistant one is *Deinococcus* by a factor of about 100 [87].

#### 32.2.1.2 Level of Dose

Murano [90] reviewed the factors that affect the susceptibility of microorganisms to irradiation, and these are (i) dose level, (ii) temperature, (iii) atmosphere (presence or absence of oxygen), (iv) medium, and (v) type of organism (size, the smaller the target organism, the more resistant it is to ionization radiation; cell wall characteristics and Gram positive or Gram negative in nature; and number and relative age of the cells). In general, the higher the dose applied, the lower the number of survivors and the lower the temperature and the rate of reactions, such as the formation of radicals from water molecules. These radicals can affect indirectly by interfering with normal cellular functions such as membrane transport. Table 32.3 shows that minimal doses can achieve significant gains in food safety. If the product is frozen, radical formation is practically inhibited [90]. An increase in the *D* value was observed from 0.16 kGy at 5°C to 0.32 kGy at -30°C when *Campylobacter jejuni* was inoculated into ground beef [64]. In general, bacteria become more resistant to ionization radiation in the frozen state as well as in the dry state. In both states, it is assumed that the contribution of indirect effects from the radiolysis of water is significantly reduced [87]. Off-flavor development in products irradiated in a dry state is less than that of moist products. This is due to the low formation of free radicals at reduced moisture content [34]. Irradiation atmosphere may have an effect, but this may only occur under specific conditions [90]. The composition of the irradiating medium will affect the survival of microorganisms to irradiation. As a rule, the simpler the life form, the more resistant it is to the effects of irradiation. For instance, viruses are more resistant than bacteria, which are more resistant than molds, which in turn are more resistant than humans. Also, within bacteria, some genera are found to be more resistant than others [90]. Bacterial spores are more resistant than their corresponding vegetative cells by a factor of about 5–15 [137].

The effectiveness of irradiation to control infectivity of foodborne parasites is summarized in Table 32.3 from Ref. [73]. Low-dose irradiation (below 1 kGy) offers a unique opportunity for controlling the infectivity of a number of foodborne parasites without changing the character of the food. Among the groups of foodborne parasites, trematodes appear to be the most sensitive to irradiation, followed by cestodes and protozoa [73]. The *D* values of various foodborne pathogens in fresh meat are given in Table 32.4.

TABLE 32.3

Effect of Irradiation on Foodborne Parasites

Parasite	Minimum Effective Dose (kGy)	Effect of Irradiation
Protozoa		
<i>Toxoplasma gondii</i>	0.09–0.7	Parasite killed or elimination of infectivity
<i>Entamoeba histolytica</i>	0.251	Killed cyst stage
Trematodes		
<i>Fasciola hepatica</i>	0.03	Inhibits maturation
<i>Clonorchis sinensis</i>	0.15–0.20	Inhibits maturation
<i>Opisthorchis viverrini</i>	0.10	Inhibits maturation
<i>Paragonimus westermani</i>	0.10	Inhibits maturation
Cestodes		
<i>Taenia</i>	>3.00	Complete inactivation of larvae
	0.40	Prevents development in humans
	0.30	Elimination of infectivity
<i>Taenia solium</i>	0.20–0.70	Elimination of infectivity
<i>Echinococcus granulosus</i>	0.50	Elimination of infectivity
Nematodes		
<i>Trichinella spiralis</i>	0.10–0.66	Elimination of infectivity
	0.11	Sterilization of females
<i>Angiostrongylus cantonesis</i>	2.00–4.00	Decreased infectivity
<i>Gnathostoma spinigirum</i>	7.00	Reduced larval penetration
<i>Anisakis</i> species	6.00	Reduced larval penetration

Source: P. Loaharanu and D. Murrell, *Trends Food Sci. Nutri.* 5:190 (1994).

TABLE 32.4

Susceptibility of Various Foodborne Pathogens to Irradiation in Fresh Meat

Organism	T (°C)	Product	D <sub>10</sub> Value (kGy)
<i>Listeria</i>	–	Meat	0.40–0.60
<i>Salmonella</i>	–		0.40–0.50
<i>Escherichia coli</i> O157:H7	–		0.25–0.35
<i>Campylobacter</i>	–		0.14–0.32
<i>Yersinia</i>	–		0.14–0.21
<i>Aeromonas</i>	–		0.14–0.19
<i>Staphylococcus aureus</i>	5	Turkey breast meat	0.45
<i>Campylobacter jejuni</i>	30	Ground turkey	0.16
	5		0.19
	–30		0.29
<i>Salmonella heidelberg</i>	0	Poultry (air packed)	0.24
	0	Poultry (vacuum packed)	0.39
<i>Salmonella enteritidis</i>	5	Egg powder	0.60
	3	Ground beef	0.55–0.78
<i>Salmonella</i> spp.	5	Turkey breast meat	0.71
<i>Listeria monocytogenes</i>	5	Beef	0.45
<i>Escherichia coli</i> O157:H7	5	Ground beef patties	0.27–0.38

Source: T. Radomyski, E.A. Murano, and D.G. Olson, *J. Food Prot.* 57:73 (1994); J.S. Smith and S. Pillai, *Food Technol.* 58(11):48 (2004).

## 32.2.2 Effects of Irradiation on Food Components

In addition to microbial growth, the effects of irradiation on other nutritional components need to be identified before using the technology. The effects of irradiation on nutritional qualities of foods are reviewed by Graham [34].

### 32.2.2.1 Effect on Proteins

Low doses of irradiation may cause molecular uncoiling, coagulation, unfolding, and even molecular cleavage and splitting of amino acids. Apparently, peptide linkages were not attacked and the main effects were concentrated around sulfur linkages and hydrogen bonds [34]. The sequence of protein bonds attacked by ionizing radiation was as follows:  $-S-CH_3$ ,  $-SH$ , imidazole, indole, alpha amino, peptide, and proline [22]. At 10 kGy radiation, overall increase in total free amino acids was observed mainly due to the rise in the levels of glycine, valine, methionine, lysine, isoleucine, leucine, tyrosine, and phenylalanine [34]. Irradiation is thought to bring about unfolding of the protein molecule, leading to the availability of more reaction sites [34].

Irradiation also affects the functional properties of proteins. In case of egg, the doses required for effective *Salmonella* reduction give undesirable side effects, such as loss of viscosity in the white and off-flavors in the yolk [57]. An egg irradiated with 6 kGy showed a thin watery condition, which may be due to the destruction or alteration of ovomucin, the main thickening compound of egg albumin. The casein in milk resulted in an increase in rennet coagulation time and reduced heat stability [34].

The off-flavor development at high doses is due to the presence of benzene, phenols, and sulfur compounds formed from phenylalanine, tyrosine, and methionine, respectively. Flavor changes and off-flavors resembling the burnt flavor were observed in irradiated milk [34]. Irradiation of cheese usually produces smoky off-flavors. Irradiation of soft cheese at a dose of 1–2 kGy is sufficient to reduce food pathogens and does not impair flavor quality; thus, careful dose application is certainly the key for the off-flavor components [57].

### 32.2.2.2 Effects on Carbohydrates

Irradiation can break high-molecular-weight carbohydrates into smaller units leading to depolymerization. This process is responsible for the softening of fruits and vegetables through breakdown of cell wall materials, such as pectin. However, softening may have advantages or disadvantages depending on the requirement. For example, it may be advantageous in reducing juice yield and in reducing the drying and cooking times of dehydrated products [57]. Sugars may be hydrolyzed or oxidized when subjected to gamma irradiation [136]. The irradiation of wheat at 0.2–10 kGy increased the initial levels of water-soluble reducing sugars by 5%–92% compared to untreated samples [109]. Such overall increase in initial total reducing sugars resulted from the stepwise and random degradation of starch. These changes are highly advantageous in the generation of bread flavor and aroma by reducing sugar–amino acids reactions [34]. Irradiation of pure carbohydrates produced degradation products, which have mutagenic and cytotoxic effects. However, these undesirable effects were produced using very high dose of irradiation [34].

### 32.2.2.3 Effect on Lipids

Irradiation initiates the normal process of autoxidation of fats which gives rise to rancid off-flavors. Highly unsaturated fats are more readily oxidized than less unsaturated fats. This process can be slowed by the elimination of oxygen by vacuum or modified atmosphere [57]. In lipids, particularly unsaturated fatty acids, radiolytic decomposition is via a preferential break at the level of the carbonyl function of the double bond [40]. This decomposition induces the formation of some volatile compounds responsible for off-odors [81]. The formation of peroxides and volatile compounds, and the development of rancidity and off-flavors have been reported [82,93]. The peroxide formed can also affect certain labile vitamins, such as vitamins E and K [34].

The lipids in cereals degraded only at high doses of irradiation and no significant effects on iodine value, acidity, or color intensity of wheat flour lipids were observed. At 10 kGy, 20% increase in total

free lipids and 46% decrease in bound lipids were observed [110]. Lipid–protein complexes, critical in baking, were not noticeably affected at low doses up to 2 kGy. The volatile oil content of spices has a dose-dependent reduction effect in black pepper [126] and ginger [98] above 6 kGy. Similar reduction was also observed in case of Ashanti pepper berries when 47 essential oil compounds were analyzed individually at a dose of 10 kGy [99].

#### **32.2.2.4 Effect on Vitamins**

The extent of vitamin C, E, and K destruction depends on the dosage used, and thiamine is very labile to irradiation. The losses are low with low dose. Ascorbic acid in solution is quite labile to irradiation but in fruits and vegetables seems quite stable at low doses of treatment [34]. Vitamins particularly those with antioxidant activity, such as A, B<sub>12</sub>, C, E, K, and thiamine, are degraded when irradiation is carried out in the presence of oxygen [136].

Irradiation can also partially damage vitamins C and B<sub>1</sub>. Kilcast [57] mentioned that the literature referring to vitamin loss is misleading in many cases. Vitamin losses are often quoted at unrealistically high irradiation doses or under unrealistic conditions. In particular, vitamin C loss is often equated with ascorbic acid loss, ignoring the fact that irradiation converts ascorbic acid into dehydroascorbic acid, which is also active as a vitamin [57,136].

#### **32.2.2.5 Effects on Enzymes**

Enzymes in foods must be inactivated prior to irradiation because it is much more resistant to radiation than microorganisms. Usually, enzyme inactivation is accomplished thermally. Generally, it may be said that complete inactivation of enzymes requires about 5–10 times the dose required for the destruction of microorganisms [34]. The *D* values of enzyme can be 50 kGy and almost four *D* values would be required for complete destruction [22]. Thus, irradiated foods will be unstable during storage due to their susceptibility to enzymatic attack than nonirradiated foods [34]. High resistance of enzymes to irradiation has been demonstrated with milk phosphatase, which was not destroyed by irradiation doses sufficient to sterilize milk [105]. Enzymes are affected by the indirect effects of free radicals formed in solvent phase. Thus, dilute solutions of enzymes are relatively more sensitive to irradiation than are concentrated solutions. Moreover, enzymes in their natural environments, as in foods, are relatively very resistant [34]. The activity of enzymes is unaffected at normal doses, and thus it limits the achievable shelf-life extension of fruits and vegetables [57].

---

## **32.3 Applications of Irradiation in Foods**

### **32.3.1 Plant Foods**

Plant tissues showed a transient increase in respiration and ethylene production even at low doses. The rate of respiration increased linearly with increasing dose of irradiation. The transient rate of respiration reverted to preirradiated levels within 24 h for 0.3 kGy, but slower with an increasing dose. Ethylene production also increased after irradiation and it reached a maximum at 1 kGy. It has been suggested that irradiation beyond 1 kGy caused membrane damage, since ethylene production is membrane associated [136]. A shift from glycolysis toward the pentose phosphate shunt in bananas and toward the glyoxylate cycle in bananas and mangoes was observed [125]. At higher doses, climacteric fruits may not ripen normally and may develop uneven coloring and skin discoloration [136]. Fruits suffer physiological disorders when exposed to radiation beyond their limits of tolerance. These undesirable symptoms are mainly tissue softening and enzymatic browning [53]. Tissue softening is caused by (i) partial depolymerization of cell wall polysaccharides, mainly cellulose and pectins [19] and (ii) damage to cell membrane [132]. Enzymatic browning is an indication of cell decompartmentation due to damage of membranes, thus bringing phenolic substrates in contact with polyphenoloxidases [120]. The damage to the cell membrane may result in (i) loss of intracellular water, (ii) cell turgescence, and (iii) oxidative attack on polyunsaturated fatty acids of membrane lipids [136]. The oxidation can be minimized by irradiating in an atmosphere with reduced oxygen content, but treatment efficiency is reduced. Voisine et al.

TABLE 32.5

Response of 23 Fruits to Irradiation

Effect	Results	Materials
Beneficial	Ripening delayed	Bananas, mangoes, papayas
	Senescence delayed	Sweet cherries, apricots, papayas
	Storage decay controlled	Tomatoes, strawberries, figs
Not beneficial	Lack of tolerance	Pears, avocados, lemons, grapefruits, oranges, tangerines, cucumbers, summer squash, bellpeppers, olives, plums, apples, table grapes, cantaloupes
	Ripening accelerated	Peaches, nectarines
	Irradiation tolerance only	Pineapples, litchis, honey dew melons

Source: E.K. Akamine and J.H. Moy, *Preservation of Food by Ionizing Radiation*. Vol. III. (E.S. Josephson and M.S. Peterson, eds.), CRC Press, Boca Raton, 1983.

[131] mentioned that a high carbon dioxide atmosphere was shown to protect tissues from irradiation-induced loss of membrane proteins. Thus, low-dose irradiation combined with modified atmosphere is increasingly considered for control of microorganisms and delayed ripening. Couture and Willemot [16] showed the synergistic action of irradiation combined with high carbon dioxide for control of mold development on strawberries. A decay incidence of *Rhizopus stolonifer* and *Botrytis cinerea* on strawberries packaged under 7% oxygen and 20% carbon dioxide and irradiated at 1 kGy was reported [11]. Table 32.5 shows the response of a number of fruits to irradiation. The applications of irradiation in specific plant materials are discussed below.

### 32.3.1.1 Spices

There is an increasingly important use of irradiation for decontamination of spices. Spices imported into Western Europe are often heavily contaminated by pathogenic microorganisms as a consequence of open air drying procedures [57]. The prevalent microorganisms of pepper are *Clostridium*, *Staphylococcus*, *Bacillus*, *Aspergillus*, and *Fusarium* species. A dose of 2.5 kGy reduced the fungal and bacterial load by 2 log cycles, and 7.5 kGy eliminated the fungal population of ground or whole pepper.

Yang et al. [140] found that the treatment of garlic bulbs with 0.15 kGy can inhibit sprouting and reduce weight losses during storage. The irradiation affects the flavor compounds of garlic. Kwon and Yoon [61] reported that the content of diallyl disulfide in garlic was slightly reduced with an irradiation of 0.05–0.10 kGy. No difference was observed in the contents of diallyl disulfide upon comparison of 0.05-kGy-irradiated bulbs with unirradiated bulbs during storage [13]. The irradiated bulbs showed no difference in odor during storage when compared with untreated bulbs [18]. Wu et al. [139] evaluated the effects of 0.15 kGy on the content of volatile compounds in garlic bulbs during storage at room temperature. The content of diallyl disulfide decreased immediately after irradiation. At the end of 8 months of storage, both irradiated and untreated samples showed a significant increase in diallyl disulfide. Wu and Yang [138] studied the effect of 0.05 kGy irradiation on the volatile compounds of ginger rhizome. The quantities of some major volatiles were significantly decreased in irradiated rhizome after 3 months of storage.

### 32.3.1.2 Fruits and Vegetables

#### 32.3.1.2.1 Berries

The postharvest shelf life of cherries, blueberries, and cranberries can be extended with low dose of irradiation [24]. Blueberries irradiated at 0.25, 0.5, 0.75, or 1.0 kGy can be stored at 1°C for 1, 3, 7 days, respectively, and 2 additional days at 15°C [83]. The firmness of Sharpblue berries was slightly affected by the dose, but firmness of Climax berries was not affected by irradiation. Flavor and texture were negatively affected as dose increased for berries of both cultivars. Weight loss, decay, peel color, total soluble



solids, and titratable acidity were not affected by dosage. Irradiation at or below 0.75 kGy was determined not to be detrimental to the postharvest quality. This treatment can be an effective alternative quarantine treatment to methyl bromide [83].

#### 32.3.1.2.2 *Mangoes*

Mango preservation would greatly benefit from the irradiation treatment. The effects of irradiation depend on the degree of maturity [136]. The optimal dose was 0.75 kGy for three-quarter ripe fruits at room temperature [3]. Combined with a mild heat treatment by hot water dip or vapor for 5 min at 55°C yielded even better results [6]. Surface scalding is a limiting factor, since at 0.25 kGy, scalding occurred on the mature green fruits, and tolerance increased with maturity [3].

#### 32.3.1.2.3 *Carrots*

Doses up to about 0.1 kGy had little effect on firmness of apples, carrots, and beets, but rapid softening occurred at higher doses [10,56]. The effective range for control of rotting and sprouting is 0.1–1 kGy, which means substantial softening can occur [9]. Bourne [9] studied the kinetics of softening in carrots up to doses ranging from 0 to 50 kGy. Two distinct regions were observed: a steep negative slope for doses up to 15 kGy and a shallow negative slope beyond 15 kGy. The two-stage softening rate curve is qualitatively similar to that of thermal softening for carrots.

#### 32.3.1.2.4 *Papaya*

Papaya can tolerate up to 1 kGy  $\gamma$ -radiation before surface scald occurs. The surface color development is not disrupted up to 2 kGy, flavor and aroma up to 4 kGy, and tissue breakdown up to 5 kGy [1,3]. A dose of 0.75 kGy was considered the optimum dose for retention of fruit firmness with only slight reduction of storage decay [1]. A hot water dip at 48.9°C for 20 min in combination delayed ripening with optimum dose of 0.75 kGy [3,6]. Hot water dip alone accelerated ripening, while irradiation alone provided only slight control of decay, and hot water dip was preferable to vapor heat treatment [136]. The respiratory activity was initially elevated immediately after irradiation and then returned to the level of untreated fruit within 24 h [2]. Paull [102] studied the effect of 0.25 kGy irradiation on papaya and found that the irradiated fruit softened more uniformly than the nonirradiated one.

Zhao et al. [144] found irradiation had no effect on the skin and flesh color development of ripening papaya. Irradiation induced immediate depolymerization and demethoxylation of papaya pectic substances indicated by an increase in water-soluble pectin, and decrease in chelator-soluble and alkali-soluble pectin with a significant decline in methanol content. The linear decrease in firmness up to 1.5 kGy was parallel to the change of pectin fractions. Pectin methylesterase was not affected either immediately after irradiation or during ripening, at doses up to 1.5 kGy.

#### 32.3.1.2.5 *Strawberries*

Irradiation at doses of 1, 2, and 3 kGy effectively prolonged the shelf life of strawberries stored at 4°C by 5, 13, and 16 days, respectively [127]. Maxie and Abdel-Kader [80] indicated that strawberries might tolerate an irradiation dose up to 2 kGy for reducing fungal infection without quality changes. The softening of strawberries occurred after irradiation [52,125,143]. The softer texture above 2 kGy may limit use of higher doses. The firmness of strawberries decreased as irradiation doses increased to 0.5, 1, and 2 kGy [141,142]. Success depends on the cultivar: the firmer fruits of “Tioga” tolerated radiation better than the softer fruits of “Brighton” [6]. Several studies indicated that irradiation-induced texture change was associated with changes in pectic substances [47,56,119]. Water-soluble pectin increased and oxalate-soluble pectin decreased in 0 and 1 day after 1 and 2 kGy irradiation, respectively. Fruit firmness correlated with oxalate-soluble pectin content. Total pectin and nonextractable pectin were not affected by irradiation. The oxalate-soluble pectin content and firmness of irradiated strawberries increased slightly at the beginning of 2°C storage and then decreased as storage time increased [142]. Irradiation enhanced sweetness of strawberries by reducing titratable acidity in comparison with untreated sample [74]. The depolymerization of carbohydrate polymers, such as starch and cellulose, may slightly increase the sugar content [19].

### 32.3.1.3 Cereals and Grains

Grains and cereals are treated with low doses of irradiation to eliminate fungi, since some of these organisms can produce mycotoxins [34]. Irradiation doses in the range of 0.2–1.0 kGy are effective in controlling insect infestation in cereals [50]. Increasing the dose to 5 kGy totally kills the spores of many fungi, which survive lower doses [92]. In addition to its protective role from insects and microorganisms, irradiation also affects various quality criteria of cereal grains [59]. The amylograph peak viscosity and falling number values of flour decreased with the increasing irradiation dose [76,95]. Rao et al. [108] also found that amylograph peak height and dough stability decreased with increasing dose. At 10kGy, loaf volume and crumb grain were impaired. The overall bread quality of wheat was greatly reduced at medium dose of irradiation of 1–10 kGy [100]. Lai et al. [63] found that loaf volume and baking quality deteriorated above 5 kGy irradiation irrespective of the baking formula.

Increased cooking losses and inferior scores in sensory characteristics were observed in Japanese noodles when wheat was irradiated in the range of 0.2–1.0 kGy [112,129]. Koksel et al. [59] studied the effects of irradiation up to 5.0 kGy on durum wheat and semolina properties and spaghetti cooking quality. The falling number and sedimentation values of wheat meals decreased with increasing dose levels. This indicated the alterations in both starch and gluten components. Irradiation also caused important changes in the cooking properties of spaghetti. Total organic matter and solid substance loss values of both cultivars increased with irradiation. Koksel et al. [59] mentioned that irradiation might be useful at 1kGy dose for the treatment of grain for insect control without adversely affecting the grain quality. Above 1kGy dose, irradiated samples exhibited lower scores for stickiness, firmness, and bulkiness compared to unirradiated samples due to the deterioration in both starch and gluten. Cowpeas can be preserved in polyethylene bags (100 mm) after ionizing treatment at doses less than 0.10 kGy without causing unfavorable nutritional consequences [23].

### 32.3.2 Animal Foods

In 1997, the FDA approved the use of ionizing radiation to inactivate pathogenic bacteria in red meat [118]. The irradiation is effective in preventing or delaying the microbial spoilage of fresh meats and poultry. Early studies [67] indicated that irradiation at doses between 0.25 and 1kGy under aerobic conditions increased microbiological shelf life, but accelerated rancidity. A tallowy odor and flavor developed during storage. The fat was noticeably bleached and peroxide accumulated more rapidly in the irradiated sample than in the control fat. In case of meats, doses up to 2.5 kGy control *Salmonella*, *Campylobacter*, *Listeria monocytogenes*, *Streptococcus faecalis*, *Staphylococcus aureus*, and *Escherichia coli* in poultry and other meats. The doses in excess of 2.5 kGy may change flavor, odor, and color, but these changes can be minimized by irradiating at low temperature or in absence of oxygen [86].

Irradiation treatment is not effective to stop the changes in meats, which adversely affect consumer acceptance, such as oxidation of pigment to yield brown or gray discolorations by atmospheric oxygen, drip loss from the cut surface of lean, and oxidation of meat lipids that causes off-flavors by atmospheric oxygen [86]. Thus, irradiation coupled with vacuum packaging has the potential to extend the shelf life [86]. Table 32.6 shows the threshold dose for an identifiable irradiation flavor in meats.

**TABLE 32.6**

Threshold Dose for an Identifiable Irradiated Flavor for Meats

Meat	Temperature (°C)	Threshold (kGy)	Reference
Pork	5–10	1.75	[121]
Beef	5–10	2.50	[121]
Chicken	5–10	2.50	[121]
Lamb	5–10	6.25	[121]
	–	2.40	[21]

Hydrogen is generated during irradiation of frozen meats and is a promising marker for distinguishing irradiated from unirradiated frozen food [46]. Poultry meat in particular is known to be susceptible to color changes following irradiation [42]. A pink color is produced in fresh poultry when it is treated with irradiation [8]. Irradiated chicken breasts were found to exhibit increased redness (*a* values) when compared with the unirradiated controls [84].

### 32.3.2.1 Poultry

At a low dose, all microorganisms are not destroyed and survivors such as *Moraxella*, *Acinetobacter*, *Lactobacillus*, and *Streptococcus* can cause spoilage [103]. A mixed microflora to a predominant Gram-positive microflora usually exists during the postirradiation stage [89]. Doses of 2–2.5 kGy are effective in controlling *Listeria* [48,70] and a dose of 1.0–2.5 kGy is adequate to eliminate *Pseudomonas aeruginosa*, and 2.5–5.0 kGy for elimination of *Serratia marcescens* [41]. A dose of 1.50 kGy was effective for *Staphylococcus aureus* in deboned chicken when irradiated in vacuum at 0°C and held at 35°C for 20 h [122,123]. In case of *Escherichia coli* in deboned chicken meat, a 90% decrease of viable cells could be achieved by doses of 0.27 kGy at 5°C and 0.42 kGy at –5°C [124].

In the Netherlands, a maximum dose of 3 kGy is permitted on an unconditional basis in case of poultry irradiation [55] and in Israel and South Africa, a dose of 7 kGy is allowed to eliminate pathogenic bacteria [107]. Mulder [89] recommended a dose of 2.5–5 kGy dose since this can extend shelf life at chill temperatures from 6 to 14 days without insignificant organoleptic quality change. However, doses as low as 0.5 kGy can induce a radiation odor and a 2.5 kGy can induce flavor changes, which may be removed on subsequent cooking [41,89]. Table 32.7 shows the changes in odor of irradiated chicken carcasses during storage at 1.6°C.

The color of meat depends on three factors: concentration of heme pigments, the chemical state of these pigments, and the physical light-scattering properties of the meat structure [77]. Patterson [103] studied the sensitivity of irradiation under air, carbon dioxide, vacuum, and nitrogen on seven bacterial species inoculated onto sterile poultry meat. *Streptococcus faecalis* and *Staphylococcus aureus* were not sensitive to the atmosphere, and others like *Pseudomonas putida*, *Salmonella typhimurium*, *Escherichia coli*, *Moraxella phenylpyruvica*, and *Lactobacillus* were more sensitive in atmospheres other than air. In general, a vacuum or carbon dioxide atmosphere during irradiation had the most lethal effect and bacteria may be more resistant to irradiation if packaged under nitrogen than carbon dioxide or air [86,103].

### 32.3.2.2 Mutton

Irradiation of vacuum-packaged mutton backstraps at 4 kGy prevented the growth of bacteria for at least 8 weeks at 0°C–1°C [78], while *Brocothrix thermosphacta* and Gram-negative bacteria grew on telescoped lamb carcasses irradiated at 2.4 kGy and stored at 5°C. The total population did not exceed 10<sup>5</sup> cfu/cm<sup>2</sup> during 16 weeks of storage [7]. However, at these high doses adverse effects on sensory

TABLE 32.7

Changes in Odor of Irradiated and Unirradiated Chicken Carcasses Stored at 1.6°C

Storage Time (Days)	Unirradiated	Irradiated	
		2.5 kGy	5.0 kGy
0	Fresh chicken	Slight irradiation odor	Irradiation odor
4	Fresh chicken	Fresh chicken odor	Slight irradiation odor
8	No odor	Fresh chicken odor	Fresh chicken odor
11	Slight off-odor	Chicken odor	Chicken odor
15	Putrid	Slight chicken odor	Slight chicken odor
18	Putrid	Stale chicken odor	Slight chicken odor
22	Putrid	Stale chicken odor	Slight chicken odor
31	Putrid	Stale chicken (sour)	Slight chicken odor

Source: R.S. Kahan and J.J. Howker, *Food Preservation by Irradiation*, Vol. II, Proceedings of Symposium, Wageningen, 1977, p. 221.

attributes and increased volume of weep released were observed. Meat chunks irradiated at 1.0 and 2.5 kGy were acceptable for 3 and 5 weeks, respectively, whereas for minced meat it was 2 and 4 weeks [101]. In contrast, unirradiated meat chunks and mince spoiled within 1 week of storage at 0°C–3°C [86].

### 32.3.2.3 Beef

*Pseudomonas*, Enterobacteriaceae, and *Brocothrix thermosphacta* were strongly inhibited in irradiated samples of beef meat and sensory properties were not altered [86]. Rodriguez et al. [111] studied the effect of 2 kGy irradiation on fresh top round beef, packed aerobically in polyethylene film. Psychrotroph counts on the untreated samples reached  $10^7$  cfu/cm<sup>2</sup> after storage between 8 and 11 days, while similar counts were not observed in irradiated samples until 28 days of storage. The shelf life of vacuum packaged raw meat can be extended considerably with doses ranging from 1 to 5 kGy, which also yielded satisfactory sensory quality [20,25]. Grant et al. [37] studied the effect of 2 kGy irradiation on growth and toxin production of *Staphylococcus aureus* and *Bacillus cereus* inoculated on roast beef. Irradiation resulted in a 3–4 log reduction in numbers of both pathogens. Toxin production by both pathogens was also delayed by irradiation. Roast beef and gravy samples irradiated at 2 kGy dose and stored at 5°C and 10°C showed similar growth rates in case of *Listeria monocytogenes*, while a lag period of 6–9 and 2–4 days, respectively, was observed compared to 1–2 days and less than 0.1 day in nonirradiated samples [38].

Postmortem aging of beef is typically done by holding carcasses or cuts between –1°C and 4°C for up to 3 weeks. During that time, tenderness improves and a distinctive flavor develops. Snyder [116] suggested that carcass aging at high temperature followed by irradiation could reduce microbial numbers. Lee et al. [69] found that irradiation in conjunction with MAP containing 25% carbon dioxide and 75% nitrogen could be used for an accelerated aging process of beef at 30°C for 2 days. Their result was based on tenderness, chemical, visual, and microbiological effects. Moreover, if irradiated beef were chilled immediately after aging, this process could improve tenderness without excessive microbial growth and would be more efficient than aging carcasses at high temperatures followed by irradiation [69]. The summary of findings by Sommers [118] is: (i) irradiation can inactivate pathogenic bacteria occasionally found in ground beef, such as *Escherichia coli* O157:H7, *Salmonella*, *Staphylococcus aureus*, and *Listeria monocytogenes*, (ii) irradiation does not make food radioactive, (iii) irradiation, when used appropriately, does not change the aroma, taste, aftertaste, texture, or overall liking of ground beef, including frozen ground beef supplied as part of the National School Lunch Program, (iv) there is no detectable increase in the risk of cancer associated with long-term consumption of radiation-pasteurized meat as determined by multi-species, multigeneration feeding studies conducted in animals, (v) irradiated ground beef is nutritious and wholesome, and (vi) irradiation is only effective as part of a comprehensive program designed to improve the microbiological safety of ground beef, not to clean up unacceptable product.

### 32.3.2.4 Pork

Sivinski and Switzer [115] mentioned that a low-dose irradiation treatment between 0.30 and 1.0 kGy might be used to inactivate the parasite *Trichinella spiralis* in pork. The effect of 1 kGy irradiation on vacuum-packaged pork stored up to 21 days at 4°C was studied. Radiation reduced the numbers of mesophiles, psychrotrophs, anaerobic bacteria, and *Staphylococci* throughout storage. Effects of irradiation on sensory characteristics of pork loin were minimal. Irradiation of pork striploins (in vacuum packaged pH 6.2–6.6) at 2.5 and 4.3 kGy reduced 3 and 5 log in the number of viable bacteria present [85]. Significant organoleptic (color, odor, and flavor) changes occurred up to 1.0 kGy. Shelf life increased from 8 to 11.5 days for vacuum-packaged ground pork irradiated at 1 kGy when stored at 5°C [27,28], and from 4 to 6 weeks at 0°C [85]. The storage life of vacuum-packaged pork at 0°C and 5°C was doubled by 2.5 and 4.3 kGy treatment, but undesirable side effects were changes in color and odor of uncooked meat [26]. The odor resulting from a dose of 2.5 kGy was sufficient to make the meat unacceptable. Treatment using a dose of 1.0 kGy was effective in extending storage life and produced only slight changes in color and odor [26]. After 12 days of refrigerated storage, *Lactobacillus* and coryneform bacteria were predominated in the irradiated meat [27]. The microbial shelf life of vacuum-packaged pork lions stored at 2°C was extended from 41 to 90 days when treated by 3 kGy [68]. Samples of vacuum-packaged ground fresh pork were irradiated at doses from 0.57 to 7.25 kGy and stored at 2°C

TABLE 32.8

Shelf Life of Irradiated and Unirradiated Pork Loin in 100% Nitrogen

Irradiation Dose (kGy)	Storage Temperature (°C)	Shelf Life (Days)			
		Microbial	Color	Odor	Overall
0	5	14	9	16	9
1	5	21	35	26	21
0	25	2	<2	<2	<2
1	25	10	>14	2	2

Source: J.D. Lambert, J.P. Smith, K.L. Dodds, and R. Charbonneau, *Food Microbiol.* 9:231 (1992).

for 35 days and analyzed. Surviving microflora were not detected in any sample that received an absorbed dose of 1.91 kGy or higher. *Staphylococcus*, *Micrococcus*, and yeast species predominated in samples that received a dose of 0.57 kGy [124]. There is no significant difference between irradiated samples and control on lipid oxidation of irradiated pork chops during storage [33]. Ehioba et al. [28] identified microbial isolates from vacuum-packed ground pork irradiated at 1 kGy.

After reviewing the literature on irradiation in combination with modified-atmosphere packaging, Mitchell [86] mentioned that substantial extensions in sensory shelf life can be achieved using doses from 0.5 to 1.75 kGy and modified atmospheres of 25% to 50% carbon dioxide (balance nitrogen). The product must be stored at 5°C or less to achieve extended shelf life. Irradiation in the presence of oxygen has a detrimental effect on chemical and sensory characteristics, resulting in the rejection of the product [65,66]. A list of the shelf life of irradiated and unirradiated pork loin in 100% nitrogen is given in Table 32.8. The shelf life can be different, depending on quality attributes, such as microbial, and color. The microflora of irradiated modified-atmosphere packaging of pork is almost exclusively lactic acid bacteria [35]. Inoculation studies showed that *Clostridium perfringens* was the most resistant and *Yersinia enterocolitica* the most sensitive among *Clostridium perfringens*, *Yersinia enterocolitica*, *Escherichia coli*, *Listeria monocytogenes*, and *Salmonella typhimurium* [36].

### 32.3.2.5 Processed Meats

The amount of nitrite required in cured meats possibly can be reduced by irradiation, thus the chance of nitrosamine formation can be lowered [20,21]. The nitrite levels in irradiated bacon can be reduced from normal levels of 120–150 to 20–40 mg/kg without loss of organoleptic quality [113]. Moreover additives, such as herbs and spices frequently are used in meat products [29]. Wills et al. [135] treated vacuum-packaged sliced corn beef with radiation doses of 1, 2, and 4 kGy. The initial microbial load reduced by 1, 2.5, and 5 log cycles; however, slight changes in aroma and flavor at 2 kGy were observed and storage life was doubled to about 5 weeks. *Enterobacteriaceae* was effectively inactivated by irradiation with doses of 1–2 kGy when sensory effects were minimal. The product could be stored up to 5–7 days when treated at 2 kGy. The ground beef patties irradiated at 2.0 kGy under vacuum remained unspoiled even after 60 days of refrigerated storage [91]. In case of minced meat, a slight reduction of pH to 5.2–5.3 was observed when vacuum packaged at a dose of 2 kGy. Lactic acid bacteria were more resistant to radiation and became the dominant species during storage. The combination of pH reduction and irradiation prevented growth of *Enterobacteriaceae* even at 10°C incubation [31].

The sensory characteristics (flavor, texture, juiciness, and aftertaste) of ground beef patties irradiated at 2.0 kGy and stored under refrigerated conditions were studied by Murano et al. [91]. After 1 day, irradiated patties were significantly more juicy and tender than nonirradiated ones, while after 7 days no significant difference was observed.

### 32.3.2.6 Fish and Fish Products

Singh [114] and Nickerson et al. [96] reviewed the irradiation of meats and fish and their shelf life. Singh [114] mentioned that the control of pathogenic organisms and the extension of shelf life of fresh fish could be achieved with relatively low doses  $\leq 2.5$  kGy. However, *Clostridium botulinum* (A, B, E, and F)

present in fish and fish products remained unaffected by the low doses of irradiation. Thus, precautions during storage under 3°C and oxygen availability to the product need to be taken. In case of dried fish (moisture <20%) a dose of 0.3 kGy is sufficient to control insect attack and their larvae [49], but at higher levels of moisture from 20% to 40% a dose of 0.5 kGy is required.

Mold growth can also contribute to spoilage depending on the moisture level in the fish. Control of the mold growth by irradiation alone requires doses of 3–5 kGy [49]. Bacterial spoilage is also a problem in semidry and fresh fish, and fish products [114]. Typical doses up to 2.5 kGy are generally adequate to control the spoilage bacteria and extend the shelf life of fresh fish. The optimum irradiation doses and shelf lives of freshwater and marine fish, and shellfish have been compiled by Singh [114]. In general, the shelf-life extension on irradiation is dependent on the conditions of irradiation and storage and seems to vary from species to species of fish.

Al-Kahtani et al. [4] studied the effects of gamma irradiation (1.5–10 kGy) and postirradiation storage up to 20 days at 2°C of tilapia and Spanish mackerel. They found that (i) the total volatile basic nitrogen formation was lower in irradiated fish than in the unirradiated ones, (ii) a larger increase in thiobarbituric acid values that continued gradually during storage, (iii) some fatty acids ( $C_{14:0}$ ,  $C_{16:0}$ , and  $C_{16:1}$ ) decreased upon irradiation, while others ( $C_{18:0}$ ,  $C_{18:1}$ , and  $C_{18:2}$ ) increased, (iv) thiamine loss was more severe at higher doses  $\leq 4.5$ , whereas riboflavin was not affected, and (v) doses higher than 3.0 kGy caused a decrease in alpha and gamma tocopherols.

Chen et al. [14] studied the effect of low doses (2 kGy or less) in reducing pathogenic and spoilage microorganisms, and on the sensory quality of crab products (white lump, claw, and fingers) through 14 days of ice storage. Irradiation effectively reduced spoilage bacteria extending the shelf life by more than 3 days beyond control samples. Fresh crab odor and flavor were similar for treated and control samples, while off-flavors and odors developed more rapidly in controls during storage. Overall, acceptability scores for irradiated crab samples were higher than for control samples through 14 days of ice storage.

---

## 32.4 Technological Problems and Limitations of Irradiation

### 32.4.1 Major Problems of Irradiation

Successful implementation of a new technology depends on the availability of a proper infrastructure within a given country [71]. Irradiation has high capital costs and requires a critical minimum capacity and product volume for economic operation [128,130], although irradiation has a low operating cost and requires low energy [71].

There are threshold doses above which organoleptic changes and off-flavor development occur. But at low doses all microorganisms and their toxins will not be eliminated. Willemoti et al. [136] mentioned that variability of the effects leads to a difficulty in standardizing the irradiation treatment. The success of the treatment depends on commodity and cultivar, dose of radiation, degree of maturity, physiological status of fruits, temperature and atmosphere during and after treatment, pre, and postharvest treatments, and susceptibility of the microorganisms to be controlled [136]. Tolerance changes with the degree of maturity. Physiological status is continually changes with mechanical injury, season, and humidity at time of harvest. The response of each individual batch of fruits is therefore difficult to predict; thus, generalized dose levels and their consequences in quality are difficult to be developed.

The packaging materials used during irradiation should not cause the production and release of undesired substances, which may migrate into the food. Irradiation may affect different packaging materials in different ways. At doses of 60 kGy and higher, some damage may occur in tin-coated steel and aluminum containers, but at the level of sterilizing doses there should not be any affect. The enamels usually used in the interior must also be of proper type. For example, in case of high-fat-content foods, oleoresin enamels are unsuitable, but suitable for enzyme inactivation of foods. Irradiation apparently depolymerizes butyl-rubber sealing compounds used in cans [34]. The shape of the container is also very important. A cubical form is most satisfactory for optimum dose distribution during irradiation [34].

El-Makhzoumi [30] mentioned that the effect of irradiation on plastic films depends on the nature of packaging film, layers of packaging film, additives in formulation, temperature and oxygen content during treatment, treatment dose, dose actually absorbed, and contact with foods. At doses less than 20kGy, physical

changes in flexible containers are negligible. High doses above 30 kGy cause brittleness in cellophanes, saran, and plioform, while 20 kGy or more can cause inconsequential physical changes in mylar, polyethane, vinyl, and polyethylene plastic films [34]. The physical damages can be considerably reduced by the addition of aromatic additives. At strong doses of 50kGy, mechanical properties of polymers can be improved by cross-linking [51]. At the doses generally applied from 3 to 25 kGy, the migration of water increases [75]. The properties of polyethylene terephthalate (PET) are well preserved during irradiation [58]. Table 32.9 shows the FDA-approved levels of irradiation doses in case of different packaging materials.

An important problem in the irradiation of foods in plastic containers is the production of gas and volatiles compounds, which may migrate into the food and cause off-flavors. At sterilizing doses, nylon gives rise to little off-odor production, while in case of polyethylene, short fragmentations of the polymer are produced, which enter the food [34]. Some food packaging materials produce volatile compounds under certain conditions. Volatile compounds are formed in polyethylene, polyester terephthalate, and oriented polypropylene after irradiation dose from 5 to 50kGy. Twenty-two compounds were identified for polyester terephthalate, 40 for oriented polypropylene, and only acetone was identified for polyethylene, which could be a good candidate for irradiation of packaged food products. These compounds are hydrocarbons, ketones, and aromatic compounds [30]. El-Makhzoumi [30] mentioned that these compounds are able to migrate into a packed food product and affect its quality. The kinetics of degradation showed that some compounds remain trapped in the polymer and can be used as irradiation detectors. Irradiated foods should be properly handled and stored after treatment to avoid deterioration, spoilage, and loss of nutritive value. Thus, handling, storage conditions, and packaging are important postirradiation considerations [34].

### 32.4.2 Legal Aspects and Safety Issues

A joint FAO/IAEA/WHO Expert Committee on Food Irradiation (IJEFCF) concluded that irradiation of food up to an overall average dose of 10 kGy causes no toxicological hazards and introduces no special nutritional or microbiological problems [133,134]. Later, other organizations such as Health Canada, the FDA, the Codex Alimentarius Commission, and European Commission's Scientific Committee on Food also supported this limit [117]. In 1993, the American Medical Association's Council on Scientific Affairs endorsed food irradiation as a safe and effective tool to increase food safety and reduce the incidence of foodborne illness, a view expressed earlier by the U.S. Department of Agriculture [73].

Irradiation of food and agricultural products is currently allowed in about 40 countries and approximately 60 commercial irradiation facilities are operating in the United States [118]. The most common irradiated food products for commercial use are spices and dry vegetable seasonings [73]. Loaharanu and Murrell [73] mentioned that the recent ban on the use of ethylene oxide for food by European Union could increase the quantity of spices and vegetables seasonings processed by irradiation in the near future. The fumigants ethylene oxide (reported to be carcinogenic) and methyl bromide could be harmful to the ozone layer [72].

The safety issues of irradiated foods can be grouped as [88] (i) residual radioactivity, (ii) free radicals and radiolytic products, (iii) carcinogenic and mutagenic properties, (iv) nutrient quality, (v) polyploidy, (vi) toxicity, (vii) microbiological safety, and (viii) operator safety during processing. A complete review

**TABLE 32.9**

Packaging Materials Approved by FDA for Use during Irradiation of Food Packaging Materials

Type of Material	Maximum Dose (kGy)
Paper (kraft)	0.5
Paper (glassine)	10
Paperboard (wax-coated)	10
Cellophane (coated)	10
Polyolefin film	10
Polystyrene film	10
Rubber HCl film	10
Vinylidene chloride–vinyl chloride copolymer film	10
Nylon-6	10
Vegetable parchment	60
Polyethylene terephthalate film	60
Nylone-11	60
Vinyl chloride–vinyl acetate copolymer film	60
Acrylonitrile copolymers	60

Source: C. Willemoti, M. Marcotte, and L. Deschenes, *Processing Fruits: Science and Technology*, Vol. 1 (L. P. Somogyi, H. S. Ramaswamy, and Y. H. Hui, eds.), Technomic Publishing Company, Lancaster, PA, 1996, p. 221.

on the above aspects of safety is provided by Smith and Pillai [117]. The safety for human consumption of irradiated products has been questioned frequently [130]. The vast majority of toxicological studies and feeding trials have shown no evidence for toxic effects. However, some studies claimed to find evidence for polyploidy in irradiated wheat used in children feed [57]. There is already a wide experience in the design, building, and operation of irradiation plants. Therefore, the plants must be controlled and inspected by authorities to ensure national and international radiological safety standards, for example, health and safety of workers and environmental pollution from radioisotopes [5].

Relatively small doses of irradiation can reduce the numbers of pathogenic organisms to a very low level. This may give rise to the growth of secondary microflora, such as *Moraxella*, lactic acid bacteria, and yeasts. Thus, Mitchell [86] expressed concerns in the absence of competing spoilage microorganisms postirradiation, where toxin production by surviving pathogens may occur more quickly making the food unsafe to eat before it is visibly spoiled [62]. Irradiation should not be an excuse for poor hygiene and is not used for reducing unacceptably high levels of microbial contamination [57]. Smith and Pillai [117] identified two major concerns expressed by antiirradiation groups: misuse to avoid plant sanitation and environmental concerns. The volumes of irradiated foods are increasing and the future of irradiated foods is as bright as ever [97].

### 32.4.3 Consumers' Attitude

The application and cost effectiveness of irradiation as a method to control foodborne pathogens will depend on consumer attitude, regulatory actions, economics, and logistics associated with different situations. Moy [88] mentioned four reasons for the slow commercialization of food irradiation. These are antinuclear activism, industry's hesitation, time-consuming approval process, and insufficient consumer education. Griffith [39] mentioned that the major factors that will determine the future of food irradiation are the development of a simple and reliable detection method, the harmonization of legislation, the commitment of the food industry, and consumer attitudes. Similar to genetic engineering techniques in food production, it is essential that consumer education and consultation with consumers are an integral part of future developments. Loaharanu [71] reviewed the results of consumer attitude surveys in different countries. He concluded that in advanced countries consumers at large are still not knowledgeable about food irradiation. They need accurate information about safety, benefits, and limitations of food irradiation. Hashim et al. [44] also reviewed consumer attitudes toward irradiated poultry and recommended ways to increase the acceptance of irradiated foods: (i) educational programs to increase consumers' understanding about irradiation, (ii) propagate information about safety of irradiation through label and a poster, (iii) television shows, children interactions, and pamphlets or brochures, and (iv) in-store sampling of cooked irradiated poultry. Recently the importance of consumer education has also been identified [32,45,94]. Pohlman et al. [104] also showed that audiovisual presentation affects consumers' knowledge and attitude toward food irradiation. Kilcast [57] mentioned three methods that have been developed and can currently be used for detection purpose. These are electron spin resonance, thermoluminescence, and detection of lipid breakdown volatiles. However, all these methods require specialist expertise.

---

## References

1. E.K. Akamine and R.T.F. Wong, Extending shelf life of papayas with gamma irradiation, *Hawaii Farm Sci.* 15:4 (1966).
2. E.K. Akamine and T. Goo, Respiration of gamma irradiated fresh fruit, *J. Food Sci.* 36:1074 (1971).
3. E.K. Akamine and J.H. Moy, Delay in postharvest ripening and senescence of fruits, *Preservation of Food by Ionizing Radiation*. Vol. III. (E.S. Josephson and M.S. Peterson, eds.), CRC Press, Boca Raton, 1983.
4. H.A. Al-Kahtani, H.M. Abu-Tarboush, A.S. Bajaber, M. Atia, A.A. Abou-Arab, and M.A. El-Mojaddidi, Chemical changes after irradiation and post-irradiation storage in tilapia and Spanish mackerel, *J. Food Sci.* 61:729 (1996).
5. H.A.G. Ardeshir, Food irradiation: the U.K. perspective, *Food Science and Technology in Industrial Development* (S. Maneepun, P. Varangoon, and B. Phithakpol, eds.), Institute of Food Research and Product Development, Bangkok, 1988, p. 499.



6. M. Baccaud, Effects de l'ionisation sur les fruits et legumes destines a la consommation en frais, *Ionisation des Produits Alimentaires* (J.P. Vasseur, ed.), Tec & Doc-Lavoisier, Paris, 1991, p. 329.
7. S.L. Beilken, B. Bill, F.H. Gran, I. Griffiths, J.J. Macfarlane, P. Vanderlinde, and P.A. Wills, Irradiation of vacuum packaged sheep carcasses to extend chilled storage life, *Proceedings European Meeting Meat Research Works*, Helsinki, 1987, pp. 177-180.
8. K.M. Blythe, The Effect of Irradiation on the Organoleptic Quality of Fresh Chicken Carcasses, M.Sc. Thesis, The Queen's University of Belfast, Northern Ireland, 1990.
9. M.C. Bourne, Kinetic of softening of carrot by gamma radiation, *J. Text. Stud.* 26:553 (1995).
10. F.P. Boyle, Z.I. Kertesz, R.E. Glegg, and M.A. Connor, Effects of ionizing radiations on plant tissues. II. Softening of different varieties of apples and carrots by gamma rays, *Food Res.* 22:89 (1957).
11. J.K. Brecht, S.A. Sargent, J.A. Bartz, K.V. Chau, and J.P. Emond, Irradiation plus modified atmosphere for storage of strawberries, *Proc. Fla. State Hort. Soc.* 105:97 (1992).
12. A. Brynjolfsson, Energy and food irradiation, *Food Preservation by Irradiation*, vol. II, STI/PUB/470, IAEA, Vienna, 1978.
13. L.N. Ceci, O.A. Curzio, and A.B. Pomilio, Effects of irradiation and storage on the flavor of garlic bulbs cv 'red', *J. Food Sci.* 56:44 (1991).
14. Y.P. Chen, L.S. Andrewa, and R.M. Grodner, Sensory and microbial quality of irradiated crab meat products, *J. Food Sci.* 61:1239 (1996).
15. Codex Alimentarius Commission, *Codex Alimentarius*, Vol. 1, 2nd edition, Food and Agricultural Organization, Rome, Italy, 1992, p. 313.
16. R. Couture and C. Willemot, Combinaison d'une faible dose d'irradiation avec l'atmosphere controlee pour ralentir le murissement des fraises, *Proceedings of the International Conference on Technological Innovation in Freezing and Refrigeration of Fruits and Vegetables* (D.S. Reid, ed.), University of California, Davis, 1989, p. 40.
17. L.M. Crawford and E.H. Ruff, A review of the safety of cold pasteurization through irradiation, *Food Control* 7:87 (1996).
18. O.A. Curzio and A.M. Urioste, Sensory quality of irradiated onion and garlic bulbs, *J. Food Process Preserv.* 18:149 (1994).
19. J.D'Amour, C. Gosselin, J. Arul, F. Castaigne, and C. Willemot, Gamma-radiation affects cell wall composition of strawberries, *J. Food Sci.* 58:182 (1993).
20. J.F. Dempster, Radiation preservation of meat and meat products: a review, *Meat Sci.* 12:61 (1985).
21. J.F. Dempster, L. McGuire, and N.A. Halls, Effect of gamma radiation on the quality of bacon, *Food Microbiol.* 3:13 (1986).
22. N.W. Desrosier and J.N. Desrosier, *Technology of Food Preservation*, 4th edition, Avi Publishing, Westport, 1977.
23. Y.M. Diop, E. Marchioni, D. Ba, and C. Hasselmann, Radiation disinfestation of cowpea seeds contaminated by *Callosobruchus maculatus*, *J. Food Process. Preserv.* 21:69 (1997).
24. G.W. Eaton, C. Meehan, and N. Turner, Some physical effects of postharvest gamma radiation on the fruit of sweet cherry, blueberry, and cranberry, *J. Can. Inst. Food Technol.* 3:152 (1970).
25. A.F. Egan and P.A. Wills, The preservation of meats using irradiation, *CSIRO Food Res. Quat.* 45:49 (1985).
26. A.F. Egan, D. Miller, B.J. Shay, and P.A. Wills, Preservation of vacuum-packaged pork using irradiation, *Food Science and Technology in Industrial Development* (S. Maneepun, P. Varangoon, and B. Phithakpol, eds.), Institute of Food Research and Product Development, Bangkok, 1988, p. 515.
27. R. M. Ehioba, A.A. Kraft, R.A. Molins, H.W. Walker, D.G. Olson, G. Subbaraman, and R.P. Skowronski, Effect of low dose (100 krad) gamma radiation on the microflora of vacuum packaged ground pork with and without added sodium phosphates, *J. Food Sci.* 52:1477 (1987).
28. R.M. Ehioba, A.A. Kraft, R.A. Molins, H.W. Walker, D.G. Olson, G. Subbaraman, and R.P. Skowronski, Identification of microbial isolates from vacuum packaged ground pork irradiated at 1 kGy, *J. Food Sci.* 53:278 (1988).
29. M.I. Eiss, Irradiation of spices and herbs, *Food Technol. Aust.* 36:362 (1984).
30. Z. El-Makhzoumi, Effect of irradiation of polymeric packaging material on the formation of volatile compounds, *Food Packaging and Preservation* (M. Mathouthi, ed.), Blackie Academic & Professional, Glasgow, 1994, p. 88.
31. J. Farkas and E. Andrassy, Interaction of ionising radiation and acidulants on the growth of the microflora of a vacuum-packaged chilled meat product, *Int. J. Food Microbiol.* 19:145 (1993).
32. J.A. Fox, Influence on purchase of irradiated foods. *Food Technol.* 56(11):34 (2002).

33. A.H. Fu, J.G. Sebranek, and E.A. Murano, Effect of irradiation treatment on selected pathogens and quality attributes of cooked pork chops and cured ham, *J. Food Sci.* 59:306 (1994).
34. H.D. Graham, Safety and wholesomeness of irradiated foods, *The Safety of Foods* (H.D. Graham, ed.), Avi Publishing, Westport, 1980, p. 546.
35. I.R. Grant, The microbiology of irradiated pork, *Dissert. Abstr. Int. C* 53:35 (1992).
36. I.R. Grant and M.F. Patterson, Effect of irradiation and modified atmosphere packaging on the microbiological safety of minced pork stored under temperature abuse conditions, *Int. J. Food Sci. Technol.* 26:521 (1991).
37. I.R. Grant, C.R. Nixon, and M.F. Patterson, Effect of low-dose irradiation on growth of and toxin production by *Staphylococcus aureus* and *Bacillus cereus* in roast beef and gravy, *Int. J. Food Microbiol.* 18:25 (1993).
38. I.R. Grant, C.R. Nixon, and M.F. Patterson, Comparison of the growth of *Listeria monocytogenes* in unirradiated and irradiated cook chill roast beef and gravy at refrigeration temperatures, *Lett. Appl. Microbiol.* 17:55 (1993).
39. G. Griffith, Irradiated foods: new technology, old debate, *Trends Food Sci. Technol.* 3:251 (1992).
40. I. Gruik and I. Kiss, *Acta Alimentaria* 16:111 (1987).
41. T. Hanis, P. Jelen, P. Klir, J. Mnukova, B. Perez, and M. Pesek, Poultry meat irradiation—effect of temperature on chemical changes and inactivation of micro-organisms, *J. Food Prot.* 52:26 (1989).
42. H.L. Hanson, M.J. Brushway, M.F. Pool, and H. Lineweaver, Factors causing color and texture differences in radiation-sterilized chicken, *Food Technol.* 17:108 (1963).
43. Y. Hasegawa and J.H. Moy, Reducing oligosaccharides in soybeans by gamma-radiation-controlled germination, *Joint FAO/IAEA Proc. Symp. Rad. Preserv. of Foods*, STI/PUB/317, 1973, p. 89.
44. I.B. Hashim, A.V.A. Resurreccion, and K.H. McWatters, Consumer attitudes toward irradiated poultry, *Food Technol.* 50:77 (1996).
45. D.J. Hayes, J.A. Fox, and J.F. Shogren, Experts advocates: how information affects the demand for food irradiation, *Food Policy* 27(2):185 (2002).
46. C.H.S. Hitchcock, Determination of hydrogen in irradiated frozen chicken, *J. Sci. Food Agric.* 68:319 (1995).
47. L.R. Howard and R.W. Buescher, Cell wall characteristics of gamma irradiation refrigerated cucumber pickles, *J. Food Sci.* 54:1266 (1989).
48. C.N. Huhtanen, R.K. Jenkins, and D.W. Thayer, Gamma radiation sensitivity of *Listeria monocytogenes*, *J. Food Prot.* 52:610 (1989).
49. IAEA, *Radiation Preservation of Fish and Fishery Products* (STI/DOC/10/303), International Atomic Energy Agency, Vienna, 1989.
50. IAEA, International Atomic Energy Agency. Analytical Detection Methods for Irradiated Foods. A Review of the Current Literature, IAEA-TECDOC-587, IAEA, Vienna, 1991.
51. P. Jacobs, *Polym. Plast. Technol. Eng.* 17:69 (1981).
52. C.F. Johnson, E.C. Maxie, and E.M. Elbert, Physical and sensory tests on fresh strawberries subjected to gamma irradiation, *Food Technol.* 19:119 (1965).
53. A.A. Kader, Potential application of ionizing radiation in postharvest handling of fresh fruit and vegetables, *Food Technol.* 40:117 (1986).
54. R.S. Kahan and J.J. Howker, Low-dose irradiation of fresh, non-frozen chicken and other preservation methods for shelf-life extension and for improving its public health quality, *Food Preservation by Irradiation*, Vol. II, Proceedings of Symposium, Wageningen, 1977, p. 221.
55. E.H. Kampelmacher, Irradiation for control of *Salmonella* and other pathogens in poultry and fresh meats, *Food Technol.* 37:117 (1983).
56. Z.I. Kertesz, R.E. Glegg, F.P. Boyle, G.F. Parsons, and I.M. Massey, Effect of ionizing radiation on plant tissues. III. Softening and changes in pectins and cellulose of apple, carrots beets, *J. Food Sci.* 29:40 (1964).
57. D. Kilcast, Food irradiation: current problems and future potential, *Int. Biodeter. Biodegra.* 36:279 (1995).
58. J.J. Killoran, Chemical and physical changes in food packaging materials exposed to ionizing radiation, *Rad. Res. Rev.* 3:369 (1972).
59. H. Koxsel, S. Celik, and T. Tuncer, Effects of gamma irradiation on durum wheats and spaghetti quality, *Cereal Chem.* 73:507 (1996).
60. P. Kurstadt and F. Fraser, *Food Irradiation Technology Overview*, Nordion International, Ontario, Canada, 1994.

61. J.H. Kwon and H.S. Yoon, Changes in flavor compounds of garlic resulting from gamma irradiation, *J. Food Sci.* 50:1193 (1985).
62. R.W. Lacey and S.F. Deailer, Food irradiation: unsatisfactory preservative, *Brit. Food J.* 92:15 (1990).
63. S.P. Lai, K.F. Finney, and M. Milner, Treatment of wheat with ionizing radiations, IV. Oxidative, physical, and biochemical changes, *Cereal Chem.* 36:401 (1959).
64. J.D. Lambert and R.B. Maxcy, Effect of gamma radiation on *Campylobacter jejuni*, *J. Food Sci.* 49:665 (1984).
65. J.D. Lambert, J.P. Smith, and K.L. Dodds, Physical, chemical and sensory changes in irradiated fresh pork packaged in modified atmosphere, *J. Food Sci.* 57:1294 (1992).
66. J.D. Lambert, J.P. Smith, K.L. Dodds, and R. Charbonneau, Microbiological changes and shelf-life of MAP, irradiated fresh pork, *Food Microbiol.* 9:231 (1992).
67. C.H. Lea, J.J. Macfarlane, and L.J. Parr, Treatment of meat with ionizing radiations V. Radiation pasteurization of beef for chilled storage, *J. Sci. Food Agric.* 11:690 (1960).
68. S. Lebepe, R.A. Molins, S.P. Charven, I.V. Farrar, and R. P. Skowronski, Changes in microflora and other characteristics of vacuum packaged pork loins irradiated at 3.0 kGy, *J. Food Sci.* 55:918 (1990).
69. M. Lee, J. Sebranek, and F.C. Parrish, Accelerated postmortem aging of beef utilizing electron beam irradiation and modified atmosphere packaging, *J. Food Sci.* 61:133 (1996).
70. S.J. Lewis and J.E.L. Corry, Survey of the incidence of *Listeria monocytogenes* and other *Listeria* spp. in experimentally irradiated and in matched unirradiated raw chickens, *Int. J. Food Micro.* 12:257 (1991).
71. P. Loaharanu, Food irradiation: current status and future prospects, *New Methods of Food Preservation* (G.W. Gould, ed.), Blackie Academic and Professional, Glasgow, 1995, p. 90.
72. P. Loaharanu, The status and prospects of food irradiation, *The IFTEC Symposium S-14 on Food Irradiation: Recent Developments and Future Prospects*, Hague, The Netherlands, 1992.
73. P. Loaharanu and D. Murrell, A role for irradiation in the control of foodborne parasites, *Trends Food Sci. Nutri.* 5:190 (1994).
74. R.T. Lovell and G.J. Flick, Irradiation of Gulf Coast area strawberries, *Food Technol.* 29:99 (1966).
75. F. Lox, *Proceedings 5th IAPRI Conf.*, Bristol, 1986, p. 1.
76. L.A. MacArthur and B.L. D'Appolonia, Gamma radiation of wheat. I. Effects on dough and baking properties, *Cereal Chem.* 60:456 (1983).
77. D.B. MacDougall, Instrument assessment of the appearance of foods, *Sensory Quality in Foods and Beverages. Definition, Measurement and Control* (A.A. Williams and K.K. Atkin, eds.), Ellis Horwood, Chichester, 1983, p. 121.
78. J.J. Macfarlane, I.J. Eustace, and F.H. Grau, Ionizing energy treatment of meat and meat products, *Proceedings of the National Symposium Ionization Energy Treatment of Foods*, Sydney, 1983.
79. A. Matsuyama and K. Umeda, Sprout inhibition in tubers and bulbs, *Preservation of Food by Ionizing Radiation*. Vol. III (E.S. Josephson and M. S. Peterson, eds.), CRC Press, Boca Raton, 1983.
80. E.C. Maxie and A. Abdel-Kader, Food irradiation-physiology of fruits as related to feasibility of the technology, *Adv. Food Res.* 15:105 (1966).
81. C. Merrit, *Radiat. Res. Rev.* 3:353 (1972).
82. W.R. Merritt, P. Angelini, E. Wierbicki, and G.W. Shults, Chemical changes associated with flavor in irradiated meat, *J. Agric. Food Chem.* 23:1037 (1975).
83. W.R. Miller and R.E. McDonald, Low-dose electron beam irradiation: a methyl bromide alternative for quarantine treatment of floride blueberries, *Proc. Fla. State Hort. Soc.* 108:291 (1995).
84. S.J. Millar, B.W. Moss, D.B. Macdougall, and M. H. Stevenson, The effect of ionising radiation on the CIELAB colour co-ordinates of chicken breast meat as measures by different instruments, *Int. J. Food Sci. Technol.* 30:663 (1995).
85. D.E. Miller, Studies of Techniques for Extending the Shelf Life of Vacuum Packed Pork, M.Phil. Thesis, Griffith University, Brisbane, 1987.
86. G.E. Mitchell, Irradiation preservation of meats, *Food Aust.* 46:512 (1994).
87. B.E.B. Moseley, Ionizing radiation: action and repair, *Mechanisms of Action of Food Preservation Procedures* (G.W. Gould, ed.), Elsevier Applied Science, London, 1989, p. 43.
88. J.H. Moy, Food irradiation-lessons and prospects for world food preservation and trade, *Development of Food Science and Technology in South East Asia* (O.B. Liang, A. Buchanan, and D. Fardiaz, eds.), IPB Press, Bogor, 1993, p. 86.
89. R.W.A.W. Mulder, Ionising energy treatment of poultry, *Food Technol. Aust.* 36:418 (1984).

90. E.A. Murano, Irradiation of fresh meats, *Food Technol.* 49:52 (1995).
91. P. S. Murano, E.A. Murano, and D.G. Olson, Quality characteristics and sensory evaluation of ground beef irradiated under various packaging atmosphere, Presented at International Congress of Meat Science and Technology, San Antonio, 1995.
92. D.R. Murray, *Biology of Food Irradiation*, Wiley, New York, 1990.
93. W.W. Nawar, Radiolytic changes in fats, *J. Rad. Res. Rev.* 3:327 (1972).
94. R.M. Nayga, A. Poghosyan, and J. Nichols, Will consumers accept irradiated food products? *Intl. J. Consumer Studies* 28(2):178 (2004).
95. W.P.K. Ng, W. Bushuk, and J. Borsa, Effect of gamma ray and high-energy electron irradiations on breadmaking quality of two Canadian wheat cultivars, *Can. Inst. Food Sci. Technol. J.* 22:173 (1989).
96. J.T.R. Nickerson, J.J. Licciardello, and J. Ronsivalli, Radurization and rancidation: fish and shellfish, *Preservation of Food by Ionizing Radiation*, Vol. III (E.S. Josephson, and M.S. Peterson, eds.), CRC Press, Boca Raton, FL, 1983.
97. D.G. Olson, Food irradiation future still bright, *Food Technol.* 58(7):112 (2004).
98. P.C. Onyenekwe and G.H. Ogbadu, Effect of gamma irradiation on the microbial population and essential oil of ginger, *Proceedings of the 1st National Conference in Nuclear Methods* (L.A. Dim, T.C. Akpa, M.C. Maiyaki, and S.P. Mallam, eds.), Zaria, Nigeria, 1992, p. 124.
99. P.C. Onyenekwe, G.H. Ogbadu, and S. Hashimoto, The effect of gamma radiation on the microflora and essential oil of Ashanti pepper (*Piper guineense*) berries, *Postharv. Biol. Technol.* 10:161 (1997).
100. O. Paredes-Lopez and M.M. Covarrubias-Alvarez, Influence of gamma radiation on the rheological and functional properties of bread wheats, *J. Food Technol.* 19:225 (1984).
101. P. Paul, V. Venugopal, and P.M. Nair, Shelf life enhancement of lamb meat under refrigeration by gamma irradiation, *J. Food Sci.* 55:865 (1991).
102. R.E. Paull, Ripening behavior of papaya (*Carica papaya* L.) exposed to gamma irradiation, *Postharv. Biol. Technol.* 7:359 (1996).
103. M. Patterson, Sensitivity of bacteria to irradiated on poultry meat under various atmosphere, *Lett. Appl. Microbiol.* 7:55 (1988).
104. A.J. Pohlman, O.B. Wood, and A.C. Mason, Influence of audiovisuals and food samples on consumer acceptance of food irradiation, *Food Technol.* 48:46 (1994).
105. B.E. Procter and S.A. Goldblith, Food processing with ionizing radiations, *Food Technol.* 5:376 (1951).
106. T. Radomyski, E.A. Murano, and D.G. Olson, Elimination of pathogens of significance in food by low-dose irradiation: a review, *J. Food Prot.* 57:73 (1994).
107. A.H. Rady, R.J. Maxwell, E. Wierbicki, and J.G. Phillips, Effect of gamma irradiation at various temperatures and packaging conditions on chicken tissues, *Radiat. Phys. Chem.* 31:195 (1988).
108. S.R. Rao, R.C. Hosney, K.F. Finney, and M.D. Shogren, Effects of gamma-irradiation of wheat on breadmaking properties, *Cereal Chem.* 52:506 (1975).
109. V.S. Rao, U.K. Vakil, C. Bandyopadhyay, and A. Sreenivasan, Effect of gamma irradiation of wheat on volatile flavor components of bread, *J. Food Sci.* 43:68 (1978).
110. V.S. Rao, U.K. Vakil, and A. Sreenivasan, Effects of gamma-irradiation of composition of wheat lipids and purothionines, *J. Food Sci.* 43:64 (1978).
111. H.R. Rodriguez, J.A. Lasta, R.A. Malbo, and N. Marchevsky, Low dose gamma irradiation and refrigeration to extend shelf life of aerobically packed fresh beef round, *J. Food Prot.* 56:505 (1993).
112. S. Shibata, T. Imai, H. Toyoshima, K. Umeda, and T. Ishima, Noodle-making quality of gamma-irradiated wheats, *J. Food Sci. Technol. (Tokyo)* 21:161 (1974).
113. H. Singh, Radiation preservation of low nitrite bacon, *Radiat. Phys. Chem.* 31:165 (1988).
114. H. Singh, Extension of shelf-life of meats and fish by irradiation, *Shelf Life Studies of Foods and Beverages* (G. Charalamboue, ed.), Elsevier Science Publishers B.V., Amsterdam, 1993, p. 145.
115. J. Sivinski and K. Switzer, Low dose irradiation: a promising option for trichina-safe pork certification, *Proceedings from the International Conference on Radiation Disinfection of Food and Agricultural Products*, Honolulu, 1983.
116. C.F. Snyder, Method of tenderizing meat, U.S. Patent 3,761,283, 1973.
117. J.S. Smith and S. Pillai, Irradiation and safety. *Food Technol.* 58(11):48 (2004).
118. C.H. Sommers, Food Irradiation is already here. *Food Technol.* 58(11):22 (2004).
119. L.P. Somogyi and R.J. Romani, Irradiation induced texture change in fruits and its relation to pectin metabolism, *J. Food Sci.* 29:366 (1964).

120. G.J. Strydom, J. Van Staden, and M.T. Smith, The effect of gamma radiation on the ultrastructure of the peel of banana fruits, *Environ. Exp. Bot.* 31:43 (1991).
121. S. Sudarmadji and W.M. Urbain, Flavor sensitivity of selected animal protein foods to gamma radiation, *J. Food Sci.* 37:671 (1972).
122. D.W. Thayer and G. Boyd, Gamma ray processing to destroy *Staphylococcus aureus* in mechanically deboned chicken meat, *J. Food Sci.* 57:848 (1992).
123. D.W. Thayer and G. Boyd, Elimination of *Escherichia coli* 0157:H7 in meats by gamma irradiation, *Appl. Environ. Microbiol.* 59:1030 (1992).
124. D.W. Thayer, G. Boyd, and R.K. Jenkins, Low dose gamma irradiation and refrigerated storage in vacuum affect microbial flora of fresh pork, *J. Food Sci.* 58:717 (1993).
125. P. Thomas, Radiation preservation of foods of plant origin. Part V. Temperature fruits: pome fruits, stone fruit and berries, *CRC Crit. Rev. Food Sci. Nutr.* 24:357 (1986).
126. W. Uchman, W. Fiszer, I. Mroz, and A. Pawlik, The influence of radapertization upon some sensory properties of black pepper, *Nahrung* 27:461 (1983).
127. UFFVA, *Food Irradiation for the Produce Industry*, United Fresh Fruit and Vegetable Association, 1986, p. 1.
128. W.M. Urbain, *Food Irradiation*, Academic Press, New York, 1982.
129. W.M. Urbain, *Food Irradiation*, Academic Press, New York, 1986.
130. K. Vas, Food preservation, *Developments in Food Science 2* (H. Chiba, M. Fujimaki, K. Iwai, H. Mitsuda, and Y. Morita, eds.), Kodansha Ltd. Tokyo, 1979, p. 205.
131. R. Voisine, C. Hombourger, C. Willemot, F. Castaigne, and J. Makhlof, Effect of high carbon dioxide storage and gamma irradiation on membrane deterioration in cauliflower florets, *Postharv. Biol. Technol.* 2:279 (1993).
132. R. Voisine, L.P. Vezina, and C. Willemot, Modification of phospholipid catabolism in microsomal membranes of  $\gamma$ -irradiated cauliflower (*Brassica oleracea* L.), *Plant Physiol.* 102:213 (1993).
133. WHO, Wholesomeness of Irradiated Food: Summaries of Data considered by the Joint FAO/IAEA/WHO Expert Committee on the Wholesomeness of Irradiated Food, EHE/81.24, Geneva, Switzerland, 1980.
134. WHO, Food Irradiation: A Technique for Preserving and Improving the Safety of Food, WHO, Geneva, 1988.
135. P.A. Wills, J.J. Macfarlane, B.J. Shaw, and A.F. Egan, Radiation preservation of vacuum-packaged sliced corned beef, *Int. J. Food Microbiol.* 4:313 (1987).
136. C. Willemot, M. Marcotte, and L. Deschenes, Ionizing radiation for preservation of fruits, *Processing Fruits: Science and Technology*, Vol. 1 (L.P. Somogyi, H.S. Ramaswamy, and Y.H. Hui, eds.), Technomic Publishing Company, Lancaster, PA, 1996, p. 221.
137. C. Woese, Further studies on the ionizing radiation inactivation of bacterial spores, *J. Bacteriol.* 77:38 (1959).
138. J.J. Wu and J.S. Yang, Effects of gamma irradiation on the volatile compounds of ginger rhizome (*Zingiber officinale roscoe*), *J. Agric. Food Chem.* 42:2574 (1994).
139. J. Wu, J. Yang, and M. Liu, Effects of irradiation on the volatile compounds of garlic (*Allium sativum* L.), *J. Sci. Food Agric.* 70:506 (1996).
140. J.S. Yang, Y.H. Fu, and T.Y. Liu, Effects of Irradiation Treatment on Nutritive Constituents of Garlics, Gingers, Onions and Potatoes (Report No 144), Food Industry Research and Development Institute, Hsinchu, Taiwan, 1979, p. 506.
141. L. Yu, C.A. Reitmeier, M.L. Gleason, G.R. Nonnecke, D.G. Olson, and R.J. Gladon, Quality of electron beam irradiated strawberries, *J. Food Sci.* 60:1084 (1995).
142. L. Yu, C.A. Reitmeier, and M.H. Love, Strawberries texture and pectin content as affected by electron beam irradiation, *J. Food Sci.* 61:844 (1996).
143. H. Zegota, Suitability of Dukat strawberries for studying effects of irradiation combined with cold storage, *Z. Lebensm. Unters. Forsch.* 187:111 (1988).
144. M. Zhao, J. Moy, and R.E. Paull, Effect of gamma-irradiation on ripening papaya pectin, *Postharv. Biol. Technol.* 8:209 (1996).

# 33

## *Pulsed Electric Fields in Food Preservation*

Humberto Vega-Mercado, M. Marcela Gongora-Nieto, Gustavo V. Barbosa-Canovas, and Barry G. Swanson

### CONTENTS

33.1	Introduction .....	783
33.2	Engineering Aspects of PEFs .....	785
33.2.1	Bench-Top Unit .....	786
33.2.2	Lab-Scale Pulser .....	786
33.2.3	Treatment Chambers .....	786
33.2.4	PEF Process Design .....	788
33.2.4.1	HACCP Principles and PEF Technology .....	788
33.2.4.2	Hazard and Operability Study (HAZOP) Principles and PEF Technology .....	790
33.2.5	Currently Used PEF Technology .....	791
33.3	Applications of PEF in Food Processing .....	792
33.3.1	Inactivation of Microorganisms .....	792
33.3.1.1	Simulated Milk Ultrafiltrate (SMUF) .....	792
33.3.1.2	Pea Soup .....	796
33.3.1.3	Liquid Eggs .....	796
33.3.1.4	Apple Juice .....	800
33.3.1.5	Skim Milk .....	800
33.3.2	Denaturation of Proteins .....	805
33.3.2.1	Alkaline Phosphatase .....	805
33.3.2.2	Plasmin and a Protease from <i>Pseudomonas fluorescens</i> M3/6 .....	805
33.4	Final Remarks .....	810
	References .....	811

### 33.1 Introduction

There are many different ways of applying electric energy for food pasteurization. These include ohmic heating [1–3], microwave heating [4–6], low electric field stimulation [7,8], high-voltage arc discharge [9–12], and high-intensity pulsed electric field (PEF) application [13–15]. Ohmic heating is one of the earliest forms of electricity applied to food pasteurization [1]. This method relies on the heat generated in food products when an electric current is passed through them. Getchell [2] described the ohmic heating method in milk pasteurization. A 220V, 15kW alternating current supply was applied to milk through carbon electrodes in an electrical heating chamber. The milk was heated to and held at 70°C for about 15 s. It has been reported that ohmic heating is suitable for viscous products and foods containing particles, and this method is considered to be a promising technique for the aseptic processing of foods [3].

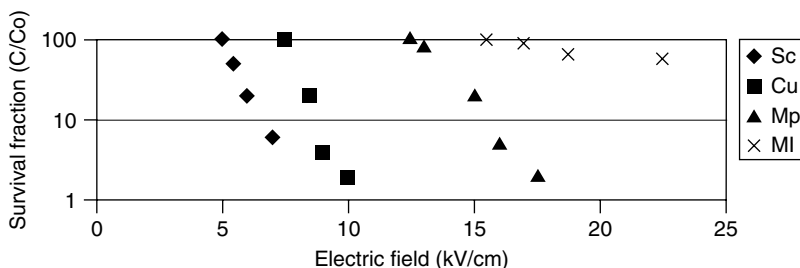
Microwave heating has been extensively applied everyday in households and the food industry [4]. Many food materials possess very low values of static conductivity. However, when they are subjected to microwave fields, they exhibit very high values of alternating field conductivity and consume

considerable energy [5]. The heat generated by microwaves is used for heating processes. Studies on microbial inactivation using microwave energy have concluded that microbial death is caused solely by thermal mechanisms [6].

Low electric field stimulation has been explored as a method of bacterial control of meat. In electrical stimulation of meat, an electric field of 5–10 V/cm is applied as alternating current (ac) pulses to the sample through electrodes fixed at opposite ends of the long axis of the muscle [7]. Recently, a very low field (0.4 V/cm) has been applied in a 6-L treatment medium in search of an easy, safe, and practical method to eliminate bacteria for food processing purposes. Several species of bacteria in saline solution were inactivated [8]. Salt solutions and their concentrations play a very important role in this method [48].

Inactivation of microorganisms and enzymes contained in food products by electric discharge began in the 1920s with the Electropure process for milk [16], which consisted of passing an electric current through carbon electrodes and heating milk to 70°C to inactivate *Mycobacterium tuberculosis* and *Escherichia coli*. Beattie and Lewis [17] demonstrated a lethal effect of electrical discharges on microorganisms when the applied voltage used to treat food was increased to 3000–4000 V. The electrohydraulic treatment was introduced in the 1950s to inactivate microorganisms suspended in liquid foods. The inactivation of microorganisms was attributed to a shock wave generated by an electric arc that prompted the formation of highly reactive free radicals from chemical species in food [14]. Gilliland and Speck [18] applied pulsed electric discharges at different energy levels for the inactivation of *E. coli*, *Streptococcus faecalis*, *Bacillus subtilis*, *Streptococcus cremoris*, and *Micrococcus radiodurans* suspended in sterile distilled water as well as for trypsin and a protease from *B. subtilis* [47].

Sale and Hamilton [19] demonstrated the nonthermal lethal effect of homogeneous electric fields on bacteria such as *E. coli*, *Staphylococcus aureus*, *Micrococcus lysodeikticus*, *Sarcina lutea*, *B. subtilis*, *B. cereus*, *B. megaterium*, *Clostridium weichii*, and yeasts such as *Saccharomyces cerevisiae* and *Candida utilis*. In general, an increase in the electric field intensity and number of pulses led to an increase in the inactivation of microorganisms (Figure 33.1 and Table 33.1). Other factors that influence



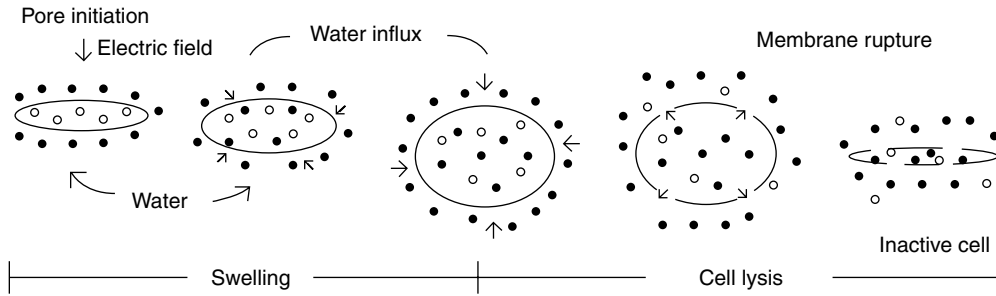
**FIGURE 33.1** Relationship between survival fraction and electric field strength (1020  $\mu$ s pulses). Sc: *Saccharomyces cerevisiae*; Cu: *Candida utilis*; Mp: Motile pseudomonad; MI: *Micrococcus lysodeikticus*. (Adapted from W. A. Hamilton and A. J. H. Sale, *Biochem. Biophys. Acta* 148: 789 (1967).)

**TABLE 33.1**

Activity of *Staphylococcus aureus* after PEF Treatment

Electric Field (kV/cm)	Survivors (%)	Protoplasts Not Lysed
0.00	100	100
9.25	100	100
14.25	35	43
19.50	0.9	16
24.00	0.3	3
27.50	0.6	2

Source: Adapted from W. A. Hamilton and A. J. H. Sale, *Biochem. Biophys. Acta* 148: 789 (1967).



**FIGURE 33.2** Mechanism of cell inactivation. (Adapted from T. Y. Tsong, *Biochim. Bioeng.* 24: 271, 1990.)

microbial inactivation by PEFs are the treatment temperature, pH, ionic strength, and conductivity of the medium containing the microorganisms [9,20–26].

Formation of pores on cell membranes by high-intensity PEFs (HIPEFs) is not entirely understood. Zimmermann et al. [27], applying the dielectric rupture theory, concluded that membrane rupture is caused by an induced transmembrane potential approximately 1 V larger than the natural potential of the cell membrane. The reversible or irreversible rupture (or electroporation) of a cell membrane depends on factors such as intensity of the electric field, number of pulses, and duration of the pulses [28–31]. The plasma membranes of cells become permeable to small molecules after being exposed to an electric field; permeation then causes swelling and the eventual rupture of the cell membrane (Figure 33.2).

In September 1996, the U.S. Food and Drug Administration (FDA), based in Washington, DC, released a “letter of no objection” for the use of PEFs to treat liquid eggs. To meet the FDA requirements [32] in filing a new and a novel process, it is necessary to (a) establish an active and continuous dialog with the FDA during process development, (b) meet with the FDA to describe the process, (c) invite the FDA to a site visit (pilot and production facility), and (d) draft and provide the FDA with an outline of the proposed filing.

The objective of the FDA is to conduct a scientific evaluation of the process to determine if the aseptically produced product poses a potential public health hazard, and if all the critical factors necessary to render the product commercially sterile are monitored and controlled. The filing information of the new process must contain

1. Equipment design: a description of the system, control mechanisms used, and fail safe procedures
2. Product specifications: a full description of the product, including physical/chemical aspects, critical factors, and influence of processing on the critical factors
3. Process design: a complete description of the critical/processing conditions used in the manufacture of the product
4. Validation: a physical demonstration of the accuracy, reliability, and safety of the process

In the area of PEFs, there are many possible project-development designs related to (a) unknown destruction kinetics of microbial pathogens (e.g., *Clostridium botulinum*), (b) identification of proper indicator organisms, (c) uniformly delivered treatment, (d) impact of processing conditions (e.g., temperature, pH, moisture, and lipid content), (e) identification/monitoring of critical factors (e.g., surface and intensity), and (f) food additives.

### 33.2 Engineering Aspects of PEFs

The concept of pulsed power is simple: electric energy at low power levels is collected over an extended period and stored in a capacitor. That same energy can then be discharged almost instantaneously at very high levels of power. The generation of PEFs requires two major devices: a pulsed power supply and a treatment chamber, which converts the pulsed voltage into PEFs.



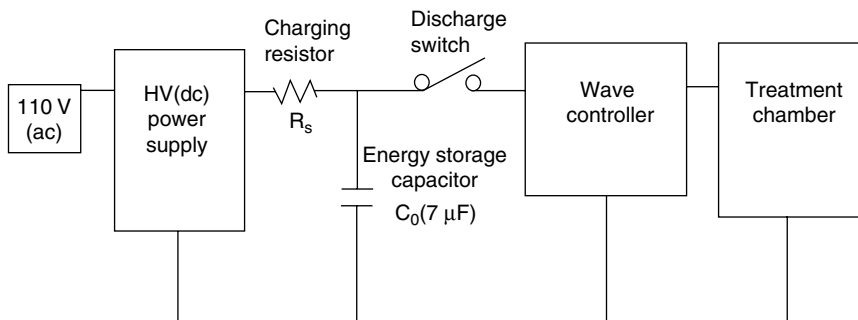


FIGURE 33.3 Major components of commercial electroporator GeneZapper.

### 33.2.1 Bench-Top Unit

A commercial electroporator (e.g., GeneZapper, IBI-Kodak Company, Rochester, NY) may be used as a bench-top pulsed power supply. This unit provides a maximum of 2.5 kV pulses. The instrument consists of a capacitor (7  $\mu\text{F}$ ), charge and discharge switches, and a wave controller. The wave controller may be connected to the electroporator to improve the discharge pattern. Treatment cuvettes with a 0.1-cm electrode gap and 100  $\mu\text{L}$  volume may be used for PEF treatments, which give a maximum intensity of approximately 25 kV/cm. Appropriate voltage and current monitors should be attached to the GeneZapper to measure the PEF treatments. Figure 33.3 illustrates the major components of the GeneZapper. This bench-top unit provides a convenient method for determining the inactivation kinetics for selected microorganisms.

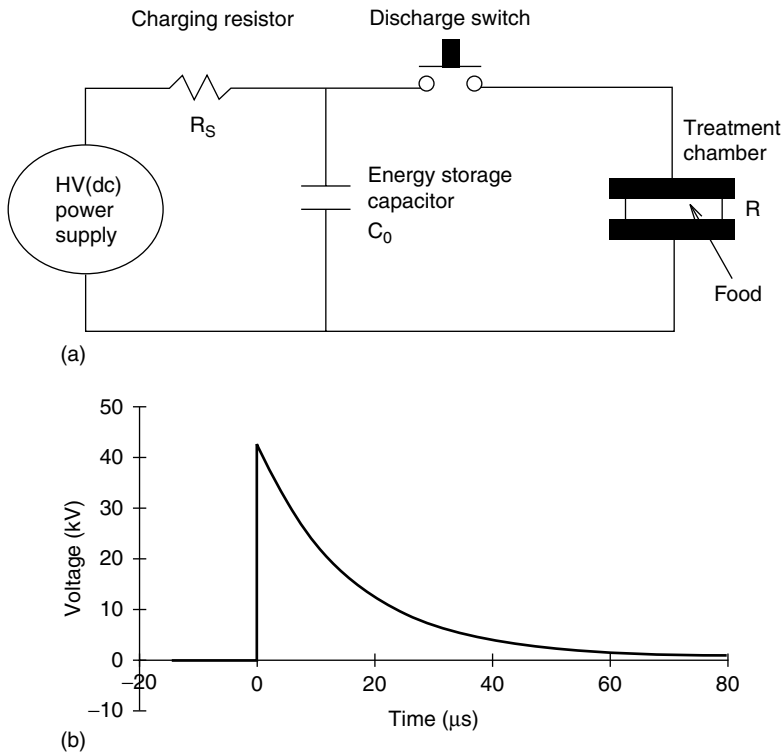
### 33.2.2 Lab-Scale Pulser

Exponential decay electric pulses could be generated by discharging a capacitor into a chamber containing the food (Figures 33.4 through 33.6). Current designs for power supplies are able to provide up to 40 kV. Capacitors of 5  $\mu\text{F}$  are used to store the electric energy that is discharged across metal electrodes, creating the electric field used to inactivate microorganisms and enzymes. A mercury ignitron spark gap may be used as the discharge switch. This type of unit may be employed for inactivation studies in a continuous mode. Pulsed voltage across the treatment chamber may be monitored by a resistance voltage divider. Electric current may be monitored by a Rogowski coil connected to a passive integrator. Both voltage and current waveforms may be monitored using a digital oscilloscope.

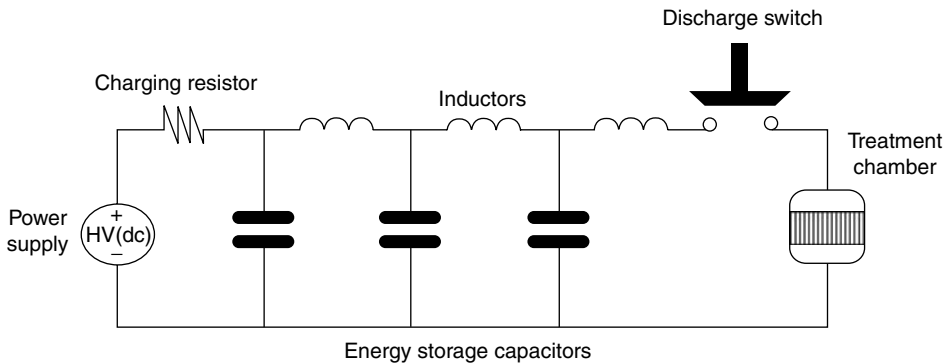
### 33.2.3 Treatment Chambers

A static PEF treatment chamber consists of two electrodes held in position by insulating materials that also form an enclosure containing food materials. Uniform electric fields can be achieved by parallel plate electrodes with a gap sufficiently smaller than the electrode surface dimension. Disk-shaped, round-edged electrodes can minimize electric field enhancement and reduce the possibility of dielectric breakdown of fluid foods. A continuous flow-through treatment chamber (Figure 33.7) was developed at Washington State University (WSU) to test the flow-through concept using low flow rates. The chamber consisted of two electrodes, a spacer, and two lids. Each electrode was made of stainless steel, whereas the spacer and lids were made of polysulfone. A flow channel was provided between the two electrodes to eliminate dead corners as well as to ensure uniform treatment.

The operating conditions for the parallel plate continuous chamber were as follows: chamber volume 20 or 8  $\text{cm}^3$  electrode gap 0.95 or 0.51 cm; PEF intensity 35 or 70 kV/cm; pulse width 2–15  $\mu\text{s}$ ; pulse rate 1 Hz; and food flow rate 1200 or 600  $\text{cm}^3/\text{min}$ . Cooling of the chamber was accomplished by circulating water at a selected temperature through jackets built into the two stainless steel electrodes. It should also be pointed out that a completely sealed treatment chamber is dangerous. When the test fluid experiences a spark, high pressure develops rapidly and the chamber may break apart.



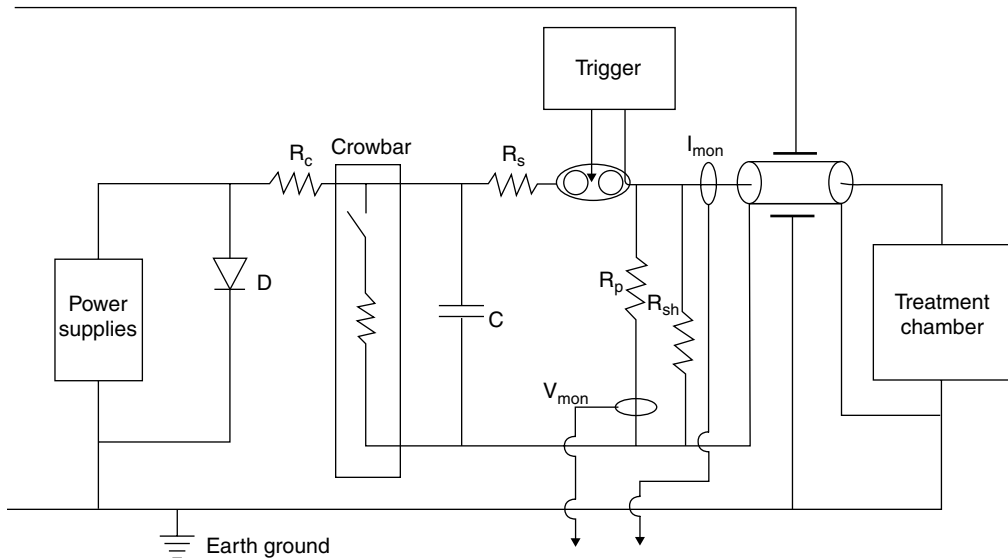
**FIGURE 33.4** (a) A simplified circuit for producing exponential decay pulses and (b) a voltage trace across the treatment chamber.



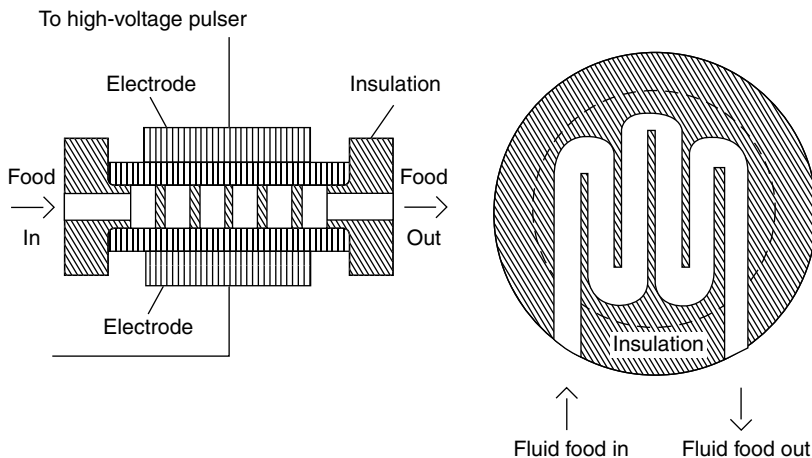
**FIGURE 33.5** Typical pulser configuration for high-intensity pulser electric fields.

A pressure-release device must be included in the treatment chamber design to ensure safety of the operation.

A coaxial treatment chamber (Figure 33.8) with a uniform field distribution along the fluid path was designed at WSU. The fluid is fed into the chamber through the bottom region and treated product exits at the top of the chamber. The protruded surface, located at the outer-grounded electrode, enhances and makes the electric field uniform within the treatment region while it reduces the field intensity in other regions of the fluid path. Cooling fluid is circulated to control the temperature between the inner high-voltage electrode and the outer-grounded electrode. The gap in the coaxial electrode or the liquid food thickness along the direction of the electric field can be selected by changing the diameter of the inner electrode.



**FIGURE 33.6** Current setup of the PEF facility at Washington State University. The pulser has a 16 kJ/s charging power supply, 40 kV peak charging voltage, and 10 Hz pulse repetition rate. C: storage capacitor; D: power supply protection diode;  $R_c$ : charging resistor;  $R_s$ : series resistor;  $R_{sh}$ : shunt resistor;  $R_p$ : voltage-measuring resistor;  $I_{mon}$ : current monitor;  $V_{mon}$ : voltage monitor.



**FIGURE 33.7** Schematic drawing of a flow-through treatment chamber. Fluid inside the chamber is baffled to avoid dead spots.

## 33.2.4 PEF Process Design

### 33.2.4.1 HACCP Principles and PEF Technology

The PEF process is summarized in Figure 33.9. The key operations are the receiving of raw materials, PEF treatment, aseptic packaging operation, and finished product storage and distribution. The following analysis [33] is based upon the seven principles of hazard analysis and critical control points (HACCP).

#### 33.2.4.1.1 Hazard Assessment

Microbial hazards are the main concern throughout the PEF operation. Raw materials contain spoilage microbes and pathogens that may spoil the ingredient or raw material or may be harmful to the consumer. Storage facilities for raw materials may increase the risk of microbial contamination from soil

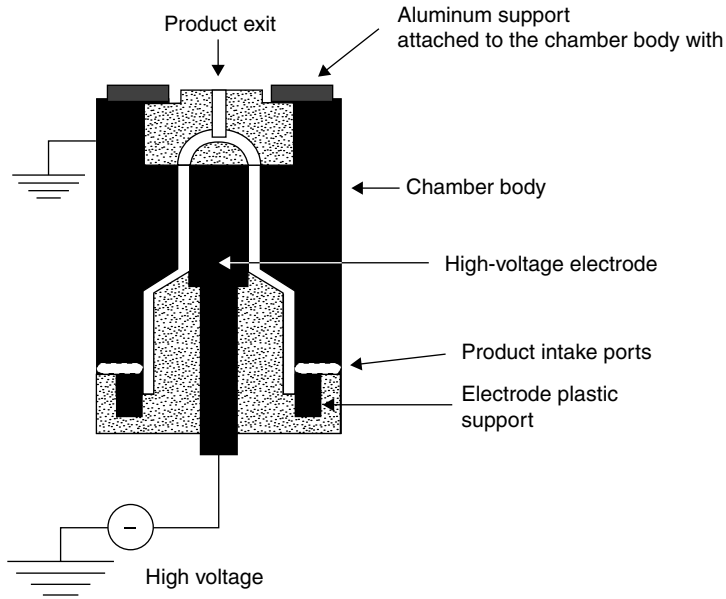


FIGURE 33.8 Schematic of the REF continuous treatment chamber.

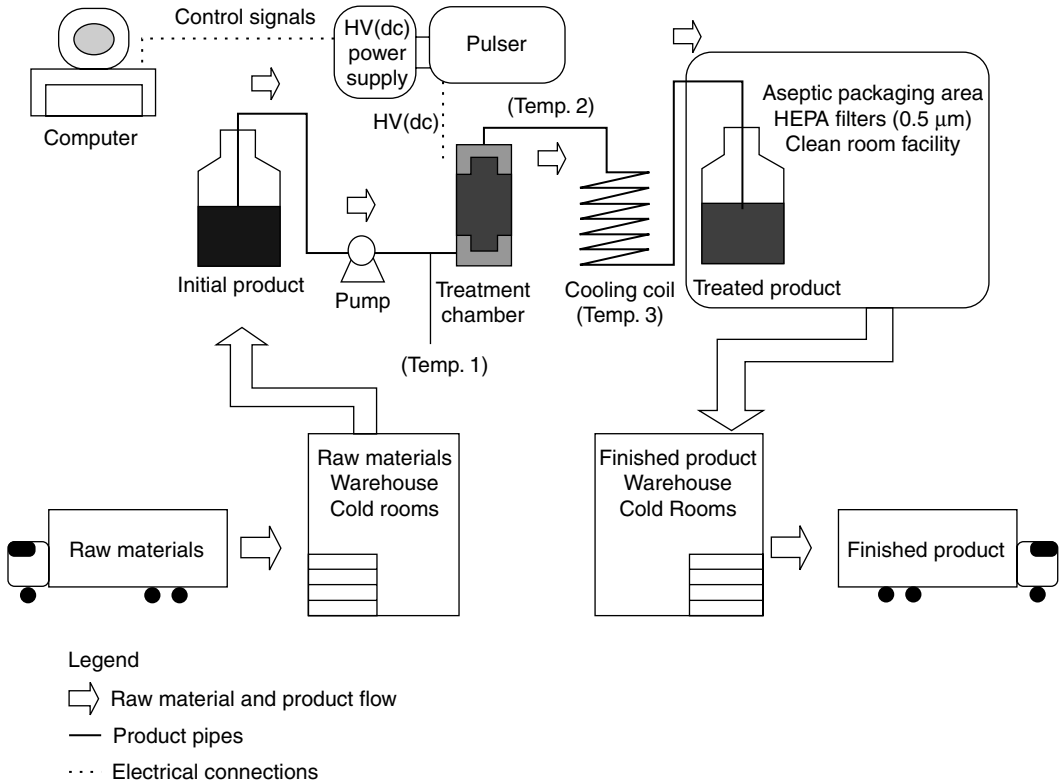


FIGURE 33.9 PEF unit operations layout.

and water deposits. The cleanliness of processing equipment plays a key role in preventing microbial contamination, thus the multiple assembly parts must always be properly sanitized. Inappropriate aseptic packaging operations and storage conditions may result in spoilage of the product.

The chemical hazards to consider are the presence of antibiotic and pesticide residuals on raw materials, electrically induced chemical reactions, and excessive detergent–sanitizer residues from processing and packaging equipment. Physical hazards include foreign matter in raw materials (e.g., stones, rubber, plastic, metal, and eggshells), metal particles from the treatment chamber after a spark, and plastic or rubber pieces from seals.

The final risk classification may be defined in terms of the product (milk, apple juice, eggs, soups, etc.). Six microbiological hazard characteristics, as well as chemical and physical hazard characteristics, are defined by the National Advisory Committee on the Microbiological Criteria for Foods (NACMCF) and will be used to classify PEF products. In general, the final hazard classification should occur between risk categories IV and VI as defined by the NACMCF.

#### 33.2.4.1.2 *Critical Control Points: Determination, Limits, Procedures, and Corrective Actions*

The following critical control points (CCPs) should be selected to ensure the safety of PEF products: receiving and storage section, PEF treatment section, and aseptic packaging section. The main factors considered and monitored for each CCP are handling and processing time, temperature of material, and cleanliness of equipment and utensils. The treatment conditions (electric field intensity, pulsing rate, input voltage, input current, and chamber temperature) should be monitored and recorded on a continuous basis. Uniform PEF treatment requires the design and construction of a pulser that accomplishes variable pulsing rates, charging rates, voltage settings, pulse widths, and pulse shapes. Pulser components such as power source, computerized controls, triggering mechanism, overloads, dummy loads, and treatment chamber should comply with defined specifications and characteristics such as maximum operating temperature, maximum voltage and current outputs, and reliability (mean time between failures, yields, etc.). The reliability of the pulser may be measured in terms of number of pulses with correct energy level per unit of time as well as total pulses per unit of time. Monitoring devices may include oscilloscopes for voltage and current measures, and pulse counters.

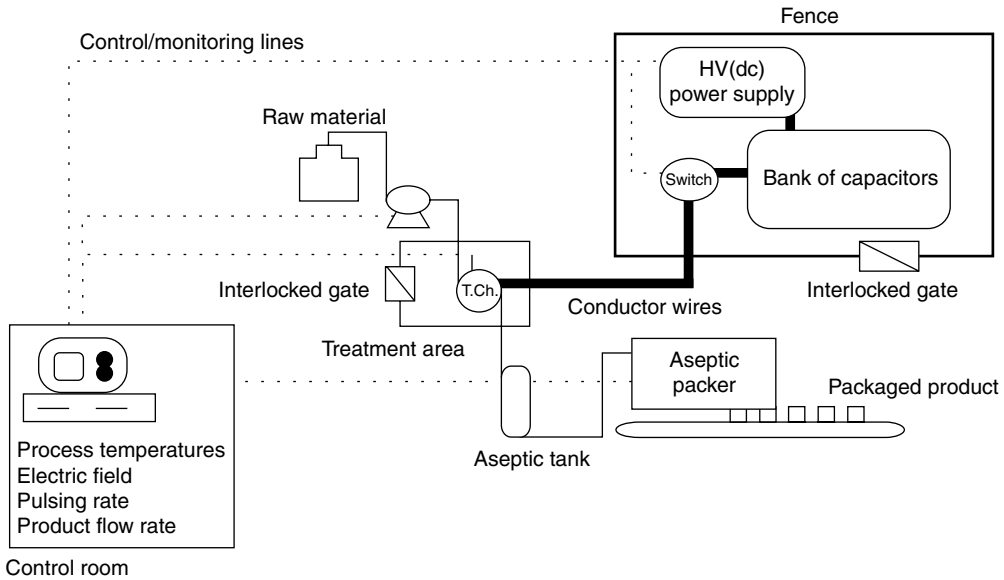
Standard operating procedures (SOPs) should be in place to define aspects such as reception, storage, and preparation of raw materials, to ensure proper handling and reduce the risk of contamination. The pulsing and packaging units must have procedures to specify the assembly and disassembly of the machinery. Cleaning specifications such as frequency and type of detergents and sanitizers to be used should be established to prevent contamination between products. The operational parameters for PEF treatments must be specified for each food product based upon its microbial risk, initial microbial counts, physical and chemical characteristics (e.g., pH, ionic strength, and composition), and the maximum time to complete the processing of each food (i.e., time from initial discharge of raw materials to the end of the packaging operation). Alternative procedures must define the corrective actions associated with deviations from process specifications or CCP limits. Quality assurance procedures must be developed for the approval or rejection of PEF-treated products based on the CCP limits and corrective actions.

#### 33.2.4.1.3 *Record Keeping*

Record keeping is a key aspect not only in a PEF operation, but also in any successful manufacturing operation. The status of raw materials, process and packaging sequence, as well as storage and shipping procedures, must be reflected in the batch or lot documents. Proper design of the documents is an important and difficult task because the documents must provide enough space for critical measurements without confusing the operator.

#### 33.2.4.2 *Hazard and Operability Study (HAZOP) Principles and PEF Technology*

The main concern of individuals working in a PEF facility is the voltage intensity, which reaches the kilovolt range. A typical pulser configuration is presented in Figure 33.10. A high-voltage power supply is selected to charge the capacitor (eventually more than one) and a discharge switch releases the stored electric energy from the capacitor through the product in the form of an electric field. The power supply, capacitor, and treatment chamber must be confined in a restricted access area with interlocked gates.



**FIGURE 33.10** Schematic diagram of a PEF equipment configuration.

The gates will turn off the pulser if they are opened while the power supply is on. Emergency switches must be accessible in case of a process failure. Also, discharging bars must be provided to discharge the elements in the circuit before maintenance or inspection of the unit occurs. To prevent the leakage of high voltage through any fluid (food or refrigerant) in contact with the treatment chamber, all connections to the chamber will be isolated and the pipes carrying materials to or from the chamber are connected to ground.

Electrical and mechanical devices such as pumps, computers, and packaging machines must be protected using safeguards. Proper warning signs must be in place regarding the safety hazards (high-voltage and high-intensity electric field) in the processing area. The information related to the operation and maintenance procedures must be contained in standard operating procedures (SOPs). The personnel involved in the PEF operation must be trained and instructed in these SOPs.

The selection of appropriate detergents and sanitizers must comply with the FDA and USDA/FSIS regulations or those of equivalent organizations in other countries. Proper protection devices such as face masks or goggles, aprons, boots, and gloves must be used by employees while applying and removing the cleaning solutions. A complete procedure must be in place to define what kind, when, where, and how to use the cleaning and sanitizing solutions. Proper record keeping is required to avoid contamination of the products with detergent or sanitizer solutions. A complete layout of the facility, including details about location of utilities, location of equipment, and emergency exits, must be available. Changes in the configuration of the facility must be reflected in the layout.

### 33.2.5 Currently Used PEF Technology

PurePulse Technologies Co., a subsidiary of Maxwell Laboratories in San Diego, CA, owns three U.S. patents to preserve fluid foods such as dairy products, fruit juices, and fluid eggs by treatment with high-intensity electric discharges from about 5 to 100 kV/cm with flat-topped exponentially decaying pulse shapes. Pulse duration is controlled to prevent electrical breakdown of the food product; the typical duration is between 1 and 100  $\mu$ s with repetition rates between 0.1 and 100 Hz [11,34]. The patents describe both a batch and continuous processing system and recommend that HIPEF treatments be applied to preheated liquid foods, which enhance microbial inactivation and shelf-life stability.

Dunn and Pearlman [11] reported more than five logarithmic cycles of microbial count reduction (5D reduction) of naturally occurring microorganisms in orange juice after 35 pulses of 100  $\mu$ s at a voltage intensity of 33.6–35.7 kV/cm and a process temperature of 42°C–65°C. The shelf life of orange juice was increased from 3 days to 1 week with no significant change in odor or taste. A 3D reduction of *E. coli*

(ATCC-10536) inoculated in homogenized and pasteurized milk exposed to 23 pulses of 100  $\mu$ s at 28.6–42.8 kV/cm was also reported. When a similar test run was carried out using milk seeded with *Salmonella dublin* prior to treatment with 36.7 kV/cm and 40 pulses of 100  $\mu$ s at 63°C, no *Salmonella* and only 20 cfu/mL of milk bacteria was found. These results may suggest that deactivation from the PEF treatment process is selective and that *S. dublin* are preferentially deactivated over the milk bacteria. Yogurt inoculated with *Streptococcus thermophilus*, *Lactobacillus bulgaricus*, and *Saccharomyces cerevisiae* was treated with 20–100  $\mu$ s pulses at 23–38 kV/cm at a process temperature of 63°C, resulting in a 2D reduction of the lactic acid bacteria and *S. cerevisiae* [11].

The *ELSTERIL* process, developed by Krupp Maschinentchnik GmbH (Hamburg, Germany) in the late 1980s and early 1990s, is used for the sterilization and pasteurization of liquid and electrically conductive media [13,35,36]. Krupp Maschinentchnik GmbH, in association with the University of Hamburg, reported microbial inactivation when PEF was applied to fluid foods such as orange juice and milk [36]. A microbial inactivation exceeding 4D has been found for *Lactobacillus brevis* inoculated in milk and treated with 20 pulses of 20 ps at 20 kV/cm, *S. cerevisiae* inoculated in orange juice and treated with 5 pulses of 20  $\mu$ s at 4.7 kV/cm, and *E. coli* inoculated in sodium alginate and treated with 5 pulses of 20  $\mu$ s at 14 kV/cm [35,36]. However, no inactivation of the endospores of *B. cereus* or the ascospores of *Bacillus nivea* was reported [36]. A substantial reduction in ascorbic acid and lipase activity was observed in milk treated with the *ESTERIL* process [36]. The taste of milk and orange juice did not significantly change after the electric field treatments [36].

The disruption of cell membranes to release fat from animal cells was conducted using a process called *ELCRACK* (Krupp Maschinenttechnik GmbH, Hamburg, Germany). The *ELCRACK* process consists of the exposure of a slurry of comminuted fish or slaughterhouse offal to high-intensity electric pulses that break down cells, leading to increased fat recovery during the separation step after it is pumped through one or more treatment chambers [35]. Washington State University has a patent for the design and development of a static PEF chamber and has filed another for the design and development of a continuous PEF chamber intended for processing liquid foods with PEF treatments [37–40].

---

### 33.3 Applications of PEF in Food Processing

The application of PEF as a food processing tool is gaining popularity, since it represents a nonthermal alternative to conventional pasteurization and sterilization methods. The PEF approach, which does not involve the use of added preservatives, is expected to be more appealing to consumers who are skeptical about the use of chemicals in foods. Furthermore, the PEF treatment, being a nonthermal process, may also have no significant detrimental effect on heat-labile components present in foods such as vitamins. The major disadvantage of PEF operation is the initial investment. A pilot plant-size pulser may cost around \$250,000. Other units for industrial use are available at prices that range from \$450,000 to \$2,000,000.

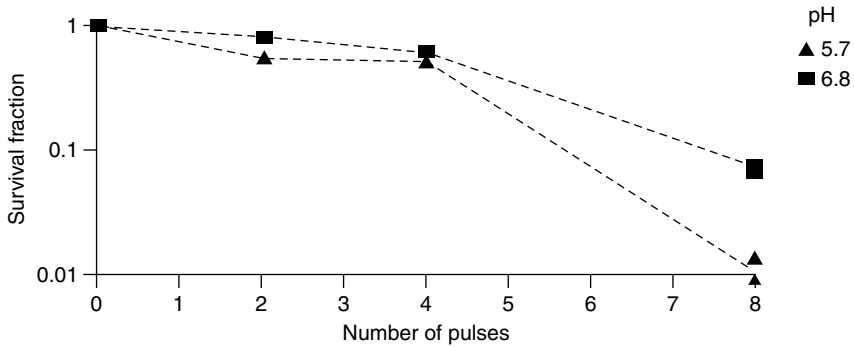
#### 33.3.1 Inactivation of Microorganisms

Raw and reconstituted apple juice, peach juice, skim milk, beaten eggs, and pea soup exposed to PEFs of 25–45 kV/cm were treated using the chamber designed at Washington State University. *E. coli* inoculated in skim milk and exposed to 60 pulses of 2  $\mu$ s width at 45 kV/cm and 35°C was reduced by 2D [25]. A reduction of 6D was observed in liquid egg inoculated with *E. coli* and treated with an electric field of 25.8 kV/cm and 100 pulses of 4  $\mu$ s at 37°C [41]. *E. coli* and *B. subtilis* inoculated in pea soup and exposed to PEFs of 25–33 kV/cm (10–30 pulses of 2  $\mu$ s) provided a limited inactivation (<1.5D) when the process temperature of pea soup was below 53°C, while microbial inactivation was 4.4D with process temperatures between 53°C and 55°C [26].

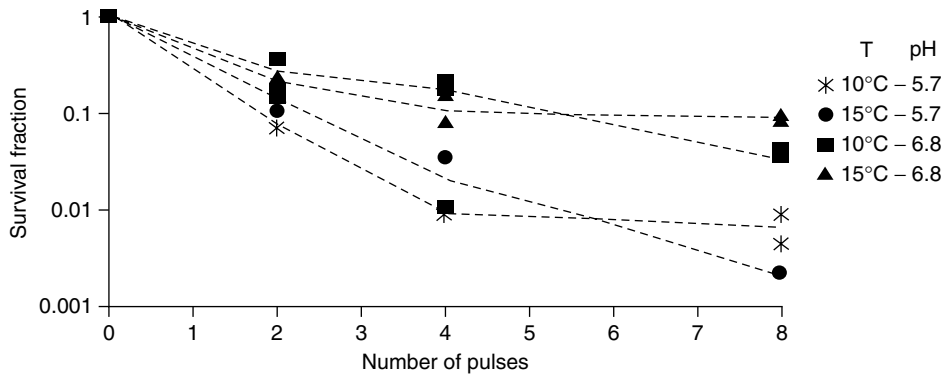
##### 33.3.1.1 Simulated Milk Ultrafiltrate (SMUF)

The inactivation of *E. coli* varied as a function of the electric field intensity, number of pulses, and pH. Low-field intensity (20 kV/cm) resulted in insignificant inactivation of microorganisms independent of temperature and pH ( $p > 0.05$ ). Meanwhile, inactivation of *E. coli* increased with an increase in the

number of pulses and an increase in the electric field from 40 to 55 kV/cm. The inactivation was more significant at pH 5.69 than at pH 6.82 ( $p < 0.05$ ) (Figures 33.11 and 33.12). The temperature effect (10°C or 15°C) on the inactivation for these experiments was not statistically significant ( $p > 0.05$ ). Table 33.2 summarizes the inactivation results after eight pulses for each of the experimental conditions.



**FIGURE 33.11** Inactivation of *E. coli* suspended in SMUF, using 40 kV/cm at 10°C, two samples per each experimental condition. (From H. Vega-Mercado et al., *Food Res. Int.* 29(2): 117, 1996.)



**FIGURE 33.12** Inactivation of *E. coli* suspended in SMUF, using 55 kV/cm, two samples per each experimental condition. (From H. Vega-Mercado et al., *Food Res. Int.* 29(2): 117, 1996.)

**TABLE 33.2**

Effect of Processing Parameters on the Inactivation of *E. coli* Suspended in SMUF after Eight Pulses

Description	pH	Number of Log Cycle Reduction	
		10°C	15°C
20 kV/cm	5.7	0.00 <sup>a</sup>	0.20 <sup>a</sup>
	6.8	0.00 <sup>a</sup>	0.06 <sup>a</sup>
	5.7	1.95 <sup>b</sup>	1.85 <sup>b</sup>
	6.8	1.16 <sup>c</sup>	1.00 <sup>c</sup>
	5.7	2.22 <sup>d</sup>	2.56 <sup>d</sup>
	6.8	1.45 <sup>c</sup>	1.10 <sup>c</sup>

Note: Log cycle reduction data with similar superscripts are not significantly different at  $\alpha=0.05$ , two samples per each experimental condition.

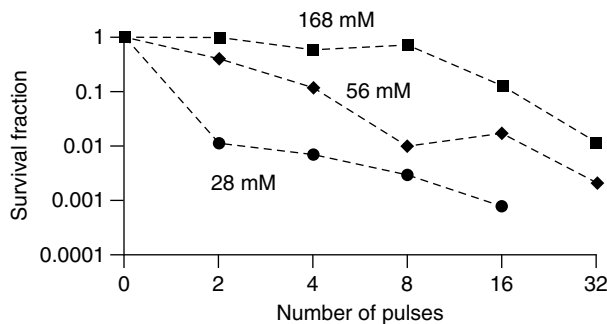
Source: H. Vega-Mercado et al., *Food Res. Int.* 29(2): 117 (1996).



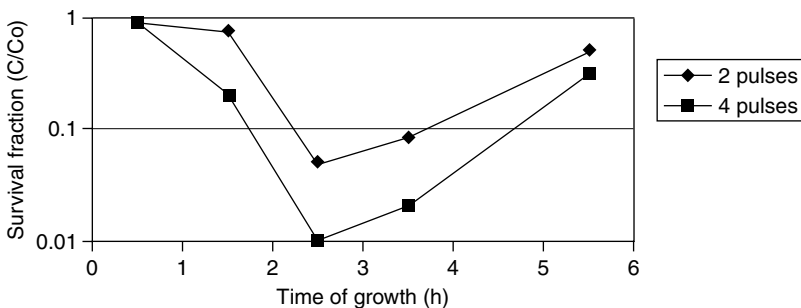
The role of pH in the survival of microorganisms is related to the ability of the organisms to maintain the cytoplasm pH near neutrality [42]. Membrane permeability increases due to formation of pores in the cell wall during PEF treatment [30] and the rate of transport of hydrogen ions may also increase due to the osmotic imbalance around the cell. Thus, a reduction in cytoplasm pH may be observed because a higher number of hydrogen ions are available than at a neutral pH. The change in pH within the cell may induce chemical modifications in fundamental compounds such as DNA or ATP, as discussed by Wiggins [43] and Dolowy [44]. Also, oxidation and reduction reactions such as those proposed by Gilliland and Speck [18] may occur within the cell structure induced by the PEF treatment.

The ionic strength of the solution also plays an important role in the inactivation of *E. coli*. An increase in the ionic strength increases the electron mobility through the solution, resulting in a decrease in the inactivation rate. The reduced inactivation rate in high-ionic-strength solutions can be explained by the stability of the cell membrane when exposed to a medium with several ions [30]. The effect of ionic strength can be observed in Figure 33.13, where a difference of 2.5 log cycles was obtained between the 0.168 and 0.028 M solutions.

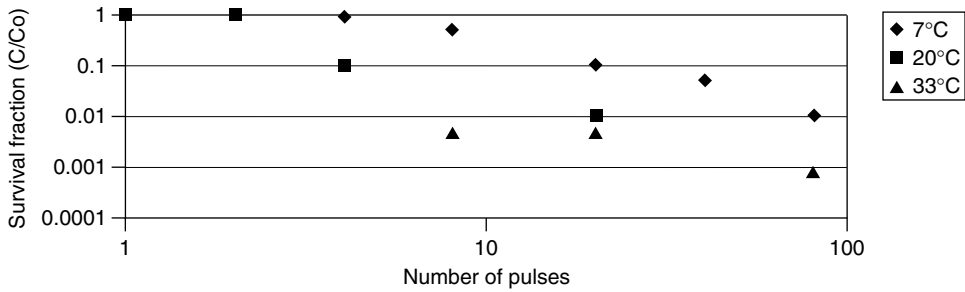
The growth stage of *E. coli* affected the effectiveness of PEF treatments (36 kV/cm at 7°C, two and four pulses). Cells in the logarithmic phase were most sensitive to the electric field treatments compared to cells in the stationary and lag phase (Figure 33.14) as reported by Pothakamury et al. [45]. Figures 33.15 and 33.16 present the effect of temperature on the log-cycle reduction of *E. coli* using exponentially decaying pulses and square wave pulses of 35 kV/cm. The rate of inactivation increases with an increase in the temperature. Coster and Zimmermann [46] suggested synergistic effects of high-intensity electric fields with moderate temperatures. The rate of inactivation increased when square wave pulses were used compared to exponentially decaying pulses. Similar results were reported for *S. aureus* when exposed to PEF at 9 and 16 kV/cm and *L. delbrueckii* and *B. subtilis* when exposed to 9, 12, and 16 kV/cm. Figures 33.17 through 33.19 present the reported results by Pothakamury et al. for *S. aureus*, *L. delbrueckii*, and *B. subtilis* suspended in SMUF.



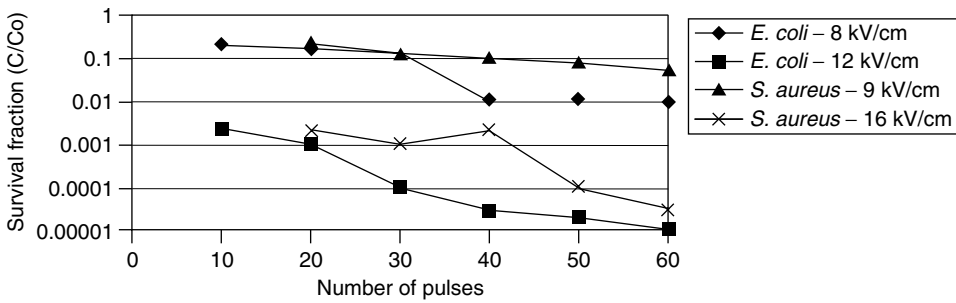
**FIGURE 33.13** Effect of ionic strength on the inactivation of *E. coli* suspended in SMUF, at 40 kV/cm and 10°C, two samples per each experimental conditions. (From H. Vega-Mercado et al., *Food Res. Int.* 29(2): 117, 1996.)



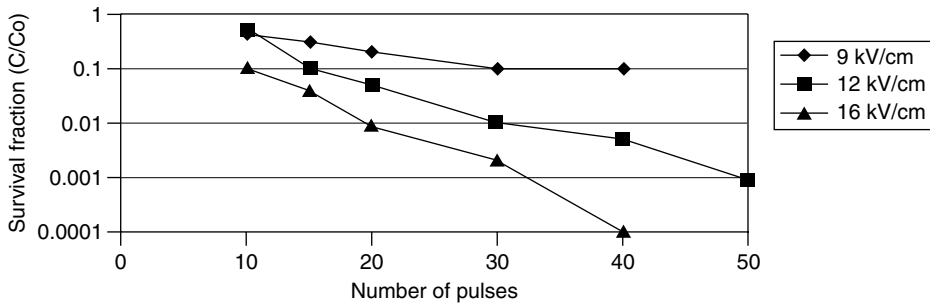
**FIGURE 33.14** Effect of growth stage on the PEF inactivation of *E. coli* suspended in SMUF. (From U. R. Pothakamury et al., *Food. Res. Int.* 28(2): 167, 1995.)



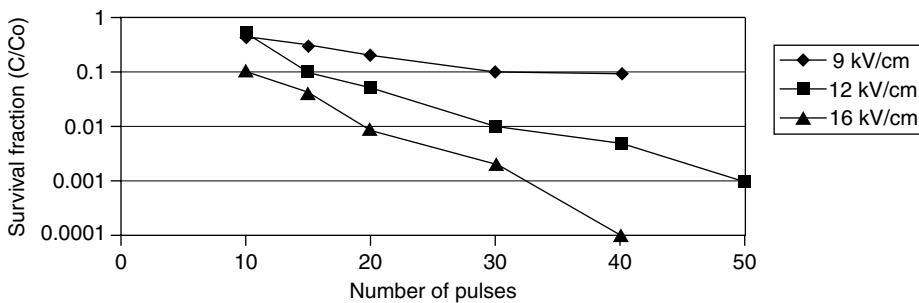
**FIGURE 33.15** Effect of temperature on PEF inactivation of *E. coli* suspended in SMUF, using exponential decay pulses. (From U. R. Pothakamury et al., *Food. Res. Int.* 28(2): 167, 1995.)



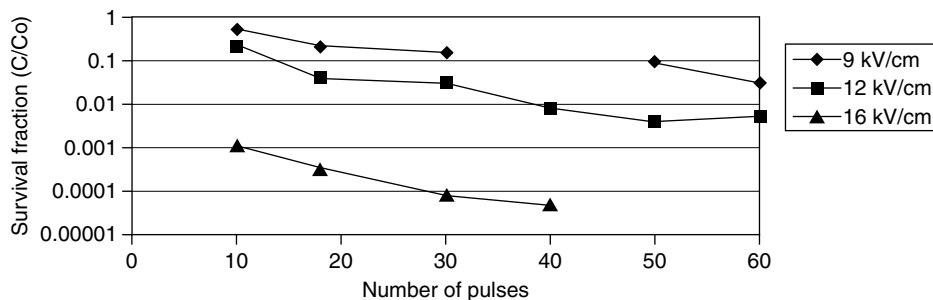
**FIGURE 33.16** Effect of temperature on PEF inactivation of *E. coli* suspended in SMUF, using square wave pulses. (From U. R. Pothakamury et al., *Food. Res. Int.* 28(2): 167, 1995.)



**FIGURE 33.17** Inactivation of *E. coli* and *S. aureus* in SMUF by REF. Simplified circuit for exponential decay pulse generation and voltage trace of an exponential decay pulse. (From U. R. Pothakamury et al., *Span. J. Food Sci. Technol.* 35(1): 101, 1995.)



**FIGURE 33.18** Inactivation of *L. delbrueckii* suspended in SMUF. (From U. R. Pothakamury et al., *Span. J. Food Sci. Technol.* 35(1): 101, 1995.)



**FIGURE 33.19** Inactivation of *B. subtilis* suspended in SMUF. (From U. R. Pothakamury et al., *Span. J. Food Sci. Technol.* 35(1): 101, 1995.)

**TABLE 33.3**

Inactivation of an *E. coli*-*B. subtilis* Mixture Suspended in Pea Soup Using PEF

Flow Rate Frequency	Number of Pulses	28 kV/cm		30 kV/cm	
		Process Temperature	Log Reduction (D)	Process Temperature	Log Reduction (D)
0.5 L/min	15	43	0.7	55	2.3
4.3 Hz	30	39	1.6	55	4.0
0.7 L/min	15	41	0.7	53	4.4
6.7 Hz	30	41	0.7	55	4.8
0.75 L/min	10	32	0.8	41	1.1
4.3 Hz	20	31	1.0	42	1.0

Source: H. Vega-Mercado et al., *J. Food Proc. Pres.* 20(6): 501 (1996).

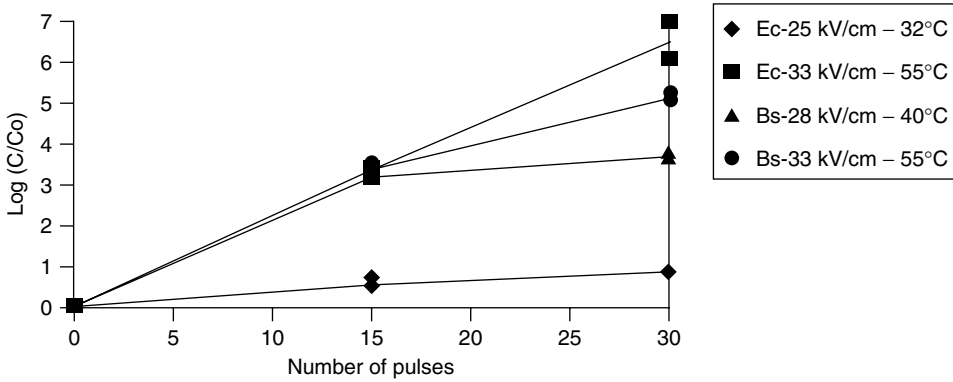
### 33.3.1.2 Pea Soup

PEF inactivation of *E. coli* and *B. subtilis* suspended in pea soup depends on the electric field intensity, number of pulses, pulsing rate, and flow rate [49] (Table 33.3). The maximum bulk temperature of the pea soup achieved during the PEF treatment was 55°C and is a function of both flow rate and pulsing rate. PEF treatments with a bulk temperature below 53°C resulted in limited microbial inactivation (<1.64D). Microbial inactivation dependence on process temperature may be explained by changes in the sensitivity of the microorganisms to PEF when the temperature exceeds 53°C. Thermal inactivation of microorganisms was avoided by cooling treated pea soup to 20°C. Thermal inactivation of *E. coli* requires up to 10 min at 61°C when suspended in bouillon [50].

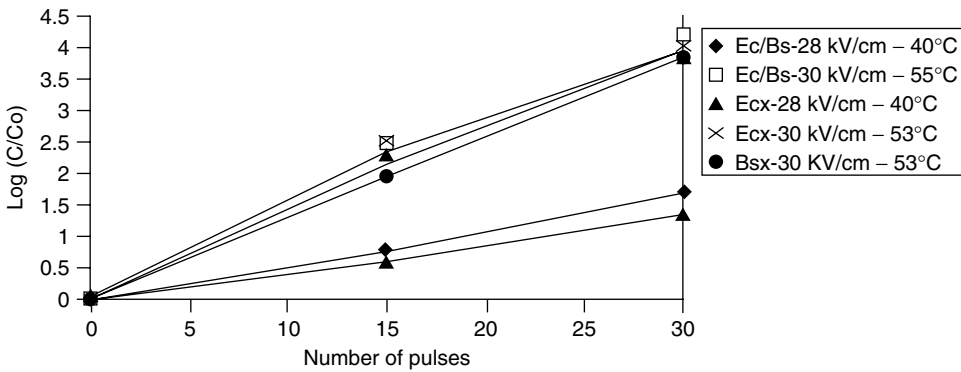
PEF inactivation of *B. subtilis* and *E. coli* decreased almost 2D when the microorganisms were mixed together in pea soup. Figures 33.20 through 33.22 summarize the inactivation of *E. coli*, *B. subtilis*, and the mixture of organisms suspended in pea soup and exposed to selected treatment conditions [49]. There is a significant difference in the inactivation levels ( $p < 0.05$ ) between *E. coli* alone and *E. coli* mixed with *B. subtilis*. PEF inactivation of *E. coli* alone reached 6.5D after 30 pulses at 30 kV/cm and flow rate of 0.5 L/mm, while an inactivation of 4.0D was observed when *E. coli* was mixed with *B. subtilis*. *B. subtilis* alone had 5.0D when exposed to 33 kV/cm at 4.3 Hz and 0.5 L/mm, while only 2.0D were observed when mixed with *E. coli* and exposed to 20 pulses at 30 kV/cm, 4.3 Hz and 0.75 L/mm or 3.5D after 30 pulses. The results for the inactivation of *E. coli* and *B. subtilis* using PEF demonstrate the feasibility of the technology for preservation of foods containing suspended particles and gelatinized starch.

### 33.3.1.3 Liquid Eggs

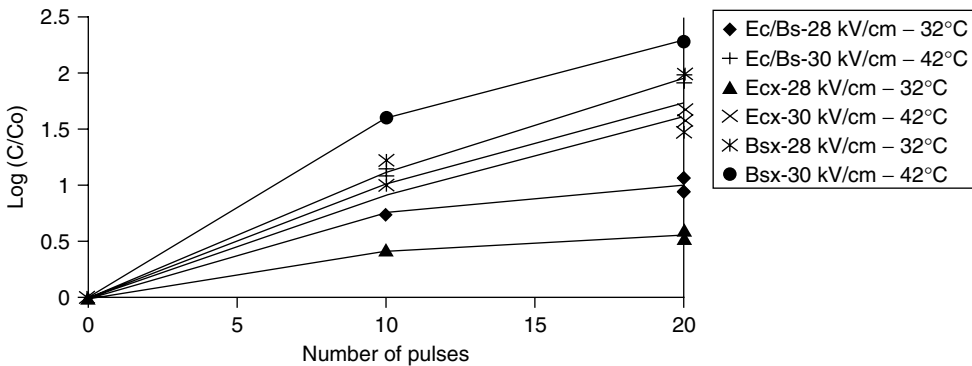
High-intensity PEF (26 kV/cm) treatment in continuous flow systems (continuous recirculation and simple pass) inactivates *E. coli* inoculated in liquid egg 6D with a peak processing temperature of  $37.2 \pm 1.5^\circ\text{C}$



**FIGURE 33.20** Inactivation of microorganisms suspended in pea soup using PEF at 0.5 L/min and 4.3 Hz (Ec: *E. coli*; Bs: *B. subtilis*). (From H. Vega-Mercado et al., *J. Food Proc. Pres.* 20(6): 501, 1996.)



**FIGURE 33.21** Inactivation of mixture of microorganisms suspended in pea soup using PEF at 0.5 L/min and 4.3 Hz (Ec: *E. coli*; Bs: *B. subtilis*; Ec/Bs: the overall inactivation for the mixture of microorganisms; Ecx: the inactivation of *E. coli* in the mixtures; Bsx: inactivation of *B. subtilis* in the mixture). (From H. Vega-Mercado et al., *J. Food Proc. Pres.* 20(6): 501, 1996.)



**FIGURE 33.22** Inactivation of mixture of microorganisms suspended in pea soup using PEF at 0.75 L/min and 4.3 Hz (Ec: *E. coli*; Bs: *B. subtilis*; Ec/Bs: the overall inactivation for the mixture of microorganisms; Ecx: the inactivation of *E. coli* in the mixture; Bsx: the inactivation of *B. subtilis* in the mixture). (From H. Vega-Mercado et al., *J. Food Proc. Pres.* 20(6): 501, 1996.)

(Table 33.4 and Figures 33.23 and 33.24). PEF treatments with 4  $\mu\text{s}$  pulses were more effective than 2  $\mu\text{s}$  pulses (Figures 33.25 and 33.26), which may be explained by the amount of energy applied to the liquid egg [41]. Figure 33.27 illustrates the effect of energy input in the inactivation of *E. coli*, with energy input (in Joules) calculated as follows:

$$\frac{\text{Energy}}{\text{Pulse}} = 0.5CV^2$$

where  $C$  is the capacitance, 0.5  $\mu\text{F}$  for 2  $\mu\text{s}$  pulses and 1.0  $\mu\text{F}$  for 4  $\mu\text{s}$  pulses, and  $V$  the measured potential across the treatment chamber (15.6 kV). The total energy input (in Joules) after  $n$  pulses is calculated by:

$$\text{Total energy} = n * \text{energy/pulse}$$

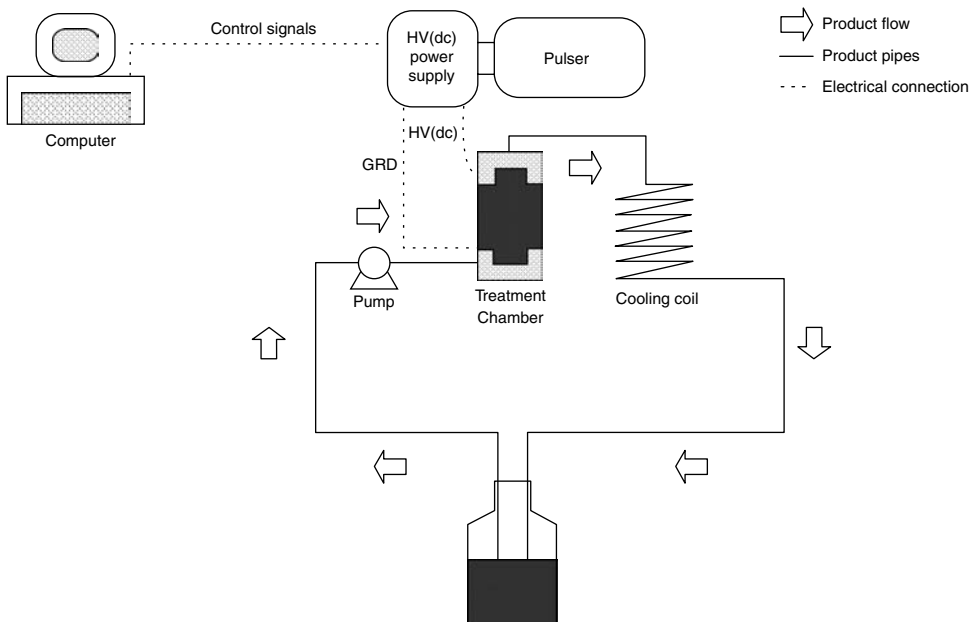
The survival fraction of *E. coli* in liquid egg is reduced almost 6D with 12,000 J applied in pulses of 4  $\mu\text{s}$  (Figure 33.26). Grahl et al. [36] nearly reached 5D by exposing *E. coli* suspended in sodium alginate to an electric field of 14 kV/cm with five pulses of 20  $\mu\text{s}$ . Zhang et al. [51] observed a 6D reduction in

**TABLE 33.4**

Treatment Conditions for Liquid Egg Exposed to PEF

Description	Operating Conditions	
	Treatment 1	Treatment 2
Pulse duration ( $\mu\text{s}$ )	2	4
Capacitance ( $\mu\text{F}$ )	0.5	1
Input voltage (kV)	40	30
Input flow rate (L/min)	0.5	0.5
Input pulse rate (Hz)	1.25, 2.5	1.25, 2.5
Peak voltage (kV)	15.5	15.5
Peak current (kA)	8.0	8.0
Electric field intensity (kV/cm)	26	26
Pulse energy (J)	60	120
Maximum temperature ( $^{\circ}\text{C}$ )	37	37

Source: O. Martin et al., *J. Food Proc. Pres.* 21: 193 (1997).



**FIGURE 33.23** Continuous recirculation PEF operation.

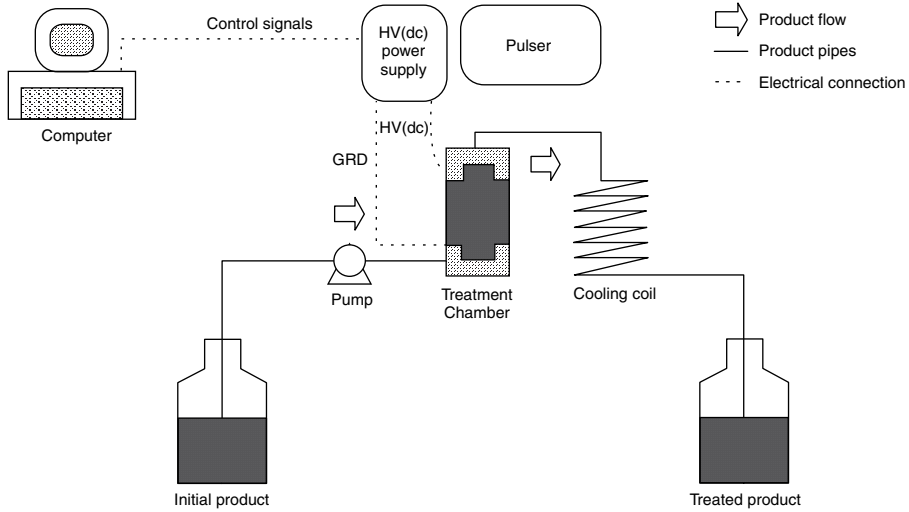


FIGURE 33.24 Single-pass PEF operation.

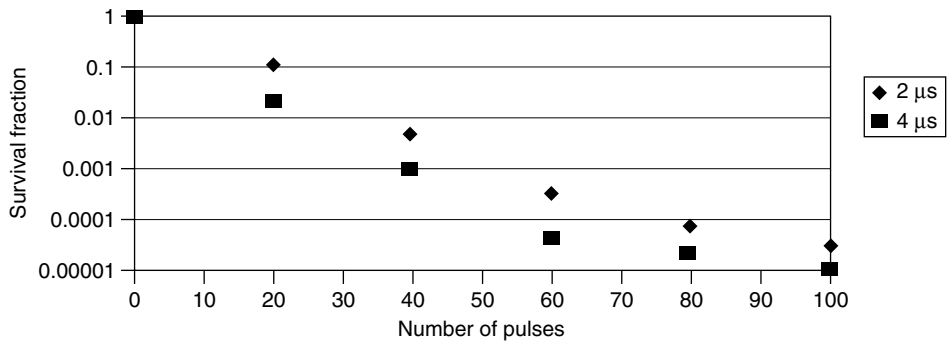


FIGURE 33.25 *E. coli* in liquid egg after PEF treatment at 26 kV/cm and 37°C in a continuous recirculation system. (From O. Martin et al., *J. Food Proc. Pres.* 21: 193, 1997.)

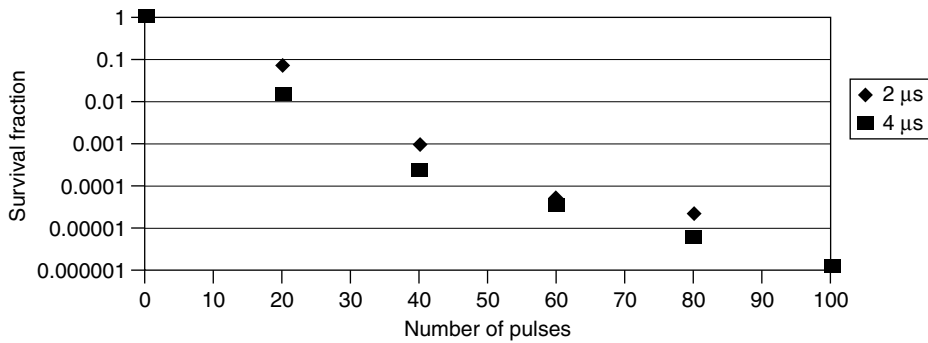
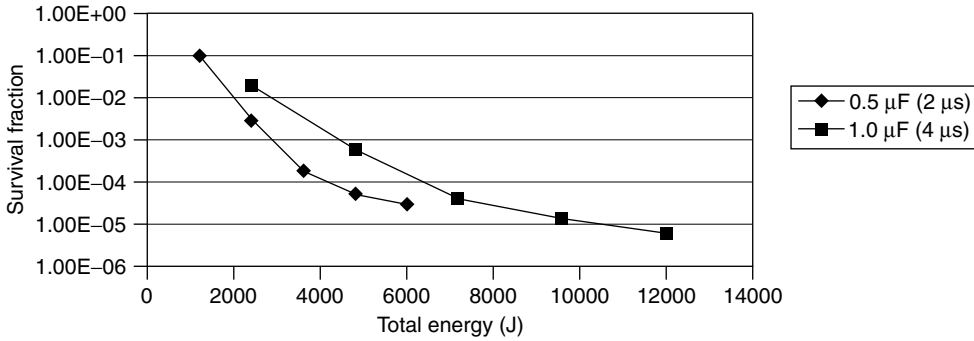


FIGURE 33.26 *E. coli* in liquid egg after PEF treatment at 26 kV/cm and 37°C in a stepwise system. (From O. Martin et al., *J. Food Proc. Pres.* 21: 193, 1997.)



**FIGURE 33.27** *E. coli* in liquid egg after PEF treatment at 26 kV/cm and 37°C as a function of input energy. (From O. Martin et al., *J. Food Proc. Pres.* 21: 193, 1997.)

*E. coli* suspended in potato dextrose agar and exposed to 64 pulses of 40 kV/cm at 15°C and a 9D reduction using 70 kV/cm and *E. coli* suspended in SMUF [52].

Proteins, an important nutrient for microbial growth, diminished the effectiveness of the PEF treatment [18,53]. The inactivation of microorganisms using PEF is more difficult in food materials than in buffer solutions [51]. In general, the bactericidal effect of PEF is inversely proportional to the ionic strength and increases with electric resistivity [5,26]. The electric resistance of liquid egg (1.9 Ω) is low compared to other foods and makes necessary the exposure of liquid egg to a large number (100) of pulses.

There was no significant difference ( $p > 0.05$ ) in the effectiveness of PEF treatment when the pulse rate varied from 1.25 to 2.50 Hz, as the inactivation of *E. coli* in liquid egg was at least 4D if the number of pulses and pulse width remained constant. There was also no significant difference ( $p > 0.05$ ) between the inactivation of *E. coli* using continuous recirculation or stepwise treatments.

### 33.3.1.4 Apple Juice

Commercial apple juice ultrafiltered and exposed to different PEF treatments showed no changes in pH, acidity, vitamin C, glucose, fructose, and sucrose content [54] as summarized in Table 33.5. The inactivation of *S. cerevisiae* suspended in apple juice is affected by the intensity of the electric field, treatment time, and number of pulses [55,56]. Figure 33.28 illustrates the microbial count of *S. cerevisiae* as a function of peak field intensity when two pulses were used and the selected field intensities were 13, 22, 35, and 50 kV/cm. The rate of inactivation increases with an increase in field intensity [56]. Microbial inactivation is a function of the number of pulses as illustrated in Figure 33.29. An inactivation of 6D is reported after 10 pulses of 35 kV/cm at 22°C–34°C. The shelf life of PEF-treated apple juice increases over 3 weeks when stored at either 4°C or 25°C as illustrated in Figure 33.30.

### 33.3.1.5 Skim Milk

#### 33.3.1.5.1 Treatment in a Static Chamber System

PEF treatment inactivates *E. coli* in skim milk at 15°C. The principal parameters influencing the microbial inactivation are the applied electric field intensity and treatment time, which can be expressed by the number of pulses ( $n$ ) when the width of each pulse is fixed [15]. The *E. coli* survival fraction decreases when milk is treated with an increasing number of pulses at a constant field intensity (Figure 33.31). The rate of inactivation of *E. coli* increases with an increase in the electric field intensity at a constant number of pulses (Figure 33.32). Less than 1 log reduction in *E. coli* population was observed for PEF treatments of 20, 25, and 30 kV/cm and 64 pulses at 15°C. However, PEF treatments at 45 kV/cm, 64 pulses, and 15°C lead to a nearly 3 log cycle reduction [57]. The reported results are consistent with those of Dunn and Pearlman [11], but these authors mentioned that the treatment temperature increased up to 43°C.

Similar *E. coli* inactivation was obtained with 20 kV/cm PEF in saline solution [58]. Hulsheger et al. [21] reduced the population of 4 log cycles by applying 20 kV/cm PEF for *E. coli* inoculated in phosphate buffer, and Grahl et al. [36] reached a nearly 5 log cycle reduction by treating *E. coli*

TABLE 33.5

Apple Juice Chemical Properties before and after PEF

Sample	pH	Acidity (Malic Acid)	Vitamin C (mg/100 g)	Glucose	Fructose	Sucrose
Control	4.10 ± 0.02	2.63 ± 0.02	1.15 ± 0.01	2.91 ± 0.33	4.95 ± 0.64	2.18 ± 0.25
PEF-T1	4.36 ± 0.03	2.67 ± 0.02	1.02 ± 0.02	2.87 ± 0.06	4.96 ± 0.11	2.25 ± 0.06
REF-T2	4.18 ± 0.01	2.75 ± 0.07	1.12 ± 0.00	3.01 ± 0.34	5.08 ± 0.67	2.21 ± 0.31
REF-T3	4.09 ± 0.01	2.63 ± 0.02	1.02 ± 0.00	2.90 ± 0.09	4.89 ± 0.13	2.13 ± 0.06
REF-T4	4.23 ± 0.01	2.61 ± 0.00	1.15 ± 0.24	2.57 ± 0.25	4.33 ± 0.47	2.43 ± 0.13

Note: The data presented are average values of two experiments each carried out in duplicate.

Source: M. V. Simpson et al., Influence of PEF on the composition of apple juice, Internal Report, Washington State University, Pullman, WA, 1995.

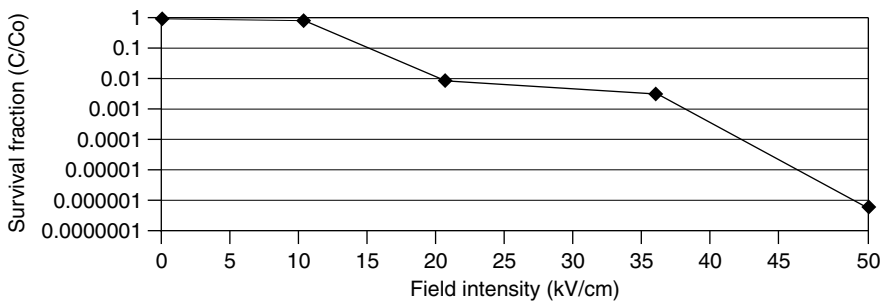


FIGURE 33.28 Survival fraction of *S. cerevisiae* as a function of peak field intensity when two 2.5 μs pulses were applied. (From B. L. Qin et al., *Proceedings of IEEE/IAS Meeting*, Orlando, FL, October 1995.)

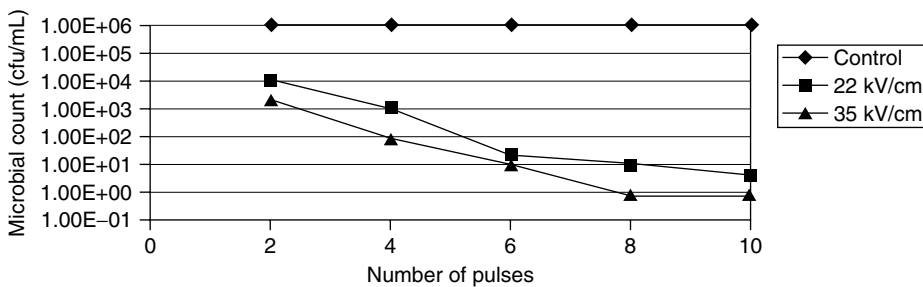


FIGURE 33.29 Microbiological count of *S. cerevisiae* in apple juice as a function of the number of 2.5 μs pulses. (From B. L. Qin et al., *Proceedings of IEEE/IAS Meeting*, Orlando, FL, October 1995.)

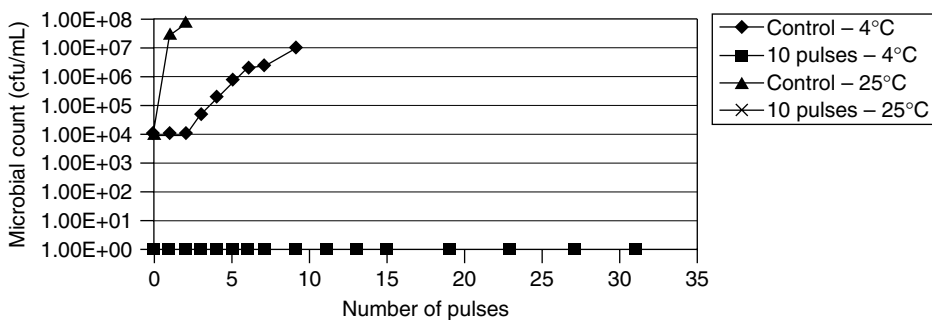
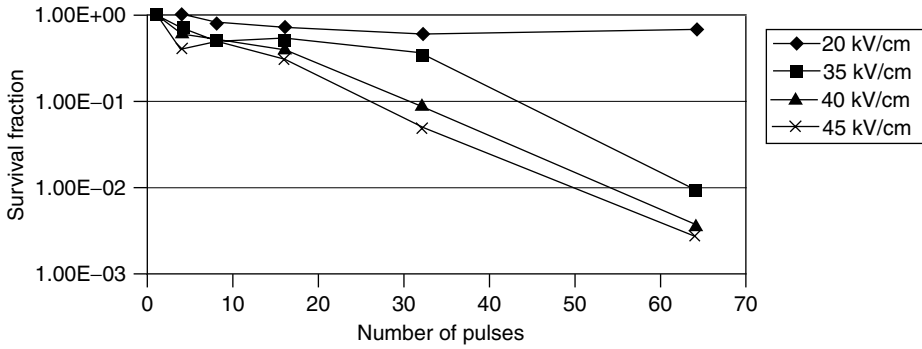
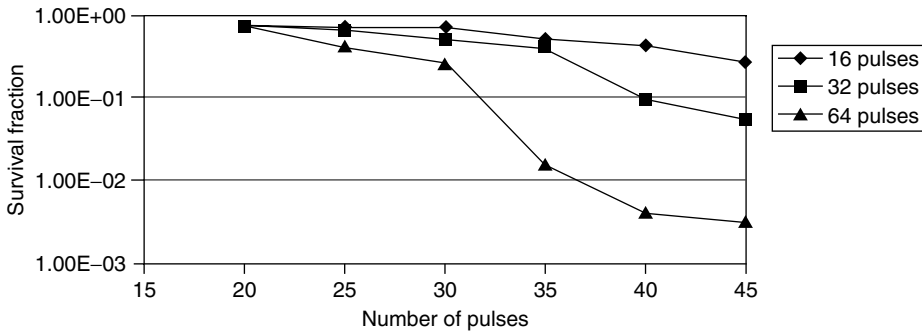


FIGURE 33.30 Shelf life of apple juice after PEF treatment of 10 2.5 μs pulses at 36 kV/cm. (From B. L. Qin et al., *Proceedings of IEEE/IAS Meeting*, Orlando, FL, October 1995.)





**FIGURE 33.31** Inactivation of *E. coli* in skim milk at 15°C in a static chamber at several field intensities. (From O. Martin et al., *J. Food. Proc. Eng.*, 20: 317–336, 1997.)



**FIGURE 33.32** Inactivation of *E. coli* in skim milk at 15°C in a static chamber with different number of pulses. (From O. Martin et al., *J. Food. Proc. Eng.*, 20: 317–336, 1997.)

**TABLE 33.6**

Kinetics Constant of Hulsheger’s Model for *E. coli* Inactivation in Skim Milk by PEF<sup>a</sup>

Electric Field Intensity (kV/cm)	Number of Pulses (n)	$n_{min}$	$E_c$ (kV/cm)	$K$ (kV/cm)	$R^2$
35	<64	15.2	—	5.6	0.829
40	<64	13.0	—	6.1	0.958
45	<64	11.0	—	8.0	0.985
<45	16	—	18.7	2.9	0.833
<45	32	—	20.4	3.9	0.861
<45	64	—	19.9	2.7	0.924

Note:  $R^2$ =correlation coefficient for regression analysis ( $p=0.05$ ).

<sup>a</sup>Treatment in astatic chamber.

Source: O. Martin et al., *J. Food Proc. Eng.*, 20: 317–336, 1997.

suspended in sodium alginate solution with 26 kV/cm PEF. The inactivation of *E. coli* in potato dextrose agar by applying 64 pulses of 40 kV/cm at 15°C resulted in a 6 log cycle reduction. Notice that PEF inactivation kinetics in semisolid products are different from the PEF inactivation kinetics in fluids because *E. coli* cells are fixed in a gel matrix, which increases uniformity of inactivation [51]. Inactivation of *E. coli* in skim milk by PEF treatment in a static chamber satisfied Hulsheger’s model (Table 33.6) because the destruction of this microorganism in skim milk followed a first-order kinetic for both the electric field intensity and the number of pulses.

Martin et al. [57] reported that the minimum number of pulses ( $n_{min}$ ) necessary to inactivate the microorganisms in skim milk at 45 kV/cm using a static chamber is 11 and 15 pulses at 35 kV/cm, respectively. The critical electric field ( $E_c$ ) is 19.9 kV/cm with 64 pulses at 45 kV/cm, which is higher than the value reported by Grahl et al [36] for *E. coli* suspended in sodium alginate solution (14 kV/cm). Zhang et al. [51] calculated 17.5 kV/cm  $E_c$  for *E. coli* in semisolid model foods.

It is more difficult to reduce the survival fraction of microorganisms present in skim milk than in buffer solutions and model foods because the composition of skim milk is complex (i.e., high protein content 33–40 g/L) [59]. These substances diminish the lethal effect of PEF in microorganisms because they absorb free radicals and ions, which are active in the breakdown of cells [18,53]. Moreover, the inactivation of bacteria by PEF is a function of solution resistance, which is inversely proportional to ionic strength. Survival fractions decrease when medium resistance increases and ionic strength decreases [26,60]. The measured resistivity of skim milk is 310  $\Omega$  cm and that of buffer solutions is even higher. Since dilution of milk increases the resistivity and decreases protein concentration, the effectiveness of PEF treatment is improved. The inactivation rate of *E. coli* suspended in skim milk/water (1:2.3) and exposed to 40 kV/cm in a static chamber at 15°C is higher than when less diluted skim milk (1:1) is used (Figure 33.33).

33.3.1.5.2 Treatment in a Continuous System

PEF treatment in a continuous flow chamber also inactivates *E. coli* inoculated in skim milk. An increase in field intensity or number of pulses produces greater bacterial inactivation (Figures 33.34 and 33.35) and microorganism death follows first-order kinetics with both field intensity and number of pulses

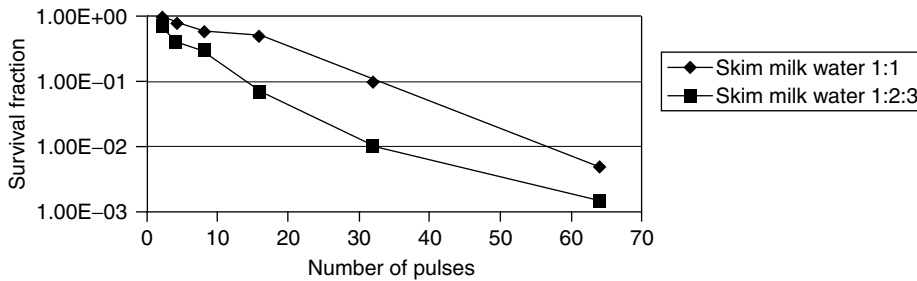


FIGURE 33.33 Effect of skim milk dilution in the inactivation of *E. coli* by 35 kV/cm PEF treatment in a static chamber at 15°C. (From O. Martin et al., *J. Food. Proc. Eng.*, 20: 317–336, 1997.)

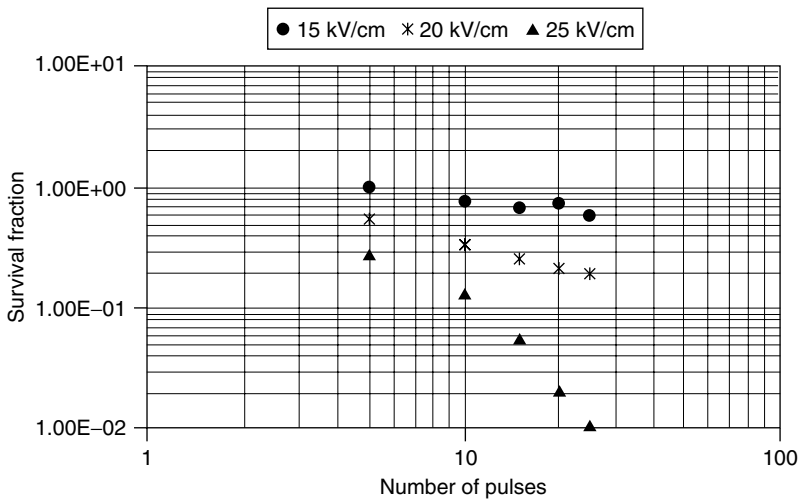
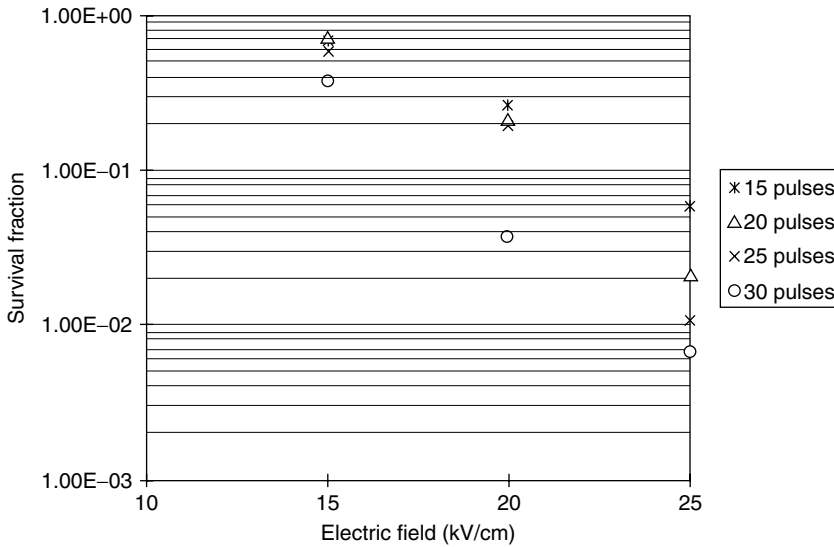


FIGURE 33.34 Inactivation of *E. coli* in skim milk at 15°C in a continuous chamber at different intensities. (From O. Martin et al., *J. Food. Proc. Eng.*, 20: 317–336, 1997.)



**FIGURE 33.35** Inactivation of *E. coli* in skim milk at 15°C in a continuous chamber with different number of 1.8 ms pulses. (From O. Martin et al., *J. Food. Proc. Eng.*, 20: 317–336, 1997.)

**TABLE 33.7**

Kinetics Constant of Hulsheger's Model for *E. coli* Inactivation in Skim Milk by PEF<sup>a</sup>

Electric Field Intensity (kV/cm)	Number of Pulses ( <i>n</i> )	<i>n</i> <sub>min</sub>	<i>E</i> <sub>c</sub> (kV/cm)	<i>K</i> (kV/cm)	<i>R</i> <sup>2</sup>
15	<30	5.4	—	3.9	0.918
20	<30	1.9	—	9.5	0.997
25	<30	2.7	—	5.8	0.955
<30	15	—	13.82	4.3	0.985
<30	20	—	14.62	2.2	0.968
<30	25	—	14.44	2.2	0.938
<30	30	—	12.34	3.5	0.992

Note: *R*<sup>2</sup>=correlation coefficient for regression analysis (*p*=0.05).

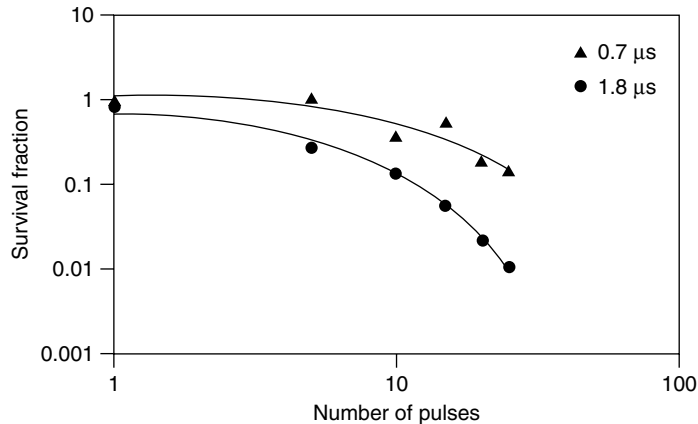
<sup>a</sup>Treatment in astatic chamber.

Source: O. Martin et al., *J. Food. Proc. Eng.*, 20: 317–336, 1997.

(Table 33.7). The *E*<sub>c</sub> when PEF treatment was carried out in a continuous system at 30 kV/cm maximum electric field intensity was between 12.34 and 14.62 kV/cm, and *n*<sub>min</sub> ranged from 1.9 to 5.4 pulses. These values were lower than those obtained in the same treated product using the static system.

In general, PEF treatment in continuous systems is more effective in terms of microorganism inactivation than in static systems due to the treatment uniformity being greater. Moreover, in this study even though both chambers are of the parallel plate type, the treatment volume in a static chamber is higher (14.5 mL) than the continuous flow chamber (8 mL). Therefore, the energy density (defined as energy divided by volume) is higher in continuous systems.

The effectiveness of PEF treatment also depends on pulse duration, which increases the *E. coli* inactivation because the energy applied in each pulse is higher. Applying 25 pulses of 0.7 μs each at 25 kV/cm in a continuous flow chamber reduces the survival fraction of *E. coli* inoculated in skim milk less than 1 log cycle, but a treatment in the same chamber with the same number of pulses and field intensity and a 1.8 μs duration pulse reduces the survival fraction by more than 2 log cycles (Figure 33.36).



**FIGURE 33.36** Effect of pulse duration in the inactivation of *E. coli* in skim milk at 15°C by 25 kV/cm PEF treatment in a continuous chamber. (From O. Martin et al., *J. Food. Proc. Eng.*, 20: 317–336, 1997.)

### 33.3.2 Denaturation of Proteins

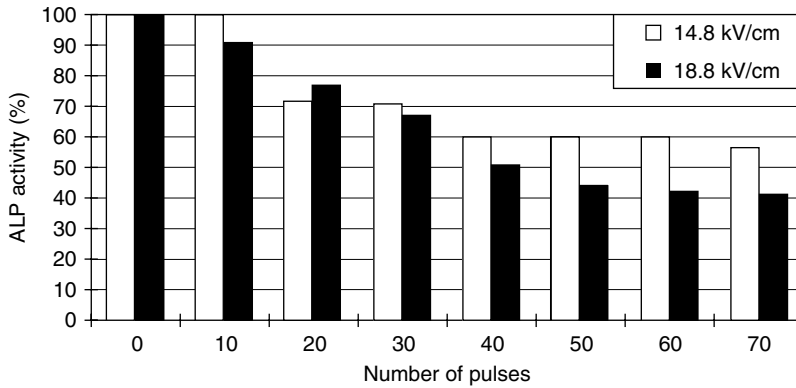
#### 33.3.2.1 Alkaline Phosphatase

The activity of alkaline phosphatase (ALP) in pasteurized milk products has public health significance, since the presence of active ALP indicates inadequate pasteurization or cross-contamination with raw milk [61]. In fresh raw milk, ALP is present in association with the membrane of fat globules; in skim milk it is in the form of lipoprotein particles.

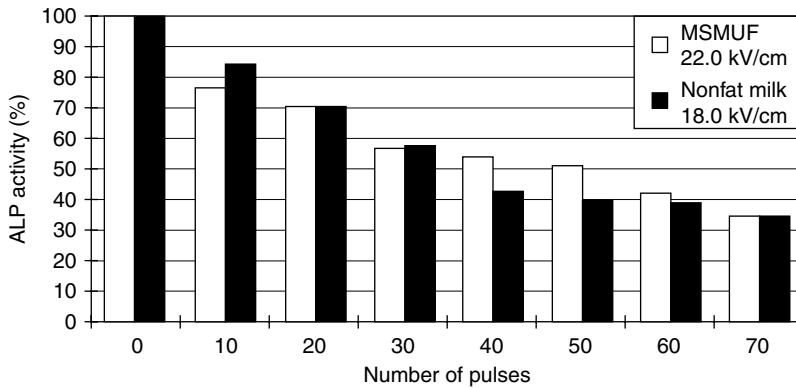
The inactivation of ALP by PEF is a function of the field intensity, the fat content of the milk, and the concentration of ALP. The activity of ALP decreases with an increase in field intensity [61]. A reduction of 43%–59% in ALP activity is reported when the enzyme is suspended in 2% milk and exposed to 70 pulses of 0.40–0.45 ms at 14.8–18.8 kV/cm (Figure 33.37). Seventy pulses of 0.74 ms of a field strength of 22 kV/cm applied to 2 mg/mi ALP in SMUF reduced the ALP activity by 65% (Figure 33.38). The activity of ALP dissolved in UHT-pasteurized 2 and 4% milk was reduced by 59% when exposed to 70 pulses of 0.40 ms at 18.8 kV/cm, while a 65% reduction was observed in nonfat milk as illustrated in Figure 33.39. ALP suspended in milk (1 mL of raw milk in 100 mL of 2% milk) using 13.2 kV/cm and 43.9°C after 70 pulses showed a reduction of 96% in activity, whereas heat treatment at 43.9°C for 17.5 min showed only a 30% reduction (Figure 33.40). Castro [61] demonstrated a reduction in initial velocity of fluoroyellow production of ALP as a function of number of pulses, as illustrated in Figure 33.41. Castro also found that PEF-treated ALP is more susceptible to trypsin proteolysis (70 pulses of 0.78 ms at 22.3 kV/cm), as illustrated in Figure 33.42. The inactivation of ALP is attributed to conformational changes induced by PEF [31,61].

#### 33.3.2.2 Plasmin and a Protease from *Pseudomonas fluorescens* M3/6

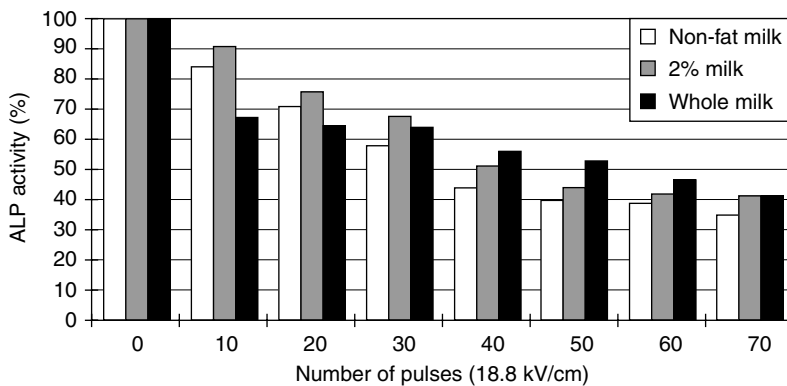
The proteolytic enzyme plasmin and a protease from *Pseudomonas fluorescens* M3/6 were also inactivated using PEFs. A 90% inactivation of plasmin activity was observed during 30 and 45 kV/cm, 10–50 pulses of 2 μs duration, and a process temperature of 10°C and 15°C [61] as presented in Figures 33.43 and 33.44. Meanwhile, 80% inactivation was found for a protease extracted from *P. fluorescens* when dispersed in Triptych soy broth and exposed to 20 pulses of 2 μs at 11–18 kV/cm and 20°C–24°C. A 60% inactivation was detected when inoculated in sterilized skim milk and exposed to 98 pulses of 2 μs at 15 kV/cm and 50°C (Figure 33.45); no inactivation was detected when inoculated in a sterilized casein–Tris buffer and exposed to a PEF treatment similar to that for skim milk. The decreased effectiveness of PEF in the inactivation of the protease in skim milk and the casein–Tris



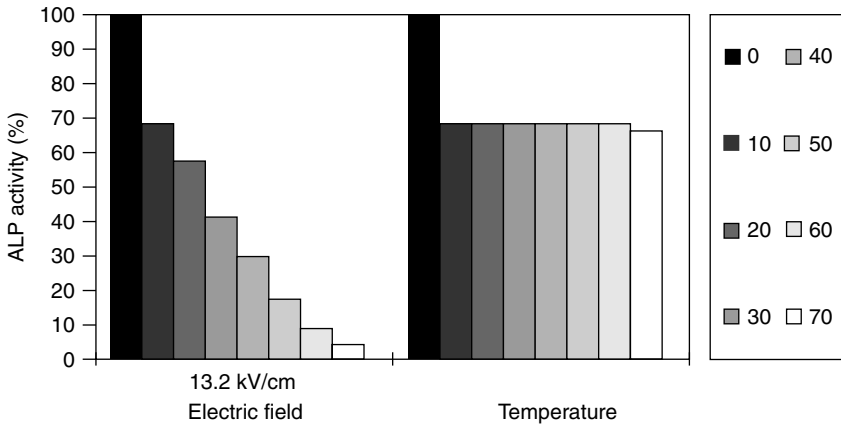
**FIGURE 33.37** PEF inactivation of ALP diluted in UHT pasteurized 2% milk. (From A. J. Castro, Ph.D. thesis, Washington State University, Pullman, WA, 1994.)



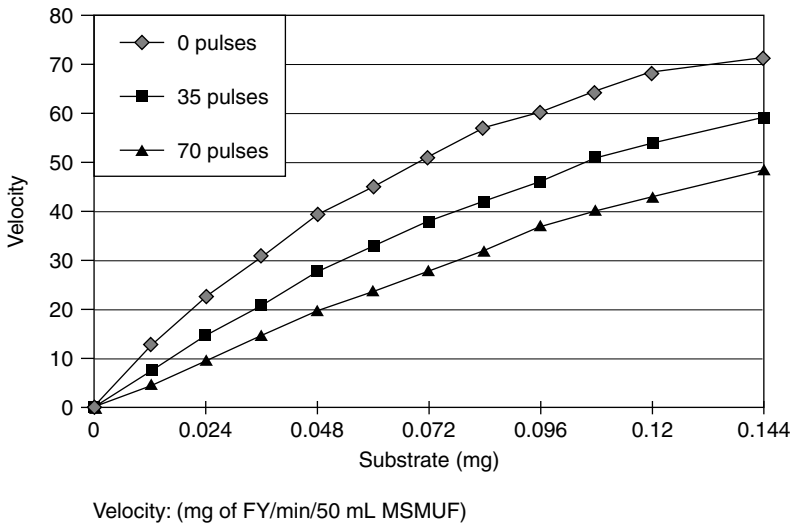
**FIGURE 33.38** PEF inactivation of ALP diluted in MSMUF or nonfat milk. (From A. J. Castro, Ph.D. thesis, Washington State University, Pullman, WA, 1994.)



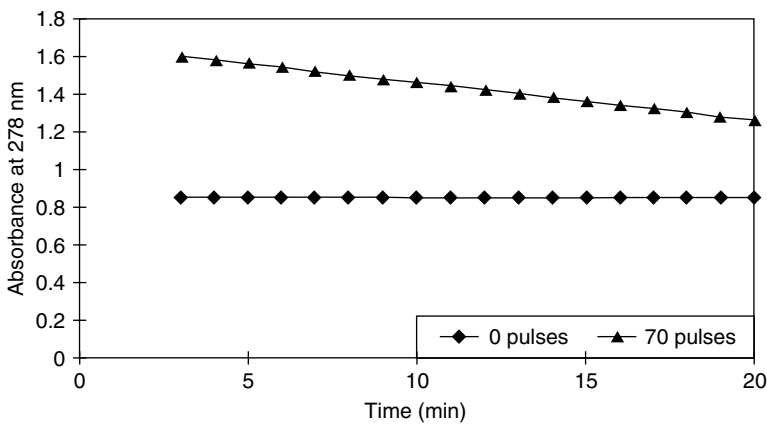
**FIGURE 33.39** PEF inactivation of ALP diluted in UHT pasteurized nonfat, 2% and whole milk. (From A. J. Castro, Ph.D. thesis, Washington State University, Pullman, WA, 1994.)



**FIGURE 33.40** Inactivation of alkaline phosphatase by PEF or heating at 44°C for 17.5 min. (From A. J. Castro, Ph.D. thesis, Washington State University, Pullman, WA, 1994.)



**FIGURE 33.41** Initial velocity of fluoroyellow (FY) producing reaction of ALP in MSMUF treated with 0.78 ms pulses of 22.3 kV/cm.



**FIGURE 33.42** Trypsin digestion of native and PEF-treated alkaline phosphatase. (From A. J. Castro, Ph.D. thesis, Washington State University, Pullman, WA, 1994.)

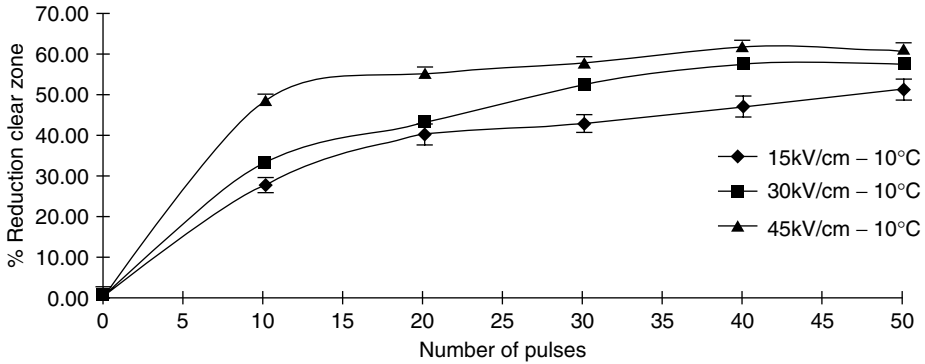


FIGURE 33.43 PEF inactivation of plasmin at 10°C. (From H. Vega-Mercado et al., *J. Food Sci.* 60: 1143, 1995.)

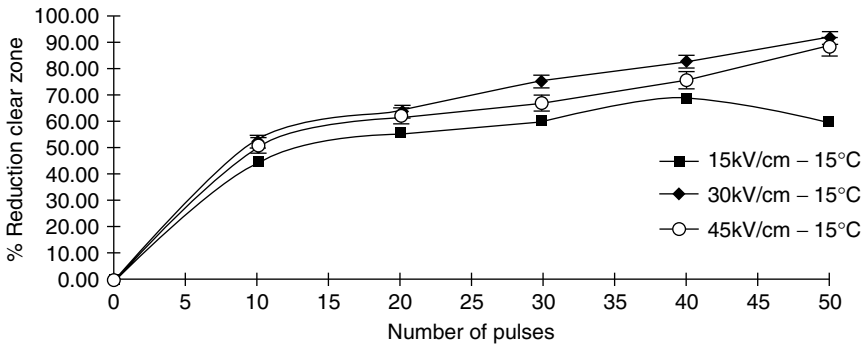


FIGURE 33.44 PEF inactivation of plasmin at 15°C. (From H. Vega-Mercado et al., *J. Food Sci.* 60: 1143, 1995.)

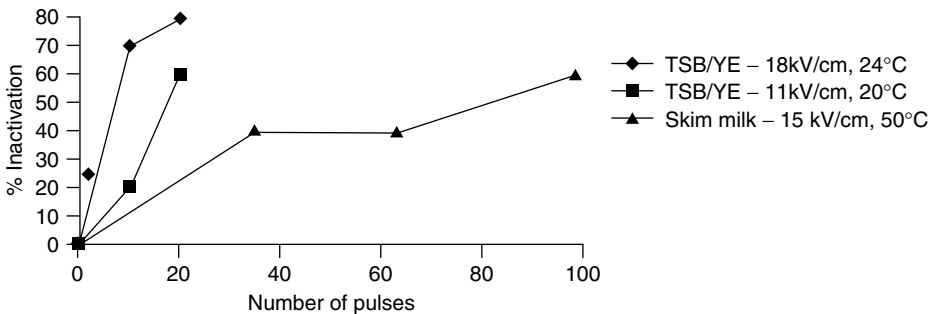


FIGURE 33.45 Inactivation of a protease from *P. fluorescens* M3/6 in Triptych soy broth enriched with yeast extract (TSB/YE, pulsing rate of 0.25 Hz) and skim milk (pulsing rate 2 Hz) using 2 μs pulses. (From H. Vega-Mercado et al., *Proceedings of ICEF7, Seventh International Congress on Engineering and Food*, The Brighton Center, Brighton, UK, 13–17 April, 1997, p. C73.)

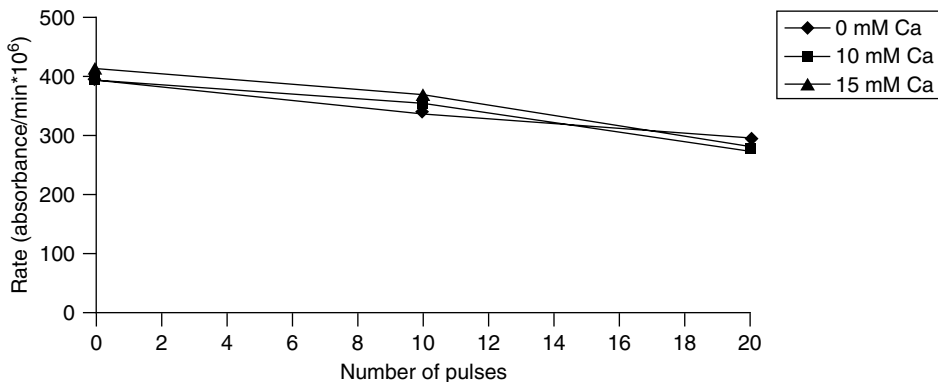
buffer may be attributed to a protective role of the substrate (i.e., casein) against conformational changes of the enzyme induced by the electric fields [63].

The susceptibility of casein to proteolysis varies as a function of treatment conditions [63]; a HIPEF treatment of 25 kV/cm at 0.6 Hz and 30°C was found to increase the proteolytic activity in skim milk inoculated with a protease from *P. fluorescens* M3/6. However, 14 or 15 kV/cm at 1 or 2 Hz and 30°C

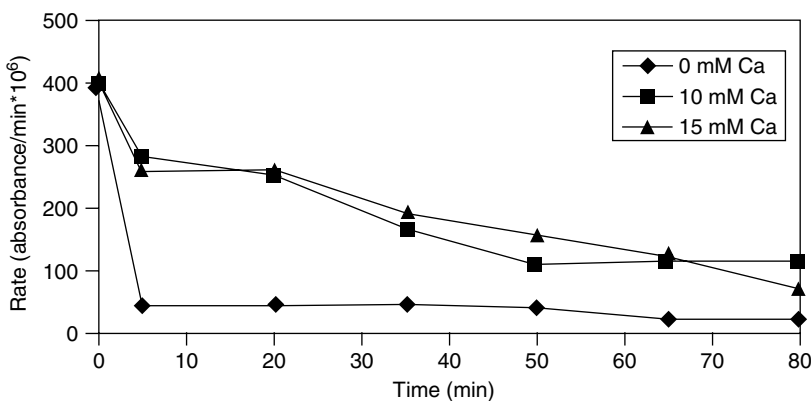
had no significant effect on the susceptibility of casein in skim milk proteolysis, and no significant change was observed in the susceptibility of casein suspended in a casein–Tris buffer when exposed to treatment conditions similar to those for skim milk [63].

The inactivation of the protease from *P. fluorescens* M3/6 when exposed to PEF does not depend on the presence of calcium in the media containing the protease (Figure 33.46). The inactivation is the same for the three solutions containing 0, 10, or 15 mM calcium. The proteolytic activity of the protease was reduced 30% after exposure to 20 pulses of 700  $\mu$ s at 6.2 kV/cm and 15°C–20°C [64].

In contrast to PEF, thermal inactivation of the protease suspended in SMUF does vary with calcium content. Heated samples containing either 10 or 15 mM calcium retained 71% of the original activity compared to 12% retention on samples without calcium after 5 min of heating, followed by a steady decrease in activity as a function of the heating time (Figure 33.47). The analysis by HPLC using the hydrophobic interaction column (HIC) of PEF (20 pulses, 15 mM  $\text{Ca}^{2+}$ ) and heat-treated (5 min, 15 mM  $\text{Ca}^{2+}$ ) samples showed differences in the retention time and high peak of the eluted protein when compared to nontreated samples (Table 33.8). EDTA has a significant inhibitory effect on the proteolytic activity of the protease (Figure 33.48). This result is similar to reported data for the protease from *P. fluorescens*. PEF treatment of samples containing EDTA enhanced the inactivation of the protease in SMUF (Figure 33.49).



**FIGURE 33.46** PEF inactivation of protease from *P. fluorescens* M3/6 at 6.2 kV/cm. (From H. Vega-Mercado, Ph.D. thesis, Washington State University, Pullman, WA, 1996.)



**FIGURE 33.47** Thermal inactivation of protease from *P. fluorescens* M3/6. (From H. Vega-Mercado, Ph.D. thesis, Washington State University, Pullman, WA, 1996.)



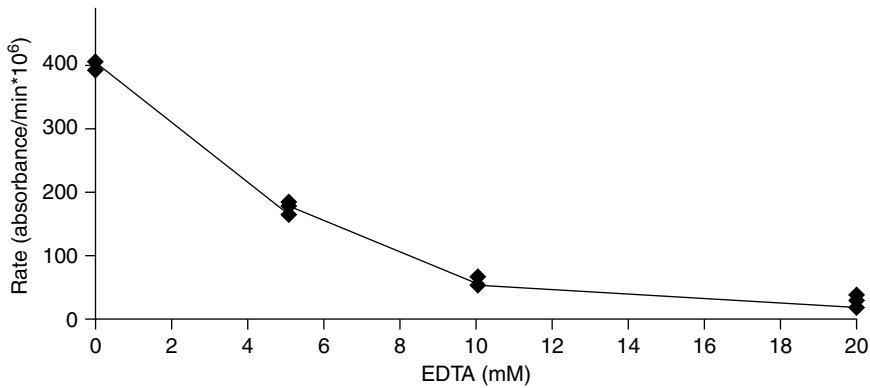
**TABLE 33.8**

Hydrophobic Changes of Protease Suspended in SMUF Induced by PEF and Thermal Treatments

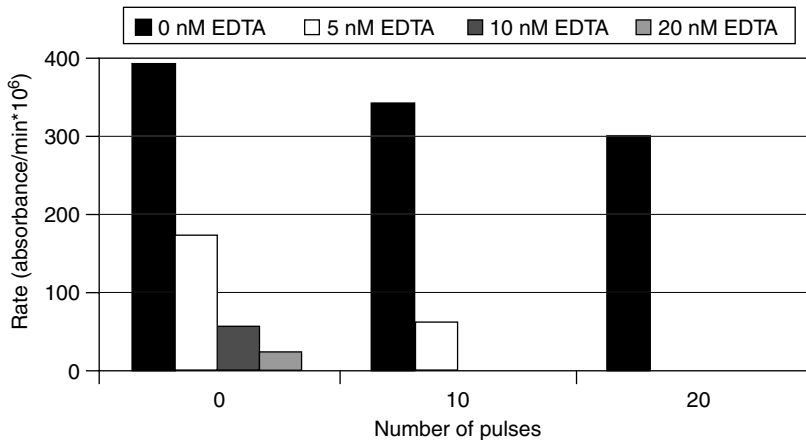
Sample	Retention Time (min)	Peak (mm)
Control	6.01	22.9
20 pulses <sup>a</sup>	5.96	25.4
Heat-treated <sup>a</sup>	5.93	20.6

<sup>a</sup> 15 M Ca<sup>2+</sup>.

Source: H. Vega-Mercado, Ph.D. thesis, Washington State University, Pullman, WA, 1996.



**FIGURE 33.48** Inhibitory effect of EDTA on a protease from *P. fluorescens* M3/6. (From H. Vega-Mercado, Ph.D. thesis, Washington State University, Pullman, WA, 1996.)



**FIGURE 33.49** PEF inactivation of a protease from *P. fluorescens* M#6 in SMUF with EDTA. (From H. Vega-Mercado, Ph.D. thesis, Washington State University, Pullman, WA, 1996.)

### 33.4 Final Remarks

The research on PEFs as a nonthermal process needs to include not only the inactivation of microorganisms, but the inactivation of enzymes, retention of vitamins, and the effect of PEF treatments on other food components. The reported inactivation of enzymes, as well as the increased proteolysis of casein

following exposure to PEF, suggests that detailed research is needed in areas other than preservation. PEFs could be utilized as an effective hurdle when used in combination with other preservation factors such as pH and water activity or as a complementary step with mild thermal processes.

---

## References

1. A. K. Anderson and R. Finkelstein, A study of the electropure process of treating milk, *J. Dairy Sci.* 2: 374 (1919).
2. B. E. Getchell, Electric pasteurization of milk, *Agric. Eng.* 16(10): 408 (1935).
3. S. Palaniappan and S. K. Sastry, Electrical conductivity of selected juices: influences of temperature, solids content, applied voltage, and particle size, *J. Food Proc. Eng.* 14: 247 (1991).
4. N. E. Bengtsson and T. Ohlsson, Microwave heating in food industry, *Proc. IEEE* 62(1): 44 (1974).
5. C. A. Balanis, *Advanced Engineering Electromagnetics*, Wiley, New York, 1989.
6. IFT, Microwave food processing, *Food Technol.* 43(1): 117 (1989).
7. R. A. Lawrie, *Meat Science*, 4th ed., Pergamon Press, New York, 1985.
8. Y. Li, M. F. Slavik, C. L. Griffis, J. T. Walker, J. W. Kim, and R. E. Wolfe, Destruction of *Salmonella* in poultry chiller water using electrical stimulation, *Trans. ASAE* 37(1): 211 (1994).
9. A. Mizuno and Y. Hori, Destruction of living cells by pulsed high-voltage application, *IEEE Trans. Ind. Appl.* 24: 387 (1988).
10. S. Palaniappan and S. K. Sastry, Effects of electricity on microorganisms: a review, *J. Food Proc. Pres.* 14: 393 (1990).
11. J. E. Dunn and J. S. Pearlman, Methods and apparatus for extending the shelf life of fluid food products, U.S. patent 4,695,472 (1987).
12. S. Jayaram, G. S. P. Castle, and A. Margaritis, Effects of high electric field pulses on *L. brevis* at elevated temperatures, *Proceedings of IEEE Industry Applications Society Annual Meeting*, 1991, p. 647.
13. B. Mertens and D. Knorr, Developments of nonthermal processes for food preservation, *Food Technol.* 46(5): 124 (1992).
14. W. Sitzmann, High voltage pulse techniques for food preservation, in *New Methods of Food Preservation* (G. W. Gould, ed.), Blackie Academic & Professional, Chapman & Hall, New York, 1995, p. 236.
15. B. L. Qin, Q. Zhang, G. V. Barbosa-Cánovas, and B. G. Swanson, Inactivation of microorganisms by pulsed electric fields of different voltage waveforms, *IEEE Trans. Dielectr. Electr. Insul.* 1(6): 1047 (1994).
16. J. C. Fetterman, The electrical conductivity method of processing milk, *Agric. Eng.* 9: 107 (1928).
17. J. M. Beattie and F. C. Lewis, The electric current (apart from the heat generated). A bacteriological agent in the sterilization of milk and other fluids, *J. Hyg.* 24: 123 (1925).
18. S. E. Gilliland and M. L. Speck, Mechanism of the bactericidal action produced by electrohydraulic shock, *Appl. Microbiol.* 15: 1038 (1967).
19. A. J. H. Sale and W. A. Hamilton, Effect of high electric fields on microorganisms. I. Killing of bacteria and yeast, *Biochim. Biophys. Acta* 148: 781 (1967).
20. H. E. Jacob, W. Foster, and H. Berg, Microbial implication of electric field effects. II. Inactivation of yeast cells and repair of their cell envelope, *Z. Aug. Mikrobiol.* 21: 225 (1981).
21. H. Hulsheger, J. Potel, and E. G. Niemann, Electric field effects on bacteria and yeast cells, *Radiat. Environ. Biophys.* 22: 149 (1983).
22. M. Sato, K. Tokita, M. Sadakata, and T. Sakai, Sterilization of microorganisms by high-voltage pulsed discharge under water, *Kagaku Hogaku Ronbunshu* 4: 556 (1988).
23. U. R. Pothakamury, H. Vega-Mercado, Q. Zhang, G. V. Barbosa-Cánovas, and B. G. Swanson, Effect of growth stage and temperature on the inactivation of *E. coli* by pulsed electric fields, *J. Food Prot.* 59(11): 1167 (1996).
24. Q. Zhang, A. Monsalve-González, G. V. Barbosa-Cánovas, and B. G. Swanson, Inactivation of *E. coli* and *S. cerevisiae* by pulsed electric fields under controlled temperature conditions, *Trans. ASAE* 37: 581 (1994).
25. Q. Zhang, B. L. Qin, G. V. Barbosa-Cánovas, and B. G. Swanson, Inactivation of *E. coli* for food pasteurization by high intensity short duration pulsed electric fields, *J. Food Proc. Pres.* 19: 103 (1995).
26. H. Vega-Mercado, U. R. Pothakamury, F. J. Chang, G. V. Barbosa-Cánovas, and B. G. Swanson, Inactivation of *E. coli* by combining pH, ionic strength and pulsed electric field hurdles, *Food Res. Int.* 29(2): 117 (1996).

27. U. Zimmermann, G. Pilwat, and F. Riemann, Dielectric breakdown on cell membranes, *Biophys. J.* 14: 881 (1974).
28. R. Benz and U. Zimmermann, Pulse-length dependence of the electrical breakdown in lipid bilayer membranes, *Biochim. Biophys. Acta* 597: 637 (1980).
29. D. Knorr, M. Geulen, T. Grahl, and W. Sitzmann, Food application of high electric field pulses, *Trends Food Sci. Technol.* 5: 71 (1994).
30. T. Y. Tsong, Review on electroporation of cell membranes and some related phenomena, *Biochim. Bioeng.* 24: 271 (1990).
31. T. Y. Tsong, Electroporation of cell membranes, *Biophys. J.* 60: 297 (1991).
32. J. W. Larkin and S. H. Spinak, Regulatory aspects of new/nova! technologies, in *New Processing Technologies Yearbook* (D. I. Chandarana, ed.), National Food Processors Association (NFPA), Washington, DC, 1996, p. 86.
33. H. Vega-Mercado, L. O. Luedecke, G. M. Hyde, G. V. Barbosa-Cánovas, and B. G. Swanson, HACCP and HAZOP for a pulsed electric field processing operation, *Dairy Food Environ. Sanit.* 16(9): 554 (1996).
34. A. H. Bushnell, J. E. Dunn, R. W. Clark, and J. S. Pearlman, High pulsed voltage systems for extending the shelf-life of pumpable food products, U.S. patent 5,235,905 (1993).
35. W. Sitzmann, Keimabtötung mit Hilfe elektrischer Hochspannungsimpulse in pumpfähigen Nahrungsmitteln. Vortrag anlässlich des Seminars. Mittelanforderung in der Biotechnologie. Ergebnisse des indirekt-spezifischen Programms des BMFT, Germany, 1990, p. 1986.
36. T. Grahl, W. Sitzmann, and H. Märkl, Killing of microorganisms in fluid media by high-voltage pulses, *Proceedings of the 10th Dechema Biotechnol.*, Conference Series 5B, Verlagsgesellschaft, Hamburg, Germany, 1992, p. 675.
37. O. Martín, Q. Zhang, A. J. Castro, G. V. Barbosa-Cánovas, and B. G. Swanson, Pulse electric fields of high voltage to preserve foods. Microbiological and engineering aspects of the process, *Span. J. Food Sci. Technol.* 34: 1 (1994).
38. B. L. Qin, Q. Zhang, G. V. Barbosa-Cánovas, B. G. Swanson, and P. D. Pedrow, *Continuous Flow Electrical Treatment of Flowable Food Products*, Washington State University, Pullman, WA, 1977.
39. Q. Zhang, F. J. Chang, G. V. Barbosa-Cánovas, and B. G. Swanson, Engineering aspects of pulsed electric field pasteurization, *J. Food Eng.* 25: 261 (1995).
40. Q. Zhang, B. L. Qin, G. V. Barbosa-Cánovas, B. G. Swanson, and P. D. Pedrow, Batch mode food treatment using pulsed electric fields, U.S. patent 5,549,041 (1995).
41. O. Martín, H. Vega-Mercado, B. L. Qin, F. J. Chang, G. V. Barbosa-Cánovas, and B. G. Swanson, Inactivation of *E. coli* suspended in liquid eggs using pulsed electric fields, *J. Food Proc. Pres.* 21: 193 (1997).
42. D. A. Corlett and M. H. Brown, pH and acidity, in *Factors Affecting the Life and Death of Microorganisms*, Academic Press, New York, 1980.
43. P. M. Wiggins, Cellular functions of a cell in a metastable equilibrium state, *J. Theor. Biol.* 52: 99 (1975).
44. K. Dolowy, Uniform hypothesis of cell behavior movement, contact inhibition of movement, adhesion, chemotaxis, phagocytosis, pinocytosis, division, contact inhibition of division, fusion, *J. Theor. Biol.* 52: 83 (1975).
45. U. R. Pothakamury, A. Monsalve-González, G. V. Barbosa-Cánovas, and B. G. Swanson, Inactivation of *E. coli* and *S. aureus* in model foods by pulsed electric field technology, *Food. Res. Int.* 28(2): 167 (1995).
46. H. G. L. Coster and U. Zimmermann, The mechanisms of electrical breakdown in the membrane of *Valonia utricularis*, *J. Membrane Biol.* 22: 73 (1975).
47. U. R. Pothakamury, A. Monsalve-González, G. V. Barbosa-Cánovas, and B. G. Swanson, High voltage pulsed electric field inactivation of *B. subtilis* and *L. delbrueckii*, *Span. J. Food Sci. Technol.* 35(1): 101 (1995).
48. U. R. Pothakamury, Preservation of foods by nonthermal processes, Ph.D. thesis, Washington State University, Pullman, WA, 1995.
49. H. Vega-Mercado, O. Martín, F. J. Chang, G. V. Barbosa-Cánovas, and B. G. Swanson, Inactivation of *E. coli* and *B. subtilis* suspended in pea soup using pulsed electric fields, *J. Food Proc. Pres.* 20(6): 501 (1996).
50. J. M. Jay, High temperature food preservation and characteristics of thermophilic microorganisms, in *Modern Food Microbiology*, 4th ed., Van Nostrand Reinhold, New York, 1992, p. 335.

51. Q. Zhang, F. J. Chang, G. V. Barbosa-Cánovas, and B. G. Swanson, Inactivation of microorganisms in a semisolid model food using high voltage pulsed electric fields, *Food Sci. Technol. (LWT)* 27(6): 538 (1994).
52. Q. Zhang, F. J. Chang, G. V. Barbosa-Cánovas, and B. G. Swanson, Inactivation of *E. coli* for food pasteurization by high intensity short duration pulsed electric fields, *J. Food Proc. Pres.* 17: 469 (1994).
53. M. Allen and K. Soike, Sterilization by electrohydraulic treatment, *Science* 10: 155 (1966).
54. M. V. Simpson, G. V. Barbosa-Cánovas, and B. G. Swanson, Influence of PEF on the composition of apple juice, Internal Report, Washington State University, Pullman, WA, 1995.
55. B. L. Qin, Q. Zhang, G. V. Barbosa-Cánovas, B. G. Swanson, and P. D. Pedrow, Pulsed electric field treatment chamber design for liquid food pasteurization using a finite element method, *Trans. ASAE*. 38(2): 557 (1995).
56. B. L. Qin, Q. Zhang, G. V. Barbosa-Cánovas, B. G. Swanson, P. D. Pedrow, and R. G. Olsen, A continuous treatment system for inactivating microorganisms with pulsed electric fields, *Proceedings of IEEE/IAS Meeting*, Orlando, FL, October 1995.
57. O. Martin, B. L. Qin, F. J. Chang, G. V. Barbosa-Cánovas, and B. G. Swanson, Inactivation of *E. coli* in skim milk by high intensity pulsed electric fields, *J. Food Proc. Eng.* 20: 317-336 (1997).
58. W. A. Hamilton and A. J. H. Sale, Effect of high electric fields on microorganisms. I. Mechanism of action of the lethal effect, *Biochem. Biophys. Acta* 148: 789 (1967).
59. H. D. Goff and A. R. Hill, Chemistry and physics, in *Dairy Science and Technology Handbook, Vol. 1: Principles and Properties* (Y. H. Hui, ed.), VCH Pub., New York, p. 1.
60. H. Hulsheger, J. Potel, and E. G. Niemann, Killing of bacteria with electric pulses of high field strength, *Radiat. Environ. Biophys.* 20: 53 (1981).
61. A. J. Castro, Pulsed electric field modification of activity and denaturation of alkaline phosphatase, Ph.D. thesis, Washington State University, Pullman, WA, 1994.
62. H. Vega-Mercado, J. R. Powers, G. V. Barbosa-Cánovas, and B. G. Swanson, Plasmin inactivation with pulsed electric fields, *J. Food Sci.* 60: 1143 (1995).
63. H. Vega-Mercado, J. R. Powers, O. Martin-Belloso, O. L. Luedecke, G. V. Barbosa-Cánovas, and B. G. Swanson, Effect of pulsed electric fields on the susceptibility of proteins to proteolysis and inactivation of an extracellular protease from *P. fluorescens* M 3/6, *Proceedings of ICEF7, Seventh International Congress on Engineering and Food*, The Brighton Center, Brighton, UK, 13-17 April, 1997, p. C73.
64. H. Vega-Mercado, Inactivation of proteolytic enzymes and selected microorganisms in foods using pulsed electric fields, Ph.D. thesis, Washington State University, Pullman, WA, 1996.



# 34

## *High-Pressure Treatment in Food Preservation*

Enrique Palou, Aurelio Lopez-Malo, Gustavo V. Barbosa-Canovas,  
and Barry G. Swanson

### CONTENTS

34.1	Introduction .....	815
34.2	Hydrostatic Pressure Treatment of Food.....	816
34.2.1	Terminology .....	816
34.2.2	Commercial Equipment .....	818
34.2.3	Processing Operation .....	820
34.2.4	Commercial Applications.....	821
34.3	Effects of High Pressure on Biological Materials.....	822
34.3.1	Microorganisms .....	823
34.3.1.1	Vegetative Cells.....	823
34.3.1.2	Microbial Spores.....	834
34.3.1.3	High-Pressure Mechanism of Action .....	835
34.3.2	Chemical and Biochemical Reactions .....	836
34.3.3	Enzymatic Reactions .....	838
34.3.4	Functional Properties .....	840
34.3.5	Sensory Properties .....	841
34.3.6	Gelation and Gelatinization Processes.....	842
34.4	Combination Treatments .....	844
34.5	Potential Applications .....	846
34.6	Final Remarks .....	847
	References .....	848

### 34.1 Introduction

Consumer trends and therefore food markets are changing and will change more in the future [1]. Foods with high quality and more fresh-like attributes are in demand; consequently, less extreme treatments or fewer additives are required. Gould [2] identified some food characteristics that must be attained in response to modern consumer demands: less heat and chill damage; more freshness; and less acid, salt, sugar, and fat. To satisfy these demands; some changes in the traditionally used preservation techniques must be achieved. From a microbiological point of view, these changes have important and significant implications. Moreover, food safety is an aspect of increasing importance and improvements in microbial control must be attained. Therefore, to satisfy market requirements, the safety and quality of foods will be based on substantial improvements in traditional preservation methods or the use of “emerging technologies.” Furthermore, the use of good manufacturing practices in the food industry and the maintenance of hygiene standards in food service establishments and homes are essential to the control of foodborne diseases. However, these procedures alone may be insufficient to ensure microbial safety, making food-preservation methods necessary [3].

One “new” or emerging technology receiving a great deal of attention is high hydrostatic pressure. Studies examining the effects of high pressure on foods date back to the end of the nineteenth century,

but renewed research and commercialization efforts worldwide could place high-pressure-treated foods on several markets soon [4–7]. In April 1990, the first high-pressure product, a high-acid jam, was introduced to the Japanese retail market. In 1991, yogurts, fruit jellies, salad dressings, and fruit sauces were also introduced, and two Japanese fruit juice processors installed semicontinuous high-pressure equipment for citrus juice bulk processing [8].

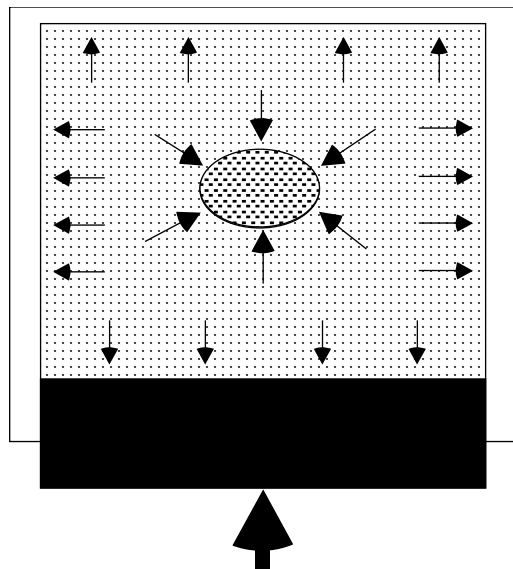
The basis of high hydrostatic pressure is the Le Chatelier principle, according to which any reaction, conformational change, or phase transition that is accompanied by a decrease in volume will be favored at high pressures, while reactions involving an increase in volume will be inhibited [7,9]. However, owing to the complexity of foods and the possibility of changes and reactions that can occur under pressure, predictions of the effects of high-pressure treatments are difficult, as are generalizations about any particular type of food. However, a tremendous amount of information has been generated in the past decade, and evidence has been recorded about the effects of high pressure on food systems, including microbial inactivation, chemical and enzymatic reactions, and structure and functionality of biopolymers [4,5,7]. The study of chemical and microbiological changes of foods processed by high hydrostatic pressure will determine their safety and quality, but commercial feasibility must include research on the design and construction of plant and equipment for the high-pressure processing of foods. Integration of the large amount of available information to design an efficient process is necessary. This chapter examines the current situation of high-hydrostatic-pressure technology with a view of its feasible use in the food industry.

## 34.2 Hydrostatic Pressure Treatment of Food

High-pressure technology was originally used in the production of ceramics, steels, and superalloys. In the past decade, high-pressure technology was expanded to include the food industry. High pressure presents unique advantages over conventional thermal treatments [10,11], including application at low temperatures, which improves the retention of food quality [12]. High-pressure treatments are independent of product size and geometry, and their effect is uniform and instantaneous [10,13–15]. The principle of isostatic processing is presented in Figure 34.1; the food product is compressed by uniform pressure from every direction and then returns to its original shape when the pressure is released [16].

### 34.2.1 Terminology

The term “high pressure” is meaningless unless it is related to pressures experienced on earth. At the deepest point in the oceans, the pressure is about 100 MPa and at the center of the earth it is 360 GPa [17]. In commercial applications, the highest pressure used is around 5–6 Gpa, which is applied for diamond grit production [17]. High-isostatic-pressure technology is the application of pressure uniformly throughout a product and is essentially applied for isostatic pressing, quartz growing, chemical reactors, and simulators [18]. Quartz crystals are grown from a strong alkaline solution of sodium hydroxide at a pressure of up to 200 MPa and a temperature of up to 420°C. Some chemical reactions are carried out at high pressure to increase the yield of the reaction. For example, low-density polyethylene is synthesized at a pressure of 200 MPa and a temperature of 350°C. High-pressure vessels are also used as simulators to test equipment that would be used in a high-pressure environment, e.g., deep in the ocean [19]. The food industry employs the technique of isostatic pressing for applying high pressures to foods.



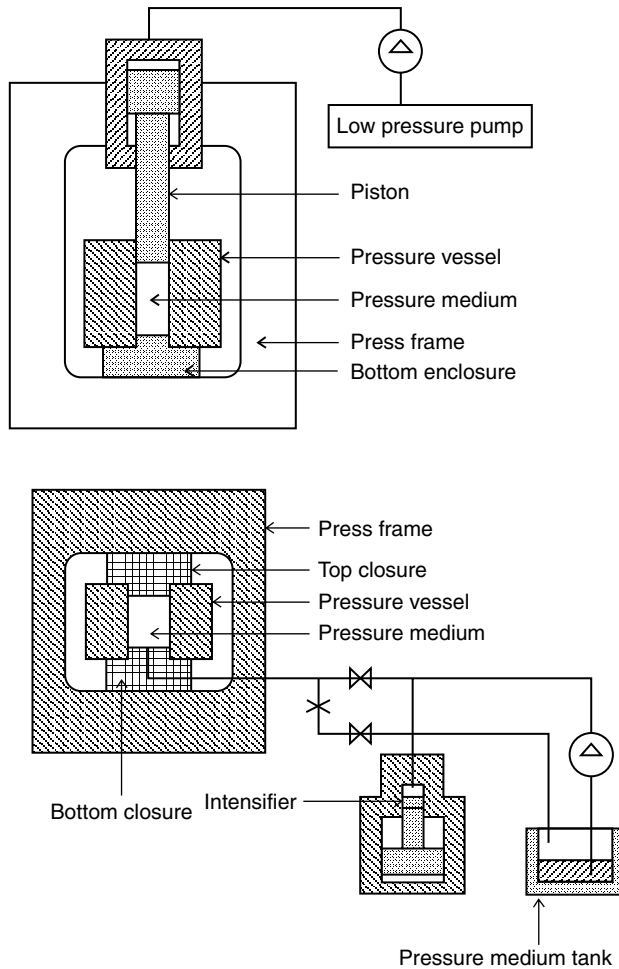
**FIGURE 34.1** The principle of isostatic processing. (Adapted from S. Olsson, in *High Pressure Processing of Foods*, Nottingham University Press, Nottingham, p. 167, 1995.)

A high-pressure system consists of a high-pressure vessel and its closure, pressure-generation system, temperature-control device, and material-handling system [20]. Once loaded and closed, the vessel is filled with a pressure-transmitting medium. Air is removed from the vessel by means of a low-pressure fast-fill-and-drain pump, in combination with an automatic deaeration valve, and high hydrostatic pressure is then generated. High pressures can be generated by direct or indirect compression or by heating the pressure medium [18].

*Direct compression* is generated by pressurizing a medium with the small diameter end of a piston (Figure 34.2). The large diameter end of the piston is driven by a low-pressure pump. This method allows very fast compression, but the limitations of the high-pressure dynamic seal between the piston and the vessel internal surface restrict the use of this method to small-diameter laboratory or pilot plant systems.

*Indirect compression* uses a high-pressure intensifier to pump a pressure medium from a reservoir into a closed high-pressure vessel until the desired pressure is reached (Figure 34.2). Most industrial isostatic pressing (cold, warm, or hot) systems utilize this method.

*Heating of the pressure medium* utilizes expansion of the pressure medium with increasing temperature to generate high pressure. This method is therefore used when high pressure is applied in combination with high temperature and requires very accurate temperature control within the entire internal volume of the pressure vessel [19]. The isostatic pressing systems may be operated as cold isostatic, warm isostatic, or hot isostatic systems [21] depending on the application.



**FIGURE 34.2** Generation of high pressure by direct (top) and indirect (bottom) compression of the pressure-transmitting medium. (Adapted from B. Mertens, in *New Methods of Food Preservation*, Blackie Academic and Professional, New York, p. 135, 1995.)



*Cold isostatic pressing* is essentially a forming technique used in the metal, ceramic, carbon, graphite, and plastic industries. Powdered materials are filled in an elastomer mold and subjected to high pressure. High-pressure machines work at ambient temperature and use as pressurization fluid a liquid such as water, emulsified water, or oil. Applied pressure is in the range of 50–600 MPa. The cold isostatic pressure process uses “wet bag” or “dry bag” configurations. In the wet bag method, the mold is filled outside the pressure vessel and then placed in the pressure vessel, which is filled with the pressure medium. In the dry bag method, the mold is fixed in the pressure vessel and separated from the pressure medium by an elastomer tool [19]. The cycle time in a wet bag method is a few minutes, while in a dry bag method it varies between 20 and 60 s. Cold and warm isostatic pressure systems are most similar to future food applications. Both the dry bag (in bulk) and wet bag (in-container) process options are of interest for food processing [20].

*Warm isostatic pressing* is also a forming technique. Isostatic pressure is applied in combination with temperatures between ambient and 250°C. A warm isostatic pressure system is used in situations where a chemical reaction develops during pressurization.

*Hot isostatic pressing* is used primarily in the metallic and ceramic industries. The material is uniformly heated and pressurized. The temperature employed is as high as 2000°C–2200°C, while pressure is around 100–400 MPa. The pressure medium used is a gas such as argon, nitrogen, helium, or air. The cycle time typically varies between 6 and 12 h [18].

The cold isostatic pressing equipment originally developed for application in the ceramic industry has been modified to meet the additional requirements in the food processing industry. While the pressure medium used in the vessel is water containing an antirusting agent or synthetic oil to protect the pressure vessel against corrosion, food processing requires the use of potable water or emulsified potable water [19].

The pressure vessel is the most important component of high-hydrostatic-pressure equipment. Crossland [17] mentioned several considerations that must be taken into account in vessel design. It is necessary to design the high-pressure vessel to be dimensionally stable in a safe-fail way, i.e., the vessel does not yield in service; if it fails it should fail with leak before fracture. There is also the problem of fatigue, which at the highest pressure cannot be avoided, but an acceptable economic lifetime must be achieved. It is also necessary to establish the minimum number of cycles to failure to determine the desired frequency of inspection.

### 34.2.2 Commercial Equipment

Japan is the leading manufacturer of high-pressure vessels. The first high-pressure food-processing vessel was manufactured by Mitsubishi Heavy Industries Ltd. (Tokyo). The major Japanese companies manufacturing high-pressure vessels are Mitsubishi Heavy Industries Ltd., Kobe Steel Ltd., and Nippon Steel Ltd. Other manufacturers of high-pressure equipment include Engineered Pressure Systems, ABB Autoclave Systems Inc., ACB, NKK Corp., Flow International, and Autoclave Engineers [6,19,22]. Table 34.1 provides specifications of some commercially available high-pressure systems and some details on pressure vessels and maximum operating pressures. As indicated in the table, the larger the vessel, the lower the maximum operating pressure [6]. The pressure vessels manufactured by Mitsubishi Heavy Industries varies in capacity from 0.6 to 210 L and the maximum working pressure varies from 400 to 700 MPa [23]. To minimize the reduction of equipment life due to repeated use of the pressure vessel, the Mitsubishi pressure vessel is made up of double cylinders. The inner surface of the pressure vessel is preloaded with a high compression stress. The parts of the vessel that come in contact with the pressurizing medium are made of stainless steel. The pressurizing and decompressing cycle is fast. Maximum pressure is attained in 90 s. High pressure and a long holding time imply that a great load is applied to the seal of the vessel cover. A self-seal packing with high durability and reliability is used. The seals can withstand repeated opening and closing of the pressure vessel and application of high pressure without leakage. A piston driven by a hydraulic cylinder is used to generate the required pressure [24].

Kobe Steel Ltd. developed two pressure vessels, a small test-pressure vessel and the other is one of the largest pressure vessels available today, with an internal volume capacity of 9400 L and a maximum working pressure of ~200 MPa. The former uses a piston for pressurization, and the oil hydraulic system and operational panel are compactly packaged as part of the equipment. Operation is fully automated and the temperature inside the pressure vessel can be recorded. This equipment also allows the use of a pressure-control program [25].

TABLE 34.1

Specifications of Selected Commercially Available High-Pressure Vessels

Vendor/Model	Diameter (m)	Length (m)	Volume (L)	Maximum Operating Pressure (MPa)
Mitsubishi Heavy Industries				
MFP 700	0.06	0.2	0.6	700
MCT 150	0.15	0.3	6.0	420
FP-30V	3.00	7.0	50	420
FP-40L	4.00	17.0	210	400
Kobe Steel				
	0.06	0.2	NA	700 <sup>a</sup>
	2.00	3.0	9400	196
ABB Autoclave Systems				
Quintus	0.09	0.225	NA	900 <sup>a</sup>
Quintus	0.30	1.250	100	900 <sup>a</sup>
Quintus	0.50	2.500	500	900 <sup>a</sup>
Engineered Pressure Systems				
	0.09	0.55	3.5	1380
	0.10	1.0	8.5	1030
	0.10	1.0	37	690
	0.60	2.5	700	550
	0.60	4.5	1250	410
	1.00	4.0	3150	200
	1.70	4.0	9000	100

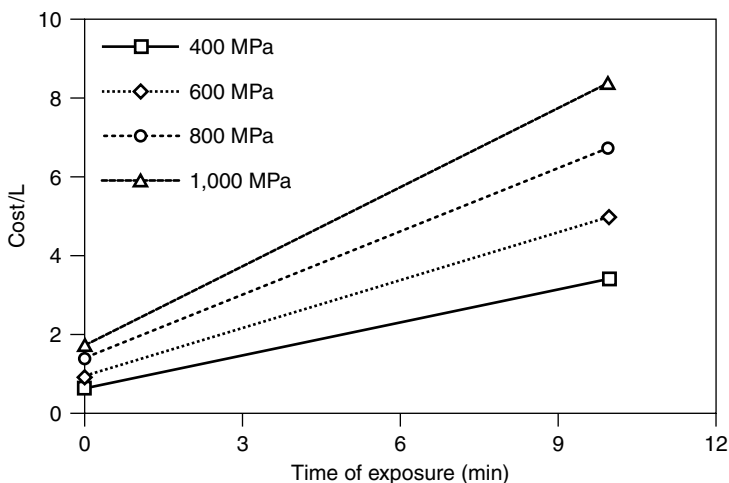
Note: NA: Not applicable

<sup>a</sup>Maximum temperature  $\approx 80^{\circ}\text{C}$ .

Source: U. R. Pothakamury et al., *Chem. Eng. Prog.* 93(3):45 (1995).

The high-pressure food processing system developed by ABB Autoclave Systems, Inc. (Vasteras, Sweden) for research purposes consists of two components: the process module and the control module. The process module consists of a cabinet, which contains the Quintus prestressed wire-wound pressure vessel, an electrohydraulic pumping system, and a hot water circulation system. The system can reach 900 MPa within 4 min. Temperature is maintained by circulating water in channels between the wire winding and the cylinder wall of the pressure vessel. The programmable control module in the ABB high-pressure research vessel monitors and controls the process time, pressure, and temperature. A microprocessor is used to control food loading into the press, press cycling, and downloading to a conveyor [26]. The cost of treating foods in 100- and 500-L systems is approximately between \$0.25 and \$0.07 per batch, respectively [27]. The high-pressure Quintus models from ABB Autoclave Systems vary in their dimensions, from 0.09 to 0.5 m (internal diameter) and from 0.225 to 2.5 m (internal length) with an internal capacity up to 500 L and a maximum operating pressure of 900 MPa. Pressure vessels with other dimensions available from ABB Autoclave Systems include: 0.045 m diameter  $\times$  0.3 m length with a maximum pressure of 1200 MPa; 0.11 m diameter  $\times$  0.26 m length with a maximum pressure of 830 MPa; 0.32 m diameter  $\times$  1.25 m length (100 L) with a maximum pressure of 900 MPa; and 0.50 m diameter  $\times$  2.50 m length (500 L) with a maximum pressure of 900 MPa. The fatigue value can be maintained infinitely by replacing a shrunk wear liner every 30,000 cycles. Changing the liner is convenient and inexpensive. ABB Autoclave Systems is designing and constructing a high-pressure vessel to work in batch mode with a maximum operating pressure of 1700 MPa. The internal diameter of the pressure vessel will be 0.076 m, while the height will be 0.18 m [28].

A warm isostatic pressing system is available from Engineered Pressure Systems Inc. (EPSI), a subsidiary of National Forge Co. (Andover, MA). The system consists of a double-ended, lined pressure vessel with plug closures. The design parameters of the high-pressure systems constructed by EPSI are listed in Table 34.1. Recently, EPSI developed a laboratory-scale pressure vessel with the following specifications: 0.1 m (internal diameter)  $\times$  2.5 m (internal height) with maximum operating



**FIGURE 34.3** Process cost as a function of exposure time at different pressures. (Adapted from S. Olsson, in *High Pressure Processing of Foods*, Nottingham University Press, Nottingham, p. 167, 1995.)

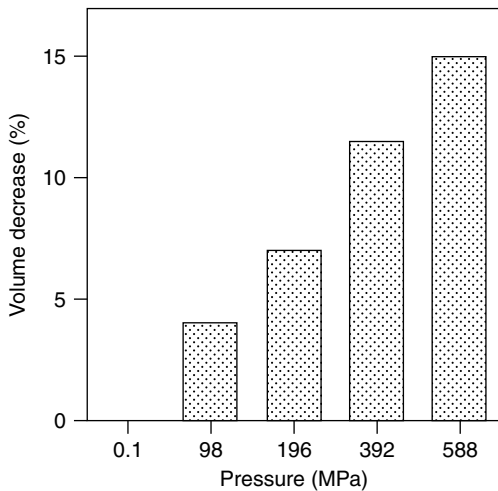
pressure of 680 MPa and maximum operating temperature of 90°C. While the design pressure is 750 MPa, the maximum operating pressure is 680 MPa. An electrohydraulic intensifier pump with a motor pressurizes the vessel to the operating pressure in 5 min or less [29]. An advanced laboratory-scale pressure vessel with a diameter of 0.024 m, length of 0.04 m, and maximum pressure of 800 MPa is also available from EPSI.

The processing cost as a function of time and pressure is presented in Figure 34.3. Processing at 400 MPa with a holding time of 10 min is twice as expensive as processing at 800 MPa with no hold time [16]. The combination of pressure, time, and temperature at which the product is processed must therefore be evaluated carefully. A low maximum operating pressure can achieve drastic reductions in fabrication costs. High-pressure processing may be combined with moderately high temperatures, so that the operating pressures required are not extremely high [30].

### 34.2.3 Processing Operation

A sterile container filled with food is sealed and placed in the pressure chamber for pressurizing. Ethylene-vinyl alcohol copolymer (EVOH) and polyvinyl alcohol (PVOH) films are recommended for packaging food for high-pressure treatment [31]. Also, existing multilayer plastic and some aluminum packages may be used for high-pressure processing. No deformation of the package occurs because the pressure is uniform [27]. The shape of the package needs to be designed to fill the vessel volume as far as possible, to increase the economical feasibility of the process.

The basis for applying high pressure to foods is to compress the water surrounding the food. At room temperature, the volume of water decreases with increase in pressure, as presented in Figure 34.4 [5,32]. Because liquid compression results in a small volume change, high-pressure vessels using water do not present the same operating hazards as vessels using compressed gases [5]. The capacity of a high-pressure plant depends on three factors: the number of cycles that can be performed in a given time, the volume of the product, and the number of high-pressure vessels available. The cycle time is determined by the time needed to handle the food product, including loading, unloading, opening, and closing the high-pressure vessel; the pressure holding time; and the pressurization and decompression rates. The productivity of the batch system is increased by a reduction in the pressurizing-decompressing cycle. The pressurizing time is reduced by increasing the delivery rate of the pump [19]. When the required operating pressure is attained, the pumping rate is reduced. At the end of the specified holding time, the pressure vessel is decompressed in two stages to avoid sudden release of pressurized water [24].



**FIGURE 34.4** Decrease in water volume with pressure. (Adapted from D. Farr, *Trends Food Sci. Technol.* 1:14, 1990.)

temperature. At the end of the processing time, the chamber is decompressed to remove the treated batch. A new batch of food is placed in the pressure vessel and the cycle begins again [13]. As in heat sterilization of packed products, the water in contact with the product must be potable, and the use of lubricating and rust-protecting products should be allowed in food processing. For bulk processing, the high-pressure equipment should be part of an aseptic line. Parts in contact with the food product should be clean and sterile. Engineering challenges to the application of high pressure in the food industry primarily relate to the construction of pressure vessels to handle large volumes of food and withstand the high pressures; the pressure vessel should have a short cycle time, be easy to clean, and be safe to operate with accurate process controls. It is desirable to develop a continuous process of pressurization for industrial purposes at reasonably low capital and operating costs [6,18,19]. Most of the challenges are being met to some extent, but research is still needed to further develop high-pressure technology and the necessary equipment.

#### 34.2.4 Commercial Applications

Current industrial applications of high hydrostatic pressure are presented in Table 34.2. The first pressure-processed foods in the human history were strawberry, kiwi, and apple jams (Meidi-ya Food Co., Japan), which were produced using high-pressure treatment without the application of heat. The jams were vivid and natural in color and taste. Hayashi [33] presents a list of pressure-processed foods in the Japanese market. The list includes fruit sauces and desserts (Meidi-ya Food Co.), mandarin (Wakayama Co.) and grapefruit juices (Pokka Co.), and unrefined rice wine called “nigori-sake.” The new sake has a white color and fresh flavor, instead of a brown color and cooked smell. Cheftel [9] mentioned that many of the products presented in Table 34.2 are acidic foods, hence they have an intrinsic safety factor; also some of the products are stored and sold refrigerated, consequently oxidative reactions are retarded. Hayashi [33] reported that at least seven food companies now sell high-pressure-processed foods, including salted raw squid and fish sausages. Knorr [10] mentioned that progress in various additional products is underway, but information is not available due to its confidential nature. In the United States and Europe, developments are being made in fruit products, ready meals, dairy products, meats, fish, and others. Avocado paste (guacamole) is now produced in Mexico using high pressure. Several new industrial applications are expected soon.

Batch processing reduces the risk of large quantities of food becoming contaminated by either the lubricants or wear particles from the machinery. Different types of food can be processed in a batch system, without the danger of cross-contamination or the need to clean the equipment after each run [19]. A technical advantage of the batch-type pressure vessel is the simplicity of fabrication when compared to a continuous flow pressure vessel operating at pressures as high as 400–900 MPa [6,19,21]. A batch system pressure vessel with a processing capacity of 600 L/h of liquid food at a maximum operating pressure of 420 MPa was used to commercially produce grapefruit juice in Japan [24]. The production rate of the batch process can be increased by operating the pressure vessels in sequence, with no lag in the processing times so that the system operates sequentially.

Food is subjected to high pressure for a specified time period. The holding time in the pressure vessel depends on the type of food and process

TABLE 34.2

Some Commercial High-Pressure-Treated Foods

Product	Processing Conditions	Package	Company
Jams Fruit dressings Fruit sauces Fruit jellies Yogurts	400 MPa, 20°C 10–30 min	Plastic cup (100–125 g)	Meidi-ya
Grapefruit juice	120–400 MPa, 20°C 2–20 min	Glass bottle (200–800 g)	Pokka
Mandarin juice	300–400 MPa, 20°C 2–3 min	Glass bottle (500 g)	Wakayama
Sugar-impregnated tropical fruits for sherbets and ice creams	50–200 MPa	Paper cups (130 g)	Nisshin
Beef tenderization	100–250 MPa, 20°C 30 min–3 h		Fuji Chiku & Mutterham
Rice cake	400 MPa, 45°C–70°C 10 min		Echigo Seika

Source: J. C. Cheftel, *Food Sci. Technol. Int.* 1:75, (1995); D. Knorr, in *New Methods of Food Preservation*, Blackie Academic and Professional, New York, p. 159 (1995); D. Knorr, *High Pressure Processing of Foods*, Nottingham University Press, Nottingham, p. 123 (1995).

### 34.3 Effects of High Pressure on Biological Materials

Pressure is an important thermodynamic variable and can affect a wide range of biological structures, reactions, and processes [34]. Pressure primarily affects the volume of a system [35]. The influence of pressure on the reaction rate may be described by the transition state theory: the rate constant of a reaction in a liquid phase is proportional to the quasi-equilibrium constant for the formation of the active reactants [36,37]. Based on this assumption, Heremans [35], van Eldik et al. [36], and Tauscher [37] reported that at constant temperature, the pressure dependence of the reaction velocity constant ( $k$ ) is due entirely to the activation volume of the reaction ( $\Delta V^*$ )

$$\left(\frac{\delta \ln k}{\delta P}\right)_T = -\left(\frac{\Delta V^*}{RT}\right) \quad (34.1)$$

where  $P$  is the pressure,  $R$  the gas constant ( $8.314 \text{ cm}^3 \text{ MPa K}^{-1} \text{ mol}^{-1}$ ), and  $T$  the temperature (K). Water is the most important food ingredient in many food products; thus, its characteristics under pressure are very important. Compared to gases, water is nearly incompressible; adiabatic compression of water increases the temperature by about 3°C per 100 MPa [37]. Self-ionization of water is also promoted by high pressure. The water-freezing characteristics can be changed by the application of pressure [38]. At approximately 1000 MPa, water freezes at room temperature, while the freezing point decreases to  $-22^\circ\text{C}$  at 207.5 MPa. This event promotes opportunities for subzero storage of foods without ice crystal formation, fast thawing of frozen foods by pressurization, and increasing food freezing by decompression of pressurized foods held below  $0^\circ\text{C}$  [34].

In an aqueous system, water molecules surrounding an ionized group align themselves according to the influence of the electrostatic charge, giving a more compact arrangement. Ionization of the acidic or basic groups found in many biomolecules, such as proteins, involves a volume decrease and, therefore, will be enhanced by increased pressure [4,39]. Microorganisms, chemical, biochemical, and enzymatic reactions; as well as some functional properties of biomolecules are affected, to some extent, by high pressure.

### 34.3.1 Microorganisms

Food preservation is based primarily on the inactivation, growth delay, or prevention of spoilage and pathogenic microorganisms and works through factors that influence microbial growth and survival. Gould [1] classified the major food-preservation technologies as those that act by preventing or slowing down the growth of microorganisms (low temperature, reduced water activity, less oxygen, acidification, fermentation, modified-atmosphere packaging, addition of preservatives, and compartmentalization in water-in-oil emulsions) and those that act by inactivating microorganisms (heat pasteurization and sterilization, ionizing radiation, high hydrostatic pressure, and pulsed electric fields). In addition, there is a strong emphasis on the use of techniques in combination, applying the hurdle technology concept [40], which could act by inhibiting or inactivating microorganisms, depending on the combination of hurdles applied.

Few techniques act primarily by inactivation, of which heat is by far the most commonly used. However, there is much interest in alternative, nonthermal preservation processes such as high pressure. From a food-safety point of view, techniques that inactivate pathogenic and spoilage flora are preferred over those based on preventing or slowing down the growth of microorganisms. This fact stimulates the interest in high pressure as a preservation technique to inactivate microorganisms in foods.

In heat sterilization and pasteurization, the applied treatment inactivates and considerably reduces the number of microorganisms initially present. However, the treated food's sensory and nutritional characteristics are also strongly affected. High hydrostatic pressure can be applied without temperature elevation, thus other food characteristics could be maintained. Nonthermal processes applied to food preservation without the collateral effects of heat treatments are being seriously studied and tested. The pressure sensitivity of microorganisms varies with the type of microorganism. Gould [1] reports that as high-pressure targets, microorganisms may be divided into those that cause food poisoning and those that cause food spoilage. Microorganisms can be further divided into those that are relatively pressure sensitive and those that are pressure resistant. Regarding pressure sensitivity, the most important categories are the vegetative and spore forms of microorganisms; in general the vegetative forms are inactivated by pressures between 400 and 600 MPa, while spores of some species may resist pressures higher than 1000 MPa at ambient temperatures. Gram-positive bacteria are more pressure resistant than Gram-negative ones [3,41,42]. Among the Gram-positive bacteria, Earnshaw [42] reported that *Staphylococcus* is one of the most resistant and can survive treatment at 500 MPa for more than 60 min.

#### 34.3.1.1 Vegetative Cells

The relative pressure sensitivity of the vegetative forms of microorganisms has made them the obvious targets for the preservation of foods by high pressure, and particularly for low-pH foods and other foods in which the intrinsic preservation systems already operating ensure that the pressure-resistant food poisoning or spoilage spore formers that may survive are unable to grow [1]. Increased opportunities must originate when combinations of pressure with some of the other already well-established inhibitory food-preservation techniques are applied using the hurdle technology approach. High-hydrostatic-pressure treatments can be considered as a new hurdle that can be used in combination with other traditional microbial stress factors such as pH, water activity ( $a_w$ ), and preservatives [40,43]. However, if high pressure is to be used instead of other stress factors, the kinetics of microbial pressure inactivation must be known as well as the spore resistance of toxigenic bacteria [1]. The extent of microbial inactivation achieved at a particular pressure treatment depends on a number of interacting factors, including type and number of microorganisms, magnitude and duration of high-pressure treatment, temperature, and composition of the suspension media or food [3,44,45]. Other experimental variables that must be taken into account include the compression and decompression rates [42].

##### 34.3.1.1.1 Type and Number of Microorganisms

Zobell [46] reported that most bacteria are capable of growth at pressures around 20–30 MPa; barophiles are organisms that can grow at pressures higher than 40–50 MPa, and those that survive for prolonged periods at pressures >200 MPa are named baroduric or barotolerant. The pressure effects on several pathogenic and spoilage microorganisms inoculated in pork slurry can be used to illustrate the microbial response to high hydrostatic pressure and the differences among species and microbial forms [41]. Figure 34.5 presents the response to high-hydrostatic-pressure treatments of vegetative forms of *Escherichia coli* and

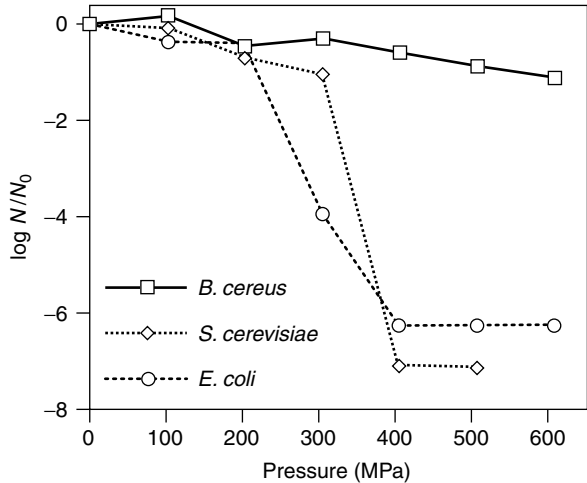
*Saccharomyces cerevisiae*, and spores of *Bacillus cereus* inoculated in a pork slurry. *E. coli* counts were almost unaffected at pressures lower than 203 MPa, but treatments at 304 MPa or higher pressures drastically reduced the initial inocula (106–107 cfu/g). More than 6 log cycles of *E. coli* were reduced at pressures higher than 405 MPa for 10 min. For *S. cerevisiae*, less than 2 log cycle reductions were observed at pressures lower than 304 MPa and more than 6 log cycles at pressures higher than 405 MPa. *B. cereus* spore counts were not reduced considerably (less than 1 log cycle) even in treatments at 608 MPa for 10 min.

Patterson et al. [3,47] reported important information about the effect of high pressure on foodborne vegetative pathogens. Styles et al. [48] and Takahashi et al. [49] reported that Gram-negative bacteria are pressure sensitive. Among these, *Vibrio parahaemolyticus* is one of the most sensible, a 6 log reduction in the initial population can be attained in treatments at 200 MPa for 20 min.

However, Gram-positive pathogens such as *Listeria monocytogenes* and *Staphylococcus aureus* required, for a 6 log reduction in the initial inoculum, treatments for 20 min at 340 and 400 MPa, respectively [3]. *E. coli* 0157:H7 is another pressure-resistant pathogenic bacteria. Takahashi et al. [49] reported that for a 6-log cycle reduction, the treatment must be at 700 MPa for 13 min. Shigehisa et al. [41] postulated that the more complex membrane structure of Gram-negative bacteria is more susceptible to environmental changes like those caused by high-pressure treatments.

Earnshaw [42] reported that little difference was observed in the overall rates of *S. carnosus* inactivation for treatments at 650 MPa with different initial populations ranging from  $10^7$  to  $10^3$  cfu/mL. When  $10^2$  cfu/mL were initially inoculated, a faster inactivation rate was observed. It is obvious that with a large number of initially inoculated microorganisms, the effects of specific high-pressure treatments can be observed; but studies with realistic numbers of microorganisms are also needed. The pressure sensitivity of microorganisms may vary with species, and probably with the strain of the same species, and with the stage of the growth cycle at which the organisms are subjected to the high-hydrostatic-pressure treatment. In general, cells in the exponential phase are more sensitive to pressure treatments than cells in the log or stationary phases of growth [3,42,46,50]. Isaacs et al. [51] reported that freshly inoculated *E. coli* cultures growing rapidly were more sensitive than *E. coli* cultures that had reached the growth stationary phase. No effect was observed in the case of cells in the stationary phase even after 7 min at 200 MPa, while around 5 log cycle reductions were recorded with young cells from the log phase. Also, it has been established that the cell age distribution in inoculation studies might be an important factor in the result obtained after high-pressure treatments. Bacteria in the stationary phase are smaller and more spherical than in the log phase—when they are rapidly growing, rod shaped, and exhibit an accelerated metabolism. Isaacs et al. [51] stated that the greater resistance to pressure when the cell metabolism slows down may reflect the accumulation of cell components, which can reduce the effects of high pressure.

Considerable variations in pressure sensitivity between strains isolated from different foods or culture collections have been reported for the same microorganisms. Patterson et al. [3] reported a 3-log reduction for *L. monocytogenes* from a culture collection after 30 min at 375 MPa. The same pressure treatment reduced the initial population by  $>10^4$ -fold and  $10^7$ -fold for strain Scott A and a chicken isolate, respectively. Cheftel [9] reported that when the pressure resistance of various microorganisms was compared, the survival fractions determined by different investigators varied by a factor of 1 to  $>8$  for different species of the same genus (*Salmonella*) or by a factor of 1.5–3.5 for different strains of the same microorganism (*L. monocytogenes*).



**FIGURE 34.5** Effects of high hydrostatic pressure on *Bacillus cereus* spores and *Saccharomyces cerevisiae* and *Escherichia coli* vegetative cells inoculated into pork slurries. The inoculated samples were subjected to pressure treatments for 10 min at 25°C.  $N$  and  $N_0$  represent the number of survivors and initially inoculated microorganisms, respectively. (Adapted from T. Shigehisa et al., *Int. J. Food Microbiol.* 12:207, 1991.)

## 34.3.1.1.2 Extent and Duration of High-Hydrostatic-Pressure Treatments

Generally, an increase in pressure increases microbial inactivation. However, increasing the duration of the treatment does not necessarily increase the lethal effect. Above 200–300 MPa, the inactivation ratio of vegetative cells increases with pressure or process time [9]. Table 34.3 presents some results about the effects of high pressure level and exposure time on several microorganisms. As mentioned before, the

**TABLE 34.3**  
Effect of High-Hydrostatic-Pressure Treatments on Selected Microorganisms

Microorganisms	Substrate or Suspension Media	Treatment Conditions	Decimal Reductions	References		
<i>Saccharomyces cerevisiae</i>	Satsuma mandarin juice	250 MPa	5 min	≈2	[57]	
			10 min	≈4		
			30 min	6		
<i>Aspergillus awamori</i>	Satsuma mandarin juice	250 MPa	5 min	≈3	[57]	
			10 min	≈4		
			30 min	>4		
		300 MPa	5 min	5		
<i>Listeria innocua</i>	Minced beef muscle	330 MPa	10 min	≈2	[52]	
			20 min	≈3		
			30 min	≈5		
		360 MPa	5 min	≈1		
			10 min	≈2		
			20 min	≈4		
<i>Listeria monocytogenes</i>	10 mM phosphate buffer saline pH 7.0	300 MPa	10 min	<1	[47]	
			20 min	≈1		
			30 min	≈2.5		
		350 MPa	10 min	≈4		
			20 min	≈5.5		
			30 min	≈6.5		
		400 MPa	10 min	≈6		
			20 min	≈8		
			30 min	≈8		
<i>Vibrio parahaemolyticus</i>	100 mM phosphate buffer pH 7.0 with 3% NaCl	103 MPa	20 min	<1	[48]	
			40 min	≈1		
		138 MPa	10 min	≈1.5		
			20 min	≈2		
			30 min	≈4		
		172 MPa	10 min	≈2.5		
20 min	≈4.5					
30 min	≈6					
<i>Salmonella typhimurium</i>	63 mM phosphate buffer pH 7.0	241 MPa	30 min	<1	[67]	
			276 MPa	10 min		<1
		345 MPa	20 min	≈1		
			30 min	≈1.5		
			10 min	≈1.8		
			20 min	≈2.5		
Total plate count	Fresh-cut pineapple	200 MPa	5 min	0.6	[77]	
			270 MPa	5 min		1.8
			≈4°C	15 min		1.6
			340 MPa	5 min		1.9
			≈4°C	15 min		3.0
	40 min	2.1–2.9				



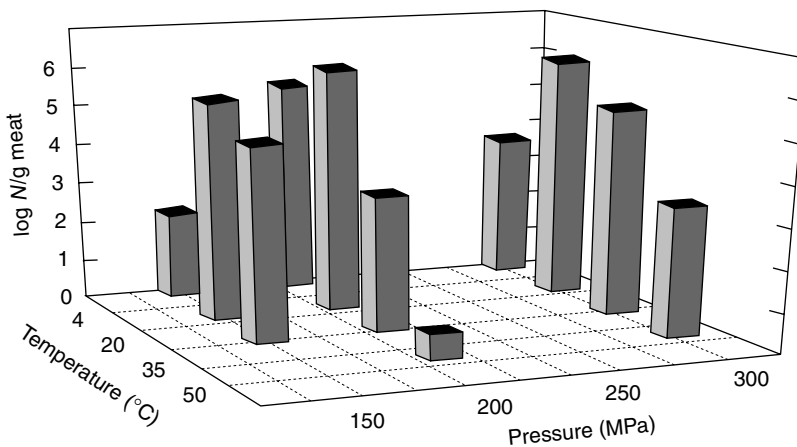
microbial response to high-pressure treatments depends on the type of microorganism. For each microorganism, there is a pressure-level threshold beyond which no effects are detected by increasing the exposure time. There also exists a pressure level at which increasing treatment time causes significant reductions in the initially inoculated microbial counts. The intrinsic conditions of the suspension media, such as pH,  $a_w$ , and nutrients, may influence the pressure threshold, which can increase or decrease effectiveness depending on the microorganism and variation of intrinsic, extrinsic, and processing factors. Kinetic studies at pressures over the pressure threshold are needed. With reliable kinetic data, the pressure sterilization or pasteurization of foods can be predicted and achieved.

#### 34.3.1.1.3 Temperature

The temperature during pressurization can have a significant effect on the inactivation of microbial cells. Several authors [9,52–55] observed that the resistance to pressure by an endogenous or inoculated microbial strain is maximal at normal temperatures (15°C–30°C) and decreases significantly at higher or lower temperatures. Freezing temperatures (–20°C) in treatments ranging from 100 to 400 MPa for 20 min enhance microbial inactivation when compared with high-pressure treatments at 20°C [49]. Hashizume et al. [56] reported that *S. cerevisiae* cells were more effectively inactivated by high-pressure treatments at elevated (40°C) or subzero (–0°C and –20°C) temperatures.

The decrease in resistance to pressure by vegetative cells at low temperatures (<5°C) may be due to changes in the membrane structure and fluidity, weakening of hydrophobic interactions, and crystallization of phospholipids [9]. However, moderate heating (40°C–60°C) may also enhance the microbial inactivation by pressure, resulting in some cases in a lower minimal inactivation pressure [9,52]. Ogawa et al. [57,58] reported an enhanced inactivation of natural flora and inoculated microorganisms in mandarin juice treated at 40°C in combination with pressures in the range of 400–450 MPa. Figure 34.6 presents the effect of temperature on the high-pressure inactivation of two psychrotrophic bacteria, *Pseudomonas fluorescens* and *Listeria innocua*, and one thermotolerant, *Citrobacter freundii*, inoculated in minced beef muscle [52]. The psychrotrophic bacteria were more sensitive to the effects of pressure at low temperatures, and *C. freundii* was more sensitive at 35°C and 50°C. For the three bacteria, the greatest inactivation was obtained with pressure treatment at 50°C [52].

Zobell [46] observed that the maximum microbial growth temperature at increased pressure is generally a few degrees higher than the optimum growth temperature at atmospheric pressure. Sale et al. [59] reported an increasing sensitivity of *B. coagulans* spores to pressure with temperature. Roberts and Hoover [60] evaluated the effect of combinations of pressure at 400 MPa with heat against spores of *B. coagulans*; and at 25°C less than 1 log cycle reduction in the initial inocula was observed. As the



**FIGURE 34.6** Effect of temperature on the pressure inactivation of *Pseudomonas fluorescens* (150 MPa, 20 min), *Citrobacter freundii* (200 MPa, 20 min), and *Listeria innocua* (300 MPa, 20 min) inoculated in minced beef muscle. *N/g*: number/g meat. (Adapted from A. Carlez et al., *Lebensm. Wiss. Technol.* 26:357, 1993.)

temperature during pressurization increased, the effectiveness of the high-pressure treatment increased; 2 and 4 log cycle reductions were observed at 45°C and 70°C, respectively.

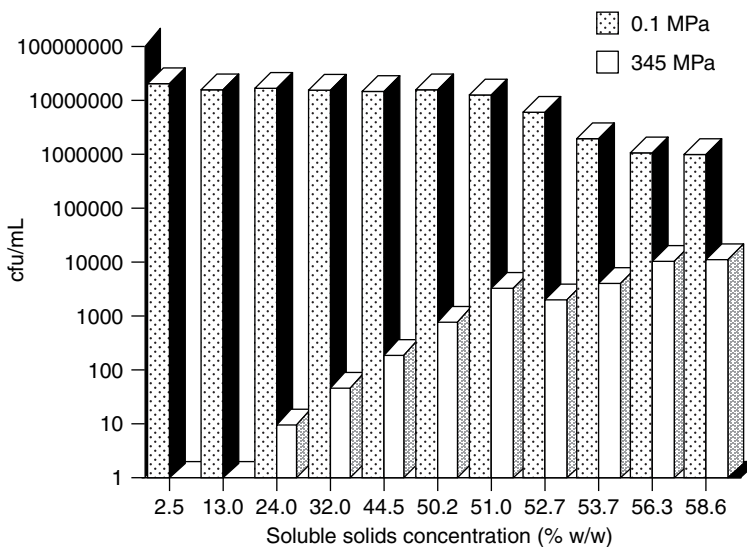
#### 34.3.1.1.4 Composition of Suspension Media or Food

The effect of pressure on inhibition or inactivation of microorganisms in combination with major environmental variables should be analyzed for a better understanding of the mode of action of this preservation technique. The extent of microbial reduction achieved by a high-hydrostatic-pressure treatment depends on a number of interacting factors, including the composition of the media or food [44,45]. Hoover et al. [4], Oxen and Knorr [61], Patterson et al. [3], Pothakamury et al. [6], and Palou et al. [44,45] stated that many food constituents appear to protect microorganisms from the effects of high pressure. Therefore, it is important to evaluate high-hydrostatic-pressure treatments for each individual case.

Dring [62] observed that nonnutritive solutions reduce the microorganism's barotolerance; and Marquis [63] reported that an enriched media protects microorganisms against pressure and suggested that free amino acids and vitamins are available and therefore the cells are protected. Hashizume et al. [56], Ogawa et al. [57], and Oxen and Knorr [61] observed that the pressure resistance of fungi increases as the sugar (sucrose, fructose, glucose) concentration in the media increases.

A baroprotective effect of reduced water activity for organisms that can grow at reduced  $a_w$  has been reported [10,11,14,44,45,64]. Oxen and Knorr [61] observed that high-hydrostatic-pressure treatment at room temperature and 400 MPa for 15 min inactivated the yeast *Rhodotorula rubra* when the  $a_w$  of the suspension media was higher than 0.96, while the number of survivors was higher when the  $a_w$  was depressed. Similar treatment at 30°C achieved 7 log cycle reductions in the initial inocula at  $a_w$  0.96, 2 log cycles were reduced at  $a_w$  0.94, and no reductions were observed when the  $a_w$  of the suspension media was 0.91 [14]. At higher temperatures (45°C), the yeast was inactivated even at low  $a_w$  values. Knorr [14] demonstrated that pressure–temperature combination treatments result in faster and greater yeast inactivation in comparison with treatments where only temperature or pressure is applied. For heat inactivation, treatments for 15 min at 70°C–80°C and atmospheric pressure were required to inhibit *R. rubra*.

Palou et al. [44] reported the effect of reduced  $a_w$  (or increasing soluble solids concentration) on *Zygosaccharomyces bailii* inhibition suspended in laboratory model systems adjusted to pH 3.5. Figure 34.7 presents the effect of the model system soluble solids concentration on the viability of *Z. bailii* without (0.1 MPa) and with a high-pressure treatment of 5 min at 345 MPa. *Z. bailii* grew well without the pressure treatment in the range of sugar concentrations studied (2%–59% w/w), rapidly reaching high



**FIGURE 34.7** Effect of soluble solids concentration and high pressure (345 MPa, 5 min) on the viability of *Zygosaccharomyces bailii*. (Adapted from E. Palou et al., *Lett. Appl. Microbiol.* 24:417, 1997.)

counts ( $\sim 10^7$  cfu/mL). This yeast is osmotolerant and its growth occurs in media containing up to 60% (w/w) glucose, with  $a_w$  0.85. The soluble solids concentration in the model system considerably affects the recovery counts after high-pressure treatment, being higher as the soluble solids concentration increased. Greater counts were observed for the experiments with sugar concentrations  $>40\%$ . In experiments with less than 20% soluble solids, complete inhibition ( $<10$  cfu/mL) of *Z. bailii* was observed. Ogawa et al. [57] reported that for *S. cerevisiae* inoculated in concentrated fruit juices, the number of surviving microorganisms depends on the juice-soluble solids concentration and observed that the inactivation effect at pressure  $\leq 200$  MPa decreased as juice concentration increased. Hashizume et al. [56] also reported an increase in the number of surviving *S. cerevisiae* cells with increasing concentrations of sucrose (0%–30% w/w) when pressurized at 260 MPa for 20 min at 25°C.

Palou et al. [44] reported a linear relationship between the water activity depression factor ( $1 - a_w$ ) and the log of *Z. bailii* survival fraction ( $N/N_0$ ) after a high-pressure treatment at 345 MPa for 5 min:

$$\log(N/N_0) = -4.599 + 45.538(1 - a_w) \quad (34.2)$$

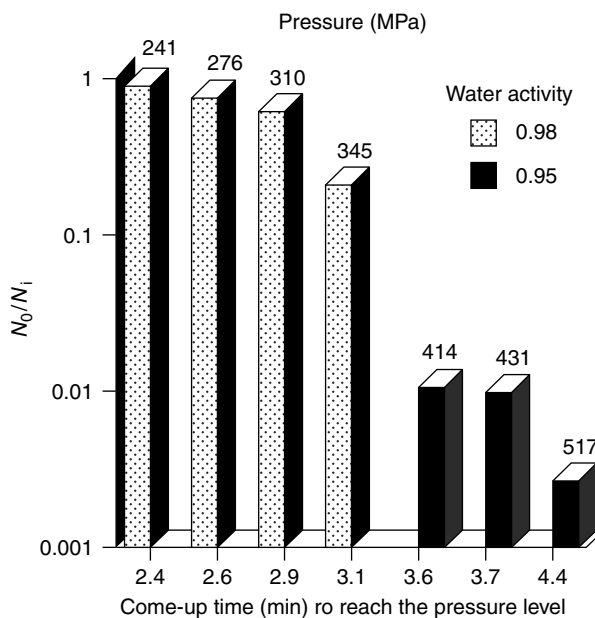
This relationship indicates that as  $a_w$  of the model system decreased, the number of surviving *Z. bailii* increased. The results obtained by Palou et al. [44] without pressure treatment demonstrate that *Z. bailii* was adapted to grow at the selected  $a_w$  values; therefore, the observed high-pressure effects can be attributed to this variable and not to the effects of reduced  $a_w$  on the extension of the lag phase or on the reduction of the growth rate. At  $(1 - a_w) > 0.07$ , reductions smaller than 1 log cycle were observed [44]. In comparison, Pandya et al. [65] reported for *Z. bailii* suspended in buffer solutions ( $a_w \sim 1.0$ ) with pH 4.0, 5.0, and 6.0 that 7 log cycles were reduced in treatments at 304 MPa for 10 min, resulting in the total inhibition of the initial inocula. The resistance to inhibition at reduced  $a_w$  values may be attributed to cell shrinkage, which probably causes a thickening in the cell membrane that reduces membrane permeability and fluidity [44]. The increased baroresistance of microorganisms at low  $a_w$  may also be attributed to partial cell dehydration due to the osmotic pressure gradients between the internal and external fluids, which may result in small cells and thicker membranes, and an increased pressure resistance [14]. The baroprotective effect of reduced  $a_w$  reveals that inhibition of microorganisms by high pressure depends not only on the pressure level and extent of the treatment, but also on the interactions with other intrinsic and extrinsic variables that influence the microbial response [44]. The design of effective pressure treatments that assure microbial stability of foods will depend on an understanding of the relationships between microorganisms and food components.

#### 34.3.1.1.5 Kinetics of Microbial Inactivation

The patterns of high-hydrostatic-pressure inactivation kinetics observed with different microorganisms are quite variable. Some investigators indicate first-order kinetics in the case of several bacteria and yeast [52,55,56,66]. Other authors observed a change in the slope and a two-phase inactivation phenomenon, the first fraction of the population being quickly inactivated, whereas the second fraction appears to be much more resistant [9]. The pattern of inactivation kinetics is also influenced by pressure, temperature, and composition of the medium [54]. For a broader use of high pressure in food processing, it is of special interest to determine the process conditions for pressure pasteurization in view of industrial applications [9]. To increase microbial safety and assure microbial stability of foods processed by high pressure, the pressure treatment must ensure a satisfactory reduction in the initial microbial counts; thus, kinetic analysis and the pressure dependence of microbial-inactivation rates are needed.

Several scientific reports [41,48,67] demonstrate the efficacy of high-hydrostatic-pressure treatments against different microbial species. However, few of them reported kinetic data, which would be necessary for the product and process design. For low-acid foods in particular, the kinetic information for pathogenic bacteria and spores will be indispensable in terms of food safety. The kinetic nature of high-pressure inhibition and inactivation may be different from that detected in heat treatment and other food processing methods. Deviations from first-order kinetics, occurrence of survivor “tails” in death kinetics, and the possibility of cell recovery after pressurization have been observed [3,42].

Earnshaw [42] stated that there is clear evidence from his and other laboratories that pressure-mediating death is not first order, and inactivation curves often present pronounced survivor tails. Thus, the  $D$  and  $z$  concepts commonly used in thermal processing cannot be usefully applied to describe pressure processes. However, there is a difference with heat-treatment kinetic evaluation and sampling, and therefore the survivor



**FIGURE 34.8** Effect of initial water activity ( $a_w$ ), pressure, and come-up time on *Zygosaccharomyces bailii* initial population reduction ( $N_0/N_i$ ).  $N_0$  = Yeast count (cfu/mL) after the come-up time for the working pressure,  $N_i$  = yeast initial population (cfu/mL). (From E. Palou et al., *Lebensm. Wiss. Technol.* 30:703, 1997.)

enumeration is not continuous. Determination of microbial pressure-inactivation kinetics depends on pressure increase and decrease rates since it includes a decompression step to perform sampling. The pressure increase and decrease are not always reported, and the come-up time to reach the pressure is therefore not always taken into account in the logarithmic representation of the number of survivors. Cheftel [9] also mentioned that some publications do not indicate precisely and fully the experimental variables such as pressure, temperature, and time conditions. Moreover, Earnshaw [42] notes that in experiments that evaluate high-pressure-inactivation kinetics, the starting population must always be given. Cheftel [9] suggested that only inoculation with high numbers of a specific strain permits precise determination of the extent of inactivation as a function of processing conditions.

In many reported survival curves, it is unclear if time zero experiments are growth controls without pressure treatment or are pressure treatments that only take into account the come-up time to reach the pressure level. Figure 34.8 presents the come-up times for pressure treatments ranging from 241 to 517 MPa [68] and the time to release the pressure was less than 15 s. The pressure come-up times exert an important effect on the yeast survival fraction. *Z. bailii* counts decreased as pressure increased; and at pressures greater than 414 MPa, 2 log cycle reductions were observed. Cheftel [9] reported that the rate of pressure increase and decrease is often neglected as an experimental variable in high-pressure microbial-inactivation studies and the initial population ( $N_i$ ) can be notably reduced during the come-up time (Figure 34.8). Palou et al. [45] reported an important effect of the come-up time at pressures of 345 and 517 MPa on *Z. bailii* log reductions in a food model system ( $a_w$  0.98 and 0.95, pH 3.5). Furthermore, total inhibition of the initially inoculated cells was achieved when only the time to reach 689 MPa was applied. Therefore, the effects of the rate of pressure increase and decrease need to be evaluated and reported.

Palou et al. [68] observed first-order kinetics for *Z. bailii* inoculated in food model systems with pH 3.5 and  $a_w$  0.98 and 0.95. The logarithm of the survival fraction decreased linearly with time, and yeast cells were inactivated more rapidly with increasing pressure treatments (Figure 34.9). The experimental points with a pressure treatment duration of "0 min" express the effect of the come-up time to reach the working pressure and correspond to the initial population ( $N_0$ ) for the kinetic analysis. Hashizume et al. [56] observed that pressure-inactivation kinetics for *S. cerevisiae* at 25°C and  $a_w$  0.99 follows a first-order kinetic model. The death velocity constants or inactivation rates ( $k$ ) can be calculated from the reciprocal of the slope of the survival curves following a traditional kinetic analysis. Table 34.4 presents the velocity constants reported by Palou et al. [68] for *Z. bailii* and those calculated from the data reported by Hashizume et al. [56].

As can be seen, the  $k$  values suggest that *S. cerevisiae* is more pressure resistant than *Z. bailii*. To compare the effectiveness of pressure treatments and optimize process conditions, the calculation of  $D$  values can be used to compare the resistance of microorganisms. By analogy with the analysis of thermal destruction or inactivation of microorganisms, a decimal reduction time ( $D$  value) can be defined as the time needed to reduce 90% of the initial population and can be calculated as  $D = 2.303/k$ .

Calculated  $D$  values for *Z. bailii* [68] and *S. cerevisiae* [56] are presented in Table 34.4. Other reports detected first-order inactivation rates and decimal reduction times for bacterial inactivation with high hydrostatic pressure. Carlez et al. [52] observed that the number of surviving *Pseudomonas fluorescens*, *Citrobacter freundii*, and *L. innocua* inoculated in a minced meat product decreased exponentially with process time. Carlez et al. [52] reported decimal reduction times at 20°C of  $D_{230 \text{ MPa}} = 14.7$  min for *C. freundii*,  $D_{250 \text{ MPa}} = 23.8$  min for *P. fluorescens*, and  $D_{230 \text{ MPa}} = 6.5$  min and  $D_{360 \text{ MPa}} = 5$  min for *L. innocua*. Smelt and Rijke [55] reported first-order kinetics for high-pressure inactivation of *E. coli* in a physiological saline solution at 20°C, with  $D$  values of 25.9, 8.0, 2.5, and 0.8 min for treatments at 200, 250, 300, and 350 MPa, respectively. The pressure resistance of microorganisms depends on the type of microorganism and composition of the suspension media. Many factors that could affect the microbial response under high-pressure treatments, such as temperature, gas solubility, ionic strength, pH, and cavitation, are also modified by pressure. Thus, the microbial inactivation curves that can be obtained during a high hydrostatic pressure treatment also depend on these factors.

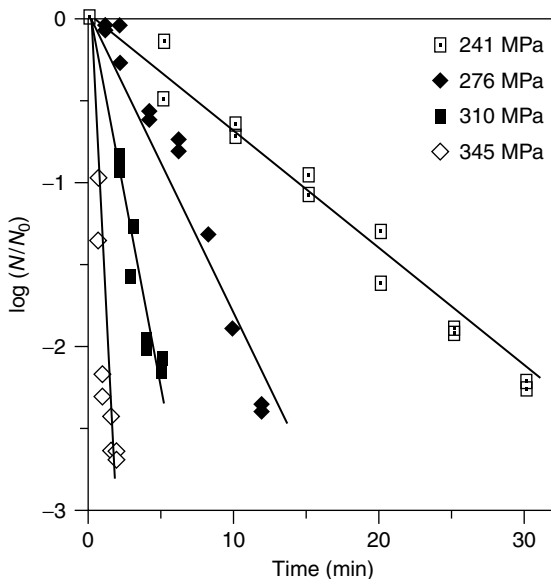


FIGURE 34.9 First-order pressure-inactivation kinetics of *Zygosaccharomyces bailii* in a laboratory model system with water activity 0.98 and pH 3.5. (Adapted from E. Palou et al., *Lebensm. Wiss. Technol.* 30:703, 1997.)

TABLE 34.4

Effect of Initial Water Activity ( $a_w$ ) and Pressure on Inactivation Rates ( $k$ ) and Decimal Reduction Times ( $D$ ) of *Zygosaccharomyces bailii* at 21°C and *Saccharomyces cerevisiae* at 25°C

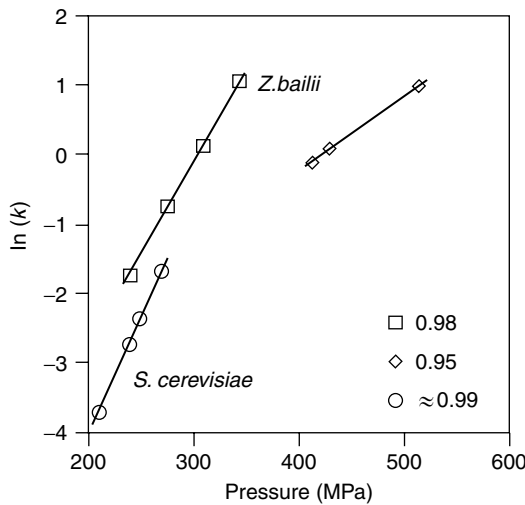
$a_w$	Pressure (MPa)	$k$ ( $\text{min}^{-1}$ )	$D$ (min)
<i>Z. bailii</i> <sup>a</sup> 0.98	241	0.176	13.12
	276	0.478	4.82
	310	1.128	2.04
	345	2.833	0.81
	414	0.902	2.55
0.95	431	1.099	2.09
	517	2.645	0.87
<i>S. cerevisiae</i> <sup>b</sup> $\approx 0.99$	210	0.025	94.00
	240	0.067	34.63
	250	0.094	24.60
	270	0.187	12.30

<sup>a</sup>From Ref. [68].

<sup>b</sup>From Ref. [56].

Figure 34.10 presents the fit of the experimental data obtained from Palou et al. [68] and Hashizume et al. [56] to Equation (34.2). The positive slope obtained from the plots of pressure inhibition rates ( $\ln/k$ ) versus pressure, and therefore a negative activation volume, indicates that a decrease in volume is related to the yeast-inhibition process. The activation volumes reported by Palou et al. [68] are presented in Table 34.5. The values obtained are quite different between system compositions and between yeast species. The apparent  $\Delta V^*$ , calculated considering the activation process of microbial inhibition as one step, indicates the volume variation between the “activated volumes” and initial states of the yeast pressure inhibition “reaction” [68]. A negative activation volume represents a reaction favored by increased pressure, so a reaction with a greater absolute  $\Delta V^*$  value indicates that increments in pressure can accelerate the response—in this case the yeast inactivation rate.

A “pressure  $z$  value” can be defined as the pressure increment needed to reduce or increase the  $D$  value by a factor of 10 and is calculated as the reciprocal of the slope in a plot of  $\log D$  versus pressure. Table 34.5 also presents  $z$  values for *Z. bailii* in food model systems at  $a_w$  0.95 and 0.98 [68]. The  $z$  value for yeast inactivation in media with  $a_w$  0.98 was 2.6 times smaller than that obtained for media with  $a_w$  0.95, showing that *Z. bailii* was more pressure sensitive in the former condition. These results indicate that the composition of the media influences the microbial response under high-hydrostatic-pressure treatments and



**FIGURE 34.10** Effect of pressure and initial water activity on the inactivation rate ( $k$ ) of *Zygosaccharomyces bailii* at 21°C and *Saccharomyces cerevisiae* at 25°C. (From E. Palou et al., *Lebensm. Wiss. Technol.* 30:703, 1997; and C. Hashizume et al., *Biosci. Biotechnol. Biochem* 59:1455, 1995.)

demonstrates the baroprotective effect of high sugar concentration or reduced  $a_w$  reported by several authors [44,45,56,57,61,69]. The  $z$  value (68 MPa) calculated from the data reported by Hashizume et al. [56] indicates that *S. cerevisiae* is more sensitive to changes in pressure than *Z. bailii*, which can be attributed to response differences between microorganisms to high-pressure treatments and composition of the suspension medium.

In biological systems, the volume changes associated with ionization can be involved in the mechanism of microbial inactivation [45]. Enhanced ionization under high-pressure treatments is reported for water and acid molecules [70]. Palou et al. [68] mentioned that in the conditions of their work, and knowing that during pressurization a decrease in the  $pK_a$  of acids and pH reduction is expected, a temporary reduction in pH and an increase in the dissociated form of the acid can be present during pressurization. The pH changes could enhance the effects of high-pressure treatments on microorganisms and favor the first-order kinetics observed for pressure inactivation of *Z. bailii*.

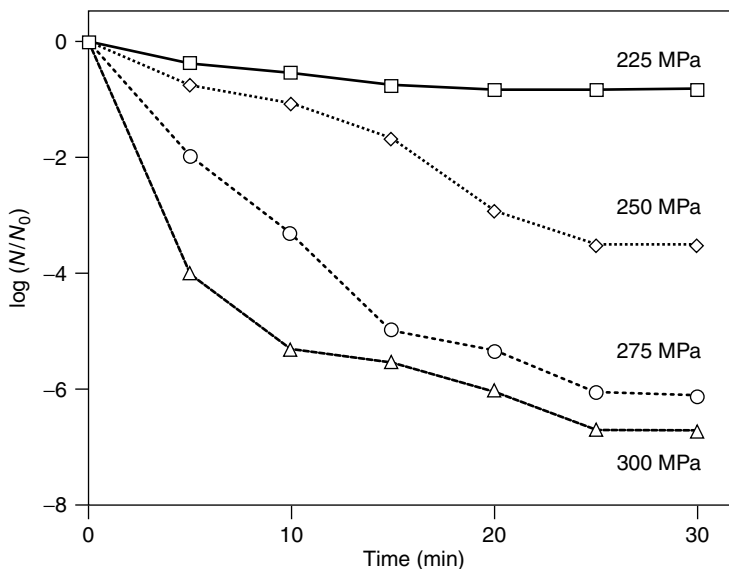
**TABLE 34.5**

Activation Volume ( $\Delta V^*$ ) and  $z$  Values of *Zygosaccharomyces bailii* at 21°C and *Saccharomyces cerevisiae* at 25°C

$a_w$	Pressure Range (MPa)	$\Delta V^*$ ( $\text{cm}^3 \text{mol}^{-1}$ )	$z$ (MPa)
<i>Z. bailii</i> <sup>a</sup>	0.98	241–345	-65.2
	0.95	414–517	-25.3
<i>S. cerevisiae</i> <sup>b</sup>	≈0.99	210–270	-83.9

<sup>a</sup>From Ref. [68].

<sup>b</sup>From Ref. [56].



**FIGURE 34.11** Effect of pressure on the inactivation of *Yersinia enterocolitica* in 10 mM buffered saline solution (pH 7.0) at 20°C.  $N$  = Number of survivors;  $N_0$  = initial number of microorganisms. (Adapted from M. F. Patterson et al., in *High Pressure Processing of Foods*, Nottingham University Press, Nottingham, p. 47, 1995.)

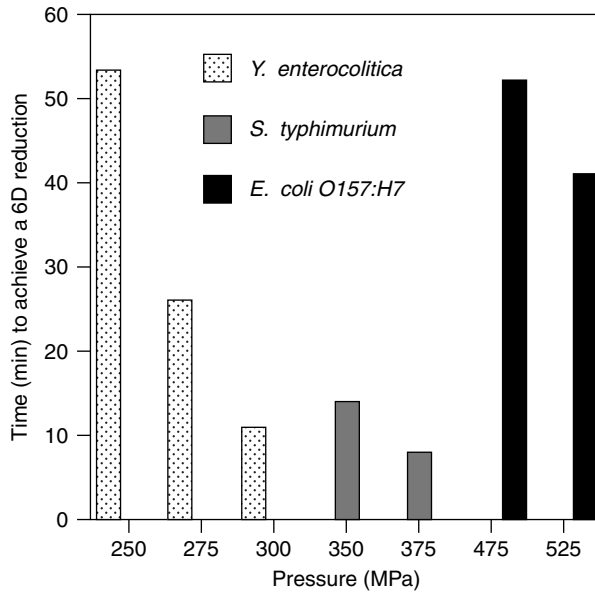
Earnshaw [42], Isaacs et al. [51], Metrick et al. [67], and Patterson et al. [3] reported that for several process conditions and different microorganisms, the inactivation curves do not follow a first-order kinetics pattern. Figure 34.11 presents a comparison of high-pressure treatments at 20°C for *Yersinia enterocolitica* suspended in a pH 7.0 phosphate buffer [3]. Similar exponential decay curves have been reported for *E. coli*, *L. monocytogenes*, *S. typhimurium*, and *S. enteritidis* by the same authors at relatively high pressures. As can be seen for treatments at 275 and 300 MPa, the survival curves cannot be described by linear relations; various authors have proposed logistic models to describe this pattern. However, the reliability of the logistic model for other organisms under different conditions and process variables needs to be investigated [71]. If the logistic model describes the experimental data, the time required to reduce the initial population by a factor of 10 ( $D$  value) can be calculated and used as a comparison parameter. Figure 34.12 presents the process time required to achieve a  $6D$  reduction in the initial inocula for three pathogens reported by Patterson et al. [3].

There are a number of possible theories to explain the tail effect [42]: tailing is a normal characteristic associated with the inactivation or resistance mechanisms, is independent of the mechanisms of survival or inactivation, and is the result of microbial population heterogeneity or is the result of experimental errors. Another possible reason for tailing is microbial adaptation and recovery during and after pressure treatment.

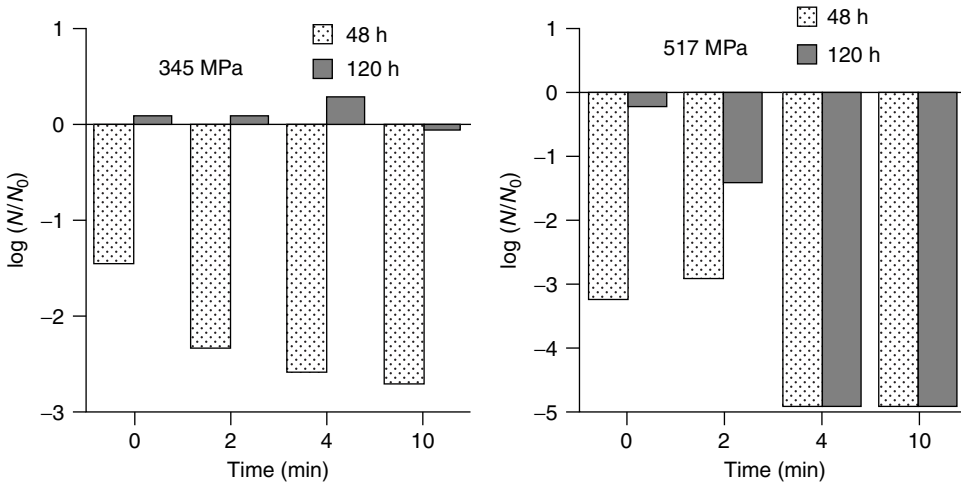
#### 34.3.1.1.6 Microbial Cell Recovery after Pressurization

The high-hydrostatic-pressure effects on microorganisms are often determined by plate counts, and usually dilution and plating are made just after treatment. Survival, as measured immediately after pressure release, may differ from that determined after a repair period in the food or in an enriched medium [9]. Recovery after pressure treatment is a very important consideration for process efficacy and death kinetics assessment [3]. Metrick et al. [67] suggested that the lack of nutrients in phosphate buffer prevents the recovery of the pressure-damaged cells. The ultimate fate of the injured cells will depend on the conditions after pressure treatment. However, the fact that pressure can cause injury may be advantageous when high hydrostatic pressure is combined with other preservation methods [3].

The possibility of cell recovery exists, and in many cases pressure-treated microorganisms may not be detected in plate count methods because of their failure to initiate growth when they are plated immediately after treatment. However, if the repair mechanism remains intact, the microorganisms may be capable of regeneration and growth. Isaacs et al. [51] observed that for *E. coli* suspensions treated at 200 MPa



**FIGURE 34.12** Predicted time to achieve a 6D reduction in the initial population of pathogenic bacteria suspended in a pH 7.0 phosphate buffer and subjected to high-hydrostatic pressure treatments. (Adapted from M. F. Patterson et al., in *High Pressure Processing of Foods*, Nottingham University Press, Nottingham, p. 47, 1995.)



**FIGURE 34.13** Effect of high-pressure treatments (345 and 517 MPa) on the log of the *Zygosaccharomyces bailii* survival fraction ( $N/N_0$ ) after a recuperation period of 48 and 120 h at 25°C. (From E. Palou et al., *J. Food Sci.* 62:855, 1997.)

for 0–6 min and plated on selective (Mac-Conkey and eosin methylene blue agars) and nonselective (tryptone soya agar) media, the survival fraction was greater for bacteria plated on the nonselective agar. This was attributed to the inhibitory ingredients contained in the selective media, indicating that there is a proportion of microorganisms that, after pressurization, can repair and reproduce, whereas the added stress caused by culturing on selective media inhibits the repair process.

Figure 34.13 indicates that for pressure treatments that lead to significant reductions in the initial population of *Z. bailii*, but not enough to inactivate the initially inoculated cells, further incubation reveals that the survivors can grow [45]. Yeast cells subjected to physical or chemical hurdles may become injured or sublethally stressed, the recovery of these cells requires generally more incubation time and the injured survivors are capable of growth even in systems with 1000 ppm potassium sorbate and



reduced  $a_w$ . In treatments rendering complete inhibition of *Z. bailii* at  $10^5$  cfu/mL after 48 h, the same result was obtained with a longer (120 h) incubation period [45]. Carlez et al. [53] demonstrated that minced meat (inoculated with *Pseudomonas* strains) treated for 20 min at 300 or 450 MPa exhibited no microbial growth after 2 or 6 days of storage, respectively, when stored at 3°C. However, the *Pseudomonas* counts increased with longer storage. The lag time before reappearance of microbial growth was related to the intensity of the pressure treatment. Carlez et al. [53] defined two different pressure levels: a lower one that causes microbial injury and delays growth and a higher one that induces complete inactivation of vegetative microorganisms.

### 34.3.1.2 Microbial Spores

Bacterial spores have demonstrated pressure resistance [59,72], and it has been suggested that spore proteins are protected against solvation and ionization. The structure and thickness of the bacterial spore coats are believed to account for this high resistance. Microbial spores suspended in foods and laboratory model systems could be inactivated by high-pressure treatments, but compared with the requirements for vegetative cells the treatment conditions must be extreme: higher pressures and long exposure times at elevated temperatures [73]. Hydrostatic pressure can cause spore germination. Some authors suggested a high-pressure treatment to induce spore germination and a subsequent treatment to inactivate the germinated microorganisms [10,11]. Gould and Sale [72] studied the germination of *Bacillus* spores and demonstrated that treatments at 25 MPa and 50°C for 30 min cause the germination of 50%–64% of the initially inoculated spores.

Crawford et al. [74] reported a decrease in viable *Clostridium sporogenes* spores with increasing pressure, up to 690 MPa; but higher pressures were ineffective in further reducing the spore counts. Crawford et al. [74] postulated that spore germination occurred at pressures lower than 690 MPa and the germinated cells were inactivated by the pressure treatment, leading to a maximum reduction in the initially inoculated spore counts. At higher pressures, a small fraction of the spore population may have remained highly resistant and capable of resisting pressures of 830 MPa. When pressure–temperature were combined at 690 MPa and 80°C for 20 min, the treatment was more effective, with a significant reduction in the *C. sporogenes* spore count [74]. Mallidis and Drizou [75] confirmed the extraordinary pressure resistance of *B. stearothermophilus* spores and concluded that the simultaneous application of moderate pressure (up to 30 MPa) and heat cannot be used as a preservation method, since the effect of pressure on the reduction of heat resistance is low at high temperatures. Nakayama et al. [76] observed no appreciable reductions in the spore viability for six *Bacillus* strains, including *B. stearothermophilus*, *B. coagulans*, *B. subtilis*, *B. licheniformis*, and *B. megaterium*, in pressure treatments at 5°C–10°C for 40 min up to pressures of 981 MPa or at 588 MPa for 120 min. Therefore, there is no possibility of pressure sterilization of low-acid foods at low temperatures. Hayakawa et al. [78] reported successful treatments for *B. stearothermophilus* spores when pressure treatments were combined with moderate temperature (70°C). Pressure treatments were 4–6 compression–decompression cycles at 600 MPa with 5 min of holding time. These treatments reduced by 6–7 log cycles the initial inocula. Lechowich [79] mentioned that there are no published reports on the high-pressure resistance of *C. botulinum* spores, and their ability to support high pressure at low or high temperatures is unknown. There is a need for data concerning the high-pressure resistance of *Bacillus* and *Clostridium* spores. With this information, the safety aspects of high-hydrostatic-pressure treatment on low-acid foods can be documented [79].

Spores from yeast and molds are easily inactivated at pressures of 300 (*Aspergillus oryzae*) or 400 MPa (*Rhizopus javanicus*) at ambient temperatures [9]. However, Butz et al. [80] demonstrated that ascospores of heat-resistant molds such as *Byssoschlamys nivea* are extremely pressure resistant. For the inactivation of *B. nivea* ascospores, pressures above 600 MPa and temperatures above 60°C were needed. No effects on spore viability after treatment at 70°C and 500 MPa for 60 min were observed; around 3 log cycle reduction was observed at 600 MPa after 60 min; approximately 5 log cycles were reduced at 700 MPa; and total and rapid inactivation of *B. nivea* within a few minutes (<10) were observed at 800 MPa.

Bacterial spores represent a challenge for high-pressure technology and more information about their resistance is required. Data are needed on the destruction of *C. botulinum* spores and the most resistant spore-forming species, and studies of the high-pressure process need to include inoculation and challenge testing.

### 34.3.1.3 High-Pressure Mechanism of Action

In the inactivation of microorganisms by high pressure, the membrane is the most probable site of disruption [4]. Inactivation of key enzymes, including those involved in DNA replication and transcription, is also mentioned as a possible inactivating mechanism [4]. The lethal effect of high pressure on vegetative microorganisms is thought to be the result of a number of possible changes taking place simultaneously in the microbial cell [3]. Shimada et al. [81] suggested that the structural impact of the high hydrostatic pressure on yeast cells occurred directly in the membrane system, particularly in the nuclear membrane. Besides membrane damage, a decrease in pH due to the enhancement of the ionic dissociation resulting from electrostriction (pressure causes the separation of electrical charges because the electrical charges “organize” water molecules around them, with a resulting decrease in the total volume of the system) during high-pressure treatments was reported by Cheftel [9]. Smelt [82] observed that the intracellular pH decreased under pressurization and associated the pH drop with the loss of ATPase activity and the reduction of the proton efflux from the cell interior. Knorr [10] reported that the reduced Na/K ATPase activity during and after pressurization can be related to a decrease in the bilayer membrane fluidity. Smelt [82] postulated that to maintain the internal pH homeostasis, the membrane-bounded ATPase acts as an ion pump. High pressure can denature the enzyme or cause dislocation in the membrane, thus microbial cells could die by internal acidification.

Microbial death is attributed to permeabilization of the cell membrane after high-pressure treatment [5]. Pressure affects several biochemical reactions and this kind of disturbance may be attributed to volume changes during compression; thus, any biological process would be affected when high pressure is applied [4]. Farr [5] established that protein denaturalization can be attributed to changes in the chain conformational arrangement. Water pH is reduced from 7.00 (0.1 MPa and 25°C) to 6.27 when 101 MPa is applied [63], and water volume is also reduced as shown in Figure 34.4. These effects can also contribute to microbial inactivation by high pressure.

High-hydrostatic-pressure treatments can alter membrane functionalities such as active transport or passive permeability, and therefore perturb the physicochemical balance of the cell [83]. The physical state of the lipids that surround membrane proteins plays a crucial role in the activity of membrane-bound enzymes, and there is considerable evidence that pressure tends to loosen the contact between attached enzymes and membrane surfaces as a consequence of the changes in the physical state of lipids that control enzyme activity [35]. Jaenicke [84] reported that pressures in the range of 101–304 MPa denature several enzymes, and treatments at 304 MPa make the phenomenon irreversible. The activity of succinate, formate, and malate dehydrogenases in *E. coli* decreases with an increase in pressure. The dehydrogenases are completely inactivated when subjected to a pressure of 100 MPa for 15 min at 27°C [85]. Thus, the microbial inactivation mechanism by high pressure can be attributed, at least partially, to enzyme inactivation [4].

Perrier-Comet et al. [83] observed that yeast cell volume variations during pressure treatment at 250 MPa for 15 min can be divided into three phases. In the first phase, volume decrease occurs during the come-up time to reach the pressure and the second phase occurs during the holding time, when the cell volume still decreases although pressure remains constant. This volume decrease is attributed to mass transfer between the external and cellular media. A third phase of volume variation is attributed to membrane compression. The initial cell volume is not recovered during decompression or after returning to atmospheric pressure. An irreversible mass transfer (mainly water) occurs during the holding time of a pressure-treatment process.

High-pressure treatment also induces morphological changes in microbial cells. Separation of the cell wall and disruption in the homogeneity of the intermediate layer between the cell wall and the cytoplasmic membrane occur. Isaacs et al. [51] demonstrated with electron microscopy studies that ribosomal destruction in cells of *E. coli* and *L. monocytogenes* results in metabolic malfunctions that can cause cell death. Mackey et al. [86] also observed by electron microscopy that the nuclear material appearance changes considerably in *L. monocytogenes* and *Salmonella thompson* after being treated at 500 MPa for 10 min. Hayakawa et al. [78] reported morphological changes in the *B. stearothermophilus* spore surface after pressurization for six cycles of 5 min each under 600 MPa at 70°C and observed that every spore was completely ruptured after this process. These observations were attributed to a weakening of the physical strength of the spore coat and rupture of the coat as a result of the pulsed pressure treatment.

For *Schizosaccharomyces pombe*, after treatment at 100 MPa the nuclear membrane was damaged and fragmented [87]. In the same study, pressure treatment above 250 MPa dramatically changed the cytoplasmic substance—the cellular organelles could hardly be detected and the fragmented nuclear membrane was barely visible. The outer cell shape, observed by scanning electron microscopy (SEM), of *S. cerevisiae* was almost unaffected by high-pressure treatments up to 300 MPa; but at pressures higher than 500 MPa there was disruption and damage to the cell wall [81]. Transmission electron microscopy (TEM) revealed that the inner structures were damaged, especially the nuclear membrane, even at 100 MPa [81]. The damage profile of high-pressure treatments revealed that *S. pombe* cells were more affected at low-pressure stresses than were *S. cerevisiae* cells [87].

Isaacs et al. [51] observed that pressure treatments at 200–400 MPa cause leakage of UV-absorbing materials from *E. coli* cells. Shimada et al. [81] reported that leakage of intracellular UV-absorbing substances from *S. cerevisiae* began to be released at relatively low pressures (100 MPa). When pressure was increased to 200 MPa for 10 min, the leakage gradually increased. Leakage of internal substances was related to cell viability and at 300 MPa most of the *S. cerevisiae* cells were inactivated, corresponding to the great concentration of UV-absorbing substances. This can be attributed to increased permeability and fluidity and might also provide evidence about the mechanism of high-pressure inactivation [70].

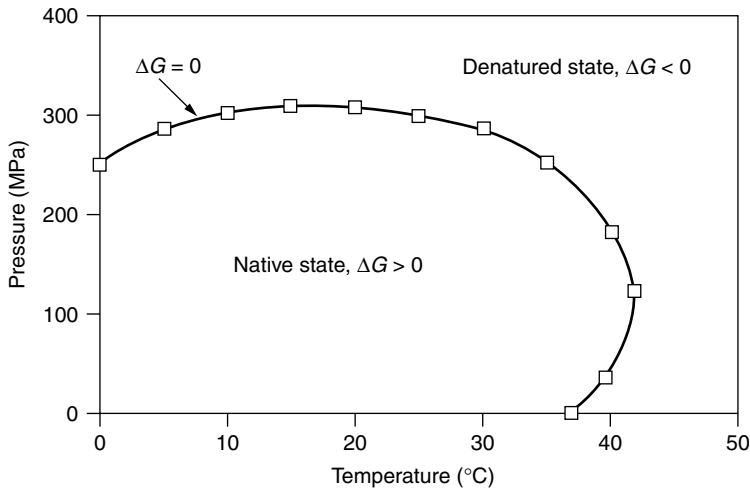
To explain the response of microorganisms to different pressures, high-pressure effects on several biological molecules have been studied. Protein denaturation, lipid phase change, and enzyme inactivation can perturb the cell morphology, genetic mechanisms, and biochemical reactions. However, the mechanisms that damage the cells are still not fully understood [83].

### 34.3.2 Chemical and Biochemical Reactions

The application of pressure influences biochemical reactions since most of these reactions involve a change in volume. Hoover et al. [4] reported that pressure affects reaction systems in two apparent ways: by reducing the available molecular space and by increasing interchain reactions. Thus, reactions involved with the formation of hydrogen bonds are favored by high pressure since bonding results in a decrease in volume [4]. However, Masson [88] reported that hydrogen bonds are insensitive to pressure. Cheftel [9] mentioned that various biochemical studies indicate that pressures above 100–200 MPa often cause (a) the dissociation of oligomeric structures into their subunits, (b) partial unfolding and denaturation of monomeric structures, (c) protein aggregation, probably as a consequence of unfolding, and (d) protein gelation if protein concentration and pressure are high enough.

High pressure can denature protein molecules. Pressure denaturation of proteins is a complex phenomenon depending on the protein structure, pressure range, temperature, pH, and solvent composition. Oligomeric proteins are dissociated by relatively low pressures (200 MPa), whereas single-chain protein denaturation occurs at pressures greater than 300 MPa. Pressure-induced denaturation is sometimes reversible, but renaturation after pressure release may take a long time. Protein denaturation becomes irreversible beyond a given pressure threshold, which depends on the protein, or at high protein concentrations that enhance aggregation [9]. Figure 34.14 presents a schematic diagram illustrating the effect of temperature on the denaturation of proteins. This kind of diagram delimits regions where the protein is active or denatured; at high temperature, pressure stabilizes the protein against temperature denaturation [9,35]. Heremans [35] mentioned that the fact that one can “cook” an egg with pressure is the result of the unique phase diagram of proteins. There is evidence that a similar phenomenon occurs with other biomolecules such as polysaccharides [35,89], microorganisms and bacteriophages [90], and phospholipids [35].

Pressure may affect the secondary, tertiary, and quaternary structure of proteins. The main targets of pressure are the electrostatic and hydrophobic bonds in protein molecules. High pressure causes deprotonation of charged groups and disruption of salt bridges and hydrophobic bonds, thereby resulting in conformational and structural changes of proteins. Structural transitions are accompanied by large hydration changes, which are the major source of volume decreases associated with dissociation and unfolding of proteins [88]. Hydrophobic interactions in proteins can be either disrupted or stabilized according to the magnitude of the applied pressure [39]. The disruptive effect of high hydrostatic pressure on the ionic and hydrophobic interactions and hydrogen bonds of milk casein micelles would allow independent movement of micelle fragments along with caseins and calcium phosphate [39] and cause a



**FIGURE 34.14** Schematic diagram illustrating the effect of temperature and pressure on the denaturation of proteins. (Adapted from K. Heremans, in *High Pressure Processing of Foods*, Nottingham University Press, Nottingham, p. 81, 1995.)

conformational change in proteins. In fresh milk, casein micelles are large complex structures consisting of many molecules of different individual caseins and calcium phosphate, maintaining the structural integrity. The structural and spatial distribution changes to the micelle components during pressurization would prevent recovery of the micelle original structures after high-pressure treatment [39].

Other food components that can be affected by high-pressure treatments are lipids. Ohshima et al. [91] observed that in cod muscles exposed to high-pressure treatments in the range of 202–608 MPa for 15 and 30 min, the peroxide value of the extracted oils increased with increasing pressure and processing time. The presence of fish muscle accelerates lipid oxidation after high-pressure treatments, while the isolated oil extract was relatively stable against autoxidation in treatments up to 608 MPa [92]. Cheah and Ledward [93] observed the effects of high-pressure treatments on lipid oxidation in rendered pork fat. Pork samples treated at 800 MPa for 20 min and stored at 50°C present a shorter induction time for lipid oxidation and greater peroxide and 2-thio-barbituric acid (TBA) values than untreated pork samples. When pork was stored at 25°C the induction periods were longer than at 50°C, and at 4°C after 8 months of storage the peroxide value was higher than in the untreated samples. The effects of  $a_w$  were also evaluated by Cheah and Ledward [93], who reported that after 4, 6, and 8 days of storage at 50°C, the lipid oxidation in terms of peroxide and TBA values of high-pressure-treated (800 MPa, 20 min) pork fat was inhibited to some extent at  $a_w$  values higher or lower than 0.44. In another study, Cheah and Ledward [94] reported that pressure treatments had little effect on lipid oxidation of minced pork, in terms of TBA value, below 300 MPa but increased proportionally at higher pressures. Pressure treatments in the range of 300–400 MPa appear to be critical for inducing marked changes in pork meat; many structural changes are induced at these pressures. These results may restrict the application of high-pressure technology for meat-based products due to induced oxidation, at least in the mentioned pressure range.

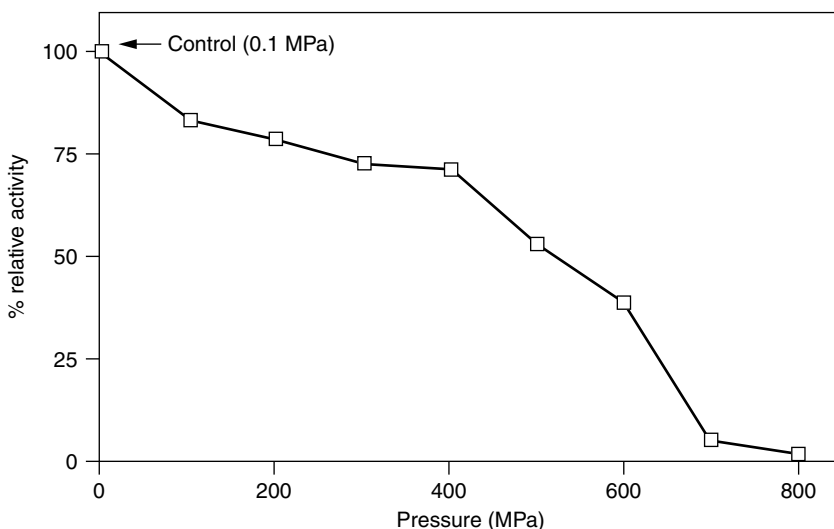
The application of high-hydrostatic-pressure treatments, in combination with moderate or elevated temperatures, may influence chemical reactions inherent to food systems such as the Maillard reaction. This reaction, which is manifested by the development of brown color in many processed foods, is known to be highly pH- and temperature-dependent. However, few studies have dealt with the effects of high pressure on the Maillard reaction. Tamaoka et al. [95] reported that brown color development was inhibited at pressures in the range of 200–400 MPa in xylose–lysine systems (pH 8.2) when heated at 50°C. They also pointed out that Maillard reactions involving xylose–lysine, xylose- $\beta$ -alanine, or glutaraldehyde- $\beta$ -alanine are inhibited by high-pressure treatments. Hill et al. [96] compared the rate of browning of glucose–lysine systems at 50°C, in the pH range of 5.1–10.1, with and without the application of high pressure at 600 MPa. Hill et al. [96] reported that at initial pH of 8.0 or 10.1, pressure enhances browning

while at pH 6.5 and 5.1 the effect is the opposite. At 600 MPa the rate of browning was reduced significantly. These observations were attributed to the pH decrease in the systems during pressurization. At pH 6.5 and 5.1, the system buffer capacity is due to the carboxylic acid group of the amino acid and decreases of about 1.2 pH units occurred. Hill et al. [96] also demonstrated by HPLC and UV spectra that the composition of the reaction products is similar in samples with the same intensity of browning, irrespective of whether the samples were treated with high pressure or not. Acid hydrolysis of proteins is enhanced under high-pressure treatment, whereas hydrolysis of cornstarch and locust bean gum is unaffected [12,97]. Pressure treatments at 392–490 MPa and temperatures of 45°C–50°C enhanced the susceptibility of wheat, corn, and potato starches to  $\alpha$ -amylase action [32].

### 34.3.3 Enzymatic Reactions

Exposure to high pressure may activate or inactivate enzymes. Pressure inactivation of enzymes is influenced by pH, substrate concentration, the subunit structure of the enzyme, and temperature during pressurization [4]. The effects of pressure on enzyme activity is thought to occur as a result of substrate–enzyme interaction. If the substrate is a macromolecule, then the effects may be on the conformation of the macromolecule, which can make the enzymic action easier or more difficult [35]. Pressure inactivation of enzyme can also be attributed to an alteration of intermolecular structures or conformational changes at the active site. Inactivation of some enzymes pressurized to 100–300 MPa is reversible. Reactivation after decompression depends on the degree of distortion of the molecule. The chances of reactivation decrease with an increase in pressure beyond 300 MPa [84,98].

Earnshaw [34] mentioned that of particular significance is the apparent lack of pressure effect on some food enzymes, including those that affect food quality, such as proteases, lipases, esterases, and oxidases. Some enzymes, such as phosphatase, are relatively pressure sensitive and can be inactivated by pressures in the range of 400–800 MPa. The enzymes alkaline phosphatase and lactoperoxidase have been successfully used as process markers in heat treatments of milk. Quality control markers such as these enzymes will be needed for high-pressure processing of dairy products. Figure 34.15 presents the effect of 20-min pressure treatments on alkaline phosphatase in raw milk; the enzyme activity decreases as pressure level increases. However, there is a need to establish microbial quality marker relations to ensure, for example, the destruction of *Mycobacterium tuberculosis* [99].



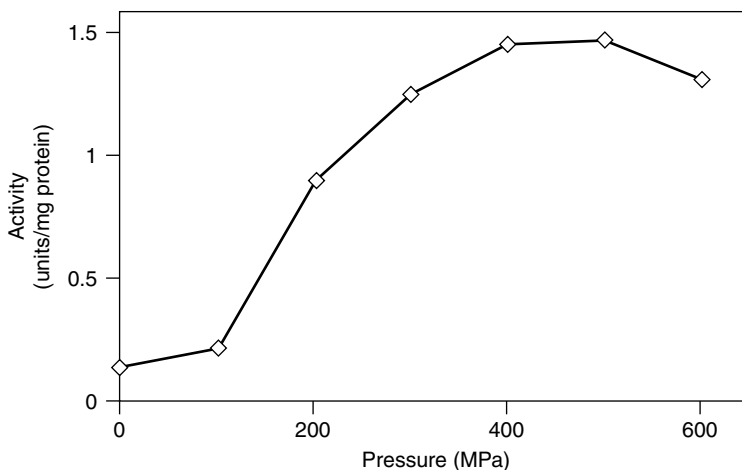
**FIGURE 34.15** Relative activity of enzyme alkaline phosphatase in raw milk after 20 min of pressure treatment. (Adapted from D. E. Johnston, in *High Pressure Processing of Foods*, Nottingham University Press, Nottingham, p. 99, 1995.)

Heremans and Heremans [100] reported that chymotrypsin is an enzyme that exhibits a pressure-induced conformational change. Its optimal activity is at neutral pH and the activity disappears at pH 10, which is attributed to rupture of the salt bridge in the vicinity of the active site. Raman spectroscopy studies indicated that pressure inactivates the enzyme due to the destabilizing effects of pressure on the salt bridge and revealed that below 400 MPa the conformational change is reversible [100].

Homma et al. [101] mentioned that high hydrostatic pressure is one of the new technologies that can be used for tenderizing meat or accelerating meat conditioning. Pressure induces changes in the muscle, which could be derived from physical force or increase in the proteolytic activity of meat enzymes. The proteolytic activity of enzymes in meat is enhanced by the application of high pressures [101]. The total activities of cathepsins B, D, and L, and acid phosphatase in the muscle increase when subjected to pressures ranging between 100 and 500 MPa for 5 min at 2°C. Cathepsin H and aminopeptidase B are resistant to pressure treatment. An increase in the activity of cathepsin B1 may account, in part, for the tenderization of meat by pressure-heat treatment [102]. Ashie et al. [103] reported a reduction in the proteolytic activity of fish muscle enzymes with increasing pressure in the range of 100–300 MPa (30 mm) and increasing crude inhibitor ( $\alpha_2$ -macroglobulin) concentration (0.1%–0.3%) at constant pH (5.5, 6.0, or 6.5). The combination of treatments could enhance the texture of fish muscle, since it favors the inactivation of proteolytic enzymes. This kind of result could have widespread use in surimi and other minced fish products, which have the problem of undesirable protease activity that leads to gel softening.

Enzymes are generally inactivated in vegetables by hot water blanching. Disadvantages of blanching include thermal damage, leaching of nutrients, and possible environmental pollution due to the production of high biochemical oxygen demand effluent. High-pressure treatment can fulfill the requirements of hot water blanching while avoiding mineral leaching and accumulation of wastewater. High-pressure treatment produces less effluent because less water is required than in hot water blanching [104]. Quaglia et al. [105] reported that pressure treatment at 900 MPa for 10 min reduces the peroxidase activity by 88% in green peas, which is comparable to traditional water blanching. However, the pressurization treatment resulted in greater ascorbic acid and firmness retention. Lower pressure levels decreased the enzyme activity to less than 50%, even when pressure was combined with moderate temperatures (39°C–60°C). Anese et al. [106] also observed, in peroxidase from a carrot cell-free extract, that a complete loss of enzyme activity was achieved only when the pressure treatment was applied at 900 MPa for 1 min. Enzyme activation was observed for treatments in the range of 300–500 MPa. For polyphenoloxidase (apple cell-free extract), it was observed that at pH 7.0, 5.4, and 4.5 a significant reduction in enzyme activity occurred in pressure treatments at 900 MPa for 1 min. For both enzymes, a pH dependence on residual activity was observed after the pressure treatment. Eshtiaghi and Knorr [104] reported that addition of citric acid could lead to increased polyphenoloxidase inactivation since pH reduction enhances the pressure effects on enzyme inactivation. Denaturation and inactivation of enzymes occur only when very high-pressure treatments are applied; the activation effects that could be presented at relatively low pressures could be attributed to reversible configuration and conformation changes on the enzyme or substrate molecules [106,107]. Seyderhelm et al. [108] evaluated the effects of high-hydrostatic-pressure treatments on selected enzymes, including catalase, phosphatase, lipase, pectinesterase, lipoxygenase, peroxidase, polyphenoloxidase, and lactoperoxidase and reported that peroxidase was the most barostable enzyme with 90% residual activity after 30 min treatment at 60°C and 600 MPa. Therefore, peroxidase could be used as an enzyme indicator for high-pressure treatments.

Pressurization at 100 and 200 MPa causes hardly any inactivation of pectinesterase [58]. Pectinesterase in juices such as Satsuma mandarin juice is inactivated when pressurized to 300–400 MPa. Purified pectinesterase is also inactivated at pressures of 300 MPa or higher. The inactivation is irreversible; and the pectinesterase is not reactivated during storage at 0°C or transportation. The activity of pectinesterase from mandarin juice remains at low levels during 90 days of storage at 0°C after pressure treatments at 400–600 MPa. Soluble solids such as sugars, proteins, and lipids exert a protective action against pectinesterase inactivation by high pressure or heat [58]. Polyphenoloxidase is often described as a soluble enzyme, localized mainly in the cytosol of plant cells, and is also associated with particulate cell fractions [109]. It is well established that polyphenoloxidases from different sources may have different molecular sizes and conformations. Thus, it is expected that the polyphenoloxidases may respond differently during and following high-pressure treatments. It is also anticipated that important differences will occur when the enzyme activity is analyzed in whole foods, extracts, or commercial enzymes. In untreated onion cells, phenolic



**FIGURE 34.16** Activation of polyphenoloxidase from Bartlett pears by high pressure. (Adapted from M. Asaka and R. Hayashi, *Agric. Biol. Chem.* 55:2439, 1991.)

compounds are confined to vacuoles and spatially separated from the polyphenoloxidase by the tonoplast; after pressurization ( $>100$  MPa) the cell and the tonoplast are disrupted and phenolic oxidation products are formed. Polyphenoloxidase is no longer separated from the substrate, and enzymatic browning begins [109].

The activity of polyphenoloxidase increases five times when slices of Bartlett pears are pressurized at 400 MPa and 25°C for 10 min (Figure 34.16). Further increase in pressure does not increase the enzyme activity. However, pressurization of homogenates of apples, bananas, or sweet potatoes did not result in activation of polyphenoloxidase [110]. Gomes and Ledward [111] reported a reduction in polyphenoloxidase activity from a crude potato extract with increasing pressure (400–800 MPa for 10 min). In contrast, when the crude extract of mushroom was treated at 400 MPa for 10 min, an enhancement in the activity was observed. Pressures above 300 MPa inactivated polyphenoloxidase in apple slices [112]. Cano et al. [113] studied the combination of high pressure and temperature on peroxidase, polyphenoloxidase, and pectin methylesterase activities of fruit-derived products. Optimal inactivation of peroxidase in strawberry puree was achieved at 230 MPa and 43°C. Pressurization–depressurization treatments caused a significant loss of strawberry polyphenoloxidase, up to 230 MPa. Combinations of high pressure and 35°C effectively reduced peroxidase in orange juice. The effects of pressure and temperature on pectin methylesterase activity in orange juice were similar to those for peroxidase. There is some evidence of changes in the enzyme–substrate interactions during pressurization and, therefore, changes in enzyme reaction kinetics. Some beneficial aspects of enzyme activation or reduced enzyme activity by high pressure can be used to retain or increase food quality.

#### 34.3.4 Functional Properties

The functional properties of biological molecules are usually dependent on conformational changes. The interactions between solvent and solute molecules, and inter- and intramolecular interactions of the solute are influenced when subjected to pressure. Therefore, either beneficial or detrimental changes can be produced as a result of high-pressure treatment [99]. Hydrogen bonding, which stabilizes protein structures ( $\alpha$ -helix and  $\beta$ -pleated sheets), is influenced by pressure but to a lesser extent than ionic or hydrophobic interactions. Hydrogen bond formation results in the shortening of interatomic distances with the corresponding volume decrease and is, therefore, enhanced by high pressure [99].

Phase changes in proteins and lipids are accompanied by the application of high pressure; these modifications offer opportunities to develop new products with unique rheological properties [34]. The structure of food proteins and polysaccharides can be changed by high-hydrostatic-pressure treatments and confers different rheological properties and mouthfeel. Earnshaw [34] explained that some Japanese researchers claim that these changes are desirable and that the gel quality of surimi can be improved with high-pressure treatments.

Pressure has an influence on meat ultrastructure with similar changes to those observed during the age conditioning of meat; therefore, the juiciness and tenderness are affected [114]. Plant structures containing entrapped air will be affected by high pressure when the air volume is compressed. However, in some cases the vacuoles and pores can be filled with the surrounding fluid, after which the material can maintain its structural integrity with increased density [34]. Adiabatic heating occurs in most food materials subjected to high pressure, and this is proportional to the compressibility of the food:air ratio. Entrapped air in the food matrix and cell vacuoles is very compressible and will increase the food or system temperature [34]. Some vegetable structures are resistant to pressure, while others can exhibit significant softening and severe color changes after pressurization. The effect of high-pressure treatments will depend on the type of vegetable or fruit, its physical characteristics, and maturity. Dumay et al. [115] evaluated the effects of high-hydrostatic-pressure treatments on the physicochemical characteristics of dairy creams and oil/water model system emulsions. Pressure treatments at 450 MPa did not affect the structure of the emulsions. Coalescence or emulsion breakdown was not observed. In the case of model emulsions, important rheological changes were observed, depending on the surface-active protein present and the effects of high pressure on unfolding or aggregation. Emulsions containing sodium casinate remained unchanged after treatment, while in those containing  $\beta$ -lactoglobulin the pressure treatment induced changes in their rheological behavior.

Fat crystallization by high-hydrostatic-pressure treatments is another interesting aspect to be considered. Buchheim and Abou El Nour [116] observed that fat crystallization increased with the extent of the pressure treatment; maximum changes were found in the pressure range of 300–350 MPa. Dumay et al. [115] stated that this behavior can be used for aging ice cream mixes and physical ripening of dairy cream in butter making. These can be considered as potential applications of high-pressure technology.

Exposure to high pressure unfolds protein molecules, which results in alterations of the functional properties of the protein [39]. Foaming, emulsifying, gelling, and water-binding capacity of proteins may be affected. Proteins treated with high pressures may lead to the development of a range of functional food ingredients prepared from food proteins by controlled unfolding [39]. It is well known that pH and ionic strength influence protein aggregation and gelation under heating conditions; this is also observed when protein solutions are subjected to high hydrostatic pressure. Chefteil [9] mentioned that it is likely, yet not fully demonstrated, that protein aggregation and gelation occur under pressurization as well as after pressure release.

### 34.3.5 Sensory Properties

The principal advantage of high-pressure technology is its relatively small effect on food composition and, hence, on sensory and nutritional attributes. Generally, pressure has little effect on food nutritional characteristics. However, more research is needed before solid judgments can be made [34]. Aleman et al. [77] studied the effect of high hydrostatic pressure on the natural flora present in fresh-cut pineapple. Treatments of 340 MPa for 15 min at  $-4^{\circ}\text{C}$ ,  $21^{\circ}\text{C}$ , or  $38^{\circ}\text{C}$  considerably reduced the initial counts of mesophilic bacteria, yeast, and molds, suggesting an increased shelf life in comparison with untreated pineapple samples. Alteration of the structure of starch and protein by high pressure can be utilized so that rice can be cooked in a few minutes [4]. Grapefruit juice manufactured by high-pressure technology does not possess the bitter taste of limonene present in conventional thermal-processed grapefruit juice [117]. Peaches and pears processed at 410 MPa for 30 min remained commercially sterile for 5 years [4]. Pressure treatment of nonpasteurized citrus juices provides a fresh-like flavor with no loss of vitamin C and a shelf life of approximately 17 months [5]. The internal structure of tomatoes becomes tough, tissues of chicken and fish fillets become opaque, and prerigor beef is tenderized [4].

Jams obtained by high-pressure processing retain the taste and color of fresh fruit, unlike conventional jams produced by heat. In Japan, high-pressure processing is utilized for the manufacture of jams, marmalades, and sauces from strawberry, orange, and other fruits. The desired plastic container is filled with a mixture of raw materials consisting of fruits, fruit juice, sugar, and acidulants. The container is sealed and subjected to a pressure of 400–600 MPa for 1–30 min. Strawberry jam can be obtained by pressurization at 400 MPa for 15 min and strawberry puree by pressurization at 400 MPa for 10 min. Pressurization allows the permeation of sugar solution into the fruits as well as commercial preservation of the jam [118].



El Moueffak et al. [119] reported that duck, foie gras pressurized at 50°C and 400 MPa for 10–30 min or at 300 MPa for 30 min presents attractive sensory characteristics, with less fat melting, softer texture, less cooked flavor, and a microbiological quality close to that obtained with traditional heat treatment. Pressure treatments up to 150 MPa did not change the sensory and instrumental color of minced beef muscle [53]. However, treatments for 10 min at pressures higher than 350 MPa turned the meat surface to a grayish tone, which corresponds to a decrease in the instrumental  $a^*$  value. The grayish tone was even more noticeable at 450 MPa applied for 10 min.

Estiaghi et al. [120] observed that the color of dried green beans, carrots, and potatoes dried without pretreatment was dark due to enzymatic browning, while pressure or water-blanching pretreated vegetables retained an acceptable color. The pretreatments applied were water blanching in boiling water (carrot and green beans for 7 min and potatoes for 4 min) and pressure treatment at 600 MPa for 15 min at 70°C. The texture of dried and rehydrated pressure-pretreated green beans, carrots, and potatoes was near to that of raw vegetables.

Butz et al. [109] reported that diced onions subjected to high-hydrostatic-pressure treatments lose their typical pungency and characteristic odor due to an intense decrease in dipropyldisulfide content and an increase in 2-methyl-pent-2-enal. Dipropyldisulfide is the compound associated with the odor of fresh onion. Diced onions presented no major changes in appearance immediately after a 30-min pressure treatment at 300 MPa and 25°C [109]. However, a slight glassy appearance, typical of steamed onions, was observed. In the same study, onions treated at 350 MPa and stored for 24 h at 20°C exhibited an intense brown color. Onions treated at 300 MPa started to brown, whereas samples pressurized at 100 MPa remained unchanged. Any pressure treatment above 100 MPa induces browning of diced onions and the rate of browning increases with increasing pressure. Microscopic evaluation of high-pressure-treated (300 MPa) onions revealed a severe damage in the vacuoles of the epidermis cells, with the liberation of substrates for polyphenoloxidase activity [109].

Takahashi et al. [121] evaluated the effect of high-hydrostatic-pressure treatments on Satsuma mandarin juice and reported that juice pressurized up to 600 MPa for 5 or 10 min at 20°C–22°C did not change in chemical composition, including soluble solids, acidity, amino nitrogen, vitamin C, and essential oil contents. The pressure-treated juices presented no off-flavor; and dimethyl sulfide, the characteristic compound found in off-flavor juices, was not detected. High-pressure-treated juices had very high scores in the sensory evaluation. Hayashi [33] reported some characteristics of food proteins treated by high-pressure technology: (a) beef muscle pressurized at 400 MPa for 10 min looked like raw ham and the taste of pressurized beef was intact, even when the surface seemed slightly baked; and (b) in shrimp treated at 400 MPa for 10 min, no apparent changes in color or shape were observed. However, shrimp meat was coagulated as in boiled shrimp.

There are few studies regarding high-pressure effects on nutritional characteristics of pressure-treated foods. Elgasim and Kennick [122] reported that pressure treatment at 103 MPa for 2 min improved the apparent digestibility of meat protein and had no adverse effect on the apparent biological value, net protein utilization, or protein efficiency ratio. A wide variety of effects and changes in food flavor, texture, physical appearance, and structure could result after the application of pressure, and these changes will depend on the type of food and its composition and structure.

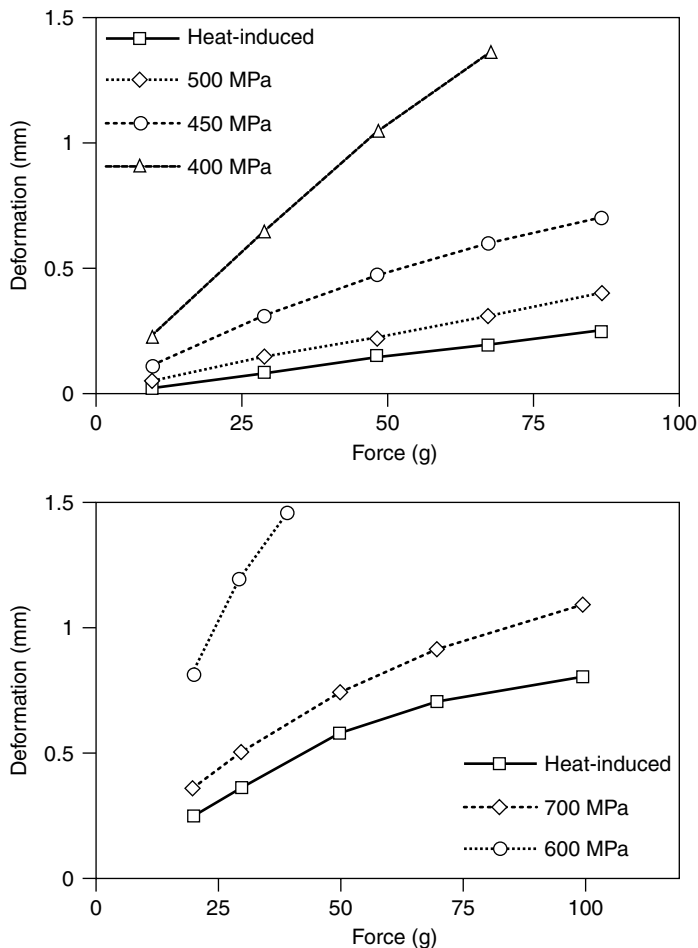
### **34.3.6 Gelation and Gelatinization Processes**

The process of gel formation is the macroscopic consequence of the denaturation, on a molecular level, of proteins and other biomacromolecules such as polysaccharides. The denatured state forms a gel or a precipitate, depending on the physical and chemical environmental characteristics.

Egg yolk subjected to a pressure of 400 MPa for 30 min at 25°C forms a gel. While a pressure of 500 MPa renders egg white partially coagulated and opaque, a pressure of 600 MPa causes complete gelation. Pressure-induced gels of egg white possess a natural flavor, displaying no destruction of vitamins and amino acids, and are more easily digested when compared with heat-induced gels. The gels retain the original color of the yolk or the white and are soft, lustrous, and adhesive when compared with heat-induced gels. While the strength of the gels increases, the adhesiveness decreases with an increase in the applied pressure. However, the hardest gel formed by high-pressure (500 MPa) treatment exhibits one-sixth the

strength of heat-induced gels. Gumminess of pressure-induced gels is considerably less than gumminess of heat-induced gels. Gels of egg white produced between 600 and 700 MPa deform readily without fracture. Cohesiveness of pressure-induced gels increases with increase in applied pressure. The force deformation curves of pressure- and heat-induced gels of egg yolk and egg white are presented in Figure 34.17 [123]. Ibarz et al. [124] studied the viscoelastic characteristics of egg gels formed under several high-hydrostatic-pressure conditions. For egg yolk samples, gels were formed at pressures above 500 MPa while for whole egg and egg white samples gels were formed at pressures over 600 MPa. During amplitude sweep and frequency sweep tests, storage modulus ( $G'$ ) and loss modulus ( $G''$ ) of gels increased when the treatment pressure increased.  $G'$  was greater than  $G''$  in every case studied.  $G'$  values for boiled egg gels were greater than for pressurized gels.

In Japan, a hydrostatic pressure of 400 MPa is used to induce gelation of pollack, sardine, skip jack, and tuna-based surimi. Squid-based surimi is obtained by pressurization of extracted muscle protein at 600 MPa. Pressure-induced surimi gels are organoleptically superior to heat-induced surimi gels [5]. Gelation can be used for adhesion binding of small-size muscles or fish fillets, restructuring of minced fish or deboned meat, and molding of surimi or pieces of gelled surimi into seafood analogs. The possibility of obtaining acceptable gels simultaneously with commercial sterilization at a temperature as low as 0°C is of tremendous practical interest to the surimi industry [22].



**FIGURE 34.17** Force deformation curves of pressure- and heat-induced gels of egg yolk (top) and egg white (bottom). (Adapted from M. Okamoto et al., *Agric. Biol. Chem.* 54(1):183, 1990.)

The mechanism of high-pressure-induced gelation is different from heat-induced gelation. Gelation by high-pressure treatment is attributed to a decrease in the volume of the protein solution. However, the application of heat results in violent movement of protein molecules, leading to the destruction of non-covalent bonds, denaturation, and formation of a random network. The rearrangement of water molecules around amino acid residues in pressure-induced gels produces glossy and transparent gels compared to opaque gels obtained by high temperatures [123].

Heremans [35] mentioned that important differences in the mechanical properties for temperature- and pressure-induced gels are expected. Hayashi [33] reported that pressure-coagulated food proteins, e.g., egg, soy protein, beef, pork, and fish meat, are more glossy, transparent, dense, smooth, and soft compared to boiled ones. These unique textural properties obtained by pressurization offer ways to create new food materials.

Gelatinization is the transition of starch granules from the birefringent crystalline state to a nonbirefringent, swollen state. Starch can be gelatinized using pressure or heat. The pressure at which starch gelatinizes depends on the source of starch. Gelatinization may be stimulated by the increased temperatures of pressurization [125]. High pressure may also produce an upward shift of gelatinization temperature by about 3°C–5°C per 100 MPa. Pressures higher than 150 MPa do not further enhance the gelatinization temperature. The effect of high pressure on gelatinization is due to the stabilization of hydrogen bonds, which maintains the starch granule in the original state [89]. High-pressure treatments on starches produce unique properties, which are different from those formed by heat gelatinization. Pressure-treated starches keep the granular structure intact, while heat treatment destroys starch granules and dissolves the starches to give transparent solutions [33].

---

## 34.4 Combination Treatments

The increasing demand for foods with reduced amounts of chemical additives and less physical damage is opening new opportunities for the hurdle-technology concept of food preservation [40,70]. The commercial challenge of minimally processed foods provides a strong motivation to study food-preservation systems that combine traditional microbial stress factors or hurdles, while introducing “new” variables for microbial control, such as high pressure. High pressure presents unique advantages over conventional thermal treatments [11]. However, many reported data indicate that commercial pasteurization or sterilization of low-acid foods using high pressure is very difficult without using some additional factors to enhance the inactivation rate. Factors such as heat, antimicrobials, ultrasound, and ionizing radiation can be used in combination with high pressure. These approaches will not only help to accelerate the rate of inactivation, but can also be useful to reduce the pressure level and hence the cost of the process while eliminating the commercial problems associated with sublethal injury and survivor tails.

High pressure can be used to reduce the severity of the factors traditionally used to preserve foods. The use of high pressure in combination with mild heating has considerable potential [3]. Studies have shown that the antimicrobial effect of high pressure can be increased with heat, low pH, carbon dioxide, organic acids, and bacteriocins such as nisin [45,60,75,126,127]. Mackey et al. [50] observed that *L. monocytogenes* cells were sensitized to pressure by butylated hydroxyanisole, potassium sorbate, and acid conditions. Therefore, if the hurdle concept could be applied to the optimization of high hydrostatic pressure for low-acid foods, a combination of moderate treatments, including pressure, can lead to a food-preservation method effective against bacterial spores [60].

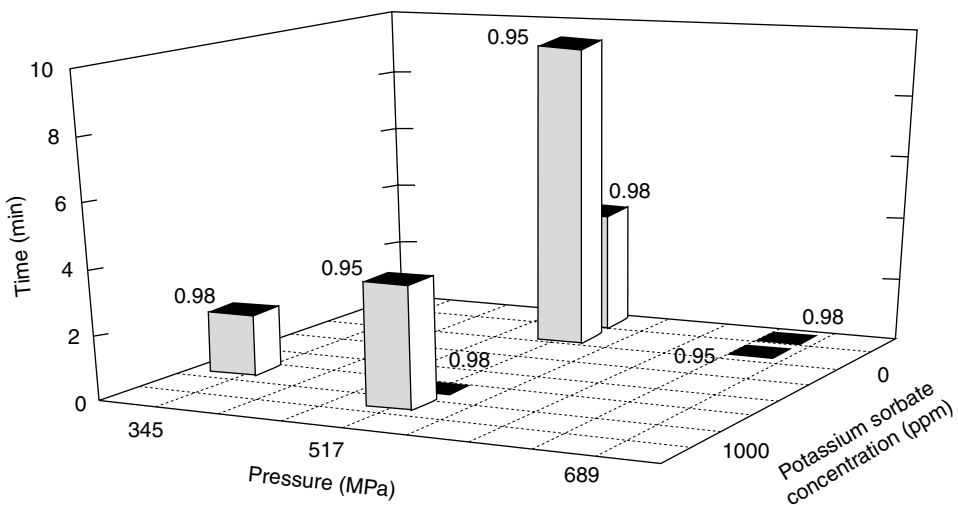
Knorr [10,11], Papineau et al. [127], and Popper and Knorr [126] reported enhanced pressure inactivation of microorganisms when combining pressure treatments with additives such as acetic, benzoic, or sorbic acids, sulfites, some polyphenols, and chitosan. These combination treatments allow lower processing pressure, temperature, and time of exposure. Roberts and Hoover [60] evaluated the effect of combinations of pressure at 400 MPa, heat, time of exposure, acidity, and nisin concentration against *B. coagulans* spores. Sublethally injured spores by the pressurization in combination with heat and acidity caused *B. coagulans* spores to become more sensitive to nisin. Acidic foods could be protected from spore outgrowth with the combined treatment. Hauben et al. [128] studied the lethal inactivation and sublethal injury of *E. coli* by high pressure and combinations of high-pressure treatments with lysozyme, nisin, and EDTA. High-pressure treatments from 180 to 320 MPa disrupted the outer membrane of bacterial cells, causing

periplasmic leakage and sensitization to lysozyme, nisin, and EDTA, demonstrating that sublethal injury can be usefully applied in a hurdle technology approach as an effective food-preservation method.

Crawford et al. [74] evaluated the combination of high hydrostatic pressure, heat, and irradiation to eliminate *C. sporogenes* spores in chicken breast. These authors reported no significant differences in the number of surviving spores between samples that were first irradiated and then pressurized or vice versa. However, there was a significant difference between samples exposed to combined treatments and those that were only irradiated, with the combined processes being more effective. No survivors of the initial inoculated spores were observed with a 6 kGy irradiation dose followed by pressurization at 690 MPa and 80°C for 20 min. Crawford et al. [74] concluded that a combination of lower doses of irradiation and high pressure is more useful in eliminating *C. sporogenes* spores than the application of either process alone.

Earnshaw et al. [70] mentioned that there is no synergistic antimicrobial action between sorbic acid and pressure up to 400 MPa when applied to *Z. bailii*, and attributed this lack of synergy to the modification of sorbic acid dissociation constant under pressurization. Tauscher [37] mentioned that the carboxylic acids commonly used as food preservatives show enhanced ionization when subjected to high pressure. However, Palou et al. [45] demonstrated that increased antimicrobial effects can be obtained when combining high pressure and potassium sorbate to inactivate *Z. bailii* in laboratory model systems with reduced  $a_w$  and pH (Figure 34.18). The initial inoculum ( $10^5$  *Z. bailii* cfu/mL) was completely inactivated in systems with  $a_w$  0.98 in the presence of potassium sorbate with pressures  $\geq 345$  MPa for more than 2 min; without potassium sorbate the pressure had to be applied at 517 MPa for 4 min. In laboratory systems with  $a_w$  0.95 and without potassium sorbate the pressure must be  $\geq 517$  MPa for 10 min, and with potassium sorbate the treatment time could be reduced to 4 min [45].

Citric and sorbic acids were included in the laboratory model systems used by Palou et al. [45]. Thus, a temporary reduction in pH and an increase in the dissociated form of the acids could be present, which will depend on the pressure level. This effect could decrease the antimicrobial effectiveness of potassium sorbate during the time of exposure, since the major antimicrobial action is attributed to the undissociated form of the acid. However, the result of high-hydrostatic-pressure treatments would depend not only on the previously mentioned effects but on the consequences of high pressure in the biological systems involved. The results presented in Figure 34.18 reveal a synergistic antimicrobial action between potassium sorbate and high pressure at both  $a_w$ . For the same pressure level, the holding time required to inhibit *Z. bailii* is shorter in the presence of the preservative. High-pressure damage to *Z. bailii* renders cells more susceptible to other antimicrobial agents (low pH, potassium sorbate), probably due to the exposure of critical cell surface targets.



**FIGURE 34.18** Combinations of high-pressure treatments (pressure and exposure time), potassium sorbate concentration, and water activity to inactivate *Zygosaccharomyces bailii* in model systems. (Adapted from E. Palou et al., *J. Food Sci.* 62:855, 1997.)

There is theoretical evidence about the pH shift during pressurization, but accurate models relating to microorganisms in food systems and direct measurement of pH are not available [70]. A detailed understanding of pH modification in foods might allow for the design of food formulations that maximize effective reversible antimicrobial pH shifts during pressurization [70]. The volume changes associated with ionization can be involved in the action of high hydrostatic pressure in biological systems. Earnshaw et al. [70] mentioned that water and acid molecules show increased ionization under high pressure. Thus, during the pressurization and holding time of a high-pressure treatment, an increase of proton concentration and a pH reduction are expected. High pressure decreases the p*K*<sub>a</sub> of certain acids that correspond to a decrease in the pH of solutions or buffers containing these acids [129]. Decreases in the p*K*<sub>a</sub> are more important for phosphoric acid than for citric acid. The pH of water or phosphate buffers decreases reversibly by 0.2–0.3 pH units per 100 MPa of applied pressure [130]. These effects can contribute, in a cooperative manner, to enhance the pressure effects on microorganisms and the knowledge and understanding of their effects may aid to design effective pressure-combined processes. For most of the possible combined processes, the primary goal consists of identifying the factors or treatments that could sensitize microorganisms to pressure [9] or recognizing the factors or treatments that could cause the microbial death in sublethal pressure-injured microbial cells. However, the protective effects that could exert by different food components are different, thus it is necessary to find the effects of each combination process in each particular food product.

---

### 34.5 Potential Applications

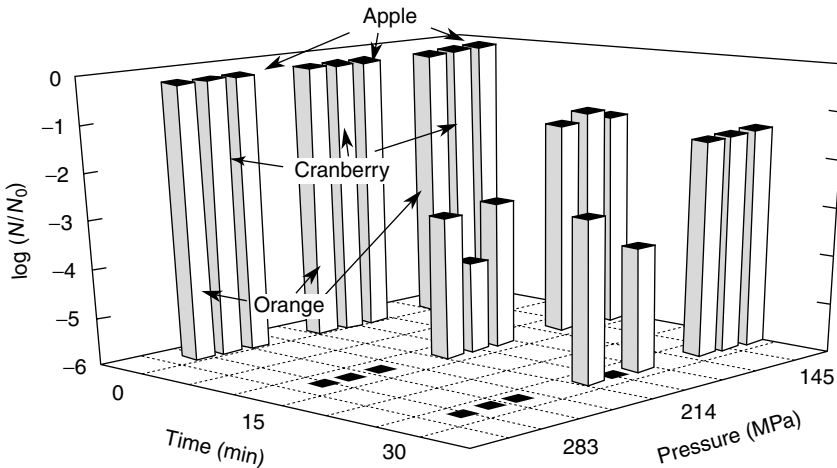
Cheftel [9] mentioned that potential applications of high pressure include decontamination of raw milk and some curds and cheeses made from raw milk, reduction of the intensity of thermal processing for prepared chilled meals containing thermosensitive food constituents, and the sanitation and increase of the refrigerated shelf life of spreads, emulsified sauces, essential oils, aromatic extracts, and herbs.

The observed tails in some survivor curves made small probabilities of survival difficult to obtain and called into question the efficiency of the high-pressure process [1]. Many reported data show that commercial pasteurization or sterilization of nonacidic foods is very difficult or impossible without using some additional factors or methods to enhance the inactivation rate. In practice, processing should be carried out at a relatively high pressure or in combination with moderate temperatures to inactivate the microbial cells. To optimize high-hydrostatic-pressure preservation techniques, the combined effects of stress factors on the growth of key microorganisms, the storage-dependent changes in food systems after high-pressure treatments, and their shelf-life limiting factors must be understood [68].

The effects of pressure in food products and foodborne microorganisms were first reported in 1899 by Hite. These early studies include results on microbial inactivation in milk and meat. In 1914, the results were expanded to fruit products [131]. The success of these pioneering works was attributed to the combined effect of low pH and high hydrostatic pressure; in some products such as berries the presence of natural organic acids (sorbic, benzoic) also contributed. However, for low-acid foods the results were not the same. Papineau and Schmerseal studied the effect of high pressure on *S. cerevisiae* inoculated in fruit juices. Figure 34.19 presents some of their results [4]. The survival fraction was reduced sixfold with treatments at 284 MPa for 30 min in apple, orange, and cranberry juices. Based on these kind of studies, Hoover et al. [4] mentioned that the antimicrobial effect of high hydrostatic pressure depends on the microbial flora initially present in the food and food composition.

Since high pressure has less effect on microbial spores than on vegetative cells, products with a pH lower than 4.0 can theoretically be processed successfully with this technology. Pressure inactivation of yeast and molds has been reported in citrus juices [57,58]. Juices pressurized at 400 MPa for 10 min at 40°C did not spoil during 2–3 months of storage. Capellas et al. [132] reported that high-pressure treatments effectively reduced the bacterial flora of fresh goat milk cheese and significantly extended the refrigerated storage life. No surviving *E. coli* were detected in the cheese after 60 days of storage (2°C–4°C) in inoculation studies after treatments at 400–500 MPa for 5–10 min. Potential pressurized juices and fruit salads are showing promise in Europe [9]. Other potential pressurized acid foods are sauces, vegetables, acidified seafoods, and possibly some wines (to replace SO<sub>2</sub>).

High-pressure technology offers a unique opportunity to develop new foods of high nutritional and sensory quality, novel texture, more convenience, and with an increased shelf life [20]. High-pressure treatment



**FIGURE 34.19** Effect of high-pressure treatments on *Saccharomyces cerevisiae* inoculated in apple, cranberry, and orange juices. (Adapted from D. G. Hoover et al., *Food Technol.* 43(3):99, 1989.)

has the potential to improve the microbiological safety and quality of foods, including meat, milk, and dairy products [3]. Carlez et al. [53] reported that high-pressure processing of minced meat contains microbial growth during storage at 3°C, and that the growth delay was around 2–3 days after a high-pressure treatment at 200 MPa for 20 min approximately 6–9 days at 300 MPa for 20 min, 10–12 days at 400 MPa for 20 min, and about 13–15 days if the treatment was applied at 450 MPa for 20 min.

Pressure depresses the freezing point of water and the melting point of ice, making it possible for various high-density forms of ice to be obtained [38]. These effects of pressure on the solid-liquid phase diagram of water have several potential applications in food technology, including pressure-assisted freezing, pressure-assisted thawing, and nonfrozen storage at low temperature under pressure. The greatest potential appears to be in high-pressure-assisted freezing and thawing [38]. High-pressure processing thaws frozen foods much faster than conventional thawing methods. Two kilograms of frozen beef are thawed in 80 min when pressurized to 200 MPa, whereas thawing the same amount of beef at atmospheric pressure takes 7 h [53]. The flavor and juiciness of the pressure-thawed beef are equivalent to those obtained by thawing beef under low humidity at 5°C. The surface of the pressure-thawed beef is slightly discolored. Meat stored at 3°C after pressurization for 20 min at 200 MPa and 20°C begins to spoil after 2 days. The spoilage of meat begins after 6 days when pressurized at 300 MPa and after 6–13 days when pressurized at 400–450 MPa [53]. However, meat remains unaffected by microbial spoilage under refrigerated temperatures after a pressure treatment for 1 h at 540 MPa and 52°C.

The perspectives for high-pressure food applications depend on further research, both at academic and industrial levels [9]. Research and development work should include shelf life testing and appropriate microbial challenge testing, as well as incorporation of good manufacturing practices in high-hydrostatic food processing [35]. Understanding the pressure-inactivation mechanism may help in the design of successful bactericidal treatments by combining pressure with mild heat treatments or other traditional microbial stress factors, since it appears that the effects of high pressure on microorganisms are more complicated than previously thought [53]. More studies dealing with kinetic data of microbial inactivation, interactions between pressure and food constituents, and storage-dependent changes are needed.

## 34.6 Final Remarks

No specific official requirements are needed in some countries that relate to the control of new food processing technologies [34]. However, the regulations on food safety are relevant, and there are still several important questions about safety and nutritional value that need to be answered.

The unique physical and sensory properties of food processed by high-pressure technology offer new chances for food product development such as minimally processed or raw meat and fish, long shelf life

convenience foods with fresh and natural colors, new types of food gels, and frozen foods with improved quality [34]. Identification of commercially feasible applications is probably the most difficult of the challenges for high-pressure technology [20]. Products processed by high pressure need to have inherent added value or an increased profitability due to the expensive process cost. Two important questions need to be answered: will the consumers accept a high-pressure-processed product, and are they prepared to pay an extra cost for a high-pressure-processed food? The commercial application of high-pressure technology in the food industry will depend largely on the economical feasibility of the process. The capital cost associated with the equipment purchase and installation is an important obstacle for its commercial implementation [20]. The cost of the high-pressure vessel represents the main fraction of the total cost of an industrial high-pressure processing plant and will depend on the maximum working pressure and the vessel dimensions and processing capacity.

Earnshaw [34] mentioned that it is unlikely that pressure processing will replace canning or freezing; nevertheless, it could find applications for expensive foods with short shelf lives and high-value ingredients such as flavors, vitamins, and functional biopolymers that are heat-sensitive. In Europe, Japan, and the United States, there is significant commercial interest in the development of high-pressure food processing, and millions of dollars have been invested in research and development.

High hydrostatic pressure is not a cheap technology, and a systematic approach must be taken to search for processing options to ensure that high-pressure treatments can be successfully and economically applied to a wide range of products [133]. The feasibility studies must include effective equipment design solutions and precisely defined minimum required pressures and time cycles. Continuous operation is also a major task.

---

## References

1. G. W. Gould, The microbe as a high pressure target, in *High Pressure Processing of Foods* (D. A. Ledward, D. E. Johnston, R. G. Earnshaw, and A. P. M. Hasting, Eds.), Nottingham University Press, Nottingham, p. 27 (1995).
2. G. W. Gould, Ecosystem approaches to food preservation, *J. Appl. Bacteriol.* 73:58S (1992).
3. M. F. Patterson, M. Quinn, R. Simpson, and A. Gilmour, Effects of high pressure on vegetative pathogens, in *High Pressure Processing of Foods* (D. A. Ledward, D. E. Johnston, R. G. Earnshaw, and A. P. M. Hasting, Eds.), Nottingham University Press, Nottingham, p. 47 (1995).
4. D. G. Hoover, C. Metrick, A. M. Papineau, D. F. Farkas, and D. Knorr, Biological effects of high hydrostatic pressure on food microorganisms, *Food Technol.* 43(3):99 (1989).
5. D. Farr, High pressure technology in the food industry, *Trends Food Sci. Technol.* 1:14 (1990).
6. U. R. Pothakamury, G. V. Barbosa-Cánovas, B. G. Swanson, and R. S. Meyer, The pressure builds for better food processing, *Chem. Eng. Prog.* 93(3):45 (1995).
7. D. A. Ledward, High pressure processing—the potential, in *High Pressure Processing of Foods* (D. A. Ledward, D. E. Johnston, R. G. Earnshaw, and A. P. M. Hasting, Eds.), Nottingham University Press, Nottingham, p. 1 (1995).
8. A. Williams, New technologies in food preservation and processing: Part II, *Nutr. Food Sci.* 94(1):16 (1994).
9. J. C. Cheftel, High-pressure, microbial inactivation and food preservation, *Food Sci. Technol. Int.* 1:75 (1995).
10. D. Knorr, Hydrostatic pressure treatment of food: microbiology, in *New Methods of Food Preservation* (G. W. Gould, Ed.), Blackie Academic and Professional, New York, p. 159 (1995).
11. D. Knorr, High pressure effects on plant derived foods, in *High Pressure Processing of Foods* (D. A. Ledward, D. E. Johnston, R. P. Earnshaw, and A. P. M. Hasting, Eds.), Nottingham University Press, Nottingham, p. 123 (1995).
12. J. C. Cheftel, Effects of high hydrostatic pressure on food constituents: an overview, in *High Pressure and Biotechnology* (C. Balny, R. Hayashi, K. Heremans, and P. Masson, Eds.), Colloque INSERM, Vol. 224, John Libbey Eurotext, Montrouge, France, p. 195, (1992).
13. F. Zimmerman and C. Bergman, Isostatic pressure equipment for food preservation, *Food Technol.* 47(6):162 (1993).
14. D. Knorr, Effects of high-hydrostatic pressure process on food safety and quality, *Food Technol.* 47(6):156 (1993).

15. G. D. Alemán, E. Y. Ting, S. C. Mordre, A. C. O. Hawes, M. Walker, D. F. Farkas, and J. A. Torres, Pulsed ultra high pressure treatments for pasteurization of pineapple juice, *J. Food Sci.* 61:388 (1996).
16. S. Olsson, Production equipment for commercial use, in *High Pressure Processing of Foods* (D. A. Ledward, D. E. Johnston, R. G. Earnshaw, and A. P. M. Hasting, Eds.), Nottingham University Press, Nottingham, p. 167 (1995).
17. B. Crossland, The development of high pressure processing, in *High Pressure Processing of Foods* (D. A. Ledward, D. E. Johnston, R. G. Earnshaw, and A. P. M. Hasting, Eds.), Nottingham University Press, Nottingham, p. 7 (1995).
18. G. Deplace and B. Mertens, The commercial application of high pressure technology in the food processing industry, in *High Pressure and Biotechnology* (C. Balny, R. Hayashi, K. Heremans, and P. Masson, Eds.), Colloque INSERM, Vol. 224, John Libbey Eurotext, Montrouge, France, p. 469 (1992).
19. G. V. Barbosa-Cánovas, B. P. Swanson, U. R. Pothakamury, and E. Palou, *Nonthermal Preservation of Foods*, Marcel Dekker, New York (1997).
20. B. Mertens, Hydrostatic pressure treatment of food: equipment and processing, in *New Methods of Food Preservation* (G. W. Gould, Ed.), Blackie Academic and Professional, New York, p. 135 (1995).
21. B. Mertens and G. Deplace, Engineering aspects of high pressure technology in the food industry, *Food Technol.* 47(6):164 (1993).
22. J. C. Cheftel, Applications des hautes pressions en technologie alimentaire, *Ind. Aliment. Agric.* 108:141 (1991).
23. Mitsubishi Heavy Industries, Technical data (1992).
24. K. Hori, Y. Manabe, M. Kaneko, T. Sekimoto, Y. Sugimoto, and T. Yamane, The development of high pressure processor for food industries, in *High Pressure and Biotechnology* (C. Balny, R. Hayashi, K. Heremans, and P. Masson, Eds.), Colloque INSERM, Vol. 224, John Libbey Eurotext, Montrouge, France, p. 499 (1992).
25. T. Kanda, T. Yamauchi, T. Naoi, and Y. Inoue, Present status and future prospects of high pressure food processing equipment, in *High Pressure and Biotechnology* (C. Balny, R. Hayashi, K. Heremans, and P. Masson, Eds.), Colloque INSERM, Vol. 224, John Libbey Eurotext, Montrouge, France, p. 521 (1992).
26. ABB Autoclave Systems, Technical data (1993).
27. R. J. Swientek, High hydrostatic pressure for food preservation, *Food Proc.* (November):90 (1992).
28. ABB Autoclave Systems, Technical data (1994).
29. Engineered Pressure Systems, Technical data (1994).
30. C. E. Morris, High pressure builds up, *Food Eng.* (October):113 (1993).
31. M. Masuda, Y. Saito, T. Iwanami, and Y. Hirai, Effects of hydrostatic pressure on packaging materials for food, in *High Pressure and Biotechnology* (C. Balny, R. Hayashi, K. Heremans, and P. Masson, Eds.), Colloque INSERM, Vol. 224, John Libbey Eurotext, Montrouge, France, p. 545 (1992).
32. R. Hayashi, Application of high pressure to food processing and preservation: philosophy and development, in *Engineering and Food*, Vol. 2 (W. E. L. Spiess and H. Schubert, Eds.), Elsevier, London, p. 815 (1989).
33. R. Hayashi, Advances in high pressure processing technology in Japan, in *Food Processing: Recent Developments* (A. G. Gaonkar, Ed.), Elsevier, London, p. 85 (1995).
34. R. P. Earnshaw, High pressure food processing, *Nutr. Food Sci.* 2:8 (1996).
35. K. Heremans, High pressure effects on biomolecules, in *High Pressure Processing of Foods* (D. A. Ledward, D. E. Johnston, R. G. Earnshaw, and A. P. M. Hasting, Eds.), Nottingham University Press, Nottingham, p. 81 (1995).
36. R. van Eldik, T. Asano, and W. J. Le Noble, Activation and reaction volumes in solution. *Chem. Rev.* 89:549 (1989).
37. B. Tauscher, Pasteurization of food by hydrostatic pressure: chemical aspects, *Z. Lebensm. Unters. Forsch.* 200:3 (1995).
38. M. T. Kalichevsky, D. Knorr, and P. J. Liliford, Potential food applications of high pressure effects on ice-water interactions, *Trends Food Sci. Technol.* 6:253 (1995).
39. D. E. Johnston, B. A. Austin, and R. I. Murphy, Effects of high hydrostatic pressure on milk, *Milchwissenschaft* 47(12):760 (1992).
40. L. Leistner, Principles and applications of hurdle technology, in *New Methods of Food Preservation*, (G. W. Gould, Ed.), Blackie Academic and Professional, New York, p. 1 (1995).
41. T. Shigehisa, T. Ohmori, A. Saito, S. Tajiri, and R. Hayashi, Effects of high hydrostatic pressure on characteristics of pork slurries and inactivation of microorganisms associated with meat and meat products, *Int. J. Food Microbiol.* 12:207 (1991).



42. R. G. Earnshaw, Kinetics of high pressure inactivation of microorganisms, in *High Pressure Processing of Foods* (D. A. Ledward, D. E. Johnston, R. G. Earnshaw, and A. P. M. Hasting, Eds.), Nottingham University Press, Nottingham, p. 37 (1995).
43. G. W. Gould and M. V. Jones, Combination and synergistic effects, in *Mechanisms of Action of Food Preservation Procedures* (G. W. Gould, Ed.), Elsevier, London, p. 401 (1989).
44. E. Palou, A. López-Malo, G. V. Barbosa-Cánovas, J. Welti-Chanes, and B. G. Swanson, Combined effect of high hydrostatic pressure and water activity on *Zygosaccharomyces bailii* inhibition, *Lett. Appl. Microbiol.* 24:417 (1997).
45. E. Palou, A. López-Malo, G. V. Barbosa-Cánovas, J. Welti-Chanes, and B. G. Swanson, High hydrostatic pressure as a hurdle for *Zygosaccharomyces bailii* inactivation, *J. Food Sci.* 62:855 (1997).
46. C. E. Zobell, Pressure effects on morphology and life processes of bacteria, *High Pressure Effects on Cellular Processes* (A. M. Zimmerman, Ed.), Academic Press, New York, p. 85 (1970).
47. M. F. Patterson, M. Quinn, R. Simpson, and A. Gilmour, Sensitivity of vegetative pathogens to high hydrostatic pressure treatment in phosphate-buffered saline and foods, *J. Food Prot.* 58:524 (1995).
48. M. F. Styles, D. G. Hoover, and D. F. Farkas, Response of *Listeria monocytogenes* and *Vibrio parahaemolyticus* to high hydrostatic pressure, *J. Food Sci.* 56:1404 (1991).
49. Y. Takahashi, H. Ohta, H. Yonei, and Y. Ifuku, Microbicidal effect of hydrostatic pressure on satsuma mandarin juice, *Int. J. Food Sci. Technol.* 28:95 (1993).
50. B. M. Mackey, K. Forestiere, and N. S. Isaacs, Factors affecting the resistance of *Listeria monocytogenes* to high hydrostatic pressure, *Food Biotechnol.* 9(1&2):1 (1995).
51. N. S. Isaacs, P. Chilton, and B. Mackey, Studies on the inactivation by high pressure of microorganisms, in *High Pressure Processing of Foods* (D. A. Ledward, D. E. Johnston, R. G. Earnshaw, and A. P. M. Hasting, Eds.), Nottingham University Press, Nottingham, p. 65 (1995).
52. A. Carlez, J. P. Rosec, N. Richard, and J. C. Cheftel, High pressure inactivation of *Citrobacter freundii*, *Pseudomonas fluorescens* and *Listeria innocua* in inoculated minced beef muscle, *Lebensm. Wiss. Technol.* 26:357 (1993).
53. A. Carlez, J. P. Rosec, N. Richard, and J. C. Cheftel, Bacterial growth during chilled storage of pressure-treated minced meat, *Lebensm. Wiss. Technol.* 27:48 (1994).
54. H. Ludwing, C. Bieller, K. Hallbauer, and W. Scigalla, Inactivation of microorganisms by hydrostatic pressure, in *High Pressure and Biotechnology* (C. Balny, R. Hayashi, K. Heremans, and P. Masson, Eds.), Colloque INSERM, Vol. 224, John Libbey Eurotext, Montrouge, France, p. 25 (1992).
55. J. Smelt and G. Rijke, High pressure treatment as a tool for pasteurization of foods, in *High Pressure and Biotechnology* (C. Balny, R. Hayashi, K. Heremans, and P. Masson, Eds.), Colloque INSERM, Vol. 224, John Libbey Eurotext, Montrouge, France, p. 361 (1992).
56. C. Hashizume, K. Kimura, and R. Hayashi, Kinetic analysis of yeast inactivation by high pressure treatment at low temperatures, *Biosci. Biotechnol. Biochem.* 59:1455 (1995).
57. H. Ogawa, K. Fukuhisa, and H. Fukumoto, Effect of hydrostatic pressure on sterilization and preservation of citrus juice, in *High Pressure and Biotechnology* (C. Balny, R. Hayashi, K. Heremans, and P. Masson, Eds.), Colloque INSERM, Vol. 224, John Libbey Eurotext, Montrouge, France, p. 269 (1992).
58. H. Ogawa, K. Fukuhisa, Y. Kubo, and H. Fukumoto, Inactivation effect of pressure does not depend on the pH of the juice, *Agric. Biol. Chem.* 54(5):1219 (1990).
59. A. J. H. Sale, G. W. Gould, and W. A. Hamilton, Inactivation of bacterial spores by hydrostatic pressure, *J. Gen. Microbiol.* 60:323 (1970).
60. C. M. Roberts and D. G. Hoover, Sensitivity of *Bacillus coagulans* spores to combinations of high hydrostatic pressure, heat, acidity and nisin, *J. Appl. Bacteriol.* 81:363 (1996).
61. P. Oxen and D. Knorr, Baroprotective effects of high solute concentrations against inactivation of *Rhodotorula rubra*, *Lebensm. Wiss. Technol.* 26:220 (1993).
62. G. J. Dring, Some aspects of the effects of hydrostatic pressure on microorganisms, in *Inhibition and Inactivation of Vegetative Microbes* (S. A. Skinner and V. Hugo, Eds.), Academic Press, New York, p. 257 (1976).
63. R. E. Marquis, High pressure microbial physiology, *Adv. Microbial Physiol.* 14(1):159 (1976).
64. P. Rovere and A. Maggi, Approccio alle alte pressioni: una nuova tecnologia a disposizione dell'industria alimentare, *Indust. Conserve* 70(1):45 (1995).
65. Y. Pandya, F. F. Jewett, and D. G. Hoover, Concurrent effects of high hydrostatic pressure, acidity and heat on the destruction and injury of yeasts, *J. Food Prot.* 58:301 (1995).

66. P. Butz and Ludwig, Pressure inactivation of microorganisms at moderate temperatures, *Physica* 139&140B:875 (1986).
67. C. Metrick, D. G. Hoover, and D. F. Farkas, Effects of high hydrostatic pressure on heat-resistant and heat-sensitive strains of *Salmonella*, *J. Food Sci.* 54:1547 (1989).
68. E. Palou, A. López-Malo, G. V. Barbosa-Cánovas, J. Welti-Chanes, and B. G. Swanson, Kinetic analysis of *Zygosaccharomyces bailii* by high hydrostatic pressure, *Lebensm. Wiss. Technol.* 30:703 (1997).
69. S. Fujii, K. Obuchi, H. Iwahashi, T. Fujii, and Y. Komatsu, Saccharides that protect yeast against hydrostatic pressure stress correlated to the mean number of equatorial OH groups, *Biosci. Biotechnol. Biochem.* 60:476 (1996).
70. R. G. Earnshaw, J. Appleyard, and R. M. Hurst, Understanding physical inactivation processes: combined preservation opportunities using heat, ultrasound and pressure, *Int. J. Food Microbiol.* 28:197 (1995).
71. M. Peleg, A model of microbial growth and decay in a closed habitat based on combined Fermi's and the logistic equations, *J. Sci. Food Agric.* 71:225 (1996).
72. G. W. Gould and A. J. H. Sale, Initiation of germination of bacterial spores by hydrostatic pressure, *J. Gen. Microbiol.* 60:335 (1970).
73. D. G. Hoover, Pressure effects on biological systems, *Food Technol.* 47(6):150 (1993).
74. Y. J. Crawford, E. A. Murano, D. G. Olson, and K. Shenoy, Use of high hydrostatic pressure and irradiation to eliminate *Clostridium sporogenes* spores in chicken breast, *J. Food Prot.* 59:711 (1996).
75. C. G. Mallidis and D. Drizou, Effect of simultaneous application of heat and pressure on the survival of bacterial spores, *J. Appl. Bacteriol.* 71:285 (1991).
76. A. Nakayama, Y. Yano, S. Kobayashi, M. Ishikawa, and K. Sakai, Comparison of pressure resistance of spores of six *Bacillus* strains with their heat resistances, *Appl. Environ. Microbiol.* 62:3897 (1996).
77. G. D. Alemán, D. F. Farkas, J. A. Torres, E. Wilhelmsen, and S. McIntyre, Ultra-high pressure pasteurization of fresh cut pineapple, *J. Food Prot.* 57:931 (1994).
78. I. Hayakawa, T. Kanno, K. Yoshiyama, and Y. Fujio, Oscillatory compared with continuous high pressure sterilization on *Bacillus stearotherophilus* spores, *J. Food Sci.* 59:164 (1994).
79. R. V. Lechowich, Food safety implications of high hydrostatic pressure as a food processing method, *Food Technol.* 47(6):170 (1993).
80. P. Butz, S. Funtenberger, T. Haberditzl, and B. Tauscher, High pressure inactivation of *Byssochlamys nivea* ascospores and other heat resistant moulds, *Lebensm. Wiss. Technol.* 29:404 (1996).
81. S. Shimada, M. Andou, N. Naitto, N. Yamada, M. Osumi, and R. Hayashi, Effects of hydrostatic pressure on the ultrastructure and leakage of internal substances in the yeast *Saccharomyces cerevisiae*, *Appl. Microbiol. Biotechnol.* 40:123 (1993).
82. J. P. Smelt, Some mechanistic aspects of inactivation of bacteria by high pressure, *Proceedings of European Symposium—Effects of High Pressure on Foods*, University of Montpellier, Montpellier (1995).
83. J. P. Perrier-Cornet, P. A. Maréchal, and P. Gervais, A new design intended to relate high pressure treatment to yeast cell mass transfer, *J. Biotechnol.* 41:49 (1995).
84. R. Jaenicke, Enzymes under extreme conditions, *Ann. Rev. Biophys. Bioeng.* 10:1 (1981).
85. R. Y. Morita, Effect of hydrostatic pressure on succinic, malic and formic dehydrogenases in *Escherichia coli*, *J. Bacteriol.* 74:251 (1957).
86. B. M. Mackey, K. Forestiere, N. S. Isaacs, R. Stenning, and B. Brooker, The effect of high hydrostatic pressure on *Salmonella thompson* and *Listeria monocytogenes* examined by electron microscopy, *Lett. Appl. Microbiol.* 19:429 (1994).
87. M. Sato, H. Kobori, S. A. Ishijima, Z. H. Feng, K. Hamada, S. Shimada, and M. Osumi, *Schizosaccharomyces pombe* is more sensitive to pressure stress than *Saccharomyces cerevisiae*, *Cell Struct. Func.* 21:167 (1996).
88. P. Masson, Pressure denaturation of proteins, in *High Pressure and Biotechnology* (C. Balny, R. Hayashi, K. Heremans, and P. Masson, Eds.), Colloque INSERM, Vol. 224, John Libbey Eurotext, Montrouge, France, p. 89 (1992).
89. J. M. Thevelein, J. A. Van Assche, K. Heremans, and S. Y. Gerlisma, Gelatinization temperature of starch, as influenced by high pressure, *Carbohydrate Res.* 93:304 (1981).
90. P. Grop and H. Ludwig, Pressure-temperature phase diagram for the stability of bacteriophage T4, in *High Pressure and Biotechnology* (C. Balny, R. Hayashi, K. Heremans, and P. Masson, Eds.), Colloque INSERM, Vol. 224, John Libbey Eurotext, Montrouge, France, p. 57 (1992).

91. T. Ohshima, T. Nakagawa, and C. Koizumi, *Seafood Science and Technology* (E. G. Blich, Ed.), Fishing News Books, Oxford, UK, p. 64 (1992).
92. T. Ohshima, H. Ushio, and C. Koizumi, High pressure processing of fish and fish products. *Trends Food Sci. Technol.* 4:370 (1993).
93. P. B. Cheah and D. A. Ledward, High pressure effects on lipid oxidation, *JAOCS* 72:1059 (1995).
94. P. B. Cheah and D. A. Ledward, High pressure effects on lipid oxidation in minced pork, *Meat Sci.* 43:123 (1996).
95. T. Tamaoka, N. Itoh, and R. Hayashi, High pressure effect on Maillard reaction, *Agric. Biol. Chem.* 55:2071 (1991).
96. V. M. Hill, D. A. Ledward, and J. M. Ames, Influence of high hydrostatic pressure and pH on the rate of Maillard browning in a glucose-lysine system, *J. Agric. Food Chem.* 44:494 (1996).
97. K. Hayashi, S. Takahashi, H. Asano, and R. Hayashi, in *Pressure-Processed Food* (R. Hayashi, Ed.), San-Ei Shuppan Co., Kyoto, p. 277 (1990).
98. C. Suzuki and K. Suzuki, The gelation of ovalbumin solutions by high pressure, *Arch. Biochem. Biophys.* 102(3):367 (1963).
99. D. E. Johnston, High pressure effects on milk and meat, *High Pressure Processing of Foods* (D. A. Ledward, D. E. Johnston, R. G. Earnshaw, and A. P. M. Hasting, Eds.), Nottingham University Press, Nottingham, p. 99 (1995).
100. L. Heremans and K. Heremans, Raman spectroscopic study of the changes in secondary structure of chymotrypsin: effect of pH and pressure on the salt bridge, *Biochem. Biophys. Acta* 999:192 (1989).
101. N. Homma, Y. Ikeuchi, and A. Suzuki, Effect of high pressure treatment on the proteolytic enzymes in meat, *Meat Sci.* 38:219 (1994).
102. L. B. Kurth, Effect of pressure-heat treatments on cathepsin B1 activity, *J. Food Sci.* 51:663 (1986).
103. I. N. A. Ashie, B. K. Simpson, and H. S. Ramaswamy, Control of endogenous enzyme activity in fish muscle by inhibitors and hydrostatic pressure using RSM, *J. Food Sci.* 61:350 (1996).
104. M. N. Eshtiaghi and D. Knorr, Potato cubes response to water blanching and high hydrostatic pressure, *J. Food Sci.* 58:1371 (1993).
105. G. B. Quaglia, R. Gravina, R. Paperi, and F. Paoletti, Effect of high pressure treatments on peroxidase activity, ascorbic acid content and texture in green peas, *Lebensm. Wiss. Technol.* 29:552 (1996).
106. M. Anese, M. C. Nicoli, G. Dall'Aglio, and C. R. Lericci, Effect of high pressure treatments on peroxidase and polyphenoloxidase activities, *J. Food Biochem.* 18:285 (1995).
107. C. Balny and P. Masson, Effects of high pressure on proteins, *Food Rev. Int.* 9:611 (1993).
108. I. Seyderhelm, S. Bouguislawski, G. Michaelis, and D. Knorr, Pressure induced inactivation of selected enzymes, *J. Food Sci.* 61:308 (1996).
109. P. Butz, W. D. Koller, B. Tauscher, and S. Wolf, Ultra-high pressure processing of onions: chemical and sensory changes, *Lebensm. Wiss. Technol.* 27:463 (1994).
110. M. Asaka and R. Hayashi, Activation of polyphenol oxidase in pear fruits by high pressure treatment, *Agric. Biol. Chem.* 55:2439 (1991).
111. M. R. A. Gomes and D. A. Ledward, Effect of high-pressure treatment on the activity of some polyphenoloxidases, *Food Chem.* 56:1 (1996).
112. A. Ibarz, E. Sangronis, G. Barbosa-Cánovas, and B. G. Swanson, Inhibition of polyphenoloxidase in apple slices during high hydrostatic pressure treatments, *1996 IFT Annual Book of Abstracts*, New Orleans, p. 100 (1996).
113. M. P. Cano, A. Hernández, and B. De Ancos, High pressure and temperature effects on enzyme inactivation in strawberry and orange products, *J. Food Sci.* 62:85 (1997).
114. J. J. Macfarlane, Pre-rigor pressurization of muscle: effects on pH, shear value and taste panel assessment, *J. Food Sci.* 38:294 (1973).
115. E. Dumay, C. Lambert, S. Funtenberger, and J. C. Cheftel, Effects of high pressure on the physico-chemical characteristic of dairy creams and model oil/water emulsions, *Lebensm. Wiss. Technol.* 29:606 (1996).
116. W. Buchheim and A. M. Abou El Nour, Induction of milk fat crystallization in the emulsified state by high hydrostatic pressure, *Fat Sci. Technol.* 10:369 (1992).
117. S. Nagatsuji, The fat of the land under pressure, *Look Japan* (October):28 (1992).
118. Y. N. Hone, K. I. Kimura, and M. S. Ida, Jams treated at high pressure, U.S. patent 5,075,124 (1991).

119. A. El Moueffak, C. Cruz, M. Antoine, M. Montury, G. Demazeau, A. Largeteau, B. Roy, and F. Zuber, High pressure and pasteurization effect on duck foie gras, *Int. J. Food Sci. Technol.* 30:737 (1995).
120. M. N. Estiaghi, R. Sute, and D. Knorr, High-pressure and freezing pretreatment effects on drying, rehydration, texture and color of green beans, carrots and potatoes, *J. Food Sci.* 59:1168 (1994).
121. K. Takahashi, Sterilisation of microorganisms by hydrostatic pressure at low temperatures, in *High Pressure and Biotechnology* (C. Balny, R. Hayashi, K. Heremans, and P. Masson, Eds.), Colloque INSERM, Vol. 224, John Libbey Eurotext, Montrouge, France, p. 297 (1992).
122. E. A. Elgasim and W. H. Kennick, Effect of pressurization of pre-rigor beef muscles on protein quality, *J. Food Sci.* 45:1122 (1980).
123. M. Okamoto, Y. Kawamura, and R. Hayashi, Application of high pressure to food processing: textural comparison of pressure- and heat-induced gels of food proteins, *Agric. Biol. Chem.* 54(1):183 (1990).
124. A. Ibarz, E. Sangronis, L. Ma, G. V. Barbosa-Cánovas, and B. G. Swanson, Viscoelastic properties of egg gels formed under high hydrostatic pressure, *1996 IFT Annual Book of Abstracts*, New Orleans, p. 180 (1996).
125. R. Hayashi and A. Hayashida, Increased amylase digestibility of pressure-treated starch, *Agric. Biol. Chem.* 53:2543 (1989).
126. L. Popper and D. Knorr, Applications of high-pressure homogenization for food preservation, *Food Technol.* 44(7):84 (1990).
127. A. M. Papineau, D. G. Hoover, D. Knorr, and D. F. Farkas, Antimicrobial effect of water-soluble chitosana with high hydrostatic pressure, *Food Biotechnol.* 5:45 (1991).
128. K. J. A. Hauben, E. Y. Wuytack, C. C. F. Soontjens, and C. W. Michiels, High-pressure transient sensitization of *Escherichia coli* to lysozyme and nisin by disruption of outer-membrane permeability, *J. Food Prot.* 59:350 (1996).
129. H. Stapelfeldt, P. H. Petersen, K. R. Kristiansen, K. B. Qvist, and L. H. Skibsted, Effect of high hydrostatic pressure on the enzymic hydrolysis of f3-lactoglobulin B by trypsin, thermolysin and pepsin, *J. Dairy Res.* 63:111(1996).
130. S. Funtenberger, E. Dumay, and J. C. Cheftel, Pressure-induced aggregation of f3-lactoglobulin in pH 7.0 buffers, *Lebensm. Wiss. Technol.* 28:410 (1995).
131. B. H. Hite, N. J. Giddings, and C. E. Weakly, The effects of pressure on certain microorganisms encountered in the preservation of fruits and vegetables, *Bull.* 146 W. Va. Univ. Agric. Exp. Sta., Morgantown, p. 1 (1914).
132. M. Capellas, M. Mor-Mur, E. Sendra, R. Pla, and B. Guamis, Populations of aerobic mesophils and inoculated *E. coli* during storage of fresh goat's milk cheese treated with high pressure, *J. Food Prot.* 59:582 (1996).
133. G. Deplace, Vessel design, in *High Pressure Processing of Foods* (D. A. Ledward, D. E. Johnston, R. G. Earnshaw, and A. P. M. Hasting, Eds.), Nottingham University Press, Nottingham, p. 137 (1995).



# 35

## *Applications of Magnetic Field in Food Preservation*

Jasim Ahmed and Hosahalli S. Ramaswamy

### CONTENTS

35.1	Introduction .....	855
35.2	Basics of Magnetism and Magnetic Field .....	856
35.2.1	Magnetism .....	856
35.2.2	Magnetic Fields .....	856
35.2.3	Magnetic Field Lines .....	857
35.2.4	Symbols and Terminology .....	857
35.2.5	Types of Magnetic Field .....	858
35.3	Magnetic Field Generation .....	858
35.3.1	Field Generation by Currents in Wires .....	858
35.3.2	Static Magnetic Fields Technique .....	859
35.3.3	Oscillation Magnetic Fields Technique .....	859
35.3.4	Ultra-High Magnetic Fields .....	860
35.4	Application of Magnetic Fields in Food Preservation .....	860
35.4.1	Pasteurization .....	860
35.4.2	Microbial Systems .....	861
35.4.2.1	Inactivation of Microorganisms .....	861
35.4.2.2	Mechanisms of Microbial Inactivation .....	862
35.4.2.3	Propagation of Yeast .....	862
35.4.2.4	Yeast under High-Gradient Magnetic Field .....	863
35.4.3	Sterilization by Magnetic Fields .....	863
35.4.4	Biological System .....	863
35.4.5	Isolation and Separation of Protein by Magnetic Technique.....	864
35.5	Other Magnetic Properties' Applications in Food Quality Systems .....	864
35.5.1	Magnetic Resonance Imaging .....	864
35.5.2	Application of Magnetic Fields in Quality Control of Food Products .....	864
35.6	Conclusion and Future Research Needs .....	865
	References .....	865

### 35.1 Introduction

Various thermal processes such as blanching, pasteurization, and sterilization have been traditionally used for enzyme and microbial inactivation as efficient, economic, reliable, and safe food preservation techniques. Application of heat, however, has some limitations because of its adverse effect on product quality. Thermal energy induces various biochemical reactions, leading to quality deterioration in foods that results in undesirable changes in nutritional and sensory characteristics [1,2]. It is, therefore, those emerging and novel technologies, which can overcome the limitations of thermal processing, that draw attention of food processors as well as consumers. Increasing consumer demand for newer food products with health benefits, desirable sensory characteristics, and higher quality has also led to the development of mild preservation techniques or minimally processed foods.

In the past, several mild preservation techniques have been developed. Gamma irradiation is one of those. Although the technique has been successful to decontaminate food, consumer acceptability is very low for this process. In recent years, the advent of some nonthermal processing systems that pasteurize and sterilize foods has been emerging as an alternative to conventional thermal processes. Most of these novel processes also focus on energy-saving and eco-friendly applications. These processes have similarity in that they are mild for the food and kill the spoilage and pathogenic microorganisms. The food product in question retains most of its natural appearance. In addition, these technologies are of specific interest to the food industry because they not only provide attractive alternatives to conventional methods of thermal processing, which often produce undesirable changes in foods, affecting the balance between high quality and process economy without compromising safety, but also offer opportunities for creating new ingredients and products because of their specific actions on biological materials and food constituents [3].

Some of the potential mild preservation techniques are (i) high hydrostatic pressure, (ii) pulsed electric fields, (iii) oscillating magnetic fields (OMFs), (iv) high-intensity light pulses, (v) electron-beam radiation, (vi) microwave and radiofrequency, (vii) ohmic and inductive heating, (viii) high voltage arc discharge, (ix) ultrasound, and (x) X-ray. Among the above technologies, some are now applied commercially while some others are still in the developmental stages. Application of magnetic fields to process food products is one of these novel nonthermal processing methods, and very limited studies have been carried out on the application and commercialization of this technology. The process could produce fresh-like attributes of foods by retaining thermolabile nutrients, reduced energy requirements for processing, inactivation of microorganisms, and, in some cases, the potential treatment of foods inside flexible packages [4]. Application of magnetic fields in food fermentation industry could be a major success by controlling cellular growth and inhibition.

---

## **35.2 Basics of Magnetism and Magnetic Field**

### **35.2.1 Magnetism**

Magnetism is a phenomenon by which materials exert an attractive or repulsive force on other materials. The origin of magnetism lies in the orbital and spin motions of electrons, and how the electrons interact with each other. The best way to introduce the different types of magnetism is to describe how materials respond to magnetic fields. The materials are mostly classified as diamagnetic, paramagnetic, and ferromagnetic according to their response to magnetic fields.

Diamagnetism is a fundamental property of all matter, though it is usually very weak. It results from the noncooperative behavior of orbiting electrons during exposure to magnetic field. Diamagnetic substances are made of atoms that do not have any net magnetic moments (all the orbital shells are filled and there are no odd electrons). Water is a good example of a diamagnetic material/fluid. However, when exposed to a field, a negative magnetization is produced and thus the susceptibility is negative. In paramagnetic materials, some of the atoms or ions have a net magnetic moment due to unpaired electrons in partially filled orbitals. Oxygen is the best example with unpaired electrons. However, the individual magnetic moments do not interact magnetically, and similar to diamagnetism, the magnetization becomes zero when the field is taken out. In the presence of a field, there is now a partial alignment of the atomic magnetic moments in the direction of the field in ferromagnetic materials, resulting in a net positive magnetization and positive susceptibility. Unlike paramagnetic materials, the atomic moments in ferromagnetic materials exhibit very strong interactions. These interactions are developed by electronic exchange forces, resulting in a parallel or antiparallel alignment of atomic moments. Exchange forces are very large, equivalent to a field in the order of 1000 Tesla, or approximately a 100 million times the strength of the earth's field. The exchange force is a quantum mechanical phenomenon due to the relative orientation of the spins of two electrons. Ferromagnetic materials exhibit parallel alignment of moments, resulting in large net magnetization even in the absence of a magnetic field. The most common examples of ferromagnetic materials are iron, nickel, cobalt, and some steels.

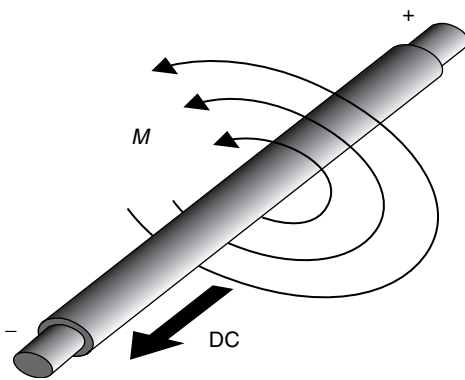
### **35.2.2 Magnetic Fields**

A magnet is surrounded by an invisible force field. A magnetic field is a field of magnetic force generating out from a permanent magnet. Magnetic fields are created by moving charged particles: in

electromagnets, electrons flow through a coil of wire connected to a battery; in permanent magnets, spinning electrons within the atoms generate the field (Figure 35.1). The strength of the magnetic field is a direct function of current passing in the wire. An electromagnetic (EM) field contains both an electrical and a magnetic field. In the case of a fluctuating magnetic or EM field, the field is characterized by its rate or frequency of fluctuation (e.g., one fluctuation per second is equal to 1 Hz, the unit of frequency). Lines of magnetic force can be seen around a magnet by sprinkling iron filings onto a sheet above it and tapping the sheet. The strength of the magnetic force is strongest when the poles are nearer and gets weaker while the poles move away from each another. A magnetic field can also be created by the spin magnetic dipole moment, and by the orbital magnetic dipole moment of an electron within an atom. A magnetic field is a vector field: it associates with every point in space a vector that may vary in time. The direction of the field is the equilibrium direction of a compass needle placed in the field.

### 35.2.3 Magnetic Field Lines

Magnetic field lines are a way to visualize the magnetic field clearly. The magnetic fields generated by a single magnet are illustrated in Figure 35.2. The distance between those lines indicates the strength of the field when drawn properly. The closer the distance, the stronger the field is found to be. The number of lines per square centimeter measures the strength of the magnetic field. Technically, 1 Gauss is equivalent to 1 magnetic field line within 1 cm<sup>2</sup>. Also, the direction of the tangent to the field line is the direction of the magnetic field at that point.

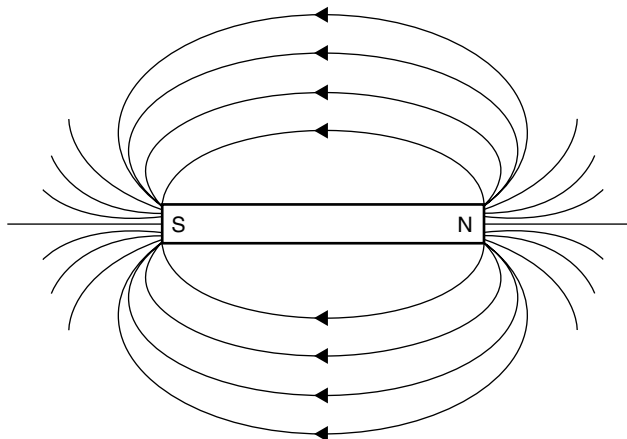


**FIGURE 35.1** Current flowing through a wire produces a magnetic field (*M*) around the wire.

### 35.2.4 Symbols and Terminology

The fundamental vector quantities describing a magnetic field are the magnetic field strength *H* and the magnetic flux density *B* (also called the magnetic induction). The relationship between magnetic flux density *B* and the magnetic field strength *H* is given by  $B = \mu H$ , which is used to describe the magnetic field generated by currents that flow in conductors. The value of  $\mu$  (the magnetic permeability) is determined by the properties of the medium.

For most biological materials, the permeability  $\mu$  is equal to  $\mu_0$ , the value of permeability of free space (air) ( $1.257 \times 10^{-6}$  H/m). Thus, for biological materials, the values of *B* and *H* are related by the constant  $\mu_0$ .



**FIGURE 35.2** Single magnet exhibiting magnetic field.



Magnetic fields, like electric fields, are produced by electric charges, but only when these charges are in motion. Magnetic fields exert forces on other charges but, again, only on charges that are in motion. The magnitude of the force  $\mathbf{F}$  acting on an electric charge  $q$  moving with a velocity  $\mathbf{v}$  in the direction perpendicular to a magnetic field of flux density  $\mathbf{B}$  is given by

$$\mathbf{F} = q\mathbf{v} \times \mathbf{B} \quad (35.1)$$

Equation 35.1 is known as Lorentz force law. The direction of  $\mathbf{F}$  is perpendicular to both those of  $\mathbf{v}$  and  $\mathbf{B}$ . If, instead, the direction of  $\mathbf{v}$  were parallel to  $\mathbf{B}$ , then  $\mathbf{F}$  would be zero. This indicates an important characteristic of a magnetic field: it does no physical work because the force, called the Lorentz force, generated by its interaction with a moving charge is always perpendicular to the direction of motion.

The basic unit of the magnetic flux density can be obtained from Equation 35.1 to be Newton second per coulomb meter (N s/C m). In SI units,  $B$  and  $H$  are measured in tesla (T) and amperes per meter (A/m), respectively; or, in cgs units, in gauss (G) and oersteds (Oe), respectively. The conversion between the gauss (G), the cgs unit of flux density, and the tesla is  $1 \text{ T} = 10^4 \text{ G}$ . A simpler form of the force equation in a wire current loop is given by

$$F = BLi = (\text{tesla}) \times (\text{m}) \times (\text{amp})$$

A more complex explanation is that if the moving charge is part of a current in a wire, then an equivalent form of the law is given below:

$$\frac{d\mathbf{F}}{dl} = \mathbf{i} \times \mathbf{B} \quad (35.2)$$

In other words, Equation 35.2 infers that the force per unit length of wire is the cross product of the current vector and the magnetic field. In Equation 35.2, the current vector,  $\mathbf{i}$ , is a vector with magnitude equal to the usual scalar current,  $i$ , and direction pointing along the wire in which the current is flowing.

### 35.2.5 Types of Magnetic Field

Magnetic fields may be homogeneous or heterogeneous, and can be in static and pulsed mode. In a homogeneous magnetic field, the field intensity is uniform in the area enclosed by the magnetic field coil, while in a heterogeneous field, the field intensity is nonuniform and field intensity decreases as distances from the center of the coil increases. Static magnetic fields (SMFs) show a constant strength over time and are generated by permanent magnets or direct current electromagnets. An OMF is applied in the form of constant amplitude or decaying amplitude sinusoidal waves and exhibits an intensity gradient over time depending on the nature of the magnet. OMFs are generated by alternate current electromagnets within pulsed fields, and the field intensity alters periodically depending on the frequency and type of wave generating from the electric current in the magnet [5]. The magnetic fields have been classified again as high- or low-intensity field as per their relative intensity. Low-intensity magnetic fields show strength in the order of 1/10th of a gauss, while high-intensity fields show strength in the order of thousands of gauss or greater [6].

---

## 35.3 Magnetic Field Generation

### 35.3.1 Field Generation by Currents in Wires

The simplest way a magnetic field is created is by supplying current along a long straight wire. The magnetic field from such a current-carrying wire actually wraps around the wire in circular loops, decreasing in magnitude with increasing distance from the wire. The magnitude of the field at a distance  $r$  from a wire carrying a current  $I$  is given by

$$B = \mu_0 I / 2\pi r \quad (35.3)$$

where  $\mu_0$  (the permeability of free space) is a constant and  $\mu_0 = 4\pi \times 10^{-7} \text{ Tm/A}$ . The magnetic action to inactivate microorganisms has some required specific field strengths, which varies between 5 and 50 T. The generation of such field strength is carried out by either (i) superconducting coils, (ii) coils that generate DC fields, or (iii) coils that can be energized by the discharge of the energy stored in a capacitor [7]. Magnetic fields generated by iron core in coil cannot produce the required intensities for microbial

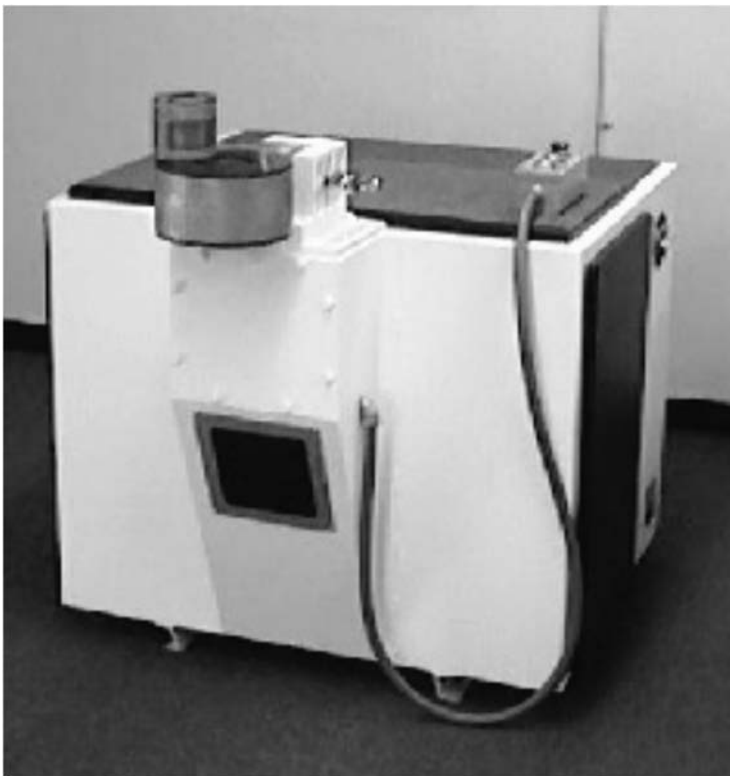
inactivation and therefore are not suitable for the purpose. The air-core solenoids can produce higher intensities and the intensity is directly related to flowing current, which is found to be a limiting factor due to huge power consumption and heat generation [5].

### 35.3.2 Static Magnetic Fields Technique

Superconducting magnets are a good choice for high-intensity magnetic field generation since they avoid heating effects. Magnetic field generation with coils of superconducting metal has been used by various researchers. Metals behave as superconductors (electricity passes through the wire with no resistance) in liquid helium environment ( $-268.9^{\circ}\text{C}$ ). This generates a magnetic field of about 2 T, which is about 40,000 times stronger than the earth's magnetic field (0.0005 T). The liquid helium is insulated by a dewar of liquid nitrogen, which helps to reduce the loss of helium from the magnets. The magnets need to be filled with liquid nitrogen regularly (weekly), and with liquid helium about once a month, which makes this type of magnet expensive to run. However, it has also some limitation in field intensity, with maximum limits of about 20 T. A hybrid magnet contains a superconducting magnetic coil and water cooled magnetic coil that can produce 15–30 T. Magnetic field above 30 T has been generated in a pulsed form by supplying current of 40 kA for short time period [8].

### 35.3.3 Oscillation Magnetic Fields Technique

Considerable effort has been made to generate high-intensity magnetic fields to extend the available field range. Magneform® magnetic forming systems (Magneform, San Diego, CA) have achieved wide acceptance as a proven production method on today's high-volume assembly lines. Magneform machines have been routinely used to form join or assemble parts of metals (Figure 35.3) and tested for food processing applications. Hofmann [9] was probably the first one to test Magneform 7000 for food applications, and such equipment have been used more recently by Harte et al. [24]. The working



**FIGURE 35.3** Magneform unit. (With permission from Magneform Corporation, USA.)

principles and coil circuits have been well described by Pothakamury et al. [5]. The instrument can store the energy in a capacitor bank. The basic magnetic pulse principle is the same as that which activates a simple electric motor. An electric current generates pulsed OMF between the plates of the capacitors, where the food sample is held in plastic bags. The frequency of the magnetic field is dictated by the capacitor's capacitance and the resistance, and induction of the coil. An OMF of 2–50 T is achieved while a coil has been connected to a capacitor of 8–16 kJ [9].

### 35.3.4 Ultra-High Magnetic Fields

The generation of higher field (in megagauss ranges) is still difficult because of the coil destruction by the higher EM forces. Miura et al. [10] have developed ultra-high magnetic fields in the megagauss range using EM flux compression technique and direct fast current discharge into a single turn coil. The authors have claimed that the novel processes can generate 500–1000 T field strength.

Scientists from the National High Magnetic Field Laboratory, University of Florida, have recently developed [11] one superconducting magnet, which stands 16 ft tall and weighs more than 15 t. Now, with its commissioning, scientists from around the world will be able to expand the horizons of scientific investigation using nuclear magnetic resonance (NMR) and magnetic resonance imaging (MRI) technologies. The bore is the space within the magnet that holds the sample being tested. The bore size of this magnet (105 mm) makes it particularly useful for scientific research. The 900 MHz magnet delivers 21 T magnetic fields that vary by less than 0.0000002 T over a volume roughly equal to the size of a small orange—an accomplishment unrivaled anywhere else in the world.

---

## 35.4 Application of Magnetic Fields in Food Preservation

### 35.4.1 Pasteurization

The basis of food preservation lies on inactivation of enzymes and microorganisms, which would produce safe food for human consumption. The microbial growth can either be stimulated or ceased during exposure to magnetic fields. Retardation of growth and reproduction of microorganisms might be due to change in deoxyribose nucleic acid (DNA) synthesis, a change in the orientation of biomolecules and biomembranes to a direction parallel or perpendicular to the applied magnetic field, or a change in the ionic drift across the plasma membrane [5].

The first approach of food preservation by OMF was initiated by Hofmann [9] with a US patent. The basic requirement for the application of OMF technology for food preservation is that the food should have high electrical resistivity, greater than 10–25 ohms-cm. Many foods have electric resistivity in these ranges. One most common example of food that can be processed by OMF technique is orange juice. The electrical resistivity of orange juice is about 30 ohms-cm. The field intensity of the food to be magnetized is a function of electrical resistivity and sample thickness. However, no correlation has been observed between magnetic field intensities and food constituents.

Inactivation of microorganisms in food has been reported to occur during exposure to OMFs with intensity higher than 2 T [9]. A single pulse intensity of 5–50 T and frequency of 5–500 kHz reduced the initial number of microorganisms by 2 log cycles. The technology could be applied for food pasteurization purpose by placing the sample in magnetic field and magnetized. The author reported the application of OMF for selected food products to control specific spoilage microorganisms as shown below:

- Milk with *Streptococcus thermophilus*
- Yoghurt with *Saccharomyces cerevisiae*
- Orange juice with *S. cerevisiae*
- Brown'n Serve rolls dough with bacterial spores

These studies also indicate that the temperature increase during magnetic field effects is almost negligible (maximum 2°C) and the reduction of microorganisms range between 1.4 and 3.6 log cycles.

## 35.4.2 Microbial Systems

### 35.4.2.1 Inactivation of Microorganisms

Almost all living organisms are exposed to magnetic fields from various sources. The geomagnetic field on the surface of the earth is ~0.50–0.75 Gauss in strength. When a magnetic field is applied to microorganisms in a liquid culture, it is distorted or weakened by that culture. A strong field may significantly affect microorganisms, or even kill them. Effects of magnetic fields on microbial growth have been classified by Yoshimura [12] as inhibitory, stimulatory, and nonobservable.

Several studies have been carried out on the effects of exposure to magnetic fields and many of these findings are inconsistent (Table 35.1). Hoffman [9] first advocated that exposure to magnetic fields causes inhibition in the growth and reproduction of microorganisms. Exposing food infected with microorganisms to an OMF at frequencies of 5–50 kHz and with an EM strength of 5–50 T reduced the microorganism population by 2 to 3 log cycles. The formation of metastable pores by the presence of natural magnetite or contaminant magnetic particles on cell membranes has been considered an effect of magnetic field [13]. The growth rate of the Burgundy wine yeast has been reported to decrease by the application of an extremely low magnetic flux density of 0.04 T [14]. On the contrary, the accelerated growth rate of *Trichomonas vaginalis* was reported when exposed to 46–120 T [15]. The growth rate of *Bacillus subtilis* was also found to increase when exposed to 0.15 T and decrease when exposed to more than 30 T [16]. Similar results were reported for *Chlorella*: an exposure of less

**TABLE 35.1**

Magnetic Field Effect on Microorganisms

Type of Microorganisms	Nature of Magnetic Fields	Field Strengths (T)	Major Finding	References
Burgundy wine yeast cells	Static	0.04	Growth retardation during exposure at 5–150 min; no retardation at 10, 15, and 17 min	[14]
<i>Trichomonas vaginalis</i>	Static	4.60–12	Growth was accelerated	[15]
<i>Escherichia coli</i>	Oscillation	0.05	Inactivation of cells when concentration was 100 cells/mL	[16]
<i>Streptococcus thermophilus</i> in milk	Oscillation	12.0	Cell population reduced from 25,000 to 970 cells/mL	[16]
<i>Saccharomyces</i> in yogurt	Oscillation	40.0	Cell population reduced from 3500 to 25 cells/mL	[9]
in orange juice	Oscillation	40	Cell population reduced from 25,000 to 6 cells/mL	[9]
Mold spores	Oscillation	7.5	Population reduced from 3000 to 1 spore/mL	[9]
<i>Escherichia coli</i>	Static	5.2–6.1	Magnetic field increased viable cells by 150 times after incubation for 48 h	[22]
<i>Escherichia coli</i> , <i>Leclercia adecarboxylata</i> , and <i>Staphylococcus aureus</i>	Oscillation	0.01	Magnetic field causes the decrease of CFU in all exposed samples. The maximum decrease of CFU was observed for <i>E. coli</i> ; <i>S. aureus</i> strain found to be most resistant to the magnetic field	[23]
<i>Saccharomyces cerevisiae</i>	Static	5–14	Rate of proliferation under the magnetic fields decreased after 16 h of incubation compared to control sample	[34]

than 400 G increased the growth, while exposure to 580 G decreased the growth rate [17]. Several studies point to the magnetic fields as a factor influencing the growth and survival of living organisms, which vary at different magnetic flux densities [18–21].

Strength of magnetic field has significant effects on microbial growth and survival. The cellular growth in the stationary phase of *Escherichia coli* under a heterogeneous magnetic field of 5.2–6.1 T was found to exhibit a significant increase in number of cells by about  $10^5$  compared to geomagnetic field cell cultivation at a specific amino acid concentration [22]. The authors claimed that such a marked death suppression effect by the high magnetic field had never been reported earlier. The amount of sigma S factor encoded by the *rpoS* gene under high magnetic field was 20% higher in comparison to control geomagnetic field, which might be part of the reason why a large number of cells in the stationary phase were maintained under the heterogeneous magnetic field. Fojt et al. [23] studied biological effects of low-frequency EM fields using three different bacterial strains namely *E. coli*, *Leclercia adecarboxylata*, and *Staphylococcus aureus* to the magnetic field. The strength and frequency of the field were 10 mT and 50 Hz, respectively, whereas the residence time was less than 30 min. The low magnetic field caused a decrease in colony forming unit (CFU) in all exposed samples. Viability decreased with longer exposure time or higher induction fields for all strains, but the quantity of the effect was strain dependent. The highest decrease of viability and the largest magnetic field effect were observed for *E. coli*. The smallest magnetic field effect appeared for *S. aureus*. From the measurement of the growth dynamics, it was concluded that the decrease in the CFU started immediately after the magnetic field was applied. However, Harte et al. [24] found no significant reductions in *E. coli* under magnetic fields lower than or equal to 18 T generated by both OMF and SMF using a 7000 series Magneform machine (Maxwell Laboratories, CA) and a superconducting magnet (National High Magnetic Field Laboratory, NM), respectively.

The finding that the viability of cells is enhanced under a high magnetic field implies that the productivity of antibiotics or enzymes by microorganisms will be enhanced under a high magnetic field. It is already reported that the high magnetic field has no mutagenic or adverse effect on biological cells [25].

#### 35.4.2.2 Mechanisms of Microbial Inactivation

Several hypotheses have been postulated for the mechanism of microbial inactivation by magnetic action. The inactivation of microorganisms may be based on the theory that the OMF may couple energy into the magnetically active parts of large molecules such as DNA [9]. Within the 5–50 T range, the amount of energy per oscillation coupled to 1 dipole in the DNA is  $10^{-2}$  to  $10^{-3}$  eV. Pothakamury et al. [5] described two theories on microbial inactivation process using either SMFs or OMFs:

1. A weak OMF could weaken bonds between ions and proteins used in metabolism and membrane integrity. In SMF such as that of the earth, the biological effects of OMF are more pronounced around particular frequencies, the cyclotron resonance frequency of ions [26].
2. The effect of magnetic fields on calcium ions bound in calcium-binding proteins such as calmodulin. The  $\text{Ca}^{2+}$  ions vibrate regularly to an equilibrium position in the binding site of calmodulin. A steady magnetic field applied to calmodulin results in the rotation of the plane of vibration, or proceeds in the direction of magnetic field at a frequency that is exactly similar to the cyclotron frequency of the bound calcium. Adding a “wobbling” magnetic field at the cyclotron frequency disturbs the precision to such an extent that it loosens the bond between the calcium ion and the calmodulin [5].

The results presented in Table 35.1 show that, although not well understood, the effect of magnetic fields on the microbial population of foods may depend on the magnetic field intensity, number of pulses, frequency, and property of the food (i.e., resistivity, electrical conductivity, and thickness of the foodstuff). Unfortunately, the effects of magnetic fields on microorganisms have produced conflicting results. Until more consistent and convincing results are produced, the prospects for this technology are questionable.

#### 35.4.2.3 Propagation of Yeast

Studies concerning the use of *S. cerevisiae* as a cell model have reported that proliferation increases more than 25% at 50 Hz and 0.5 mT alternating magnetic fields during 10 h exposure [27]. Nevertheless, the effect observed by these authors when they used 0.2 mT, 50 Hz, in the exposition is the inhibitory action

(16%) of the cell proliferation. The cell growth dependence with field frequency found by them exhibits positive responses by more than 20% increase in the cell number after 10 h of exposure to 15 and 50 Hz. However, conflicting results have been reported by Ruiz-Gómez et al. [28] while studying the growth effects induced by static and sinusoidal 50 Hz magnetic fields on the haploid yeast strain *S. cerevisiae*. Magnetic fields were produced by a pair of Helmholtz coils (40 cm in diameter) with 154 turns of copper wire in each and separated by 20 cm. The experiments were carried out at 0.35 and 2.45 mT, and yeasts were exposed to magnetic field for time periods of 24 and 72 h in the homogeneous field area. Growth was recorded by measuring the optical density at 600 nm. They reported that static and sinusoidal 50 Hz magnetic field (0.35 and 2.45 mT) did not induce changes in the growth of *S. cerevisiae*.

#### 35.4.2.4 Yeast under High-Gradient Magnetic Field

Superconducting technology has provided new methods for studying the application of strong magnetic fields in biological systems and dia- or paramagnetic materials. Room temperature bores of superconducting magnets have given opportunities to explore the importance of the diamagnetism of biological materials [29,30] as well as that of strong (ferro-) magnetism in solid-state materials. A new approach using superconducting technology involved gradient magnetic fields in the horizontal direction, which made several interesting phenomena. It was reported that the surface of water bends downward under the magnetic field of 10 T or so at the center [31]. The parting of water has been termed as “Moses effect,” a phenomenon in which the surface of water has been separated under high magnetic fields [32]. The horizontal gradient magnetic force and the vertical gravitational force generate a sloping gravity-like field for living organisms [33], in which the sloping field is considered to be the actual direction of gravity. In the case of the parting of water, the water was pushed to lower magnetic fields from higher fields, and localized in the middle part of the space forming a “water wall.” However, the applied field should be high and steep enough to clearly observe these effects.

The effects of gradient magnetic fields on the behavior of yeast (*S. cerevisiae*) proliferation and mass distribution have been reported also by Iwasaka et al [34] using strong SMFs (flux density 14 T). When yeast was exposed to 9–14 T magnetic fields with a maximum flux density gradient of  $dB/dx = 94$  T/m, where  $x$  is the space coordinate, the rate of yeast proliferation under the magnetic fields decreased after 16 h of incubation compared to that of the control. The results indicated that the gas pressure inside a flask with 6 T, 60 T/m gradually increased in comparison to the pressure inside a control tube. Owing to the diamagnetism of medium water and yeast, the liquid surface clearly inclined under gradient magnetic fields, and the hydrostatic force in suspension was strengthened by the diamagnetic forces. In addition, magnetophoresis of the yeast cells in the medium solution exhibited localization of the yeast sedimentation pattern. The mechanisms for deceleration of yeast proliferation by magnetic fields have been proposed and well described by Iwasaka et al. [34].

#### 35.4.3 Sterilization by Magnetic Fields

Complete sterilization is possible by exposure of magnetic fields to more than one oscillation sequence [35]. Microorganisms tested in this effect are viruses, bacteria, molds, protozoa, and algae. The decaying magnetic oscillations can be produced by discharging voltage from a capacitor into a coil so that the capacitor and coil are in an electrical loop, and no other components will deter from the natural back and forth oscillations that result from the electrical current varying in direction as it goes through the coil producing magnetic fields that repeatedly change from north pole energy to south pole energy (and vice versa). Approximately, 10 magnetic pulse output (five each from north and south poles) is all that is significant in strength because each pulse becomes weaker than the one before due to energy dissipation in the wire, coil, and capacitor. The best range of initial magnetic field strength is 5–50 T, but anywhere between 2 and 100 will work [35]. Generally, higher electrical conductivity of the infected matter requires less magnetism strength to inactivate the microbes. Foods with minimal electrical conductivity need to be exposed to 10–100 oscillation sequences for complete sterilization. It is believed that some microbes are killed, while the majority are just devitalized so that they cannot reproduce [35].

#### 35.4.4 Biological System

Researchers (Henry Lai and group) [36] at the University of Washington have discovered a method of treating malaria with magnetic fields that could prove revolutionary in controlling the disease the World

Health Organization calls one of the world's most complex and serious human health concerns. Researchers claim the malaria parasite *Plasmodium* appears to lose vigor and can die during exposure to OMFs, which may cause tiny iron-containing particles inside the parasite to move in ways that damage the organism. The OMF may affect the parasites in two ways. In organisms still in the process of binding free heme molecules into stacks, the alternating field likely "shakes" the stacked heme molecules, preventing further stacking. That would allow harmful heme free reign within the parasite. If the parasite is further along in its life cycle and has already bound the heme into stacks, the oscillating field could cause the stacks to spin, causing damage and death of the parasite.

#### **35.4.5 Isolation and Separation of Protein by Magnetic Technique**

Isolation and separation of specific molecules is common practice in almost all areas of biosciences and biotechnology. Various techniques have been used to achieve this goal. Recently, increased attention has been paid to the development and application of magnetic separation techniques, which employ small magnetic particles. Safarik and Safarikova [37] recently reviewed magnetic techniques for the isolation and purification of proteins and peptides.

The basic principle of batch magnetic separation is simple. Magnetic carriers bearing an immobilized affinity or hydrophobic ligand or ion-exchange groups, or magnetic biopolymer particles having affinity to the isolated structure, are mixed with a sample-containing target. Magnetic separation techniques have several advantages over standard separation techniques. This process requires only a few handling steps. The separation can be carried out directly in crude samples containing suspended solid material. Owing to the magnetic properties of magnetic adsorbents (and diamagnetism of most of the contaminating molecules and particles), they can be relatively easily and selectively removed from the sample. In fact, magnetic separation is the only feasible method for recovery of small magnetic particles (diameter of 0.1–1  $\mu\text{m}$ ) in the presence of biological debris and other fouling material of similar size. In addition, the power and efficiency of magnetic separation procedures is useful in large-scale operations. Several automated systems for the separation of proteins or nucleic acids have become available recently.

Magnetic separation is usually a very mild operation to the target proteins or peptides. Even large protein complexes may remain intact when using the very gentle magnetic separation procedure [38]. The separation process has been significantly influenced by both the reduced shearing forces and the higher protein concentration throughout the isolation process. Appropriate magnetic particles can be used for their concentration instead of ultrafiltration, precipitation, etc. [39].

---

### **35.5 Other Magnetic Properties' Applications in Food Quality Systems**

#### **35.5.1 Magnetic Resonance Imaging**

In the end, it could be useful for the readers to know the applications of MRI technology (magnetic resonance used), which is growing very fast and could be used for food quality control purposes in the future. MRI is an imaging technique used basically in health care technology to produce high-quality images of the inside of the human body. MRI is based on the principles of NMR, a spectroscopic technique used by scientists to obtain microscopic chemical and physical information about molecules. However, the tremendous potential of magnetic resonance systems in other fields has not been fully explored yet. The technique was called MRI rather than nuclear magnetic resonance imaging (NMRI) to avoid negative connotations associated with the word nuclear in the late 1970s [40].

#### **35.5.2 Application of Magnetic Fields in Quality Control of Food Products**

1. MRI is an attractive tool for temperature mapping (distributions) induced in water-based foods by microwave and conductive heating. Also, it can measure quantitatively in three dimensions all aspects of the mass transport of water and fat in foods to give direct information about the effects of process engineering, including flow, mixing, and heating.

2. MRI has been proven efficient as an in-line sensor for detecting defects and measuring the quality of fruits and vegetables.
3. MRI can predict the structure and dynamics of foods and other heterogeneous materials during and after processing.
4. MRI has been used efficiently as a viscometer; MRI measurements of the fluid velocity profile in tube flow are coupled with a pressure drop measurement to yield shear viscosity. Each measurement yields a range of shear viscosity data for a single flow rate, as compared to most conventional viscometers that produce only one data point under the same circumstances. This technique has the potential to significantly enhance process control of industrial processes.

---

### 35.6 Conclusion and Future Research Needs

There is a growing consumers' need for minimally processed foods, and therefore food processing sectors are keenly looking for newer development involving mild processing technologies. The use of magnetic fields as an alternative food processing technology has not gained full commercial acceptance possibly due to inconsistent results on microbial growth and death kinetics. In addition, there is a significant lack of information on the field and the development of machineries. The first food scientists need to be confirmed that magnetic field could effectively deactivate microorganisms. Application of magnetic fields could be effective and beneficial for biomass production at controlled growth rate using superconducting technology. This would help the growth of fermentation and pharmaceutical industries. The structural modifications of proteins and fats could be achieved by exposing these constituents in magnetic fields. However, there is significant lack of research on these areas, and it is hoped that future development will provide answers to nagging questions.

---

### References

1. Martens, B. and Knorr, D. Developments of nonthermal processes for food preservation. *Food Technol.* 46(5), 124, 126–133, 1992.
2. Wouters, P. C. and Smelt, J. P. P. M. Inactivation of microorganisms with pulsed electric fields: Potential for food preservation. *Food Biotechnol.* 11, 193–229, 1997.
3. Knorr, D. Novel approaches in food processing technology: New technologies for preserving foods and modifying function. *Curr. Opin. Biotechnol.* 10, 485–491, 1999.
4. Martin, F. S., Harte, F., Barbosa-Cánovas, G. V., and Swanson, B. G. Magnetic field applications to foods. *Encyclopedia of Agricultural, Food and Biological Engineering*, Marcel Dekker, New York, pp. 580–584, 2003.
5. Pothakamury, U. R., Barbosa-Cánovas, G. V., and Swanson, B. G. Magnetic-field inactivation of microorganisms and generation of biological changes. *Food Technol.* 47(12), 85–93, 1993.
6. Barbosa-Cánovas, G. V., San Martin, M. F., Harte, F., and Swanson, B. G. Magnetic fields as a potential nonthermal technology for the inactivation of microorganisms. In: *Control of Foodborne Microorganisms*, Juneja, V. K. and Sofos, J. N., Eds., Marcel Dekker, New York, pp. 399–418, 2001.
7. Gersdorf, R., deBoer, F. R., Wolfrat, J. C., Muller, F. A., and Roeland, L. W. The high magnetic facility of the University of Amsterdam, high field magnetism. *Proceedings of the International Symposium on High Field Magnetism*, Osaka, Japan, pp. 277–287, 1983.
8. Date, M. High field magnetism. *Proceedings of the International Symposium on High Field Magnetism*, Osaka, Japan, Sept. 13–14, North-Holland, Amsterdam, 1983.
9. Hofmann, G. A. Deactivation of Microorganisms by an Oscillating Magnetic Field. US Patent 4,524,079, June 18, 1985.
10. Miura, N., Goto, T., Nakao, K., Takeyama, S., Sakakibara, T., and Herlach, F. Megagauss magnetic fields—Generation and application to magnetism. *J. Magn. Magn. Mater.* 54–57, 1409–1414, 1986.
11. <http://www.magnet.fsu.edu/spotlights/900MHzcomm/>
12. Yoshimura, N. Application of magnetic action for sterilization of food. *Shokukin Kihatsu* 24(3), 46–48, 1989.
13. Vaughan, T. E. and Weaver, J. C. Molecular change due to biomagnetic stimulation and transient magnetic fields: Mechanical interference constrains on possible effects by cell membrane pore creation via magnetic particles. *Bioelectrochem. Bioenerg.* 46, 121–128, 1998.



14. Kimball, G. C. The growth of yeast in a magnetic field. *J. Bacteriol.* 35, 109–122, 1938.
15. Genkov, D., Cvetkova, A., and Atmadzov, P. The effect of the constant magnetic field upon the growth and development of *T. vaginalis*. *Folia Med.* 16, 95–99, 1974.
16. Moore, R. L. Biological effects of magnetic fields: Studies with microorganisms. *Can. J. Microbiol.* 25, 1145–1151, 1979.
17. Takahashi, F. and Kamezaki, T. Effect of magnetism of growth of *Chlorella*. *Hakkokogaku* 63, 71–74, 1985.
18. Yamaoka, Y., Takimura, O., Fuse, H., and Kamimura, K. Effect of magnetism on growth of *Dunaliella salina*. *Res. Photosynth.* 3, 87–90, 1992.
19. Singh, S. S., Tiwari, S. P., Abraham, J., Rai, S., and Rai, A. K. Magnetobiological effects on a cyanobacterium, *Anabena doliolum*. *Electro. Magnetobiol.* 13, 227–235, 1994.
20. Tsuchiya, K., Nakamura, K., Okuno, K., Ano, T., and Shoda, M. Effect of homogeneous and inhomogeneous high magnetic fields on the growth of *Escherichia coli*. *J. Ferment. Bioeng.* 81, 343–346, 1996.
21. Piatti, E., Albertini, M. C., Baffone, W., Fraternali, D., Citterio, B., Piacentini, M. P., Dacha, M., Vetrano, F., and Accorsi, A. Antibacterial effect of a magnetic field on *Serratia marcescens* and related virulence to *Hordeum vulgare* and *Rubus fruticosus* callus cells. *Comp. Biochem. Physiol. B. Biochem. Mol. Biol.* 132, 359–365, 2002.
22. Horiuchi, S., Ishizaki, Y., Okuno, K., Ano, T., and Shoda, M. Drastic high magnetic field effect on suppression of *Escherichia coli* death. *Bioelectrochemistry* 53(2), 149–153, 2001.
23. Fojt, L., Strasak, L., Vetterla, V., and Jan Smarda, J. Comparison of the low-frequency magnetic field effects on bacteria *Escherichia coli*, *Leclercia adecarboxylata* and *Staphylococcus aureus*. *Bioelectrochemistry* 63, 337–341, 2004.
24. Harte, F., San Martin, M. F., Lacerda, A. H., Lelieveld, H., Barbosa-Cánovas, G. V., and Swanson, B. G. Effect of a high-intensity magnetic field on *Escherichia coli*, *IFT Annual Meeting*, 2000 ([http://ift.confex.com/ift/2000/techprogram/paper\\_4579.htm](http://ift.confex.com/ift/2000/techprogram/paper_4579.htm)).
25. Sakurai, H., Okuno, K., Kubo, A., Nakamura, K., and Shoda, M. Effect of a 7 Tesla magnetic fields on mammalian cells. *Bioelectrochem. Bioenerg.* 49, 57–63, 1999.
26. Coughlan, A. and Hall, N. How magnetic field can influence your ions? *New Scientist* 8(4), 30, 1990.
27. Mehedintu, M. and Berg, H. Proliferation response of yeast *Saccharomyces cerevisiae* on electromagnetic field parameters. *Bioelectrochem. Bioenerg.* 43, 67–70, 1997.
28. Ruiz-Gómez, M. J., Prieto-Barciab, M. I., Ristori-Bogajoc, E., and Martínez-Morilloa, M. Static and 50 Hz magnetic fields of 0.35 and 2.45 mT have no effect on the growth of *Saccharomyces cerevisiae*. *Bioelectrochemistry* 64, 151–155, 2004.
29. Torbet, J., Freyssinet, J. M., and Hudry-Clergeon, G. Oriented fibrin gels formed by polymerization in strong magnetic fields. *Nature* 289, 91–93, 1981.
30. Ikezoe, Y., Hirota, N., Nakagawa, J., and Kitazawa, K. Making water levitate. *Nature* 393, 749–750, 1998.
31. Sugawara, H., Hirota, N., Homma, T., Ohta, M., Kitazawa, K., Yokoi, H., Kakudate, Y., Fujiwara, S., Kawamura, M., Ueno, S., and Iwasaka, M. Magnetic field effect on interface profile between immiscible nonmagnetic liquids—enhanced Moses effect. *J. Appl. Phys.* 79, 4721–4723, 1996.
32. Ueno, S., Iwasaka, M., and Kitajima, T. Redistribution of dissolved oxygen concentration under magnetic fields up to 8 T. *J. Appl. Phys.* 33, 7174–7176, 1994.
33. Hirota, N., Homma, T., Sugawara, H., Kitazawa, K., Iwasaka, M., Ueno, S., Yokoi, H., Kakudate, Y., Fujiwara, S., and Kawamura, M. Rise and fall of surface level water solutions under high magnetic field. *J. Appl. Phys.* 34, L991–L993, 1995.
34. Iwasaka, M., Ikehatab, M., Miyakoshic, J., and Uenoa S. Strong static magnetic field effects on yeast proliferation and distribution. *Bioelectrochemistry* 65, 59–68, 2004.
35. Malignancy treatment. US Patent #4,665,8984, 1984.
36. <http://www.uwnews.org/article.asp?articleID=3302>
37. Safarik, I. and Safarikova, M. Magnetic techniques for the isolation and purification of proteins and peptides. *Biomagn. Res. Technol.* 2(7), 1–17, 2004.
38. Hofmann, I., Schnolzer, M., Kaufmann, I., and Franke, W. W. Symplekin, a constitutive protein of karyo- and cytoplasmic particles involved in mRNA biogenesis in *Xenopus laevis* oocytes. *Mol. Biol. Cell* 13, 1665–1676, 2002.
39. Alche, J. D. and Dickinson, K. Affinity chromatographic purification of antibodies to a biotinylated fusion protein expressed in *Escherichia coli*. *Protein Expr. Purif.* 12, 138–143, 1998.
40. Hornak, J. P. Basics of MRI, 2004. <http://www.cis.rit.edu/htbooks/mri/inside.htm>

# 36

## *Combined Methods for Food Preservation*

Lothar Leistner

### CONTENTS

36.1	Introduction .....	867
36.2	Principles of Combined Preservation Methods.....	868
36.2.1	Hurdle Effect .....	868
36.2.2	Hurdle Technology.....	870
36.2.3	Total Quality .....	870
36.2.4	Potential Hurdles .....	871
36.3	Basic Aspects.....	872
36.3.1	Homeostasis .....	872
36.3.2	Metabolic Exhaustion .....	872
36.3.3	Stress Reactions .....	873
36.3.3.1	Multitarget Preservation .....	874
36.4	Application of Hurdle Technology .....	874
36.4.1	General Aspects .....	874
36.4.1.1	Intermediate-Moisture Foods .....	874
36.4.1.2	High-Moisture Foods .....	876
36.4.1.3	Integer Foods.....	877
36.4.2	Applications in Industrialized Countries .....	878
36.4.2.1	Fermented Foods.....	878
36.4.2.2	Heated Foods.....	880
36.4.2.3	Chilled Foods .....	882
36.4.2.4	Healthful Foods.....	882
36.4.2.5	Packaging of Foods.....	883
36.4.3	Applications in Developing Countries.....	884
36.4.3.1	Fruits of Latin America.....	884
36.4.3.2	Meats of China .....	886
36.4.3.3	Dairy Products of India.....	887
36.5	Design of Hurdle Technology Foods .....	888
36.6	Conclusions .....	890
	References .....	890

### 36.1 Introduction

The microbial stability and safety of most traditional and novel foods is based on a combination of several preservative factors (called hurdles), which the microorganisms present in the food are unable to overcome. This is illustrated by the so-called hurdle effect, first introduced by Leistner [1]. The hurdle effect is of fundamental importance for the preservation of foods, since the hurdles in a stable product control microbial spoilage, food poisoning as well as desired fermentation processes [1,2]. Leistner and coworkers acknowledged that the hurdle concept illustrates only the well-known fact that complex interactions of temperature, water activity, pH, and redox potential are significant for the microbial stability

of foods. From an understanding of the hurdle effect, the hurdle technology [3] has been derived, which allows improvements in the safety and quality of foods, by deliberate and intelligent combinations of hurdles. Over the years, the insight into the hurdle effect has broadened and the application of hurdle technology extended. In industrialized countries, the hurdle technology is currently of particular interest for minimally processed foods, whereas in developing countries hurdle technology is at present of paramount importance since it stabilizes foods stored without refrigeration. The application of deliberate and intelligent hurdle technology is advancing now rapidly worldwide. This concept is synonymously called food preservation by combined methods, combined processes, combination preservation, or combination techniques. Different languages have coined special expressions for this concept, which is called Hürden-Technologie in German, hurdle technology in English, Technologie des Barrières in French, Tecnologia degli Ostacoli in Italian, Tecnologia de Obstaculos in Spanish, and Zanglangishu in Chinese. Recently, the term hurdle technology has been most often used.

In Europe, a three-year research project "Food Preservation by Combined Processes," supported by the European Commission, to which scientists of 11 European countries have contributed, fostered the application of hurdle technology [4,5]. The hurdle technology concept has proven successful since an intelligent combination of hurdles secures microbial stability and safety as well as the sensory quality of foods [6–8], provides convenience and freshness of foods to the consumers, and might be cost efficient for the producers since it demands less energy during production and storage.

---

## 36.2 Principles of Combined Preservation Methods

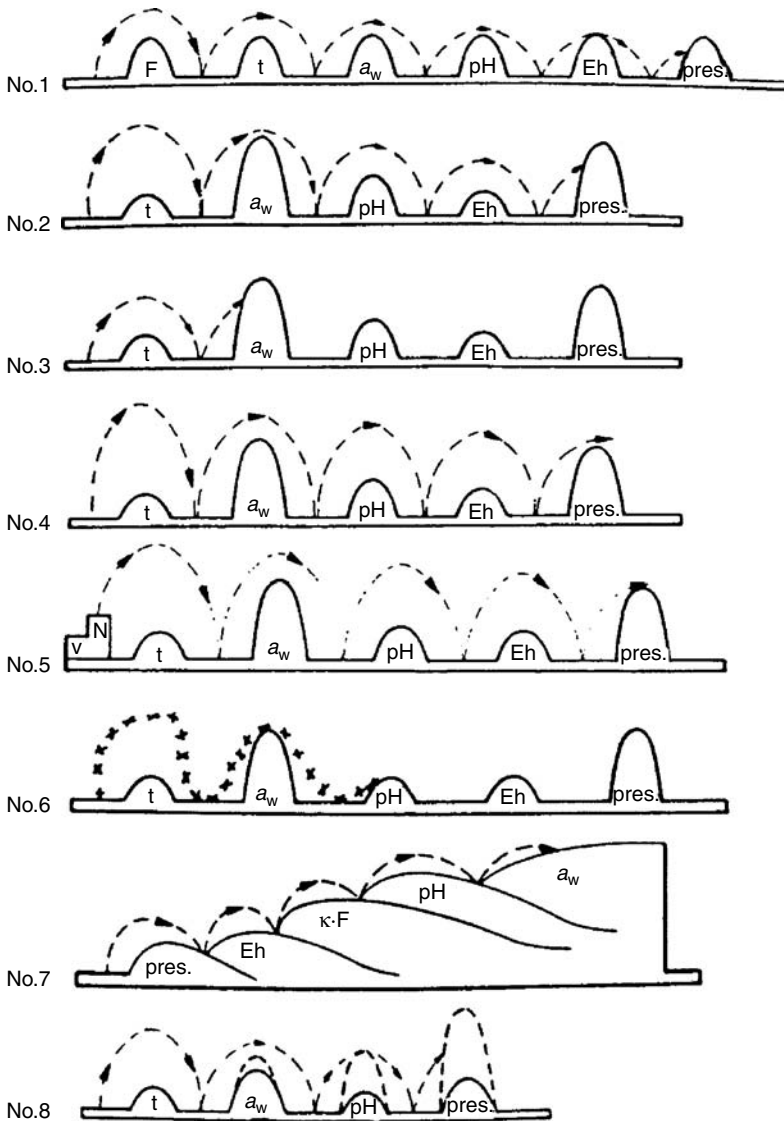
There are many preservation methods used for making foods stable and safe, e.g., heating, chilling, freezing, freeze drying, drying, curing, salting, sugar addition, acidification, fermentation, smoking, and oxygen removal. However, these processes are based on relatively few parameters or hurdles, i.e., high temperature ( $F$  value), low temperature ( $t$  value), water activity ( $a_w$ ), acidification (pH), redox potential (Eh), preservatives, and competitive flora. In some of the preservation methods mentioned, these parameters are of major importance, while in others they are only secondary hurdles [2,6].

The critical values of these parameters for the death, survival, or growth of microorganisms occurring in foods have been determined in recent decades and are now the basis of food preservation. However, it must be kept in mind that the critical value of a particular parameter changes if other preservative factors are present in the food. For instance, the heat resistance of bacteria increases at low  $a_w$  and decreases in the presence of some preservatives, or a low Eh increases the inhibition of microorganisms caused by a reduced  $a_w$ . The simultaneous effect of different preservative factors could be additive or even synergistic. Furthermore, as mentioned before, the microbial stability and safety of many foods is based on the combined effects of hurdles. For instance, mildly heated canned foods ("half-preserved" or "three-quarter-preserved") need refrigeration during storage, or fermented sausages are only stable and safe if both the  $a_w$  and the pH are in an appropriate range. Therefore, in food preservation the combined effect of preservative factors must be taken into account, which is illustrated by the so-called hurdle effect.

### 36.2.1 Hurdle Effect

For each stable and safe food, a certain set of hurdles is inherent, which differs in quality and intensity depending on the particular product; however, in any case, the hurdles must keep the "normal" population of microorganisms in the food under control. The microorganisms present ("at the start") in a food should not be able to overcome ("leap over") the hurdles present; otherwise the food will spoil or even cause food poisoning. In previous publications [6,7], some examples were given to illustrate the hurdle effect. Since these examples are quite helpful for an understanding of the hurdle effect, as well as for the applications of combined methods in food preservation, they are briefly repeated here.

Figure 36.1 gives eight examples of the hurdle effect. Example 1 represents a food, which contains six hurdles, and these are high temperature during processing ( $F$  value), low temperature during storage ( $t$  value), water activity ( $a_w$ ), acidity (pH), redox potential (Eh), and preservatives (pres.). The microorganisms present cannot overcome these hurdles, and thus the food is microbiologically stable and safe. However, example 1 is only a theoretical case, because all hurdles are of the same height, i.e., have the



**FIGURE 36.1** Illustration of the hurdle effect using eight examples. Symbols have the following meaning: F, heating; t, chilling;  $a_w$ , water activity; pH, acidification; Eh, redox potential; pres., preservatives; K-F, competitive flora; V, vitamins; N, nutrients. (From L. Leistner, *Food Res. Int.* 25: 151, 1992; L. Leistner, *Food Design by Hurdle Technology and HACCP*, Adalbert-Raps-Foundation, Kulmbach, 1994, p. 62.)

same intensity, and this rarely occurs. A more likely situation is presented in example 2, since the microbial stability of this product is based on hurdles of different intensity. In this particular product the main hurdles are  $a_w$  and preservatives, whereas other less important hurdles are storage temperature, pH, and redox potential. These five hurdles are sufficient to inhibit the usual types and numbers of microorganisms associated with such a product. If there are only a few microorganisms present at the start (example 3), then a few or only low hurdles are sufficient for the microbial stability of the product. The ultra-clean or aseptic processing of perishable foods is based on this principle. The same proves true if the initial microbial load of a food (e.g., high-moisture fruits or carcass meat) is substantially reduced (e.g., by application of steam), because after such a reduction fewer microorganisms are present at the start, which are easier to inhibit. On the other hand, as in example 4, if due to bad hygienic conditions too many undesirable microorganisms are present initially, even the usual inherent hurdles in a product may be unable to prevent

spoilage or food poisoning. Example 5 is a food rich in nutrients and vitamins, which foster the growth of microorganisms (this is called the “booster” or “trampoline effect”), and thus the hurdles in such a product must be enhanced, otherwise they will be overcome. Example 6 illustrates the behavior of sublethally damaged microorganisms in food. If, for instance, bacterial spores in meat products are damaged sublethally by heat (as occurs in F-SSP, discussed in Section 36.4.2.2), then the vegetative cells derived from such spores lack “vitality,” and therefore are inhibited by fewer or lower hurdles. In some foods, the stability is achieved during processing by a sequence of hurdles, which are important in different stages of the ripening process and lead to a stable final product. Example 7 illustrates the sequence of hurdles in fermented sausages, as will be discussed in Section 36.4.2.1. Finally, example 8 illustrates the possible synergistic effect of hurdles, which probably relates to a multitarget disturbance of the homeostasis of microorganisms in foods (discussed in Section 36.3.4).

### 36.2.2 Hurdle Technology

A better understanding of the occurrence and interaction of different preservative factors (hurdles) in foods is the basis for improvements in food preservation. If the hurdles in a food are known, the microbial stability and safety of this food might be optimized by changing the intensity or quality of these hurdles. Therefore, from an understanding of the hurdle effect, the hurdle technology has been derived [3], which means that hurdles are deliberately combined in the preservation of traditional and novel foods. By an intelligent mix of hurdles, it is possible to improve not only the microbial stability and safety but also the sensory and nutritive quality as well as the economic properties of a food. For the economic properties of a food, e.g., it is important to know how much water in the product is compatible with its microbial stability, and if an increased  $a_w$  is compensated by other hurdles (pH and Eh.) this food becomes more economical. Even the pet food industry employs this principle now. A stable pet food was formerly produced with an  $a_w$  of 0.85, and this needed addition of excessive amounts of propylene glycol that might have caused health implications in cats. But now, due to the application of hurdle technology, pet foods are microbiologically stable at ambient temperatures with an  $a_w$  of 0.94, and they are more healthy, tasty, and economic [6]. Hurdle technology is increasingly used for food design in industrialized and developing countries for optimizing traditional foods and for making new products according to needs. For instance, if energy preservation is the goal, then energy-consuming hurdles such as refrigeration are replaced by other hurdles ( $a_w$ , pH, or Eh), which do not demand energy and still ensure a stable and safe food [1]. Furthermore, if we want to reduce or replace preservatives, such as nitrite in meats, we could emphasize other hurdles in the food, e.g.,  $a_w$ , pH, refrigeration, or competitive flora, which would stabilize the product [9]. More recent examples related to the application of hurdle technology will be given in subsequent sections of this review article.

### 36.2.3 Total Quality

Stanley proposed that the hurdle technology approach might be applicable to a wider concept of food preservation than just microbial stability, but for it to work, a precise knowledge of the effectiveness of each hurdle for a given commodity is required. Furthermore, he suggested distinguishing between positive and negative hurdles for the quality of foods [10]. Hurdle technology is applicable not only to safety, but also to quality aspects of foods, although this area of knowledge has been explored much less than the safety aspect. McKenna emphasized that while hurdle technology is appropriate for securing the microbial stability and safety of foods, the total quality of foods is a much broader field and encompasses a wide range of physical, biological, and chemical attributes. The concept of combined processes should work toward the total quality of foods rather than the narrow but important aspects of microbial stability and safety. However, at present the tools for applying hurdle technology to total food quality are still not adequate, and this is equally true for predicting food quality by modeling. However, researchers should appreciate the wider power of the hurdle technology concept, and food industry should use the available tools of combined processes for as many quality enhancements as is possible [11].

Some hurdles, e.g., Maillard reaction products, influence the safety as well as the quality of foods, because they have antimicrobial properties and at the same time improve the flavor of the products; and

this applies to nitrite used in the curing of meat also. The possible hurdles in foods might influence the stability and safety, as well as the sensory, nutritive, technological, and economic properties of a product, and the hurdles present might be negative or positive for securing the desired total quality of a food. Moreover, the same hurdle could have a positive or a negative effect on foods, depending on its intensity. For instance, chilling to an unsuitably low temperature will be detrimental to fruit quality (“chilling injury”), whereas moderate chilling is beneficial. Another example is the pH of fermented sausages, which should be low enough to inhibit pathogenic bacteria, but not so low as to impair taste. If the intensity of a particular hurdle in a food is too small it should be strengthened; on the other hand, if it is detrimental to the total food quality it should be lowered. By this adjustment, the hurdles in foods should be kept in the optimal range, considering safety as well as quality [7,12].

### 36.2.4 Potential Hurdles

For the advanced application of hurdle technology a continual increasing number of preservative factors (hurdles) have become available (Table 36.1). The most important hurdles commonly used for the preservation of foods, either applied as “process” or “additive” hurdles, are temperature (high or low), decreased water activity ( $a_w$ ), acidity (pH), low redox potential (Eh), preservatives (e.g., nitrite, sorbate, and sulfite), and competitive microorganisms (e.g., lactic acid bacteria). In addition, more than 50 hurdles of potential use in foods of animal or plant origin, which improve the stability and the quality of these products, have hitherto been identified and described [12,13], and the list of possible hurdles for food preservation is by no means complete. At present especially physical, nonthermal processes (high hydrostatic pressure, mano-thermo-sonication, oscillating magnetic fields, pulsed electric fields, and light pulses) receive considerable attention, since in combination with conventional hurdles they are of potential use for the microbial stabilization of fresh-like food products with little induced degradation of sensory and nutritional properties. With these physical, nonthermal processes often not a

**TABLE 36.1**

Partial List of Potential Hurdles for Foods of Animal or Plant Origin, Which Improve the Stability and the Quality of These Products

---

Temperature (low or high)
pH (low or high)
$a_w$ (low or high)
Eh (low or high)
Modified atmosphere (nitrogen, carbon dioxide, and oxygen)
Packaging (aseptic packaging, vacuum or modified atmosphere or active packaging, and edible coatings)
Pressure (high)
Radiation (microwaves, UV, and irradiation)
Other physical processes (mano-thermo-sonication, high electric field pulses, oscillating magnetic field pulses, radio frequency energy, and photodynamic inactivation)
Microstructure (emulsions, fermented sausage, and ripened cheese)
Competitive flora (lactic acid bacteria)
Preservatives (organic acids, lactate, acetate, sorbate, ascorbate, glucono-delta-lactone, phosphates, propylene glycol, diphenyl, parabens, free fatty acids and their esters, phenols, monolaurin, chelators, Maillard reaction products, ethanol, spices and their extracts, nitrite, nitrate, sulfite, carbon dioxide, oxygen, ozone, chlorine, smoke, antioxidants, pimaricin and other antibiotics, lysozyme, chitosan, lactoperoxidase, nisin and other bacteriocins, pectine hydrolysate, protamine, and hop extracts)

---

Source: After L. Leistner, *J. Food Eng.* 22: 421 (1994); L. Bøgh-Sørensen, in *Food Preservation by Combined Processes*, FLAIR Final Report, EUR 15776 EN, European Commission, Brussels, 1994, p. 7.

sterile product but only a reduction of the microbial load is intended, and the growth of the remaining microorganisms is inhibited by additional, conventional hurdles. Another group of hurdles that is of special interest in industrialized as well as in developing countries are “natural preservatives” (spice extracts, lysozyme, chitosan, pectin hydrolysate, protamine, paprika glycoprotein, and hop extracts). Moreover, the microstructure of some foods (e.g., emulsions, fermented sausages, and ripened cheese), which might be a considerable hurdle in relation to microbial growth, is under study and will be discussed in Section 36.4.2.1 of this review. However, not all the potential hurdles for food preservation will be commonly applied, and certainly not all of them to the same food product.

---

### 36.3 Basic Aspects

Food preservation implies putting microorganisms in a hostile environment to inhibit their growth, shorten their survival, or cause their death. The feasible responses of the microorganisms to such a hostile environment determine whether they may grow or die. More basic research is needed related to these responses, because a better understanding of the physiological basis for the growth, survival, and death of microorganisms in food products might open new dimensions for food preservation [7]. Furthermore, such an understanding would be the scientific basis for an efficient application of hurdle technology in the preservation of foods. Recent advances in these respects have been made by considering the homeostasis, metabolic exhaustion, and stress reactions of microorganisms, as well as by introducing the concept of multitarget preservation for a gentle but effective preservation of foods [8,14].

#### 36.3.1 Homeostasis

A key phenomenon that deserves more attention in food preservation is the interference by the food with the homeostasis of microorganisms [15]. Homeostasis is the tendency toward uniformity or stability in the normal status (internal environment) of organisms. For instance, the maintenance of a defined pH within narrow limits is a feature and prerequisite of living organisms [16], and this applies to higher organisms as well as to microorganisms. Much is already known about the homeostasis in higher organisms at the molecular, subcellular, cellular, and systematic levels in the field of molecular biology, biochemistry, physiology, pharmacology, and medicine [16]. This knowledge should now be transferred to microorganisms important in the poisoning and spoilage of foods. If the homeostasis of microorganisms, i.e., their internal equilibrium, is disturbed by preservative factors (hurdles) in foods, they will not multiply, i.e., remain in the lag phase or even die, before their homeostasis is reestablished (“repaired”). Thus, food preservation is achieved by disturbing the homeostasis of microorganisms in a food temporarily or permanently [7].

Gould [15] has pointed out that during evolution a wide range of more or less rapidly acting mechanisms (e.g., osmoregulation to counterbalance a hostile water activity in food) have developed in microorganisms that act to keep important physiological systems operating, in balance and unperturbed even when the environment around them is greatly perturbed [17]. In most foods, the microorganisms are operating homeostatically to react to environmental stresses imposed by the preservation procedures applied, and the most useful procedures employed to preserve foods are effective in overcoming the various homeostatic mechanisms the microorganisms have evolved [17]. The repair of a disturbed homeostasis demands much energy, and thus the restriction of energy supply inhibits repair mechanisms of the microbial cells and leads to a synergistic effect of preservative factors (hurdles). Energy restrictions for microorganisms are caused by anaerobic conditions, such as “vacuum” or “modified-atmosphere” packaging of foods. Therefore, a low  $a_w$  (and a low pH) and low redox potential of foods act synergistically [17]. The interference with homeostasis of microorganisms or entire microbial populations forms an attractive and logical focus for improvements in food preservation techniques [17].

#### 36.3.2 Metabolic Exhaustion

Another phenomenon of definite practical importance is the metabolic exhaustion of microorganisms, which could lead to an “autosterilization” of foods. This was first observed by us, and initially not

believed, many years ago [18] in mildly heated (95°C core temperature) liver sausage adjusted to different water activities by the addition of salt and fat, and the product inoculated with *Clostridium sporogenes* PA 3679 and stored at 37°C. Clostridial spores that survived the heat treatment vanished in the product during storage, if the products were stable. Later, this behavior of *Clostridium* and *Bacillus* spores was regularly observed during storage of shelf-stable meat products (SSP), especially F-SSP [19], which will be discussed in Section 36.4.2.2 The most likely explanation is that bacterial spores, which survive the heat treatment, are able to germinate in these foods under less favorable conditions than those under which vegetative bacteria are able to multiply [6]. Therefore, during storage of these products some viable spores germinate, but the germinated spores or vegetative cells derived from these spores die. Thus, the spore counts in stable hurdle technology foods actually decrease during storage, especially in unrefrigerated foods. In addition, during studies in our laboratory with Chinese dried meat products, we observed the same behavior of microorganisms [20]. If these meats were contaminated after processing with staphylococci, salmonellae, or yeasts, the counts of these microorganisms on stable products decreased quite fast during unrefrigerated storage, especially on meats with a water activity close to the threshold for microbial growth. Again the same phenomenon was observed by Latin American researchers [21–24] in their studies with high moisture fruit products (HMFP), as will be discussed in Section 36.4.3.1. The counts of a variety of bacteria, yeasts, and molds that survived the mild heat treatment decreased quite fast in the products during unrefrigerated storage, because the hurdles applied (pH,  $a_w$ , sorbate, and sulfite) did not allow growth.

A general explanation for this behavior might be that vegetative microorganisms, which cannot grow, will die and they die more quickly if the stability is close to the threshold for growth, storage temperature is elevated, antimicrobial substances are present, and the organisms are sublethally injured (e.g., by heat) [7]. Apparently, microorganisms in stable hurdle technology foods strain every possible repair mechanism for their homeostasis to overcome the hostile environment. By doing this they completely use up their energy and die, if they become metabolically exhausted. This eventually leads to an autosterilization of such foods [14]. Thus, owing to autosterilization the hurdle technology foods, which are microbiologically stable, become even safer during storage, especially at ambient temperatures. So, for example, salmonellae that survive the ripening process in fermented sausages will vanish more quickly if the products are stored at ambient temperature. However, on refrigeration they will survive longer and might cause food poisoning [7]. It is also well known that salmonellae survive in mayonnaise at chill temperatures much better than at ambient temperature. Unilever laboratories in Vlaardingen have confirmed metabolic exhaustion in *Listeria innocua* that were inoculated in water-in-oil-emulsions (resembling margarine). In these products, *Listeria* vanished faster at ambient (25°C) temperature than at chill temperature (7°C), at pH 4.25 > pH 4.3 > pH 6.0, in fine emulsions > in coarse emulsions, and under anaerobic conditions > than aerobic conditions. From these experiments, it was concluded that metabolic exhaustion is accelerated if more hurdles are present, and this might be caused by increasing energy demands to maintain internal homeostasis under stress conditions (P.F. ter Steeg, 1995; personal communication).

### 36.3.3 Stress Reactions

A limitation to the success of hurdle technology foods could be stress reactions of microorganisms. As some bacteria become more resistant (e.g., toward heat) or even more virulent under stress, they generate stress shock proteins. The synthesis of protective stress shock proteins is induced by heat, pH,  $a_w$ , ethanol as well as by starvation. These responses of microorganisms under stress might hamper food preservation and could become problematic for the application of hurdle technology. On the other hand, the switch-on of genes for the synthesis of stress shock proteins, which helps organisms to cope with stress situations, could become more difficult if different stresses are received at the same time. To counter different stresses simultaneously, several or more protective stress shock proteins will have to be synthesized which is energy consuming. The microorganisms cannot this deliver since they become metabolically exhausted [8]. Therefore, a multitarget preservation of foods could be the answer to avoid synthesis of such stress shock proteins, which otherwise might jeopardize the microbial stability and safety of hurdle technology foods [14]. Nevertheless, further research in stress shock proteins and the different mechanisms that switches them on or could inactivate them seem warranted in relation to hurdle technology foods.



### 36.3.3.1 Multitarget Preservation

The multitarget preservation of foods should be the ultimate goal for a gentle but most effective preservation of foods [8]. For foods preserved by hurdle technology, it has been suspected for some time that different hurdles in a food could not just have an additive effect on microbial stability, but act synergistically [1]. Example 8 in Figure 36.1 illustrates this. A synergistic effect could become true if the hurdles in a food hit, at the same time, different targets (e.g., cell membrane, DNA, enzyme systems, pH,  $a_w$ , and Eh) within the microbial cell, and thus disturb the homeostasis of the microorganisms present in several respects. The repair of the homeostasis as well as the activation of stress shock proteins then become more difficult [7]. Therefore, employing different hurdles simultaneously in the preservation of a particular food should have advantages, because optimal microbial stability could be achieved with an intelligent mix of gentle hurdles. In practical terms, this could mean that it is more effective to use different preservatives in small amounts in a food than only one preservative in larger amounts, because different preservatives might hit different targets within the microbial cell, and thus act synergistically [12].

It is anticipated that the targets in microorganisms of different preservative factors (hurdles) in foods will be elucidated, and then the hurdles could be grouped in classes according to their targets within the microbial cells. A mild and effective preservation of foods, i.e., a synergistic effect of hurdles, is likely if the preservation measures are based on an intelligent selection and combination of hurdles taken from different “target classes” [7]. This approach seems not only valid for traditional food preservation procedures, but for modern processes (such as food irradiation, ultrahigh pressure, and manothermo-sonication) too. An example for a multitarget novel process is the application of nisin (damages the cell membrane) in combination with lysozyme and citrate, which then are able to penetrate easily into the cell and disturb the homeostasis using different targets [14].

Food microbiologists could learn in this respect from pharmacologists, because the mechanisms of action of biocides have been studied extensively in the medical field. At least 12 classes of biocides are already distinguished that often have more than one target within the microbial cell. Multiple lesions in microorganisms are known. Often the cell membrane is the primary target; it becomes leaky and unzips the organism. However, biocides also impair the synthesis of enzymes, proteins, and DNA [25]. The “multidrug attack” has proved successful in the medical field to fight bacterial infections (e.g., tuberculosis) as well as viral infections (e.g., AIDS), and thus a “multitarget attack” of microorganisms should be a promising approach in food microbiology too [14].

---

## 36.4 Application of Hurdle Technology

Foods based on combined preservation methods (hurdle technology) are prevalent in industrialized as well as in developing countries. In the past and often even today, hurdle technology is applied empirically without knowing the governing principles in the preservation of a particular food. Nevertheless, with a better understanding of these principles and improved monitoring devices, the deliberate application of hurdle technology has advanced. Subsequently, some general aspects of hurdle technology will be briefly discussed, and examples of the application of combined preservation methods in industrialized and in developing countries will be given.

### 36.4.1 General Aspects

With regard to the application of hurdle technology, one might differentiate between intermediate-moisture foods, high-moisture foods, and integer foods, since they differ somewhat in the types of hurdles used or the mode of hurdle application. Therefore, these three groups will be discussed separately.

#### 36.4.1.1 Intermediate-Moisture Foods

The intermediate-moisture foods (IMF) are in the  $a_w$  range of 0.9–0.60, and thus water activity is their primary hurdle for securing microbial stability and safety. However, IMF are often stabilized by additional hurdles such as heating, preservatives, pH, redox potential, and competitive microflora [26]. These foods are easy to prepare and storable without refrigeration, thus they are cost- and energy-efficient. Traditional

IMF based on meat, fish, fruits and vegetables are common and much liked in different parts of the world, because they are tasty, nutritious, and in general safe. On the other hand, newly developed, tailor-made IMF (except for certain candy bars) have not achieved the expected breakthrough in human nutrition. Some reasons for this disappointing performance are the poor palatability of most novel IMF due to the high concentration of humectants, and the need to introduce often high amounts of antimicrobial additives (“chemical overloading of foods”), which may cause health concerns and pose legal problems [7].

Traditional IMF are today the prevalent food items in developing countries. None of the food manufacturers in these countries has the capability to measure  $a_w$ , and few recognize the relevance and significance of water activity for the preservation of their foods. Thus, the application of hurdle technology in the processing of IMF in developing countries is done empirically. Only recently have changes occurred. An outstanding example for these recent developments is the CYTED-D program (Science and Technology for Development) of Latin America, which was sponsored by Spain and to which Argentina, Brazil, Chile, Costa Rica, Cuba, Mexico, Nicaragua, Puerto Rico, Uruguay, and Venezuela contributed. A project in this program, entitled “Development of Intermediate Moisture Foods (IMF) Important to Ibero-America,” had the objective to identify and evaluate foods of Latin America, which could be storable without refrigeration. This study comprised fruits, vegetables, and bakery products as well as foods derived from fish, milk, meat, and miscellaneous products. About 260 food items of the region were approved to be microbiologically stable and safe at ambient temperatures. The properties ( $a_w$ , pH, preservatives, and food composition.) and the production technology for these products were measured and described [27,28], and it was concluded that most of the approved products were intermediate-moisture foods. However, some had higher  $a_w$  values, sometimes as high as 0.97–0.98, and nevertheless were stable and safe without refrigeration, and it turned out that the stability of these high-moisture foods was caused by a combination of several, empirically applied hurdles. This observation was the starting point for Latin America to apply intentional hurdle technology [3] to high-moisture foods, especially to tropical and subtropical fruits, storable without refrigeration, which will be discussed in Section 36.4.3.1. In the opinion of Latin American scientists [28], the technological achievements of their region deserve a closer look, in particular by developing countries where refrigeration is scarce. Since the tailor-made IMF are often not satisfactory from the sensory point of view and contain high levels of additives, the application of hurdle technology to stabilize high-moisture foods, which also need no refrigeration, seems to have great potential [28].

The Latin American CYTED-D study demonstrated a promising approach for improving the stability of foods in developing countries, which could be applied in other regions too. Following this concept, first, the properties of already available, microbiologically stable, and safe food items should be thoroughly studied and described. Second, the preservative factors (hurdles) effective in these foods and thus the principles behind their microbial stability and safety must be elucidated. Third, if feasible, the preservation and quality of these foods should be improved by the intentional application of hurdle technology [7]. Using this concept, Tapia et al. [29] have identified the hurdles in food items studied within the CYTED-D program, and by critical evaluation of the hurdles that have been traditionally applied to certain foods, they assessed the microbial stability and safety of these products. It was demonstrated that similar hurdles are active in the same type of foods in different countries of Latin America. However, there were also surprising differences that pointed to an over- or underprocessing of the same food in different countries of the same region [29]. This insight could lead to the avoidance of some nonessential preservatives or, on the other hand, to an improved stability, safety, and quality of some food items by fortification of certain hurdles.

Latin American researchers [28,29] pointed out that reduced water activity was the main hurdle in the IMF they have described within the CYTED-D project; however, that in practically all these products, additional hurdles were present that contributed considerably to stability and safety. This observation has confirmed the opinion expressed by Leistner and Rodel [26] that in most IMF several hurdles are inherent. Tapia et al. [29] listed many traditional IMF of Latin America, derived from fruits, vegetables, meat, milk, and fish, in which several identified hurdles contributed to microbial stability and safety. Very often the reduced  $a_w$  was combined with a reduced pH. However, in some salted fish and shrimps the pH was  $> 8.0$ , and thus in these foods the elevated pH might contribute to preservation. Many meat, fish, fruit, and dairy products contained in addition preservatives (nitrite, smoke, benzoate, sorbate, sulfites, spices, and Maillard products) and sometimes competitive microorganisms. Maillard reaction products, that are

generated during caramelization of sweet condensed milk (*dulce de leche*) are probably an important hurdle for this Latin American food item. A special case concerns candied fruits common in this region. Their heavy sugar coating acts as a physical barrier (hurdle) against microbial contamination after the heat process, so that these foods are stable during storage in spite of the absence of preservatives and sometimes rather high pH. Quite often a thermal treatment is used to inactivate heat-sensitive microorganisms during the manufacturing process and improve microbial stability, and in sealed containers a vacuum is achieved by hot filling of the products. Once the container is opened, the redox potential increases and then the microbial stability of these IMF against molds and yeasts must be secured by the preservatives present. Additional hurdles were employed particularly in those IMF that had rather high  $a_w$  and pH values. In the IMF studied, it was exceptional if the  $a_w$  was apparently the only hurdle present, but in most IMF products 3–5 hurdles have been identified [29]. How many hurdles, besides  $a_w$ , are active in IMF depends on the type of the product; however, it may be concluded that the microbial stability and safety of IMF in general is based on a combination of several preservative factors.

It is obvious that a thorough study of traditional IMF using up-to-date methodology would be of benefit to developing countries. However, it is also rewarding for industrialized countries, because traditional products are an abundant source of innovative ideas that could be used in food design. For instance, we learned from traditional Chinese sausage (*la chang*) that a sausage could be preserved in the raw state even without fermentation, or we realized that in traditional charqui of Brazil fermentation takes place even at an  $a_w < 0.90$ , if halophilic pediococci are involved. Heat inactivation of most pathogenic bacteria, including staphylococci, is achieved in some Chinese IMF meats by just applying 50°C for several hours. Another interesting aspect of traditional IMF meats is the bactericidal effect of Maillard products toward food-poisoning bacteria, because even if these organisms recontaminate the product after heating and drying they do not survive long, probably due to metabolic exhaustion as mentioned in Section 36.3.2. Apparently, the growth inhibition of xerotolerant molds on unpackaged Chinese IMF meats with an  $a_w < 0.69$  is also supported by Maillard reaction products, which, therefore, are important hurdles for traditional IMF [6].

#### 36.4.1.2 High-Moisture Foods

In developing countries, IMF are prevalent, whereas in industrialized countries high-moisture foods (HMF) are common, because they are often only minimally processed and due to their fresh-like properties and convenience, they are appealing to the consumer. However, since the water activity is above 0.90 in HMF, this hurdle is less prominent and other hurdles have to secure microbial stability and safety of foods during storage. Therefore, HMF are often chilled or frozen, and low temperature storage is widely used. However, refrigeration is energy consuming and thus costly, and in case of temperature abuse the stability and safety of the foods might be jeopardized. Therefore, besides the low-temperature hurdle for HMF, additional hurdles (such as heating, pH, Eh,  $a_w$ , preservatives, and competitive flora), often applied in combination by means of hurdle technology, are significant. The hurdles are employed in HMF either empirically or now more often intentionally.

An example for empirical use of hurdles in HMF is the Italian mortadella. This meat product is an emulsion-type sausage, which is traditional and very common in Italy, and might be even stored without refrigeration as long as the sausage is uncut. Italian mortadella contains, due to a mild heat process (78°C core temperature), viable spores of bacteria. However, the growth of bacilli and clostridia is inhibited in genuine mortadella by a slightly decreased  $a_w$  (below 0.95), and this adjustment (by salt, sugar, milk powder, and drying) was done in the past without knowledge of the reasons, but by applying traditional recipes, the water activity has been surprisingly well adjusted to the desired level of  $< 0.95$ , by hand, with experience [9,19,30]. In Germany, meat products preserved by a similar principle (pasteurization and  $a_w$  adjustment to  $< 0.95$  by drying of the sausage) are also popular. These  $a_w$ -SSP are stable at ambient temperature and will be discussed in Section 36.4.2.2.

Another example of a shelf-stable emulsion-type sausage in Europe is the Gelderse rookworst, typical of the Netherlands, for which intentional hurdle technology has already been in use for a number of years. A major hurdle of this product is the reduced pH, which is adjusted to 5.4–5.6 by the addition of 0.5% glucono- $\delta$ -lactone, and thus rookworst belongs to the group of pH-SSP. This sausage is stable for several weeks at ambient temperature, if vacuum packaged and reheated at 80°C for about 1 h in the pouch. The heat treatment eliminates vegetative organisms, and bacterial spores are apparently not of

much concern, as their numbers decrease during the heat process and surviving spores are inhibited by the pH and other hurdles present (e.g., nitrite). Gelderse rookworst is exported from the Netherlands in large quantities to Britain, and with pH > 5.4 is acceptable from the sensory point of view. The binding of water and fat in rookworst is not a problem, in spite of the relatively low pH, if pork rinds and phosphates are added to the product [3,19]. More examples of the application of intentional hurdle technology to HMF of industrialized countries will be presented in Sections 36.4.2.1 through Section 36.4.2.5.

As mentioned before, in developing countries IMF are prevalent. However, there is also a trend in developing countries to move gradually away from IMF toward HMF [31]. Since IMF contain high amounts of humectants (such as sugar and salt) as well as much fungistatic preservatives (such as sorbate, benzoate, and sulfite), which are undesirable from the sensory or nutritional point of view, and in addition they have a less appealing texture and appearance than HMF, efforts are being made to improve the quality of IMF by decreasing the sugar and salt addition, as well as by increasing the moisture content and  $a_w$ , without sacrificing the microbial stability and safety of the products if stored without refrigeration [19]. It might be expected that high-moisture, fresh-like foods, which nevertheless are storable at ambient temperature, since they have been stabilized by intentional hurdle technology, will be on the increase in developing countries as soon as the application of advanced hurdle technology has been mastered [31]. Recent examples, which support this trend, are novel high-moisture fruit products of Latin America, and novel dried meat products of China, which will be discussed in Sections 36.4.3.1 and 36.4.3.2.

### 36.4.1.3 Integer Foods

Whole or integer foods are not comminuted and consist of large pieces of plant or animal tissue; nevertheless, their microbial stability and safety might be improved by application of hurdle technology. Two approaches are common: either the use of coatings that contain and maintain inhibitory substances to protect the surface of the foods against microbial deterioration or the dewatering and impregnation process, which consists of soaking foods in highly concentrated solutions of humectants or other food additions [12,19].

An example for an application of a surface coating is pastirma, a traditional beef product of Muslim countries, which is storable for several months at ambient temperatures and is eaten in the raw state [32]. The stability and safety of pastirma is based on the reduced  $a_w$  (0.90–0.85), in combination with several additional preservative factors [33,31]. The interior of this product is stabilized by dry curing of meat stripes (~5 cm thick) with salt and nitrate (which is reduced by bacteria to nitrite) and the removal of water by drying and pressing of the meat, as well as by the growth of lactic acid bacteria that decrease the pH to about 5.5. These hurdles secure the inhibition of spoilage and pathogenic bacteria, including salmonellae, within the meat. The surface of pastirma is covered with an edible paste (3–5 mm thick) containing 35% freshly ground garlic and other spices (paprika, kammon, mustard as well as fenugreek as a binder). This surface coating prevents the growth of molds on the product during storage, even at elevated humidity and temperatures. Thus, at least five hurdles ( $a_w$ , nitrite, pH, competitive flora, and garlic) are relevant to the preservation of pastirma.

Torres [34] studied the surface microbial stability of model foods by using coatings, which maintain preservatives and the desired low pH, and confirmed that a low pH in the surface layer greatly improved the effectiveness of sorbic acid in this coating. Guilbert [35] used superficial edible layers for easily perishable tropical fruits and achieved a preservation without affecting the integrity of food pieces. He pointed out that the formulation of edible films and coatings must include a component that can form an adequately cohesive and continuous matrix as well as the addition of a plasticizing agent to overcome brittleness. Specific agents (antimicrobials, antioxidants, organic acids, nutritional additives, flavors, and coloring) can be incorporated into edible films to obtain functional effects localized on the surface [36].

Edible coatings as well as osmotic dehydration represent two ways to apply hurdle technology to solid foods without affecting their structural integrity [36]. The so-called osmotic dehydration is a dewatering and impregnation process, which consists of soaking foods (fruits, vegetables, meat, cheese, and fish.) in concentrated solutions of humectants (sucrose, and sodium chloride) and is employed for solute transfer from a solution into the product [37]. With this process, also called “direct formulation,” not only can water-activity-lowering agents be inserted into the food, but also preservatives and nutrients, as well as substances that control the pH, texture, and flavor. This would build up positive hurdles, which improve the stability as well as the quality of food products [36,38]. As opposed to traditional soaking techniques

(e.g., salting as used in cheesemaking, fish or meat curing, candying and semicandying), which impregnate solute further and limit water loss, osmotic dehydration generally involves significant water removal (40–70 g of water is lost per 100 g of initial product) with limited and controlled solute incorporation (5–25 g of solute is gained per 100 g of initial product). Under typical operating conditions used for fruit and vegetables, mass transfer mainly occurs during the first 2 h; thereafter, mass transfer rates become progressively slower until water loss stops, whereas solute gain continues to increase steadily. A soaking process does not generally produce stable products, but soaking has to be used as a preprocessing step before complementary processing steps such as drying, freezing, pasteurization, canning, frying, and the addition of preservative agents [39].

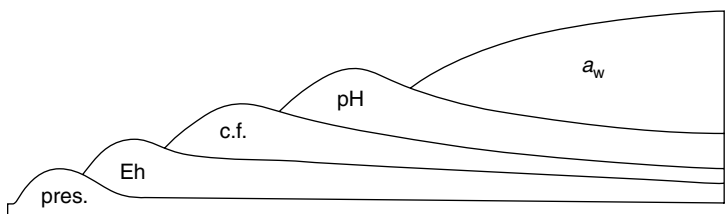
### 36.4.2 Applications in Industrialized Countries

The deliberate and intelligent application of hurdle technology started in the mid-1970s in Germany [1] and was first used for the preservation of meat products [3]. Soon this concept was applied to a variety of food items in industrialized as well as in developing countries. In this review, some examples of advanced hurdle technology employed in industrialized countries for fermented, heated, or chilled foods, and for the design of healthful foods as well as in relation to the trend of less packaging of foods will be discussed.

#### 36.4.2.1 Fermented Foods

In fermented foods, such as fermented sausages, raw hams, ripened cheeses, and pickled vegetables, a sequence of hurdles leads to a stable and safe product. For instance, in fermented sausages (salami), as shown by the sequence of hurdles in Figure 36.1 (example 7), the food-poisoning and the spoilage organisms are inhibited, and the desired competitive flora (lactic acid bacteria) is selected. Because the hurdles inherent to the salami process have been studied in our laboratory [7,19,33,40] and were confirmed in others, they will be briefly discussed here and are again illustrated by Figure 36.2.

The important hurdles in the early stages of the ripening process of salami are nitrite and salt (pres.), which inhibit many of the bacteria in the batter. However, other bacteria are able to multiply, use up the oxygen, and thus cause the redox potential of the product to decrease. This in turn enhances the Eh hurdle, which inhibits aerobic organisms and favors the selection of lactic acid bacteria. They are the competitive flora (c.f.) and flourish by metabolizing the added sugars, which causes a decrease in pH value, i.e., an increase of the pH hurdle. In long-ripened salami the nitrite is depleted and the lactic acid bacteria vanish, while the Eh and pH increase again, i.e., all these hurdles become weak during a longer ripening of salami. Only the water activity hurdle ( $a_w$ ) is strengthened with time and is then mainly responsible for the stability of long-ripened raw sausage [6,33]. Since this sequence of hurdles was revealed, the production of fermented sausages became less empirical and more advanced, and this knowledge has been used to achieve the required inhibition of *Clostridium botulinum*, *Listeria monocytogenes*, and *Staphylococcus aureus* as well as the inactivation of *Salmonella* spp. and verotoxins producing *Escherichia coli* in salami during fermentation and ripening. The sequence of hurdles that



**FIGURE 36.2** Sequence of hurdles occurring during the ripening and drying of fermented sausages (salami). Symbols have the following meaning: pres., addition of nitrite-curing-salt; Eh, decrease of redox potential; c.f., growth of competitive flora; pH, acidification;  $a_w$ , decrease of water activity during the drying process. (After L. Leistner, *Food Design by Hurdle Technology and HACCP*, Adalbert-Raps-Foundation, Kulmbach, 1994, p. 62; L. Leistner, in *Water Activity: Theory and Applications to Food* Marcel Dekker, Inc., New York, 1987, p. 295.)

TABLE 36.2

Criteria of the Quick- and Slow-Ripened Fermented Sausages of Germany

Criteria	Quick-Ripened Products	Slow-Ripened Products
$a_w$	0.95–0.90	0.90–0.65
pH	4.8–5.2	5.4–6.0
Weeks	1–2	4–8
Production	80%	20%

secures the microbial stability and safety of raw hams is also well known [41]. Probably in other fermented foods too, such as ripened cheeses and pickled vegetables, a sequence of hurdles should be important for the proper fermentation process, and it would be challenging to elucidate them.

In Germany, we differentiate within fermented sausages two groups, i.e., quick-ripened products and slow-ripened products (Table 36.2). Quick-ripened products amount to about 80% of the production and the slow-ripened products to only 20%. In quick-ripened products the  $a_w$  is rather high, because they still contain much water, and therefore are less expensive. However, to compensate for this high  $a_w$ , a low pH in such products is essential for microbial stability. On the other hand, slow-ripened products, which are more expensive due to the long drying period, have a low  $a_w$ , and therefore these products can afford a rather high pH, which makes them much more tasty. These differences between quick- and slow-ripened salami are mentioned here, because they illustrate satisfactorily that the hurdles in a food are somehow interchangeable. Therefore, emphasis could be given to different hurdles to achieve microbial stability, with the consequences that the products have different features related to their sensory properties and price.

A feature peculiar to fermented sausages (and probably to ripened cheeses too) is their microstructure, which influences the desired ripening process as well as the survival of pathogenic bacteria in the product. Thus, the microstructure is an important hurdle for the stability of salami [7,19]. Electron microscopy studies [42] have revealed that the natural flora as well as added starter cultures are not evenly distributed in fermented sausages, but are arrested in little cavities of the product, i.e., the ripening flora can only grow in nests. These nests are 100–5000  $\mu\text{m}$  apart, and thus large areas of the sausage must be influenced by metabolites (e.g., nitrate reductase, catalase, organic acids, and bacteriocins) accumulated in such nests or cavities. Thus, from small nests of desirable bacteria the entire fermentation of the product must be accomplished, and from these nests the pathogenic bacteria (e.g., salmonellae or *Listeria*) must be inactivated, even if their nests might be located in distant areas of the food matrix. Within each nest, the bacteria, either in pure or mixed cultures, are in keen competition for nutrients and impair each other by their metabolic products. In nests of mixed cultures, generally the lactic acid bacteria prevail due to their tolerance of low Eh, pH, and  $a_w$ . At the beginning of the sausage fermentation in these nests the lactobacilli appear vigorous and metabolically active, whereas at the end of the ripening process the lactobacilli in their nests have degenerated and may have died [19,42]. Small and equal distances between nests of desirable bacteria in the sausage matrix should be advantageous, since this would foster the proper ripening process and the inactivation of pathogenic bacteria. The thorough mixing of the meat and fat particles of the sausage batter, before stuffing the sausage mix into casings, would bring about the desired, more even distribution of bacteria in the sausage matrix. Moreover, if starter cultures are used, they should be added in a fashion, which favors an even distribution, and this could be achieved better by using starter cultures not in a powdery but in a liquid state [7,19].

However, the microstructure is not only important for salami (and cheese), but for other foods too. In concentrated oil-in-water emulsions the bacteria form small colonies, and in water-in-oil emulsions the bacterial growth is confined to the water droplets, which might lose their integrity due to coalescence [43]. The impact of microstructure on microbial growth, survival, and death in foods has theoretical and practical implications. Certainly, under these circumstances, predictive modeling of the behavior of microorganisms is difficult. On the other hand, it is possible to influence the number, size, and distance of microbial nests in such foods, and thus their safety, stability and quality, by the recipes of the product and the technology applied [7,19]. The microstructure of foods is definitely an important hurdle for certain foods, and therefore this criterion is listed in Table 36.1. Further studies on the behavior of submerged bacterial colonies in food matrices seem warranted [44].

### 36.4.2.2 Heated Foods

Heat-processed high-moisture foods based on hurdle technology, which are stable at ambient temperature, have been named shelf-stable products [3], and they offer the following advantages: the mild heat treatment (70°C–110°C) improves the sensory and nutritional properties of the food, and the lack of refrigeration simplifies distribution and saves energy during storage. SSP are heated in sealed containers (casings, pouches or cans), which avoid recontamination after processing.

However, because of the mild heat treatment, these foods still contain viable spores of bacilli and clostridia, which are inhibited by an adjustment of  $a_w$ , pH, Eh, and, in the case of autoclaved sausages, by sublethal injury of the spores. At present, four different types of SSP foods are distinguished (F-SSP,  $a_w$ -SSP, pH-SSP, and Combi-SSP), depending on their primary hurdles (Table 36.3), though additional hurdles foster the safety and stability of these products [6,7,19].

#### 36.4.2.2.1 F-SSP

In F-SSP [3,6,33], the sublethal damage of the spores is the primary hurdle, which is achieved by a mild heat treatment. Examples are sausages with an adjusted  $a_w$  (Bologna-type sausage  $< 0.97$ , liver and blood sausages  $< 0.96$ ) in PVDC casings that are heated in counterpressure autoclaves to  $F_0 > 0.4$ . Such products are produced in large quantities and in considerable variety since the mid-1980s in German supermarkets. They are stored unrefrigerated for several weeks and have caused no problems with regard to food poisoning or spoilage, because guidelines for their processing have been suggested and followed [45]. The F-SSP, due to metabolic exhaustion of the microorganisms, even autosterilize during storage (see Section 36.3.2). The F-SSP casings are more advisable than cans because during chilling of the cans after autoclaving, some water of condensation may occur inside the lid, and if drops of water fall back on the surface of the sausage mix, the critical  $a_w$  increases locally and thus growth of clostridia may start in this portion of the product. If autoclaved sausages fill the casings tightly, water of condensation inside the container cannot occur, and therefore F-SSP in casings are more stable than in cans with head space [46].

#### 36.4.2.2.2 $a_w$ -SSP

The stability of another type, the  $a_w$ -SSP [3,6,19,30,33], is primarily caused by the reduction of the water activity below 0.95, and guidelines for their processing have been suggested [33]. Examples of traditional  $a_w$ -SSP meats are Italian mortadella and German brühdauerwurst; however, a large variety of such meat products are now on the market, and most of them are snack items. The shelf life of  $a_w$ -SSP at ambient temperature is even better than fermented sausages, since in  $a_w$ -SSP lipases are inactivated due to the heat treatment (internal temperature  $> 75^\circ\text{C}$ ) and thus these products are less prone to become rancid.

#### 36.4.2.2.3 pH-SSP

In the third type, the pH-SSP [3,6,33], an increased acidity is the primary hurdle. This principle is applied in Gelderse rookworst, a shelf-stable meat product, which has been discussed in Section 36.4.1.2. Other traditional meat products of the pH-SSP type are brawns, and these jelly sausages are adjusted to an appropriate pH by the addition of acetic acid. Such products are, for example, composed of a brine (pH  $< 4.8$ ) made of water, gelatin, salt, sugar, agar (2%), spice, and a solid phase, made of Bologna-type sausage in cubes with  $a_w$  of  $< 0.98$ . Both components are mixed (2 parts brine:3 parts meat), filled in casings and heated to an internal temperature of  $> 72^\circ\text{C}$ , but not higher than  $80^\circ\text{C}$ . If the product is in equilibrium, it should have a final pH  $< 5.2$ , and then it is storable for several days at ambient temperatures. Outside the meat field, pH-SSP are common as heat-pasteurized fruit and vegetable preserves with pH  $< 4.5$ , which are bacteriologically stable and safe, in spite of a mild heat treatment. In such products vegetative microorganisms are inactivated by heat, and the multiplication of surviving bacilli and clostridia is inhibited by the low pH. Since bacterial spores are able to germinate at lower pH levels than vegetative bacilli, and

TABLE 36.3

Different Shelf-Stable Products (SSP) and Their Primary Hurdles<sup>a</sup>

F-SSP	Sublethal damage of bacterial spores
$a_w$ -SSP	Slightly reduced water activity
pH-SSP	Slightly increased acidity
Combi-SSP	Combination of equal hurdles

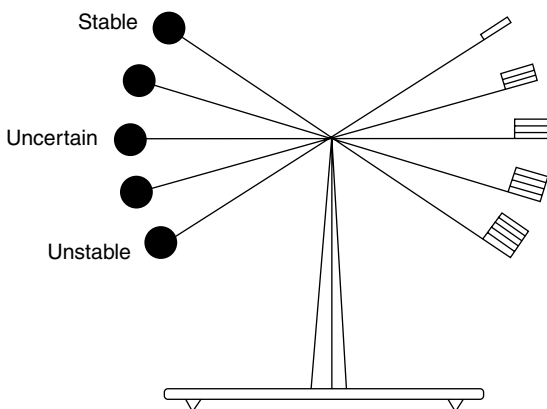
<sup>a</sup>All are mildly heated foods, stable at ambient temperature, nevertheless have fresh-product characteristics

clostridia are able to multiply, in pH-SSP, as in F-SSP and  $a_w$ -SSP, the number of spores tends to decrease during storage due to metabolic exhaustion of microorganisms. On the other hand, while the heat resistance of bacteria and their spores is enhanced with decreasing  $a_w$ , it is diminished with decreasing pH. Thus, pH-SSP needs less heat treatment for inactivation of microorganisms than do  $a_w$ -SSP.

#### 36.4.2.2.4 Combi-SSP

In the fourth type, the Combi-SSP [6,19,47], a combination of rather equal hurdles is applied, each of which adds a little to an imaginary balance [6], which should swing from the unstable to the stable state of the product. Our experimental work suggests that even small enhancements of the individual hurdles in a food in summation have a definite effect on the microbial stability of a product. For instance, for the stability and safety of a food, it is of significance whether the  $F_0$  is 0.3 or 0.4, the  $a_w$  is 0.975 or 0.970, the pH is 6.5 or 6.3, and the Eh value is somewhat higher or lower. Every small improvement or reinforcement of a hurdle adds some weight to the balance, and the sum of these weights determines whether a food is microbiologically unstable, uncertain, or stable (Figure 36.3). In other words, all little steps in the direction of stability decide whether or not the balance swings from an unstable into a stable state of the product [6]. We followed this line in our product design of Bologna-type sausages as Combi-SSP. Different types of Brühwurst (wieners, bockwurst, fleischwurst, and fleischkäse) were developed, which proved to be microbiologically stable and safe at least for 1 week at 30°C. The initial spore load of the sausage mix is low, because spice extracts instead of natural spices are used, nitrite (100 ppm) with curing salt must be added, and these products are heated to a core temperature > 72°C, and are adjusted to an  $a_w$  and pH of < 0.965 and < 5.7, respectively. These products are repasteurized after vacuum packaging for 45–60 min (depending on the diameter of the products) at 82°C–85°C [48]. Combi-SSP offers opportunities for many food items; however, they require strict rules for food design and process control (see Section 36.5). The Combi-SSP concept is not only applicable to meat products but to other foods also. For instance, an Italian pasta product (tortellini) was stabilized by using hurdles like water activity reduction and a mild heat treatment, as well as modified atmosphere or ethanol vapor during storage, combined with moderate chilling temperatures [49,50]. Another example is paneer, a dairy product of India, which was developed as Combi-SSP [51,52], and will be discussed later (Section 36.4.3.3). In both cases, the thesis work of young scientists was groundbreaking.

The Federal Centre for Meat Research in Germany demonstrated the efficiency of the application of hurdle technology in an extensive study (supported by the Medical Corps of the German Army) on 75 meat products with fresh-product characteristics, which were storable without refrigeration [19,47,48]. In this



**FIGURE 36.3** The balance should illustrate that even small enhancements of different hurdles could bring about in summation a substantial improvement of the microbial stability of a food. (After L. Leistner, *Food Res. Int.* 25: 151, 1992; L. Leistner, *Food Design by Hurdle Technology and HACCP*, Adalbert-Raps-Foundation, Kulmbach, 1994, p. 62.)

study, eight categories of meat products were selected and optimized, one represented fermented sausages and most of the others F-SSP,  $a_w$ -SSP, and Combi-SSP (Table 36.4). Since these meats had to be suitable for army rations during military exercises, they had to be stable and safe at least for 6 days at 30°C, and in addition be tasty and nutritious. Since large- and medium-size enterprises had to supply them, if they were granted a contract from the army, we had to define the manufacturing of these meats in detail, and for this purpose we introduced a linkage between hurdle technology and hazard analysis critical control point (HACCP) [19,53]. In the manufacturing plants, while processing the recommended meats for the army, no microbiological tests could be carried out; however, time, temperature, pH, and  $a_w$  had to be strictly controlled. These measurements had to be done on-line or at least close to the line. Fortunately, a precise instrument for



this purpose became available [54], which allows  $a_w$  determinations of meat products within 10–20 min. This army study might be useful in other occasions, in which hurdle technology and HACCP should be linked [47].

### 36.4.2.3 Chilled Foods

The results of hurdle technology are most obvious in high-moisture foods, which become shelf stable at ambient temperature due to an intelligent application of combined methods for preservation. However, the use of hurdle technology is appropriate for chilled foods too, because in case of temperature abuse, which easily might happen during food distribution, the stability and safety of chilled foods could break down, especially if low temperature storage is the only hurdle. Therefore, it is reasonable to incorporate into chilled foods (e.g., sous vide dishes) some additional hurdles, which would act as a backup in case of temperature abuse. This type of safety precaution for chilled foods might be called “invisible technology” [8,19], and this implies that the additional hurdle acts as safeguards in chilled foods and ensures that they remain microbiologically stable and safe during storage in retail outlets as well as at home.

However, for many chilled foods, additional hurdles are already routinely used. This is in particular true for refrigerated foods, for which modified-atmosphere packaging (MAP) is employed. Raw and minimally processed vegetables are among the most popular ready-to-eat foods, which are stored chilled in MAP [55,56]. In Europe, MAP is mainly applied to salads, potatoes, carrots, and cabbage, whereas in USA the fresh-cut market produce is served mainly with salads, paprika, onions, cabbage, mushrooms, endive, and spinach. MAP is intended to suppress microbial growth; retard respiration, ripening, and aging of vegetables; and inhibit oxidative reactions requiring oxygen. In combination with appropriate chilling, shelf life of foods under MAP can be up to 5–7 days. Immediately before sealing, gas of defined composition is introduced in the packages that are generally stored at 4°C–7°C. Typically, the gas composition in MAP for fresh and minimally processed vegetables is 2%–5% oxygen and 5%–10% carbon dioxide. The modified composition of the gas atmosphere in MAP systems has a marked impact on the growth of spoilage microorganisms as well as on pathogens [57–59]. Minimally processed vegetables are not sterile and numerous genera of spoilage bacteria, yeasts, and molds are frequently encountered, and some cold-tolerant pathogens (*E. coli* 0157:H7, *Bacillus cereus*, *Yersinia enterocolitica*, *Aeromonas hydrophila*, *Listeria monocytogenes*) are hazards for MAP produce and all have been reported to occur on vegetables [60]. Even the CO<sub>2</sub> in MAP does not inhibit the pathogens directly, the competitive flora that grows in MAP at reduced oxygen and increased carbon dioxide might act as a hurdle and thus suppress the pathogens mentioned [58]. However, occasionally *L. monocytogenes* might under certain conditions in MAP systems proliferate to hazardous levels. Additional preservative factors (hurdles), e.g., *Enterococcus mundtii* as protective culture, may be integrated into the MAP system to assure a safety better than what is possible with current standards [61].

### 36.4.2.4 Healthful Foods

Consumers demand healthy foods, that contain less fat, salt (sodium), and cholesterol. Because of this trend muscle foods, derived from red meat, poultry, or fish are modified. However, less salt or fat as well as their substitutes and replacers might diminish the microbial stability and safety of foods since important hurdles change. Compensation of these deficits could be achieved by application of intelligent hurdle technology [62,63].

**TABLE 36.4**

Categories of Meat Products on the German Market, Which Are Fresh-Like and Storable without Refrigeration due to the Application of Hurdle Technology

1. Quick-ripened fermented sausage
2. Mini-salami (two different technologies)
3. Brühwurst and liver sausage as F-SSP
4. Dried brühwurst as  $a_w$ -SSP
5. Repasteurized brühwurst as  $a_w$ -SSP
6. Brawns and brühwurst as pH-SSP
7. Items of brühwurst as Combi-SSP
8. Brühwurst in autoclaved flat pouches

*Source:* L. Leistner, *Food Design by Hurdle Technology and HACCP*, Adalbert-Raps-Foundation, Kulmbach, 1994, p. 62; L. Leistner and H. Hechelmann, Proceedings of Food Preservation 2000, U.S. Army Research Center, Natick, Massachusetts, 1993, vol. II, pp. 511–520; H. Hechelmann et al., *Stabile Fleischerzeugnisse mit Frischprodukt-Charakter für die Truppe*, BMVg FBWM 91–11, Dokumentations- und Fachinformationszentrum der Bundeswehr, Bonn, Germany, 1991, p. 129.

Several substitutes and enhancers for sodium chloride (i.e., various other salts and hydrolysates) and > 100 fat replacers (i.e., fat mimetic systems or synthetic fat replacers) are available today and are of potential use for modified muscle foods. However, the microbial consequences of their use are generally unknown. Probably, of major importance for the stability and safety of low-fat and low-salt muscle foods is an increased water activity ( $a_w$ ), and the acidity (pH) might be unfavorable too since low salt muscle foods have a slightly higher pH compared with the normal products, and if fat is replaced by proteins the pH and the buffering capacity might increase, and thus the microbial stability and safety of these products would decrease. Added preservatives might be diluted and thus rendered less effective, since low fat products contain more water due to an increased water holding capacity caused by fat replacers. Furthermore, the redox potential (Eh) might change because proteinaceous fat replacers might increase the Eh-buffering capacity of a food, whereas foods with a high water content should have a low Eh capacity. The microstructure of some foods (e.g., emulsions, fermented products) is significant for their microbial stability and safety. This microstructure could change by the addition of some fat replacers; however, this effect has not yet been investigated. More data are needed on the impact of different fat replacers and salt substitutes (sodium), as well as of relevant combinations, on the important preservative factors (hurdles) of modified foods. The quantitative data obtained should be the basis for the microbial stability management of novel low-fat and low-salt muscle foods, and would make the design by intelligent hurdle technology feasible.

To keep low-fat and low-salt muscle foods microbiologically stable and safe, the refrigeration during storage of these products must be perfect. Since this cannot always be guaranteed, the weak hurdles in modified products should be compensated by alternative preservative factors. In the design, processing, and marketing of low-fat and low-salt muscle foods the microbiologists should take an active part, and his close cooperation with technologists will prove fruitful. Hitherto, in the design and production of low-fat and low-salt muscle foods the nutritional aspects have been emphasized much more than the microbial aspects. However, the latter should not be neglected, because these foods will only be continuously accepted by the consumer if they cause no food poisoning and do not spoil easily [62,63].

#### **36.4.2.5 Packaging of Foods**

Packaging is an important hurdle for most foods, since it supports the microbial stability and safety as well as the sensory quality of the products. Little research has been carried out in packaging of hurdle technology foods as a group. Because for the various types of hurdle technology foods known, the appropriate packaging materials and procedures must be selected and applied with respect to the individual properties of the food items in question [8,64].

The industrialized countries have the tendency to overpackage their foods, whereas in developing countries there is a lack of knowledge and of simple packaging materials for foods. Therefore, further exploration into easy-to-use, cheap, environment-friendly, and efficient packaging for hurdle technology foods for developing countries should be a challenging and even a lucrative approach [64].

Packaging in industrialized countries is sophisticated, because absorbers, scavengers, scrubbers, getters, or emitters for gas components as well as desiccants, antimicrobial packaging material, tuned infrared films, edible food coatings and films, time-temperature integrator tags, and microwave doneness indicators are employed for food items [65,66]. These procedures and devices might be summarized under the term "active packaging." Japan was in many respects and for several decades the world champion in food packaging, and recent developments in active or smart packaging frequently originated from this country. However, since the mid-1980s several Japanese packaging experts cast doubts on these developments and question whether such strategies in food packaging should be pursued in the future. According to the opinions of Japanese packaging experts, which were conveyed by Ono [67], five generations of food packaging are distinguishable: First came the function of "containing," i.e., since prehistorical times people used vessels, pots, and baskets as containers for foods. The second generation of packaging had the function of "transporting," i.e., wrappings, bottles, and barrels were used for food transport and distribution. The third generation provided extended shelf life of foods by hermetical "sealing" the packages, and this made canning, vacuum, and modified atmosphere as well as aseptic packaging possible. In the fourth generation, the packaging had to "create quality" during distribution of the food, i.e., now the packaging itself has a processing function, in addition to the common processing of foods. Therefore, such systems are called smart or active or functional packaging, and they are

**TABLE 36.5**

## Generations of Food Packaging, Suggested in Japan

---

First: "Containing." People used packaging (pots and baskets) since prehistorical days for containing foodstuffs.

Second: "Transporting." Packaging is used to transport foodstuffs in bottles, barrels, containers, and cartons.

Third: "Sealing." This made canning of foods; vacuum, modified atmosphere, and aseptic packaging possible.

Fourth: "Create Quality." Active packaging improves the food through scavengers, absorbers, getters, and emitters.

Fifth: "Less Packaging." Just-in-time distribution of foods or advanced hurdle technology foods provides the shelf life.

---

*Source:* After K. Ono, *Packaging Design and Innovation*, material for a Third Country Training Programme in the Field of Food Packaging, February 20—March 5, Singapore, 1994, p. 34; Kentaro Ono, Snow Brand Tokyo, Japan (personal communication, 1996).

sophisticated but costly and wasteful too. In addition, they create environmental problems, which in a densely populated country like Japan have severe consequences. Therefore, recycling and reduced packaging have become necessary goals. Japan aims at using the fifth generation of packaging at "less packaging" of foods, and this generation might be called the "climax of packaging or its despair" [67]. In the fifth generation, the shelf life and quality of foods should not be provided by the packaging, but by the food itself or by the mode of distribution (Table 36.5).

In the opinion of Japanese experts, the future packaging should provide only information (name and picture of product, nutritional and shelf life data) and some convenience to the consumer. The required shelf life of the food shall not come from the packaging, but shall be secured either by (i) aseptic packaging combined with just-in-time delivery systems, or (ii) development of stable and safe hurdle technology foods.

Aseptic (ultraclean) packaging of food is perfectly executed in Japan, because factory workers carry out orders with discipline and diligence. If, owing to ultraclean packaging, only few microorganisms are present "at the start" in the food, only few hurdles of low intensity are needed to inhibit microbial growth, and thus ultraclean packaging is an important component of hurdle technology [6,7]. Ultraclean packaged foods need only simple packaging, if, in addition, a quick delivery at low temperature is guaranteed. In Japan, such foods are transported close to freezing point, and just-in-time distribution systems have been widely introduced, because they provide the needed shelf life at low costs due to reduced inventory at the point of sale [67]. Delivery is often done three times a day, and this just-in-time delivery proved successful and is expected to increase rapidly. However, the frequency of the transportation needed would also be a burden on the environment.

The other concept that could avoid elaborate packaging is to design foods that are stable, safe, and of superior sensory quality in spite of minimal packaging. In this respect, Japanese authors discussed initially the promotion of intermediate-moisture foods [67]. However, after getting acquainted with hurdle technology applied to high-moisture foods, the latter concept became a promising option for achieving the fifth generation of food packaging [68].

### 36.4.3 Applications in Developing Countries

There exists an abundant variety of preserved foods in developing countries, because the gap between harvest peaks has to be bridged, and the taste as well as the nutritional properties of foods might improve due to preservation. Most of the preserved foods in developing countries, which preferably must be storable without refrigeration, are based on empirical use of hurdle technology. However, several foods have already been optimized by the intentional application of hurdles. The state-of-the-art use of hurdle technology in some countries of Latin America, Asia, and Africa has recently been presented in a comprehensive review [31]. Therefore, only some examples will be briefly discussed.

#### 36.4.3.1 Fruits of Latin America

During the last decade, a novel process for the preservation of high-moisture fruit products (HMFP:  $a_w > 0.93$ ) has been developed in seven Latin American countries (Argentina, Costa Rica, Cuba, Mexico,

Nicaragua, Puerto Rico, and Venezuela) and has been applied to peach halves, pineapple slices, mango slices and purée, papaya slices, chicozapote slices, purée of banana, plum, passion fruit, and tamarind, as well as whole figs, strawberries, and pomalanza [22,23]. The new technologies were based on the combination of a mild heat treatment (blanching for 1–3 min with saturated steam), slight reduction in water activity (to 0.98–0.93, by addition of glucose or sucrose), lowering of pH (to 4.1–3.0, by addition of citric or phosphoric acids), and the addition of antimicrobials (potassium sorbate or sodium benzoate, and sodium sulfite or sodium bisulfite) in moderate amounts to the syrup of the products (Table 36.6). During storage of HMFP, the sorbate and in particular the sulfite levels decreased, whereas the  $a_w$  fell (the  $a_w$  hurdle increased) due to the hydrolysis of sucrose [23]. Thus, “combined methods technology” (hurdle technology) was applied in these novel processes [21–23,69,70]. The minimal processes proved inexpensive, energy efficient, simple to carry out (little capital investment), and were satisfactory to preserve fruits *in situ*. The resulting fresh-like products were still scored highly by the 30–50 member consumer panel after 3 months of storage at 35°C for taste, flavor, color, and especially for texture, which is often problematic for canned fruits. Thus, according to Latin American researchers [22,23,69,71,72], the combined methods applied allow storage of fruits, without losses between seasonal harvest peaks, for direct domestic consumption or for further processing to confectionery, bakery goods and dairy products, or for preserves, jams, and jellies. Fruit pieces can also be utilized as ingredients in salads, barbecues, pizzas, yoghurt, and fruit drink formulations [23,71]. Moreover, these novel HMFP will open new possibilities for export markets.

The high-moisture fruit products stabilized by hurdle technology proved shelf stable and safe for at least 3–8 months of storage at 25°C–35°C. Owing to the blanching process the initial microbial counts were substantially reduced, and during the storage of the stabilized HMFP the number of surviving bacteria, yeasts, and molds further decreased, often below the detection limits [21–24,69,70–72]. Banana puree challenged with yeasts, molds, clostridia, and bacilli, known to spoil fruits, and stored at ambient temperatures for 120 days remained stable when proper hurdles were applied (mild heat treatment, adjustment of  $a_w$  to 0.97 and pH to 3.4, addition of 100 ppm potassium sorbate, 400 ppm sodium bisulfite, and 250 ppm ascorbic acid). The inoculated microorganisms declined and often vanished below the detection limit [70]. These favorable microbiological results obtained with HMFP are probably due to “metabolic exhaustion” of the microorganisms present in the stabilized products (see Section 36.3.2). Since HMFP during storage at ambient temperatures become apparently sterile, pathogenic and toxigenic microorganisms are not likely to be a hazard for these foods [31].

Alzamora and coworkers expressed the opinion that HMFP technologies, as developed in Latin America, will attract much attention in many developing countries, because they are easy to implement

**TABLE 36.6**

Typical Process Used for the Preservation of High-Moisture Fruit Products (HMFP), as Developed in Latin America

Hurdles	Intensity
1. Heat treatment <sup>a</sup>	Saturated steam for 1–3 min
2. Water activity <sup>b</sup>	$a_w$ reduction to 0.98–0.93
3. Acidification <sup>c</sup>	pH adjustment to 4.1–3.0
4. Preservative (I)	1000 ppm sorbate or benzoate
5. Preservative (II)	150 ppm sulfite or bisulfite

<sup>a</sup>Dependent on the size and type of fruit

<sup>b</sup>Adjusted with sucrose, glucose, and maltodextrine.

<sup>c</sup>Adjusted, if necessary, with phosphoric or citric acid

Source: After S.M. Alzamora et al., in *Food Preservation by Moisture Control, Fundamentals and Applications*, Technomic, Lancaster, Pennsylvania, 1995, p. 463; M.S. Tapia de Daza et al., in *Food Preservation by Moisture Control, Fundamentals and Applications*, Technomic, Lancaster, Pennsylvania, 1995, p. 575; A. Argaiz et al., in *Food Preservation by Moisture Control, Fundamentals and Applications* Technomic, Lancaster, Pennsylvania, 1995, p. 729; M.S. Tapia de Daza et al., *Crit. Rev. Fd. Sci. Nutr.* 36: 629 (1996).

and will improve the quality of stored fruits considerably [22]. They even believe that the usefulness of hurdle technology for HMFP may give rise to an “explosion” of research on minimally processed fruits, and of the application of this innovative process by the food industry [23]. The advances of Latin America in fruit preservation are impressive, and recently have been confirmed by Indian researchers, who concluded that “hurdle technology is seen as a promising technique for the preservation of fresh fruits and vegetables” [73]. However, the preservation of HMFP must certainly be based on the guidelines for good manufacturing practice (GMP), to be successful under industrial or even artisan conditions [74]. For instance, the reuse of syrup may become a risk in relation to a build-up of the spoilage flora (e.g., *Zygosaccharomyces bailii*, which could be sorbate resistant), and therefore the reuse of syrup in HMFP processes should only be recommended after pasteurization.

### 36.4.3.2 Meats of China

Even though the per capita consumption of meat, compared to Western countries, is rather low in China, nevertheless, due to the huge number of people living in China; this country has the largest meat consumption worldwide. Pork is the preferred meat in China; however, beef, water buffalo, sheep, poultry, and rabbit are also used as raw materials [75]. Only about 15% of the available meat of China is processed [76]; however, this is still a large amount and meat products are an important and precious part of the diet. Two categories of meat products exist in China side by side: Chinese meats and Western meats. Of the Western meat products, recently, autoclaved emulsion-type sausages have gained ground in China. Their technology has been derived from the German F-SSP (see Section 36.4.2.2.1); however, the  $a_w$  of the Chinese products is not adjusted, and therefore they must receive a severe heat treatment ( $F_0 > 5.0$ ), which is not beneficial for the taste, but results in shelf-stable products. On the other hand, the recipes of traditional Chinese meat products date back centuries, and their microbial stability and safety are based on combined preservative factors empirically applied. Studies are in progress to identify the hurdles inherent to these traditional meats [77]. The concept of hurdle technology (Zang Lan Gi Shu, in Chinese) was introduced in China by the author of this chapter. Work related to application of hurdle technology to meat products is carried out at present in several Chinese research institutes, and recent publications in Chinese [e.g., 78–82] have made this concept popular in the People’s Republic of China.

Traditional Chinese meat products are quite simple to prepare without expensive equipment, have a typical flavor, are ready to eat, and storable for an extended time without refrigeration. The traditional meats of China listed in Table 36.7 are all intermediate-moisture foods, and this implies that they might be too salty or too sweet, too tough and too dark due to the formation of much Maillard reaction products. The water activity is the primary hurdle in these meats, but if additional hurdles are strengthened then the  $a_w$  might be raised, and this often improves the sensory quality of the products. However, the microbial stability and safety of the meats must not be jeopardized by an increased  $a_w$ . Therefore, intentional and intelligent hurdle technology is increasingly applied. Some examples of such endeavors will be cited.

Rou gan is a typical dried meat product of China, prepared mainly from beef, using a technology that has not changed for hundreds of years, but improvements are possible and desirable. Consumers now prefer products with a softer texture, lighter color, and less sugar addition. Shafu is a modified dried meat that fulfills these expectations. The  $a_w$  of rou gan is in the range of 0.60–0.69, whereas shafu has an  $a_w$  of 0.74–0.76, because its moisture is higher and the sugar content lower. Additional hurdles in shafu are nitrite and ascorbic acid, which improve

**TABLE 36.7**

Traditional Chinese Meat Products<sup>a</sup>

Cured meats (Yan La)	Chinese bacon—La Rou Pressed duck—Ban Ya Silk rabbit—Cha Si Tu Cured chicken—Yuan Bao Ji
Dried meats (Rou Gan)	Dried meat—Rou Gan Sweet meat—Rou Pu Meat floss—Rou Song
Sausage (La Chang)	Guangdong La Chang, and Sichuan La Chang,
Raw ham (Ho Tui)	Yü Nam Ho Tui and Jin Hua Ho Tui

<sup>a</sup>All these meat products are intermediate-moisture foods and are storable without refrigeration.

Source: After L. Leistner, in *The Microbiological Safety and Quality of Food* (B.M. Lund, T.C. Baird-Parker, and G.W. Gould, eds.), Aspen Publishers Inc., Gaithersburg, Maryland, 2000, vol. I, p. 294; W. Wang and L. Leistner, *Fleischwirtsch.* 74: 1135 (1994).

the color and delay rancidity, whereas rou gan is cured with nitrate only. Furthermore, the microbial stability of shafu is improved by the selection of raw material with low microbial load, low temperature during curing but relative high temperature and shorter times during heating, minimizing of recontamination after the heat process as well as vacuum packaging of the final product to inhibit mold growth and to delay rancidity. Therefore, shafu is microbiologically stable and safe for several months at ambient temperatures, and thus has the same shelf life as the traditional rou gan [76]. Both products have low residual levels of nitrite and nitrate, contain few microorganisms, including, in general, no pathogenic or toxigenic bacteria, and thus are safe meats.

A similar approach was chosen to improve the quality of Islamic dried beef in dices, which is also storable for several months without refrigeration. The traditional product is just salted and dried, and therefore is very salty and becomes easily rancid. The modified product contains less salt, is cured with nitrate to improve color, and some ascorbic acid is added to delay rancidity. Furthermore, vacuum packaging is applied to reduce oxidation and avoid mold growth [83]. More examples for the application of hurdle technology to Chinese meat products have been given in a recent review article [31].

Finally, the stabilization of the Chinese sausage, which was achieved in cooperation with Taiwan [84], will be mentioned. Chinese sausage is highly esteemed by oriental consumers and differs from the fermented sausages common in Western countries. It is also processed raw, although with only little fermentation. Several types of la chang (also called lup cheong) are known, e.g., the Sichuan type is more spicy and the Cantonese type more sweet, whereas the Taiwanese la chang is more soft. In mainland China, finished products of la chang have the following properties:  $a_w$  0.85–0.70, pH 5.9–5.7, NaCl 3%–5%, sugar 4%–20%, total count  $< 10^6$ /g, shelf life 2–3 months without refrigeration and if vacuum packaged 4–5 months. To the coarsely ground meat and fat from pork, sugar, salt, soya sauce, liquor, spices, nitrate (or nitrite), and sometimes sodium ascorbate are added. The mix is stuffed into casings with small diameter, and the sausages are dried fast over charcoal at 45°C–60°C to  $a_w < 0.92$ , and then further at ambient temperature to  $a_w < 0.80$ , to avoid an increase of lactic acid bacteria counts, since all Chinese dislike sour meats. Thus, la chang is a typical meat product preserved by combined factors. In general, before consumption, la chang is sliced and heated in rice or vegetable dishes [33,77,78,84].

The Taiwanese variety of Chinese sausage contains more moisture and therefore can have an  $a_w$  as high as 0.94. This improves the sensory properties since the products are softer, but decreases their microbial stability and safety, because in such products lactic acid bacteria still grow and lead to a sour taste, and *Staphylococcus aureus* might cause food poisoning. After addition of 3.5% sodium lactate and 1.0% sodium acetate, the Taiwanese sausage remains tasty and is rendered microbiologically stable and safe, even if stored for several weeks without refrigeration. These additives reduce the  $a_w$  of the product but also have some antimicrobial effects [84]. Challenge tests using inocula of *Staphylococcus aureus*, *Listeria monocytogenes*, or *Salmonella* spp. confirmed that Taiwanese sausage, which was modified by intentional hurdle technology, was stable and safe [84]. Furthermore, they demonstrated that in this product the number of pathogens decreased faster during storage at 25°C than at 10°C. This was probably due to a faster metabolic exhaustion of the pathogens at the higher storage temperature (see Section 36.3.2).

### 36.4.3.3 Dairy Products of India

Lectures in India by the author of this chapter on food preservation using combined preservative factors, as well as reports on this subject published by Indian scientists (e.g., Refs. [52,73,85,86]) have stimulated research about the application of hurdle technology to traditional and modified Indian food products. Work related to food preservation using hurdle technology is at present carried out at several research institutes of India. In India, vegetarian food is common, but dairy products are also much appreciated. Some recent examples of the application of hurdle technology to Indian dairy products will be discussed.

Paneer is a traditional, cottage-cheese-type product fried in cubes with oil and onions, to which a sauce containing salt, spices, and often tomatoes are added. This food is frequently consumed and much liked in the northern provinces of India, because of its nutritive value and characteristic taste. However, paneer spoils bacteriologically within 1–2 days at room temperature (which in India can reach 35°C), and this is a strong drawback for its industrial production. Sterilized paneer in cans has severe sensory limitations with regard to flavor, texture, and color. Therefore, together with a visiting scientist from

India, Dr. K. Jayaraj Rao, in the German Meat Research Institute, Kulmbach, a mildly heated paneer in hermetically sealed containers, with the desired flavor (freshly prepared), color (little browning), and texture (not too hard) was developed [51]. This product was stabilized by hurdle technology, and thus is stable and safe for several weeks without refrigeration. The following combinations of hurdles proved effective in this product:  $a_w = 0.97$ , heating to  $F_0$  of 0.8, pH = 5.0 or alternatively  $a_w = 0.96$ ,  $F_0 = 0.4$ , pH = 5.0 [51]. After his return to India, K.J. Rao conducted a thorough study on the application of hurdle technology to fried paneer in cubes made from buffalo milk. The product with gravy was packed either in tins or flexible retort pouches, and a set of hurdles, i.e.,  $a_w = 0.95$ ,  $F_0 = 0.8$ , pH 5.0, and 0.1% potassium sorbate, was chosen, which had maximum lethal and inhibitory effects on microorganisms and minimum effects on textural and chemical characteristics [52]. The water activity of paneer and gravy was lowered by using humectants, such as *dahi*, skim milk powder, salt, and glycerol. The pH was adjusted by changing the *dahi*:skim milk powder ratio. The resulting product had a keeping quality of 2 weeks at 45°C, 1 month at 30°C, or over 3 months at 15°C, which was limited by textural changes (hardness, cohesiveness, gumminess, springiness, and chewiness) as well as by chemical changes (browning, oxidation, lipolysis, and loss of available lysin), but not by microbial spoilage. The stabilized product was compared with fresh samples from restaurants and was found to be equally acceptable. In the opinion of Rao [52], this method of paneer preservation has a large scope for alterations in product formulations, depending on regional taste preferences, without affecting the keeping quality of the product. Via paneer, the hurdle technology has been introduced into food science of India, and its application to other indigenous foods is now anticipated.

A recent example is *dudh churpi*. This is a popular dairy product of the Himalayan region of India (i.e., Bhutan, Sikkim, and Darjeeling), made of milk from yaks or cows and is stable for several months without refrigeration. Most important for *dudh churpi* is the texture (elasticity), since people living in high altitudes chew it as an “energy tablet.” The sensory quality and microbial stability of *dudh churpi* was optimized by Hossain [86] using combined methods (hurdle technology), i.e., heating, acid coagulation, addition of sugar and sorbate, smoking, drying, and packaging in closed containers. In this detailed and diligent study, *dudh churpi* was scientifically explored and then a feasible optimization of the product was suggested. Thus, hurdle technology was applied to improve the quality of a traditional food of the remote Himalayan region, and at the same time the scientific basis of this study opened new avenues for food science and industrial food production in India.

---

### 36.5 Design of Hurdle Technology Foods

The application of hurdle technology is useful for the optimization of traditional foods as well as in the development of novel products. There are similarities between the concepts of predictive microbiology and HACCP. The three concepts have related but different goals: hurdle technology is primarily used in food design, the predictive microbiology for process refinement, and the HACCP concept for process control. In product development, these three concepts should be combined. Therefore, we have suggested for the design of foods, a 10-step procedure that comprises all three concepts (Table 36.8), and this approach proved suitable when solving real product development tasks in the food industry [19,47,87]. However, these 10 steps should still be considered tentative, until further practical experience with the application of the suggested user guide for food design has accumulated in the food industry.

In food design, experts from different disciplines, including microbiologists and technologists, must work together. The microbiologist should determine which types and intensity of hurdles are needed for the necessary safety and stability of a particular food product, and the technologist should determine which ingredients or processes are proper for establishing these hurdles in a food, by taking the legal, technological, sensory, and nutritive limitations into account. Because the engineering, economic, and marketing aspects have to be taken into consideration too, food design is indeed a multidisciplinary endeavor [7,19].

Predictive microbiology [88,89] is a promising concept that allows computer-based and quantitative predictions of microbial growth, survival, and death in foods, and thus should be an integral part of advanced food design (see Table 36.8, steps 4 and 7). However, the predictive models constructed so far handle only up to four different factors (hurdles) simultaneously. There are numerous hurdles to be

**TABLE 36.8**

Steps for Food Design Using an Integrated Concept Comprising Hurdle Technology, Predictive Microbiology, and HACCP or GMP

1. For the modified or novel food product, the desired sensory properties and the desired shelf life are tentatively defined.
2. A feasible technology for the production of this food has to be outlined.
3. The food is manufactured according to this technology, and the resulting product is analyzed for pH,  $a_w$ , preservatives, or other inhibitory factors. Temperatures for heating (if intended) and storage, as well as the expected shelf life are defined.
4. For preliminary microbial stability testing of the food product, predictive microbiology might be employed.
5. The product is challenged with food-poisoning and spoilage microorganisms, using somewhat higher inocula and storage temperatures than would be “normal” for this food.
6. If necessary, the hurdles in the product are modified, taking “multitarget preservation” and the sensory quality of the food (i.e., “total quality”) into consideration.
7. The food is again challenged with relevant microorganism, and if necessary the hurdles in the food are modified again. Predictive microbiology for assessing the safety of the food might be helpful at this stage too.
8. After the established hurdles of the modified or novel foods are exactly defined, including tolerances, the methods for monitoring the process are agreed on. Preferably physical methods for monitoring should be used.
9. The designed food should now be produced under industrial conditions, because the possibilities for a scale-up of the proposed manufacturing process must be validated.
10. For the industrial process, the critical control points (CCPs) and their monitoring have to be established, and therefore the manufacturing process should be controlled by HACCP. If HACCP is not appropriate, guidelines for the application of manufacturing control by GMP must be defined.

Source: After L. Leistner *Food Design by Hurdle Technology and HACCP*, Adalbert-Raps-Foundation, Kulmbach, 1994, 62 pp.; L. Leistner and H. Hechelmann, *Proceedings of Food Preservation 2000*, U.S. Army Research Center, Natick, Massachusetts, 1993, vol. II, pp. 511–520; L. Leistner, in *Food Preservation by Combined Processes*, FLAIR Final Report, EUR 15776 EN, European Commission, Brussels, 1994, p. 25.

considered nevertheless, which are important for the stability, safety, and quality of a particular food (see Section 36.2.4). It is unlikely that all, or even a majority of these hurdles, could be covered by predictive modeling. Thus, predictive microbiology cannot be a quantitative approach to the totality of hurdle technology. However, it does allow quite reliable predictions of the fate of microorganisms in food systems, while considering few yet the most important hurdles. As several hurdles are not taken into account, the predicted results are fortunately often on the safe side, i.e., the limits indicated for growth of pathogens in foods by the models available are in general more prudent (“fail safe”) than the limits in real foods. Nevertheless, predictive microbiology will be an important tool for advanced food design, because it can narrow down considerably the range over which challenge tests with relevant microorganisms need to be performed. Although predictive microbiology will never render challenge testing obsolete, it may greatly reduce both time and costs spent in product development [7,12,19].

HACCP could be a reasonable supplement to hurdle technology, because after the food has been properly designed, its manufacturing process must be effectively controlled, and for this purpose the application of HACCP might be suitable. However, in a strict sense, the HACCP concept only controls the hazards of foods, and not at the same time their stability and quality [90]. Even in commercial practice, safety and quality issues will often overlap if HACCP is applied [19]. Since for hurdle technology foods the microbial safety and stability as well as the sensory quality, i.e., the total quality of the food (see Section 36.2.3), is essential, the HACCP concept might be too narrow for this purpose if it relates only to biological, chemical, and physical hazards. Therefore, the HACCP concept should be broadened to cover the microbial safety (food poisoning), stability (spoilage) of foods as well as their sensory quality. If this is not acceptable, instead of HACCP the production process could be controlled by GMP, and for this purpose GMP rules or guidelines for the production of each food item must be defined [33]. For hurdle technology foods of developing countries, GMP guidelines are often more acceptable, because the application of HACCP faces practical difficulties where many small producers prevail.



---

## 36.6 Conclusions

The stability, safety, and quality of most preserved foods is based on empirical application of combined methods for preservation and, more recently, intentionally employed hurdle technology. The deliberate and intelligent application of hurdle technology allows a gentle but efficient preservation of safe, stable, nutritious, and tasty foods, and is advancing worldwide. Moreover, knowledge of the physiological basis of growth, survival, and death of pathogenic and spoilage microorganisms in foods is increasing, since the homeostasis, metabolic exhaustion, and stress reactions of microorganisms in relation to the hurdle effect are now better understood. Therefore, the multitarget preservation, as an ultimate goal for a gentle but most effective preservation of foods, is more likely to be achieved soon.

In industrialized countries, the hurdle technology approach is at present of utmost interest for minimally processed, fresh-like foods that are mildly heated or fermented, and for underpinning the microbial stability and safety of foods coming from future lines, such as healthful foods with less fat and salt or advanced hurdle technology foods that require less packaging. For refrigerated foods, chill temperatures are the major and sometimes the only hurdle. However, in case of temperature abuse during distribution this hurdle breaks down, thus spoilage or food poisoning could happen. Therefore, additional hurdles should be incorporated as safeguards into chilled foods, and this approach might be called "invisible technology."

In developing countries, the intentional application of hurdle technology for foods, which remain stable, safe, and tasty even if stored without refrigeration, has made impressive strides, especially in Latin America with the development of novel high-moisture fruit products. However, much interest in intentional hurdle technology is also emerging for meat products in China as well as for dairy products of India. There is a general trend in developing countries to move gradually away from intermediate-moisture foods, because they are often too salty or too sweet, and have a less appealing texture and appearance than high-moisture foods. However, deliberate hurdle technology should be applied to high-moisture foods without sacrificing the microbial stability and safety, especially of those foods that are stored without refrigeration. Therefore, if hurdle technology foods become more sophisticated, they will require a thorough understanding of the principles involved as well as more backup of their production by guidelines based on GMP and, where appropriate, by application of the HACCP concept.

Hurdle technology foods are in general less robust than traditional food products, which are often overprocessed, and thus maintain a large margin of safety. Therefore, if modified hurdle technology foods are produced, the applied processes must be exactly defined and controlled. For the design of hurdle technology foods, a 10-step procedure was suggested that comprises hurdle technology, predictive microbiology, and HACCP or GMP guidelines. This procedure proved suitable for solving real product development tasks in the food industry; however, it is open to further improvements. Hurdle technology should not lead to the addition of too much additives but actually should reduce the amount of additives used even if their number might increase. It is of paramount importance that additional hurdles are introduced into a food product only after careful consideration of the necessity and in essential amounts, otherwise an undesirable chemical overloading of the food might result.

Combined methods used for tissue preservation are by no means a new process, as has been pointed out by Chirife et al. [91] in their study on the mummification in ancient Egypt. In the opinion of these authors, the embalmed mummies contained, more than 3000 years ago (at least), three hurdles namely reduced  $a_w$  (0.72), increased pH (10.6), and preservatives (spices, aromatic plants). However, today the action of combined preservative factors is much better understood and their intentional and intelligent application is progressing, and further applications of hurdle technology for optimization of traditional as well as in the design of novel foods are anticipated.

---

## References

1. L. Leistner, Hurdle effect and energy saving, *Food Quality and Nutrition* (W.K. Downey, ed.), Applied Science Publishers, London, 1978, p. 553.
2. L. Leistner, W. Rödel, and K. Krispien, Microbiology of meat products in high- and intermediate-moisture ranges, *Water Activity: Influences on Food Quality* (L.B. Rockland and G.F. Stewart, eds.), Academic Press, New York, 1981, p. 855.

3. L. Leistner, Hurdle technology applied to meat products of the shelf stable product and intermediate moisture food types, *Properties of Water in Foods in Relation to Quality and Stability* (D. Simatos and J.L. Multon, eds.), Martinus Nijhoff Publishers, Dordrecht, 1985, p. 309.
4. L. Leistner and L.G.M. Gorris, *Food Preservation by Combined Processes*, FLAIR Final Report, EUR 15776 EN, European Commission, Brussels, 1994, 100 pp.
5. L. Leistner and L.G.M. Gorris, Food preservation by hurdle technology, *Trends Food Sci. Technol.* 6: 41 (1995).
6. L. Leistner, Food preservation by combined methods, *Food Res. Int.* 25: 151 (1992).
7. L. Leistner, Principles and applications of hurdle technology, *New Methods of Food Preservation* (G.W. Gould, ed.), Blackie Academic & Professional, London, 1995, p. 1.
8. L. Leistner, Food protection by hurdle technology, *Bull. Jpn. Soc. Res. Food Prot.* 2: 2 (1996).
9. L. Leistner, I. Vukovic, and J. Dresel, SSP: meat products with minimal nitrite addition, storable without refrigeration. Proceedings of 26th Europ. Meeting Meat Res. Workers, Colorado Springs, Colorado, 1980, vol. II, pp. 230–233.
10. D.W. Stanley, Biological membrane deterioration and associated quality losses in food tissues, *Crit. Rev. Fd. Sci. Nutr.* 30: 487 (1991).
11. B.M. McKenna, Combined processes and total quality management, *Food Preservation by Combined Processes* (L. Leistner and L.G.M. Gorris, eds.), FLAIR Final Report, EUR 15776 EN, European Commission, Brussels, 1994, p. 99.
12. L. Leistner, Further developments in the utilization of hurdle technology for food preservation, *J. Food Eng.* 22: 421 (1994).
13. L. Bøgh-Sørensen, Description of hurdles, *Food Preservation by Combined Processes* (L. Leistner and L.G.M. Gorris, eds.), FLAIR Final Report, EUR 15776 EN, European Commission, Brussels, 1994, p. 7.
14. L. Leistner, Emerging concepts for food safety, Proceedings of 41st ICoMST, San Antonio, Texas, 1995, pp. 321–322.
15. G.W. Gould, Interference with homeostasis—food, *Homeostatic Mechanisms in Micro-organisms* (R. Whittenbury, G.W. Gould, J.G. Banks, and R.G. Board, eds.), Bath University Press, Bath, 1988, p. 220.
16. D. Häussinger (ed.), *pH Homeostasis—Mechanisms and Control*, Academic Press, London, 1988, 479 pp.
17. G.W. Gould, Homeostatic mechanisms during food preservation by combined methods, *Food Preservation by Moisture Control, Fundamentals and Applications* (G.V. Barbosa-Cánovas and J. Welte-Chanes, eds.), Technomic, Lancaster, Pennsylvania, 1995, p. 397.
18. L. Leistner and S. Karan-Djurdjic, Beeinflussung der Stabilität von Fleischkonserven durch Steuerung der Wasseraktivität, *Fleischwirtschaft* 50: 1547 (1970).
19. L. Leistner, *Food Design by Hurdle Technology and HACCP*, Adalbert-Raps-Foundation, Kulmbach, 1994, 62 pp.
20. H.-K. Shin, *Energiesparende Konservierungsmethoden für Fleischerzeugnisse, abgeleitet von traditionellen Intermediate Moisture Foods*, PhD Thesis, Universität Hohenheim, Stuttgart-Hohenheim, 1984, 115 pp.
21. S. Sajur, *Preconservación de Duraznos por Métodos Combinados*, MS Thesis, Universidad Nacional de Mar del Plata, Argentina, 1985.
22. S.M. Alzamora, M.S. Tapia, A. Argaiz, and J. Welte, Application of combined methods technology in minimally processed fruits, *Food Res. Int.* 26: 125 (1993).
23. S.M. Alzamora, P. Cerrutti, S. Guerrero, and A. López-Malo, Minimally processed fruits by combined methods, *Food Preservation by Moisture Control, Fundamentals and Applications* (G.V. Barbosa-Cánovas and J. Welte-Chanes, eds.), Technomic, Lancaster, Pennsylvania, 1995, p. 463.
24. M.S. Tapia de Daza, A. Argaiz, A. López-Malo, and R.V. Díaz, Microbial stability assessment in high and intermediate moisture foods: special emphasis on fruit products, *Food Preservation by Moisture Control, Fundamentals and Applications* (G.V. Barbosa-Cánovas and J. Welte-Chanes, eds.), Technomic, Lancaster, Pennsylvania, 1995, p. 575.
25. S.P. Denyer, and W.B. Hugo (eds.), *Mechanisms of Action of Chemical Biocides: Their Study and Exploitation*, Blackwell Scientific Publications, London, 1991, 346 pp.
26. L. Leistner and W. Rödel, The stability of intermediate moisture foods with respect to micro-organisms, *Intermediate Moisture Foods* (R. Davies, G.G. Birch, and K.J. Parker, eds.), Applied Science Publishers, 1976, p. 120.

27. J.M. Aguilera, J. Chirife, M.S. Tapia, J. Welti, and E. Parada Arias, *Inventario de Alimentos de Humedad Intermedia Tradicionales de Iberoamérica*. Unidad Profesional Interdisciplinaria de Biotecnología, Instituto Politécnico Nacional, México, 1990, 557 pp.
28. J. Welti, M.S. Tapia de Daza, J.M. Aguilera, J. Chirife, E. Parada, A. López Malo, L.C. López, and P. Corte, Classification of intermediate moisture foods consumed in Ibero-America, *Rev. Esp. Cienc. Tecnol. Aliment.* 34: 53 (1994).
29. M.S. Tapia de Daza, J.M. Aguilera, J. Chirife, E. Parada, and J. Welti, Identification of microbial stability factors in traditional foods from Iberoamerica. *Rev. Esp. Cienc. Tecnol. Aliment.* 34: 145 (1994).
30. L. Leistner, F. Wirth, and I. Vukovic, SSP (Self Stable Products)—Fleischerzeugnisse mit Zukunft, *Fleischwirtsch.* 59: 1313 (1979).
31. L. Leistner, Use of combined preservative factors in foods of developing countries, *The Microbiological Safety and Quality of Food* (B.M. Lund, T.C. Baird-Parker, and G.W. Gould, eds.), Aspen Publishers Inc., Gaithersburg, Maryland, 2000, Vol. I, P. 294.
32. T. El-Khateib, U. Schmidt, and L. Leistner, Mikrobiologische Stabilität von türkischer Pastirma, *Fleischwirtsch.* 67: 101 (1987).
33. L. Leistner, Shelf-stable products and intermediate moisture foods based on meat, *Water Activity: Theory and Applications to Food* (L.B. Rockland and L.R. Beuchat, eds.), Marcel Dekker, New York, 1987, p. 295.
34. J.A. Torres, Microbial stabilization of intermediate moisture food surfaces, *Water Activity: Theory and Applications to Food* (L.B. Rockland and L.R. Beuchat, eds.), Marcel Dekker, Inc., New York, 1987, p. 329.
35. S. Guilbert, Technology and application of edible protective film, *Food Packaging and Preservation* (M. Matahlouthi, ed.), Elsevier Applied Science Publisher, New York, 1986, p. 371.
36. S. Guilbert, Edible coatings and osmotic dehydration, *Food Preservation by Combined Processes* (L. Leistner and L.G.M. Gorris, eds.), FLAIR Final Report, EUR 15776 EN, European Commission, Brussels, 1994, p. 65.
37. C.R. Lerici, D. Mastrocola, A. Sensidoni, and M. Dalla Rosa, Osmotic concentration in food processing, *Preconcentration and Drying of Food Materials* (S. Bruin, ed.), Elsevier Applied Science Publishers, Amsterdam, 1988, p. 123.
38. A.L. Raoult-Wack, S. Guilbert, and A. Lenart, Recent advances in drying through immersion in concentrated solutions, *Drying of Solids* (A.S. Mujumdar, ed.), International Science Publishers, New York, 1992, p. 21.
39. A.L. Raoult-Wack, Recent advances in the osmotic dehydration of foods, *Trends Food Sci. Technol.* 5: 255 (1994).
40. L. Leistner, Stable and safe fermented sausages world-wide, *Fermented Meats* (G. Campbell-Platt and P.E. Cook, eds.), Blackie Academic & Professional, London, 1995, p. 160.
41. L. Leistner, Allgemeines über Rohschinken, *Fleischwirtsch.* 66: 496 (1986).
42. K. Katsaras and L. Leistner, Distribution and development of bacterial colonies in fermented sausages, *Biofouling* 5: 115 (1991).
43. M. Robins, T. Brocklehurst, and P. Wilson, Food structure and the growth of pathogenic bacteria, *Food Technol. International Europe* 31 (1994).
44. J.W.T. Wimpenny, L. Leistner, L.V. Thomas, A.J. Mitchell, K. Katsaras, and P. Peetz, Submerged bacterial colonies within food and model systems: their growth, distribution and interactions, *Int. J. Food Microbiol.* 28: 299 (1995).
45. H. Hechelmann and L. Leistner, Mikrobiologische Stabilität autoklavierter Darmware, *Mitteilungsblatt der Bundesanstalt für Fleischforschung, Kulmbach*, 84, 5894 (1984).
46. H. Hechelmann, L. Leistner, and R. Albertz, Ungleichmäßiger  $a_w$ -Wert als Ursache für mangelhafte Stabilität von F-SSP, *Jahresbericht Bundesanstalt für Fleischforschung, Kulmbach* 1985: C 27 (1985).
47. L. Leistner and H. Hechelmann, Food preservation by hurdle-technology, Proceedings of Food Preservation 2000, U.S. Army Research Center, Natick, Massachusetts, 1993, vol. II, pp. 511–520.
48. H. Hechelmann, R. Kasproviak, S. Reil, A. Bergmann, and L. Leistner, *Stabile Fleischerzeugnisse mit Frischprodukt-Charakter für die Truppe*, BMVg FBWM 91–11, Dokumentations- und Fachinformationszentrum der Bundeswehr, Bonn, Germany, 1991, 129 pp.
49. P. Giavedoni, *Azioni Combinate nella Stabilizzazione degli Alimenti*, PhD Thesis, Università degli Studi di Udine, Udine, Italy, 1994, 208 pp.

50. P. Giavedoni, W. Rödel, and J. Dresel, Beitrag zur Sicherheit und Haltbarkeit von frischen gefüllten Teigwaren, abgepackt in modifizierter und in einer Äthanol-Gas-Atmosphäre, *Fleischwirtsch.* 74: 639 (1994).
51. K.J. Rao, J. Dresel, and L. Leistner, Anwendung der Hürden-Technologie in Entwicklungsländern, zum Beispiel für Paneer, *Mitteilungsblatt der Bundesanstalt für Fleischforschung, Kulmbach*, 31: 293 (1992).
52. K.J. Rao, *Application of Hurdle Technology in the Development of Long Life Paneer-Based Convenience Food*, PhD Thesis, National Dairy Research Institute, Karnal, India, 1993, 193 pp.
53. L. Leistner, Linkage of hurdle-technology with HACCP, Proceedings of the 45th Reciprocal Meat Conference, Chicago, Illinois, 1993, pp. 1–3.
54. W. Rödel, R. Scheuer, and H. Wagner, A new method of determining water activity in meat products, *Fleischwirtsch. Int.* 1990: 22 (1990).
55. L.G.M. Gorris and H.W. Peppelenbos, Modified atmosphere and vacuum packaging to extend the shelf-life of respiring products, *Hort. Technol.* 2: 303 (1992).
56. I.J. Church and A.L. Parsons, Modified atmosphere packaging technology: a review, *J. Sci. Food Agric.* 67: 143 (1994).
57. C. Nguyen-the, and F. Carlin, The microbiology of minimally processed fresh fruits and vegetables, *Crit. Rev. Fd. Sci. Nutr.* 34: 371 (1994).
58. M.H.J. Bennis, H.W. Peppelenbos, C. Nguyen-The, F. Carlin, E.J. Smid, and L.G.M. Gorris, Microbiology of minimally processed, modified-atmosphere packaged chicory endive, *Posth. Biol. Technol.* 9: 209 (1996).
59. C.A. Phillips, Modified atmosphere and its effects on the microbiological quality and safety of produce, *Int. J. Food Sci. Technol.* 31: 463 (1996).
60. L.R. Beuchat, Pathogenic microorganisms associated with fresh produce, *J. Food Prot.* 59: 204 (1995).
61. M.H.J. Bennis, W. van Overbeek, E.J. Smid, and L.G.M. Gorris, Biopreservation in modified atmosphere stored mungbean sprouts: the use of vegetable-associated bacteriocinogenic lactic acid bacteria to control the growth of *Listeria monocytogenes*. *Lett. Appl. Microbiol.* 28: 226 (1999).
62. L. Leistner, Microbial stability of low fat and/or low salt meat products, Proceedings of the 43rd ICOMST, Auckland, New Zealand, 1997, pp. 414–415.
63. L. Leistner, Microbial stability and safety of healthy meat, poultry and fish products, *Production and Processing of Healthy Meat, Poultry and Fish Products* (A.M. Pearson and T.R. Dutson, eds.), Blackie Academic & Professional, London, 1997, p. 347.
64. L. Leistner, Stable hurdle technology foods and packaging—worldwide, *J. Pack. Sci. Technol., Jpn.* 6: 4 (1997).
65. A.L. Brody, Active packaging 2001, *Meat International* 2(9/10): 42 (1991).
66. T.P. Labuza, An introduction to active packaging for foods, *Food Technol.* 50(4): 68 (1996).
67. K. Ono, *Packaging Design and Innovation*, Material for a Third Country Training Programme in the field of food packaging, February 20–March 5, Singapore, 1994, 34 pp.
68. K. Ono, Snow Brand Tokyo Japan (personal communication, 1996).
69. A. López-Malo, E. Palou, J. Welti, P. Corte, and A. Argai, Shelf-stable high moisture papaya minimally processed by combined methods, *Food Res. Int.* 27: 545 (1994).
70. S. Guerrero, S.M. Alzamora, and L.N. Gerschenson, Development of a shelf-stable banana purée by combined factors: microbial stability, *J. Food Prot.* 57: 902 (1994).
71. A. Argai, A. López-Malo, and J. Welti-Chanes, Considerations for the development and stability of high moisture fruit products during storage, *Food Preservation by Moisture Control, Fundamentals and Applications* (G.V. Barbosa-Cánovas and J. Welti-Chanes, eds.), Technomic, Lancaster, Pennsylvania, 1995, p. 729.
72. M.S. Tapia de Daza, S.M. Alzamora, and J. Welti Chanes, Combination of preservation factors applied to minimal processing of foods, *Crit. Rev. Fd. Sci. Nutr.* 36: 629 (1996).
73. N.K. Rastogi, J.S. Sandhi, P. Viswanath, and S. Saroja, Application of hurdle/combined method technology in minimally processed long-term non-refrigerated preservation of banana and coconut, Abstracts for ICFoST '95, Mysore, India, 1995, pp. 109–110.
74. L. Leistner, Use of hurdle technology in food processing: recent advances, *Food Preservation by Moisture Control, Fundamentals and Applications* (G.V. Barbosa-Cánovas and J. Welti-Chanes, eds.), Technomic, Lancaster, Pennsylvania, 1995, p. 377.

75. L. Leistner, Fermented and intermediate moisture foods, Proceedings of the 36th ICoMST, Havana, Cuba, 1990, pp. 842–855.
76. W. Wang and L. Leistner, Shafu: a novel dried meat product of China based on hurdle-technology, *Fleischwirtsch.* 73: 854 (1993).
77. W. Wang and L. Leistner, Traditionelle Fleischerzeugnisse von China und deren Optimierung durch Hürden-Technologie, *Fleischwirtsch.* 74: 1135 (1994).
78. W. Wang and L. Leistner, Hurdle technology applied to traditional meat products, *Meat Res.* 1995(3): 8 (1995), in Chinese.
79. W. Wang and L. Leistner, Application of hurdle technology in the development of food products. Part I, *Meat Res.* 1996(1): 42 (1996), in Chinese.
80. W. Wang and L. Leistner, Application of hurdle technology in the development of food products. Part II, *Meat Res.* 1996(2): 42 (1996), in Chinese.
81. X.Q. Zhu, Developments in the theory of food preservation and its applications in foreign countries, *Meat Res.* 1996(2): 39 (1996), in Chinese.
82. X.Q. Zhu and L. Leistner, Water activity and food preservation, *Meat Res.* 1996(3): 48 (1996), in Chinese.
83. R. Xia and Q.N. Hsu, Processing method for Islamic dried beef in dices, *Meat Res.* 1996(3): 32 (1996), in Chinese.
84. J.C. Kuo, J. Dresel, and L. Leistner, Effects of sodium lactate and storage temperature on growth and survival of *Staphylococcus aureus*, *Listeria monocytogenes* and *Salmonella* in Chinese sausage, *Chinese Food Sci.* 21: 182 (1994).
85. J.S. Berwal, Hurdle technology for shelf-stable food products, *Indian Food Ind.* 13: 40 (1994).
86. Sk.A. Hossain, *Technological Innovation in Manufacturing Dudh Churpi*, PhD Thesis, University of North Bengal, Siliguri, India, 1994, 122 pp.
87. L. Leistner, User guide to food design, *Food Preservation by Combined Processes* (L. Leistner and L.G.M. Gorris, eds.), FLAIR Final Report, EUR 15776 EN, European Commission, Brussels, 1994, p. 25.
88. T.A. McMeekin, J.N. Olley, T. Ross, and D.A. Ratkowsky, *Predictive Microbiology: Theory and Application*, Research Studies Press Ltd., Taunton, Somerset, 1993, 340 pp.
89. P.J. McClure, C. de W. Blackburn, M.B. Cole, P.S. Curtis, J.E. Jones, J.D. Legan, I.D. Ogden, M.W. Peck, T.A. Roberts, J.P. Sutherland, and S.J. Walker, Modelling the growth, survival and death of microorganisms in foods: the UK Food Micromodel approach, *Int. J. Food Microbiol.* 23: 265 (1994).
90. M.D. Pierson and D. Corlett JR., *HACCP : Principles and Applications*, Van Nostrand Reinhold, A Division of Wadsworth Inc., USA, 255 pp.
91. J. Chirife, G. Favetto, S. Ballesteros, and D. Kitic, Mummification in ancient Egypt: an old example of tissue preservation by hurdle technology, *Lebensm.-Wiss. u. Technol.* 24: 9 (1991).

# 37

## *Update on Hurdle Technology for Mild and Effective Preservation of Foods*

Lothar Leistner

### CONTENTS

37.1	Introduction .....	895
37.2	Principles of Food Preservation .....	896
37.2.1	Hurdle Technology.....	896
37.2.1.1	Fundamentals of Hurdle Technology .....	897
37.2.1.2	Hurdles for Food Preservation .....	899
37.2.1.3	Total Quality and Monitoring of Hurdle Foods .....	899
37.2.1.4	International Interest in Hurdle Technology.....	900
37.2.1.5	Reviews on Hurdle Technology .....	900
37.2.2	Recent Applications of Hurdle Technology.....	900
37.2.2.1	Provisions for the Army .....	900
37.2.2.2	Fusion Foods of China .....	901
37.2.2.3	Novel Fruit Preservation .....	901
37.2.3	Design of Hurdle-Technology Foods.....	901
37.2.3.1	Steps of Food Design .....	901
37.2.3.2	Shelf-Life Prediction of Hurdle Foods .....	902
37.3	Conclusions .....	903
	References .....	903

### 37.1 Introduction

The microbial stability and safety of most traditional and novel foods are based on a combination of several preservative factors (called *hurdles*), which microorganisms present in the food are unable to overcome. This is illustrated by the so-called hurdle effect, first introduced by Leistner [1]. The hurdle effect is of fundamental importance for the preservation of foods, since the hurdles in a stable product control microbial spoilage, food poisoning, as well as desired fermentation processes [1,2]. Leistner and coworkers acknowledged that the hurdle effect illustrates only the well-known fact that complex interactions of temperature, water activity, pH, redox potential, etc., are significant for the microbial stability of foods. From an understanding of the hurdle effect, hurdle technology [3] was derived, which allows improvements in the safety and quality of foods using deliberate and intelligent combinations of hurdles. Over the years insight into the hurdle effect has been broadened and the application of hurdle technology extended. In industrialized countries, hurdle technology is currently of particular interest for minimal-processed, convenience foods, whereas in developing countries foods storable without refrigeration, due to stabilization by hurdle technology, are at present of paramount importance. The application of deliberate and intelligent hurdle technology is increasing rapidly worldwide. This concept was also referred to as food preservation by combined methods, however, now the term hurdle technology is most often used.

In Europe, a 3-year research project on food preservation by combined processes, supported by the European Commission, to which scientists from 11 European countries have contributed, fostered the application of hurdle technology [4,5]. The hurdle technology concept proved successful, as an intelligent combination of hurdles secures microbial stability and safety as well as the sensory quality of foods [6,7], it provides convenient and healthy foods to the consumer, and is cost-effective for producers since it demands less energy during production and storage.

---

## 37.2 Principles of Food Preservation

Many preservation methods are used for making foods stable and safe, e.g., heating, chilling, freezing, freeze drying, drying, curing, salting, sugar addition, acidification, fermentation, smoking, and oxygen removal. However, these processes are based on relatively few parameters or hurdles, e.g., high temperature ( $F$  value), low temperature ( $t$  value), water activity ( $a_w$ ), acidification (pH), redox potential (Eh), preservatives (pres.), and competitive flora (c.f.). In some of the preservation methods mentioned, these parameters are of major importance, and in others they are only secondary hurdles [2,6].

The critical values of these parameters for the death, survival, or growth of microorganisms in foods have been determined in recent decades and are now the basis of food preservation. However, it must be kept in mind that the critical value of a particular parameter changes if other preservative factors are present in food. For instance, the heat resistance of bacteria increases at low  $a_w$  and decreases at low pH and in the presence of some preservatives, whereas a low Eh increases the inhibition of microorganisms caused by a reduced  $a_w$ . The simultaneous effect of different preservative factors could be additive or even synergistic. Furthermore, as mentioned earlier, the microbial stability and safety of many foods are based on the combined effects of hurdles. For instance, mildly heated canned foods (“half-preserved” or “three-quarter-preserved”) need refrigeration during storage, and fermented sausages are only stable and safe if both the  $a_w$  and the pH are in an appropriate range. Therefore, in food preservation the combined effect of preservative factors must be taken into account.

### 37.2.1 Hurdle Technology

In previous publications [6,7], figures with several examples illustrating the principles of hurdle technology in foods have been presented, which will not be repeated here. However, it should be mentioned that the hurdle effect is, for instance, important for the ultraclean or aseptic packaging of foods, because if there are only few microorganisms present at the start, then a few or low hurdles are sufficient for the stability of the product. The same proves true if the initial microbial load of a food (e.g., on carcass meat or on high-moisture fruits) is substantially reduced (e.g., by the application of steam), because after such decontamination procedures fewer microorganisms are present, which are then more easily inhibited. The number and intensity of hurdles needed for microbial stability are also lower if the microorganisms present are sublethally injured, because then they lack “vitality” and thus are easier to inhibit. In contrast, a food rich in nutrients and vitamins will foster the growth of microorganisms (the “booster” or “trampoline” effect), and thus the hurdles in such foods must be enhanced, otherwise they will be overcome. The latter also happens if due to bad hygiene too many undesirable microorganisms are initially present, then the usual hurdles inherent to a product may be unable to prevent spoilage or food poisoning. In fermented foods (e.g., salami, raw ham, cheese, pickled fruits, or vegetables) a sequence of hurdles is active, arising in different stages of the ripening process and leading to microbiologically stable and safe products.

A better understanding of the occurrence and interaction of different preservative factors (hurdles) in foods is the basis for improvements in food preservation. If the hurdles for a food are known, the microbial stability and safety of this food might be optimized by changing the intensity or quality of these hurdles. From an understanding of the hurdle effect, hurdle technology has been derived [3], which means that hurdles are deliberately combined in the preservation of traditional and novel foods. Using an intelligent mix of hurdles, it is possible to improve not only the microbial stability and safety, but also the sensory and nutritive qualities, as well as the economic aspects, of a food. It is important that the water content

in the product be compatible with the microbial stability, and if an increased  $a_w$  is compensated by other hurdles (pH, Eh, etc.) this food becomes more economical. Even the pet food industry now employs this principle. Stable pet food was formerly produced with an  $a_w$  of 0.85, which required addition of excessive amounts of propylene glycol, which might have adversely affected the pet's health. But now, owing to the application of hurdle technology, pet foods are microbiologically stable at ambient temperatures with an  $a_w$  of 0.94, and they are more healthy, tasty, and economical [6]. Hurdle technology is increasingly used for food design in industrialized and developing countries for optimizing traditional foods and for making new products according to needs. For instance, if energy preservation is the goal, then energy-consuming hurdles, such as refrigeration, are replaced by other hurdles ( $a_w$ , pH, or Eh) that do not demand energy but still ensure a stable and safe food [1]. Furthermore, if we want to reduce or replace preservatives (e.g., nitrite in meats), we could emphasize other hurdles in the food (e.g.,  $a_w$ , pH, refrigeration, or competitive flora), which would stabilize the product [8]. More recent examples related to the application of hurdle technology will be given in subsequent sections of this chapter.

### 37.2.1.1 Fundamentals of Hurdle Technology

Food preservation implies exposing microorganisms to a hostile environment to inhibit their growth, shorten their survival, or cause their death. The feasible responses of the microorganisms to such a hostile environment determine whether they grow or die. More basic research is needed in this area, because a better understanding of the physiological basis for growth, survival, and death of microorganisms in food products could open new dimensions for food preservation [7]. Furthermore, such an understanding would be the scientific basis for an efficient application of hurdle technology in the preservation of foods. Advances have been made by considering the homeostasis, metabolic exhaustion, and stress reactions of microorganisms, as well as by introducing the concept of multitarget preservation for gentle yet effective preservation of foods [7,9].

#### 37.2.1.1.1 Homeostasis

A key phenomenon that deserves more attention in food preservation is the interference by the food with the homeostasis of microorganisms [10]. Homeostasis is the tendency to uniformity and stability in the internal status of organisms. For instance, the maintenance of a defined pH within narrow limits is a feature and prerequisite of living organisms, and this applies to higher organisms as well as to microorganisms. Much is already known about homeostasis in higher organisms at the molecular, subcellular, cellular, and systemic levels in the fields of pharmacology and medicine [11]. This knowledge should be transferred to microorganisms important for the poisoning and spoilage of foods. In food preservation, the homeostasis of microorganisms is a key phenomenon, which deserves much attention, because if the homeostasis of these microorganisms is disturbed by preservative factors (hurdles) in foods, they will not multiply, i.e., they remain in the lag phase or even die, before homeostasis is repaired (reestablished). Thus, food preservation is achieved by disturbing the homeostasis of microorganisms in a food temporarily or permanently [7].

Gould [10] has pointed out that during evolution a wide range of mechanisms (e.g., osmoregulation to counterbalance a hostile water activity in food) have developed in microorganisms that act to keep important physiological systems operating, and unperturbed even when the environment around them is greatly perturbed [12]. In most foods microorganisms are operating homeostatically in order to react to environmental stresses imposed by the preservation procedures applied. The most useful procedures employed to preserve foods are effective in overcoming various homeostatic mechanisms the microorganisms have evolved to survive extreme environmental stresses [12]. The repair of a disturbed homeostasis demands much energy, and thus the restriction of energy supply inhibits repair mechanisms in microbial cells and leads to a synergistic effect of preservative factors (hurdles). Energy restriction for microorganisms is, for example, caused by anaerobic conditions, such as vacuum or modified-atmosphere packaging of foods. Therefore, low  $a_w$  (or low pH) and low redox potential act synergistically [12]. Such interference with the homeostasis of microorganisms or entire microbial populations provides an attractive and logical focus for improvements in food-preservation techniques [12].



### 37.2.1.1.2 Metabolic Exhaustion

Another phenomenon of practical importance is the metabolic exhaustion of microorganisms, which could lead to "autosterilization" of a food. This was first observed in experiments with mildly heated (95°C core temperature) liver sausage adjusted to different water activities by the addition of salt and fat, and the product was inoculated with *Clostridium sporogenes* and stored at 37°C. Clostridial spores that survived the heat treatment vanished in the product during storage if the products were stable [13]. Later this behavior of *Clostridium* and *Bacillus* spores was regularly observed during storage of shelf-stable meat products (SSP), if these products were stored at ambient temperatures [14]. The most likely explanation is that bacterial spores that survive the heat treatment are able to germinate in these foods under less favorable conditions than those under which vegetative bacteria are able to multiply [6]. Thus, the spore counts in stable hurdle-technology foods actually decrease during storage of the products, especially in unrefrigerated foods. Also during studies in our laboratory with Chinese dried meat products the same behavior of microorganisms was observed. If these meats were contaminated after processing with staphylococci, salmonellae, or yeasts, the counts of these microorganisms on stable products decreased quite fast during unrefrigerated storage, especially on meats with a water activity close to the threshold for microbial growth. Latin American researchers [15,16] observed the same phenomenon in studies with high-moisture fruits products, because the counts of a variety of bacteria, yeasts, and molds, which survived the mild heat treatment, decreased fast in the products during unrefrigerated storage, since the hurdles applied (pH,  $a_w$ , sorbate, and sulfite) did not allow growth.

A general explanation for this surprising behavior might be that vegetative microorganisms which cannot grow will die, and they die more quickly if the stability is close to the threshold for growth, storage temperature is elevated, antimicrobials are present, and the microorganisms are sublethally injured (e.g., by heat) [7]. Apparently, microorganisms in stable hurdle-technology foods strain every possible repair mechanisms for their homeostasis to overcome the hostile environment, by doing this they completely use up their energy and die, if they become metabolically exhausted. This leads to an autosterilization of such foods. Owing to autosterilization, hurdle-technology foods, which are microbiologically stable, become more safe during storage, especially at ambient temperatures. For example, salmonellae that survive the ripening process in fermented sausages will vanish more quickly if the products are stored at ambient temperature, and they will survive longer and possibly cause foodborne illness if the products are stored under refrigeration [7]. It is also well known that salmonellae survive in mayonnaise at chill temperatures much better than at ambient temperatures. Unilever laboratories at Vlaardingen have confirmed metabolic exhaustion in water-in-oil emulsions (resembling margarine) inoculated with *Listeria innocua*. In these products *Listeria* vanished faster at ambient temperature (25°C) than under refrigeration (7°C), at pH 4.25 > pH 4.3 > pH 6.0, in fine emulsions more quickly than in coarse emulsions, and under anaerobic conditions more quickly than under aerobic conditions. From these experiments, it has been concluded that metabolic exhaustion is accelerated if more hurdles are present, and this might be caused by increasing energy demands to maintain internal homeostasis under stress conditions (ter Steg, P.F., personal communication, 1995). Thus, it could be concluded that refrigeration is not always beneficial for the microbial safety and stability of foods. However, this is only true if the hurdles present in a food inhibit the growth of microorganisms also without refrigeration, if this is not the case then refrigeration is beneficial. Certainly, the survival of microorganisms in stable hurdle-technology foods is much shorter without refrigeration.

### 37.2.1.1.3 Stress Reactions

Some bacteria become more resistant or even more virulent under stress, since they generate stress shock proteins. The synthesis of protective stress shock proteins is induced by heat, pH,  $a_w$ , ethanol, oxidative compound, as well as by starvation. Stress reactions might have a nonspecific effect, since due to a particular stress microorganism become more tolerant to other stresses, i.e., they acquire a "cross-tolerance." The various responses of microorganisms under stress might hamper food preservation and could turn out to be problematic for the application of hurdle technology. However, the activation of genes for the synthesis of stress shock proteins, which help organisms to cope with stress situations, should be more difficult if different stresses are received at the same time. Simultaneous exposure to different stresses will require energy-consuming synthesis of several or at least much more protective stress shock proteins,

which in turn may cause the microorganisms to become metabolically exhausted. Therefore, multitarget preservation of foods could be the key for avoiding synthesis of stress shock proteins, which otherwise could jeopardize the microbial stability and safety of hurdle-technology foods [17].

#### 37.2.1.1.4 *Multitarget Preservation*

The concept of multitarget preservation of foods has been introduced by Leistner [7,17]. Multitarget preservation should be the ambitious goal for a gentle but most effective preservation of foods [17]. It has been suspected for some time that different hurdles in a food might not have just an additive effect on microbial stability, but they could act synergistically [1]. A synergistic effect could be achieved if hurdles in a food hit, at the same time, different targets (e.g., cell membrane, DNA, enzyme systems, pH,  $a_w$ , and Eh) within the microbial cells and thus disturb the homeostasis of the microorganisms present in several respects. If so, the repair of homeostasis as well as the activation of stress shock proteins become more difficult [7]. Therefore, employing simultaneously different hurdles in the preservation of a particular food should lead to optimal microbial stability. In practical terms, this could mean that it is more effective to employ different preservative factors (hurdles) of small intensity than one preservative factor of larger intensity, because different preservative factors might have a synergistic effect [18].

It is anticipated that the targets in microorganisms of different preservative factors for foods will be elucidated, and that hurdles could be grouped in classes according to their targets. A mild and effective preservation of foods, i.e., a synergistic effect of hurdles, is likely if the preservation measures are based on intelligent selection and combination of hurdles taken from different target classes [7]. This approach is probably not only valid for traditional food-preservation procedures, but as well for modern processes such as food irradiation, high hydrostatic pressure, and pulsed technologies [19]. Food microbiologists could learn from pharmacologists, because the mechanisms of action of biocides have been studied extensively in the medical field. At least 12 classes of biocides are known which have different targets, and sometimes more than one, within the microbial cell. Often the cell membrane is the primary target, becoming leaky and disrupting the organism, but biocides also impair the synthesis of enzymes, proteins, and DNA [20]. Multidrug attack has proven successful in the medical field to fight bacterial infections (e.g., tuberculosis and leprosy) as well as viral infections (e.g., AIDS), and thus a multitarget attack on microorganisms should also be a promising approach in food microbiology [17].

#### 37.2.1.2 *Hurdles for Food Preservation*

At present, the most important hurdles for food preservation are  $F$  (high temperature: heating),  $t$  (low temperature: chilling, freezing),  $a_w$  (water activity: drying, salting, sugaring, freezing), pH (acidity: acidification), Eh (redox potential: oxygen removal, ascorbate addition, etc.), pres. (preservatives: sulfite, sorbate, nitrite, etc.), and c.f. (competitive flora: fermentation). However, many additional hurdles should be taken into account. The number of potential hurdles is great. Not only with respect to novel nonthermal preservation methods (e.g., high hydrostatic pressure, mano-thermo-sonication, oscillating magnetic fields, and light pulses), but especially with respect to the many only partially investigated “natural” preservatives, which are effective in plants and animals as well as in biofilms. After these potential hurdles have been investigated thoroughly, at least 100 preservative hurdles should be available for food design.

#### 37.2.1.3 *Total Quality and Monitoring of Hurdle Foods*

For well-designed foods, the microbial as well as the sensory quality are significant. To secure the total quality of a product, the safety and quality hurdles in foods must be kept in the optimal range. If the intensity of a particular hurdle in a food is too small, it should be strengthened; if it is detrimental for the total food quality, it should be lowered [18]. Well-designed hurdle-technology foods, if based on the hazard analysis critical control point (HACCP) concept, can be routinely produced without microbiological tests. But other process parameters have to be strictly controlled, and these are: time, temperature, pH, and  $a_w$  [7]. These measurements should be done online, or at least close to the line.

### **37.2.1.4 International Interest in Hurdle Technology**

From 1994 to 2005, the author of this chapter has been invited to numerous countries to present lectures on hurdle technology or to consult various food industries on this subject. He has conducted these activities in Argentina, Australia, Austria, Belgium, Brazil, Chile, China, Denmark, Ecuador, France, Germany, Greece, Hungary, India, Israel, Italy, Japan, Lithuania, Malaysia, the Netherlands, New Zealand, Pakistan, Peru, Poland, Russia, Serbia, Spain, Switzerland, Taiwan, Thailand, Turkey, UK, USA, and Venezuela. In many of these countries, he has also been teaching these courses several times.

The concept of hurdle technology has different expressions in different languages. For instance, Hürden-Technologie (in German), Hurdle Technology (in English), Technologie des Barrières (in French), Barjernaja Technologija (in Russian), Technologia Plotków (in Polish), Tehnologija Prepreka (in Serbian), Tecnologia degli Ostacoli (in Italian), Tecnologia de Obstaculos (in Spanish), Zanglangishu (in Chinese), and Shogai Gijutsu (in Japanese).

### **37.2.1.5 Reviews on Hurdle Technology**

The principles and applications of hurdle technology have been published in numerous articles, chapters of books, proceedings of conferences, four encyclopedias, and one comprehensive book. Few examples should be mentioned: an early example is a compendium on *Food Design by Hurdle Technology and HACCP* [14]. This is a “picture book” on the subject in English (62 pages, 22 color pictures), which was printed by the Adalbert Raps Foundation (Kulmbach, Germany) and has been distributed by request to more than 5000 food scientists and technologists worldwide. The European Commission supported a FLAIR Concerted Action on *Food Preservation by Combined Processes*. To this action 13 scientists from 11 European countries contributed and 2000 copies of their Final Report [4] were distributed by request. Often-quoted chapters of books are *Combined Methods for Food Preservation* [21] and *Use of Combined Preservative Factors in Food of Developing Countries* [22]. Reviews of food preservation based on hurdle technology have been published in four encyclopedias [23–26]. Recently, the first comprehensive book on *Hurdle Technologies: Combination Treatments for Food Stability, Safety and Quality* has been published [27]. Most recent is the chapter *Update on Hurdle Technology Approaches to Food Preservation* [28].

## **37.2.2 Recent Applications of Hurdle Technology**

In the past 15 years several new processes and products, based on deliberate and intelligent application of hurdle technology in food preservation, have emerged. Some examples will be mentioned.

### **37.2.2.1 Provisions for the Army**

At the Federal Centre of Meat Research, Kulmbach, Germany, ready-to-eat and ambient-stable meat products, which have fresh-like characteristics, were developed in cooperation with the meat industry for the German army. The Federal Centre asked German processors to name meat products that taste like those bought in delicatessen shops but need no refrigeration; 24 manufacturers named 100 of their products, and 75 proved stable and safe unrefrigerated. These products were scrutinized for their physical, chemical, microbiological, and technological characteristics. On this basis eight categories (product groups) were distinguishable, with a stability and safety based on different principles of hurdle technology. The technology of these products was improved and their processing standardized using the HACCP concept. With the permission of the German army the results have been published [29–31].

The principles and applications of hurdle technology were introduced to India by Leistner in 1995, and again in 1997 in the Defence Food Research Laboratory (DFRL) located in Mysore, India. A national seminar on *Food Preservation by Hurdle Technology* was held, and the proceedings were published [32]. In this seminar, the preservation of various foods based on hurdle technology was discussed. Proceedings from further national seminars, which were held in India on this subject, are not generally available since the results were rated as confidential.

### 37.2.2.2 Fusion Foods of China

A new category of meat products emerged and increased rapidly in China in the 1990s, which might be called *fusion foods* [33], because they have been derived from German minimal-processed, ambient-stable, autoclaved sausages called F-SSP, but have been adopted to suit meat processing in China. The German F-SSP are hurdle products, since they are only mildly heated to  $F=0.4$  in counterpressure autoclaves, and their water activity is adjusted to  $a_w$  below 0.97 or 0.96 [14]. In China, counterpressure autoclaves were not available and it was also not yet feasible to adjust the  $a_w$  of sausages. The Chinese fusion meats are called *retort sausages* or *ham sausages*, they are emulsion-type products to which 5%–10% starch, 3%–5% soy protein, 0.3%–0.5% carrageen, and 0.3%–0.5% polyphosphates are added, and they are heated at retort temperatures of 115°C–120°C for 20–30 min to achieve a shelf life at ambient temperatures for at least 6 months. Retort sausages are high-volume and low-cost foods, which amount today to 30%–50% of all processed meats consumed in China.

### 37.2.2.3 Novel Fruit Preservation

Fruits are an important and abundant food commodity in Latin America. Therefore, researchers there have concentrated on improvements in the preservation of tropical and subtropical fruits, especially as high-moisture products by using combined preservative factors (hurdle technology). The objectives were to develop simple, inexpensive, energy-efficient processes for the local fruit industry, which could overcome the seasonal production constraints and reduce post-harvest losses. The main goal was to preserve fruits in fresh-like condition even if stored for several months without refrigeration. Alzamora et al. [34] have suggested five hurdles for the preservation of high-moisture fruit products (HMFP): (1) mild heat treatment (to inactivate enzymes and lower the initial microbial load); (2) slight reduction of  $a_w$  (by addition of sucrose or glucose); (3) pH adjustment if necessary (by addition of citric or phosphoric acid); (4) addition of preservative I (potassium sorbate or sodium benzoate); and (5) addition of preservative II (sodium sulfite or bisulfite) in moderate amounts. This process results in stable and safe fresh-like products storable for at least 3–8 months (i.e., from one harvest peak to the next) at ambient temperatures by using modest packaging. If these hurdle-preserved fruits are stable they even autosterilize during storage, due to metabolic exhaustion. HMFP are an attractive alternative to conventional fruit preservation. More recently, Latin American researchers reported on fundamental aspects and applications of minimally processed fruits and vegetables, and discussed additional hurdles such as high hydrostatic pressure and natural antimicrobials for fruit preservation [35].

## 37.2.3 Design of Hurdle-Technology Foods

The application of hurdle technology is useful for the optimization of traditional foods as well as in the development of novel products. There are similarities to the concepts of predictive microbiology and HACCP. These three concepts have related but different goals: hurdle technology is primarily used in food design, predictive microbiology for process refinement, and HACCP for process control. In product development, these three concepts should be combined. Thus, for the design of hurdle-technology foods a 10-step procedure, which includes all the three concepts, has been suggested, and this approach proved suitable when solving real product-development tasks in the food industry [36]. However, these 10 steps should still be considered tentative until further practical experience with the application of the suggested user guide for food design has accumulated in the food industry.

### 37.2.3.1 Steps of Food Design

The following steps are suggested for food design using an integrated concept comprising hurdle technology, predictive microbiology, and HACCP:

1. For the modified or novel food product the desired sensory properties and the desired shelf life are tentatively defined.
2. A feasible technology for the production of this food must be outlined.

3. The food is manufactured according to this technology, and the resulting product is analyzed for pH,  $a_w$ , preservatives, and other inhibitory factors. Temperature for heating (if intended) and storage as well as the expected shelf life are defined.
4. For testing the preliminary microbial stability of the food product, predictive microbiology might be employed.
5. The product is challenged with toxigenic and spoilage microorganisms using somewhat higher inocula and storage temperatures than would be “normal” for this food.
6. If necessary, the hurdles in the products are modified, taking multitarget preservation and the sensory quality of the food (i.e., total quality) into consideration.
7. The food is again challenged with relevant microorganisms and, if necessary, the hurdles in the food are modified again. Predictive microbiology for assessing the safety of the food might be helpful at this stage too.
8. After the established hurdles of the modified or novel foods are exactly defined, including tolerances, the methods for monitoring the process are agreed upon. Preferably, physical methods should be used for monitoring.
9. The designed food should now be produced under industrial conditions, because the possibilities for a scale-up of the proposed manufacturing process must be validated.
10. For the industrial process the critical control points (CCPs) and their monitoring must be established, and therefore the manufacturing process should be controlled by HACCP. If HACCP is not appropriate, guidelines for the application of manufacturing control by good manufacturing practice (GMP) must be defined.

In food design, different researchers, including microbiologists and technologists, must work together. The microbiologists should determine which type and intensity of hurdles are needed for the necessary safety and stability of a particular food product, and the technologist should determine which ingredients or processes are proper for establishing these hurdles in a food, taking into account the legal, technological, sensory, and nutritive limitations. Because the engineering, economic, and marketing aspects must also be considered, food design is indeed a multidisciplinary endeavor [7,14].

### 37.2.3.2 Shelf-Life Prediction of Hurdle Foods

Predictive microbiology attempts to describe the effects of environmental conditions on the growth, survival, and death of microorganisms. Most models used in the past in predictive microbiology have been *inactivation models* to predict the death of microorganisms, in particular bacterial spores, caused by heat, disinfectants, radiation, etc. It is only in the last two decades that *kinetic models* have been developed to predict the growth of food poisoning and recently also of food spoilage microorganisms. Kinetic models have been very useful, especially for predicting the safe shelf lives of chill-stored foods; however, they are less useful close to the boundary between growth and no growth, and less useful therefore for establishing the conditions necessary for long ambient stability [37]. More recently, therefore, increasing attention has been given to the development of models that allow prediction of the probabilities of growth under different conditions and of models that allow predictions of growth–no growth boundaries or the growth–no growth interface, as pointed out by Ratkowsky and Ross [38]. Such *boundary* or *probability models* are of particular significance for ambient-stable hurdle-technology foods, and they should be applied to food poisoning as well as to spoilage microorganisms. For example, McKellar and Lu [39] developed a probability of growth model for *Escherichia coli* O157:H7 as a function of temperature, pH, NaCl, and acetic acid that correctly predicted growth in 99%—no growth of 1820 treatment combinations. Because spoilage yeasts are often tolerant microorganisms in low-pH, low- $a_w$  foods they have been important targets for recent probability and boundary modeling (e.g., by López-Malo et al. [40]). The recent increase in interest in boundary modeling is to be welcomed because it is highly supportive of the development of many hurdle-technology preservation systems, and in particular those that aim to generate safe and stable foods that are intended to have long ambient-stable shelf lives [28,41].

---

### 37.3 Conclusions

The concept of hurdle technology for mild and effective preservation of a variety of foods has attracted much attention in industrialized as well as developing countries, and probably it will be employed increasingly in future food preservation. In a book on *Antimicrobials in Food* (3rd edition), which has been published in 2005 by CRC Press, the authors (P. M. Davidson, J. N. Sofos, and A. L. Branen) stated in their Preface: "More research is needed on the effectiveness of antimicrobial combinations and antimicrobials in combination with physical methods (e.g., hurdle technology) that are effective against different groups of microorganisms. Combinations could well be the ideal antimicrobial for which everyone is searching."

---

### References

1. Leistner, L., Hurdle effect and energy savings, in *Food Quality and Nutrition*, Downey, W.K., Ed., Appl. Sci. Publishers, London, 1978, p. 553.
2. Leistner, L., Rödel, W., and Krispien, K., Microbiology of meat products in high- and intermediate-moisture range, in *Water Activity: Influence on Food Quality*, Rockland, L.B. and Stewart, G.F., Eds., Academic Press, New York, 1981, p. 855.
3. Leistner, L., Hurdle technology applied to meat products of the shelf stable product and intermediate moisture food types, in *Properties of Water in Foods in Relation to Quality and Stability*, Simatos, D. and Multon, J.L., Eds., Martinus Nijhoff Publishers, Dordrecht, 1985, p. 309.
4. Leistner, L. and Gorris, L.G.M., Eds., *Food Preservation by Combined Processes*, FLAIR Final Report, Concerted Action No. 7, Subgroup B, EUR 15776 EN, European Commission, Directorate-General XII, Brussels, 1994, 100pp.
5. Leistner, L. and Gorris, L.G.M., Food preservation by hurdle technology, *Trends Food Sci. Technol.*, 6, 41, 1995.
6. Leistner, L., Food preservation by combined methods, *Food Res. Int.*, 25, 151, 1992.
7. Leistner, L., Principles and applications of hurdle technology, in *New Methods of Food Preservation*, Gould, G.W., Ed., Blackie Academic & Professional, London, 1995, p. 1.
8. Leistner, L., Vukovic, I., and Dresel, J., SSP: meat products with minimal nitrite addition, storable without refrigeration, in *Proc. 26th Eur. Meeting Meat Res. Workers*, vol. II, Colorado Springs, 1980, p. 230.
9. Leistner, L., Basic aspects of food preservation by hurdle technology, *Int. J. Food Microbiol.*, 55, 181, 2000.
10. Gould, G.W., Interference with homeostasis—food, in *Homeostatic Mechanisms in Micro-organisms*, Whittenbury, R., Gould, G.W., Banks, J.G., and Board, R.G., Eds., Bath University Press, Bath, 1988, p. 220.
11. Häussinger, D., Ed., *pH Homeostasis: Mechanisms and Control*, Academic Press, London, 1988, p. 479.
12. Gould, G.W., Homeostatic mechanisms during food preservation by combined methods, in *Food Preservation by Moisture Control, Fundamentals and Applications*, Barbosa-Cánovas, G.V. and Welti-Chanes, J., Eds., Technomic, Lancaster, 1995, p. 397.
13. Leistner, L. and Karan-Djurdjic, S., Beeinflussung der Stabilität von Fleischkonserven durch Steuerung der Wasseraktivität, *Fleischwirtschaft*, 50, 1547, 1970.
14. Leistner, L., *Food Design by Hurdle Technology and HACCP*, Adalbert Raps Foundation, Kulmbach (Germany), 1994, 62pp.
15. Alzamora, S.M., Cerrutti, P., Guerrero, S., and López-Malo, A., Minimally processed fruits by combined methods, in *Food Preservation by Moisture Control, Fundamentals and Applications*, Barbosa-Cánovas, G.V. and Welti-Chanes, J., Eds., Technomic, Lancaster, 1995, p. 463.
16. Tapia de Daza, M.S., Argaiz, A., López-Malo, A., and Díaz, R.V., Microbial stability assessment in high and intermediate moisture foods: special emphasis on fruit products, in *Food Preservation by Moisture Control, Fundamentals and Applications*, Barbosa-Cánovas, G.V. and Welti-Chanes, J., Eds., Technomic, Lancaster, 1995, p. 575.
17. Leistner, L., Emerging concepts for food safety, in *Proc. 41st Int. Congress Meat Sci. Technol.*, San Antonio, 1995, p. 321.
18. Leistner, L. Further developments in the utilization of hurdle technology for food preservation, *J. Food Eng.*, 22, 421, 1994.

19. Barbosa-Cánovas, G.V., Pothakamury, U.R., Palou, E., and Swanson, B.G., *Nonthermal Preservation of Foods*, Marcel Dekker, New York, 1998, p. 276.
20. Denyer, S.P. and Hugo, W.B., Eds., *Mechanisms of Action of Chemical Biocides, Their Study and Exploitation*, Blackwell Scientific Publications, Oxford, 1991, 343pp.
21. Leistner, L., Combined methods of food preservation, in *Handbook of Food Preservation*, 1st ed., Rahman, M. S., Ed., Marcel Dekker, New York, p. 457.
22. Leistner, L., Use of combined preservative factors in foods of developing countries, in *The Microbiological Safety and Quality of Food*, vol. I, Lund, B.M., Baird-Parker, A.C., and Gould, G.W., Eds., Aspen Publishers, Gaithersburg, 2000, p. 294.
23. Leistner, L., Hurdle technology, in *The Wiley Encyclopedia of Food Science and Technology*, 2nd ed., vol. I, Francis, F.J., Ed., Wiley, New York, 1999, p. 1302.
24. Gorris, L.G.M., Hurdle technology, a concept for safe, minimal processing of foods, in *Encyclopedia of Food Microbiology*, Robinson, R.K., Batt, C.A., and Patel, P.D., Eds., Academic Press, London, 1999, p. 1071.
25. Leistner, L., Hurdle technology (EOLSS contribution 5.10.4.12), in *Food Engineering, Encyclopedia of Life Support Systems*, Barbosa-Cánovas, G.V., Ed., EOLSS Publishers/UNESCO, Paris, 2005, p. 595.
26. Leistner, L., Hurdle technologies, in *Encyclopedia of Meat Science*, Jensen, W.K., Devine, C., and Dikeman, M., Eds., Elsevier, Oxford, 2004, p. 640.
27. Leistner, L. and Gould, G.W., *Hurdle Technologies: Combination Treatments for Food Stability, Safety and Quality*, Kluwer Academic/Plenum Publishers, New York, 2002, 194pp.
28. Leistner, L. and Gould, G.W., Update on hurdle technology approaches to food preservation, in *Antimicrobials in Food*, 3rd ed., Davidson, P.M., Sofos, J.N., and Branan, A.L., Eds., CRC Press, Boca Raton, 2005, p. 621.
29. Hechelmann, H., Kasprowiak, R., Reil, S., Bergmann, A., and Leistner, L., *Stabile Fleischerzeugnisse mit Frischprodukt-Charakter für die Truppe*, BMVg FBWM 91-11, Dokumentations- und Fachinformationszentrum der Bundeswehr, DOK/Bw/0050/82, Bonn, Germany, 1991, 129pp. (in German).
30. Leistner, L. and Hechelmann, H., Food preservation by hurdle technology, in *Proc. Food Preservation 2000, Conference on Integrating Processing, Packaging, and Consumer Research*, vol. II, U.S. Army Natick Research, Development and Engineering Center, Natick, 1993, p. 511.
31. Leistner, L., Minimally processed, ready-to-eat and ambient-stable meat products, in *Shelf-Life Evaluation of Foods*, 2nd ed., Man, C.M.D. and Jones, A.A., Eds., Aspen Publishers, Gaithersburg, 2000, p. 242.
32. Defence Food Research Laboratory (DFRL), Preservation of food by hurdle technology, in *Proc. National Seminar on Food Preservation by Hurdle Technology and Related Areas*, DFRL, Mysore, and Defence R&D Organisation, Ministry of Defence, Government of India, 1999, 189pp.
33. Leistner, L., Update on hurdle technology, in *Engineering and Food for the 21st Century*, Welti-Chanes, J., Barbosa-Cánovas, G.V., and Aguilera, J.M., Eds., CRC Press, Boca Raton, 2002, p. 615.
34. Alzamora, S.M., Tapia, M.S., Argáiz, A., and Welti, J., Application of combined methods technology in minimally processed fruits, *Food Res. Int.*, 26, 125, 1993.
35. Alzamora, S.M., Tapia, M.S., and López-Malo, A., Eds., *Minimally Processed Fruits and Vegetables, Fundamental Aspects and Applications*, Aspen Publishers, Gaithersburg, 2000, 360pp.
36. Leistner, L., User guide to food design, in *Food Preservation by Combined Processes*, Leistner, L. and Gorris, L.G.M., Eds., Final Report of FLAIR Concerted Action No. 7, Subgroup B, EUR 15776 EN, European Commission, Directorate-General XII, Brussels, 1994, p. 25.
37. Baranyi, J. and Roberts, T.A., Principles and application of predictive modeling of the effects of preservative factors on microorganisms, in *The Microbiological Safety and Quality of Food*, vol. I, Lund, B.M., Baird-Parker, T.C., and Gould, G.W., Eds., Aspen Publishers, Gaithersburg, 2000, p. 342.
38. Ratkowsky, D.A. and Ross, T., Modelling the bacterial growth/no growth interface, *Lett. Appl. Microbiol.*, 20, 29, 1995.
39. McKellar, R.C. and Lu, X., A probability of growth for *Escherichia coli* O157:H7 as function of temperature, pH, acetic acid, and salt, *J. Food Prot.*, 64, 1922, 2001.
40. López-Malo, A., Guerrero, S., and Alzamora, S.M., Probabilistic modeling of *Saccharomyces cerevisiae* under the effects of water activity, pH, and potassium sorbate concentration, *J. Food Prot.*, 63, 91, 2000.
41. McMeekin, T.A., Presser, K., Ratkowsky, A.D., Ross, T., Salter, M., and Tienungoon, S., Quantifying the hurdle concept by modelling the bacterial growth/no growth interface, *Int. J. Food Microbiol.*, 55, 93, 2000.

## **Part 5**

# **Enhancing Food Preservation by Indirect Approach**





---

## *Packaging as a Preservation Technique*

---

**Mohammad Shafiur Rahman**

### **CONTENTS**

38.1	Introduction .....	907
38.2	Packaging and Preservation.....	908
38.2.1	Purpose of Packaging.....	908
38.2.1.1	Product Containment .....	908
38.2.1.2	Preservation by Maintaining Quality .....	908
38.2.1.3	Presentation and Convenience .....	910
38.2.1.4	Protection during Distribution and Processing .....	911
38.2.1.5	Provide Storage History .....	912
38.2.2	Ideal Packaging .....	912
38.2.3	Types of Packaging Materials .....	913
38.3	Environmental Issues.....	913
38.3.1	Environmental Damage .....	913
38.3.2	Reuse .....	913
38.3.3	Recycle.....	913
38.3.4	Reduce .....	914
38.4	Future Direction .....	914
	References .....	914

---

### **38.1 Introduction**

Packaging has been with humans for thousands of years in one form or the other. Packaging dates back to when people first started moving from place to place. Originally, skins, leaves, and bark were used for food transport. Mesolithic humans used baskets, and neolithic humans used metal containers and discovered pottery. Four thousand years ago, sealed pottery jars were used to protect against rodents, and in 1550 BC, glass making was an important industry in Egypt. Tin-plating iron became possible in AD 1200, and as steel replaced iron this method became useful after AD 1600. In 1825, Oersted first extracted aluminum [7]. The Greek and the Roman times saw the rise of pottery and the use of glass. In the 1400s, timber chests were first used, and after 1850 paper and glass started to be used substantially as processes were developed for mass production. Napoleon Bonaparte was involved in the invention of canning. More recently, plastics were developed, particularly the first commercial plastics in the United States around 1935–1942 [7].

One hundred years ago there was little use for packaging in the food industries. Now, tremendous progress has been made in the development of diversified packaging materials and in the packaging equipment. Over the last three decades, packaging has grown in volume and importance into one of the most significant areas of food production.

---

## 38.2 Packaging and Preservation

### 38.2.1 Purpose of Packaging

In addition to the direct approach to food preservation, such as drying and freezing, other measures such as packaging and quality management tools need to be implemented in the process to avoid contamination or recontamination. Although these measures are not preservation techniques, they can play an important role in producing high-quality safe food [23]. Packaging performs five main functions (5Ps): product containment, preservation and quality, presentation and convenience, protection, and provide storage history.

#### 38.2.1.1 Product Containment

The first function of packaging is its capability of containment. The primary purposes of packaging are containment and protection. It is self-explanatory; liquids, semiliquids, and powders, as well as bulk solids, cannot be marketed without suitable containers. According to the size of the package, different amounts of the product can be delivered to consumers suiting their choice and convenience [18]. In certain circumstances, quantification is mandatory, as in the case of medical pills or capsules that are marketed individually in a blister-type package. Containment refers to holding goods in a form suitable for transport, whereas protection refers to safekeeping goods in a way that prevents significant quality deterioration.

#### 38.2.1.2 Preservation by Maintaining Quality

The second function of packaging is to control the local environmental conditions to enhance storage life and safety. The main purpose of food packaging is to protect the product from surroundings and maintain the quality of the food throughout the product's shelf life. One means of spreading the product availability over time is by the proper use of packaging. Product shelf life is controlled by three factors: product characteristics, properties, and storage and distribution conditions of individual package [11]. Reactions causing deterioration in foods include enzymatic, chemical, physical, and microbiological changes. Additional problems include insects, pests, and rodents.

##### 38.2.1.2.1 Nutritional Quality

Packaging affects the nutritional quality of foods. Examples include peroxidation of polyunsaturated fats and destructive oxidation of nutrients such as ascorbic acid, tocopherols, vitamin A, folate, and riboflavin. Fatty acid peroxides are well established as causing health problems. As antioxidative nutrients such as vitamins C and E are lost, other food components become even more vulnerable to oxidation. Carotenoid pigments can also be oxidized, leading to loss of color as well as loss of their beneficial effects in the body. Lipid hydroperoxides can also result in the formation of aldehydes and other compounds with off-flavors. Such peroxides can act as free radicals that, in turn, can damage other food components such as proteins [1].

Light induces photodegradation and causes loss of vitamins, especially riboflavin (which also acts as a photosensitizer),  $\beta$ -carotene, and vitamin C; production or degradation of free amino acids; increase of peroxide value; formation of sensory unpleasant volatile compounds (methional, aldehydes, and methyl ketones) as well as color changes [2]. Oxidative rancidity occurs when oxygen reacts with unsaturated fatty acids either spontaneously on exposure to air (autoxidation) or in the presence of light and sensitizer (photosensitized oxidation) such as chlorophyll or myoglobin. Among all other functions of packaging, the protection of foodstuffs against light plays a key role particularly during storage, transport, and sales display. Visible light covers a wavelength range of 380–700 nm and ultraviolet (UV) light a range of 200–380 nm. Photodegradative processes induced by UV light should be given priority because of its high energy content, which is capable of splitting certain chemical bonds. Fluorescent light can initiate photooxidation in foods. In addition to light barriers, use of UV absorber in the packaging material can decrease lipid oxidation [19].

##### 38.2.1.2.2 Barrier Properties

To achieve the best from packaging (i.e., optimum), it is important to know product characteristics, properties of individual package, storage, and distribution conditions [21]. The knowledge of product characteristics and conditions of storage and distribution dictate the required barrier properties of the

packaging materials used for a specific application. Barrier properties include permeability of gases (such as oxygen, carbon dioxide, nitrogen, and ethylene), water vapor, aromas, and light. These are vital factors for maintaining the quality of foods. However, packaging materials cannot be chosen solely on the basis of their barrier properties. Factors such as processability, mechanical properties (tensile strength, elongation, tear strength, puncture resistance, friction, burst strength, etc.), and chemical resistance and interaction with product must also be taken into account [21]. Environmental factors, such as temperature, relative humidity, and light intensity to which the product is exposed during storage and distribution, must also be taken into consideration when selecting packaging materials. Transportation damage may occur to the product due to the vibration and other stresses during transport. The extent of such damage can be reduced by proper packaging, such as introducing padding and support, and by adjusting the distribution pattern according to the transported product [21].

The current packaging techniques perform more on the preservation by direct interactions with the product. Earlier food packaging materials used to provide only barrier and protective functions. Now various types of active substances can be incorporated into the packaging material to improve its functionality and give it new or extra functions. Such active packaging technologies are designed to extend the shelf life of foods, while maintaining their nutritional quality and safety. Active packaging technologies involve interactions between the food, the packaging material, and the internal gaseous atmosphere [15]. In some cases, the new concept of active or life packaging material allows a one-way transfer of gases away from the product or the absorption of gases detrimental to the product.

Many packaged foods contain active enzymes and other materials, which could perform or simulate living system, such as respiration. Indeed the benefits of controlled atmospheres with less oxygen and more carbon dioxide result in part from slowing down the effects of these enzyme systems. The carbon dioxide is sometimes generated within the package by enzymatic action. If there is gas exchange across the packaging plastic, the benefits of the effect are diminished [1]. Ethylene affects the physiological processes of plants. As a plant hormone, ethylene regulates many aspects of growth development and senescence, and is physiologically active in trace amounts ( $<0.1$  ppm). It is a natural product of plant metabolism and is produced by all tissues of higher plants and by some microorganisms. Moreover, nonethylene and non-respiratory organic volatiles may also have physiological and quality efficiency [9]. Thus, packaging can also play a part either by absorbing ethylene (or other volatiles) or preferential transmission of this gas.

Smart packaging with antimicrobial adds a dimension to safety [14]. The extra functions they provide include oxygen scavenging (absorb oxygen gas in the package and prevent rancidity, and are being developed as forms of sachets or polymer additives), antimicrobial activity, moisture scavenging, ethylene scavenging, and ethanol emitting [10]. Floros et al. [8] reviewed existing active packaging products and patents. Now it is possible to tailor the atmosphere to suit the needs of the food product inside the package. Indeed, the package itself can be the main regulator of atmospheric conditions within the headspace. The modified atmosphere could provide consumers' benefits, including quality retention, additive reduction, fumigant elimination, and matching today's busy lifestyle by providing fresh, ready-prepared, take-home meals.

### 38.2.1.2.3 Antimicrobial Packaging

Antimicrobial packaging is a promising form of active food packaging. When antimicrobial agents are incorporated into a polymer, the material limits or prevents microbial growth. This application could be used for foods effectively, not only in the form of films but also as containers and utensils. The incorporation of antimicrobial agents with polymeric packaging provides an economic and laborless way to solve the food surface contamination problems [27]. Food packaging materials may obtain antimicrobial activity by common antimicrobial substances, radiation, or gas emission/flushing. Radiation methods may include the use of radioactive materials, laser-excited materials, UV-exposed films, or far-infrared-emitting ceramic powders. Irradiation sterilization of food packaging materials is not yet permitted by the FDA [10]. A variety of films can be made with antimicrobial activities and various degrees of clarity for use as food packaging. An extensive list of antimicrobial agents used in packaging materials is given by Han [10]. One of the new technologies expected to enhance plastic film barriers to gases and vapors is glass (silica)-coated plastics or the use of other ultrathin coatings, such as diamond, or other chemically treated surfaces [25]. The development of coated packaging materials, which absorb or block the ingress of taints during container transport of food to export markets, will be of particular benefit.

Active and intelligent packaging is still largely a research field, but some manufacturers have already developed sachets of substances, which can change the atmosphere inside the package, such as oxygen scavengers. Oxygen removal is not always easy. Oxygen removal can be mechanical, but air in the packaging materials or residual oxygen cannot be effectively removed in many cases. Conventional oxygen scavenging is too slow to retard the changes in many products. Oxygen scavenging system can also be incorporated in plastic package and, thus forms an integral part of its structure. There are significant technical and commercial advantages in not having to insert sachets or attach labels to trays or bags. It has the advantage of being activated just prior to use. The package can be manufactured and stored under standard conditions, then triggered to an activated state prior to filling. Inhibition of lipid oxidation in fish muscle can be done by packing antioxidant-incorporated polyethylene film [12]. Oxygen scavengers can also be added in the cap of a glass container.

Different foods require different packaging solutions. For example, the deterioration of product quality in bakery products is due to crystallization of starch granules, causing staling; moisture uptake, causing a reduction in crispness; mold growth, as bakery products typically have a high moisture content; and rancidity from exposure of lipids to oxygen, drying out of the interior (crumb) of a loaf of bread. The main forms of packaging for bakery products have distribution rather than protection as their primary objective. Product quality is ensured by specifying short shelf life. For example, bread should be consumed as quickly as possible. It is difficult to specify a packaging material for bread that could meet the competing requirements of keeping the crust dry and the crumb moist. Furthermore, moisture movement from starch to protein within the crumb leads to texture changes as the bread ages. Since the shelf life is short, the goal of bread packaging is partially moisture control, but its main purpose is to allow the product to be distributed safely and hygienically. The material used should be inexpensive, as bread is a staple. Materials such as waxed paper, cellophane, and polyethylene are commonly used in bread packaging. Bread was one of the first mass products to be packaged in plastic bags, and it is the largest single domestic consumer product to go into plastic packaging. For many bakery products, even this level of packaging is excessive. Cakes and pastries are often distributed in cardboard boxes that are not airtight, made possible with a waxed paperboard support. Packages containing pies must have air holes, so that the package can “breathe” moisture during heating or cooling, preventing crust uptake of moisture [7].

#### 38.2.1.2.4 *Edible Film*

Edible antimicrobial films are a particularly promising development. Edible coatings can inhibit growth of microflora themselves, and these films also offer the opportunity to provide high concentrations of antimicrobials at food surfaces. Edible films may also be used to overcome some of the difficulties in maintaining modified atmospheres around packaged ripening produce. The ratio of the permeabilities of the film to carbon dioxide and oxygen can be crucial [25]. Enzyme-generated biofilms for packaging fresh food can be developed from cross-links of proteins [24].

#### 38.2.1.3 *Presentation and Convenience*

The third function is the presentation and convenience. In many cases, these are most important factors to the consumers.

##### 38.2.1.3.1 *Presentation*

Food labels are intended by law to provide the information that consumers need to be able to make the necessary decisions about those purchases of food. It is important to display the product in an attractive manner to the potential buyer. A cleverly designed and beautifully produced packaging can help sell a product, which is an essential ingredient of an effective marketing campaign. The packaging helps in distinguishing products on the shelf, which is a trait especially important when marketing low-fat or nutritional products. Furthermore, packaging must address communication, legal, and commercial demands. For a package to be effective, it must present the product well and should do its own publicity. The protective packaging may have flaps that can be opened to give a ready-made display for the product, whereas some stores may remove the protective packaging to display the product directly on the shelves, leading to a preference for rectangular containers. The clarity (haze) and gloss optical characteristics are important in packaging presentation.

### 38.2.1.3.2 Convenience

In many cases, packaging provides convenience to the consumers, for example, paper carton for milk or juice with an ease-open and easy-pour cap, thus can also increase consumption. Changes in society, such as diminishing population pattern, increasing average age, smaller families, more leisure time, as well as improvements in the quality of life, standard of living, and general level of education, may also demand specific function of packaging [6]. Eating styles, such as ready-to-eat meals, snacks, and microwavable ready meals, have been changed over the years, which need innovation in packaging. For children, the packaging might represent innovation or fun [22]. Today's consumer wants to buy food that is ready to eat, or needs a minimum of preparation, and is good value for money [4]. With microwave food preparation increasing, there is a need for the packaging industry to confront the particular problems in designing packages that deliver microwave products to the dinner table. Food processors can accelerate the usage of microwave ovens by designing products and packages that use the phenomenon of microwave heating/cooking to provide quality [20]. Two types of materials, transparent to microwave and reflective to microwave, can affect the cooking. The transparent materials are nonmetallic substances, such as ceramics, that are coated or filled with microwave absorbent materials. The reflective category is composed of all devices that are metallic and absorb heat [20].

Packaging should meet the future demand of meeting eating style of the society. Other conveniences could be ease of opening, smaller portions, reclosable, and tamper-proof methods. Consumers want tamper-evident closures to avoid packaging being opened unnoticed. In general, tamper-proof packaging makes products more difficult to open, so there is clearly a need to balance safety with consumer accessibility [6]. The tamper-resistant package is to alert the consumer that tampering has taken place and provide visible evidence of tampering. In many cases, consumers are ready to pay more for tamper-resistant packaging. Tampering can be classified into four categories: two for kind of tampering and two for location of tampering [16].

Casual tampering or grazing happens in the store. The tamperer wants to taste or smell or change price by changing caps, but probably does not intend to do harm. Malicious, surreptitious tampering occurs outside the store at home or in a workshop. The tampered package may be returned to the store shelves. In case of normal route of entry, the tamperer opens the package and recloses it using the cap or the tear strip or the tear out easy-open end. A casual tamperer would do this, but a malicious tamperer might not do so. In case of evasive route of entry, the tamperer opens and recloses the package by any means other than the cap, or the tear strip. The intended route of entry and, therefore, the tamper-resistant feature are left undisturbed [16].

Value-added packaging allows in-package cooking and facilitates on-the-go consumption. Self-heating containers are also being developed for the convenience of consumers, who do not need to reheat the product during consumption. In a system described by Webb [26], an exothermic reaction takes place with crushed limestone and the heating process begins. Users feel the heat of the container 2–3 min after pushing a button on the bottom surface of the can, and the container heats fully within 5 min.

### 38.2.1.4 Protection during Distribution and Processing

The fourth function is to protect the product during transit to the consumer. Packaging is part of the distribution process necessary to deliver goods to the consumer and facilitate handling and transportation. It also has affected international trade by making shipping of food products possible, allowing seasonal products to be more accessible out of season. Packaging can handle better when there are challenges in food distribution chain, such as heat, humidity, or dew. It is important to be aware of the distribution challenges and designing of package to suit it.

In case of prepacked product, it should have the ability to stand the severity or type of process conditions, such as flexible packaging during canning, microwavable foods, ovenable, and retortable foods. Irradiated foods are usually prepacked prior to treatment by ionizing radiation, which prevents recontamination. Packaging materials are also exposed to radiation during treatment, though in this instance it can lead to radiation-induced degradation of the packaging material, followed by interaction between the material and food product [6].

Protective packaging is a term applied to packaging primarily designed to protect the goods, rather than for appearance or presentation, so it is generally used to apply to the outer containers used for transporting

goods from the manufacturer to the point of sale, and filling materials inside the outer containers, e.g., nylon barrier-sealed bubble packaging (computer parts), urethane expanding foam, PE foam package “cushions,” and PS loose-fill packaging. The most widely used protective package is the outer carton. All packaging is protective as one of its primary functions, so it is more accurate to call this transport packaging or tertiary packaging (on the basis of the primary packaging in contact with the product, secondary for grouping units together for single purchase, and tertiary being for grouping secondary packaging for convenience distribution). A pallet is the frame base for carrying the transport packs [7]. The primary packages are put into cartons and the sealed cartons are transported through specialized conveyors, allowing products from different processing lines and sorted onto individual product pallets. Another aspect of protective packaging involves primary packaging designed to prevent anyone from opening the package before purchase. Cases of extortion or sabotage are also reported. In the mid-1970s, child-resistant packaging became an issue, leading to the development of childproof lids for poisonous products. Tamper-resistant refers to the ability of the packaging to resist tampering (or opening), e.g., for child protection, whereas tamper-evident refers to the ability of the packaging to reveal that it has been opened [7].

#### **38.2.1.5 Provide Storage History**

Time-temperature indicator (TTI) is effective for predicting microbial concentrations and other parameters of food quality during shipping and storage. It helps in ensuring proper handling and provides a gauge of product quality for sensitive products in which temperature control is imperative to efficacy and safety. TTIs are tags that can be applied to individual packages or shipping cartons to visually indicate whether a product has been exposed to time and temperature conditions that adversely affect the product quality. TTI could be used in chilled foods to identify the temperature abuse during storage and distribution.

According to the response mechanisms, TTIs can be divided into three groups: (i) biological, (ii) chemical, and (iii) physical systems. One of them is the use of enzyme-based TTIs to monitor and predict shelf life of products. The tags are available in a one-dot version and a three-dot version with the three dots changing color at different rates. The change of color of the dot indicates the exposed time and temperature of the product [17]. There is considerable potential for use of TTIs in the food distribution chain, but there are two issues to be considered. One is the economics. When using a TTI for a relatively low-cost product, such as lettuce, the indicator also has to be relatively low in cost. This should be considered or addressed by the manufacturer of the indicator. The other issue is knowledge of the food product. The food processor must know the degradation kinetics of his product—how the quality characteristics of his product are changing with time and temperature exposure—so that he can select the indicator that matches it [17].

#### **38.2.2 Ideal Packaging**

There is no such thing as the ideal packaging. Packaging should be such that we could come close to the ideal and the criteria of ideal packaging are listed as [7]

- Zero toxicity
- High product visibility
- Strong marketing appeal
- Ability of moisture and gas control
- Stable performance over a large temperature range
- Low cost and availability
- Suitable mechanical strength (i.e., strength in compression, wear, and puncture characteristics)
- Easy machine handling and suitable friction coefficient
- Closure characteristics, such as opening, sealing and resealing, pouring
- Ability to include proper labeling
- Resistance of migration or leaching from package
- Protection from loss of flavor and odor
- Controlled transmission of required or unwanted gases

### 38.2.3 Types of Packaging Materials

From skins, leaves, and bark, tremendous progress has been made in the development of diversified packaging materials and in the packaging equipment. In general, packaging materials may be grouped into rigid and flexible structures. Plastic film, foil, paper, and textiles are flexible materials; whereas wood, glass, metals, and hard plastics are examples of rigid materials.

---

## 38.3 Environmental Issues

### 38.3.1 Environmental Damage

Recently, a new dimension of safety has arisen, the ecological dimension. This means that packaging has not only to satisfy physical, chemical, and biological criteria using their life cycle as packaging, but once the original function has been fulfilled the packaging should decay without polluting the environment (passive protection function). The presence of plastics in the habitat of wildlife on both land and sea has created issues, which are being vigorously exploited by the environmental lobby to demand solutions from the plastic industry [13]. Thus, overall environmental safety is demanded from packaging material disposal. Global environment protection and resource saving pressures (environmental issues are becoming increasingly important to the consumer) thus need to develop easily reusable, recyclable, easily disposable, or environment-friendly packaging.

### 38.3.2 Reuse

Reuse means using something again after its initial purpose has expired. Landfill is just one of the many methods of disposal. It is important to know the consequences of current methods of disposal of packaging. The present and future focus is to use materials that can be either recycled or burned without producing noxious fumes and use of printers' inks that do not contain heavy metals [3].

### 38.3.3 Recycle

After use, most of the plastic waste has traditionally been disposed into landfills, which in turn have led to serious environmental concerns. Other options are the recycling and reuse of postconsumer plastics, where contamination is the main concern. Package design utilizing a laminate whereby the food contact surface is a virgin layer placed over the recycled material means the virgin layer free of contaminants acts as a functional barrier. The worst-case scenario for contamination from recycled plastic in contact with food is where the package is 100% recycled, a monolayer with any contaminant evenly distributed and in direct contact with food [5]. The solutions proposed are recycling, incineration, composting, and environmental degradation. Thus, there is a need to develop enviopacks, biodegradable products, and especially recycling.

Regrind material can be sandwiched between other materials provided that the virgin plastic layer has sufficient barrier properties. The main difficulty then with reused plastics is the migration of contaminants into the food [7]. In many cases, energy requirement during recycling is also an important factor. PET bottles were 25% more energy efficient than glass and 65% more efficient than aluminum and had less impact on resources at all levels of possible recycling [7].

There is a growing pressure to recycle materials and for industry to use materials, which can be recycled. One of the many difficulties with recycling is that there is no control over how the consumer uses the container (e.g., for pesticides, chemicals), and the container may become contaminated. The ink on labels is also difficult to remove during recycling [7].

The problems for food contact use of recycled materials are initial sorting of waste into material/polymer types and proving that the collected materials are free from contamination that could prove harmful to the consumer [4]. In many cases, collection costs can be far greater than the potential market of these materials. Auditing recycling can provide ounce of prevention that can help in avoiding the complications of improper disposal and the resulting liabilities.



### 38.3.4 Reduce

Another consideration could be the reduction of the amount of packaging used for foods. It is important to use packaging in optimum level in addition to target only reuse and recycle. In many cases, the efficient preservation and distribution chain could reduce the amount of excessive packaging requirement for food.

---

## 38.4 Future Direction

The target is to satisfy most of the criteria mentioned earlier in the list of ideal packaging in the future. The choice of package is always a compromise between the desired objectives. Quality, safety, freshness, and convenience are expected to be the future targets in the development of food packaging. The future packaging trends are to develop package with the following characteristics: opening ease, smaller portions, safe to the consumers, environmental packaging, tamper-proof methods, and recloseable packaging [6]. Oxygen scavenging technology is merely in its infancy and it has the potential of becoming one of the most revolutionary advances in the packaging industry. The packaging should also give lifestyle benefits. Packaging plays an indispensable role in modern society, for without it many products could not reach consumers in sound condition. In all cases, the amount of packaging used should be optimum, thus need to avoid overpackaging. In future the question will arise. Who should pay for collection and sorting? Are products packaged excessively? Better management on the product shelf life can reduce its excessive packaging. Efficient distribution systems also need to be developed for an optimum packaging. There is a need to educate the consumer for understanding all aspects of food packaging and making them as a partner for future development. This could help in making the progress smooth and steady to achieve the target of safe packaging technology for the consumers.

---

## References

1. Birkbeck, J. 1998. Does packaging affect nutritional quality? *The Food Technologists* 28(4): 156–157.
2. Bosset, J.O., Gallmann, P.U., and Sieber, R. 1994. Influence of light transmittance of packaging materials on the shelf-life of milk and dairy products—A review. In *Food Packaging and Preservation*, M. Mathlouthi (Ed.), p. 223. Blackie Academic & Professional, Glasgow.
3. Brown, D. 1993. Plastics packaging of food products: The environmental dimension. *Trends in Food Science and Technology* 4: 294–300.
4. Campbell, A.J. 1994. The recycling, reuse and disposal of food packaging materials: A UK perspective. In *Food Packaging and Preservation*, M. Mathlouthi (Ed.), p. 210. Blackie Academic & Professional, Glasgow.
5. Crockett, C. and Sumar, S. 1996. The safe use of recycled and reused plastics in food contact materials—Part II. *Nutrition & Food Science* July/August: 34–37.
6. De Gante, C.R. 1997. Trends in food packaging. In *Food Engineering 2000*, P. Fito, E. Ortega-rodriguez, and G.V. Barbosa-Canovas (Eds.), pp. 347–364. Chapman & Hall, New York.
7. Driscoll, R.H. and Paterson, J. L. 1999. Packaging and food preservation. In *Handbook of Food Preservation*, M. S. Rahman (Ed.), p. 687. Marcel Dekker, New York.
8. Floros, J.D., Dock, L. L., and Han, J. H. 1997. Active packaging technologies and applications. *Food Cosmetics and Drug Packaging* 20(1): 10–17.
9. Gamage, T.V. and Rahman, M. S. 1999. Postharvest handling of foods of plant origin. In *Handbook of Food Preservation*, M. S. Rahman (Ed.), pp. 11–46. Marcel Dekker, New York.
10. Han, J. H. 2000. Antimicrobial food packaging. *Food Technology* 54(3): 56–65.
11. Harte, B.R. and Gray, J. I. 1987. The influence of packaging on product quality. In *Food Product-Package Compatibility Proceedings*, J.I. Gray, B.R. Harte, and J. Miltz (Eds.), pp. 17–29. Technomic Publishing, PA.
12. Huang, C. and Weng, Y. 1998. Inhibition of lipid oxidation in fish muscle by antioxidant incorporated polyethylene film. *Journal of Food Processing and Preservation* 22: 100–209.
13. Huang, J., Shetty, A.S., and Wang, M. 1990. Biodegradable plastics: A review. *Advances in Polymer Technology* 10(1): 23–30.
14. Katz, F. 1999. Smart packaging adds a dimension to safety. *Food Technology* 53(11): 106.

15. Labuza, T.P. and Breene, W.M. 1988. Applications of “active packaging” for improvement of shelf-life and nutritional quality of fresh and extended shelf-life foods. *Journal of Food Processing and Preservation* 13: 1–69.
16. Lockhart, H.E. 1987. Tamper-evident packaging—is it really? In *Food Product-Packaging Compatibility Proceedings*, J.I. Gray, B.R. Harte, and J. Miltz (Eds.), pp. 270–275. Technomic Publishing Company, PA.
17. Mermelstein, N.H. 1998. Enzyme developments. *Food Technology* 52(8): 122–124.
18. Miltz, J. 1992. Food packaging. In *Handbook of Food Engineering*, D.R. Heldman, and D.B. Lund (Eds.), pp. 667–740. Marcel Dekker, New York.
19. Pascall, M.A., Harte, B.R., Giacin, J.R., and Gray, J.I. 1995. Decreasing lipid oxidation in soyabean oil by a UV absorber in the packaging material. *Journal of Food Science* 60(5): 1116–1119.
20. Perry, M.R. 1987. Packaging for the microwave oven. In *Food Product-Packaging Compatibility Proceedings*, J.I. Gray, B.R. Harte, and J. Miltz (Eds.), pp. 178–199. Technomic Publishing Company, PA.
21. Petersen, K., Nielsen, P., Bertelsen, G., Lawther, M., Olsen, M.B., Nilsson, N.H., and Morthensen, G. 1999. Potential biobased materials for food packaging. *Trends in Food Science and Technology* 10: 52–68.
22. Pszczola, D.E. 1997. Packaging helps promote consumption of milk. *Food Technology* 51(11): 74.
23. Rahman, M.S. 1999. Purpose of food preservation and processing. In *Handbook of Food Preservation*, M.S. Rahman (Ed.), pp. 1–10. Marcel Dekker, New York.
24. Rogers, P.J., Batzloff, M.R., Negus, S.M., and Tonissen, K.F. 1999. Enzyme generated biofilms for packaging fresh food. *Food Australia* 51(7): 313–315.
25. TFT. 1997. Intelligent packaging for better food. *The Food Technologist* 27(3): 90–91.
26. Webb, V. 1999. The onto self-heating container. *Resource* 6: 9–10.
27. Weng, Y., Chen, M., and Chen, W. 1999. Antimicrobial food packaging materials from poly(ethylene-co-methacrylic acid). *Food Science and Technology* 32: 191–195.



# 39

## *Types of Packaging Materials Used for Foods*

Robert H. Driscoll and Mohammad Shafiur Rahman

### CONTENTS

39.1	Introduction.....	917
39.2	Types of Packaging Materials.....	917
39.2.1	Plastics .....	917
39.2.1.1	Background .....	918
39.2.1.2	Manufacturing .....	918
39.2.1.3	Properties .....	922
39.2.1.4	Processes .....	925
39.2.1.5	Package Types .....	928
39.2.2	Metals (Steel, Tin, Aluminum).....	929
39.2.2.1	Canning .....	930
39.2.2.2	Aluminum .....	930
39.2.3	Glass .....	932
39.2.3.1	History .....	933
39.2.3.2	Glass Manufacture.....	933
39.2.3.3	Glass Containers .....	933
39.2.4	Timber, Cardboard, and Papers .....	934
39.2.4.1	Timber .....	934
39.2.4.2	Cardboard .....	934
39.2.4.3	Papers.....	936
39.2.5	Ceramics .....	937
39.2.6	Metallized Films.....	937
	References .....	938

### 39.1 Introduction

Originating from natural materials such as skins, leaves, and bark, tremendous progress has been made in the development of diversified packaging materials and packaging equipment. Packaging materials are commonly grouped into rigid and flexible structures. Plastic film, foil, paper, and textiles are flexible materials; whereas wood, glass, metals, and hard plastics are examples of rigid materials.

### 39.2 Types of Packaging Materials

#### 39.2.1 Plastics

Polymers are the fastest-growing group of materials in food packaging. The first plastic materials used for flexible packaging entered commercial production in 1939, just as the war started, but the main development took place in the mid-1950s [6]. Their foremost advantage is their wide diversity and extremely broad spectrum of properties. Plastics are relatively cheap, light, easily processed and shaped, and easy

to seal. The density of most plastics is on par with that of paper or a shade higher, but it is less than half the density of glass or aluminum or about one-eighth the density of steel. Plastics do not shatter like glass or buckle like metals [6]. Two major drawbacks are their permeability to gases and vapors, and the possibility of their interacting with the product [5]. Polymers (or as they are commonly called, plastics) are compounds of very high molecular weight. They are constructed of many repeating units or building blocks, combined together via a chemical reaction. These building blocks, called mers or monomers, are gases or liquids at room temperature and pressure, whereas polymers are normally solids under these conditions. Polymers can be either natural (familiar examples are starch, proteins, and rubber) or synthetic, the latter being those used in packaging. Reviews on types of plastic packaging materials are given by Driscoll and Paterson [2], Stollman et al. [7], and Miltz [5]. Other components in plastics are residual monomer and oligomers, additives such as heat and light stabilizers, antioxidants, plasticizers, and UV absorbers, as well as processing aids such as lubricants, slip agents, and antistatic agents.

Since no single film can satisfy all packaging requirements, plastic films may be combined by lamination or coextrusion. Lamination is a technique for bonding films together to give a film with the properties of both constituents. By combining the qualities of choice from the raw material films, a laminate can be tailor-made for its particular application. Each layer in the resulting laminate may exhibit different properties from its free state, such as mutual layer reinforcement in which cracks in a brittle layer are prevented from propagating by high elongation (elastic) layers. For package sterilization, the material of choice is polypropylene (PP), which is used as the outer and inner plies of the laminate with polyvinylidene chloride (PVDC) as the middle layer to provide an oxygen barrier. Intermediate between these main functional layers will be other plies to contribute appropriate bulk and strength. PP has the additional advantage as it can be heat sealed [3].

### **39.2.1.1 Background**

#### *39.2.1.1.1 Introduction*

The first type of packaging material to be discussed is plastic, which is technologically a complex class of material. Packaging materials may be grouped into rigid and flexible structures. Plastic film, foil, paper, and textiles are flexible materials; whereas wood, glass, metals, and hard plastics are examples of rigid materials. The volume of plastics produced each year now exceeds the amount of steel consumed, and practically none of it is recycled. Plastics now account for about 25% of household waste, although less than 20% of the containers we use are plastic. Half of these are used for milk and various carbonated drinks. However, using other forms of packaging would double packaging costs, quadruple the amount of waste products, would take more energy to produce, and reduce the number of new jobs per year created by the growing packaging industry (e.g., 2500 in Australia). There is increasing recognition of the need to recycle. The main difficulties are separation of plastics (manual labor) and purity of the final product (energy problems).

Because of their lower unit cost and lower energy consumption during manufacture, plastics have tended to replace the traditional packaging materials, glass, paper, and metals, in situations where high barrier properties are not required by the product. Although no ideal barrier plastic exists, developments in laminates and copolymers are slowly reducing the competitive edge of glass and metal containers.

#### *39.2.1.1.2 History*

The historical developments of plastics are presented in Table 39.1. Since 1953, a range of other important plastics have been developed. The definitions of terms are also presented in Table 39.2.

### **39.2.1.2 Manufacturing**

#### *39.2.1.2.1 Manufacture of Plastic*

Polyethylene (PE) is a polymer that is produced from oil or coal through extraction of ethylene gas. Ethylene ( $C_2H_4$ ) is a monomer, a molecule that can combine with itself through breaking its carbon-carbon double bond to produce long-chain macromolecules that are highly inert to the environment. Many other monomers are derived from ethylene.

TABLE 39.1

## Historical Developments of Plastics

Year	Plastic Type
1843	Malayan <i>gutta percha</i> , a shellac molding material, was the first seminatural plastic.
1870	Searching for a substitute for ivory for constructing billiard balls, Hyatt made pyroxylin from cotton and nitric acid and then reacted this with camphor, producing celluloid.
1909	Leo Baekeland reacted phenol with formaldehyde with a catalyst, hexamethyleneteramine, under pressure (to stop foaming), producing the first synthetic resin, called bakelite.
1919	Casein was developed as a film.
1927	Cellulose acetate and polyvinyl chloride were developed.
1935	ICI reacted with ethylene under high pressure with trace O <sub>2</sub> , giving LDPE, which suited the newly developed technique of blow molding.
1953	Karl Zeigler produced HDPE from ethylene using catalysts, titanium tetrachloride and triethyl aluminum.

TABLE 39.2

## Definitions of Terms

Terminology	Definition
Mer	A unit, e.g., a basic unit in a chemical structure polymer: many units.
Plastic	Deforms, can be shaped by a shear force in excess of a plastic yield minimum.
Thermoplastic	Shaped by reducing the yield stress by heat softening.
Thermosetting	Initially shaped by heat, but shape is then set permanently crystalline: regular, periodic shape.
Amorphous	Opposite to crystalline, random shape.
Isotactic	Possessing a preferred orientation of molecules (same feel) atactic: molecules in structure are randomly oriented (no feel).

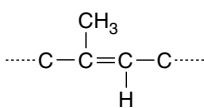


FIGURE 39.1 The structure of natural rubber (isoprene) (leaving out irrelevant hydrogen atoms).

The chain of mers can twist and kink around the C–C bonds so that the resulting macromolecule can vary from a straight line to a sphere. The degree of linearity has a huge effect on the resulting plastic properties. As the polymer is cooled after melting or manufacture, the chains will link to each other, either by van der Waals forces, ionic attraction, or cross-link bonding. If the macromolecules are straight and regular, they will fit well together, giving higher density and crystallinity.

The kinked and twisted molecules are stretchable, sometimes to many times their unstretched length, so that the plastic can be *oriented*. Branching can occur along the chains but is relatively rare, requiring a reaction to occur at a C–H bond. Higher temperatures permit more of these random branching reactions to occur. Branching reduces crystallinity by preventing ordered molecular arrangements. Most polymers are from difunctional monomers; a few are tri- or multifunctional, leading to three-dimensional configurations instead of long chains. These structures are more rigid at high temperatures.

The plastics are divided into two groups: thermoplastic and thermoset. Thermoplastic means that the plastic may be heated and cooled without losing its structure, while thermoset plastics, once cooled, cannot be reheated without breakdown of the macromolecule. When a thermoplastic material is heated, it becomes pliable and can be shaped as required. Linear polymers tend to be thermoplastic, whereas cross-linked polymers are thermoset. Cross-linking occurs when atoms join across polymers, e.g., sulfur, which is used to cross-link isoprene to give us the rubber used in car tires, or oxygen, which causes aging in the same rubber by cross-linking and so reducing the rubber flexibility. The structure of natural rubber (isoprene) (leaving out irrelevant hydrogen atoms) is shown in Figure 39.1.

The C after the double bond can point up or down, leading to isomers (isoprene and “gutta percha”) with different properties. By analogy with isomers, the basic units can also combine in different orientations, leading to isotactic polymers with ordered structures, which can more easily be crystalline, and atactic structures, where the orientation continuously varies along the chains, preventing crystallinity. For example, PE varies from atactic PE with a density of  $900 \text{ kg/m}^3$  to crystalline PE with a density of  $1000 \text{ kg/m}^3$ . Common forms of PE are low-density PE (LDPE,  $920 \text{ kg/m}^3$ ), linear low-density PE (LLDPE), medium-density PE (MDPE), and high-density PE (HDPE,  $960 \text{ kg/m}^3$ ).

Bonds can be broken in a number of ways (degradation of the polymer). A C–C bond has an energy of  $6.1 \times 10^{-19} \text{ J}$ . UV light at 300 nm has an energy of  $6.1 \times 10^{-19} \text{ J/photon}$ , so is close to the same energy. Visible light at around 600 nm has about half as much energy. If thermal or strain energy are also present, then visible light will also degrade plastic (but more slowly than UV).

Glass temperature refers to the temperature at which individual molecular energy is too low to allow the macromolecules to slide past each other. The melt temperature is the transition temperature from a solid to a free liquid and is higher than the glass temperature. Below the glass temperature, the plastic is brittle, therefore some plastics cannot be used for freezing, but between the two temperatures the plastic can be shaped and bent more easily. A plasticizer acts by reducing the average molecular size, acting as a lubricant between the large macromolecules so that they slide over each other.

Methods of polymerizing include:

1. Addition: unsaturated compounds open up their double bonds under heat and pressure. The macromolecule forms in three stages: initiation, propagation, and termination. Initiation is the initial rupture of the C=C bond to produce energetic combination sites. In propagation, further monomers react with a growing chain. In termination, two growing chains meet each other and combine, preventing any further reaction. For high molecular weights, this should be delayed as long as possible.
2. Condensation: after initiation, molecules combine, releasing low-molecular-weight compounds such as water.
3. Ionic (either anionic or cationic polymerization): initiation occurs through the introduction of ionic compounds, which become integrated into the polymer, producing a class of plastics called ionomers (surlyn).

Ethylene is the main monomer used in the production of plastics ( $\text{CH}_2=\text{CH}_2$ ). The hydrogen atoms can be replaced by halides (chlorine, fluorine, and bromine), phenyl, or other such groups to produce further monomers, all containing the central ethylene double bond. These polymers are generally thermoplastic and are called polyolefins.

Large chemical companies usually manufacture plastic in the form of small plastic beads or resin. These granules are transported in bulk to factories for manufacture into either rigid or flexible materials. In either case, the resin is fed into the hopper of an extruder, which brings the resin temperature to above its plastic melting point but below its degradation temperature. It is then ready to be shaped by passing through a die plate, containing die inserts that shape the product as required.

#### 39.2.1.2.2 Construction of Rigid Plastics

**39.2.1.2.2.1 Blow Molding** Many plastics are shaped using a process called blow molding. This is a process for producing hollow parts in one operation and is primarily used to make plastic bottles. A hot plastic tube, called a parison, is inflated against a cold mold. The final shape will have a thin neck, ideal for many packaging applications. The parison is produced by extruding the plastic at high temperature and pressure. Variations on blow molding include coextrusion blow molding, injection blow molding, and injection stretch molding. Labeling can also be done in the mold.

**39.2.1.2.2.2 Injection Molding** Injection molding involves direct injection of molten plastic into a shaped space between two dies. The dies separate after the plastic cools to allow the final shape to fall out. This is used for making solid plastic objects such as caps, closures, and plastic toys.

**39.2.1.2.2.3 Thermoforming** Many plastic containers are formed by thermoforming. This involves heating a plastic sheet until it softens and then shaping it by stamping it between two cooled molds. A growing requirement of molded plastics is that they be microwaveable, i.e., has a softening point well above 100°C. They must also be shelf stable. Plastics are generally slow to degrade under ambient conditions, but they may discolor or become brittle.

#### 39.2.1.2.3 Construction of Plastic Sheets and Films

Approximately 10 different polymers account for the majority of packaging films. In general, a film is defined as a layer of thickness of less than 0.010 inch (0.25 mm). Thicker plastic is referred to as a sheet. Films may be used as liners, wraps, or overwraps, depending on how they are applied to the product. Liners are plastic films applied to the inside of the container, often to protect the container from the product, such as plastic linings sprayed into the inside of metal drums or cans. Wraps are applied directly to the product, usually by making a tube from the film, sealing one end, filling the tube with product, then sealing the top end. An overwrap is applied around the carton, often heat shrunk onto the carton to provide barrier protection.

Films may also be used for bags, envelopes, and pouches. A common method of closing plastic bags is with plastic clips that can also double as price tags, as in bread packaging. Envelopes are bags sealed on three sides, with the last side folded over and sealed after filling with product, used mainly for flat items. Pouches are constructed and filled on the processing line automatically. A typical pouch is a complex laminate, possibly of oriented PP (outside), LDPE, aluminum foil, adhesive, and a copolymer film on the inside.

Films are manufactured using an extruder. The plastic resin granules and other ingredients are fed into the extruder and compressed and heated until the plastic flows out of the die. The two main die shapes are slit circular and slit rectangular. The extruded plastic may then be stretched while still hot and flexible:

1. **Monoaxially:** the die is designed to give a wide sheet of plastic film. This can then be stretched in the machine direction by up to 80 times its original length, which has the effect of thinning the sheet and orienting the molecular structure. The result is that the plastic can be stretched easily in one direction after cooling, but not in the other. The thickness of the film is checked, the film cooled, and then wound onto the mill roll.
2. **Biaxially:** jaws and rollers are used to stretch the film apart in both directions at once (Tenter process). The molten film is poured onto a casting wheel and then through a series of rollers, which stretch the film in the machine direction. The film then passes through the Tenter section oven, where the jaws are used to grip the softened plastic and pull it apart in the transverse direction. The result is a stiff plastic. A second method is called the bubble method, where the plastic is extruded as a continuous cylinder, and a bubble of air is blown up the center of the cylinder, forcing biaxial expansion. As the plastic heat sets, it will shrink slightly before assuming a fixed shape.

The plastic may then be coated prior to the mill roll in several ways to enhance its properties. A common example is coating a plastic that is difficult to print with a printable plastic on one or both sides. Coating will be discussed in more detail below. Another common coating produces metallized plastic. For this technique, the plastic passes quickly through an evacuated chamber in which aluminum is vaporized. This deposits a metal layer several molecules thick (~200 Å), resulting in a metallized appearance. This material is often used to replace foils as it is cheaper but does not have the same barrier properties as foil (although there will be some improvement over untreated film). The metal coat also substantially reduces UV light reaching the product. Metallized films are a common base for eye-catching graphics. However, the metal does not attach firmly to the plastic and may be scraped off (a surface lacquer prevents this), and the plastic is not sealable on the metallized side. Metallized plastics also suffer from metal oxidation, affecting print adhesion, giving a maximum effective lifetime of about 3 months.

The film may also be pearled, a technique that distributes fine air bubbles throughout the plastic (or cavitating the surface), resulting in a pearly white opaque appearance. This is useful for preventing “show-through,” the wet appearance where fats directly contact the plastic, and a particular problem



with chocolate wrapping. Pearllized plastics also tear more easily. The ideal film should have good barrier properties, be chemically stable, temperature resistant, heat sealable, resist grease, be strong, not allow migration, have good transparency and gloss, be printable, and be inexpensive to make. Since no plastic will satisfy all these requirements, the actual plastic chosen for a particular function will be a compromise.

### 39.2.1.3 Properties

#### 39.2.1.3.1 Plastics

Most of the properties discussed in the following section are explained where first used. One key property relevant to packaging equipment, slip, is not covered in detail, and therefore will be explained here. From the perspective of machining, plastic film must have the right friction coefficient to pass smoothly through the packaging equipment. If the slip is too high, the result is different package sizes in tube-formed packaging due to the film sliding past the forming rollers as well as a loss of registration in printing (see below). The product slides easily inside the package, interfering with sealing the pack. On the other hand, too low a slip can cause the film to stick to hot surfaces or folding box surfaces and can cause the product not to slide down to the bottom of the pack, also affecting pack sealing and presentation. The product should be able to slide back and forward in the pack relatively easily for tight sealing at both ends. This section also serves to introduce and describe the primary packaging plastics.

**39.2.1.3.1.1 Polyolefins Polyethylene:** PE is the result of polymerization of ethylene gas and has the formula  $(CH_2)_n$ . It was invented by Imperial Chemical Industries PLC (ICI) in the 1930s. Two main manufacturing processes result in different PE products. The first is called LDPE and the second HDPE.

LDPE is formed at high pressures (1000–3000 atm). This results in long branched chains, weakly linked to each other by van der Waals forces (but strong overall force due to length). The branching is random, and so LDPE is an atactic polymer. Thus, neighboring chains can slip past each other, allowing the material to bend easily (flexible). As a result, the printability of LDPE is poor. However, many plastics with poor printability can be made printable by corona treatment, in which an ionic discharge is used to sensitize one side of the plastic.

LDPE has low density, as the long chains exhibit branching, so that the molecules are not able to fit closely together. This irregularity in structure also results in a lower melting point and a less crystalline (ordered chain) structure. LDPE is tough, semitransparent (poor clarity), and flexible, and has a waxy feel. It resists most chemicals below 60°C, and it resists water moderately, but not gases (poor O<sub>2</sub> barrier). LDPE is usually used as thin sheets or laminated to other packaging materials. It is used for bag manufacture (bread, diapers), for low-temperature storage (due to its low barrier properties), and for packaging rice. The melting point of LDPE is 105°C.

HDPE is produced at low temperatures and pressures of about 10 atm. This gives rise to an ordered molecular structure, which is called an isotactic polymer. The Ziegler process is used, employing a catalyst. HDPE is stiffer, harder, less flexible, and waxy. Higher temperatures are required to produce thermoplasticity (melting point, 134°C). HDPE is used for making containers, e.g., crates, bottles, bags, tubs, plastic knives and forks, etc. It can be steam sterilized, whereas LDPE cannot. HDPE bottles are opaque and can be used to contain detergent and milk. HDPE resists fats and oils better than LDPE. However, it does not seal easily.

This simplifies the total PE picture. Available PEs include low-, medium-, and high-density PE, linear low (LLDPE) and medium densities (with twice the hot-tack strength), copolymers of PEs, copolymers with vinyl acetate (EVA), and ionomer film (surlin). PE may be coextruded with nylon, saran, and ethylene vinyl alcohol (EVOH) sandwiched inside. Such films have high strength, flexibility, clarity, and especially barrier properties, and are used for bag-in-the-box, pouches, cups and lids, etc. Usually the form of PE used will be a trade-off between barrier properties required and cost.

**Polypropylene:** This monomer has the formula  $CH_2CH-CH_3$ . PP was developed using polymerization catalyst technology by Giulio Natta in 1954. PP forms a regular, highly ordered polymer at low pressures in the presence of certain catalysts called isotactic PP. It has high crystallinity (high clarity and gloss), is

hard, heat resistant (higher softening point, 150°C), exhibits good memory, flex crack resistance, puncture resistance, and stiffness. It is resistant to chemicals (except aromatic and chlorinated hydrocarbons).

PP has excellent moisture and average gas-barrier properties. It can be printed on and is ideal for reverse or surface printing. Cast PP has excellent heat sealability. PP is used for injection-molded containers and blister packs, laminations, carton overwraps, snack food bags, and confectionery bags. It may be coated (e.g., with PVDC or acrylic) and may contain additives. PP has poor heat stability, so precise heat control is required in the packaging equipment.

PP film may be stretched during production yielding an oriented (OPP) or biaxially oriented film (BOPP) of high clarity, strength, and resistance to water vapor and gases (e.g., for wrapping snack foods), and coated with saran or acrylic for better barrier and heat sealability. PP causes contact transparency (“show-through”), and is available in thicknesses from 15 to 75  $\mu\text{m}$ . It may be pearlized ( $\text{CaCO}_3$  + heat generates  $\text{CO}_2$  bubbles, resulting in reduced barrier properties and strength, but no show-through) or white (pigmented, better print density, replaces the need for a white undercoating before printing, reduced show-through). It is used for confectionery, especially chocolate. PP may be coextruded with PE (1.5  $\mu\text{m}$ ) for heat sealability.

*Polyvinyl chloride:* This monomer has the formula  $\text{CH}_2\text{CH}-\text{Cl}$ . The term vinyl means that a halogen has been substituted for a hydrogen atom. Polyvinyl chloride (PVC) has low crystallinity (so has good transparency when pure), but higher interchain bonding than PE due to the  $\text{Cl}^-$  halogen, so is harder and stiffer. For this reason, plasticizers may be added during manufacture. The Australian Standard 3010—Plastics for Food Contact: PVC—allows four plasticizers for food involving flexible sheets and films, e.g., vitafilm (for meat) with particular oxygen diffusion characteristics.

PVC has good feel and printability. It is highly inert. It is glossy and resistant to moisture, fats, and gases. There is great variety in PVC compositions, e.g., stabilizers, impact aids, lubricants, and other additives are present in large proportions. The stabilizer is necessary because the decomposition point for PVC is close to the melting point. For food products, the extraction of the stabilizer from the PVC must be less than 1 ppm of the stabilizer, and the stabilizer must be a calcium–tin or dioctyl–tin system (not butyl–tin, used for nonfood products), containing tinuven for UV protection. PVC is used in the biaxial-stressed form, e.g., for shrink wrapping of cheese and meat. It is also used for thermoformed containers, e.g., for chocolates as well as for plastic pipes and toys. It heat-shrinks after stretching and can be thermoformed.

*Polyvinylidene chloride:* This polymer is similar to PVC, except that there is a double chlorine substitution, giving  $\text{CH}_2=\text{CCl}_2$ . PVDC has a more ordered structure with high crystallinity and softness. It has excellent barrier properties (especially to  $\text{O}_2$ ) and is commonly used as a copolymer with PVC. PVDC possesses reasonable clarity, good feel, good printability, and strength. It is difficult to cut as it lacks stiffness, so is hard to machine by itself and is too expensive for use as a pure monofilm (except for household use). It resists chemicals, has low water, gas, aroma, and flavor permeability (due to chlorine ions), and high strength. It has high chemical stability and is hydrophobic.

PVDC is used with PVC as a copolymer to coat other packaging materials to provide good barrier properties. It is used in laminates and is an important shrink film, with excellent cling properties. PVDC cannot be reprocessed because it degrades (melting point, 162°C). This makes coextrusion lamination difficult as well, although it can still be easily used in coating from solution. When used in coextrusion, it must be copolymerized first (for example, with vinyl chloride) to give better temperature stability.

*Polytetrafluoroethylene:* The formula for this monomer is  $\text{CF}_2=\text{CF}_2$ . Polymerization produces long, straight unbranched chains, with ionic intermolecular bonding, so polytetrafluoroethylene (PTFE) is strong and crystalline. Since the bonds C–C and C–F are strong, this material is extremely inert and has a high softening point (340°C). PTFE possesses a high gloss and is waxy in feel. It is used in coating cookware (nonstick surfaces) and forming and packaging where easy-to-clean nonstick surfaces are required.

*Polystyrene:* This polymer results when an ethylene hydrogen is replaced by a phenyl radical ( $\text{CH}_2\text{CH}-\text{C}_6\text{H}_5$ ). It is a synthetic rubber, which does not degrade over time. Polystyrene (PS) is amorphous (random packing), low in density, and brittle. In the pure form, it has good clarity and printability. It is often used for loose bulk packaging, especially for packing fragile materials. Originally this involved aeration of the liquid plastic with fluorocarbons, but environmental aspects have encouraged CFC-free production and reusability of loose packaging materials (also called void packaging).

PS is usually copolymerized, especially with butadiene, to give high-impact polystyrene (HIPS, see later), which has a less brittle structure. Yogurt and ice cream tubs are common examples. Margarine tubs may be made from acrylonitrile butastylene (ABS). PS is also used for disposable plates and cups. PS can be foamed with hexane to form expanded polystyrene (EPS), a low-cost, low-density material that is easily formed into holding trays, cups, etc.

PS is the plastic of choice for thermoforming because it has strength, low cost, formability, and sealability. PE and PP are only used where specifically required; PP containers can be filled at high temperatures. Although PS provides a good barrier to gases, it is permeable to water vapor. It resists grease, acids, alcohols, and alkalis (i.e., chemically stable). Oriented PS is a most useful packaging film and is heat shrinkable. The melting point of HIPS is 100°C.

**39.2.1.3.1.2 Other Thermoplastics Polyesters:** Polyesters are plastics formed by the polymerization of esters. In general, they have reasonable clarity and poor feel and printability, but are strong, versatile, with good heat resistance. This is useful for boil-in-the-bag-type applications, where the plastic must sustain temperatures of 100°C without deforming or softening. When metallized, polyesters are also used for snack and coffee pouches.

Ethylene glycol and terephthalic acid yield polyethylene terephthalate (PET). PET has high strength and chemical stability. It is used for blow-molded bottles and some films, increasingly for thermoformed trays, for shrink-wraps, and for boil-in-the-bag products. It has excellent clarity, comparable to that of glass. It can be printed, metallized, and laminated. It has high barrier properties for a plastic film. Owing to efficient recycling, PET is a cheap plastic. It is only used in 12 and 15  $\mu\text{m}$  gauges for film and is commonly used as the outer layer of a laminate structure due to its gloss and temperature stability (melting point, 254°C). It is used for microwave pie wraps (microperforated).

Forms of PET include atactic PET (APET), crystalline PET (CPET), oriented PET (OPET), and copolymer PET/cyclohexane dimethanol (PETG; melting point, 265°C). Polyethylene naphthalene (PEN) shows promise due to its low permeability to gases. There is a growing interest in recycling polyesters due to their initially high cost. The advent of the PET range has revolutionized the packaging industry, allowing plastic to compete directly with glass bottles. Blow-molded PET bottles have less weight, lower production and energy costs, and are droppable, while they still have excellent clarity and gloss. The bottle is molded as follows: the closure is first injection molded, producing a little bottle with the screw top already formed, then transferred hot to a blow-mold die. The wall thickness is computer controlled. The production equipment is specific to PET. Current production rates are about 1 per second. They are not suitable for beer, which requires a light barrier (opacity).

**Cellulose:** This was the first transparent film to be used (invented by Du Pont) in packaging and was widely used until the advent of PP. It is biodegradable. A common name is cellophane, a trademark name of British Cellophane Ltd. Cellulose is clear, stiff, printable, and glossy, but has poor feel and moisture resistance. It has good heat-dimensional tolerance. It is not heat sealable. It is naturally antistatic and therefore good for powders (e.g., milk powder). Cellulose is still widely used today, due to the addition of coatings that have given cellophane great adaptability. Examples of coatings are nitrocellulose (making cellophane flexible and durable), PVC, PE, and PVDC (oxygen-barrier properties).

Cellulose can be laminated to foil, paper, and some plastic films. It is able to retain folds (called *dead fold*), so that if it is twisted, it retains that twist, making it ideal for individual candy wrappings. It is also tearable. It is used for cookies, confectionery, and pastries in situations where vapors may need to “breathe” to prevent surface molding. Cellulose is sold on the basis of weight per unit area, not thickness, due to the variation in thickness that occurs with moisture absorption. It is available in weights of 22–60 g/m<sup>2</sup>. Some typical cellulose codes are given in Table 39.3.

**Cellulose acetate:** This product is made from cellulose and acetic anhydride. Cellulose acetate has good clarity, is printable in sheet form, but has poor feel and barrier properties. It is becoming obsolete, although it is still used in laminates and thermoformed blister packs.

**Other thermoplastics:** Other biodegradable biopolymers are being developed but have not yet become competitive. The raw material for the new thermoplastics is usually starch, which is blended with conventional oil-based polymers.

**Polyamides (nylons):** These are made from condensation of a diacid (e.g., adipic acid) and a diamine (e.g., hexamethylene diamine). Polyamides have high crystallinity, strength, impact strength,

**TABLE 39.3**  
Some Typical Cellulose Codes

Code	Explanation
A	Anchored (describes lacquer coating)
/A	Copolymer coated from dispersion
B	Opaque
C	Colored
D	Coated one side only
F	For twist wrapping
M	Moistureproof
P	Plain (nonmoistureproof)
Q	Semimoistureproof
S	Heat sealable
/S	Copolymer coated
T	Transparent
U	For adhesive tape manufacture
X	Copolymer coated on one side
XX	Copolymer coated on both sides

puncture and stress-crack resistance, flexibility, and melting (255°C) and softening points. They also have good chemical resistance. Polyamides are used for boil-in-the-bag-type products, frozen foods, fish, meat, vegetables, and processed meat and cheese, always in lamination. They have low water barrier and high gas permeability. A large range of different nylons exists. Polyvinylidene-coated or metallized nylon is about twice the price of pure nylon film. Nylon is available as cast (18–100 µm) and biaxially oriented nylon (BON) (12, 15, and 20 µm). It can be metallized or PVDC coated for better barrier properties and is usually laminated. As a film, it must be biaxially oriented to give printing and machining stability.

*Polycarbonates:* These are formed from condensation of carbonic acid in the presence of aliphatic or aromatic dihydroxy compounds. They are amorphous. Most polycarbonates are tough, stiff, hard, and transparent (high clarity), with high softening points, and therefore can be

cooked in oven or sterilized, they have poor barrier properties, and cost three times as much as PP. They are used for plastic tableware and fruit juice containers.

*Acrylonitrile:* This is an excellent gas barrier (like EVOH and PVDC). It possesses good chemical resistance and has a melting point of 170°C. It is easy to thermoform because of its high stiffness. Acrylonitrile (AN) forms copolymers such as Lopac and Borex, which have potential as high-barrier plastics. Acrylonitrile buta-styrene (ABS) is still used, but polyacrylonitrile (PAN) has been replaced by PET.

*Pliofilm:* This is a rubber hydrochloride formed by combining polyisoprene (natural rubber) with hydrochloric acid. It is a printable, good-feel, opaque film with good heat-sealing characteristics and grease resistance. Pliofilm is no longer used much as it is not easy to machine and is not very durable. However, it was one of the first thermoplastics. It is chemically stable, requires a plasticizer, and has poor barrier properties.

*Ethylene vinyl alcohol:* This film has high oxygen-barrier properties, but hydroxyl groups make it hydrophilic, which increases its permeability. Thus, it must be sandwiched between materials with good water-barrier properties, such as PP or LDPE, to be effective. However, its oxygen-barrier properties make it a highly desirable film, competing with PVDC for this role. EVOH is more expensive than PVDC, but it is easier to process and is recyclable. The melting point of EVOH is 185°C.

*Ionomers:* Surlyn is the brand name of a range of Du Pont ionomer resins (invented by Rees in 1961). An ionomer resin has both ionic and covalent bonds. The ionic bonds are due to sodium or zinc cations. Surlyn has low-temperature heat sealability (about 90°C), good hot tack (four times better than LDPE, LLDPE, and EVA), formability, toughness, and chemical inertness. Surlyn has some haze. To achieve a coefficient of friction of about 0.2 (as required by modern packaging machinery), slip agents must be added. Surlyn is used for shrink-wrapped meat, cheese blocks, fish, individual candy wrapping, pet food bags, potato chips, snack foods, drink Tetra Pak cartons, margarine tubs, cookies, frozen foods, nuts, etc. as part of a laminate structure, especially as the inner heat-sealing layer.

### 39.2.1.4 Processes

#### 39.2.1.4.1 Copolymers

Condensation of combinations of certain homopolymers with each other can produce complex copolymers with properties different from the individual constituents. Depending on how the individual monomers combine, a great variety of properties can result. Let A and B be two monomers: they can combine (a) in strict sequence, e.g., A—B—A—B—A— ... , (b) in blocks, e.g., A—A—A—A—B—B—B— ... , or (c) in branching chains, with a central chain of one monomer. Some examples are ethylene vinyl acetate (EVA, a good heat sealant but with poor barrier properties), ethyl-vinyl alcohol (EVOH, a hydrophilic plastic), vinyl chloride copolymers, and PS copolymers.

### 39.2.1.4.2 Lamination

Since no single film can satisfy all packaging requirements, plastic films may be combined by lamination or coextrusion. Lamination is a technique for bonding films together to give a film with the properties of both constituents. By combining the qualities of choice from the raw material films, a laminate can be tailor-made for its particular application. Each layer in the resulting laminate may exhibit different properties from its free state, such as mutual layer reinforcement in which cracks in a brittle layer are prevented from propagating by a high elongation (elastic) layer. This effect depends on good adhesion between the layers. Three factors affect the adhesion between layers:

1. Viscosity/shear rate match during melding of layers. To be coextruded, the melt flow viscosities should be similar (a ratio of within 3:1), otherwise one of the plastics will flow with respect to the other, preventing bonding.
2. Temperature, pressure, and period of contact, to build the bond.
3. Functionality of adjacent resin layers, i.e., that they are sufficiently similar in structure to mix at the contact surfaces.

If all these factors are not present, then an adhesive layer is necessary and the plastics may be cold bonded with a tie layer of resin adhesive. Adhesives are discussed below. A typical triple-layer film would be composed as follows. Properties of outside layer: high gloss, printable, good lamination, possibly metallized, high slip. Properties of middle layer: strength, stiffness, barrier properties, possibly opaque. Properties of inner layer: easy to seal (hot seal, good hot-tack properties, or good cold-seal properties), low migration rates, barrier properties.

A laminating machine has the following components:

- Continuous feed roll with a feeder “on-the-fly” splicer, which can cut off the old roll and join on the new (there may be several rolls feeding film into the machine at once)
- Tensioning rollers to give exact control over the tension in the plastic
- Lamination stage where the primary and secondary webs are combined (a web refers to the film as it passes through the machinery)
- Compression rollers to push the layers together
- A take-up (rewind) roller to collect the final laminate

Note that plastics can be laminated with papers and foils as well as plastics. Laminations with paper will tend to use water-based adhesives, since the solvent (water) will absorb into the paper base away from the adhesion zone, allowing the glue to set quickly. Lamination also allows reverse printing, where one plastic layer is printed (in mirror image) before lamination to sandwich the printing inside the laminate for greater protection. Lamination of plastic films is achieved by one of four processes:

1. Adhesive lamination, where a continuous glue source is fed as a flat film between consecutive layers of the laminate. This may be a hot glue (a plastic resin fed from an extruder, for example) or a pressure-sensitive glue applied as a high-viscosity liquid to one web, then dried in a tunnel oven to remove the solvent, and then wrapped with the secondary web around a chill roller. The glue may physically bond (e.g., to paper or board) or chemically bond. This technique is also used for labels.
2. Extrusion lamination, where extruders replace the feel roll, and the layers are coextruded.
3. Thermal lamination, where heat is used to join the webs by partial melting.
4. Wax (or hot-melt) lamination, where a thermoplastic glue or wax is used instead of a pressure-sensitive glue. The rollers must have the capacity to be heated to a suitable temperature.

Typical speeds for lamination are 100–200 m/min.

### 39.2.1.4.3 Coatings

To enhance plastic film properties such as printability, coatings are often used. Aqueous and solvent coatings are applied to the substrate through water dispersions or emulsions, solvent solutions, or waxing. Aqueous and solvent coatings are applied to the substrate using direct roll, direct gravure, or reverse gravure methods. The coating liquid is then dried and cured by infrared heat or a hot-air oven. The coated film is then cooled before being wound onto a roll core. Modern machines allow simultaneous coating on both sides. Examples of coating are:

1. Foil lidding: a lacquer coating is applied to the foil, which can be heat sealed to the container but is peelable for convenient opening. On the outer side, a clear nitrocellulose lacquer is applied.
2. PVDC may be coated onto paper or PP by reverse gravure. PVDC does not bond well to other plastics, so a prime coat may be applied first. The prime coat may be nitrocellulose, vinyl, acrylic, or shellac.
3. Cohesive (cold seal, latex based) coatings are often gravure coated onto films during printing (on the opposite face). Cold seals are pressure sensitive and therefore can be sealed more quickly than hot seals, which require adequate dwell time.
4. Colored vinyl lacquers may be applied to outer packaging surfaces, e.g., to give colored aluminum foil.
5. Paraffin waxes are used as coating bases for papers, especially for inner wraps or liners for biscuits or cereals. The wax may be blended with resins, synthetic rubbers, and polymers to meet specific requirements.

### 39.2.1.4.4 Adhesives

Adhesive layers are used to bond film layers together to construct a laminate and are also polymers. These tie layers will affect the mechanical properties of the final construction. They are usually expensive and must have lower melt temperatures than the layers they are bonding. The adhesives are mostly olefin copolymers, polyurethane, or polyester dissolved in solvents. If no solvent is used, the glue may be extruded hot between the films. Examples of a hot-melt adhesive are copolymers of ethylene and acetic acid, and surlyn.

Adhesives must “wet” the film surfaces to provide laminate strength, or the laminate will tend to separate into its individual components when used. They may be categorized as liquid, solid, solution, or emulsion [1]:

1. Liquids are monomers that react with trace water to form polymers, such as cyanoacrylate (“superglue”), reactive liquids that combine chemically such as epoxy resins, and pressure-sensitive adhesives (congealed liquid resin in a rubber matrix, with the property that they can be peeled off again).
2. Solids are powder adhesives activated by the addition of moisture, solvent, or heat. Hot melts consist of a polymer, resin, wax, and stabilizers. The hot melt is supplied in solid form, applied in the hot liquid form, and then resolidifies as it cools. No solvent is required and they set very quickly.
3. The two main classes of solutions are (a) water based (traditional glues with natural polymers such as starch, flour, casein, animal glue, dextrin, gum arabic, etc., and newer synthetic resins in solution such as PVA, cellulose ethers, and vinyl pyrrolidones) and (b) other solvents (natural, e.g., resin, shellac, bitumen, rubber, and gums, and synthetic, e.g., nitrocellulose, urethanes, nitrile rubbers, epoxies, and cellulose acetate).
4. Emulsions dry faster than solutions and have a greater range of properties. Synthetic resin emulsions now dominate the packaging industry. They include PVAc, acrylic resins, polychloroprenes, etc.

### 39.2.1.4.5 Heat Seals

A major requirement of plastic film is heat sealability. A heat seal is the fusion of two surfaces under the influence of heat, pressure, and time. The two surfaces are partially melted by the heat applied by a pair

of heated jaws. For plastics such as PP, which has a higher melting point, a copolymer coating may be applied on one or both sides to give heat sealability. Some important terms used in heat sealing are:

- Dwell time—time for heat to penetrate the outer films to reach the two layers being bonded, i.e., time the plastic must remain under heat and pressure.
- Heat seal threshold—minimum temperature at which a heat seal threshold of 200 g force per 25 mm is obtained. This temperature should be about 80°C–120°C, i.e., a balance between too high (wrong layers melt) and too near ambient (no melting). The lower the temperature, the faster the sealing, since less heat must be lost before resolidification of the plastic.
- Pressure—about 1 atm pressure is applied.
- Useful heat seal range—range of temperatures over which the films may be sealed. The upper limit is the point where distortion of the plastics starts to occur.
- Maximum linear film speed—the maximum speed at which film can be passed through the sealing machine.
- Hot tack—the strength of the initial partially molten seal is called the hot tack. If the hot tack is not good, then stresses on the film before cold tack is achieved can reduce the integrity of the seal.
- Cold tack—the final “cold” strength of the bond.

### **39.2.1.5 Package Types**

#### *39.2.1.5.1 Plastic Bags*

Bags are formed from sheet or film plastic by folding and heat sealing as required. Some bags have folds in the base so that when packed, they expand to a rectangular shape. Handles may be inserted during folding and heat sealed into the folds. The bags must be strong enough to resist breakage under the design load, but also must not break when being loaded.

Bags may be preformed, in which case they may be “wicketed,” or formed from the source plastic sheet during packaging (usually by forming tubes from the plastic). Wicketing is the process of punching small carry holds at one end of the bag with which to hold the bag during loading. The holes must be carefully designed to carry the load of the product entering the bag, yet must tear off easily so that the next bag becomes available.

#### *39.2.1.5.2 Plastic Closures*

A closure must perform five functions:

1. Contain, to the same level as the remainder of the package.
2. Allow access, so that the consumer can retrieve the product in a convenient way. The ability of the package to be functional in this regard is an important marketing consideration.
3. Restrict access, e.g., tamper-evident and child-resistant caps.
4. Protect the product, keeping out dirt, moisture, etc.
5. Be economic.

The closure may also be used for advertising or barcoding. A plastic screw cap lid has three main components:

1. The cap itself
2. A liner (HDPE wad), adhesively attached to the cap in most cases
3. The screw, which interlocks with connecting lugs in the finish of the container but does not provide a good barrier seal

The closure must be applied with the correct torque. Insufficient torque leads to leakage, whereas too much torque makes removal by the consumer difficult. Tamper-evident attachments to the screw cap are

commonly used with plastic beverage bottles, consisting of a ratchet ring under the cap, which becomes detached when the customer removes the lid. A dispensing closure is one that allows the product to be dispensed without removing the closure. Examples of dispensing closures are lids such as flip-tops (e.g., gable-top cartons), pump action, aerosols, and opening pourers, which allow small amounts of the product to be removed easily.

Aerosols are cans containing a liquid product layer and a compressed gas propellant. The propellant may also be present as a liquid, which boils as the product is used to replenish the driving pressure. The product may be dispensed as a fine spray, mist, dust, or foam. An example of an aerosol application for the food industry is in instant whipped cream. The advantages of aerosols are simple dispensing and complete exclusion of air. They are, however, expensive and an explosion risk, and since 1974 the use of CFCs has been a suspected cause of damage to the ozone layer. There is now an almost total ban on CFC propellants. In Australia, CFCs have been totally replaced by trigger pump packs and inert gas pressure packs.

The advent of flexible packages (replacing rigid containers) has led to a need to develop closures for such packages. Methods include plastic zippers, pressure-sensitive tape, metal bands, plastic clips, and twist ties (e.g., breads). Child-resistant lids have locking devices that either prevent turning unless squeezed or require pressure to open. Tamper-evident seals are discussed in more detail elsewhere.

#### 39.2.1.5.3 *Oven-Safe Containers*

Ovenable plastic-based food trays have become an essential component of convenience foods. The three main plastics used are PP, PS, and CPET. PP is suitable for microwaves, but not for the higher conventional oven temperatures. Foam PS has a still lower melt temperature, but now, PS low-density blends have been developed with heat deflection temperatures (HDTs) of 190°C, which is suitable for microwaves. These are cheaper than CPET. CPET is stable from -40°C to 220°C, is clear, resists fats, oils, water, and oxygen on the shelf, but is more expensive. Some instant snack meals have complex laminate structures with metal full aperture easy opening (FAEZO) lids and snap-on plastic overlids. Aluminum foil trays have good appearance, stack well, have good barrier properties, and can be dual ovenable. Paperboard trays are ovenable in a range of sizes.

### 39.2.2 **Metals (Steel, Tin, Aluminum)**

Steel, tin, and aluminum are used mainly for canned foods and beverages. The most common use of metals for packaging is in tin-coated steel and aluminum cans. The principal advantages of metal cans are their strength providing mechanical protection, effective barrier properties, and resistance to high temperatures providing stability during processing. As regards their opacity, it is an advantage for light-sensitive products, but disadvantage in that contents are invisible. Other disadvantages of metal cans are their heavy mass, high cost, and tendency to interact with contents and environment (internal and external corrosion). The critical concepts of canning are to ensure that the product in the can is stable and that the seal provided by the metal is complete. Tin coating or lacquering is an important part of can manufacture. The lacquer is a resin, such as an acrylic (which resists high temperatures), oleoresinous, alkyd, epoxy, phenolic, polybutadiene, or vinyl resin. More than 200 different protective coatings are now in use [4]. The lacquering must be complete. Small gaps in the coating can lead to the iron being exposed. The interior coating has to withstand sterilization temperatures and action of acids, as well as sulfide staining. As iron corrodes it produces hydrogen gas, which can blow the can. The development of lacquers has meant that tin-free cans are possible. Another disadvantage of steel is the high-energy requirement during manufacture [2,5].

Aluminum is used increasingly for canning due to its lightness, low cost, corrosion resistance, availability, and recyclability. Aluminum is also used extensively in many noncanning applications such as foil packaging, caps, convenience food containers and lids, yogurt tub lids, kitchenware, and laminates. Foil may be used for formed or semirigid containers. Aluminum foil is difficult to use on modern fast-packaging equipment because of creases, tearing, and marking effects. In practice, aluminum foil of fine



gauge may have minute pinhole defects due to the tolerances of the rollers, crystal size, and lubricants used, which allow transmission of air and water.

### 39.2.2.1 Canning

The most common use of metals for packaging is in tin and aluminum cans. The metal provides a highly effective barrier between the food product and the environment. Thus, the critical concepts of canning are to ensure that the product in the can is biologically stable and that the seal provided by the metal is complete. Food stability for nonpowders is usually achieved by thermal processing. Canning was invented by Appert in the nineteenth century in response to the need to supply Napoleon's army with good-quality food. He used glass bottles, but Durand (English) used metal and pottery at about the same time. The two ideas together gave us tin cans.

Tin cans are made of sheet steel coated with 0.5 mm tin. The coating is applied by tinning, which is electrolytic deposition of the tin at about 10 g/m<sup>2</sup>, and hot dip, which uses about 30 g/m<sup>2</sup>. The steel is rolled and ribbed (for added strength) and either sealed with solder (usually 95% lead, 5% tin), or, more commonly, welded. The resulting tube ends are flanged, and the lids at both ends are attached by a double seam without solder. Since steel corrodes rapidly in the presence of acidic substances, the tin acts as a barrier. Some cans are lacquered internally for high-acid products (pH < 3) or for products that change color in the presence of tin. Foods that contain sulfur produce a blackening of the tin. The steel can provide almost perfect barrier protection and, because of its structural strength and ability to handle pressure, can be retorted (cooked under pressure) after sealing.

In competition with traditional tin-plated steel cans, modern cans may be made from tin-free steel, aluminum, or laminates. Laminates or composite cans are often fiber-foil containers, such as helical-wound tubes, with metal ends. The fiber may be paperboard. The first layer would be the liner, followed by other layers until finally, the printing layer is wound on. The layers are sealed together with adhesives, which generally contribute the majority of the structural strength.

The closure is traditionally the seamed lid, to be opened by the consumer with a can opener. A major development in canning has been the customers' preference for convenience over cost, so that pull tabs (now out of favor because of pollution), zip tops, pop tops, and ring pulls (where the ring remains attached to the can) have been adopted. Other examples are sardine cans (peel-back lids using a key to lever open the lid) and the recently developed FAEZO cans, where a ring tab is used to peel back the entire top lid. The lid is scored during manufacture to a precise metal thickness—too thick and the can is difficult to open, too thin and the package integrity is endangered.

Not all cans are retorted. The term "general line" is used for containers that are not hermetically sealed for heat processing, which account for about 16% of the tinplate market worldwide. Advantages of tinplate here are strength (impact, puncture), barrier, formability, printability, and product compatibility. They tend to be used for higher-value products, as the painted tin can look very effective. The processes of manufacturing steel cans are described well in many textbooks and will not be covered here. Aluminum can manufacture is described below.

### 39.2.2.2 Aluminum

#### 39.2.2.2.1 Introduction

Aluminum is used increasingly for canning due to its lightness, low cost, corrosion resistance, availability, and recyclability. Aluminum is also used extensively in many noncanning applications such as

1. Foil packaging, e.g., chocolate, household, or industrial foil
2. Bottle closures and overwraps, e.g., caps and wine bottles
3. Convenience food containers and lids, e.g., frozen-stored/oven-heated, single portion sizes, yogurt tub lids
4. Kitchenware, e.g., saucepans and cutlery
5. Special applications, e.g., shrimp freeze blocks
6. Laminates

#### 39.2.2.2.2 *Properties*

Aluminum makes up 7.9% of the earth's crust and is attacked by acidic solutions (especially food acids—pH <4). Special inks had to be developed to work with aluminum due to its smooth metal surface and high reflectance. A common solution with formed containers is to put all the print on the lid. The main properties of aluminum are lightness (three times lighter than steel), strength (alloys are as strong as steel), corrosion resistance, electrical conductivity (twice that of copper), appearance, and ease of recycling. It has the barrier properties of steel, but without the corrosion problem. It is highly attractive in appearance, as it reflects about 85% of the incident light, so stands out from other products. It can be bonded with paper (e.g., chewing gum and cigarette wrappers) to allow easier printing. It has excellent strength so that thin films can be made. It can be extruded into complex shapes, such as roof guttering.

#### 39.2.2.2.3 *Manufacture*

Aluminum foil became common after the electrolytic method of extracting aluminum metal from bauxite was developed independently by Hall in the United States and Heroult in France in 1883. Bauxite contains 75% hydrated alumina ( $\text{Al}_2\text{O}_3$ ) in mono- and trihydrate forms as well as oxides of iron, silicon, clay, etc.

#### 39.2.2.2.4 *Aluminum Foil*

Foil may be used for formed or semirigid containers. Many instant meals are packed in cooking and eating trays made of aluminum, with different compartments commonly formed in the tray to separate the meal components, especially with frozen foods. Aluminum foil is made of solid sheet aluminum rolled to a thickness of less than 0.15 mm and sold on cardboard rolls. For food applications, it is sold at high purity (99.8%) except for formed containers, where it is strengthened (like steel) by the addition of 1%–1.5% manganese. After rolling, the aluminum is work hardened, so it is brittle and crinkly. The aluminum can be softened by slow heating and slow cooling (annealing, about 24 h heating at 300°C, which also cooks off the processing lubricating oils, then 24 h cooling is typical), giving a soft metal of low strength and high flexibility (ductility) suitable for household use and most other food applications—this is called zero temper. By rolling and strain hardening (“quenched” when hot), a more brittle, stronger material is produced. This is called H temper, with a number added according to the degree of hardening. Hard tempers must be used whenever a high degree of forming is required. The metal may also be normalized, a process of air-cooling heated metal that is intermediate between quenching and annealing.

#### 39.2.2.2.5 *Foil Laminates*

Aluminum foil is difficult to use on modern fast-packaging equipment because of creases, tearing, and marking effects. Thus, additional treatments are common. Lamination can be difficult for the same reasons, but once laminated the resulting plies have excellent machining and visual properties. For example, sodium silicate may be used to glue foil to vegetable parchment (cigarette foil). The foil may be printed, coated, seal applied, and laminated in a step called converting. The web may also be embossed (embossing roller), giving a textured matte appearance, which reduces glare and makes separation in refrigerated storage easier.

#### 39.2.2.2.6 *Rigid Foil Containers*

Rigid aluminum foil containers have varying strengths, but offer the ultimate in convenience for all food processing, packaging, display, and consumer requirements. They are produced as follows. The foilstock (after hot-rolling) is cold rolled to 7  $\mu\text{m}$ , the final rolling being two-ply. The plies are separated and annealed (cold rolling causes high degrees of work hardening). The foil may then be coated. The web is then slitted to size and then die-formed using complex dies, which control the degree of drawing of the aluminum to retain uniform strength. Lids may be cardboard laminated with aluminum. They are not affected by heat, and can be heated, immersed, and frozen.

#### 39.2.2.2.7 *Pinhole Defects*

In practice, aluminum foil of fine gauge may have minute pinhole defects. The aluminum foil is graded according to the number of defects as: grade 0, <200 holes/m<sup>2</sup>; grade 1, 200–900 holes/m<sup>2</sup>; grade 2,

900–3000 holes/m<sup>2</sup>; and grade 3, >5000 holes/m<sup>2</sup>. The size of the holes is also significant. For this reason, aluminum is commonly bonded with PE for commercial food-packaging applications, so that thicknesses of the order of 10 µm can be used. The resulting barrier properties are far superior to those of plastics and plastic laminates.

#### 39.2.2.2.8 Aluminum Tubing

Aluminum is also used for squeezable tubes (e.g., toothpaste or tomato paste tubes). However, this use is becoming less common due to the following problems:

1. Neck finishing is expensive.
2. Inks tend to crack and peel off after squeezing.
3. Some products are affected by aluminum, so a lining may be necessary.
4. Plastic laminates cost about 20% less.
5. Aluminum tubes are more subject to contamination.

Plastic laminates (usually including a foil layer) are increasingly being substituted for products such as sauces, peanut butter, cheese, etc. The main problem with aluminum tubing has been the integrity of the side seam.

#### 39.2.2.2.9 Aluminum Cans

Cans are made by cutting a blank (a disk of aluminum) from coiled sheet, the skeletal web being recycled, and then drawing the blank into a cup. The walls may then be ironed by forcing the cup through a series of annular rings (dies) until the cup has the required height (drawn and wall-ironed [DWI] process), with a bottoming die forming a raised dome in the base. Alternatively, the cup may be redrawn, giving a thicker wall (drawn and redrawn [DRD] process). The thinner walled (DWI) cans are suitable for carbonated beverages, while DRD cans are suitable for steam sterilization and retorting. The body shell is trimmed to length, chemically washed, and then given a chemical etch primer (chromate phosphate) so that later coatings will stick. The lid (two-piece design) is then added.

The can may have a reduced neck diameter for improved appearance, better stacking, and saving metal. Ring-pull tabs or FAEZO openings may be used. Printing may be done before drawing the can (i.e., on the blank), the ink design stretching with the can, or may be applied by offset printing to the final can. Lacquers (e.g., vinyl or epoxy) may be applied internally for acid products to prevent interaction between the product and the can and externally for protecting the ink and providing the right slip properties on the base. The final can has a base thickness of about 0.020 inch and a wall thickness of 0.0065 inch.

#### 39.2.2.2.10 Current Research

Some areas of current research are dent recovery (using laminates), foil machinability, pinhole defects, closure opening force, and recycling (Australia has the highest recovery rate in the world). Apart from cans, aluminum recycling is difficult due to lamination with other materials, food and moisture contaminants, and the low value and volumes of material, so the trend is to reduce the amount of aluminum required. Foil food containers are difficult to microwave due to arcing and heat energy reflectance. However, there is some interest in developing aluminum food trays for microwave use. All packaging materials either transmit (glass, plastic, and paperboard), absorb (susceptors such as metallized polyester laminated to paper, useful for browning and crisping), or reflect (metals). Thus, the tray must be open to the microwave energy at the top, so that the food cooks more slowly but more evenly.

### 39.2.3 Glass

Glass containers used to be and still are considered a prestigious means of packaging, and serve for the most expensive wines, liqueurs, perfumes, and cosmetics. It is highly inert, impermeable to gases and vapors, and amenable to the most diverse shaping. In its normal state, it has the advantage of transparency,

but where required it can be given different desired colors. It has complete as well as selective light protection properties. Its main disadvantages are its fragility, heavy mass, and high energy requirement during manufacturing. In addition to its marketing strength, glass has other advantages that give it muscle in today's marketplace. It is an excellent oxygen barrier and completely neutral in contact with foods. Glass also fits well into the modern recycling society, since it can be recycled indefinitely. Glass packaging technology has developed to the extent that strength, minimal mass, color, and shape all have been improved. While glass will not supplant metal and plastic in volume, it is finding an increasingly strong niche at the high end of the food spectrum [5, 8].

### **39.2.3.1 History**

Glass was first manufactured by humans thousands of years ago, possibly as an offshoot of pottery as glazes, and dates to 12,000 BC. Pressing glass in molds to form cups or bowls dates from 1200 BC and blow piping was invented by the Phoenicians in 300 BC. In the third century AD, clear glass was discovered, for example, cast glass using flat stones, used for church windows. Until the Industrial Revolution, glass was mainly used for high-quality tableware.

With mass production, however, glass started to become ubiquitous, first through the cork-sealed narrow-necked bottle, then from about 1850 on the wide-necked jar, and from 1920 the screw top jar. The glass bottle is an almost ideal form of packaging for a large variety of products. It is inert to most substances; the product is visible; the cylindrical shape is good for loading, stacking, and holding; and it is cheap to manufacture and versatile in design.

The glass bottle is used for milk, jams, soft drinks, wines, beer, and spirits, and for many food products. It is highly inert, shows the product well, easily available, easy to mold, cheap, has almost perfect barrier properties (including barriers to odors), and is recyclable. However, it is brittle, and some product loss will occur through breakage. Because it is fragile, high weights are required per product unit, and for a while research was directed at reducing the high weight ratios by coatings (e.g., surlyn), which allow the glass to be handled at much higher packaging speeds. The coating reduced breakage, but this research ended when the PET bottle became available. More recently, environmental considerations have revived the idea. Over 75 billion glass containers are used annually by the food industries.

### **39.2.3.2 Glass Manufacture**

Glass is the result of heating silica, soda ash, and limestone to over 1500°C, with the small addition of minerals for color or strength. As the mixture melts, the compounds fuse and become easy to shape. This may be done by sucking the melt into heat-resistant molds or by blowing semimolten glass into rough shape in a mold and then pressing this into a second mold where a jet of compressed air forces the glass into the final shape. Crystallization is prevented by cooling the final product quickly, so that the final product is amorphous and thus transparent. Annealing is a process of reheating the glass, and then gradually cooling to remove stresses (also used for metals). Safety glass is laminated and toughened.

Special glasses include Pyrex, produced by the addition of borosilicate and having resistance to thermal shock, amber glass, used to inhibit ultraviolet radiation for beer bottles, and crystal with added lead (note that wine can leach lead from glass!). Glass may be corroded by application of hot concentrated alkali. Leaching tests for lead, cadmium, arsenic, and zinc are conducted on glass with high contents of these minerals, but in most cases the fusion process of glass production prevents traceable amounts of these elements from escaping. In general, glasses are not retortable due to thermal shock and the expense of Pyrex glasses, but if retorted must be cooled under pressure to prevent thermal shock.

### **39.2.3.3 Glass Containers**

The main components of the container are the cylindrical main part, the bottom, the neck (called the finish), the closure (the screw cap), and the label. The cylindrical shape is chosen for maximizing strength for a given volume (the sphere is a better shape but not convenient for packaging). Glass is not well suited for sharp corners as stresses tend to concentrate in areas of sharp curvature. The main components of the cap are a lacquer, wad, liner, and cover. Caps may be plastic or metal, and the type of closure might be

thread, lug, friction, snap-cap, roll-on, cork, crown, twist-off, etc. The various types of glass containers have a range of names:

1. Bottles (most used)—round, narrow neck to facilitate pouring and closure, for liquids and powders
2. Jars (wide-mouthed bottles)—neckless, allowing fingers or utensils to be easily inserted; used for liquids, solids, and nonpourable liquids such as sauces, jellies, and pastes
3. Tumblers (open-ended jars)—shaped like drinking glasses; used for jams, condiments, and jellies
4. Jugs (bottles with carrying handles)—short, narrow necks designed for pouring
5. Carboys (shipping containers)—shaped like short-necked bottles, usually used with a wooden crate holder
6. Vials and ampoules (small glass containers)—occasionally used for spices, etc., but mainly used by the pharmaceutical industry

The main uses of glass for packaging are in milk bottles, condiments, baby foods, instant coffee, and drinks. Glass is not used for frozen products, or for ground or roasted coffee because of breakage costs and the difficulty of vacuum flushing.

### **39.2.4 Timber, Cardboard, and Papers**

Pulp products are widely used in food packaging in the form of different kinds of paper, paperboard, laminates, and corrugated board. The main advantages of paper are its low cost, low mass, relatively high stiffness, and excellent printability; the main disadvantage is its high sensitivity to moisture, reflected in close dependence on the relative humidity of the environment [5].

The basic raw material for papermaking is cellulose. The cellulose molecule consists of a long, straight chain of glucose units. Paper can be classified according to its surface properties into machine-dried, machine-glazed, or super-calendered papers. Great importance must be given to coated and laminated papers, particularly for difficult packaging conditions. All demands regarding special performance as a barrier against water or water vapor, for example, can be met by combination of paper and other materials. These are wax-coated, bitumen-coated, and plastic-coated papers. Other special types of paper include glassine, greaseproof paper, vegetable parchment, and waxed papers. Glassine is used extensively because of its inherent resistance to grease, oils, and fats, and is the densest paper made [2,5]. Paper laminations commonly used include paper/aluminum, paper/plastic, and paper/plastic/aluminum.

Use of wood in packaging today is rather limited, confined primarily to crates, large boxes, and pallets. Its major advantage is its strength, but it is quite expensive and cheaper alternatives, such as corrugated board, have been found adequate for many applications. Even pallets, which used to be made exclusively from wood, are made today in part from foamed plastics [5].

#### **39.2.4.1 Timber**

Wood is commonly used in box construction, but the use of wood for individual packaging (such as cigars) has decreased since the advent of plastics. Examples of timber for packaging are cases, boxes, and casks for long-distance transport.

#### **39.2.4.2 Cardboard**

The next choice of packaging material to be considered is cardboard. This may be a protective package (see previous section) or a presentation package. Folding carton construction consists of taking a two-dimensional flat piece of board (excellent for storage) and cutting, scoring, folding, and then gluing (or locking) it into a three-dimensional rigid box. The cardboard will usually be laminated to paper to allow printing and presentation.

For transport purposes, the fiberboard must resist relative humidity and temperature effects. Relative humidity affects the moisture content of the board (which is hygroscopic), raising it from 6%–7% safe

moisture (at manufacture) to 14%, at which point the board becomes like a piece of rag. Temperature strongly influences the rates of diffusion of gases and moisture into the package. Thus, the transport requirements will depend on ambient conditions. The board should be designed for the optimum lifetime of the projected job.

The various elements of cuts, tucks, locks, flaps, and folds may be assembled in an endless variety of ways, although the most common is rectangular for packing and storage convenience. Since cardboard is obviously highly versatile, the details for construction vary widely. The actual specifications may include (a) grade of board, ink type, glue type (e.g., hot-melt glue or water-based), etc., (b) performance criteria, such as handling strength and crushing strength, and (c) size.

One of the major uses of cardboard is as corrugated cardboard, a concept developed by Albert Jones in 1871, adopting the method for making ruffles from collars and paper for sweatbands in tall hats. Jones hand-cranked paper, and in 1874 Oliver Long patented gluing paper to both sides of fluted paper. Corrugated cardboard consists of two linerboards, covering a central corrugated sheet. The linerboards are made of *kraft*, test liner, or low-grade pulp covered with kraft. The corrugated paper is made of straw paper or kraft paper. The main factor determining the board properties are the corrugations. A useful modification is the double- and triple-wall container, the corrugations on successive layers usually parallel. The board is usually printed at the time of manufacture.

Choosing a carton for a specific job depends on the capacity of the carton to meet the requirements for that job. There is a trend to replace subjective tests (e.g., cartons must run on certain packaging machines) with more scientific objective tests (e.g., compression strength). The choice of carton for a specific job will depend on:

1. Carton load, both the internal weight of the product and the external load applied.
2. Warehousing conditions, such as stack heights and ambient warehouse conditions.
3. Storage life.
4. Type of handling, e.g., fork, manual, and palletizer.
5. In-use conditions (especially RH).
6. Item size, determining critical dimensions of the carton.
7. Maximizing pallet efficiency by using the available space.
8. Size and style: accuracy of the dimensions, which affects packaging machine performance (e.g., 1/64 inch), prefolds, print areas, etc.
9. Protective properties: different cartons protect against different agents, e.g., moisture or odor. These vapors can enter/leave through the cardboard itself, the creases, the glue seals, or the gaps between folds. Moisture vapor protection (MVP) is generally achieved through waxing the cardboard and is measured in terms of the resulting water vapor transfer rate (WVTR) measured in  $\text{g/m}^2/\text{day}$ .

A waxed board is difficult to print on, so the board may be laminated with white paper.

#### 39.2.4.2.1 *Glue*

The glue must be chosen that will seal within the time the box is in the packaging machine. A common glue is dextrin, which is water based, the water being absorbed into the cardboard as the glue sets. Hot glues may also be used.

#### 39.2.4.2.2 *Inks*

The inks used must be of the specified hue (and reproducible), resist fading, and resist rubbing.

#### 39.2.4.2.3 *Opening Cartons*

For ease of use, some quick reliable means of opening the carton are usually built in. Examples are perforated thumbnail openings, fold-and-tear openings designed to assist pouring, and designated areas for cutting.

#### 39.2.4.2.4 Board Strength

The board must be strong enough for packaging, handling, storage, and intended use. It creates a bad impression with the user if the pack bulges, so bulge strength is important. The board must also resist compression and a degree of impact. The strength of the cardboard chosen for the protective package is related to the strength of the product package, so that if a weak carton is used, a strong external box is necessary for delivery to the point of sale. Note that the air moisture content (relative humidity) has a large effect on the strength of cardboard. Other problems with cartons include pallet integrity, ropes denting boxes, weak cartons (bottoms fall out), pallet stack collapse (compression), overweight cartons, and forklift damage.

### 39.2.4.3 Papers

#### 39.2.4.3.1 History and Manufacture

Paper bags were used in the seventeenth century. A bag-making machine was developed in 1852 by Wolle in the United States. The gusseted bag (1873) and multiwalled bag (1925) were important later developments. Paper is defined as sheets of material thinner than 0.23 mm and lighter than 220 g/m<sup>2</sup>. Paper and board are produced from wood pulp (treated with calcium bisulfite or caustic soda to break down the lignin structure), rags, and other waste. Paper is decomposed by bacterial action over a period of time. Thus, paper is ultimately environment friendly. However, paper has had tough competition as a packaging material over recent years due to extensive use of plastics. Treatments of paper to make it more competitive include paraffin and waxes (waterproofing) and plastic coating (added strength, water and gas resistance). Paper can also be laminated with aluminum.

Paper is produced from wood pulp, treated by the addition of soda, calcium sulfite, or calcium sulfate (depending on the end use). The pulp is milled into a continuous sheet and bleached (chlorine, caustic soda, and sodium hypochlorite). After drying, it may be treated with various chemical coats to enhance its performance. Paper is designated by the weight of a ream of paper of given size. Usually, a ream is 500 pages, but variation in size makes it difficult to directly compare two papers. For printing, the standard size is 24 × 36 inches (6 ft<sup>2</sup> or 0.55742 m<sup>2</sup>). Some of the standard papers used are:

1. Bond papers (17" × 22"): soda pulp, uncoated bleached, finished to give wet strength and a good printing surface
2. Tissues (24" × 36"): lightweight semibleached or bleached, finished to give wet strength, with open or closed fiber formation
3. Litho papers (25" × 38"): smooth printing surface, but not as strong as bond paper, used in magazines
4. Kraft papers (24" × 36"): unbleached equivalent to bond paper, but of heavier basis weight (and hence greater strength), and cheaper

Other special types of paper include glassine, greaseproof paper (glassine paper that has not been calendered and is free of wood pulp, water resistant, and heavily milled), vegetable parchment (boilproof and fat impervious, due to treatment with sulfuric acid), and waxed papers. This paper is not moisture-proof, so may be waxed or laminated.

Glassine is used extensively because of its inherent resistance to grease, oils, and fats and is the densest paper made. It is made from straw, which is pulped and purified, then hydrated at high temperature until it partly gelatinizes. The resulting sheet is fed into a calendar, where it is rolled under high-pressure steam to give a transparent paper. It can be laminated. It is used for dry products such as cereals and biscuits after being waxed (paraffin).

Paper laminations commonly used include paper/aluminum (for strength and excellent resistance to moisture and air) and paper/plastic (good for heat sealing as the plastic can bond across the seal, but also good for writing on). Regenerated cellulose is cellulose precipitated out of solution. Cellophane is clear cellulose regenerated from a viscose solution.

### 39.2.4.3.2 Paperboard

Waste paper can be used to produce board for cartons. Some types are:

1. Chip board: waste paper blended with wood pulp to give a flexible gray board (not suited for printing)
2. Manila-lined board: a top liner of ground wood pulp covering newspaper or other waste paper pulp; this can be printed on
3. Clay-coated board: same as manila-lined, except that the top liner is coated with white mineral powder bonded to the surface; this important innovation, coupled with fast electrostatic printing, has allowed the carton to be an attractive way of presenting goods

Waste paper may also be turned into paper pulp for molding, e.g., in egg cartons, molded trays, and vegetable holders. Recycled paper is weak and discolored, making it poor for packaging. It must be used in conjunction with virgin paper. Recycled cardboard does not crease accurately, so boxes cannot be erected as accurately or quickly.

### 39.2.5 Ceramics

The term ceramic describes any nonmetal nonorganic material produced by high temperatures, such as glass and pottery. The raw material is molded into the required shape and then fired. Once fired, the material cannot be easily modified as it is brittle and inert. If the material has been applied in a thin coat to another substance before firing, it is called a glaze. The most common use of ceramics in the food industry is, of course, pottery.

The chemical composition of most ceramics is silica ( $\text{SiO}_2$ ), alumina ( $\text{Al}_2\text{O}_3$ ), and water. Glass is almost pure silica, whereas clays have large amounts of alumina present. The main chemical structure of the fired product is the tetrahedral  $\text{SiO}_4$  complex, although other stable structures like this may be present. Most clays are reddish brown, due to the presence of iron, the exception being kaolin (China clay).

During firing, the clay shrinks as water is removed. Thus, control of the amount of water in the clay is important, and an initial drying stage is necessary to remove unbound moisture before firing. The firing temperature is also critical. For pottery, it should be above  $1000^\circ\text{C}$ . This is well below the melting point of the clay, but is high enough to cause the clay structure to break down into  $\text{Al}_2\text{O}_3$  and  $\text{SiO}_2$  molecules, which then react exothermally (sintering). A glass resulted from complete melting and then cooling.

Vitreous enamel is a finish applied to metals. This is done by coating the metal in powdered glass and then heating above the melting point of the glass. Legislation nowadays prevents the use of cadmium or lead in vitreous glazes.

### 39.2.6 Metallized Films

Plastic films can be formed by lamination, coextrusion, or impregnation. No single film can satisfy all packaging requirements. Lamination is a technique for bonding films together to give a film with the properties of multiple constituents. By combining the qualities of choice from the raw material films, a laminate can be tailor-made for its particular application. Each layer in the resulting laminate may exhibit different properties from its free state, such as mutual layer reinforcement in which cracks in a brittle layer are prevented from propagating by a high elongation (elastic) layer. The effect depends on good adhesion between the layers [2]. Coatings are often used to enhance plastic film properties such as printability. Aqueous and solvent coatings are applied to the substrate through water dispersions or emulsions, solvent solutions, or waxing.

Aluminum-metallized films are extensively used in food packaging applications, and compared with films containing aluminum foil. Metallization has the following advantages: (1) lower environmental impact due to a significant reduction in the amount of raw material used and the recyclability of metallized film scrap as part of the base material, (2) greater flexibility and resistance to flexion, and (3) impressive presentation. In contrast with polymeric films, the main disadvantage of metallization is its



low resistance to flexion and extension [1]. At present two other major limitations exist: foods cannot be cooked in a microwave oven within the package, and the opacity of the finished films can be a handicap for some products in which appearance is as important as quality. Thus, packaging manufacturers are looking for good barrier characteristics without compromising transparency to light and microwaves. Transparent films with excellent barrier properties have been achieved by coating with aluminum oxide or silicon oxide [1]. Silicon-oxide-coated film helps in extending product shelf life by maximizing flavor, color, and vitamin C retention, and permitting higher filling temperatures.

---

## References

1. Catala, R. and Gavara, R. 1997. High-barrier polymers for the design of food packages. In *Food Engineering 2000*, P. Fito, E. Ortega-Rodriguez, and G. V. Barbosa-Canovas (Eds.), Chapman & Hall, New York. pp. 327–345.
2. Driscoll, R. H. and Paterson, J. L. 1999. Packaging and food preservation. In *Handbook of Food Preservation*, M. S. Rahman (Ed.), Marcel Dekker, New York. p. 687.
3. Herbert, D. A. 1984. Developments in the packaging of heat processed foods. In *Profitability of Food Processing*. The Institute of Chemical Engineers, UK. pp. 343–351.
4. Mannheim, C. 1987. Interaction between metal cans and food products. In *Food Product-Packaging Compatibility Proceedings*, J. I. Gray, B. R. Harte, and J. Miltz (Eds.), Technomic Publishing Company, PA. pp. 105–133.
5. Miltz, J. 1992. Food packaging. In *Handbook of Food Engineering*, D. R. Heldman and D. B. Lund (Eds.), Marcel Dekker, New York. pp. 667–740.
6. Nordmark, B. 1998. The miracle material from the 20th century: plastics, the safe barrier. *Food Technology in NZ*. October: 10–13.
7. Stollman, U., Johansson, F., and Leufven, A. 1994. Packaging and food quality. In *Shelf Life Evaluation of Foods*, C. M. D. Man and A. A. Jones (Eds.), Chapman & Hall, London. pp. 52–71.
8. Robertson, G. L. 1993. *Food packaging, Principles and Practise*. Marcel Dekker, New York. p. 244.

Shyam S. Sablani and Mohammad Shafiur Rahman

**CONTENTS**

40.1	Introduction .....	939
40.2	Food Packaging Interaction and Safety .....	940
40.3	Migration of Package Components .....	941
40.3.1	Migrating Substances .....	941
40.3.1.1	Plasticizers .....	941
40.3.1.2	Thermal Stabilizers .....	941
40.3.1.3	Slip Additives and Surface Property Modifiers.....	942
40.3.1.4	Antiaging Additives.....	942
40.3.1.5	Optical Property Modifiers .....	942
40.3.1.6	Monomers and Oligomers.....	942
40.3.1.7	Contaminants.....	943
40.3.2	Prediction of Migration .....	943
40.3.3	Migration Testing and Analytical Methods .....	945
40.3.4	Factors Affecting Migration.....	945
40.3.4.1	Glass Transition Temperature of Polymers .....	945
40.3.4.2	Solubility of Migrant at the Polymer–Food Interface.....	945
40.3.4.3	Dispersion into Bulk Food .....	945
40.4	Food and Packaging Material Interaction .....	946
40.4.1	Metal–Food Interaction .....	946
40.4.2	Paper–Food Interaction .....	947
40.4.3	Plastic–Food Interaction .....	948
40.4.4	Stickiness and Packaging.....	950
40.5	Safety and Legislative Aspects.....	950
	References .....	951

**40.1 Introduction**

Packaging materials are used to protect the food during storage and distribution. The package may provide protection for microbiological, chemical, and physical contamination. However, most packaging materials used for foods are not inert and reaction may occur between food and package material. Components of the packaging material must be safe to the product as well as to the consumers. Food may interact with the packaging materials and this may change the initial mechanical and barrier properties as well as the safety of the product. This interaction may be classified into three main phenomena: migration, permeation, and absorption. In packaging regulations, the term migration is used to describe the transfer of package components from the package to the contained food product. A distinction is usually made between global migration and specific migration. Global migration refers to the total transfer, i.e., the quantity of all substances migrating from the package into the packaged food, whereas specific migration relates to the transfer of one or more identifiable substances that is a constituent

of the packaging material [32]. The volatiles such as flavors and aromas are lost by means of permeation and absorption, and this may directly affect the food quality. The permeation of polymeric film depends on the solution and the transport behavior of gas and vapor. The packaging materials can also absorb flavor compounds from products, the loss of which results in a reduced perception of quality.

## 40.2 Food Packaging Interaction and Safety

The use of packaging materials is not without risk to human health or loss of quality to the contained food. Food products may undergo loss in quality due to failure of the package or product–package interaction. Package failure can result from inadequate barrier properties for the intended shelf life or from loss of integrity during distribution [39]. Improper use or selection of packaging materials can increase the risk associated with packaged food products. For example, package failure due to loss of integrity can greatly increase the risk of microbial contamination and potential food poisoning. The migration of potentially toxic substances from packaging material to contact phase is also a major concern in the selection and use of materials for food packaging because of the possible effect upon human health. In addition, migration of other components from packaging materials, which are not harmful to human health, may adversely reduce the quality of products [39]. The sorption of fats or organic acids by the food-contact layer in a polymer laminate can cause separation (delamination) of different layers of the laminate. Other sorbed compounds might swell the polymer, acting as plasticizers, resulting in increased diffusivity, and thereby a higher permeability [72].

Product–package interaction results from one of the several modes. A complete scenario is shown in Figure 40.1. In specific situations, product components may penetrate the structure of the packaging material, causing loss of barrier and mechanical properties. Further, the migration of low-molecular-weight components from packaging material to a contained product can result in flavor loss or color change. In addition, a packaging material undergoing oxidation can also accelerate the oxidation of products in contact with that material. Packaging materials can absorb flavor compounds from products, the loss of which results in a reduced perception of quality; thus scalping of flavor compounds is a concern for many aseptic products currently being packaged. For example, citrus products contain volatile, highly aromatic compounds. When these compounds are selectively removed by the packaging material, they no longer function as flavor components and thus the perceived quality of the product is

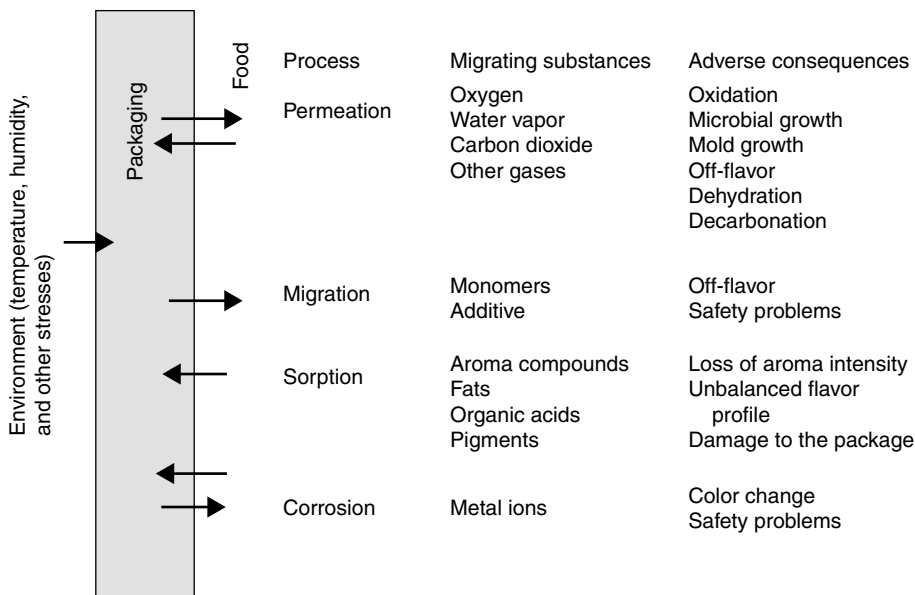


FIGURE 40.1 A complete scenario of product–package interaction resulted from several modes.

diminished due to the loss of aroma intensity or the development of an unbalanced flavor profile [72,84]. Another problem associated with absorption of flavor components by packaging materials is the influence of that absorbent on the barrier characteristics of the packaging material. Relatively minor increases in the concentration of the organic vapor lead to large increases in the permeability of the packaging material. Food contact material may be responsible for autocatalyzed oxidative reactions in products.

### 40.3 Migration of Package Components

#### 40.3.1 Migrating Substances

Substances that usually migrate from packaging materials to food are plastic additives, monomers, oligomers, and contaminants. To improve manufacturability, a wide variety of additives are used during processing of the polymeric-based packaging materials. This includes plasticizers, antioxidants, light stabilizers, thermal stabilizers, lubricants, antistatic agents, and slip additives, migrating solvents, such as adipic acid, toluene, butanone-2, ethyl acetate, hexane, and pigments such as molybdate orange [1,54].

##### 40.3.1.1 Plasticizers

Plasticizers are a group of additives used in plastic materials to improve their flexibility. The plasticizer also gives the material the limp and tacky qualities found in “cling” films. Butyl benzyl phthalate (BBP), di-*n*-butyl phthalate (DBP), dicyclohexyl phthalate (DCHP), di(2-ethyl)hexyl phthalate (DEHP), diheptyl adipate (DHA), heptyl adipate (HAD), and heptyl octyl adipate (HOA) are types of plasticizers commonly used (Table 40.1). About 80% of all plasticizers are used in polyvinyl chloride (PVC). Typically, phthalic esters such as dioctyl phthalate (DOP), also known as di-2-ethylhexylphthalate (DEHP), and dioctyl adipate (DOA) or di-2-ethylhexyladipate (DEHA), are used. The migration of such plasticizers from plastics into food has been reported in the literature. As a result, packaging industry has replaced PVC with other polymers, such as PE or regenerated cellulose not associated with plasticizers [1].

##### 40.3.1.2 Thermal Stabilizers

Thermal stabilizers are used in plastics to retard decomposition during processing. Generally, epoxidized seed and vegetable oils, such as soybean oil (epoxidized soybean oil, ESBO) and sunflower oil, are widely used in a range of food contact plastics, heat stabilizers, lubricants, and plasticizers [11]. Materials such as PVC,

**TABLE 40.1**

Type and Concentration of Plasticizers Found in Some Packaging Materials

Packaging Material	Thickness (cm)	Plasticizer	Concentration of Plasticizer ( $\mu\text{g}/\text{dm}^2$ )
Cellulose acetate	0.003	BBP	1250
		DBP	1840
		DCHP	2090
		DEHP	1620
Cellulose acetate	0.004	BBP	2050
		DBP	3170
		DCHP	3340
Cellulose acetate	0.004	DBP	4840
		DCHP	6480
Polyvinylchloride copolymer	0.002	DHA	2240
		HAD	2550
		HOA	2680

BBP, butyl benzyl phthalate; DBP, di-*n*-butyl phthalate; DCHP, dicyclohexyl phthalate; DEHP, di(2-ethyl)hexyl phthalate; DHA, diheptyl adipate; HAD, heptyl adipate; and HOA, heptyl octyl adipate.

Source: Adapted from Lau, O.-W. and Wong, S.-K. (1997) *Analytica Chimica Acta* 347: 249–256.

poly(vinylidene chloride), and polystyrene (PS) frequently contain epoxidized oils levels ranging from 0.1% to 27%. Their toxicity is strongly affected by their purity since the residual ethylene oxide is quite toxic [54].

#### **40.3.1.3 Slip Additives and Surface Property Modifiers**

The tendency of polymers such as PVC, polyolefins, and PS to stick to metals during processing can be reduced by adding slip additives such as fatty acid esters and amides, polyethylene waxes, metallic stearates (e.g., zinc stearate), and paraffin. Slip additives are added to plastic formulations, but they gradually manage to emerge and tend to bloom to the surface. They impart useful properties, including lubrication, to prevent films from sticking together or forming conglomerates and reduce the static charge [54,83]. Many packaging films tend to stick together because they are nonconductors of electricity. This blocking tendency can be reduced by the addition of organic amides, such as erucamide, and metallic soaps, such as zinc stearate. In some food packaging applications, moisture tends to condense as droplets and obstruct the view of the pack contents. The addition of nonionic ethoxylates or hydrophilic fatty acid esters, such as glyceryl stearate, promotes the deposition of continuous films of moisture.

#### **40.3.1.4 Antiaging Additives**

Aging is the process of deterioration of materials resulting from the combined effects of atmospheric radiation, temperature, oxygen, water, microorganisms, and other atmospheric agents (e.g., gases). Bosset et al. [10] reviewed the influence of light transmittance of packaging materials on the shelf life of milk and dairy products. Antioxidants are used to slow down the oxidation process of plastics, which is due to light exposure. Butylated hydroxytoluene (BHT) and Irganox 1010 are the most commonly used antioxidants. Grade et al. [31] characterized the migration of antioxidants from polypropylene into fatty food simulants. Huang and Weng [43] studied the inhibition of oxidation in fish muscle by antioxidant-incorporated polyethylene film. Antimicrobials such as algaecides, bactericides, and fungicides can be added to polymers to prevent the growth of microorganisms. UV stabilizers are used to prevent deterioration of polymeric films by photooxidation [79]. They act by absorbing high-energy UV radiation and releasing it as lower energy radiation. Ozdemir and Floros [76] reviewed the active food packaging technologies.

#### **40.3.1.5 Optical Property Modifiers**

These are used to modify the ability of plastic to transmit light, exhibit color, and reflect light from surface (i.e., gloss). Some of the pigments for use as colorants in packaging are carbon black, white titanium dioxide, red iron oxide, yellow cadmium sulfide, molybdate orange, ultramarine blue, blue ferric ammonium ferrocyanide, chrome green, and blue and green copper phthalocyanines. Owing to potential migration of colorants from plastic into food, the FDA has questioned the use of some of these colorants.

#### **40.3.1.6 Monomers and Oligomers**

Monomers and oligomers are likely to migrate from packaging material to food [1,54]. Monomers are reactive substances, with respect to living organisms, and hence, potentially toxic. Therefore, hygiene regulations aim at restricting the content of residual monomers in the raw and starting materials, plastics and articles are made therefrom. Residual monomers are always present in PS and several adverse and harmful effects are attributed to styrene. Vinyl chloride monomer is highly toxic, the levels of which in PVC food packaging materials are closely controlled. Epoxy resins of the bisphenol A type, such as bisphenol A diglycidyl ether (BADGE), intended to use as articles or components of articles are considered for use in manufacturing, packaging, and transporting food. Because of their high toxicity, it is necessary to control their migration into food. Other compounds, such as isocyanates used in polyurethane polymers, and adhesives are toxic and their health effects are well documented. Polyamides can also migrate into boiling water, and it is nontoxic but imparts bitter taste to foods. Polyethylene terephthalate (PET) is commonly used as packaging material for beverages and edible oils. Standard limit has also been established for migration of compound from PET packages.

### 40.3.1.7 Contaminants

Apart from additives and monomer residues present in the packaging materials, other sources of food contamination have also been reported. These are mainly decomposed products from additives and monomers that may also migrate into foods. Some of the compounds are diphenylthiourea, benzene dioxins, hydrogen peroxide, and other volatiles [1].

### 40.3.2 Prediction of Migration

The amount of migrants into food can be predicted by using a mathematical model based on diffusion. The mathematical models are useful tools for identification of the factors affecting migration and in the design of package. Furthermore, a better understanding of the migration process will help in controlling and limiting chemical contamination of food from packaging material [1,66]. The diffusion of migrants in polymer and food can be described using Fick's second law

$$D_p \frac{\partial^2 C_p}{\partial x^2} = \frac{\partial C_p}{\partial t}$$

$$D_s \frac{\partial^2 C_s}{\partial x^2} = \frac{\partial C_s}{\partial t}$$

where  $D_p$  and  $D_s$  are the diffusivity of migrant in the polymer and food phase ( $\text{m}^2/\text{s}$ );  $C_p$  and  $C_s$  the concentration of migrant in the polymer and food phase ( $\text{mg}/\text{g}$ );  $x$  is the space coordinates measured normal to the polymer–food interface ( $\text{m}$ ); and  $t$  the time ( $\text{s}$ ). The amount of package components that may migrate into liquid or solid food depends on the chemical and physical properties of food and package. Various factors like migrant concentration, molecular weight, solubility, diffusivity, partitioning coefficient between polymer and food, time, temperature, polymer and food composition, and structures (density, crystallinity, and chain branching) control migration. Several semiempirical diffusion-based mathematical models have also been suggested (Table 40.2).

Briston and Katan [13] divide migration into three classes based on the limiting control mechanism—class 1: nonmigrating materials with or without the presence of food; class 2: independently migrating, which is not controlled by the food, although the presence of food may accelerate the migration; and class 3: leaching, which is controlled by the food, negligible in the absence of food, and significant in its presence. There is no absolute cutoff between these various classes and the definitions of words like “significant” can influence where they will be placed [24]. Class 1 was applied for diffusivity of less than  $10^{-15} \text{ m}^2/\text{s}$ . However, class 3 systems as those with diffusivity  $10^{-13} \text{ m}^2/\text{s}$  or higher in the presence of food. The migration process is fully described by the kinetics of migrant diffusion in each phase, expressed by diffusivity ( $D$ ) and the chemical equilibrium, expressed as partition coefficient,  $K$ , defined as the ratio of migrant equilibrium concentration in the polymeric material,  $C_p$ , to its equilibrium concentration, in the food phase,  $C_s$ .  $K$  is defined as

$$K = \frac{C_p}{C_s}$$

when  $K=1$ , the migrant concentration in food phase equals the concentration in polymeric phase, at equilibrium.  $K$  is higher when more migrants are absorbed into the polymer than in the food. From food safety point of view, a large  $K$  limits migration from packaging material to food; in contrast, a lower  $K$  indicates that more migrant is absorbed into food from polymer. However, to minimize flavor loss in a package, a low  $K$  is preferred. Parameters such as temperature, pH, chemical structure of migrant, molecular size and structure, fat content of foods, and degrees of crystallinity influence partition coefficient [92]. Lau and Wong [54] reported the values of  $K$  from 2.5 to 250 and  $D_s$  from  $1.1 \times 10^{-16}$  to  $2.7 \times 10^{-15} \text{ m}^2/\text{s}$  for three different plasticizers/food systems, being much larger in foods having high fat contents. Nielsen et al. [73] estimated  $K$  up to 22 for four aroma compounds in a water/LDPE system under different storage temperature. Widen et al. [101] studied the migration of model contaminants from PET bottles: influence of temperature, food simulants, and functional barriers.

TABLE 40.2

Selected Mathematical Models Proposed for Description of Migration of Substances

Model	References
$M_t = 2C_0\rho\left(\frac{D_p t}{\pi}\right)$	[1]
<p><math>M_t</math> is the total migrant from the polymer in time, <math>t</math> (s); <math>C_0</math> the initial migrant concentration in the polymer (mg/g); <math>\rho</math> the polymer density (g/cm<sup>3</sup>); <math>D_p</math> the diffusivity of migrant in polymer (cm<sup>2</sup>/s); and <math>t</math> the package life time (s).</p>	
$\frac{M_t}{A} = \frac{2\sqrt{D_s t} K C_0}{1 + K\alpha} \left[ \frac{1}{\sqrt{\pi}} - i\operatorname{erfc}\left(\frac{L}{2\sqrt{D_p t}}\right) \right]$	[58]
<p><math>\alpha = \sqrt{D_s/D_p}</math>; <math>K</math> = partitioning coefficient and <math>i\operatorname{erfc}(x) = \frac{1}{\sqrt{\pi}} \exp(-x^2) - x\operatorname{erfc}(x)</math></p>	
<p><math>D_p</math> and <math>D_s</math> are the diffusivity of migrant in polymer and food phase (m<sup>2</sup>/s); <math>C_p</math> and <math>C_s</math> the concentration of migrant in the polymer and food phase (mg/g); <math>L</math> is the thickness of polymer (m); and <math>t</math> the time (s).</p>	
$M_t = 2C_0\left(\frac{D_p t}{\pi}\right)^{1/2} \left[ \frac{\beta}{1 + \beta} \right]$	[94]
$\beta = K\left(\frac{D_s}{D_p}\right)^{1/2}$	
<p><math>t</math> is the storage time; <math>M_t</math> the amount of migrant; <math>K</math> the partitioning coefficient; <math>D_p</math> and <math>D_s</math> are the diffusivity of migrant in polymer and food phase; <math>C_0</math> is the initial migrant concentration in the polymer.</p>	
$\frac{M_t}{A} = \sqrt{D_s t} K C_0 \left( 1 - \frac{\sqrt{D_p t}}{3L} \right)$	[58]
<p><math>D_p</math> and <math>D_s</math> are the diffusivity of migrant in polymer and food phase (m<sup>2</sup>/s); <math>C_p</math> and <math>C_s</math> the concentration of migrant in the polymer and food phase (mg/g); <math>L</math> is the thickness of polymer (m); and <math>t</math> the time (s).</p>	
<p>Migration across recycled plastic and food film barrier</p>	
$M_t = \frac{2}{\sqrt{\pi}} \left[ C_p \left( 1 + \frac{b}{d} \right) - C_B \frac{b}{d} \right] \rho_p \sqrt{D_p} (\sqrt{\theta_r + t} - \sqrt{\theta_r})$	[30]
<p><math>b</math> is the thickness of the barrier; <math>d</math> the thickness of the recycled plastic; <math>C_B</math> the migrant concentration in the barrier layer; <math>\theta_r</math> the lag time of the migrant across the barrier layer; and <math>\rho_p</math> the density of the recycled plastic layer.</p>	
$M_t = C_{\text{sat}} \gamma_{\text{air}} \sqrt{\frac{Dt}{\pi}} \left[ 1.33\beta t - 0.54(\beta t)^2 + 0.15(\beta t)^3 + \dots \right]$	[56]
<p><math>\beta</math> is the kinetic factor; <math>C_{\text{sat}}</math> the saturated migrant concentration in the packaging material when exposed to saturated migrant vapor; and <math>\gamma_{\text{air}}</math> the ratio of migrant concentration in air to that of the saturated migrant concentration in air.</p>	
$C_{F,t} = \frac{A}{m_F} \rho_P C_{P0} \sqrt{D_P t}$	[3]
<p><math>C_{F,t}</math> is the estimated concentration, <math>\rho_P</math> the density of the plastic material, <math>D_P</math> the migrant diffusivity, and <math>(A/m_F)</math> the package surface area. <math>D_P = 10^4 \exp(A_P - aM_r - bT^{-1})</math>, where the coefficient <math>A_P</math> accounts for the effect of the polymer on diffusivity (<math>A_P</math> values for different polymers are 9 for LDPE, 5 for PP and HDPE, <math>\leq 0</math> for nonpolyolefins, <math>-7</math> for PVC, and <math>-3</math> for PC and PET). <math>M_r</math> is the substance relative molecular weight, <math>T</math> the temperature (K), and <math>a</math> and <math>b</math> are correlation constants for molecular weight and temperature effects on diffusivity bearing values of 0.010 and 10450, respectively.</p>	

**TABLE 40.3**

List of Food Simulants for Component Migration Study

Simulant A	Distilled water
Simulant B	3% acetic acid (w/v) in aqueous solution
Simulant C	15% ethanol (v/v) in aqueous solution
Simulant D	Rectified olive oil, sunflower oil, or HB307

Source: Adapted from Arvanitoyannis, I. S. and Bosnea, L. (2004) *Critical Reviews in Food Science and Nutrition*, 44: 63–76.

### 40.3.3 Migration Testing and Analytical Methods

Analysis of the migrant in the foods can be very expensive and time consuming because of the low concentrations of migrated substances found in the food and the complexity of the food matrix. Sophisticated analytical methods and protocols have been developed to study the migration of packaging components from

package or food-contacting material into the food. These procedures are not only important for quantification of migrants but also required to establish databases to evaluate changing residue levels as well as to calculate dietary intakes [4,5]. These methods and protocols have been approved by regulatory agencies such as the FDA and the EC. The analytical procedures involve sample preparation, extraction, cleanup, and a final determination using chromatographic or spectrophotometric analysis. Various analytical instruments such as high-performance liquid chromatography (HPLC), gas chromatography (GC), and GC–mass spectrometry (GC-MS) have been used for routine analysis. For example, HPLC methods are reported in the literature for the determination of bisphenol A in epoxyresins and diglycidylether of DGEBA in tin and 4,4-bis-(dimethylamino benzophenone) in paper and board. GC and GC-MS have been used in the determination of 4,4-bis-(diethylamino benzophenone) in paper and board, styrene dimmers/trimmer in PS cups, and mineral hydrocarbons in PS and wax paperboard. Owing to the complex nature of foods and variety of conditions arising from contact with package, a series of steps is necessary to quantify specific and overall migration. To simplify the process, regulatory agencies have approved the use of food simulants to carry out the migration study (Table 40.3). Bradley et al. [12] surveyed the method of test of caprolactam migration into foods packaged in nylon-6.

### 40.3.4 Factors Affecting Migration

#### 40.3.4.1 Glass Transition Temperature of Polymers

For contaminants coming from the surrounding environment, such as naphthalene or other volatile organics, the rate of migration is affected by the glass transition temperature ( $T_g$ ) of the polymer. At room temperature, polymers such as polyethylene and polypropylene with  $T_g$  lower than room temperature have large permeability for organic compounds compared to those with  $T_g$  higher than room temperature, such as PS and PVC.

#### 40.3.4.2 Solubility of Migrant at the Polymer–Food Interface

A migrant with greater solubility into food will have a smooth and continuous concentration profile at the polymer–food interface, which in turn will facilitate the rate of migration into the food. In contrast, if the migrant partitions poorly into the food, the migrant concentration profile may be discontinuous at the interface, which retards the rate of migration. Since most of the polymer additives and contaminants are fat soluble, the problem of food contamination due to migrating chemicals is more serious in fatty foods than in aqueous-based foods. Heirlings et al. [40] studied the influence of polymer matrix and adsorption onto silica materials on the migration of  $\alpha$ -tocopherol into 95% ethanol from active packaging.

#### 40.3.4.3 Dispersion into Bulk Food

Once the migrant molecules are solvated, they diffuse away from the interface and move into the bulk food. The migration at this stage as well as that for the two previous stages is driven mainly by entropy, a measure of randomness. Limm and Hollifield [61] demonstrated that mixing could increase the migration into food because mixing enhances kinetically migrant salvation by removing migrant from the interface thus reducing reprecipitation. However, the migrant solubility and diffusion coefficients



are the prime factors governing the dispersion of migrant into food, thus affecting the rate of migration as whole.

## 40.4 Food and Packaging Material Interaction

### 40.4.1 Metal–Food Interaction

Corrosion is the destructive attack on a metal through the chemical or electrochemical reaction with the environment. Since steel corrodes rapidly in the presence of acidic substances, the tin acts as a barrier. Some cans are lacquered internally for high-acid products ( $\text{pH} < 3$ ) or for products that change color in the presence of tin. Foods that contain sulfur produce a blackening of the tin. The steel can provide almost perfect barrier protection and, due to its structural strength and ability to handle pressure, can be retorted (cooked under pressure) after sealing [25]. The most important corrosion accelerators in foods include acidity, oxygen, nitrates, sulfur compounds, trimethylamines, anthocyanins, dihydroascorbic acid as well as severity of heat treatment and storage conditions [64] (Table 40.4).

Corrosion products in food cans are limited to three metals: tin, iron, and lead, which are liable to dissolve from the container. Of these only lead is toxic and cumulative in body tissues, hence a hazard. Lead content varies widely within and between food products. Even the raw material may contribute, although generally the level is well below the regulatory limits, which is 2 ppm for most foods, 0.5 ppm for baby foods, and 0.2 ppm for soft drinks [64]. In a survey, the lead content of 168 samples of acid foods was found to be in the range of 0.02–8.16 ppm, the average for lacquered cans being 1.45 ppm and for plain cans 0.46 ppm [64]. The shift from three-piece soldered cans to three-piece welded or cemented cans, or to two-piece cans, is completely eliminating the problem of lead migration from

**TABLE 40.4**  
Migrating Components from Packaging Materials (other than Polymer) to Food

Packaging Material	Migrating Component	Food	References
Wooden packaging	1-Propanol	Apples	[68]
Tin	DGEBA	Canned foods	[8]
Metals/plastics/glass/aseptic Recycled Paper and board Cans coated with lacquer	DIPNs Epichlorohydrin	Tomato	[15,95,96]
Paper cardboard and board	Metals (Zn, Sn, Al, Mn, Ba)	Test foods	[52]
Cartons (Al-laminated)	Al	Skimmed milk, yogurt drink	[28]
Aseptic	H <sub>2</sub> O <sub>2</sub>	Milk	[86]
Aluminum foil paper laminates	Phthalate esters (DBP, BBP, DEHP)	Butter, margarine	[78]
Cans	BADGE (lacquer)	Water-based simulants	[80]
Aluminum	Al	Food and drinks	[69]
Paper-based food packaging	2378-TCDD/2378-TCDE (polychlorinated dibenzofurans)	Fatty and nonfatty foods	[59]
Ceramic containers	Pb, Cd	Dairy products	[14]
Aluminum	Al	Milk	[88]
Cans	BADGE	Canned foods	[96]
Aluminum	Al	Dairy products	[88]
Paper and board	4,4-bis(dimethylamino) benzophenone (MK), 4,4-bis-(diethylamino) benzophenone (DBAB)	Dairy products	[16]

cans to foods [64]. Commercial tin–lead alloys used for soldering the seams of tin cans contain almost 98% lead. Thus, the possibility of lead migration into canned foods exists [64]. Canned infant foods are soldered with pure tin to avoid lead contamination, and welding is increasingly used instead of soldering for the same reason [64].

Iron, an essential constituent of our diet, does not constitute a toxicity problem, and a limit of 50 ppm is usually considered. Most of the tin present in canned foods is insoluble in the gastric and intestinal fluids and is not absorbed during digestion. In solid foods, high levels may occur. Metallic tin and its salts are considered to be low oral toxicity, whereas alkyl derivatives are highly toxic. Outbreaks of poisoning manifested by nausea, vomiting, and other gastrointestinal disturbances were traced to solid foods and drinks containing high levels of tin (hundreds of ppm). The 250 ppm level quoted in the past as permissible upper limit in canned foods is based not on toxicological evidence of safety, but rather on the fact that higher levels produce off-taste and are rarely found under normal conditions of processing and storage. The tendency today is to reduce it to 150 ppm. In lacquered cans, the tin content of the food rarely exceeds 100 ppm [64]. The detection of aluminum residue in sauces packaged in aluminum pouches [48] and in fresh and stored canned beer [100] was studied. Aluminum content of some foods and food products in the USA with aluminum food additives [85], and milk and milk products in comparison to other foods [89] were reviewed.

Migration in metal cans is primarily associated with transfer of compounds from solvents used for coating. Mesityl oxide, a solvent used to coat side seams, imparts a “catty” flavor defect to the packaged pork products. It interacts with free sulfhydryl groups of meat proteins and trace amounts of free hydrogen sulfide present in meat. Inophorone, a contaminant of can coating solvents, causes a “chemical” defect in canned milk beverages. Epoxy coatings are responsible for anomalous flavors in canned beers [33]. Soft drinks and especially beer are very delicate products, and their flavor and clarity are easily affected if in contact with tin, iron, or an unsuitable varnish. The taste of beer, for example, is adversely affected by dissolved iron above 0.1 ppm [64]. Goodson et al. [34] studied the migration of bisphenol A from can coatings—effect of damage, storage conditions, and heating.

Lubricants are normally used with tinplate to prevent abrasion and facilitate handling during conversion into containers. Typical lubricants contain fatty acids and esters prone to oxidation, and some oxidation products may be transferred to the packaged food [33]. Lubricants can result in stale, rancid, woody, and cardboard-like off-flavors in canned beer [51]. Such a compound is 2-nonenal, which has a sensory threshold of about 1 ppb.

#### 40.4.2 Paper–Food Interaction

Most documented cases of migration from paperboard or paperboard/plastic laminates pertain to components transferred from solvents and adhesives used for material and package fabrication or those transferred from inks used for printing [51,74,82]. Hydrocarbon-like off-odors were reported in doughnuts packaged with wax-coated paperboard dividers [82]. Solvents used for printing paper were implicated in the migration of solvent residues into packaged yogurt, resulting in a chemical taste [82]. The compounds migrated from the adhesive layer of aluminum-baked paperboard packaging caused off-flavors. A variety of odor-active (low sensory threshold) phenols and cresols, such as *p*-chloro-*m*-cresol, were identified [21]. Similarly, pentachlorophenol and methyl chloroform were traced in adhesives used for paperboard package fabrication [51]. Pentachlorophenol is used as a biocide in certain adhesives and causes a moldy off-flavor in food products. Moldy off-flavors due to the migration of 2,4,6-trichloroanisole into cocoa power packaged in paperboard containers have also been reported [51]. The paper or paperboard manufacturing process itself could result in the formation of potential migrants. These are chlorophenols (such as 2,4-dichlorophenol, 2,4,6-trichlorophenol, and 2,3,4,6-tetrachlorophenol) and two nitrosoamines (morpholine and *N*-nitrosomorpholine) [42,51]. The first group formed during bleaching, and the second carcinogen group was used as a corrosion inhibitor for boiler feed water. Other odor-active compounds that may be formed and released during heating of certain types of paperboard packages include acetone, 2,3-butadine, chloroform, furan, furfural, methylene chloride, carbon disulfide, and acetaldehyde. These compounds may be formed during bleaching and lignin removal phases of paperboard manufacturer [33].

### 40.4.3 Plastic–Food Interaction

Polymer materials are not absolute barriers. Interactions occur between foods, packages, and polymer materials. The types of polymer and aroma compound affect the degree of sorption. Other factors includes crystallinity of polymers, glass–rubber transition, environmental conditions, and composition of packaged food (fat content, pH, pulp content, and type of aroma compounds present) [47]. In case of plastics, the major source of concern is the component migration. Migration from plastics is mainly due to: (1) residual components and reactants from the manufacturing process, (2) compounds formed during conversion into packaging materials and packages, (3) additives incorporated for functionality, and (4) adhesives used during conversion [33,49] (Table 40.5).

Toxicological implications of component migration from packages into foods are another serious problem. Thus, food–package interaction is becoming an issue of increasing concern and research [33]. Most plastics contain residual monomers and other additives, some of which are suspected carcinogens (acrylonitrile, vinyl chloride, etc.). Several monomers have been linked with health problems, the most significant of these being vinyl chloride. The National Health and Medical Research Council standard in Australia is <50 ppb vinyl chloride for utensils, <10 ppb in film, and 0 ppb in foods [25]. Symptoms of vinyl chloride monomer poisoning are now well documented. If it is present in the air at a greater concentration than 500 ppm, then poisoning occurs [25]. Polycarbonate plastic is used in making food storage containers, and bisphenol A is a principal reactant in its preparation. Residual bisphenol A in polycarbonate bottles migrates to liquid foods and can be determined at low ppb levels [9]. In general, packaging materials can alter the flavor profile of packaged foods by absorbing flavor compounds, chemically reacting with food components to produce off-flavors, or releasing components that produce off-flavors into food.

**TABLE 40.5**

Migrating Components from Polymer Packaging Materials to Food

Packaging Material	Migrating Component	Food	References
PS	Styrene dimmers/trimmers	Instant food	[50]
PS cups	Styrene	Yoghurt	[71]
PS	Styrene	Water, milk, cold and hot beverages, olive oils	[91]
Polyester cookware	Benzene	Olive oils	[45,46]
PVC films	DEHA	Cheese	[65]
LDPE, HDPE, PP, microwave packaging	Irganox 1010 (I-1010) cPET	Food simulant liquids (FSL)	[6,36]
PVC films	Diocyladipate	Cheese sausages	[63]
PVC films	DEHA	Cheese	[70,99]
Polymeric material	Styrene	Dairy products	[2]
PP cups	DEHA	Dairy products	[29]
Polystyrene	Styrene/ethyl benzene	Dairy product	[27]
PP cups	2-Decanone	Cheese sauce	[38]
PS (+recycled material)	Monostyrene	Dairy products	[97]
PS+ABS+waxed paperboard	Mineral hydrocarbons	Dairy products	[18]
Wax coatings	Mineral hydrocarbons	Cheese sausages	[19]
Polymer	Diocyl phthalate	Milk	[35]
PS	Monostyrene	Milk	[75]
PP	Monomers	Yoghurt	[17]
PS	Styrene	Food oil	[60]
PS	Styrene	Cheese, dessert, meat products	[37]
PVC	DEHA	Cheese	[77]
LDPE	Naphthalene	Milk	[55]
ABS	Mineral hydrocarbons	Dairy products	[46]
PC	Bisphenol A (BPA)	FSL	[9]
PVC films	DEHA	Bread, olive oil, cheese, meat	[81]
PVC	DEHA	Microwave fatty foods	[57]

Migration in plastics packaging refers to the transfer of compounds from the plastic to the food product. This might be by leaching or diffusion. Direct contact between plastic and a food product can result in components of the packaging being leached out into the product, changing the flavors of the food. The main components that have caused problems are amides (slip agents), heat-degradation products from the polymer base, and ink components. Migration may also occur from the food to the plastic, in some cases resulting in plasticizing of the package if the vapors are water or certain solvents. This can result in loss of mechanical strength. The food may lose valuable volatiles, such as odors, carbon dioxide, water, or flavors. For example, a fruit juice in polyethylene will lose limonene to the plastic (scalping) and increase ascorbic acid degradation [25]. Van Willige et al. [98] studied the influence of flavor absorption by food packaging materials (low-density polyethylene, polycarbonate, and PET) on taste perception of a model solution and orange juice. Strathmann et al. [90] investigated the interaction of active packaging material with food aroma compounds. More details of flavor–food packages interaction are given by Linszen and Roozen [62].

Instead of testing for each possible migratory compound, a test for the total migration of all compounds from a packaging material is usually used. Migration of small molecules in plastic under conditions of high temperature has already been identified as a problem [93]. Transfer of aromas or flavors leads to tainting of the beverage filled for the second trip. The single largest groups are monomers and oligomers with molecular weights up to 1000 [49]. The chemical nature of monomers and oligomers depends on the polymers. Vinyl chloride monomer, acrylonitrile monomer, and styrene are three monomers that received substantial attention [33]. Their migration is very important because of possible toxic and carcinogenic effects. In addition to that, monomer- and oligomer-mediated flavor problems or off-flavors are equally important. Styrene monomer has very low sensory threshold and imparts strong odors to foods [67]. In general, high-molecular-weight (around 1000) oligomers found in polyolefins are paraffinic in nature and impart oily off-flavors to foods [49]. Aroma compounds from orange juice stored in PET were studied [7]. Influence of packaging on the aroma stability of strawberry syrup during storage was studied by Ducruet et al. [26].

Other compounds that are produced during plastics manufacturing and cause flavor problems due to migration include aldehydes, ketones, carboxylic acids, hydroxyl acids, catalyst residues, and solvents [33]. Solvents used during polymerization reactions are present in very low levels in the raw resins, but some foods are sensitive to them at the ppb level [20]. A common catalyst 2,2'-azobisisobutyronitrile used during polymerization of PVC, acrylonitrile, and PS decomposes into tetramethylsuccinonitrile at around 100°C [44], migration of this is extremely undesirable since it is an acute central neurotoxin [22,23]. During extrusion of the plastic material, temperatures may reach 250°C and higher. At these temperatures, the antioxidants in the polymer will be rapidly lost. Free radicals may form on the surface of the material and in food contact; these oxidizable sites or contact points may cause autocatalyzed oxidation of food products [39].

Polyolefins give a variety of thermal degradation (oxidation) products, including aldehydes, ketones, and acrolein [39]. Acetaldehyde is of primary concern with respect to migration and off-flavor development in foods [51]. PVC contains allylic chlorine atoms that are readily released during exposure to minimal heat and render the material thermally unstable. PS is relatively heat stable, but evolves about 0.2% styrene monomer during extrusion [49].

A study on the thermal decomposition of low-density polyethylene at similar conditions during extrusion revealed the presence of 44 degradation by-products representing hydrocarbons, alcohols, aldehydes, ketones, acids, cyclic esters, and cyclic ethers [41]. The major degradation products were formic acid, formaldehyde, acetic acid, and acetaldehyde. Formaldehyde and acetaldehyde are odor-active compounds associated with strong off-odors in packaged foods [20].

Adhesives are used with some multilayer packaging materials to bond dissimilar materials together and fabricate (seal) certain types of packages. Many adhesives contain solvents that may migrate into foods [49]. Solvents are also part of ink systems used for printing packaging materials and have been known to impart off-flavors to packaged foods [20]. However, proper drying of printing materials may completely eliminate solvent migration from adhesives and printing inks [20]. Most solvents are volatile and highly odor active. Off-flavor problems due to migration of solvent residues in various products have been reported, including toluene, *p*-tertiary butylphenol, ethyl acetate, isopropanol, methyl ethyl ketone, and hexane [33]. Volatile compounds can be generated when packaged food in plastic is heated by

microwave oven [102]. Different local and international regulatory authorities provide a lower limit to migration from packaging materials below which regulations would be deemed not to apply.

#### **40.4.4 Stickiness and Packaging**

The sticking of food to packaging surfaces can be desirable or undesirable to both the processor and the consumer. For example, the keeping quality of sausage products is known to be closely related to the degree of adhesion of meats to the casing. However, the adhering of a food product to the contact surface can result in product loss, and in some cases, poor product appearance [53]. Adhesiveness or stickiness between the foodstuff and the packaging surface is a complex phenomenon. The word adhesion is broadly used to define the sticking together of two materials with or without an intermediate layer. It is an interfacial phenomenon, which in the food packaging system generally involves a liquid–solid interface or a solid–liquid interface. There are various theories or mechanisms of adhesion described in the literature. These are electrostatic, diffusion, mechanical, chemical, surface energetic, adsorption, or wetting [53]. Some materials and additives for polymers are designed to be effective at the surface of the material. Examples include antifogging agents, some antistatic agents, slip agents, and antiblock agents. Such materials were developed to have an inherent incompatibility with the polymer matrix. Gibbs' free energy considerations lead to these types of materials accumulating at the surface where total energy is minimized, producing the most stable configuration. There may be other cases where surface effects were not intended, but incompatibility with the matrix or other factors leads to an accumulation of the material at the surface [24].

---

### **40.5 Safety and Legislative Aspects**

In recent years, consumer awareness about safety and wholesomeness of foods has increased dramatically. Food safety is a subject of intense study by a large group of scientists. The consumer concerns have been about food additives, both those added intentionally and those ending up in the food from, for example, the packaging material or processing equipment. The numbers of substances used in packages used for food are considerable. Many of these substances are potentially toxic, harmful, and can migrate into foods. In the early 1980s, numerous toxicological studies of several commonly used plasticizers demonstrated carcinogenic effect in rodents and potential estrogenic effect in humans. From food safety point of view, it is important to understand the toxicity of such substances at the concentration at which they appear in the food from the packaging material.

To protect consumers from the migration of harmful substances from packaging to food, different countries have different regulations. The approach adopted by USA and the EC will be discussed here since between them they account for the larger proportion of packaging materials used with food. In USA, the regulations include migration of both the basic polymer resins used in food packaging and the additives that are added to a polymer in the process of manufacturing the final food package. Regulations specify limits of global migration of polymeric resins from the packaging. The time/temperature/solvent conditions for the short-term extraction tests used to test compliance are also spelled out in the regulation (Code of Federal Regulation). The likelihood of a substance posing a health hazard depends on its dietary concentration and toxic potency. The agency considered both the factors in establishing a threshold of regulation level. Hence, the extent of migration of harmful substances to food that is trivial to food safety concern is also proposed. In Europe Commission of the European Communities (CEC) directives have been implemented for packaging materials. The first relevant CEC directive was issued in 1976, which also proposed analytical test methods to enable limits. The EC has listed thousands of additives and monomers as potential migrants. Many of them are authorized with restrictions or with specific migration limits, and certain number of analytical methods have been standardized. The directives adopted by the EU member states concerning migration can be divided into three groups: (1) directives applicable to all materials and articles, (2) directives applicable to one category of materials and articles, and (3) directives related to individual substances [1]. In general, the directives introduced limits upon the overall migration from plastics into food and food simulants. In addition, specific migration limits or composition limits for free monomers in the final article have been

set for some monomers. Currently, the limit for overall migration was set at 10  $\mu\text{g}/\text{dm}^2$  or 60 mg/kg of food simulants. It also includes the lists of permitted monomers together with the restriction, which apply to specific monomers. The FDA has determined that most known carcinogens pose less than a one-in-a-million lifetime risk if present in the diet at a level of 0.5  $\mu\text{g}/\text{kg}$ .

---

## References

1. Arvanitoyannis, I. S. and Bosnea, L. (2004) Migration of substances from food packaging materials to foods, *Critical Reviews in Food Science and Nutrition* 44: 63–76.
2. Baner, A. L., Franz, R., and Piringer, O. (1994) Alternative methods for the determination and evaluation of migration potential from polymeric food contact materials, *Deutsche Lebensmittel Rundschau* 90: 181–185.
3. Baner, A., Brandsch, J., Franz, R., and Piringer, O. (1996) The application of a predictive migration model for evaluating the compliance of plastic materials with European food regulations, *Food Additives and Contaminants* 13: 587–601.
4. Begley, T., Castle, L., Feigenbaum, A., Franz, R., Hinrichs, K., Lickly, T., Mrecea, P., Milana, M., O'Brien, A., Rebre, S., Rijk, R., and Piringer, O. (2005) Evaluation of migration models that might be used in the support of regulations for food-contact plastics, *Food Additives and Contaminants* 22: 73–90.
5. Begley, T. H., Biles, J. E., Cunningham, C., and Piringer, O. (2004) Migration of a UV stabilizer from polyethylene terephthalate (PET) into food simulants, *Food Additives and Contaminants* 21: 1007–1014.
6. Begley, T. H. and Hollifield, H. C. (1990) Evaluation of polyethylene terephthalate cyclic trimer migration from microwave food packaging using temperature-time profiles, *Food Additives and Contaminants* 7: 339–346.
7. Berlinet, C., Ducruet, V., Brillouet, J.-M., Reynes, M., and Brat, P. (2005) Evolution of aroma compounds from orange juice stored in polyethylene terephthalate (PET), *Food Additives and Contaminants* 22: 185–195.
8. Biles, J. E., White, K. D., McNeal, T. P., and Begley, T. H. (1999) Determination of the diglycidyl ether of Bisphenol A and its derivatives in canned foods, *Journal of Agricultural Food Chemistry* 47: 1965–1969.
9. Biles, J. E., McNeal, T. P., Begley, T. H., and Hollifield, H. C. (1997) Determination of bisphenol-A in reusable polycarbonate food-contact plastics and migration to food-simulating liquids, *Journal of Agricultural Food Chemistry* 45: 3541–3544.
10. Bosset, J. O., Gallmann, P. U., and Sieber, R. (1994) Influence of light transmittance of packaging materials on the shelf-life of milk and dairy products—A review. In *Food Packaging and Preservation*, M. Mathlouthi (Ed.), p. 223. Blackie Academic & Professional, Glasgow.
11. Boussoum, M. O., Atek, D., and Belhaneche-Bensemra, N. (2006) Interactions between poly (vinyl chloride) stabilized with epoxidised sunflower oil food simulants, *Polymer Degradation and Stability* 91: 579–584.
12. Bradley, E. L., Speck, D. R., Read, W. A., and Castle, L. (2004) Method of test and survey of caprolactam migration into foods packaged in nylon-6, *Food Additives and Contaminants* 21: 1179–1185.
13. Briston, J. H. and Katan, L. L. (1974) *Plastics in Contact with Food*, p. 466. Food Trade Press, London.
14. Cabrera, C., Lorenzo, M. L., and Lopez, M. C. (1995) Lead and cadmium contamination in dairy products and its repercussion on total dietary intake, *Journal of Agricultural Food Chemistry* 43: 1605–1609.
15. Casp, A., Marin, R., Arozarena, I., Navarro, M., and Bieche, B. J. (1999) Interaction between package and tomato as in instrument for package selection, *Acta Horticulture* 487: 407–411.
16. Castle, L., Damant, A. P., Honeybone, C. A., Johns, S. M., Jickells, S. M., Sharman, M., and Gilbert, J. (1997) Migration studies from paper and board food packaging materials, Part 2. Survey for residues of dialkylaminobenzophenone UV-cure ink photoinitiators, *Food Additives and Contaminants* 14: 45–52.
17. Castle, L., Mercer, A. J., and Gilbert, J. (1995) Chemical migration from polypropylene and polyethylene aseptic food packaging as affected by hydrogen peroxide sterilization, *Journal of Food Protection* 58: 170–174.
18. Castle, L., Kelly, M., and Gilbert, J. (1993) Migration of mineral hydrocarbons into foods (2), polystyrene, ABS, and waxed paperboard containers for dairy products, *Food additives and Contaminants* 10: 167–174.

19. Castle, L., Kelly, M., and Gilbert, J. (1993) Migration of mineral hydrocarbons into foods (3), cheese coatings and temporary castings for skinless sausages, *Food additives and Contaminants* 10: 175–184.
20. Culter, J. D. (1992) Minimizing plastic package/product interactions—an unfilled need, *Journal of Plastic Film and Sheet* 8(3): 208–226.
21. DeNunzio, C., Parasi, G., Santoro, P., and Ricci, P. A. (1987) Determination of phenols and cresols in aluminum backed paper by high-performance liquid chromatography, *Journal of Chromatography* 392: 454–459.
22. Doherty, P. A., Smith, R. P., and Ferm, V. H. (1982) Tetramethyl substitution on succinonitrile confers pentylenetetrazole-like activity and blocks cyanide release in mice, *Journal of Pharmacology and Experimental Therapeutics* 223(3): 635–641.
23. Doherty, P. A., Smith, R. P., and Ferm, V. H. (1983) Comparison of the teratogenic potential of two aliphatic nitriles in hamsters: Succinonitrile and tetramethyl succinonitrile, *Fundamental and Applied Toxicology* 3(1): 41–48.
24. Downes, T. W. (1987) Practical and theoretical considerations in migration. In *Food Product-Packaging Compatibility Proceedings*, J. I. Gray, B. R. Harte, and J. Miltz (Eds.), pp. 44–59. Technomic Publishing Company, PA.
25. Driscoll, R. H. and Paterson, J. L. (1999) Packaging and food preservation. In *Handbook of Food Preservation*, M. S. Rahman (Ed.), p. 687. Marcel Dekker, New York.
26. Ducruet, V., Fournier, N., Saillard, P., Feigenbaum, A., and Guichard, E. (2001) Influence of packaging on the aroma stability of strawberry syrup during shelf life, *Journal of Agricultural Food Chemistry* 49: 2290–2297.
27. Ehret, H. J., Ducruet, V., Luciani, A., and Feigenbaum, A. (1994) Styrene and ethylbenzene migration from polystyrene into dairy products by dynamic purge and trap chromatography, *Journal of Food Science* 59: 990–992, 1001.
28. Eklund, T. and Brenne, E. (1989) Aluminum containing packaging: Research on aluminum migration into milk products, *Meieriposten* 78: 396–398.
29. Franz, R., Huber, M., and Piringner, O. G. (1993) Method for testing and evaluating recycled polymers for use in food packaging with regard to migration across a functional barrier, *Deutsche Lebensmittel Rundschau* 89: 317–324.
30. Frank, R., Huber, M., and Piringner, O. G. (1997) Presentation and experimental verification of a physico-mathematical model describing the migration across functional barrier layers into foodstuffs, *Food Additives and Contaminants* 14: 627–640.
31. Garde, J. A., Catala, R., Gavara, R., and Hernandez, R. J. (2001) Characterizing the migration of antioxidants from polypropylene into fatty food simulants, *Food Additives and Contaminants* 18: 750–762.
32. Giacin, J. R. and Brzowska, A. (1987) Analytical measurements of package components from unintentional migrants. In *Food Product-Packaging Compatibility Proceedings*, J. I. Gray, B. R. Harte, and J. Miltz (Eds.), pp. 62–97. Technomic Publishing Company, PA.
33. Gnanasekharan, V. and Floros, J. D. (1997) Migration and sorption phenomena in packaged foods, *Critical Reviews in Food Science and Nutrition* 37(6): 519–559.
34. Goodson, A., Robin, H., Summerfield, W., and Cooper, I. (2004) Migration of bisphenol A from can coatings—Effects of damage, storage conditions and heating, *Food Additives and Contaminants* 21: 1015–1026.
35. Gortseva, L. V., Shutova, T. V., and Shmil, V. D. (1990) Determination of content of dioctyl phthalate in milk and model media simulating food products, *Gigiena I Sanitariya* 11: 89–90.
36. Goydan, R., Schwoppe, A. D., Reid, R. C., and Cramer, G. (1990) High temperature migration of antioxidants from polyolefins, *Food Additives and Contaminants* 7: 323–337.
37. Hammarling, L., Gustavsson, H., and Svensson, K. (1995) Polystyrene food packaging presents no problem if correctly used, *Var-Foda* 45: 26–28.
38. Hansen, A. P., Jesudason, P. J., and Armagost, M. S. (1992) Sorption of nonanal and 2-decanone by a polypropylene cup used in aseptic packaging of cheese sauce, *Journal of Dairy Science* 75: 119.
39. Harte, B. R. and Gray, J. I. (1987) The influence of packaging on product quality. In *Food Product-Packaging Compatibility Proceedings*, J. I. Gray, B. R. Harte, and J. Miltz (Eds.), pp. 17–29. Technomic Publishing Company, PA.
40. Heirlings, L., Siro, I., Devlieghere, F., Van Bavel, E., Cool, P., De Meulenaer, B., Vansant, E. F., and Debevere, J. (2004) Influence of polymer matrix and adsorption onto silica materials on the migration

- of  $\alpha$ -tocopherol into 95% ethanol from active packaging, *Food Additives and Contaminants* 21: 1125–1136.
41. Hoff, A. and Jaconsson, S. (1981) Thermo-oxidative degradation of low-density polyethylene close to industrial processing conditions, *Journal of Applied Polymer Science* 26: 3409–3423.
  42. Hotchkiss, J. H. and Vecchio, A. J. (1983) Analysis of direct contact paper and paperboard food packaging for N-nitrosomorpholine and morpholine, *Journal of Food Science* 48(1): 240–242.
  43. Huang, C. and Weng, Y. (1998) Inhibition of lipid oxidation in fish muscle by antioxidant incorporated polyethylene film, *Journal of Food Processing and Preservation* 22: 100–209.
  44. Ishiwata, H., Inoue, T., Yamamoto, M., and Yoshihira, K. (1988) Determination of tetramethylsuccinonitrile in food containers made of plastics, *Journal of Agricultural Food Chemistry* 36(6): 1310–1313.
  45. Jickels, S. M. Crews, C., Castle, L., and Gilbert, J. (1990) Headspace analysis of benzene in food contacts materials and its migration into foods from plastics cookware, *Food additives and Contaminants* 7: 197–205.
  46. Jickels, S. M., Nichol, J., and Castle, L. (1994) Migration of mineral hydrocarbons into foods, 5. Miscellaneous applications of mineral hydrocarbons in food contact materials, *Food additives and Contaminants* 11: 333–341.
  47. Johansson, F. and Leufven, A. (1994) Food packaging polymer films as aroma vapor barriers at different relative humidities, *Journal of Food Science* 59(6): 1328–1331.
  48. Joshi, S. P., Toma, R. B., Medora, N., and O'Connor, K. (2003) Detection of aluminum residue in sauces packaged in aluminum pouches, *Food Chemistry* 83: 383–386.
  49. Katan, L. L. (1988) Organolepsis. In *Plastic Films*, J. H. Briston (Ed.), pp. 200–232. Longman Scientific and Technical, UK.
  50. Kawamura, Y., Nishi, K., Machara, T., and Yamada, T. (1999) Migration of styrene dimmers and trimmers from polystyrene containers into instant foods, *Journal of the Food Hygiene Society of Japan* 39: 390–398.
  51. Kim-Kang, H. (1990) Volatiles in packaging materials, *CRC Critical Review in Food Science and Nutrition* 29(4): 255–271.
  52. Knezevic, G. (1989) Migration of metal traces from paper, cardboard, and board into test foods II, *Verpackungs-Rundschau* 40: 55–56.
  53. Lai, C. C. (1987) Sticky problems in food packaging. In *Food Product-Package Compatibility*, J. I. Gray, B. R. Harte, and J. Miltz (Eds.), pp. 258–269. Michigan State University, East Lansing, MI.
  54. Lau, O.-W. and Wong, S.-K. (2000) Contamination in food from packaging material, *Journal of Chromatography A* 882: 255–270.
  55. Lau, O.-W. and Wong, S.-K. (1994) Naphthalene contamination of sterilized milk drinks contained in low-density polyethylene bottles, Part 1, *Analyst* 119: 1037–1042.
  56. Lau, O.-W. and Wong, S.-K. (1994) Permeability of naphthalene in different types of polymeric food packaging materials, *Packaging Technology and Science* 8: 271–277.
  57. Lau, O.-W. and Wong, S.-K. (1996) The migration of plasticizers from cling film into food during microwave heating: Effect of fat content and contact time, *Packaging Technology and Science* 9: 19–27.
  58. Lau, O.-W. and Wong, S.-K. (1997) Mathematical model for the migration of plasticizers from food contact materials into solid foods, *Analytica Chimica Acta* 347: 249–256.
  59. LeFleur, L., Bousquet, T., Ramage, K., Davis, T., Mark M., Lorusso, D., Woodrow, D., and Saldana, T. (1991) Migration of 2378-TCDD/2378-TCDF from paper based food packaging and food contact products, *Chemosphere* 23: 1575–1579. *Proceedings, Chlorinate dioxin, and related compounds*, 1990, Bayreuth, Germany.
  60. Lickly, T. D., Lehr, K. M., and Welsh, G. C. (1995) Migration of styrene from polystyrene foam food contact articles, *Food and Chemical Toxicology* 33: 475–481.
  61. Limm, W. and Hollifield, H. C. (1995) Effect of temperature and mixing on polymer adjuvant migration to corn oil and water, *Food Additives and Contaminants* 12: 609–624.
  62. Linssen, J. P. H. and Roozen, J. P. (1994) Food flavor and packaging interactions. In *Food Packaging and Preservation*, M. Mathlouthi (Ed.), p. 48. Blackie Academic & Professional, Glasgow.
  63. Macias, C., Arias Verdes, J. A., Hernandez, D. M., and Ramos, J. (1990) Estimation of plasticizers in foods, *Revista Cubana Alimentacion y Nutrition* 4: 169–178.
  64. Mannheim, C. (1987) Interaction between metal cans and food products. In *Food Product-Package Compatibility Proceedings*, J. I. Gray, B. R. Harte, and J. Miltz (Eds.), pp. 105–133. Technomic Publishing Company, PA.



65. Mercer, A., Castle, L., and Gilbert, J. (1990) Evaluation of a predictive mathematical model of di-(2-ethylhexyl) adipate plasticizer migration from PVC film into foods, *Food Additives and Contaminants* 7: 497–507.
66. Miltz, J. (1992) Food packaging. In *Handbook of Food Engineering*, D. R. Heldman and D. B. Lund (Eds.), pp. 667–740. Marcel Dekker, New York.
67. Miltz, J., Elisha, C., and Mannheim, C. H. (1980) Sensory threshold of styrene and the monomer migration from polystyrene food packages, *Journal of Food Processing and Preservation* 4(4): 281–289.
68. Mousavi, M., Desobry, S., and Hardy, J. (1999) 1-Propanol migration into apples contained in wooden packaging, *Sciences des Aliments* 19: 183–193.
69. Muller, J. P., Steinegger, A., and Schlatter, C. (1993) Contribution of aluminum from packaging materials and cooking utensils to the daily aluminum intake, *Zeitschrift fur Lebensmittel Untersuchung und Forschung* 197: 332–341.
70. Nerin, C., Gancedo, P., and Cacho, J. (1992) Determination of bis(2-ethylhexyl) adipate in food products, *Journal of Agricultural Food Chemistry* 40: 1833–1835.
71. Nerin, C., Rubio, C., Cacho, J., and Salafranca, J. (1998) Parts-per-trillion determination of styrene in yogurt by purge-and-trap gas chromatography with mass spectrometry detection, *Food Additives and Contaminants* 15: 346–354.
72. Nielsen, T. and Jagerstad, M. (1994) Flavour scalping by food packaging, *Trends in Food Science and Technology* 5: 353–356.
73. Nielsen, T. J., Margaretha Jagerstad, I. R. E., and Oste, R. E. (1992) Study of factors affecting the absorption of aroma compounds into low-density polyethylene, *Journal of the Science of Food and Agriculture* 60: 377–381.
74. Nijssen, B. (1991) Off-flavors. In *Volatile Compounds in Foods and Beverages*, H. Maarse (Ed.), pp. 689–736. Marcel Dekker, New York.
75. O'Neil, E. T., Tuohy, J. J., and Franz, R. (1994) Comparison of milk and ethanol/water mixtures with respect to monostyrene migration from a polystyrene packaging material, *International Dairy Journal* 4: 271–283.
76. Ozdemir, M. and Floros, J. D. (2004) Active food packaging technologies, *Critical Reviews in Food Science and Nutrition* 44: 185–193.
77. Page, B. D. and Lacroix, G. M. (1995) The occurrence of phthalate ester and bi-2-ethylhexyl adipate plasticizers in Canadian packaging and food sampled in 1985–1989: A survey, *Food Additives and Contaminants* 12: 129–151.
78. Page, B. D. and Lacroix, G. M. (1992) Studies into the transfer and migration of phthalate esters from aluminum foil-paper laminates to butter and margarine, *Food Additives and Contaminants* 9: 197–212.
79. Pascall, M. A., Harte, B. R., Giacini, J. R., and Gray, J. I. (1995) Decreasing lipid oxidation in soyabean oil by a UV absorber in the packaging material, *Journal of Food Science* 60(5): 1116–1119.
80. Paserio, L. P., Simal Lozano, J., Paz Abuin, S., Lopez Mahia, P., and Simal, G. J. (1993) Kinetics of the hydrolysis of Bisphenol A diglycidyl ether (BADGE) in water-based food simulants. Implication for legislation on the migration of BADGE-type epoxy resins into foodstuffs, *Journal of Analytical Chemistry* 345: 527–532.
81. Petersen, J. H., Lillemark, L., and Lund, L. (1997) Migration from PVC cling films compared with their field of application, *Food Additives and Contaminants* 14: 345–353.
82. Reineccius, G. (1991) Off-flavors in foods, *CRC Critical Review in Food Science and Nutrition* 29(6): 381–402.
83. Robertson, G. L. (1993) *Food Packaging: Principles and Practice*. Marcel and Dekker, New York, NY.
84. Sadler, G. D. and Braddock, R. J. (1991) Absorption of citrus flavor volatiles by low density polyethylene, *Journal of Food Science* 56(1): 35–54.
85. Saiyed, S. M. and Yokel, R. A. (2005) Aluminum content of some foods and food products in the USA, with aluminum food additives, *Food Additives and Contaminants* 22: 234–244.
86. Satyanarayana, B. and Das, H. (1990) Detection of residual hydrogen peroxide in package material used for aseptic packaging of milk, *Indian Dairyman* 42: 223–224.
87. Sebtı, I. and Coma, V. (2002) Active edible polysaccharide coating and interactions between solution coating compounds, *Carbohydrate Polymers* 49: 139–144.
88. Sieber, R. and Daniel, R. C. (1995) Aluminum in milk and milk products: A review, *Schweizerische Milchwirtschaftliche Forschung* 24: 39–47.

89. Sieber, R. and Daniel, R. C. (1997) Aluminum in milk and milk products in comparison to other foods: A review, *Ernahrung* 21: 7–12.
90. Strathmann, S., Pastorelli, S., and Simoneau, C. (2005) Investigation of the interaction of active packaging material with food aroma compounds, *Sensors and Actuators B* 106: 83–87.
91. Tawfik, M. S. and Huyghebaert, A. (1998) Polystyrene cups and containers: Styrene migration, *Food Additives and Contaminants* 15: 592–599.
92. Tehrany, E. A. and Desobry, S. (2004) Partition coefficients in food/packaging systems: A review, *Food Additives and Contaminants* 21: 1186–1202.
93. TFT. (1997) Intelligent packaging for better food, *The Food Technologist* 27(3): 90–91.
94. Till, D. E., Reid, R. C., and Schwartz, P. S. (1982) Plasticizer migration from polyvinyl chloride film to solvents and foods, *Food and Chemical Toxicology* 20: 95–104.
95. UK, Ministry of Agriculture, Fisheries and Food (1999) Diisopropyl-naphthalene in food packaging made from recycled paper and board, *Food Surveillance Information Sheet* 169: 10–15.
96. UK, Ministry of Agriculture, Fisheries and Food (1997) Survey of Bisphenol a diglycidyl ether (badge) epoxy monomer in canned foods, *Food Surveillance Information Sheet* 125: 12.
97. van Renterghem, R. and de Groof, B. (1993) Evaluation of recycled polystyrene for packaging of dairy products, *Milchwissenschaft* 48: 79–82.
98. van Willige, R. W. G., Linssen, J. P. H., Legger-Huysman, A., and Voragen, A. G. J. (2003) Influence of flavor absorption by food-packaging materials (low density polyethylene, polycarbonate and polyethylene terephthalate) on taste perception of a model solution and orange juice, *Food Additives and Contaminants* 20: 84–91.
99. Vaz, P., Gustavsson, H., and Nilsson, K. (1991) Plastic films used for cheese sold at manual counter, *Var-Foda* 43: 309–311, 335–336.
100. Vela, M. M., Toma, R. B., Reiboldt, W., and Pierri, A. (1998) Detection of aluminum residue in fresh and stored canned beer, *Food Chemistry* 63: 235–239.
101. Widen, H., Leufven A., and Nielsen, T. (2004) Migration of model contaminants from PET bottles: Influence of temperature, food simulants and functional barrier, *Food Additives and Contaminants* 21: 993–1006.
102. Woods, K. D. (1991) Food-package interaction safety. In *Food and Packaging Interactions*, S. J. Risch and J. H. Hotchkiss (Eds.), pp. 110–147. American Chemical Society, Washington DC.



# 41

## *Hygienic Design and Sanitation*

Mohammad Shafiur Rahman

### CONTENTS

41.1	Hygienic Design .....	957
41.1.1	Factory Facility Design .....	957
41.1.1.1	Factory Site .....	957
41.1.1.2	Floors .....	958
41.1.1.3	Walls .....	959
41.1.1.4	Doors, Windows, and Ceilings .....	959
41.1.1.5	Lighting .....	959
41.1.2	Equipment Design .....	959
41.2	Good Hygienic Practice .....	961
41.2.1	Purpose of Sanitation .....	961
41.2.2	Strategy for Establishment of Sanitary Practices .....	962
41.2.2.1	Reduction of Food Contamination Sources .....	962
41.2.2.2	Personal Hygiene and Food Handling.....	962
41.2.2.3	Cleaning of the Factory Facility .....	964
41.2.2.4	Cleaning of Equipment .....	964
41.2.2.5	Hygiene Monitoring .....	965
References	.....	966

### 41.1 Hygienic Design

Lack of adequate hygienic practices at all stages of food production—harvesting, postharvesting, processing, and storage—drastically increases the risk of contamination with food poisoning [2]. Sanitation is the creation and maintenance of hygienic and healthful conditions. Its applications refer to hygienic practices designed to maintain a clean and wholesome environment for food production, preparation, and storage [39]. This involves not only cleanliness in foods but also improving the environment around food processing. One of the keys to operating a clean and sanitary facility is design of the buildings and equipment. It is important to do it right the first time, as it is always much harder and more expensive to retrofit or rebuild [26].

#### 41.1.1 Factory Facility Design

It is important to design food processing factory and equipment keeping in consideration hygienic factors to ensure food safety and quality.

##### 41.1.1.1 Factory Site

The design, construction, and maintenance of the factory site and buildings need special considerations from hygiene point of view. To maintain a good standard of hygiene, a well-planned and adequate waste

disposal system is essential [58]. Attention to the design, construction, and maintenance of the site surrounding the factory provides an opportunity to set up the first (outer) of a series of barriers to protect production operations from contamination. These barriers start at the site boundary, and moving inward, end with the walls of high- and low-care regions [54]. Thorpe [54] reviewed the number of steps that can be taken for factory site. The important ones are:

- i. Using two lines of rodent baits located every 15–21 mm along the perimeter fencing and at the foundation walls of the factory, together with a few mouse traps near building entrances [34].
- ii. Keeping the area adjacent to buildings grass-free and covering with a deep layer of gravel or stones help in weed control and assist inspection of bait boxes and traps [37,57].
- iii. Strategy of making the factory site unattractive by denying birds food and harborage, this needs clearing up of any spillages of raw materials, and avoiding keeping waste material in uncovered containers and growing big trees around the site [46].
- iv. Premises should be purpose built to a sanitary design with modern easy-to-clean materials and should be situated in surroundings that are free from potential harborage for rodents, birds, and insects [58].
- v. Protective screens and preventing unauthorized opening of doors and windows avoids flying insects.
- vi. Use of high-pressure sodium lights in preference to mercury vapor lamps for lighting warehouses and outdoor security systems to avoid attracting night-flying insects [34,46].
- vii. Landscaping sites can reduce the amount of dust blown into the factory; entrances into the plant and areas surrounding it should be well paved to reduce the amount of mud and dirt brought in by workers and clients [2].
- viii. Buildings should be oriented such that prevailing winds do not blow directly into manufacturing areas; doors and windows of the plants should be screened tightly to prevent the entry of flies and other insects [2].
- ix. There should be a proper layout of vehicular routes around the factory site to avoid soil being blown into buildings [54].
- x. Plant premises and areas surrounding it should be kept completely free of all decomposing materials and pools of stagnant water that generate foul odors and are ideal for breeding flies and other insects [2].
- xi. Should not have flower plants to avoid attracting flies and other insects.
- xii. The air circulating within the factory needs to be controlled since pests, insects, rodents, and birds carry pathogens.

#### **41.1.1.2 Floors**

Intensifying the hygiene-enhancing qualities of specialist safety flooring is an important aim in safety flooring manufacture. The main characteristics required are strength; fastness; abrasion, corrosion, and skid resistance. A bacteriostat in the formulation is integral to the flooring and gives the exposed surface strong antibacterial activity against Gram-positive and Gram-negative microorganisms [33]. The slip resistance of the floor is another safety aspect in the prevention of injury-causing slips, trips, and falls. As the problem of floor surface slip performance is relatively complex, there are many other factors involved rather than simply the flooring material. Thus, a broad range of polymeric shoe-sole materials are used today in addition to flooring materials. Today, a wide variety of flooring solutions are available. These include safety floors with studded or formulated with hard mineral additives (fine grain chemicals, e.g., silicon carbide) that provide a large coefficient of friction (for strong grip) under wet and contaminated, for example, greasy, conditions [33]. Studded tiles are not recommended because of greater difficulty in cleaning such surfaces. Ideally, surfaces that offer the greatest ease in cleaning should be used. However, the final choice should reflect a balance among ease of cleaning, slip resistance, and other factors. Joints should be grouted properly. Cementitious grouts are not considered suitable hygienic applications. Epoxy, polyester, and furan resins can be used. Epoxy resins have limited resistance to very high concentrations of sodium hypochloride and soften at temperatures above 80°C. Polyester and furan

resins are more resistant to chemical attack. Floor finish with either tiles or a synthetic resin should be considered. The choice of flooring surfaces can be broadly grouped into three categories: (i) concretes, (ii) fully vitrified ceramic tiles, and (iii) seamless resin screeds. Concrete flooring, including the high-strength granolite finishes, may be suitable in different parts of the factory. However, this is not recommended for high-care production areas due to its ability to absorb water and nutrients and hence allow microbial growth below the surface, where it is extremely difficult to apply effective cleaning [54]. Pressed or extruded ceramic tiles have been used by the food industry for many years and are still extensively used in processing areas. In recent years, they have been partially replaced by various seamless resin floors due to cost and wide availability. The waterproof membrane of floor should be extended up walls to a height above the normal spillage level [54].

All floors in the factory should be cleaned regularly and must be properly constructed with good drainage. Water should not be allowed to remain stagnant on the factory floor or drain because this breeds unwanted insects and flies [2]. A correct slope on the floor is also important [58]. Drainage should be taken into account the proposed layout of equipment. Ideally, the layout and situation of production equipment should be finalized before the floor is designed to ensure that discharges can be fed directly into drains. In reality, this may not be possible for the food industry since the layout of lines may be frequently changed. Drainage should be at the middle of the factory and equipment should be placed on both sides of the drain. Equipment should not be located directly over drainage channels as this may restrict access for cleaning [54].

#### **41.1.1.3 Walls**

A number of technical factors such as hygiene characteristics, insulation properties, and structural characteristics need to be taken into consideration for walls. A U-shaped channel at the floor and wall junction should be used for easily cleanable and watertight junction. The walls must be constructed of impervious, nonabsorbant, washable, nontoxic materials and have smooth crack-free surfaces [54].

#### **41.1.1.4 Doors, Windows, and Ceilings**

Doors, windows, and ceilings also need to be properly designed. Windows must have nets to prevent insects from entering the production areas and automatic doors should be used.

#### **41.1.1.5 Lighting**

Lighting in all areas of the plant should be sufficient for adequate performance of all assigned duties. Areas where cleaning, sorting, picking, and product inspection are done should be provided with sufficient nonglazing light to enhance work performance [2]. Lighting should be used in such a way as to avoid attracting insects. Electroblade could also be used to trap and kill insects and flies.

### **41.1.2 Equipment Design**

Hygienically designed equipment should be installed in a manner that minimizes the chances of contamination and to facilitate housekeeping and sanitation programs [54]. All equipment must be designed and constructed so that all internal contact points and external surfaces can be cleaned. Each piece of equipment has its own peculiar areas where microorganisms might proliferate, and hazard analysis of any weak points should ensure their removal, and indicate control and monitoring [58].

Legislation on the hygienic design of food-processing equipment or the hygienic maintenance of these equipments is rather vague [1]. In Europe, the most important legislation giving criteria for hygienic design of equipment is the Council Directive on the approximation of the laws of Member States relating to machinery (89/392/EEC, revised 98/37/EC), which contains safety requirements and the basic principles of hygienic design [4]. National standards and directives applicable to the hygienic design of food machinery are available, but only a few international standards exist, directed mainly at the dairy industry [30]. A basic standard of hygiene requirements for the design of machinery is the ISO 14159:2002 [35]. The European Committee for Standardization (CEN) issues standards for equipment manufacturers to be able to fulfill the requirements of the directive. One important basic standard is the Standard EN 1672-2 “Food-processing machinery—Safety and

hygiene requirements—Basic concepts Part 2; Hygiene requirements” [5]. However, there are also guidelines and methods published, e.g., by the European Hygienic Engineering and Design Group (EHEDG, <http://www.ehedg.org>), 3-A Sanitary Standard, Inc. (3-A, <http://www.3-a.org>), and NSF International (<http://www.nsf.org>) available for helping in the design of new hygienic equipment. According to the EHEDG guidelines, constructions that cause problems include dead ends, sharp corners, low-quality seals and joints, etc. [15,17].

Equipment can be classified into three groups—*aseptic equipment* (high demand): can be cleaned in place (CIP) and freed from microorganisms and spores (sterilization in place, SIP) without any dismantling; *hygienic equipment class I*: can be cleaned in place and freed from relevant microorganisms without dismantling; *hygienic equipment class II*: can be cleaned after dismantling and freed from relevant microorganisms by sterilization, pasteurization, or chemical treatment after reassembly [16,20]. Care should be taken in the location of adjoining equipment to prevent inefficient discharge of product from one unit to the next.

Valves are essential components of all food-processing plants, and the quality of the valves used strongly influences the microbiological safety of the food production process. Valves that may come in contact with food must therefore comply with strict hygienic requirements. The following are important conditions: (i) pits and crevices must always be avoided, (ii) sharp edges should be avoided, (iii) screw threads should not be used, and (iv) dead ends, which may trap product or prevent adequate cleaning, should be avoided. If dead ends are unavoidable, they must be as short as possible and be installed in a drainable and cleanable position; and there should be as few seals in a valve as possible; and during processing, the compressibility of the sealing should not be exceeded. More details are given in the European Hygienic Equipment Design Group Report [16]. In Europe, valve design must meet the criteria shown in Table 41.1 [19]. The guidelines for basic design and safe use of double-seat mixproof valves in food processing, along with an outline of its benefits and applications, are provided by the EHEDG group [19]. This type of valve prevents intermixing of ingredients or cleaning fluids during normal use. Other EHEDG [18] updates provide general hygienic design criteria for the safe processing of dry particulate materials. Figure 41.1a shows the possible design faults for liquid-holding tanks; a better design could be that shown in Figure 41.1b. The design criteria for handling dry materials must consider (i) the eventuality of disassembly/accessibility for cleaning and inspection, (ii) the moisture content of the product, and (iii) safety aspects including the formation of dust and exposure to it.

Mechanical seals are commonly in use for pumps, agitators, mixers, and other types of rotary equipment. Dynamic sealing takes place at the interface between a stationary seal ring and a rotating ring. It is accomplished by using perfectly flat surfaces, and using the product pressure along with spring force to press the components together. The appropriate design of mechanical seals can cause contamination of a food product by microorganisms and residues, which may be toxic or allergenic. An EHEDG update [20] presents the details for the design of mechanical seals for hygienic and aseptic applications. The general design criteria are as follows: (i) the parts of the seal in contact with product

**TABLE 41.1**

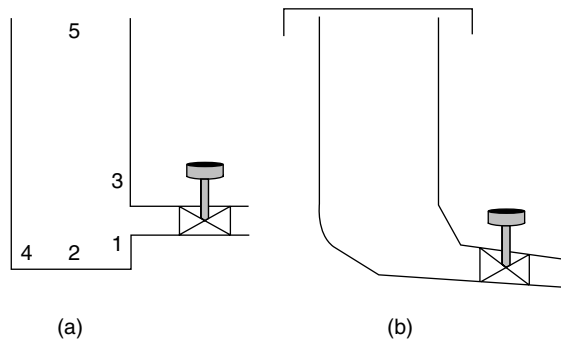
The Criteria for Valve Design in Europe

---

Council Directive 98/37/EC
CEN EN 1672-2 requirements
ISO 14159 hygiene requirements for the design of machinery
Requirements set out in the EHEDG guidelines
<ul style="list-style-type: none"> <li>• Doc. 8: Hygienic equipment design criteria, 1993</li> <li>• Doc. 9: Welding stainless steel to meet hygienic requirement, 1993</li> <li>• Doc. 10: Hygienic design of closed equipment for the processing of liquid food, 1993</li> <li>• Doc. 13: Hygienic design of equipment for processing, 1996</li> <li>• Doc. 14: Hygienic design of valves for food processing, 1996</li> <li>• Doc. 16: Hygienic pipe couplings, 1997</li> </ul>

---

Source: EHEDG update, *Trends in Food Science and Technology* 12: 296–301 (2001).



**FIGURE 41.1** Design of a liquid-holding tank. (a) Poor design (1: dead end, 2: no slope on the bottom, 3: sharp exit, 4: sharp corner, 5: no cover), (b) hygienically improved design.

must be suitable for CIP and SIP according to EHEDG guidelines; (ii) the nonproduct side of the seal should be cleanable and capable of being disinfected and should not contaminate or have any adverse influence on the food; (iii) product-contact surfaces have to be smooth and crevice-free; (iv) the non-product side must be as smooth and crevice-free as possible; (v) dead ends are not permitted on the product side; (vi) springs are not permitted on the product side; and (vii) designed corners must have a minimum radius of 3 mm. Materials used for components in mechanical seals must be nontoxic, anti-corrosive, crevice-free, and nonabsorbent; should not transfer undesirable odors, colors, or taints to the product; should neither contribute to the contamination of food nor have any adverse effects on the food; should have surfaces and coatings that are durable, cleanable, capable of being disinfected, without breaks, resistant to cracking, chipping, flaking, and abrasion; and prevent penetration by unwanted matter.

All equipment must be rinsed and sanitized on a daily basis and, in some instances, whenever there is a change in shift (if this is applicable) [2]. All surfaces in contact with food and outside surfaces of equipment must be cleanable. Surface roughness has a significant influence on cleaning ability. The greater the surface roughness, the longer the cleaning time [16]. Geometry appears to be one of the main factors in hygiene, emphasized by the way the equipment is connected to the CIP circuit [9,14].

## 41.2 Good Hygienic Practice

To ensure that the food industry staff members conform to personal hygiene requirements, two issues must be considered: (i) the environment within which the staff operate and (ii) the quality of the staff members. From food hygiene point of view, the quality of the working environment depends on the facilities or equipment provided, which include toilets and protective clothing. The quality of staff depends upon their health, hygiene, habits, attitude, beliefs, and education or knowledge level on hygiene [36].

### 41.2.1 Purpose of Sanitation

Sanitation is important from legal, economic, quality, and food safety standpoints. Sanitation programs should be integrated with a company's HACCP (Hazard Analysis and Critical Control Point) or food safety programs [26]. Giese [26] mentioned that good sanitation is much more than just good common sense; sanitation also entails getting the message across to all plant personnel and not just those involved with handling food. Sanitation consists of two parts: (i) cleaning and (ii) sanitizing. Cleaning means the removal of residue of food, dirt, dust, foreign material, or other soiling ingredients or materials. Sanitizing means the effective bactericidal treatment of clean surfaces of equipment and utensils [2,53]. Ideally, disinfectants should have the widest possible spectrum of activity against microorganisms (viruses, bacteria, fungi, and spores) in a time relevant to application contact times [25].



The benefits of sanitation are: (i) it increases the chance of complying with regulatory requirements; (ii) it can prevent a catastrophe; (iii) it enhances or facilitates an effective quality assurance program by increasing the acceptability and storage life of food by suppressing microbial population; and (iv) it saves energy and retards the spreading of flora throughout the establishment [39]. There is an increasing trend in food production toward products with a short shelf life. This demands higher standards of hygiene [29].

Cleaning and sanitizing are also important elements of any sanitation program. Good cleaning compounds must be economical, nontoxic, noncorrosive, noncaking, nondusting, easy to measure or meter, stable during storage, and easily and completely dissolvable. The selection of these compounds depends on the area and equipment to be cleaned, soil types, and their attachment characteristics [39]. Different types of cleaners and sanitizers are available. The value of working with suppliers is in not only selecting the best materials to meet industry needs, but also ensuring that employees have been properly trained in their use [26]. Surface-attached organisms are generally found to be less susceptible to disinfectants than suspended organisms. In practice, however, many factors are present in the factory environment that may affect the resistance of bacteria prior to disinfection [25]. Cleaning compounds are classified by Marriott [39] as alkaline (strong alkaline, heavy-duty alkaline, and mild alkaline cleaners), acidic (strong acidic cleaners, mild acidic cleaners, and solvent cleaners), synthetic detergents, alkaline soaps, phosphate substitutes for laundry detergents, and solvent cleaners. More details about cleaning compounds and sanitizers are given by Marriott [39].

### **41.2.2 Strategy for Establishment of Sanitary Practices**

A planned sanitation maintenance program is essential to meet legal requirements; protect brand and product reputation; and ensure product safety, quality, and freedom from contamination. All phases of food production and plant sanitation should be included in the program to supplement the cleaning and sanitizing procedures for equipment and factory facilities [39].

#### **41.2.2.1 Reduction of Food Contamination Sources**

Foods not handled in a sanitary way may become contaminated from processing equipment, employees, soil, air, water, sewage, insects, and rodents. Contamination can be reduced through effective house-keeping and sanitation, protection of food during storage, proper disposal of garbage and litter, and protection against contact with toxic substances [39].

#### **41.2.2.2 Personal Hygiene and Food Handling**

Good personal hygiene practices of personnel working in or visiting the production area are important. Additional requirements apply to personnel working in high-care areas. Personal hygiene refers to the cleanliness of a person's body. The health of the workers plays an important part in food sanitation. People are potential sources of microorganisms that cause illness in others through transmission of viruses or through food poisoning [39]. Personal hygiene needs reasonably clean hands, forearms, neck, hair, and clothing liable to come into contact with food [36].

The education of food handlers is a crucial line of defense in the prevention of most types of food-borne illnesses [40]. Aarnisalo et al. [1] investigated the hygienic working practices of maintenance personnel as well as the hygiene of the equipment in the Finnish food industry with questionnaires and microbial surveys. The protective clothing, washing of hands and tools as well as avoiding foreign bodies left on the production lines should be targeted when the hygienic working practices are developed for maintenance personnel. On the basis of questionnaire to those working on food processors, packaging machines, conveyers, dispensers, and slicing and cooling machines were considered the most problematic pieces of equipment hygienically, mainly because of poor hygienic design. To improve food safety, the training of maintenance personnel in food hygiene as well as equipment design should be emphasized. Similarly, Nel et al. [43] interviewed the workers from a deboning room of a high-throughput abattoir by means of a structured questionnaire to ascertain the knowledge, attitude, beliefs, and practices regarding personal and general hygiene applied specifically in the deboning room. Basic hygiene practices

were found to be in place and the workers adhered to the majority of these. The results highlighted a need for improved communication between management and workers as well as a need for more training in personal and general hygiene. Although basic personal and hygiene practices such as the wearing of overalls and gumboots as well as the cleaning and disinfection of equipment are adhered to, they need to be optimized in order to be effective.

The selected basic rules of personal hygiene are listed as follows [2,33,39,53]:

- i. Washing hands in hot water using plenty of soap and drying hands on a clean cloth or paper towel. Soap and water act as emulsifying agents to solubilize grease and oils on the hands. Increased friction through rubbing the hands together or using a scrub brush with the use of soap can reduce a large number of transient and more resident bacteria than quick hand wash. Approximately 25% of food contamination is attributable to improper washing. Hand washing is conducted to break the transmission route of microorganisms from the hands to another source and reduce resident bacteria. Antimicrobial soaps are recommended for food preparation and handling areas. The fast-acting bactericidal skin cleanser kills most skin organisms on contact within 15s. Proper washroom hygiene demands effective hand drying. Cloth-towel system is hygienic, environment friendly, and cost effective. There is a lot more to skin cleaning than just soap and water. Inadequate or incorrect cleaning can lead to chronic skin disease. Skin cleaning must be done thoroughly, but also gently. The choice of cleaner depends largely on the type of contamination. The wrong choice could lead to skin irritation, dermatitis, and even more severe skin conditions.
- ii. Washing hands after using the toilet; handling garbage or other soiled materials; handling uncooked muscle foods, egg products, or dairy products; handling money; smoking; coughing; and sneezing.
- iii. Maintaining skin protection. Maintaining skin involves a three-point program: (i) correct skin protection for use before contact with various skin irritants and for under gloves, (ii) effective nonaggressive skin cleaning, which minimizes the loss of natural fats and oils from the skin, and (iii) after-work skin care to recondition the skin and support the healing of existing dermatitis or damage. A protective cream is also used in many cases. The types of materials that are handled dictate which type of protective cream to use. Protective creams do more than to protect the skin. These other functions include strengthening the outer layer of the skin, supporting the skin's ability to repair itself, stimulating skin growth, and making cleaning easier.
- iv. Keeping fingernails short and clean, using a hairnet or cap, bathing daily, using deodorants, and washing hair at least twice a week.
- v. Using protective clothing, footwear, and headgear; they must be changed regularly. Beards must be kept short and trimmed and a protective cover worn when considered appropriate by management.
- vi. Avoiding use of nail varnish, false nails, makeup, false eyelashes, wristwatches, and jewelries or ornaments. Locations of these items are the places where more microorganisms could grow and are difficult to clean.
- vii. Avoiding counting money during food handling.
- viii. Avoiding consumption of food and drink in areas other than the tea bars and staff restaurant.
- ix. Avoiding consumption of sweets and chewing gum in production areas.
- x. Avoiding smoking or taking snuff in food production areas, warehouses, and distribution areas.
- xi. Avoiding spitting in all areas on the site.
- xii. Remaining away from food when a person has an infected cut, boil, or other infection of the exposed skin; covering sneezes and coughs by means of a tissue or handkerchief.
- xiii. Reporting all cases of diarrhea, fever, etc., and having periodic checkups.
- xiv. Avoiding hands to touch food-service equipment and utensils. Disposable gloves should be used when contact is necessary.

All personnel should receive basic training in food handling and hygiene. This should include personal hygiene and an appreciation of the HACCP or the GMP to implement HACCP. The management must select clean and healthy employees and ensure that they conduct hygienic practices. Sick workers should take sick leave and proper treatment before starting work again.

Hand hygiene is the most important means of reducing the spread of infection. Peden and Vaughan [44] improved the hand hygiene compliance rate within the hospital by using visual reminders, education, and positive reinforcement. Similarly, hand hygiene education and reminders to staff continue increased compliance and guarantee success [42]. Surveillance is a complex task that requires many elements to be addressed for data to be correctly reported. This includes the consistent application of data collection criteria by appropriately educated persons [10].

#### **41.2.2.3 Cleaning of the Factory Facility**

Cleaning and disinfection prevent contamination of food products from the factory facility and equipment surfaces. In the case of high-risk chilled foods, this is often a critical control point [29].

#### **41.2.2.4 Cleaning of Equipment**

All equipment should be washed and rinsed. Frequent cleaning of the plant equipment should be maintained at all times, and all parts should be continually washed by well-located continuous water sprays. Equipment should be cleaned as soon as possible after use and disinfected or sterilized just before it is used again. If there is an appreciable time lag between uses, the equipment should be washed and disinfected or sterilized after use and disinfected or sterilized again before use. The frequency will depend upon the hazard risk to the product being produced [58].

All equipment should be designed for easy cleaning. If the product is cleaned in place, the detergent used and the flow rates and angle or efficiency of the spray balls must be validated to ensure that the soil is effectively removed from all areas with no blind spots. Hand cleaning depends upon operative training as well as the correct use of detergents [58]. All utensils used must be absolutely clean. Buckets, knives, and drain pans should be cleaned and rinsed whenever empty or not in use [2].

Evans [21] studied microbial contamination of food refrigeration equipment in chilled rooms in 15 plants processing a variety of foods (raw meat and salads, Chinese ready meals, dairy products, slicing and packaging of cooked meats, and catering establishments). An initial survey of total numbers of microbes at a total of 891 sites on evaporators, drip trays, and chilled room walls was followed up with a more detailed examination of 336 sites with high counts, selecting for *Listeria* spp., coliforms, enterococci, *Staphylococcus aureus*, and *Bacillus cereus*. Although evaporator cleaning procedures were carried out in some factories as part of routine maintenance, these were not shown to be effective at maintaining low levels of bacteria on evaporators. To maintain evaporator hygiene, it was suggested that more regular cleaning procedures, possibly by means of automated cleaning systems, should be considered [21].

Knowledge of adhering microflora on process equipment would also be valuable information in designing, cleaning, and disinfecting procedures, and is essential in the “good hygienic practices” program of food processing plants, as the development and design of improved cleaning and disinfecting procedures should target the microorganisms persisting and potentially contaminating the product. Many food pathogenic and spoilage bacteria are able to attach to food contact surfaces [60] and remain viable even after cleaning and disinfection [23]. Such adhered bacteria can detach during production and contaminate food as it passes the surfaces. Microorganisms attached to and growing on a surface are called microbial biofilms. Microbial fouling or biofouling causes problems in food industry. Hygienic problems in equipment are caused when microorganisms get attached to the surfaces and survive on them [62] and later get detached from them, contaminating the product. The microflora adhering to the processing equipment during production and after cleaning and disinfecting procedures were identified in four different fish processing plants [7]. A total of 1009 microorganisms were isolated from various agar plates and identified. A stepwise procedure using simple phenotypic tests was used to identify the isolates and proved a fast way to group a large collection of microorganisms. *Pseudomonas*, Neisseriaceae, Enterobacteriaceae, *Coinneforin*, *Acinrobacter*, and lactic acid bacteria dominated the microflora of cold-smoked salmon plants, whereas the microflora in a plant processing semipreserved herring consisted of *Pseudomonas*,

*Alcaligenes*, and Enterobacteriaceae. *Psychrobacter*, *Staphylococcus*, and yeasts were found in a caviar processing plant. Overall, many microorganisms that are often isolated from fish were also isolated from the fish processing plants. However, some selection depending on processing parameters occurred, since halo- and osmotolerant organisms dominated in the caviar processing. After cleaning and disinfection, yeasts, *Pseudomonas*, Neisseriaceae, and *Alcaligenes* remained in smokehouses, yeasts and *Pseudomonas* in the herring plant, and *Pseudomonas*, *Staphylococcus*, and yeasts in the caviar plant. The dominant adhering organisms after cleaning and disinfection were pseudomonas and yeasts, independent of the microflora during processing [7].

The ability of spores to adhere differed widely among strains [3]. All the members of the *B. cereus* group are surrounded by a loose balloon-like exosporium whose hydrophobic character could account for their strong adhesion to various materials such as stainless steel, polymers, or glass [32]. Transmission electron microscopy not only revealed the presence of appendages [28,47] on exosporium, but also that exosporium was made of a basal crystalline layer surrounded by a hair-like external layer whose filaments vary in length between species and strains [50]. Exosporium contains proteins, polysaccharides, lipids, and ash [41]. Some of the proteins constitutive of or associated with the exosporium were identified on *B. anthracis* [45,48] and *B. cereus* spores [55]. A number of these proteins are not structural components, but are closely associated with the exosporium, such as EA1 [45,61], GroEL [12,45], or InA [12]. Glycoproteins of high molecular weight (over 200 kDa) were identified in extracts from *B. anthracis* [48,49], *B. thuringiensis* [24], and *B. cereus* [12,55] spores. Only a few of the proteins and glycoproteins described in the literature have as yet proven to be required for exosporium constitution or stability. Among the latter, BcIA is a structural component of the hair-like structure [49], while ExsFA and ExsFB are essential for the stability of the basal crystalline layer [51] and ExsA for the assembly of the coat and exosporium of *B. cereus* spores [8]. Some differences among spores from various *B. cereus* strains were previously evidenced. The most frequently reported variation is the surface energy, *B. cereus* spores being moderately to highly hydrophobic [3,31]. Additionally, the number and length of appendages could also differ among strains [28]. All these variations in spore surface properties could affect spore adhesion. Indeed, current theories on the mechanism by which bacteria adhere to inert surfaces suggest the importance of a cell surface's hydrophobic character [11,22]. The presence of appendages, presumed to promote spore adhesion by overcoming the potential barrier and initiating contact with surfaces [59], was also believed to play a major role in attachment [6,32,38], but these results remained highly controversial [38,47]. Lastly, the presence of some surface proteins and glycoproteins was known to play a major role in the adhesion of vegetative cells of various bacteria such as *Enterococcus faecalis* [56] or *Staphylococcus aureus* [13].

Tauveron et al. [52] examined seven strains of *B. cereus* isolated from the environment and from patients with diarrhetic symptoms were examined from two angles: their spore surface properties, and their ability to adhere to stainless steel and resist a cleaning-in-place (CIP) procedure. Their results revealed significant differences in their morphology (size of exosporium, and length and number of appendages), hydrophobic character, and surface protein composition. Most of these proteins originated in the vegetative cell and were tightly bound to the external surface of the exosporium such as EAI or alanine racemase. Spore adhesion properties also varied from strain to strain. The ability to adhere was higher when spores were surrounded by long appendages, while the largest spores displayed the least resistance to cleaning. These observations suggested that food processing line contamination might be due to a given type of strain with specific surface properties (long appendages and small exosporium), which would represent an increased threat under the milder processing conditions required by consumers (e.g., minimally heat-treated foods) and by legal requirements (to limit effluents caused by hygiene procedures).

#### 41.2.2.5 Hygiene Monitoring

The evaluation of the effectiveness of a sanitation program may be carried out in several ways: visual inspection, swabbing and microbiological analysis, contact plates, or ATP (adenosine triphosphate) bioluminescence [29]. Traditional hygiene monitoring using culturing techniques has a number of problems: it is laborious and time consuming. Estimation of the total colony count may take 24–48 h. If it is necessary to detect or estimate the presence of specific microorganisms, 4–7 days may elapse before a result is obtained. Results need to be generated sufficiently quickly to take remedial action or prevent contaminated

surfaces being reused [29]. The technique of ATP bioluminescence involves taking a sample by swabbing a surface and then processing the swab. More details are given by Hawronskyi and Holah [29] and Griffith et al. [27]. These methods can be divided into three different types: cuvette-, pen-, and swab-based. The speed of this method enables remedial action to be taken in the case of poorly cleaned equipment. The disadvantages are: (i) it cannot currently give any indication of the presence or absence of pathogens, only a total level of ATP contamination on a surface; (ii) the presence of detergents or other chemicals may interfere with the bioluminescence reaction; and (iii) it is expensive compared to the low-cost conventional culture techniques [29].

---

## References

1. K. Aarnisalo, K. Tallavaara, G. Wirtanen, R. Maijala, L. Raaska, The hygienic working practices of maintenance personnel and equipment hygiene in the Finnish food industry, *Food Control* 17: 1001–1011 (2006).
2. I. Alli, J. I. Boye, Quality assurance, quality control, inspection, and sanitation, in *Processing Fruits: Science and Technology, Volume 1, Biology, Principles, and Applications* (L. P. Somogyi, H. S. Ramaswamy, Y. H. Hui, eds.), Technomic Publishing Company, Lancaster, PA, 1996, p. 363.
3. A. Andersson, U. Ronner, Adhesion and removal of dormant, heat-activated, and germinated spores of three strains of *Bacillus cereus*, *Biofouling* 13: 51–67 (1998).
4. Anonymous, Council Directive 89/392/EEC on 14 June 1989 on the approximation of the laws of Member States relating to machinery. European Union, 1989.
5. Anonymous, EN 1672-2, *Food Processing Machinery—Basic Concepts, Part 2: Hygienic Requirements*, European Committee for Standardization, Brussels, Belgium, 1997.
6. J. W. Austin, G. Sanders, W. W. Kay, S. K. Collinson, Thin aggregative fimbriae enhance *Salmonella enteritidis* biofilm formation, *FEMS Microbiology Letters* 162: 295–301 (1998).
7. D. Bagge-Ravn, Y. Ng, M. Hjelm, J. N. Christiansen, C. Johansen, L. Gram, The microbial ecology of processing equipment in different fish industries—analysis of the microflora during processing and following cleaning and disinfection, *International Journal of Food Microbiology* 87: 239–250 (2003).
8. K. Bailey-Smith, S. J. Todd, T. W. Southworth, J. Proctor, A. Moir, The ExsA protein of *Bacillus cereus* is required for assembly of coat and exosporium onto the spore surface, *Journal of Bacteriology* 187: 3800–3806 (2005).
9. T. Benezech, C. Lelievre, J. M. Membre, A. F. Viet, C. Faille, A new test method for in-place cleanability of food processing equipment, *Journal of Food Engineering* 54: 7–15 (2002).
10. N. Bennett, C. Boardman, A. Bull, M. Richards, P. Russo, M. C. Edid, Educating smaller rural hospital infection control (IC) nurses, Victoria, Australia, *American Journal of Infection Control* 34(5): E64 (2006).
11. L. Boulange-Petermann, J. Rault, M. N. Bellon-Fontaine, Adhesion of *Streptococcus thermophilus* to stainless steel with different surface topography and roughness, *Biofouling* 11: 201–216 (1997).
12. S. Charlton, A. J. Moir, L. Baillie, A. Moir, Characterization of the exosporium of *Bacillus cereus*, *Journal of Applied Microbiology* 87: 241–245 (1999).
13. C. Cucarella, C. Solano, J. Valle, B. Amorena, I. Lasa, J. R. Penades, Bap, a *Staphylococcus aureus* surface protein involved in biofilm formation, *Journal of Bacteriology* 183: 2888–2896 (2001).
14. EHEDG Update, A method for assessing the in-place cleanability of food-processing equipment, *Trends in Food Science and Technology* 3(12): 325–328 (1992).
15. EHEDG Update, Hygienic equipment design criteria, *Trends in Food Science and Technology* 4(7): 225–229 (1993).
16. EHEDG Update, European hygienic equipment design group, *Trends in Food Science and Technology* 5: 169 (1994).
17. EHEDG Update, Hygienic design of equipment for open processing, *Trends in Food Science and Technology* 6: 305–310 (1995).
18. EHEDG Update, General hygienic design criteria for the safe processing of dry particulate materials, *Trends in Food Science and Technology* 12: 296–301 (2001).
19. EHEDG Update, Hygienic design and safe use of double-seat mixproof valves, *Trends in Food Science and Technology* 12: 203–206 (2001).

20. EHEDG Update, Design of mechanical seals for hygienic and aseptic applications, *Trends in Food Science and Technology* 14: 478–481 (2003).
21. J. A. Evans, S. L. Russell, C. James, J. E. L. Corry, Microbial contamination of food refrigeration equipment, *Journal of Food Engineering* 62: 225–232 (2004).
22. C. Faille, C. Jullien, F. Fontaine, M. N. Bellon-Fontaine, C. Slomianny, T. Benezech, Adhesion of *Bacillus* spores and *Escherichia coli* cells to inert surfaces: role of surface hydrophobicity. *Canadian Journal of Microbiology* 48: 728–738 (2002).
23. J. F. Frank, R. A. Koffi, Surface-adherent growth of *Listeria monocytogenes* is associated with increased resistance to surfactant sanitizers and heat, *Journal of Food Protection* 53: 550–554 (1990).
24. M. Garcia-Patrone, J. S. Tandecarz, A glycoprotein multimer from *Bacillus thuringiensis* sporangia: dissociation into subunits and sugar composition, *Molecular and Cellular Biochemistry* 145: 29–37 (1995).
25. H. Gibson, R. Elton, W. Peters, J. T. Holah, Surface and suspension testing: conflict or complementary, *International Biodegradation and Biodegradation* 36: 375 (1995).
26. J. H. Giese, Food sanitation: more than just good common sense, *Food Technology* 50: 45 (1996).
27. C. J. Griffith, C. A. Davidson, A. C. Peters, L. M. Fielding, Towards a strategic cleaning assessment programme: hygiene monitoring and ATP luminometry, an options appraisal, *Food Science and Technology Today* 11: 15 (1997).
28. Y. Hachisuka, S. Kozuka, M. Tsuijokawa, Exosporia and appendages of spores of *Bacillus* species, *Microbiology and Immunology* 28: 619–624 (1984).
29. J. Hawronskyi, J. Holah, ATP: a universal hygiene monitor, *Trends in Food Science and Technology* 8: 79 (1997).
30. J. Holah, A. Timperley, Hygienic design of food processing facilities and equipment, in *Proceedings of 30th R3-Nordic Contamination Symposium*, Helsinki, Finland, May 30–June 2, 1999, VTT Symposium 193, Libella Painopalvelu Oy, Espoo, pp. 11–39.
31. U. Husmark, U. Ronner, Forces involved in adhesion of *Bacillus cereus* spores to solid surfaces under different environmental conditions, *Journal of Applied Bacteriology* 69: 557–562 (1990).
32. U. Husmark, U. Ronner, The influence of hydrophobic, electrostatic and morphological properties on adhesion of *Bacillus* spores, *Biofouling* 5: 335–344 (1992).
33. Hygiene News, *Food Technology New Zealand* August: 25 (1996).
34. T. J. Imholte, *Engineering for Food Safety and Sanitation*, Technical Institute of Food Safety, Crystal, MN, 1984.
35. ISO 2002, International standard ISO 14159:202, Safety of machinery, Hygiene requirements for the design of machinery, International Organization for Standardization, Switzerland, 2002.
36. N. Johns, *Managing Food Hygiene*, The Macmillan Press, Houndmills and London, 1991.
37. A. M. Katsuyama, J. P. Strachan, *Principles of Food Processing Sanitation*, The Food Processors Institute, Washington, DC, 1980.
38. A. Klavenes, T. Stalheim, O. Sjøvold, K. Kosefsen, P. E. Granum, Attachment of *Bacillus cereus* spores with and without appendages to stainless steel surfaces, *Transactions of the Institution of Chemical Engineers Part C* 80: 312–318 (2002).
39. N. G. Marriott, *Principles of Food Sanitation*, Third Edition, Chapman & Hall, New York, 1994.
40. M. Martinez-Tome, A. M. Vera, A. Murcia, Improving the control of food production in catering establishments with particular reference to the safety of salads, *Food Control* 11: 437–445 (2000).
41. L. L. Matz, T. C. Beaman, P. Gerhardt, Chemical composition of exosporium from spores of *Bacillus cereus*, *Journal of Bacteriology* 101: 196–201 (1970).
42. K. Micklow, M. Morris, P. Markazi, D. Borton, J. Zuckerman, Hand hygiene: staff-driven approach leads to success, *American Journal of Infection Control* 34(5): E61 (2006).
43. S. Nel, J. F. R. Lues, E. M. Buys, P. Venter, The personal and general hygiene practices in the deboning room of a high throughput red meat abattoir, *Food Control* 15: 571–578 (2004).
44. A. Peden, J. Vaughan, Hand hygiene, *American Journal of Infection Control* 34(5): E60 (2006).
45. C. Redmond, L. W. Baillie, S. Hibbs, A. J. Moir, A. Moir, Identification of proteins in the exosporium of *Bacillus anthracis*, *Microbiology* 150: 355–363 (2004).
46. D. A. Shapton, N. F. Shapton, *Principles and Practices for the Safe Processing of Foods*, Butterworth Heinemann, Oxford, 1991.
47. T. Stalheim, P. E. Granum, Characterization of spore appendage from *Bacillus cereus* strains, *Journal of Applied Microbiology* 91: 839–845 (2001).

48. C. Steichen, P. Chen, J. F. Kearney, C. L. Tumbough, Identification of the immunodominant protein and other proteins of *Bacillus anthracis* exosporium, *Journal of Bacteriology* 185: 1310–1903 (2003).
49. P. Sylvestre, E. Couture-Tosi, M. Mock, A collagen-like surface glycoprotein is a structural component of the *Bacillus anthracis* exosporium, *Molecular Microbiology* 45: 169–178 (2002).
50. P. Sylvestre, E. Couture-Tosi, M. Mock, Polymorphism in the collagen-like region of the *Bacillus anthracis* BcIA protein leads to variation in exosporium filament length, *Journal of Bacteriology* 185: 1555–1563 (2003).
51. P. Sylvestre, E. Couture-Tosi, M. Mock, Contribution of ExsFA and ExsFB proteins to the localization of BcIA on the spore surface and to the stability of the *Bacillus anthracis* exosporium, *Journal of Bacteriology* 187: 5122–5128 (2005).
52. G. Tauveron, C. Slomianny, C. Henry, C. Faille, Variability among *Bacillus cereus* strains in spore surface properties and influence on their ability to contaminate food surface equipment, *International Journal of Food Microbiology* 110: 254–262 (2006).
53. M. E. Thorner, P. B. Manning, *Quality Control in Food Service*, Avi Publishing Company, Westport, 1983.
54. R. H. Thorpe, Hygienic design considerations for chilled food plants, in *Chilled Foods a Comprehensive Guide* (C. Dennis, M. Stringer, eds.), EllisHorwood, West Sussex, 1992, p. 343.
55. S. J. Todd, A. J. Moir, M. J. Johnson, A. Moir, Genes of *Bacillus cereus* and *Bacillus anthracis* encoding proteins of the exosporium, *Journal of Bacteriology* 185: 3373–3378 (2003).
56. A. Toledo-Arana, J. Valle, C. Solano, M. J. Arrizubieta, C. Cucarella, M. Lamata, B. Amorena, J. Leiva, J. R. Penades, I. Lasa, The enterococcal surface protein, Esp, is involved in *Enterococcus faecalis* biofilm formation, *Applied and Environmental Microbiology* 67: 4538–4545 (2001).
57. J. A. Troller, *Sanitation in Food Processing*, Academic Press, New York, 1983.
58. E. Underwood, Good manufacturing practices—a means of controlling biodeterioration, *International Biodeterioration and Biodegradation* 36: 449 (1995).
59. M. C. M. van Loosdrecht, J. Lyklema, W. Norde, A. J. B. Zehnder, Bacterial adhesion: a physico-chemical approach, *Microbial Ecology* 17: 1–15 (1989).
60. F. B. Vogel, H. H. Huss, B. Ojeniyi, P. Ahrens, L. Gram, Elucidation of *Listeria monocytogenes* contamination routes in cold-smoked salmon processing plants detected by DNA-based typing methods, *Applied and Environmental Microbiology* 67: 2586–2595 (2001).
61. D. D. Williams, C. L. Turnbough, Surface layer protein EA1 is not a component of *Bacillus anthracis* spores but is a persistent contaminant in spore preparations, *Journal of Bacteriology* 186: 566–569 (2004).
62. G. Wirtanen, Biofilm formation and its elimination from food processing equipment. VTT Publications, Doctoral thesis, Espoo, VTT Offsetpaino, Finland, 1995.

# 42

## *Hazard Analysis and Critical Control Point (HACCP)*

Titus De Silva

### CONTENTS

42.1	Background.....	970
42.1.1	Need for an Effective Food Safety Assurance System .....	970
42.1.2	The Development of HACCP .....	971
42.1.3	Benefits of HACCP .....	971
42.2	Terminology .....	972
42.3	Management Commitment .....	972
42.4	Prerequisite Programs.....	973
42.5	The Scope of the HACCP Program .....	974
42.6	The Seven Principles .....	974
42.7	Development of the HACCP Plan .....	974
42.7.1	The Team .....	975
42.7.2	Training .....	975
42.7.3	Product Description and Intended Use .....	976
42.7.4	Flow Diagram .....	976
42.7.5	Types of Hazards .....	977
42.7.5.1	Biological Hazards.....	977
42.7.5.2	Chemical Hazards .....	979
42.7.5.3	Physical Hazards .....	979
42.7.6	Sources of Hazards .....	979
42.7.6.1	Raw Materials .....	979
42.7.6.2	Processing Steps .....	979
42.7.6.3	Machinery .....	980
42.7.6.4	Handling of Food.....	980
42.7.6.5	Environmental Conditions .....	980
42.7.7	Some Measures for Controlling Hazards .....	980
42.7.7.1	Measures at the Processing and Packaging Stages .....	980
42.7.7.2	Measures at Postprocessing and Packaging Stages.....	982
42.7.7.3	The Consumer .....	983
42.7.8	Hazard Analysis.....	983
42.7.9	Assessing the Hazard Potential .....	984
42.7.9.1	Assessment of Raw Materials .....	984
42.7.9.2	Assessment of the Process.....	984
42.7.9.3	Assessment of the Product during Storage and Delivery .....	985
42.7.9.4	Assessment of End Use .....	985
42.7.10	Critical Control Points .....	986
42.7.10.1	Classification .....	986
42.7.10.2	Location of the CCPs.....	986
42.7.10.3	Determination of the CCPs .....	986
42.7.11	Identification of the CCPs .....	987
42.7.11.1	Decision Tree .....	987
42.7.11.2	Risk Analysis .....	988



42.7.12	Establishing Critical Limits for Each CCP .....	990
42.7.13	Establishing Procedures and Equipment for Monitoring the CCPs .....	990
42.7.14	Establishing Corrective Actions .....	991
42.7.15	Verification Procedures .....	991
42.7.16	Documentation and Record Keeping .....	991
42.7.17	Validation Procedures .....	992
42.8	Consumer Protection .....	992
42.9	Management of the HACCP Program .....	992
42.9.1	Review, Audit, and Recall Processes .....	992
42.9.1.1	Review .....	992
42.9.1.2	Audit .....	993
42.9.1.3	The Product Recall Process .....	994
42.10	Benefits of Implementing an HACCP System .....	994
42.11	HACCP in the Overall Quality System .....	994
42.12	Case Study I: Production of Chicken and Vegetable Salad .....	997
42.12.1	Product Description .....	997
42.12.2	Assessing the Hazard Potential of Chicken and Vegetable Salad .....	997
42.12.2.1	Raw Materials .....	998
42.12.2.2	Process .....	998
42.12.2.3	Product .....	999
42.12.2.4	End Use .....	999
42.12.3	Application of Decision Tree .....	1000
42.12.4	Overall Risk Assessment and Reduction .....	1002
42.12.5	Control Schedule .....	1002
42.13	Case Study II: Production of Vacuum-Packed Hot-Smoked Salmon .....	1002
42.13.1	Product Description .....	1002
42.13.2	Assessment of Hazard Potential of Vacuum-Packed Hot-Smoked Salmon .....	1002
42.13.2.1	Raw Materials .....	1002
42.13.2.2	Process .....	1004
42.13.2.3	Product .....	1005
42.13.2.4	End Use .....	1006
42.13.3	Risk Assessment .....	1006
42.13.4	Overall Risk Assessment and Reduction .....	1006
42.13.5	Control Schedule .....	1008
42.14	Good Manufacturing Practices .....	1008
42.15	ISO 22000 Standard .....	1008
	References .....	1008

---

## 42.1 Background

### 42.1.1 Need for an Effective Food Safety Assurance System

Food safety has been an area of concern since the Middle Ages and regulatory measures have been enforced to prevent the sale of adulterated or contaminated food. Many rules and recommendations advocated in religions or historical texts are evidence of the concern to protect people against foodborne diseases and food adulteration. Motarjemi et al. [1] summarized the present situation and emphasized the need for an effective food safety program [1].

Technological progress in food processing has brought about greater awareness of the problems associated with food preservation. With the expansion of global food trade, food safety has become an issue worldwide. According to the World Health Organization (WHO), “thousands of millions” of cases of foodborne illnesses occur every year and two million children die each year from diarrhea. These cases relate to microbiological contaminants only, and if chemical and physical contaminants are taken into consideration the number of cases would be much higher [2].

International food trade contributes to the spread of foodborne illnesses in five ways [2]: (a) new threats arise as a result of the introduction of pathogens and contaminants from one country to another, (b) pathogens

that have been controlled in one country can be reintroduced by another country where it has not been controlled, (c) transportation over long distances and long periods of time provides ample opportunities for contamination and growth of microorganisms, (d) contaminated food can reach more people resulting in major outbreaks of disease, and (e) history of the food product may be unknown by the importing country when trans-shipment of food through one or more countries takes place. International and national organizations have enforced laws and regulations to achieve quality and safety in food preparation and preservation, in order to safeguard the consumer from foodborne infections and intoxication.

### 42.1.2 The Development of HACCP

The principles of the Hazard Analysis and Critical Control Point (HACCP) technique were applied to the chemical processing industry, particularly in Great Britain, more than 40 years ago [3]. The Pillsbury Company, together with NASA and the U.S. Army's Research, Development and Engineering Center at Natick, first developed this system to ensure the safety of astronauts' food [1,4,5]. Since then the HACCP system has grown to become a universally recognized and accepted method for food safety assurance. WHO has recognized the importance of the HACCP system for prevention of foodborne diseases for over 20 years and has played an important role in its development and promotion. One of the highlights in the history of the HACCP system was when the Codex guidelines for application of the HACCP system were adopted by the FAO/WHO Codex Alimentarius Commission in 1993, requiring them for international trade [6]. In the United States, large chemical industries have also adopted hazard control programs. The U.S. Occupational Safety and Health Administration (OSHA) introduced the HACCP technique to reduce accidents.

### 42.1.3 Benefits of HACCP

Lack of food safety systems costs the food industry millions of dollars annually through waste, reprocessing, recalls, and the resulting loss of sales. Foodborne diseases are no longer limited to developing countries. In the United States, the Centers for Disease Control and Prevention (CDC) report that foodborne diseases account for 76 million illnesses; 325,000 hospitalizations; and 5000 deaths each year. According to WHO, the medical cost of just five foodborne diseases in England and Wales was estimated at £300–£700 million in 1996 [2].

It is now recognized internationally that the most cost-effective approach to food safety is through the application of the HACCP technique. By adopting an effective safety system based on HACCP, the food industry can minimize the potential for things to go wrong and ensure the safety of food products. HACCP is entirely complementary and adds essential safety elements to existing processing systems, such as good manufacturing practices (GMPs) and ISO 9000 standards. Food producers as well as retailers and consumers will be benefited as a result of an effective HACCP program. The benefits of the HACCP system are summarized in Table 42.1 [1].

**TABLE 42.1**

Benefits of the HACCP System

- 
- Ensures safety of food products through preventive measures rather than through final inspection and testing
  - Capable of identifying all potential hazards
  - Easy to introduce technological advances in equipment design and processing procedures related to food products
  - Directs resources to the most critical part of the food processing system
  - Encourages confidence in food products by improving the relationship among regulatory bodies, food processors, and the consumer
  - Promotes continuous improvement of the system through regular audits
  - Focuses on safety issues in the whole chain, from “farm to fork”
  - Complements the quality management system (e.g., ISO 9000)
-

**TABLE 42.2**

## Terminologies Related to HACCP

<b>Term</b>	<b>Definition</b>
<i>Hazard</i>	A biological, chemical or physical, or other property in a food product that has the potential to harm the consumer or cause illness. It can occur in the ingredients or at any stage in the life of a product. The term can thus be applied to foreign material, chemical residues, and microbiological contamination
<i>Severity</i>	The seriousness or consequence of exposure to the hazard
<i>Risk</i>	The estimate of the probability of a hazard occurring
<i>Hazard analysis</i>	The identification of biological, chemical or physical, or other hazards associated with ingredients, production practices, processing, storage, distribution, retailing, and use
<i>Critical control point (CCP)</i>	An operational step in a manufacturing process that could result in injury or put the consumer at risk if not controlled. At critical control points, controlling measures can be exercised to eliminate or minimize any form of hazard
<i>Control point</i>	An operational step in a manufacturing and distribution process that may be controlled to maintain quality and meet regulatory requirements
<i>HACCP plan</i>	A document that sets out the procedures, based on the principles of HACCP, to be followed to assure food safety
<i>Hazard analysis and critical control point (HACCP)</i>	A scientific, rational, and systemic approach to identification, assessment, and control of hazards during production, processing, manufacturing, preparation, and use of food to ensure that it is safe when consumed. The HACCP system provides a preventive, and thus a cost-effective, approach to food safety
<i>HACCP system</i>	The organizational structure, procedures, processes, and resources needed to implement the HACCP plan
<i>Critical limit</i>	One or more prescribed tolerances that must be met to ensure that a CCP effectively controls a health hazard
<i>Sensitive ingredient</i>	An ingredient known to have been associated with a hazard and about which there is a concern
<i>Validation</i>	A review of the HACCP plan to ensure that all elements of the plan are accurate and correct
<i>Verification</i>	The use of methods, procedures, and tests to ensure that the requirements of the HACCP system have been fulfilled

## 42.2 Terminology

Terms important to the HACCP concept—such as hazard, severity, risk, and hazard analysis—are defined in Table 42.2. It is important to understand the terminology first before applying the HACCP procedure in food systems.

## 42.3 Management Commitment

The designing and implementation of an HACCP system is the responsibility of the HACCP team. But the senior management must be aware of the fundamental requirements of the food safety program so that they can commit the necessary resources and have a positive approach to the project. Its role then is to influence the project's success by creating a “buy-in” from every member of the organization. In the absence of total commitment from the senior managers, the organization runs the risk of failure at a critical point [7]. The senior management must acknowledge that an HACCP program is a comprehensive tool that helps everyone in the organization to maintain a safe food production and serving

environment. As with a quality management system (QMS), the food safety program involves suppliers, staff, and customers. In addition, the organization has to comply with regulatory requirements. Therefore, support from the senior management team, regulatory bodies, training institutions, and the industry is essential in designing an effective food safety program. Suppliers can support the organization's commitment by recommending equipment and procedures that will assist in realizing the long-term food safety goals [8].

## 42.4 Prerequisite Programs

Prerequisite programs are an essential part of the HACCP program. These provide the basic environment and operating conditions that ensure the production and delivery of safe foods. It is not possible to implement an HACCP program without the prerequisite programs in place. The National Advisory Committee for the Microbiological Criteria for Foods (NACMF) [9] has recommended the prerequisite programs shown in Table 42.3 as a foundation for an effective HACCP system in the organization.

Other prerequisite programs might include (a) quality assurance procedures, (b) product formulations, (c) glass control, (d) labeling, and (e) employee food and ingredient handling practices. An HACCP program ensures that the food is safe to consume and the integration of the prerequisite programs provides assurance that the food is safe as well as wholesome. The prerequisite programs have to be regularly audited and reviewed just like any other management program. While these programs can be managed separately from the HACCP program, some aspects such as recall procedure, preventive maintenance, sanitation, and hygiene may be incorporated into the HACCP plan.

**TABLE 42.3**  
Prerequisite Programs

Prerequisite Program	Scope
1 Facilities and premises	<ul style="list-style-type: none"> <li>● Suitability of production environment, including buildings, pathways, drainage, waste management, etc.</li> <li>● Provision of adequate space for manufacture, storage, cooling, and refrigeration</li> <li>● Provision of ventilation, water supply, and lighting facilities for personnel</li> </ul>
2 Supplier control	<ul style="list-style-type: none"> <li>● Program for the approval of suppliers</li> <li>● An effective GMP and food safety programs</li> </ul>
3 Specifications	<ul style="list-style-type: none"> <li>● Written specifications for all ingredients, packagings, and processes</li> </ul>
4 Equipment	<ul style="list-style-type: none"> <li>● Calibration of equipment</li> <li>● Preventive maintenance according to an established schedule</li> </ul>
5 Cleaning and sanitation	<ul style="list-style-type: none"> <li>● Validation of sanitation methods</li> <li>● Availability of documented procedures</li> <li>● Regular cleaning and sanitation of equipment</li> </ul>
6 Personnel hygiene	<ul style="list-style-type: none"> <li>● Establish a personnel hygiene policy</li> <li>● Ensure that all employees follow the required personnel hygiene policy</li> </ul>
7 Training	<ul style="list-style-type: none"> <li>● Management of training records in personnel hygiene, GMP, cleaning, sanitation procedures, personnel safety, and their role in the HACCP program</li> </ul>
8 Management of chemicals	<ul style="list-style-type: none"> <li>● Proper and safe storage and segregation of food and nonfood chemicals</li> </ul>
9 Receiving, storage, and transport	<ul style="list-style-type: none"> <li>● Storage of all raw materials and products under sanitary conditions</li> <li>● Maintaining appropriate environmental conditions for storage</li> </ul>
10 Traceability and recall	<ul style="list-style-type: none"> <li>● Batch coding of all raw materials and products</li> <li>● Establish an effective recall procedure</li> </ul>
11 Pest control	<ul style="list-style-type: none"> <li>● An effective pest control program</li> </ul>

## 42.5 The Scope of the HACCP Program

In the early years following the introduction of HACCP, concern was focused on microbiological integrity. The basic philosophy was to examine the food ingredients as they are processed, until consumption of the finished product. Aggressive competition required organizations to reduce costs while maintaining quality. Increasing consumer awareness and legal liability to produce safe food forced organizations to adopt a broader view of the food safety program. There were other significant changes. Changes in process technology, increased automation, complex packaging solutions, new ingredients and improved formulations, greater emphasis on sensory evaluations and complex distribution networks leading to reduced delivery times had a major impact on food safety requirements.

The generic requirements of food safety were stipulated in the Codex Alimentarius, which is a collection of food standards adopted by the Codex Alimentarius Commission [10]. The HACCP program incorporates the general principles of food hygiene as well as appropriate commodity standards. In 1998, the British Retail Consortium (BRC) developed and introduced the BRC technical standards and protocols for supplying retailer-branded food products. Although, it was originally developed primarily for the supply of retailer-branded products, in recent years it has been used as a basis for developing HACCP programs. It incorporates the management system of ISO 9000, principles of Codex Alimentarius, and GMPs [11]. Thus, a complete HACCP program includes: (i) HACCP principles, (ii) management principles, (iii) plant environment standards, (iv) process and product control, and (v) personnel hygiene.

## 42.6 The Seven Principles

The seven principles of HACCP were formulated by the NACMF in 1987 [12]. They are now widely accepted as the standard for developing a food safety program:

1. Analyze the hazards and assess the risks
2. Identify the critical control points (CCPs)
3. Define critical limits for each CCP
4. Establish controls to monitor the CCPs
5. Establish corrective actions
6. Define record-keeping and documentation requirements
7. Establish verification procedures

These seven principles form the framework of the HACCP program and will be described in the sections that follow. In the future, three more principles may be added [13] to the seven already in place: (1) summary and interpretation of each HACCP system (this review briefly summarizes the system, indicates any remaining hazards, and assesses the risks of occurrence); (2) education and training; and (3) validation.

## 42.7 Development of the HACCP Plan

The development of the HACCP plan goes through four distinct stages. The key tasks associated at each stage (Table 42.4) are applicable to any food processing operation regardless of the size. The program evolves as the HACCP team works through these stages [14]. It is a good idea to carry out an HACCP study for each new product in each plant. Hazard

**TABLE 42.4**

Development of the HACCP Plan

Stage	Key Tasks
1	<ol style="list-style-type: none"> <li>1. Assemble the team</li> <li>2. Train the staff</li> <li>3. Describe the product and intended use</li> </ol>
2	<ol style="list-style-type: none"> <li>4. Draw the flow diagram</li> <li>5. Analyze the hazards (Principle 1)</li> <li>6. Establish the CCPs (Principle 2)</li> <li>7. Define critical limits (Principle 3)</li> <li>8. Establish monitoring methods (Principle 4)</li> <li>9. Establish corrective actions (Principle 5)</li> </ol>
3	<ol style="list-style-type: none"> <li>10. Define verification methods (Principle 6)</li> <li>11. Establish documentation and record-keeping requirements (Principle 7)</li> <li>12. Validate the HACCP plan</li> </ol>
4	<ol style="list-style-type: none"> <li>13. Review and improve the program</li> </ol>

analysis critically examines the quality of all ingredients, processing steps, and the product itself. The CCPs can be identified by analyzing the hazards in each processing step. The HACCP plan is managed by regular monitoring and reviewing of the system through implementation of corrective action when necessary.

#### 42.7.1 The Team

The HACCP study begins with the selection of a team consisting of members drawn from various disciplines in the food processing operation. The success of the HACCP program depends on the constitution of the HACCP team [15]. It is not a management team, but a team drawn from all levels depending upon the expertise and experience required. All the key functions of the organization should be represented in the team and may include a project leader, a production manager, a technical expert, an engineer, a secretary, and others as required. Once the team is formed, the members will require further training on HACCP principles and they should be provided with the necessary tools to perform the tasks. The team's objectives [16] will be (i) to define the type of food produced by the organization, (ii) how the ingredients are received, (iii) to define the processes and their controls, (iv) how the food is stored and distributed, and (v) to identify the hazards and the CCPs. In the absence of in-house expertise, it may be necessary to seek the advice of external consultants. The team leader or coordinator has a significant impact on the outcome of the program and will be responsible for assigning various tasks to the team members. The responsibilities of the team are summarized in Table 42.5.

#### 42.7.2 Training

HACCP training has now been accepted as the most cost-effective means of controlling hazards related to microbiological, physical, and chemical contamination of foods. Implementation of the HACCP plan is a team exercise; thus, training and education are essential if full benefits are to be achieved [17]. Food producers have a responsibility to produce safe food products, and regulatory bodies need to be competent in monitoring the HACCP programs.

HACCP training should provide (a) knowledge of concepts, principles, and benefits of the HACCP program; (b) practical skills and knowledge necessary for the implementation of the HACCP program; and (c) the skills needed for further development of the HACCP program. Regulatory authorities, senior managers, shop floor personnel, and technical managers should be involved in the HACCP training program. The training program itself should target the needs of each of these groups. For example, regulatory authorities need to have knowledge of the concepts, principles, and benefits of the HACCP programs, while the shop floor personnel need to have practical skills. Scientific data should be used to support the training progress. Software on HACCP programs, are now available and the material presented in such programs can be an essential tool for training.

**TABLE 42.5**

Responsibilities of the HACCP Team Members

<b>Team Member</b>	<b>Responsibility</b>
Project leader	<ul style="list-style-type: none"> <li>• Convenes and chairs meetings</li> </ul>
Production manager	<ul style="list-style-type: none"> <li>• Constructs flow charts</li> <li>• Advises on production issues and process capability</li> </ul>
Technical expert	<ul style="list-style-type: none"> <li>• Advises on technical issues</li> <li>• Identifies hazards and recommends solutions</li> </ul>
Engineer	<ul style="list-style-type: none"> <li>• Supplies information on the performance of equipment and machinery</li> <li>• Makes recommendations on new machinery, equipment, or processes that may be required</li> </ul>
Secretary	<ul style="list-style-type: none"> <li>• Records proceedings of the meetings</li> </ul>
Others (as required)	<ul style="list-style-type: none"> <li>• Provide information on specialist areas</li> </ul>

### 42.7.3 Product Description and Intended Use

The HACCP team needs to have a complete understanding of the product, its intended use, the ingredients used, the composition of the product, and the processing steps. It is necessary to have this information before analyzing for hazards because the food products have to be assessed in relation to the ability of different pathogens to grow. The product description [18] should include (i) name of the product, (ii) end-product features (e.g., pH, preservatives, etc.), (iii) how the product is to be used (i.e., ready-to-eat, further processing, or heated prior to consumption), (iv) packaging details (e.g., packaging materials and packaging conditions), (v) shelf life, (vi) distribution outlets, (vii) labeling instructions, (viii) shipping conditions, and (ix) target consumer group. An example of a product description is shown in Table 42.6.

The list of product ingredients should include raw materials, processing aids, and packaging material. Regulatory requirements have to be checked to ensure that the additives and preservatives are permissible and within the specified limits. An example of a list of ingredients and packaging materials is shown in Table 42.7.

The team has to gather further information on the processing steps and formulations used in the production of food. A checklist may include, but not limited to, the following: (i) possibility of contamination during preparation and storage; (ii) inactivation of microorganisms and toxins, and the possibility of microbiological, chemical, and physical contamination during processing; (iii) pH, water activity ( $a_w$ ), and reduction/oxidation potential; (iv) possibility of the presence of microorganisms in raw materials and packaging; (v) basis of the process technology; and (vi) effect of packaging on the survival and growth of microorganisms.

### 42.7.4 Flow Diagram

Food processing operation is a continuous flow of food ingredients from “farm to fork” (growing, harvesting, receiving, storage, processing, packaging, transportation, and service). A flow diagram breaks up the process into a series of sequential steps that assist further evaluation. It typically commences at the point where the food is received at the operation. Thus, the steps in the flow diagram include the entry of ingredients, all the processing steps, packaging, storage, distribution, and handling by the consumer. In a simple flow diagram, the process steps are shown inside boxes with arrows indicating the entry and exit points.

In a large food production operation, it is not possible to draw flow diagrams for each of the recipes. However, they could be grouped

**TABLE 42.6**

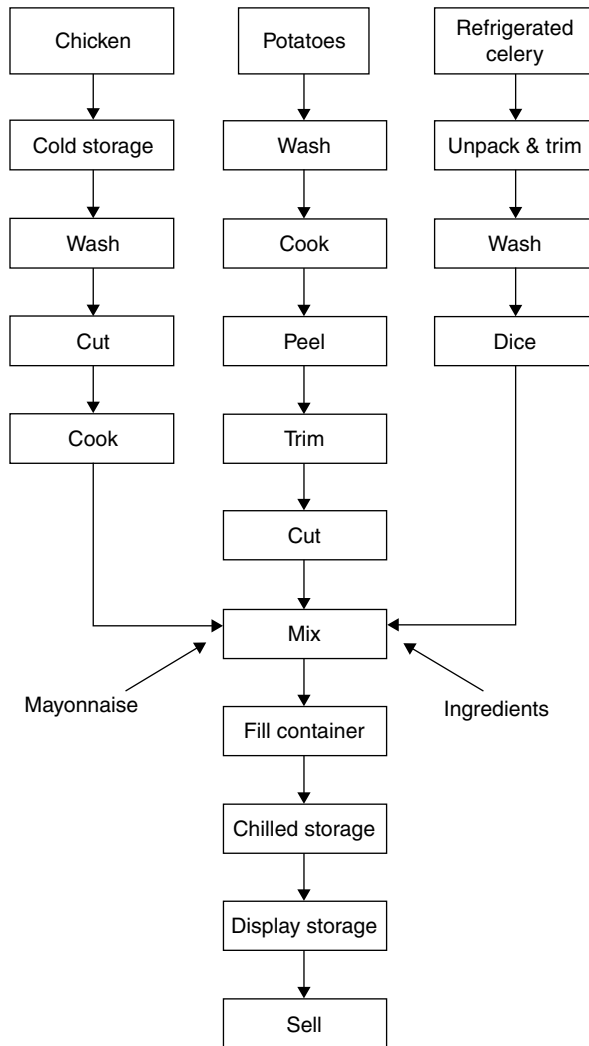
Product Description of Country Medium Wine

Product Feature	Description
Product name	Country Medium Wine
Product features	Alcohol 12% v/v, pH, preservatives, and SO <sub>2</sub>
How the product is to be used	Cool before serving
Packaging	3 L plastic bags of special composition that prevent the entry of O <sub>2</sub>
Shelf life	9 months from the date of packing
Distribution outlets	Retail shops
Labeling	Alcohol content, preservatives, storage conditions, and the number of standard drinks
Shipping conditions	No physical damage or extremes of temperature
Target consumer group	None

**TABLE 42.7**

List of Raw Materials Used in the Production of Wine

Primary Ingredients	Chemicals	Packaging Materials	Noncontact Packaging
Grapes	See attached list (attach list of chemicals used)	Bottles, glass Bottles, plastic 3 L bags Metal caps Plastic caps Corks	Cases, corrugated board Labels Muselets Shrouds Capsules, PVC Sections, corrugated board



**FIGURE 42.1** Flow diagram for the production of chicken and vegetable salad.

according to the method of processing, e.g., baking, cooking, chilling, steaming, cold preparations, etc. Yet another approach is to group recipes according to the category of food—thin cooking, thick cooking, sauces and brews, fruits and vegetables, starches, breads and butter, cold combinations, and hot combinations. In such instances, a single flow diagram would be adequate for each food category [19]. Figures 42.1 and 42.2 show the flow diagrams for the production of chicken and vegetable salad, and hot smoked salmon, respectively.

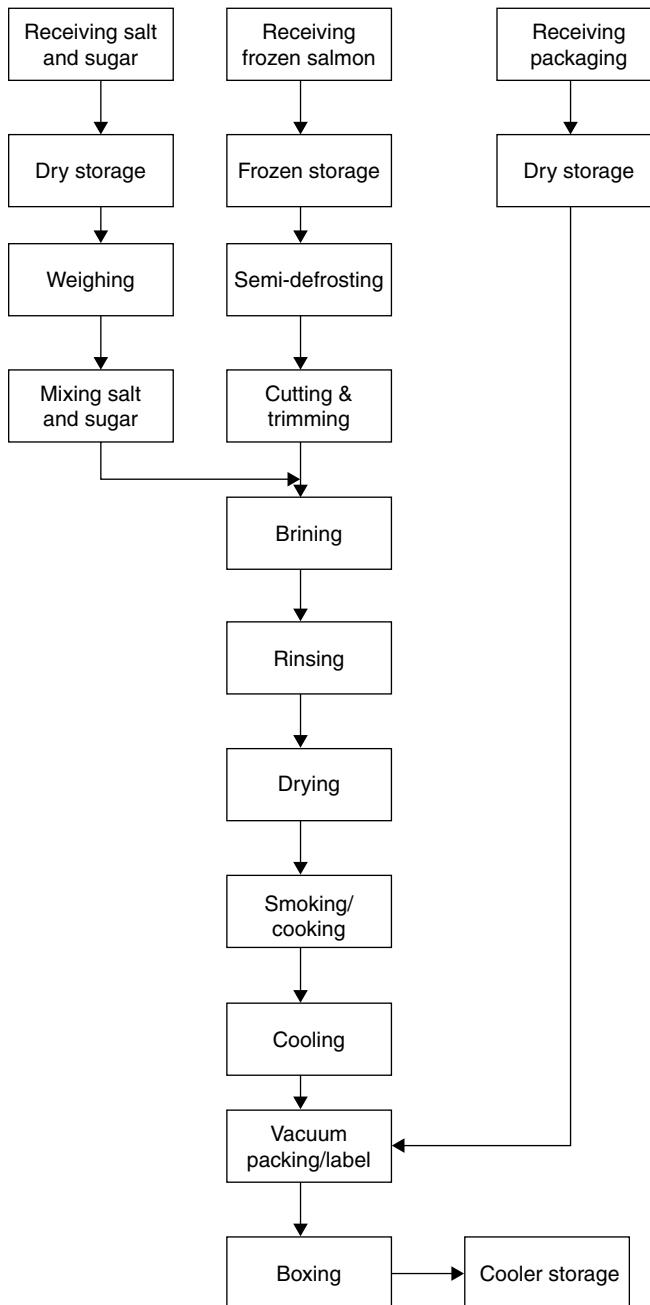
### 42.7.5 Types of Hazards

Hazards in food processing can be classified into three types: biological, chemical, and physical.

#### 42.7.5.1 Biological Hazards

Biological hazards are associated with microbiological organisms such as bacteria, viruses, fungi, and parasites. Most foodborne illnesses are caused by pathogenic bacteria and a certain level of microorganisms is present in some raw foods. Viruses can be foodborne/waterborne or transmitted by human, animal,





**FIGURE 42.2** Flow diagram for the production of vacuum-packed hot-smoked salmon.

or other contact. They survive on living cells and therefore cannot replicate in food but can reside in it. Parasites are host specific but can include humans in their life cycle. They occur in undercooked meat products or contaminated ready-to-eat food. Fungi include molds and yeasts, and some produce mycotoxins, which are toxic for humans and animals. The survival and growth of microorganisms depend upon several factors: (i) inadequate time–temperature combination during heat treatment, (ii) slow acid production during fermentation, (iii) holding foods between 7°C and 65°C because of processing delays, (iv) storage of foods for long periods at refrigerated temperature, (v) high water activity ( $a_w$ ), and (vi) low levels of chemical preservatives.

### **42.7.5.2 Chemical Hazards**

Chemicals are used in the production of food, e.g., pesticides are applied in agriculture and food additives are used during the formulation and processing stages of food products. The types and concentration of chemicals are important for safety aspects. Some examples of hazardous chemicals are heavy metals such as lead, tin, cadmium, copper, and mercury; food additives such as certain preservatives, colorings, and conditioners; and others such as solvents, cleaning agents, paints, and additives.

### **42.7.5.3 Physical Hazards**

Physical hazards are caused by foreign matter that can enter into a food product at any stage from the processing of raw materials to consumption of the finished product. Foreign matter may be visible to the naked eye or may be dissolved or dispersed in the food product. The physical form of the foreign matter can vary from powder to particulate matter, depending upon its type and origin. The detection of foreign matter in a food product is not easy because of the variability and infrequent occurrence. Some of the common types of foreign matter associated with physical hazards in food are insects, spiders, worms, etc. (although these organisms are nonhazardous in themselves, they may carry pathogenic microorganisms), parts of animals, birds, metals, machine parts, glass pieces, plastic objects, sand, stones, dirt, cigarette butts, and plastic dressing strips.

## **42.7.6 Sources of Hazards**

### **42.7.6.1 Raw Materials**

Raw materials are the primary source of contamination. Failure to follow basic quality assurance procedures on raw materials may lead to food products that are unsafe for consumption. The common quality assurance procedures carried out on raw materials are related to: (i) identification and labeling, (ii) storage conditions, (iii) handling requirements, (iv) preparation and processing, and (v) isolation of unsuitable raw materials. The raw materials that are most likely to cause microbial hazards are meat, poultry, fish, and dairy products. The level of microbial contamination depends upon the [20] (a) source, (b) refining and handling process, (c) packaging material, and (d) storage conditions.

The HACCP technique is closely associated with the protection of the consumer from microbiological hazards. Such narrow focus has been criticized on the grounds that microbiological hazards account for only one type of hazard [21]. Raw materials may carry traces of chemicals and foreign matter. Heavy metals such as lead, arsenic, mercury, tin, and cadmium are thought to be of greatest health concern. They occur in vegetables grown in contaminated soils. Packaging materials such as lead capsules in wine bottles and solder from the side seams of cans are potential sources of contamination. Adhesives, coatings, and resins used in packages may cause health hazards unless they comply with the health and safety requirements [22]. Seam defects in cans and seal defects in other packaging designs can lead to microbial contamination.

Cleaning chemicals, solvents, lubricants, and dirty or incompletely washed bottles may contaminate food products. Excessive amounts of sulfur dioxide used in the sterilization process prior to filling bottles result in high levels of sulfur dioxide in the food product (e.g., high sulfur dioxide levels in wine). Preservative colorings, flavors, and conditioners are common additives used in food processing, and excessive amounts of these can be harmful. The permissible levels of food additives are governed by the food regulations in each country. Fruits and vegetables sprayed with pesticides can retain high levels of pesticide residues unless the applications are carefully monitored. Foreign objects such as stones and insect parts may also be found in fruits and vegetables. An unhygienic working environment can promote contamination with rodent bait, insecticides, insects, etc. Other sources of chemical and foreign body contamination include glass fragments from broken light fittings and thermometers; stones and particles of wood in sun-dried fruits, herbs, and spices; and accidental contamination with cleaning chemicals or other toxic nonfood substances [23].

### **42.7.6.2 Processing Steps**

Uncontrolled processing operations can lead to hazardous situations. Failure to maintain processing conditions such as temperature/time delay in processing, using incorrect formulations and procedures, and following unauthorized processing techniques may all result in contamination or microbial growth.

Mercury thermometers in the processing area can be a potential hazard, and most industries prohibit the use of such thermometers in their factories. Poor cleaning practices may leave excess cleaning chemical residues on plant and equipment.

### **42.7.6.3 Machinery**

Unclean and unhygienic equipment can easily promote the growth of microorganisms or other hazards. Failure to maintain the sterility of equipment when it is required results in microbial contamination. Proper setting up of equipment should also be followed. Glass bottles can get chipped at the filler or capping machine if the machines are not properly set up. Imperfectly made containers can also contaminate the food with the material of the container. Metal pieces from meshes or metal parts and nuts and bolts can easily get mixed with the food product if the machines are not regularly maintained. Badly designed or modified plant and equipment can promote the growth of microorganisms in dead ends of pipe work or dirt traps.

Preventive maintenance of machinery is an important aspect in a safety-management program. If safety requirements are ignored, the layout of the machinery and equipment can be a potential hazard. The machinery should be examined at intervals to ensure safe operation. Any change in engineering should be such that it is not hazardous.

### **42.7.6.4 Handling of Food**

With the introduction of highly automated and high-speed machinery, vast volumes of food products are processed, stored, and transported to distribution centers and retail chains. Therefore, food safety depends upon processing characteristics as well as handling during transport, storage, and customer use. Hazards may develop due to inadequate temperature control during storage, transportation, retail handling, and home storage. Products such as chilled/frozen entrees and meal components are preserved by refrigeration. If these products are stored at higher temperatures or used beyond their recommended shelf life [24], it may prove hazardous.

Failure to rotate stocks of dated products can result in outdated products reaching the consumer. Abuse by the customer is possible in the absence of clear storage or preparation instructions. Lack of knowledge about handling, cooking, and storage of foods increases the risk of hazard occurrence. Personal hygiene is extremely important in any food-serving establishment. If adequate precautions are not taken, food handlers can transmit pathogenic bacteria. Personal articles such as jewelry can get mixed with foods during preparation.

### **42.7.6.5 Environmental Conditions**

Hazards due to environmental conditions may affect raw materials, processing, and machinery. Pollution of water and soil can have alarming results through the food chain. Through regulatory requirements, most countries monitor and control the disposal of domestic and industrial wastes to prevent the entry of hazardous materials and rodents into the food production environment. Environmental contamination may also be due to foreign matter, chemicals such as sprays, and contaminants in water.

## **42.7.7 Some Measures for Controlling Hazards**

### **42.7.7.1 Measures at the Processing and Packaging Stages**

*Raw Materials:* In a food processing environment, raw materials constitute one of the most important areas that must be carefully controlled. The food producer has no direct control over the quality of the incoming raw materials. Until adequate control can be established over the entire range of raw materials to prevent the entry of or eliminate harmful or potentially harmful organisms and residues, constant vigilance must be maintained. This is particularly true of “sensitive ingredients,” those ingredients that have been historically associated with a known hazard, such as eggs, fish, milk, cheese, shellfish, etc. The processes used to remove or destroy microorganisms in raw materials and packaging are shown in Table 42.8 [20]. Some of the controls that can be established to ensure that incoming raw materials do not cause a health hazard are summarized in Table 42.9.

Packaging materials can also be a source of health hazard since most users are unaware of the materials used. Controls can be established by specifying the recommended types of packaging materials. Bulk containers that are used to transport food products should have a cleaning program in place, which should be audited. Only permissible products should be transported in bulk containers that are used to carry food products. Other controls include tamperproof seals, inspection of samples on delivery, and maintaining appropriate storage conditions.

*Processing Steps:* A wide variety of methods can be employed to control hazards that may be encountered during the processing operations. The type of control mechanisms depends upon the processing method or methods employed in the plant. Temperature and pressure recorders are common in most food processing systems. With advances in electronic technology, thermometers are not often used and if they are employed, mercury thermometers should be avoided. Control charts, log sheets, and other records can be employed to monitor the temperature and pressure in a processing environment. Batch records should clearly state the type and quantities of ingredients used in production. Control of Products that require a use-by-date should commence at the source of ingredients. All products, including the ingredients used, should have a batch number or lot number to enable traceability. Finished products should be maintained at the specified temperature and products held under quarantine should be clearly labeled to prevent them from being dispatched. Operating storage tanks at positive pressure can create problems of cross-contamination between liquid and gas lines. Such cross-contamination can be avoided by using non-return valves at appropriate locations. Changes made in a process should be controlled through a change control procedure, which should include a reassessment of the hazards and the CCPs.

*Plant and Machinery:* Hazards due to plant and machinery can be controlled by the development and maintenance of equipment and accessories used to manufacture a food product. It is necessary to thoroughly clean and sterilize all equipment and utensils before and after processing. It is also important to recognize the significance of HACCP principles in planning the layout of the equipment. A hazard control program requires that every production line in the plant be correctly laid out showing the operation and interrelation of all machinery and equipment. A preventive maintenance program should be in place that indicates the frequency at which the equipment should be checked. When a change in machinery or machine settings occurs, the hazards must be reassessed. Critical measuring equipment such as

**TABLE 42.8**  
Processing Methods to Control Microorganisms in Raw Materials and Packaging

Method	Control Parameter
Heat treatment	Time, temperature, and humidity
Filtration	Pore size and filter integrity
Irradiation	Dosage and density of load
Chemical	Concentration, pH, and temperature

recognize the significance of HACCP principles in planning the layout of the equipment. A hazard control program requires that every production line in the plant be correctly laid out showing the operation and interrelation of all machinery and equipment. A preventive maintenance program should be in place that indicates the frequency at which the equipment should be checked. When a change in machinery or machine settings occurs, the hazards must be reassessed. Critical measuring equipment such as

**TABLE 42.9**  
Control of Incoming Raw Materials to Ensure Safety

1. Be highly selective of the sources/suppliers of materials and their ability to produce and deliver a safe product consistently by implementing an approved supplier policy
2. Establish specifications for raw materials taking into consideration those characteristics that are critical to quality and safety
3. Avoid using the cheapest price as the sole criterion for purchase. Relate the price to risk assessment
4. Review any new ingredients introduced into the system. Instruct the supplier to inform you of any changes in the characteristics of the raw material, since even minor changes may affect the final quality of the end-product
5. Carry out periodic audits at the supplier's premises
6. Instruct the supplier to have an HACCP and a QA program in place. Provide encouragement and support if necessary. Developing a partnership can be mutually beneficial
7. Inform the supplier to label the raw materials accurately and provide assurance in the form of compliance certificates when they are delivered
8. Carry out periodic tests on raw materials on a random basis on delivery
9. Monitor storage conditions of raw materials, both at the supplier's and the producer's premises
10. Encourage the raw material suppliers to develop safe packaging for the ingredients

thermometers, weighing scales, etc. should be calibrated by organizations authorized by the national bodies to do so, so that the measurements can be traced to a national standard. Line lubricants, grease, and chemicals used for cleaning the equipment should be recognized as safe and should be purchased from an approved supplier. The operators are the closest to the machinery and they should be adequately trained to identify potential hazards. Unusual observations should be immediately investigated.

*Storage and Distribution:* Hazards due to storage, dispatch, and distribution are associated with storage conditions, stock rotations, and physical locations. All purchased products should be handled and stored in a manner that ensures protection, preservation, and freedom from contamination, pests, etc. Specific storage conditions can be monitored by the use of temperature/time records, while the physical location can be observed for cleanliness and freedom from vermin and dirt. Scheduled cleaning and vermin control programs should be in place and monitored in the storage area. Products released for dispatch should be physically located away from the quarantine area. The use of status stickers such as HOLD, QUARANTINE, REJECT, and PASSED will prevent substandard products from being dispatched. Electronic records should clearly indicate the status of finished goods in the storage area, and provision must be made to ensure that only released products are available for distribution to customers. The design of food storage areas should take into account access to goods, personnel, and forklifts; ease of cleaning; drainage; lighting; and ventilation.

Refrigerated foods such as sous vide and other chilled foods have gained popularity worldwide. These foods are more susceptible to mishandling than frozen or shelf-stable products and therefore need to be managed carefully. Training of personnel in the safe handling of food during transport, monitoring temperature/time records in refrigerated trucks, maintaining cleanliness and hygiene, and correct delivery procedure are some of the controls that can be exercised to reduce or eliminate hazards due to transport and storage. Routine inspection and audits can be used to monitor the effectiveness of the storage, dispatch, and distribution system.

*Premises:* Control methods that can be used to prevent the occurrence of hazards and for safe operation within the premises of the food production area depend upon the proper design and layout of processing areas. Several control measures can be employed to prevent potential hazards: (i) pest control program in the plant, (ii) a scheduled maintenance program; (iii) regular inspection of vents and overhead pipes; (iv) use of guarded light fittings; (v) filtered air supply in the processing area; (vi) temperature/time records in manufacturing and storage areas; (vii) regular cleaning program for walls, floors, and ceiling; (viii) monitoring the quality of water supply and its temperature when used for sterilizing/sanitizing of equipment; and (ix) waste disposal program to prevent the entry of rodents and pests. Health and safety regulations also provide some measure of control over the hazards that originate in a food processing facility. Regular audits should be carried out to ensure that health and safety regulations are observed.

*Personnel:* An HACCP program should take into account the hazards due to poor handling of food in a production facility and at food-serving stations. In catering facilities and chilled and frozen food premises, poor physical health and lack of personal hygiene of the staff represent a major risk [25]. Food handlers can be a major source of pathogenic bacteria. Incidences have been noted where personal articles such as pens, paper, jewelry, metal items, cigarette butts, and chewing gum have been incorporated into food products. Entry of these hazards can be controlled by introducing a policy covering prohibition of smoking, chewing gum, and wearing jewelry; maintaining personal hygiene; use of clean uniforms; monitoring illnesses and regular medical care; and regular audits to monitor the effectiveness of documented procedures for handling food. All garments should be clean and free of soil. Freshly laundered garments should be provided for food handlers on a daily basis. Wherever appropriate, head covers should be worn. Besides being unpleasant, hair is also a source of microbial contamination [26]. Workers who handle food should not have cuts or infectious diseases. Such workers should be prevented from handling food. Touching the prepared food with bare hands should be avoided. Suitable hand washing and drying facilities should be provided near the workstations.

#### **42.7.7.2 Measures at Postprocessing and Packaging Stages**

Contamination of food products can also occur at postprocessing and packaging stages. Food manufacturers and retailers should be aware of the need to handle food in a safe and hygienic manner. Manufacturers and retailers have a responsibility to ensure that food products are not abused by the consumer after purchase.

*Retail:* Before food reaches the consumer, retailers are responsible for maintaining the safety of all food products in their care. The retailers must store the food at the recommended temperature and

adequate care has to be taken when the food is handled. Control measures therefore relate to monitoring the temperature/time records during storage, inspection of equipment and facilities, auditing, training of staff, and the use of tamperproof and tamper-evident packaging.

*Food Service:* Food is presented to the consumer in a variety of ways and some food-service systems are prone to microbiological and other hazards. The HACCP techniques that can be applied to food production systems are also valid in food-service systems. In food, the presence of certain microorganisms or their metabolic products in amounts large enough to cause illness when consumed is a major concern. In this respect, the population is at greater risk from food-service establishments [27]. Hazards that need to be controlled are linked with several factors, including the composition of menus and individual food items, particularly raw materials not subjected to further processing, storage, preparation, handling, and holding procedures. The control methods include: (i) selection of suppliers, (ii) inspection of raw materials on arrival, (iii) temperature/time control in storage and food-handling areas, (iv) monitoring personnel hygiene and food-handling practices, (v) sanitation of utensils and handling equipment, (vi) provision of adequate covers to protect from insects, and (vii) control the entry of insects.

#### **42.7.7.3 The Consumer**

*Food Preparation:* Outbreaks of food poisoning due to poor handling of food in the home are not uncommon. Food spoilage due to pathogenic microorganisms as well as hazards from foreign objects can occur during the preparation of food. Consumer awareness of the potential hazards of handling food in the household is important to ensure the safety of foods prepared at home. The hazards can be controlled by checking the containers prior to purchase, handling the product correctly on the way home, properly storing the ingredients and food, keeping the kitchen equipment clean, preparing the food correctly, and managing the pantry appropriately [28].

*Food Usage:* Prepared food products such as ham, cheese, and sauces may be consumed directly or incorporated into other foods. Hazards can occur due to consumer abuse. The manner of reconstitution of the food, and consumer groups such as diabetics for whom the food is made should be indicated on the label. Very few control methods are available for the consumer to turn to. Controls can be exercised through the provision of consumer information as to how the food product should be handled, used, and stored. Warning labels such as use-by dates and storage conditions, use of temperature/time indicators on sensitive and high-risk food items, and a packaging design that minimizes abuse by the consumer are some of the ways in which the food processor can help the consumer minimize hazards.

#### **42.7.8 Hazard Analysis**

Hazard analysis, the first principle of the HACCP program, is necessary to identify those hazards that must be eliminated or reduced to an acceptable level to produce safe food. A hazard analysis serves three purposes [29]: (i) to identify the hazards of significance to food safety, (ii) to select critical hazards on the basis of risk to the consumer, and (iii) to identify potential hazards that warrant specific preventive measures. When the same product is manufactured by different food processing organizations, the hazards will depend upon [18] the following: (i) sources of ingredients, (ii) product formulations, (iii) processing machinery and equipment, (iv) processing and preparation procedures, (v) duration of processes, (v) storage conditions, and (vi) experience, knowledge, and attitudes of the personnel.

All existing and new products must be subjected to hazard analysis and when raw materials, product formulations, processing or preparation procedures, packaging components, distribution, and the use of product changes, the original hazard analysis has to be reviewed. A systematic approach to hazard analysis involves the assessment of biological, chemical, and physical hazards in all facets of the food production operation, including delivery to consumers. Biological hazards occur when there is potential for harmful bacteria to contaminate the food. Chemical hazards exist when food is contaminated with substances such as pesticide residues, toxic metals, cleaning agents, and sometimes food additives and preservatives in excessive amounts. Physical hazards can exist when particles such as glass fragments, metal pieces, wood, hair, jewelry, or dirt contaminate the food. A suitable form for hazard analysis is shown in Table 42.10 [30]. The analysis should cover all the steps from receiving raw materials to delivery to consumers as given in the flow diagram (Figure 42.1).

TABLE 42.10

Hazard Analysis Form

Processing Step	Hazard Type	Significant? (Y/N)	Hazard Description	Control Method
	Biological			
	Chemical			
	Physical			

### 42.7.9 Assessing the Hazard Potential

An important step in implementing an HACCP program is the assessment of potential hazards. Hazard analysis requires knowledge of pathogenic organisms or any agent that could cause spoilage of the product and pose a risk to the consumer. A broad understanding of how these hazards could arise is also essential for a complete assessment. An assessment of potential hazards involves a detailed examination of the following: raw materials, process, product, and end use. These are assessed on the basis of biological, chemical, and physical hazards. Different systems have been used to assess the hazards associated with food products [31,32]. Suitable layouts for the assessment of the hazards are described in the sections that follow.

#### 42.7.9.1 Assessment of Raw Materials

The hazards related to raw materials can be grouped under microbial, foreign matter, and those associated with transportation and storage.

*Biological hazards:* Some food products are more prone to microbial contamination than others, e.g., food products such as fish and meat are more likely to be contaminated with microorganisms than are fruits and vegetables. Chlorinated water and food ingredients such as salt generally do not carry microorganisms. Several factors are important for the growth of microorganisms. These factors are discussed in other chapters and must be taken into consideration in assessing the risk potential. Microbial growth may also occur during uncontrolled transport and storage conditions. Products such as salt and sugar do not require special storage conditions, whereas maintaining a prescribed temperature/time is important for chilled food.

*Physical hazards:* Common types of foreign matter that are of concern in a food production environment are soil, metal objects, personal articles, etc. and the possibility of such contamination should also be assessed. Some food products may be damaged or undergo deterioration during transport. The extent of damage or deterioration that can occur under uncontrolled conditions of transport should also be considered when the raw materials are assessed.

*Chemical hazards:* The raw materials may also be contaminated with chemicals and other pesticide residues. The possibility of such contamination should be considered during the assessment.

*Assessing the risk:* Risk can be high or low, e.g., cooked food such as fish, meat, and eggs have a low risk in contrast to uncooked food. Even if the hazard is eliminated at a later stage of the process, any risk associated with raw materials should not be ignored.

#### 42.7.9.2 Assessment of the Process

The assessment of the process involves analysis of each step. At each step of the process, consideration has to be given to the possibility of contamination with biological, physical, or chemical hazards.

*Biological hazards:* Microbial destruction is a critical factor in food processing, and if adequate controls are not in place, microbial contamination is a distinct possibility. During the handling of food items, microbial contamination can occur. However, microbial growth will take place only if the material is a suitable substrate and stored at a condition appropriate for growth.

*Physical hazards:* Processes such as sieving, washing, inspection, and metal detection are designed to remove or reduce foreign matter present in a food product. The assessment is based on the efficacy of the process. New foreign matter can be introduced during certain steps in the process. For example, plastic pieces can become embedded in the food product during a packaging operation, and metal pieces or shavings can get into the product via faulty machinery.

*Chemical hazards:* Any equipment that comes into direct contact with food items can contaminate the food if it has not been thoroughly cleaned. However, carton closure equipment that does not come into contact with food directly cannot be considered a possible hazard source.

*Control measures:* If the hazard is not eliminated downstream, adequate control measures should be exercised at the step under consideration. If vegetables are washed for the purpose of removing foreign matter and intended to be consumed uncooked, the washing step is critical and needs a high degree of control because of possible microbial contamination. However, if the vegetables are intended to be cooked, the washing step is for the purpose of removing soil and dirt and therefore needs a low degree of control. Displaying raw chilled seafood, poultry, and meat needs a high degree of control because it is important to keep the display temperature below 4°C to limit bacterial growth [33]. The consequences of failing to do so can be serious. Process steps such as filling trays and handling of food require a moderate degree of control.

#### **42.7.9.3 Assessment of the Product during Storage and Delivery**

The methods by which food should be stored and delivered depend on the characteristic of the food product. The product is evaluated on the basis of hazards associated with its stability. Consideration has to be given to storage conditions, packaging requirements, and delivery instructions necessary to prevent the product from undergoing deterioration or spoilage.

*Biological Hazards:* Products such as bottled wine, canned foods, and jam do not require special storage conditions, and hence there are no hazards associated with storage. For perishable foods such as meat, fish, and ice cream, the storage conditions are critical to prevent the growth of microorganisms. Vegetables require special storage conditions, but if abused, the hazards that can occur are less critical. Chilled and frozen foods may be subjected to unfavorable storage conditions (temperature/time) over long periods during transport. These food products require special packaging and the hazards associated with such products are critical.

*Physical Hazards:* Food transported over long distances is subjected to a wide variety of storage conditions and handling techniques. The hazards that can occur during the transport of food substances are assessed as to the extent of damage or deterioration. Few or no hazards are associated with food products that do not require special storage conditions or handling techniques. Some food products packed in glass or plastic containers require special storage conditions during transport to prevent damage and subsequent spoilage.

*Chemical hazards:* During storage and delivery, chemical hazards in a food product are often caused by unclean containers. Food ingredients are also transported to food producers, and in some instances contaminated substances may be transported in the same vehicle [34].

*Control measures:* Controls are not necessary for food products such as canned foods, sugar, and salt. When chilled and frozen food products are transported, stringent control measures should be exercised. Some products that are transported over short distances in insulated packaging may not require special storage conditions, and failure to maintain control over temperature/time may not have serious consequences.

#### **42.7.9.4 Assessment of End Use**

During the last few years, food manufacturers have been aware of the increase in the cases of consumer dissatisfaction and complaints about food products [28]. Mishandling of products, which leads to deterioration of quality, has been cited as one of the causes of consumer dissatisfaction. Hazards can sometimes occur in the hands of the consumer as a result of inappropriate usage and abuse by the consumer.

*Inappropriate usage:* Food products that can be safely consumed by the general population cause no risk. Some food products that can be safely consumed by a section of the population may not be tolerated by others, although the effects of such a hazard may not be significant. The hazards associated with the usage of such foods are classified as low. The hazards that can occur, e.g., as a result of incorrect labeling or wrong formulation of food products made especially for certain groups of people—such as the elderly, children with allergies, and diabetic patients—are critical.

*Abuse by the consumer:* Food products that do not require special storage conditions or handling cause no hazards in the hands of the consumer. However, some food products have a low risk of being abused and require moderate care in handling, e.g., bread left outside and open to air soon develops mold. Some foods such as cooked meat require special handling by the consumer to prevent spoilage that may not be



obvious, and the consumption of such food may cause serious illness (e.g., *Salmonella* poisoning). These food products have a high risk of abuse.

*Control measures:* Controls are not necessary for food products that cannot be abused. Foods that have a low risk of abuse require moderate degree of control, while food products that require special handling need strict control measures.

#### **42.7.10 Critical Control Points**

The determination of the CCPs is the second principle of HACCP. This is the next step after hazard analysis, which identifies the potential hazards that can threaten food supply and production. A CCP in a food processing system leads to an unacceptable health risk and can be effectively controlled to prevent or eliminate health hazards to an acceptable level of low risk.

##### **42.7.10.1 Classification**

Critical control points can be generally classified as CCP1 and CCP2 [35]. CCP1 is defined as a step or location in a food processing system that on its own effectively eliminates a hazard, e.g., metal detection in food products and sterilization. CCP2 is defined as a step or location in a food processing system that contributes to the control of a hazard but does not guarantee elimination, e.g., inspection and pasteurization.

It is important to distinguish between the CCPs and control points that are less critical in ensuring food safety. Several key points to note in determining the CCPs [15] are: (i) CCPs should not be restricted to a minimum or maximum number, (ii) each CCP is specific to a product and process, (iii) CCPs should not be duplicated, (iv) CCPs should only be introduced when it is necessary to eliminate or reduce a health hazard, (v) CCPs should always be developed by consulting an expert when there is doubt about a product or process, and (vi) development of CCPs requires the use of common sense.

The presence of a control downstream should not be considered a reason to neglect controls in preceding steps. For example, wines are tested for pesticide residues prior to bottling and even then the grape grower has the responsibility to control the spray program. Any opportunity to eliminate or minimize the occurrence of a hazard should not be overlooked.

##### **42.7.10.2 Location of the CCPs**

HACCP techniques enable the food processor to identify hazards and risks, focus on where they pose a threat to the safety of food, and develop the means to control them. The actual location of a CCP depends upon the type of hazard, ingredients, packaging, processing procedures, storage, and handling. Emphasis should be placed on prevention of entry rather than detection after they have been introduced. The CCPs should be introduced as early as possible in the food processing system and close to the origin of the hazard. All precautions must be taken to prevent the entry of new ones [35]. Hazards associated with raw materials should be controlled at the source, i.e., the supplier. This minimizes the risk of entry of hazards and avoids unnecessary inspection of raw ingredients on receipt. Therefore, preprocessing techniques such as washing and sorting will be more effective in controlling hazards.

Food production processes are often associated with more than one CCP. For example, in the production of entrees in conventional, cook/chill, and cook/freeze food-service systems, time-temperature is a CCP throughout production in each of the models. Equipment and personal sanitation are also the CCPs that should be regularly monitored using standards and criteria established by the food processing system [36]. The inspection of the finished product usually verifies the effectiveness of controls placed so far.

##### **42.7.10.3 Determination of the CCPs**

True CCPs have often been confused with control points, and as a result a large number of the CCPs are identified, making the HACCP system unworkable. For example, in a commercial process of smoked fish it is possible to identify many individual steps, but only three can be considered critical: salt penetration, smoking, and storage [21]. There are two approaches for identifying the CCPs: decision tree developed by the Codex Alimentarius Committee of Food Hygiene [37,38] and risk analysis.

**TABLE 42.11**

CCP Decision Tree

Question Number	Question	Response “Yes”	Response “No”
1	Do control measures exist at this or subsequent steps for the identified hazard?	Proceed to Q2	If the control is necessary, modify the process
2	Is this step specifically designed to eliminate or reduce the likely occurrence of the identified hazard to an acceptable level?	CCP	Proceed to Q3
3	Could contamination with the identified hazard occur in excess of acceptable levels or increase to an unacceptable level?	Proceed to Q4	Not a CCP
4	Will a subsequent step eliminate the identified hazard or reduce likely occurrences to an acceptable level?	Not a CCP	CCP

### 42.7.11 Identification of the CCPs

#### 42.7.11.1 Decision Tree

The decision tree [30] employs a systematic approach and a logical method at every process step for each hazard identified as significant in the food production operation. It promotes further discussion by the HACCP team and hence improves the quality of the outcome. The principal elements of the decision tree are shown in Table 42.11 as a series of questions.

Q1. Do control measures exist at this or subsequent steps for the identified hazard?

This question refers to the use of control measures such as temperature control, visual inspection, or use of metal detectors at this step or subsequent steps in the food processing operation to control the hazard. If there are no control measures, the team should indicate how the hazard would be controlled before or after the manufacturing process (outside the control of the organization). For example, pesticide residue in grapes is controlled by the grape grower. Alternatively, the operation, process, or product could be modified to ensure that a control measure exists.

Q2. Is this step specifically designed to eliminate or reduce the likely occurrence of the identified hazard to an acceptable level?

For each operation, the team should define the acceptable levels. Examples of controls that are designed to eliminate or reduce the likely occurrence of a hazard include chlorination of water, pasteurization, use of metal detectors, cleaning procedures, etc. This question applies to process operations and is not applicable to incoming raw materials.

Q3. Could contamination with the identified hazard occur in excess of acceptable levels or increase to an unacceptable level?

This question refers to the likelihood of the hazard having an impact on the safety of the product. The response to this question should be based on the risks, the company’s complaint reports, and scientific literature on the subject. If the contamination is not likely to represent a threat to human life, the response to this question is “no.”

Q4. Will a subsequent step eliminate the identified hazard or reduce likely occurrences to an acceptable level?

This question is designed to identify those hazards that are known to represent a threat to human health or that could increase to an unacceptable level, and which would be controlled by a downstream

operation. If the response to this question is a “yes,” it is necessary to identify the subsequent step that controls the hazard, thus proceeding to the next identified hazard. The questions given in the decision tree should be asked for each significant hazard at each process operation, including receipt and handling of raw materials. All the CCPs identified by the team must be implemented and cannot be replaced by other controls elsewhere in the operation.

#### 42.7.11.2 Risk Analysis

Food safety is a significant public health issue worldwide with major costs to the health authorities. Uncontrolled application of agricultural chemicals, environmental pollution, use of nonpermissible additives, and other abuses of food along the food chain can potentially introduce or fail to reduce hazards related to food production, delivery, and service. Therefore, food safety programs designed to protect consumers have to meet several challenges: (i) the emergence of new pathogens and other hazards, (ii) the reemergence of pathogens and other hazards, and (iii) the threat of bioterrorism. With the increased awareness of food additives and food safety among consumers, analysis of risks associated with food becomes extremely important. The level of risk to the consumer depends on the degree of control exercised by growers, suppliers, processors, and regulatory authorities to eliminate or minimize the risks to acceptable safe levels. Risk analysis is an evolving discipline, and the methods used for the assessment and management of risks are still being developed [39].

It is important to understand the difference between hazard and risk. Hazard is a biological, chemical, or physical agent in food that may have an adverse health effect. In contrast, risk is a function of the probability of an adverse effect and its severity of impact on the affected population [40]. Risk analysis process involves three distinct steps: risk assessment, risk management, and risk communication. The purpose of risk assessment is to identify the hazards and their immediate, interim, and long-term effects on human health. Risk management establishes appropriate controls to eliminate or reduce these risks. The aim of risk communication is to develop methods to communicate this information to consumers.

*Risk assessment:* Risk assessment consists of four components:

1. Hazard identification
2. Hazard characterization—quantitative and qualitative evaluation of the adverse effects of the hazard on humans
3. Exposure assessment—quantitative or qualitative evaluation of the likely degree of exposure to the hazard
4. Risk characterization—integration of the first three components to arrive at an estimate of the likely adverse effects in the target population

Once the hazards have been identified, they should be assessed on the basis of established data. Each hazard can be assigned a numerical risk level based on the severity of outcome and the likelihood of occurrence [41]. Severity is classified into three levels:

High severity (score = 3)—Microbial contamination causing life-threatening illness (e.g., *Clostridium botulinum*, *Salmonella typhi*, *Vibrio cholerae*) or contamination with chemical or foreign object causing life-threatening or permanent illness or injury.

Medium severity (score = 2)—Microbial contamination causing chronic illness (e.g., *Campylobacter*, *Vibrio parahaemolyticus*) or contamination with chemical or foreign body causing temporary illness or injury.

Low severity (score = 1)—Microbiological contamination causing moderate illness (e.g., *Listeria monocytogenes*, *Staphylococcus aureus*) or contamination by chemical or a foreign body causing discomfort, nausea, etc. [23].

The likelihood can also be categorized as high (score = 3), medium (score = 2), and low (score = 1). High likelihood indicates that the hazard will occur, medium likelihood indicates a reasonable chance of occurrence, and low likelihood denotes that the occurrence will be rare.

Risk level = Likelihood × Severity

Risk level = 1–3: low risk—establish control measures where appropriate.

Risk level = 4–6: medium risk—establish control measures.

Risk level = 7–9: high risk—a CCP.

For example, in the canning process, the likelihood of *C. botulinum* surviving retorting is very low (1) but the severity of the illness (botulism) is high (3). Thus the risk level is 3, and the retorting is a control point and not a CCP.

A better approach for risk assessment takes into consideration the severity of the illness as well as customer complaint reports and product recalls [42]. In this case, the ratings for severity are as follows: (i) fatal, (ii) serious illness, (iii) product recall, (iv) customer complaint, and (v) not significant. Likelihood ratings for each food hazard are: (A) common (repeating) occurrence, (B) known to occur or “it has happened” (own information), (C) could occur or “I have heard it happening” (published data), (D) not expected to occur, (E) practically impossible. Based on the above ratings, significance factors are assigned to various combinations as shown in the matrix in Table 42.12.

Example of an assessment of significance:

*Process step*—Receiving salmon for the production of vacuum-packed hot-smoked salmon.

*Potential hazard*—Pathogens, parasites in fish.

*Severity*—2 (serious illness).

*Frequency*—D (not expected to occur in finished product because of subsequent steps).

*Significance*—12 (not a CCP).

*Control measures*—Received frozen, supplier HACCP compliant with specifications, control smoking/cooking at subsequent step.

*Risk management:* Risk management is the process of implementing policy alternatives compatible with the results of risk assessment and applying appropriate control options, including regulatory measures. The aims of the risk management program are to (i) establish the significance of the estimated risk, (ii) compare the costs of reducing this risk to the benefits gained, (iii) compare the estimated risk to benefits to the consumer, and (iv) promote regulatory and other changes necessary to reduce the risk.

The outcome of the risk management program is the development of standards, codes of practice, and other guidelines for food safety. Risk management decisions are based on the outcome of the risk assessment process, food processing, quality and food safety requirements, food handling and distribution requirements, and food quality and safety standards to control hazards in food production. These decisions are implemented, and their effectiveness on control measures is monitored to ensure that the food safety objectives are met.

*Risk communication:* Risk communication is the final element of the risk analysis process. According to the Codex Alimentarius’ definition, risk communication is an interactive process of exchange of information and opinion on risk among risk assessors, risk managers, and other interested parties. The responsibility for food safety rests with each one involved at all stages of the food chain, including consumers. They should be provided with appropriate information on potential hazards and precautions to be taken

to eliminate or reduce the risks. Consumers also need to be aware of the control measures exercised by regulatory bodies to ensure food safety.

The purpose of risk communication is to educate the general public and specific target groups such as elderly, diabetics, etc. on food hazards and their risks to the general health and well-being. Communication provides the information necessary to prevent, minimize, or reduce risks associated with food intake to acceptable safe levels through voluntary or regulatory control mechanisms. This information also allows the consumers to exercise their own control measures to safeguard their health.

**TABLE 42.12**

Matrix for the Assessment of Significance of Risk

Likelihood →		A	B	C	D	E
Severity	1	1	2	4	5	11
↓	2	3	5	8	12	16
	3	6	9	13	17	16
	4	10	14	18	21	23
	5	15	19	22	24	25

Note: Shaded areas = CCPs.

### 42.7.12 Establishing Critical Limits for Each CCP

Establishing measurable limits (specifications) for each CCP is the third principle of HACCP. Critical limits define the criteria for acceptability or rejection and are thus the operational boundaries for each CCP. These limits may be derived through various means: experiments through validation, regulatory requirements, codes of practice, or other valid sources. Critical limits should be established for the following food production operations as applicable: (i) distribution processes, (ii) receiving operations, (iii) storage, (iv) thawing, (v) production, (vi) hot holding, (vii) cooling, (viii) processing, (ix) reheating, (x) cold holding, (xi) transportation, (xii) recipe flow charting, and (xiii) employee training.

The measurable limits are often defined by time, temperature, physical attributes, acidity, pH, moisture content, water activity, salt concentration, and chlorine levels. Purchasing management procedures should include clearly defined specifications, and the control limits may refer to a successful outcome of an audit at the supplier's premises. The person who receives goods must ensure that the food is received in good condition, free from spoilage and tampering, and meets the organization's in-house specifications. It is essential that the temperature of perishable products and the cleanliness of the vehicle/container are checked on receipt. Training requirements have to be established for all employees who handle food. These may include proper hand washing techniques, use of clean uniforms and hair covers, communicating the company's policies on smoking at the workplace, wearing jewelry, etc. Cross-contamination is an important hazard that is sometimes overlooked. Raw and cooked products should be physically segregated in storage. Critical limits for cross-contamination may include storage conditions and proper use of cutting boards. Table 42.13 shows some examples of critical limits [18].

### 42.7.13 Establishing Procedures and Equipment for Monitoring the CCPs

Monitoring is defined as planned measurement or observation to ensure that the CCP is under control. It is the fourth principle of HACCP. Monitoring procedures should be carefully defined such that loss of control can be detected. It is essential that responsibility is assigned for observation or testing. The test results have to be accurately recorded for future reference. The purpose of monitoring includes the following: (i) evaluate the effectiveness of the system's operation at the CCP, (ii) determine instances of deviation from a critical limit, and (iii) provide evidence that the performance level of the operation at the CCP complies with the HACCP plan.

Monitoring can be performed at defined time intervals or continuously. The latter is more reliable and shows deviations from the specified limits, allowing timely corrective action to be taken. When monitoring is done at time intervals, the frequency of monitoring should provide confidence that the CCP is under control. When monitoring systems are designed, it is necessary to consider the time lapse between the measurement and results. Online measurements are rapid and provide results immediately. However, microbiological tests provide results after a few days and, therefore, finished products have to be held under quarantine until the test results are known. All monitoring equipment should be subjected to regular calibrations. There are two types of monitoring: measurement monitoring and observation monitoring [43].

**TABLE 42.13**

Some Examples of Critical Limits

Hazard	CCP	Control Limit
Bacterial pathogens (nonsporulating)	Pasteurization	72°C for at least 15 s
Metal fragments	Metal detection	Metal fragments larger than 0.5 mm
Bacterial pathogens	Drying over Acidification step	$a_w$ less than 0.85 for controlling growth in dried food products Maximum pH of 4.6 to control <i>Clostridium botulinum</i>
Excessive nitrite	Curing/brining	Maximum 200 ppm sodium nitrite in finished product
Food allergens	Labeling	Legible label containing a list of correct ingredients
Histamine	Receiving fish	Maximum 25 ppm histamine levels in evaluation of tuna for histamine

Observation monitoring usually involves the use of checklists and includes visual checks (sight, smell, and taste), visual observations for some physical characteristic (presence of foreign objects), and checks for hygiene and cleanliness. Observation monitoring is generally easy to implement, but there are some disadvantages. Results of observation monitoring often require interpretation, and the operators must be sufficiently trained to make a sound judgment.

Measurement monitoring often involves instrumentation and can be automated. The results are straightforward and do not require subjective judgment. Measurement techniques can be designed such that the findings can be easily interpreted. The results will also demonstrate trends and highlight subtle changes.

#### **42.7.14 Establishing Corrective Actions**

Establishing corrective action procedure is the fifth principle of the HACCP plan. Corrective action is necessary when deviation at a CCP has exceeded the critical limits. Deviation is critical when it results in an unacceptable consumer health risk, which must be resolved promptly. Deviation procedures are a predetermined and documented set of actions to be accomplished when a deviation occurs. Corrective actions enable the cause of the noncompliance to be corrected and the noncompliant product to be managed. Product control includes proper identification, segregation, and disposition of the affected product.

After appropriate corrective action is taken, it may be necessary to review the HACCP plan. The corrective action procedures should include an investigation to determine the cause of the problem, effective procedures to prevent a recurrence, and verification of the effectiveness of the corrective action.

#### **42.7.15 Verification Procedures**

The sixth principle of HACCP is the verification of operational procedures. It involves the application of methods, procedures, tests, and other evaluations—in addition to monitoring—to determine compliance with the HACCP plan [18]. The purpose of verification procedures is to assess the effectiveness of the plan and ensure that the HACCP system is compatible with the plan. Although it is carried out at planned intervals on completion of the study, verification may also have to be performed when there is a change in the ingredients, product or process, or when a deviation occurs, or a new hazard is identified. Some of the verification activities are (i) audits covering all operations of food production; (ii) reviews of menu and recipes and confirmation that documented methods are followed; (iii) maintenance and calibration checks; (iv) verification of flow charts; (v) cross-contamination possibilities; (vi) all records, including relevant training records; (vii) corrective action reports; and (viii) compliance to regulatory requirements.

#### **42.7.16 Documentation and Record Keeping**

Record keeping is the last principle of the HACCP plan and is an essential requirement of the HCCP program. Records demonstrate the history of the process, its measurements, deviations at the CCP, and corrective actions taken. Record keeping is also an essential regulatory requirement. Regulations governing food production dictate the type of records to be maintained by the person operating the food processor. For example, according to FDA's HACCP regulations, seafood operations are expected to document and follow basic sanitation standards [30]. An HACCP manual includes, but not limited to, the following documents [44]: (i) profile of the organization; (ii) policies, e.g., hygiene, cleanliness, smoking, etc.; (iii) products manufactured by the organization; (iv) prerequisite program referenced; (v) flow diagrams; (vi) hazard analysis; (vii) control schedule; (viii) consumer complaint procedure; (ix) recall procedure; (x) corrective action and disposal of nonconforming goods procedure; and (xi) record and document control procedure.

Records and documents may be in any form, e.g., charts, written procedures, and electronic records. The records have to be regularly reviewed to ensure that HACCP controls are effective, correct data are being recorded at the specified intervals, and that operators are completing their tasks as instructed. Most of the records associated with the HACCP program are associated with monitoring and corrective actions. They can be simple check sheets or complex control charts. The type of records to be maintained depends on the nature of the food processing operations. Monitoring the temperature is essential for

processes that employ refrigerators, freezers, dishwashers, steam equipment, hot and cold cabinets, and ovens. Some examples of the records to be maintained are (i) pest control records, (ii) calibration records, (iii) maintenance logs, (iv) shipping records, (v) premises inspection reports, (vi) release reports, (vii) training records, (viii) calibration reports, (ix) consumer complaint and corrective action reports, and (x) control charts as applicable. Records keeping should not be treated as mere paper work. It is the key system to manage, verify, and validate the HACCP program [45].

#### **42.7.17 Validation Procedures**

While verification can be performed by audits and other methods at scheduled intervals or as required, the effectiveness of operational processes and methods can be determined only by a proper validation. Validation is the process of ensuring that the procedures are effective [46]. A process can be verified as correct but may not be valid to achieve the desired result. For example, the process of cooling a stockpot of soup in a refrigerator may comply with documented procedures (verification), but the long time required for the temperature to drop in the center of a large container can permit bacteria to continue to grow (validation). Hence, the validity of the cooling process (refrigerator in contrast to blast chiller) is in doubt. Often, equipment or procedures are unique to the organization, and therefore the operating characteristics of the process will become important in the validation of a critical limit. Food science is an evolving discipline, and it is essential that up-to-date scientific references are used in the validation process. Validation is an ongoing planned procedure, but the following factors may cause a review of the validation procedure: (i) when raw materials, product or processes change; (ii) results of adverse audit reports; (iii) frequent deviation from the specified critical limits; (iv) new scientific data on potential hazards or processes; (v) consumer complaints; and (vi) product recalls.

---

### **42.8 Consumer Protection**

The primary objective of an HACCP system is to protect the consumer from the harm caused by hazards associated with food products. A survey carried out by a task force has revealed four causes of consumer dissatisfaction with food products [28]: unfamiliarity and expectations, price, defects, and mishandling by the consumer.

Food producers have a responsibility to ensure that all food products are adequately labeled. Information such as product description (particularly for new products), ingredients, shelf life, storage conditions, and special preparations, if any, should be provided to create awareness of the nature of the product and prevent mishandling. Retailers as well as manufacturers can go a step further by providing information in the form of leaflets that explain handling of food products on the way home, storing of ingredients and prepared foods, and the potential hazards involved with handling foods in the household. Food producers as well as retailers have an important role to play in educating the consumer as to food safety.

---

### **42.9 Management of the HACCP Program**

#### **42.9.1 Review, Audit, and Recall Processes**

##### **42.9.1.1 Review**

The HACCP program, just like the quality management system, is dynamic. With advances in food technology, food producers are constantly looking at new, rapid, and safe ways of processing food. The HACCP program should be flexible enough to adapt itself to changing circumstances. New knowledge gained about microorganisms also poses a challenge to already developed and implemented HACCP programs. An HACCP program should also take into account the variability and adaptability of the agents responsible for hazards to human health.

It is easy for organizations that have a quality management system in place to incorporate an HACCP program into the existing system. Procedures such as management responsibility, management review, and document approval and issue can be applied to the HACCP system. The function of the management

representative then is to maintain the system through regular audits and reviews. The management representative responsible for the program should ensure that all new and current product specifications, results of audits, customer feedback, process conformance and product conformity, the status of preventive and corrective actions, actions taken since the last meeting, standards of practice, changes to procedures and equipment, engineering and microbiological data, safety controls, and monitoring systems are reviewed regularly by the HACCP team. It is the responsibility of the team to determine, in relation to current practices or new procedures, (a) the potential hazards in ingredients, products, and risks, (b) whether the hazard can be eliminated or minimized, (c) the effectiveness of a terminal heat treatment, (d) the possibility of recontamination, and (e) the hazards associated with handling, storage, distribution, and product usage.

A hazard identification form (Figure 42.3) can be used to report the results found by the team. All accidents, misuse of ingredients, unsafe environment, and safety issues must be recorded and reported to the appropriate authorities. Authority must also be given to the operators to stop the process if in their opinion it is unsafe to operate. All safety issues must be dealt with immediately and timely action taken to eliminate unsafe practices and equipment.

**42.9.1.2 Audit**

An HACCP audit can be defined as a systematic and independent examination to determine whether (a) HACCP activities and related results comply with the planned arrangements, (b) these arrangements

**HAZARD IDENTIFICATION FORM**

**A. HAZARD**

Identified hazard (include details such as product name, code, pack size etc.)  
 .....  
 .....  
 .....  
 Identified by.....Date.....Time.....  
 Location.....

Potential effect on health/safety.....  
 .....  
 .....  
 Severity score.....Likelihood score.....Risk factor.....

**B. ANALYSIS**

Contributing factors.....  
 .....  
 .....

**C. SOLUTION**

Recommended method for reduction/elimination of hazard.....  
 .....  
 .....

**D. IMPLEMENTATION**

Responsibility.....By when.....

**E. MONITORING**

Results of audit.....  
 .....  
 .....

**FIGURE 42.3** Hazard identification form.



are implemented effectively, and (c) the arrangements are suitable to achieve the objectives. A schedule of audits must be prepared and carried out as planned. There is no international standard yet for the HACCP system equivalent to the ISO 9000 standard series. However, the HACCP system can be audited against the specified requirements of the system. To some extent, the BRC standard for food meets the requirements of a food safety standard [11]. It integrates the relevant section of the ISO 9000 standard, Codex Alimentarius, and GMP. The BRC standard has the following sections (i) HACCP system, (ii) quality management system, (iii) general documentation requirements, (iv) factory environment standards, (v) product control, (vi) process control, and (vii) personnel.

HACCP audits should provide (a) an assessment of the adequacy of the existing system, (b) a benchmark against which improvements can be made and evaluated, (c) evidence that contractual and legal requirements have been met, and (d) feedback on safety issues. HACCP audits are carried out in a manner similar to quality system audits and typically apply to, but not limited to, records and activities associated with control points and CCPs, training, and reviews. All noncompliances must be dealt with at the earliest opportunity, and products related to these noncompliances should be kept under quarantine for thorough investigation.

### **42.9.1.3 The Product Recall Process**

A reliable and well-tested method of recall should be in place to deal with a food item that has been established to be contaminated with a harmful ingredient or pathogenic organisms. Government regulations place a legal responsibility on food producers who recall food products for safety-related reasons to notify the authorities in writing within a specific period of initiating a recall (Figure 42.4). The traceability information will enable the affected product in the warehouse, retail outlets, and the hands of the consumer to be isolated. A suggested plan for a product recall is shown in Figure 42.5.

The text for the advertisement placed in the daily print media should comply with the statutory requirements and includes (i) names of the product and producer; (ii) pack size and a description of the packaging; (iii) any other details necessary for identification; (iv) reason for recall; (v) the necessity to identify and quarantine the stock; (vi) the manner of disposal; (vii) if the hazard to the consumer is serious, indications of clinical symptoms and advice to consult a medical practitioner; and (viii) a toll-free telephone number to provide assistance to consumers. When the recall has been terminated, the recall team should review the effectiveness of the recall procedure and recommend changes, if necessary. The recall team should document the following information: (i) name of the product and pack size, (ii) reason for recall, (iii) cause of the problem, (iv) chronological history of the recall events with actions taken, (v) effectiveness of the recall, (vi) total cost of the recall, and (vii) corrective actions taken.

In case of a recall, the accuracy of information and speed with which action is taken is important. Although a mock recall may be impracticable, regular traceability audit of a product should be carried out. This may include an audit of the ingredients used, process employed, laboratory findings, and the product distribution details. A sample recall notice is shown in Figure 42.6.

---

## **42.10 Benefits of Implementing an HACCP System**

The HACCP system is a preventive and cost-effective approach to food safety and is more effective in preventing foodborne illnesses than traditional approaches. Application of an effective HACCP system has clear benefits for consumers, industry as well as regulatory bodies [47]. These benefits are summarized in Table 42.14.

---

## **42.11 HACCP in the Overall Quality System**

The survival of a business depends on its ability to satisfy the customer's needs and expectations at an affordable cost, which is achieved through an effective quality management system. It provides a basis for continuous improvement. The effectiveness of a quality management system can be assessed against

**OUR FACTORY LIMITED**

**PRODUCT RECALL FORM**

**REFERENCE:** **NAME OF OUTLET:**  
**CONTACT PERSON:** **DATE:**  
**TELEPHONE:** **FAX:**

**1. PLEASE REMOVE THE FOLLOWING PRODUCTS FROM SALE TO CUSTOMERS IMMEDIATELY**

PRODUCT	CODE	SIZE
.....		
.....		
.....		
.....		

**2. REASON FOR RECALL**

.....  
 .....  
 .....

**3. PLEASE RETURN YOUR STOCK TO:**

.....

**NOTES:**

1. Please return the form to.....
2. If you are not holding stock send a NIL return
3. All stock will be replaced at Our Factory expense

I have returned today.....(units)  
 To.....

.....  
 Manager Date:

Our phone: Our fax:

**FIGURE 42.4** Product recall form.

standards such as ISO 9000. The quality management system should be designed to meet the individual needs of the organization. Food manufacturers, while being aware of the quality of foods, should also realize that food safety is an absolute requirement. Regulatory authorities all over the world enforce laws aimed at protecting the consumer from harmful food. HACCP is a management tool that focuses attention on food safety and complements the quality management system. Implementation of both a quality management system and an HACCP program requires teamwork.

The requirements of an HACCP program are embodied in the seven principles defined by the National Advisory Committee on Microbiological Criteria for Food [48]. The procedures relating to the HACCP system can be developed using the seven principles as the basis. An ISO 9000-based quality management system can easily be integrated with the HACCP program [44]. The clauses in the ISO 9000 standard such as responsibility, management review, and audit can be applied while keeping the focus on safety as well as quality. An HACCP system can be incorporated into the quality management system by making references to individual clauses such as product realization, corrective and preventive actions, internal audits, document control, and others common to both systems. The HACCP system must not be limited to the seven principles and should also include procedures relating to HACCP planning, customer complaints, and control of HACCP records, some of which are prerequisites.

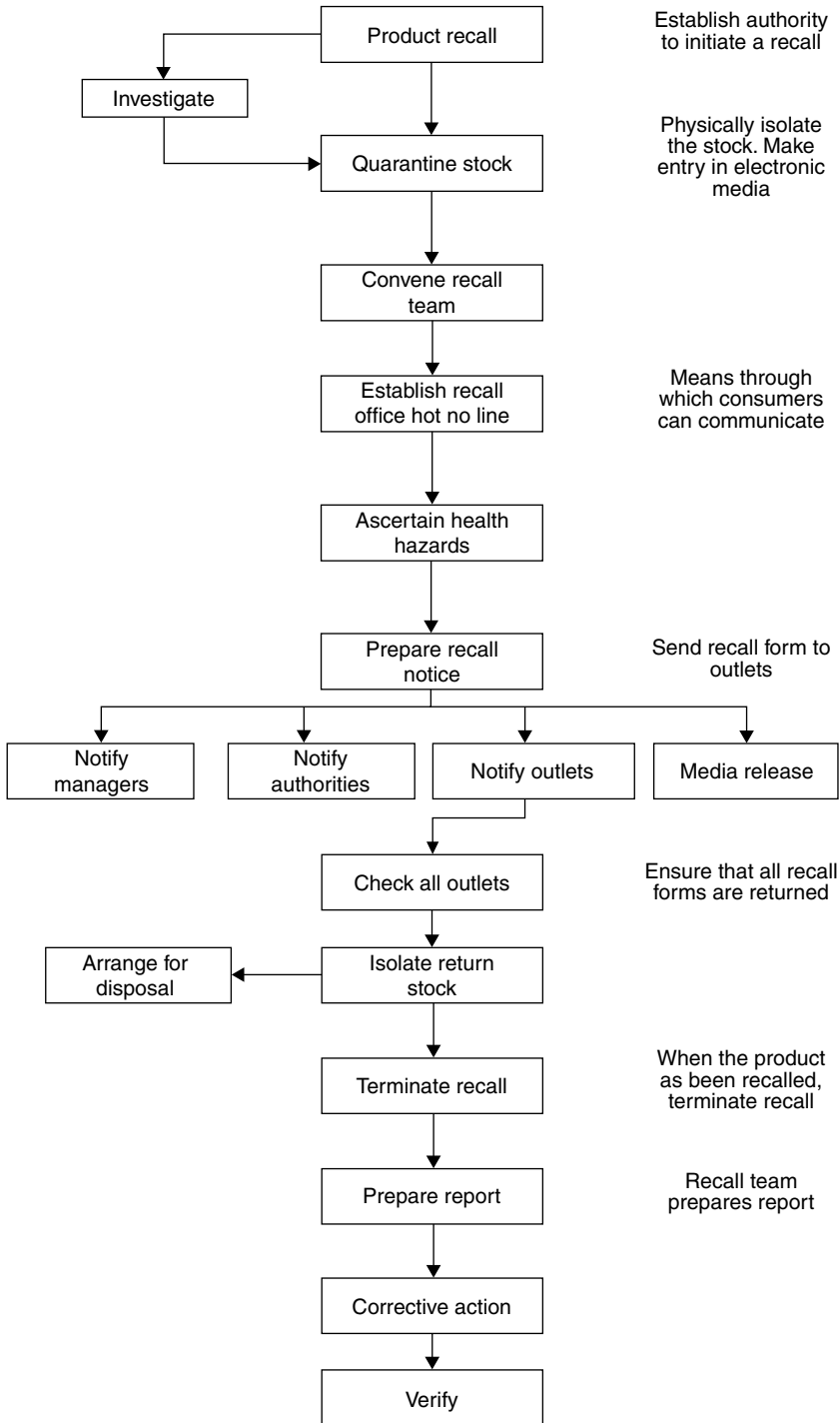


FIGURE 42.5 Recall plan.

**FOOD RECALL NOTICE**

**FOOD PRODUCTS LIMITED STRAWBERRY JAM**

**FOOD PRODUCTS LIMITED IS RECALLING 375G JARS OF STRAWBERRY JAM, BECAUSE OF THE DISCOVERY OF GLASS IN TWO JARS OF FOOD PRODUCT'S STRAWBERRY JAM. THE RECALL APPLIES TO THE PRODUCT HAVING THE CODE L23A6.**

**THE PRODUCT HAVING THE ABOVE CODE SHOULD NOT BE CONSUMED.**

**AS A SAFETY MEASURE WE ARE RECALLING ALL SUPPLIES OF THIS PRODUCT WITH THE ABOVE IDENTIFICATION ON THE LABEL.**

**THERE HAVE BEEN NO REPORTS OF INJURY OR ILLNESS. HOWEVER, ANY PERSON CONCERNED ABOUT THEIR HEALTH AS A RESULT OF CONSUMING THE PRODUCT SHOULD SEEK MEDICAL ADVICE.**

**PLEASE RETURN THE PRODUCT TO THE POINT OF PURCHASE FOR A REFUND OR PHONE TOLL FREE.....**

**THE RECALL DOES NOT APPLY TO ANY OTHER FOOD PRODUCTS LIMITED STRAWBERRY JAM HAVING A DIFFERENT CODE OR ANY OTHER FOOD PRODUCTS LIMITED PRODUCT.**

**WE SINCERELY APOLOGISE FOR ANY INCONVENIENCE CAUSED BY THIS RECALL.**

**FOOD PRODUCTS LIMITED  
(ADDRESS)  
FAX**

**FIGURE 42.6** Recall notice.

**TABLE 42.14**

**Benefits of Implementing the HACCP System**

**Benefits for Consumers**

- Lower risk of foodborne illnesses
- Greater awareness of food safety
- Greater confidence in food supply
- Better quality of life through health and socioeconomic benefits

**Benefits for Industry**

- Greater consumer confidence on product
- Minimizes legal and insurance costs
- Increases market access
- Lower wastage, fewer or no recalls, minimum or no reprocessing, and corrective action
- A consistent product
- Enhanced staff commitment to food safety
- Lower business risk

**Benefits for Regulatory Bodies**

- Improved health among the community
- More efficient food control
- Lower public health costs
- Trade promotion
- Greater confidence of the community in the food supply

**42.12 Case Study I: Production of Chicken and Vegetable Salad**

**42.12.1 Product Description**

Chicken and vegetable salad is a ready-to-eat chilled product prepared with cooked chicken, freshly sliced celery, and cooked, peeled, and diced potato in a dressing mixture. Chicken breasts (skinless, boneless) and other ingredients are bought at the market. The dressing mixture consists of a pasteurized mayonnaise base blended with spices. The product is put into plastic trays, which are covered with a peelable foil membrane, and packed in a cardboard outer package. The product is refrigerated and brought to the refrigerated case as required.

**42.12.2 Assessing the Hazard Potential of Chicken and Vegetable Salad**

A flow diagram for the production of chicken and vegetable salad has already been described (Figure 42.1). The next step in the HACCP technique is to assess the hazards associated with the raw materials, processing

steps, product, and end usage. It will then be possible to determine the raw materials and the processes that are critical. The whole process is then examined to establish the CCPs using the decision tree.

#### 42.12.2.1 Raw Materials

Of the raw materials, the most hazardous item is chicken. It may be contaminated with pathogenic bacteria. The storage conditions after collection and during transport are also significant. Therefore, the cooking step is very critical. Potatoes may carry bacterial spores on the skin. If the potatoes are received washed, the washing step is only a control point. Celery may be contaminated with bacteria and spray residues. Although chicken, potato, celery, and other ingredients may be contaminated with foreign matter, washing or inspection prior to use will reduce the risk of contamination. Mayonnaise, being acidic, may be contaminated with acid-tolerant bacteria. Tables 42.15 through 42.18 show the hazards associated with the raw materials used in the production of chicken and vegetable salad.

#### 42.12.2.2 Process

The process assessment of chicken and vegetable salad is given in Table 42.19. Potatoes are washed for the purpose of removing foreign matter from the skin. Cooking chicken is the only crucial step in the whole process and requires careful control of temperature and cooking time. Potatoes are also cooked, but the bacterial spores residing on the skin may not be destroyed. After cooking, there are several steps (peeling, trimming, and chopping) that involve manual handling. All such steps are hazardous, and there

**TABLE 42.15**

Hazards Associated with Processing Chicken

Processing Step	Hazard Type	Significant Y/N?	Hazard Description	Control Method
Receiving chicken	Biological	N	Pathogenic bacteria (e.g., <i>Salmonella</i> , <i>Campylobacter</i> , <i>Yersinia</i> )	Supplier HACCP compliant with controls and specifications. Cooking step
	Chemical	N		
	Physical	N		
Cold storage	Biological	Y	Growth of pathogenic bacteria on long-term storage	Store below 1°C
	Chemical	N		
	Physical	N		
Washing	Biological	N	Microorganisms may remain after washing	Clean sink between items
			They redistribute when soaked	On completion, clean and disinfect
			Microorganisms occur in drip water	Water control program Cooking step
	Chemical	N	Foreign matter, unlikely	Use filtered water
	Physical	N		
Cutting	Biological	N	Microbiological contamination from hands and equipment	Disinfect utensils and equipment. Personnel hygiene Cooking step
	Chemical	N		
	Physical	N		
Cooking	Biological	Y	Survival of bacteria	Cook to an internal temperature of 75°C
	Chemical	N		
	Physical	N		

**TABLE 42.16**

Hazards Associated with Processing Potatoes

Processing Step	Hazard Type	Significant Y/N?	Hazard Description	Control Method
Receiving potatoes	Biological	N	Bacterial spores on skin	Supplier HACCP compliant with controls and specifications. Washing, cooking, and peeling steps
	Chemical	N	May be grown in contaminated soil, unlikely	Approved and monitored supplier program
	Physical	N	Foreign matter	Wash thoroughly.
Washing	Biological	N	Microorganisms may remain after washing.	Clean sink between items.
			They redistribute when soaked	On completion clean and disinfect.
			Microorganisms occur in drip water	Water control program. Washing, cooking, and peeling steps
	Chemical	N		
Cooking	Physical	N	Foreign matter may remain after washing, unlikely	Wash thoroughly
	Biological	Y	Survival of bacteria	Boil in water until potatoes are tender
	Chemical	N		
Peeling Trimming Cutting	Physical	N		
	Biological	Y	Microbiological contamination from hands and equipment	Disinfect utensils and equipment. Personnel hygiene
	Chemical	N		
	Physical	N		

are no crucial steps downstream. Washing the celery may reduce the level of vegetative pathogens but will not eliminate them. Microbial contamination can occur during the mixing operations. The salad is hand filled into trays and exposed to the environment. Frequent manual handling during the filling operation is a health hazard. The temperature of chilled storage and display cabinets must be controlled to prevent the growth of microorganisms. All steps recognized as significant should be considered for the identification of the CCPs in the final analysis.

#### **42.12.2.3 Product**

Microbial growth can occur if the storage conditions of the salad are not controlled at the food producer's premises and during transport and distribution.

#### **42.12.2.4 End Use**

The chicken and vegetable salad is a food product that is prepared for the general population. However, after purchase, abuse such as leaving the container open or keeping it at a warm temperature can cause the product to deteriorate and become a health hazard if consumed. The label should include specific conditions of storage and the use-by date.

**TABLE 42.17**

Hazards Associated with Processing Celery

Processing Step	Hazard Type	Significant Y/N?	Hazard Description	Control Method
Receiving celery	Biological	Y	Microbiological contamination	Supplier HACCP compliant with controls and specifications.
	Chemical	Y	Chemical spray residue	Wash under running water
	Physical	Y	Foreign matter	
Refrigerated storage	Biological	N	Microbiological growth unlikely	Store below 5°C. Inspect daily for spoilage
	Chemical	N		
	Physical	N		
Washing	Biological	Y	Microorganisms may remain after washing.	Clean sink between items.
			They redistribute when soaked	
			Microorganisms occur in drip water	
	Chemical	Y	Chemical residues	Water control program.
Physical	N	Foreign matter	Use filtered water	
Trimming Chopping	Biological	Y	Microbiological contamination from hands and equipment	Disinfect utensils and equipment. Personnel hygiene
	Chemical	N		
	Physical	N		

**TABLE 42.18**

Hazards Associated with Processing Mayonnaise and Other Raw Materials

Processing Step	Hazard Type	Significant Y/N?	Hazard Description	Control Method
Receiving mayonnaise and ingredients	Biological	N	Acid resistant bacteria, unlikely	Supplier HACCP compliant with controls and specifications
	Chemical	N	Foreign matter may remain undetected	Inspect before use
	Physical	Y		
Receiving trays	Biological	N	Microbiological contamination, unlikely	Supplier HACCP compliant with controls and specifications.
	Chemical	N		
	Physical	N	Foreign matter, unlikely	Inspect before use

### 42.12.3 Application of Decision Tree

Table 42.20 shows the application of decision tree to the process steps. The four questions in the decision tree allow the identification of hazards that could be reduced at an early stage even though a downstream process is capable of eliminating or reducing the risk. For example, washing potatoes removes or reduces the extent of foreign matter that may be present before they are cooked. The cooking step destroys the microorganisms. Therefore both washing (removal of foreign matter) and cooking (eliminating microorganisms) steps are the CCPs.

**TABLE 42.19**

Hazards Associated with the Preparation of Chicken and Vegetable Salad

Processing Step	Hazard Type	Significant Y/N?	Hazard Description	Control Method
Mixing	Biological	Y	Contamination from hand and equipment	Clean and disinfect equipment Personnel hygiene
	Chemical	N		
	Physical	N		
Filling trays	Biological	N	Microbiological contamination in open containers, unlikely	Maintain clean environment Close containers immediately after packing
	Chemical	N		
	Physical	N		
Storage	Biological	Y	Microbial growth on long-term storage	Store below 5°C  Mark lot number and use by date
	Chemical	N		
	Physical	N		

**TABLE 42.20**

Critical Control Points for Chicken and Vegetable Salad

Process Step	Significant Hazard	Q1	Q2	Q3	Q4	CCP Y/N
Receive chicken	Microbial contamination	Yes	No	Yes	Yes	No
Cold storage	Microbial growth	Yes	No	Yes	Yes	No
Washing	Microbial contamination	Yes	No	Yes	Yes	No
Cutting	Microbial contamination	Yes	No	Yes	Yes	No
Cooking	Survival of microorganisms	Yes	Yes			CCP
Receive potato	Bacterial spores					
	Foreign matter	Yes	No	No		No
Washing	Foreign matter	Yes	Yes			CCP
Cooking	Survival of microorganisms	Yes	Yes			CCP
Receive celery	Microbial contamination	Yes	No	No		No
	Chemical spray					
Washing	Foreign matter					
	Microbial contamination	Yes	Yes			CCP
Trimming	Microbial contamination	Yes	No	No		No
Chopping						
Receive mayonnaise and ingredients	Foreign matter	Yes	No	No		No
Inspect ingredients	Foreign matter may go undetected	Yes	Yes			CCP
Receive trays	Foreign matter	Yes	No	No		No
Mixing	Microbial contamination	Yes	No	No		No
Storage	Microbial growth	Yes	No	Yes	No	CCP

The decision tree is applied to all the steps to determine the CCPs. Chicken can undergo spoilage during storage. However, the storage step is not classified as a CCP because it does not eliminate or reduce the microorganisms, and there is ample opportunity to inspect for spoilage during the subsequent steps of washing, cutting, and cooking. Cooking the chicken pieces for a sufficiently long period can destroy microorganisms. Hence, it is a crucial step and classified as a CCP.

The steps of peeling and cutting after cooking can introduce contaminants from the hand, knives, and other equipment. However, bacteria cannot multiply in the presence of high-acid ingredients such as mayonnaise, vinegar, pickle, etc. Therefore, the mixing step can give absolute control if sufficiently high-acid ingredients are added and thoroughly blended. Thus, the peeling and cutting steps are not CCPs.



Celery may be contaminated with foreign matter and microorganisms. The washing step will remove foreign matter but may not reduce the risk of vegetative pathogens to an acceptable level. While the reduction of foreign matter is an important process step, the trimming and chopping operations after the washing step may provide ample opportunity to ensure that the foreign matter is removed. However, if there is sufficient evidence to show that the washing step does reduce the level of microbial contamination and any chemical residue to an acceptable level, the washing step could be considered as a CCP.

The plastic trays into which the salad is filled are new. Although the trays may have foreign matter, they are inspected prior to use and hence contamination with foreign matter can be eliminated. The process of chilling and storage of the finished product are the CCPs (CCP1), and storage under controlled conditions will prevent the growth of microorganisms.

#### **42.12.4 Overall Risk Assessment and Reduction**

It is now possible to consider how risks can be reduced by making some changes to the process. Vegetables are a major source of contamination. Potato and celery can be purchased from an approved grower. Celery may be blanched or washed with chlorinated water to reduce the bacterial load. Potato can be washed, peeled, trimmed, cooked and diced, or diced and cooked. Contamination can occur during the manual handling operations, particularly after the cooking step. The use of disposable gloves during manual handling will minimize contamination. Pathogenic bacteria do not grow in acid media, and contamination during the mixing step can be controlled by adjusting the pH to 4.5 or lower. If this is not practicable, the formulation can be tested and the recipe then followed accurately. Tamperproof or tamper-evident packs can be used as a precaution against tampering and possible contamination. The risk of abuse by the consumer can be minimized by providing warning labels that give instructions on storage after purchase. Metal detectors can be installed on line to detect metal objects in the food. The finished product can be subjected to microbiological tests to detect the presence of specific microorganisms.

#### **42.12.5 Control Schedule**

Steps that have been identified as the CCPs are controlled as specified in the control schedule (Table 42.21).

---

### **42.13 Case Study II: Production of Vacuum-Packed Hot-Smoked Salmon**

#### **42.13.1 Product Description**

Vacuum-packed hot-smoked salmon [49] is a cooked ready-to-eat product. Salmon, packed in ice, are delivered to the production facility within hours of harvesting. Salt, sugar, and spices are bought from the market. After smoking, the smoked salmon are individually packed and vacuum sealed. They are then packed in outer boxes of polystyrene with corrugated board outside. The finished boxes are frozen at  $-18^{\circ}\text{C}$  and delivered in refrigerated trucks. The shelf life of the product is 1 year from the production date.

#### **42.13.2 Assessment of Hazard Potential of Vacuum-Packed Hot-Smoked Salmon**

The flow diagram for the production of vacuum-packed hot-smoked salmon is shown in Figure 42.2. The hazards associated with the raw materials, processing steps, product, and end usage are examined next. The analysis will show the raw materials and the processes that are critical to the production of a safe product. A risk analysis is carried out to establish the CCPs.

##### **42.13.2.1 Raw Materials**

The assessment of hazard potential is shown in Tables 42.22 through 42.24. Fish is an ideal breeding ground for pathogens such as *C. botulinum* and *L. monocytogenes*, and parasites. Throughout the process, adequate care has to be taken to prevent the growth of microorganisms. The fish should be

**TABLE 42.21**  
Control Schedule for Chicken and Vegetable Salad

Processing Step	Item to be Controlled	Control Limit	Control Method	Frequency	Action	Responsibility	Record
Receiving ingredients CCP2	Foreign matter	No foreign matter	Visual inspection	Every batch	Reject Inform supplier	Supervisor	Inward goods record
Cooking potatoes CCP1	Cooking temperature/ time	Cook to a minimum internal temperature of 60°C for at least 15 s	Monitor temperature	Continuous	Cook longer	Operator	Temperature chart
Washing potatoes CCP2	Foreign matter	No foreign matter	Visual inspection	Every batch	Remove foreign matter Wash again	Operator	Check sheet
Trimming, chopping celery CCP2	Equipment cleanliness, foreign matter	Clean equipment, no foreign matter	Visual inspection	Continuous	Remove foreign matter Clean equipment	Operator	Check sheet
Cooking chicken CCP1	Cooking temperature/ time	Cook to a minimum internal temperature of 75°C for at least 15 s	Monitor temperature	Continuous	Cook longer	Operator	Temperature chart
Storage-filled trays CCP1	Storage temperature, labeling instructions	Store below 5°C, label correctly	Monitor temperature, inspect label	Every 2 h	Quarantine product Investigate cause	Supervisor	Temperature chart

TABLE 42.22

Hazards Associated with Processing Salmon and Ingredients

Processing Step	Hazard Type	Significant Y/N?	Hazard Description	Control Method
Receiving Salmon	Biological	Y	Pathogenic bacteria, parasites	Raw fish is frozen and the end product is also frozen Supplier HACCP compliant with controls and specifications. Smoking process
	Chemical	N		
	Physical	N	Metal hooks	Cutting step
Cold storage	Biological	N	Growth of pathogenic bacteria on long-term storage	Frozen storage.
	Chemical	N		
	Physical	N		
Receiving salt and sugar	Biological	N		
	Chemical	N		
	Physical	N	Foreign matter, unlikely	Inspection on receipt
Dry storage of salt and sugar	Biological			
	Chemical	N		
	Physical	N		
Receiving packaging	Biological	N	Bacteria, unlikely	Supplier HACCP compliant.
	Chemical	N		
	Physical	N	Foreign matter, unlikely	Inspection prior to use
Dry storage of packaging	Biological	N		
	Chemical	N		
	Physical	N		
Weighing salt and sugar	Biological	Y	Microbiological contamination from hand and equipment	Personnel hygiene Clean and disinfect equipment
			Chemical residues	Cleaning procedures
Mixing	Biological	N	Microbiological contamination from hand and equipment	Personnel hygiene
	Chemical	N		
	Physical	N		

packed in ice until delivered to the factory. Packaging materials that come into contact with fish may harbor microorganisms. Therefore, the packaging material suppliers should have an effective food safety program in place to ensure that food-contact materials are free from biological, chemical, or physical contaminants.

#### 42.13.2.2 Process

The hazards associated with the smoking process are shown in Table 42.23. The production facility should maintain a hygienic environment, clean and disinfected equipment, and a personnel hygiene program to minimize or eliminate the chances of contamination. The brining process has to be carried out under refrigeration because high temperature can lead to pathogen growth. Immediately after brining,

TABLE 42.23

Hazards Associated with Processing Steps

Processing Step	Hazard Type	Significant Y/N?	Hazard Description	Control Method
Semidefrosting	Biological	Y	Pathogenic bacteria growth, unlikely since the fish is only semidefrosted	Monitor semidefrosting
	Chemical	N		
	Physical	N		
Cutting and trimming	Biological	Y	Contamination from hands	Personnel hygiene
	Chemical	N	Foreign matter	Inspection
	Physical	N		
Brining	Biological	Y	<i>C. botulinum</i> growth and toxin production in finished product	Proper brining
	Chemical	N	Other bacterial pathogens	Correct salt concentration
	Physical	N		
Rinsing	Biological	N	Microbial contamination, unlikely due to short time	Rinsing procedure
	Chemical	N		
	Physical	N		
Drying	Biological	Y	Microbiological concentration; salt content in the fish is insufficient to inhibit growth	Controlled at the smoking step
	Chemical	N		
	Physical	N		
Smoking/cooking	Biological	Y	Survival of pathogens due to inadequate cooking	Proper smoking/cooking
	Chemical	N		
	Physical	N		
Cooling	Biological	N	Growth of pathogens	Cooling procedure Combination of salt and smoking Too short period for growth to occur
	Chemical	N		
	Physical	N		

the product should be maintained below 4°C until further processing. The smoking operation is the most critical step. The smoking process should be designed to eliminate *L. monocytogenes* by holding the product at a suitably high temperature for a sufficiently long period. The internal temperature of fish should be continually monitored and recorded. If adequate temperature is not reached, bacteria will survive. The smoking temperature of not lower than 65°C for not less than 30 min is based on the coldest part of the fish in the oven. Severe temperature abuse during packaging, storage, and distribution can allow pathogen growth. The storage conditions should be specified on the label so that consumers are aware of the danger of storage outside the stated limits.

#### 42.13.2.3 Product

The drivers must ensure that refrigerating units in delivery trucks are maintained in good working condition. Microbial growth can occur if the storage conditions are not adhered to at the food production facility as well as during transport and distribution.

TABLE 42.24

Hazards Associated with Packing Hot-Smoked Salmon

Processing Step	Hazard Type	Significant Y/N?	Hazard Description	Control Method
Vacuum packing/labeling	Biological	Y	Introduction of bacteria Temperature abuse can allow growth during subsequent distribution and storage	Packing procedure Indicate storage conditions (−18°C) on the label
	Chemical	N		
	Physical	N		
Boxing	Biological	N	Microbiological contamination, unlikely	Packing procedure
	Chemical	N		
	Physical	N		
Cold storage	Biological	Y	Growth of <i>C. botulinum</i>	Correct storage temperature
	Chemical	N		
	Physical	N		
Distribution	Biological	N	Bacterial growth, unlikely	Polystyrene boxes and refrigerated trucks
	Chemical	N		
	Physical	N		

#### 42.13.2.4 End Use

The product is intended for general use. The label must comply with regulatory requirements and should specify any colorants or additives added, storage conditions, and expiry date.

#### 42.13.3 Risk Assessment

Raw fish may carry pathogenic bacteria and parasites. Risk assessment of the hot-smoking process depends on the severity of the outcome and the likelihood of occurrence of the hazard in the food product. Throughout the process, the growth of pathogenic bacteria such as *C. botulinum* and *L. monocytogenes* is a potential hazard that can lead to serious illness (severity score = 2). The likelihood of triggering the illness is extremely low [50]. The pathogenic organisms grow at temperatures above 1°C, and they compete with spoilage flora, which grows well at temperatures below 1°C. Therefore the fish is likely to be spoiled before the production of toxins or the development of a high number of pathogens. When the products are cooked before consumption, the risk is completely eliminated. Thus, the likelihood at the fish receiving step is classified as D (unlikely to occur).

Brining is an essential part of the whole operation as the salt content in the fish in combination with smoke and heat treatment is necessary to control the growth of microorganisms. Cases of contamination of smoked salmon with *L. monocytogenes* [51] have been reported. Because of the critical nature of brining, smoking, and cool storage operations and reported cases of contamination, the hazard of microbial growth is classified as likely events (likelihood score = C) and thus, these steps are the CCPs. Table 42.25 shows the risk analysis of the hazards identified as significant.

#### 42.13.4 Overall Risk Assessment and Reduction

The fish are a major source of microbial contamination. Raw fish should be examined for freshness and wholesomeness. All eviscerated fish or fish not being used should be kept below 0°C. Frozen fish should be checked for wholesomeness. The production facility should ensure that cleanliness of the plant and equipment, a hygienic environment, and personnel hygiene are maintained to minimize the risks of contamination.

**TABLE 42.25**

Control Schedule for Hot-Smoked Salmon

Activity	Potential Hazard	Critical Limit	S	L	A	Control Method	Corrective Action	Person Responsible	Record
Receiving salmon	Microbial growth	Received frozen	2	D	12	Product is frozen Supplier HACCP compliant Controlled at smoking	HOLD, inform supplier	Supervisor	Inward goods receipt
Weighing salt and sugar	Microbial contamination	No contamination	3	D	17	Personnel hygiene Disinfect equipment	HOLD product, monitor cleaning and hygiene	Supervisor	Check sheet
Semidefrosting	Microbial growth	No growth	2	D	12	Defrosting procedure Controlled at smoking	HOLD, investigate	Supervisor	Temperature chart
Cutting and trimming	Microbial contamination	No contamination	2	D		Personnel hygiene Controlled at smoking	HOLD, check cleaning and hygiene	Supervisor	Check sheet
Brining <b>CCP</b>	Microbial growth	Minimum 24 h soaking Minimum salt content of 60°	2	C	8	Time in brine Salt content Weight of fish and brine Maintain chill room temperature	HOLD longer in brine Investigate	Supervisor	Check sheet Temperature chart
Drying	Microbial concentration	No growth	3	D	17	Correct drying procedure Correct salt concentration	HOLD product Investigate	Supervisor	Check sheet
Smoking <b>CCP</b>	Survival of microorganisms	No microorganisms	2	C	8	Minimum internal temperature of fish should be 65°C for 30 min	HOLD product Investigate	Smoke operator	Temperature chart
Vacuum-packing, labeling	Growth of microorganisms	No growth	3	C	13	Presence of appropriate label/statement on storage Correct packing procedure	Relabel	Packing supervisor	Check sheet
Cold storage <b>CCP</b>	Bacterial growth, toxin production	No growth or toxin	2	C	8	Cooler temperature of 0°C or less	HOLD product Adjust cooler temperature	Supervisor	Temperature chart

Note: S = Severity; L = Likelihood; and A = Assessment.

During frozen fish storage, the temperature can be monitored through continuous surveillance using security alarms. The smoking process is critical, and the internal temperature of fish during this process can be monitored using thermocouple probes in the three thickest fish in the coldest part of the oven. A sample from each oven load should be analyzed for water-phase salt level. The cooling step after smoking should be controlled because of the possibility of microbial growth, if the cooling period is too long.

Time–temperature integrated labels may be applied on the finished product to indicate any abuse of temperature over a certain period of time. Tamper-evident packaging will provide further security against intended or unintended contamination. Automatic labeling system with alarms will ensure the application of the label on every pack.

#### 42.13.5 Control Schedule

Steps that have been identified as the CCPs are controlled as specified in the control schedule (Table 42.25).

---

### 42.14 Good Manufacturing Practices

In preparing the salad and the hot-smoked salmon, there are several operations that are control points, but not CCPs. These steps can be controlled by implementing GMPs. Inspection and storage of raw materials, cleaning of equipment, use of food-grade detergents and disposal gloves, training in personnel hygiene, a preventive maintenance program, and the use of status stickers are some of the controls that must be considered to assure the safety of the final product. Regular audits provide a means of verifying the effectiveness of such procedures.

---

### 42.15 ISO 22000 Standard

ISO 22000:2005 defines the requirements for a food safety management program, which requires the organization to demonstrate its ability to control food hygiene throughout the food chain. The aim of the program is to ensure that food is safe at the time of consumption. This standard harmonizes the voluntary standards.

---

## References

1. Y. Motarjemi, F. Kaferstein, G. Moy, S. Miyagawa and K. Miyagishima, Importance of HACCP for public health and development: The role of the World Health Organisation, *Food Control* 7:77 (1996).
2. M.O’K. Glavin, A single microbial sea: Food safety as a global concern, *SAIS Review* 23:203 (2003).
3. O.P. Snyder, HACCP—An industry food safety self-control programme—Part I. *Dairy, Food Environ. Sanit.* 12:26 (1992).
4. R. Vail, Fundamentals of HACCP, *Cereal Foods World* 39:393 (1994).
5. B. Nordmark, HACCP, *Food Technol. N.Z.* 30:18 (1995).
6. Joint FAO/WHO Codex Alimentarius Commission, *Codex Guidelines for the Application of HACCP*, 20th Session (1993).
7. C. Norton, Developing and verifying a flow diagram for food production, *Food Manage.* 38:80 (2003).
8. J. Hernandez, How to develop a food safety programme, *Food Manage.* 34:66 (1999).
9. National Advisory Committee for the Microbiological Criteria for Foods, Hazard analysis and critical control point principles and application guidelines, *J. Food Prot.* 61:1246 (1998).
10. World Health Organisation, General information about the Codex Alimentarius, Retrieved February 11, 2004 from [http://www.who.int/foodsafety/codex/general\\_info/en/print.html](http://www.who.int/foodsafety/codex/general_info/en/print.html).

11. British Retail Consortium, *BRC Global Standard: Food*, London (2003).
12. A.V. Risawadka, An introduction to HACCP, *Prof. Safe.* 45:33 (2000).
13. F.L. Bryan, Hazard analysis critical control point approach to food safety: Past, present and future, *J. Environ. Health* 61:9 (1999).
14. C. Norton, Taking it step-by-step, *Food Manage.* 37:52 (2002).
15. R. Kirby, HACCP in practice, *Food Control* 5:231 (1994).
16. C. Norton, HACCP start-up steps Part II, *Food Manage.* 37:60 (2002).
17. T. Mayes, HACCP training, *Food Control* 5:190 (1994).
18. Food and Agriculture Organisation of the United Nations, *Food Quality and Safety Systems*, Section 3, Rome (1998).
19. C. Norton, HACCP – Developing and verifying a flow diagram for food production: HACCP step-by-step Part IV, *Food Manage.* 37:56 (2002).
20. E. Underwood, Good manufacturing practices — A means of controlling biodeterioration, *Int. Biodeter. Biodegrad.* 36:449 (1995).
21. E.S. Garrett and M. Hudak-Ross, Use of HACCP for seafood surveillance and certification, *Food Technol.* 44:159 (1990).
22. H. Baumann, HACCP: Concept, development and application, *Food Technol.* 44:156 (1990).
23. R. Early, *Guide to Quality Systems for the Food Industry*, Blackie Academic & Professional, Glasgow, pp. 62–70 (1995).
24. H.E. Baumann, The origin of the HACCP system and subsequent evolution, *Food Sci. Technol.* 8:66 (1994).
25. J. Brooks and M. Reeves, Methods of controlling hazards, *Managing Food Safety*, Food Technology Research Centre, Department of Food Technology, Massey University, Palmerston North, p. 12 (1995).
26. J.S. Avens, Safety of food service delivery systems in schools, *Safety of Foods* (H.D. Graham, Ed.), AVI Publishing Company Inc., Connecticut, p. 758 (1980).
27. B.A. Munce, Hazard analysis critical control points and the food service industry, *Food Technol. Aust.* 36:214 (1984).
28. T.D. Beard, HACCP and the home: The need for consumer education, *Food Technol.* 45:123 (1991).
29. C. Norton, Conducting a hazard analysis, *Restaurant Hospitality*, 86:82 (2002).
30. J.J. Rooney and J. Kilkelly, On today's menu: Quality, *Quality Prog.* 35:25 (2002).
31. R.A. Savage, Hazard analysis critical control point: A review, *Food Rev. Int.* 11:575 (1995).
32. J. Brooks and M. Reeves, Methods of controlling hazards, *Managing Food Safety*, Food Technology Research Centre, Department of Food Technology, Massey University, Palmerston North, p. 1 (section 7) (1995).
33. F.L. Bryan, Application of HACCP to ready-to-eat chilled food, *Food Technol.* 44:70 (1990).
34. D.L. Archer, The need for flexibility in HACCP, *Food Technol.* 44:174 (1990).
35. J. Brooks and M. Reeves, Critical control points, *Managing Food Safety*, Food Technology Research Centre, Department of Food Technology, Massey University, Palmerston North, p. 2 (1995).
36. B.J. Bobeng and B.D. David, HACCP models for quality control of entrée production in food service systems, *J. Food Prot.* 40:632 (1977).
37. Microbiology and Food Safety Committee of the National Food Processors Association, HACCP implementation: A generic model for chilled goods, *J. Food Prot.* 56:1077 (1993).
38. J. Brooks and M. Reeves, Evaluating control points, *Managing Food Safety*, Food Technology Research Centre, Department of Food Technology, Massey University, Palmerston North, p. 5 (1995).
39. Food and Agriculture Organisation, Annex 2 — The application of risk analysis to food safety control programmes, Retrieved December 4, 2003 from <http://www.fao.org/docrep/W8088E/w8088e07.htm>.
40. Report of the Joint FAO/WHO Expert Consultation, *Application of Risk Analysis to Food Standards Issues*, Geneva, Switzerland, March, 13–17 (1995).
41. Saferpak, HACCP, Retrieved December 4, 2003 from <http://www.saferpak.com/haccp.htm>.
42. R. Peters, Food Safety: Hunter Health, *Safe Food Australia*, 8 December (1999).
43. C. Norton, You've got to measure to manage, *Food Manage.* 38:58 (2003).
44. W.L. Bennet and L.L. Steed, An integrated approach to food safety, *Quality Prog.* 32:37 (1999).
45. C. Norton, Make food safety a matter of record, *Food Manage.* 38:82 (2003).
46. C. Norton, Don't trust — verify, *Food Manage.* 38:68 (2003).



47. World Health Organisation, Strategies for implementing HACCP in small and/or less developed businesses, *Report of a WHO Consultation*, The Hague, June, 16–19 (1999).
48. Microbiology and Food Safety Committee of the National Food Processors Association, Implementation of HACCP in a food processing plant, *J. Food Prot.* 56:548 (1993).
49. G.C. Fletcher, P.J. Bremer, G. Summers and C. Osborne, *Guidelines for the Safe Preparation of Hot-Smoked Seafood in New Zealand*, NZ Institute for Crop & Food Research Limited, (2003).
50. H.H. Huss, Assurance of seafood quality, *FAO Fish.Tech.* Paper No. 334, Rome (1993).
51. Safety Alerts, April 4, 2003, Retrieved February 16, 2004 from <http://www.safetyalerts.com>.
52. International Organisation for Standardization, ISO 22000 Food Safety Management Systems, Retrieved October 20, 2004 from <http://www.iso.org>.

# 43

## *Good Manufacturing Practice (GMP)*

Titus De Silva

### CONTENTS

43.1	Introduction .....	1012
43.2	GMP Activities .....	1012
43.3	GMP Philosophy .....	1013
43.4	Foundation of GMP .....	1014
43.4.1	Effective Manufacturing Operations .....	1014
43.4.2	Effective Food Control .....	1014
43.4.3	Effective Management .....	1014
43.5	The Preliminary Process .....	1014
43.6	GMP Activities .....	1014
43.6.1	Organization and Personnel .....	1015
43.6.2	Training and Personnel Hygiene .....	1016
43.6.2.1	Recruitment and Induction .....	1016
43.6.2.2	Competence and Training .....	1016
43.6.2.3	Food Hygiene Requirements .....	1016
43.6.3	Building and Facilities .....	1016
43.6.4	Equipment .....	1017
43.6.5	Control of Components .....	1017
43.6.6	Production and Process Control .....	1018
43.6.6.1	Controls during Production .....	1018
43.6.6.2	Control of Finished Product .....	1018
43.6.7	Packaging and Delivery .....	1018
43.6.8	Storage and Distribution .....	1019
43.6.8.1	Storage .....	1019
43.6.8.2	Distribution .....	1019
43.6.9	Laboratory Controls .....	1019
43.6.10	Documentation .....	1019
43.6.10.1	Instructions and Procedures .....	1019
43.6.10.2	Programs .....	1021
43.6.10.3	Records and Reports .....	1021
43.6.10.4	Document Control System .....	1021
43.6.11	Cleaning and Sanitation .....	1021
43.6.11.1	Cleaning and Sanitization Steps .....	1022
43.6.11.2	Cleaning Methods .....	1022
43.6.11.3	Sanitization Methods .....	1022
43.6.12	Maintenance and Calibration .....	1022
43.6.12.1	Repair .....	1022
43.6.12.2	Preventive Maintenance .....	1022
43.6.12.3	Intrusive Maintenance .....	1022
43.6.12.4	Calibration .....	1022

43.6.13	Pest Management Program .....	1023
43.6.14	Foreign Matter Control .....	1023
	43.6.14.1 External Sources of Contamination .....	1023
	43.6.14.2 Internal Sources .....	1023
	43.6.14.3 Foreign Matter Control .....	1023
43.6.15	Waste Management .....	1023
43.6.16	Reworking Material .....	1024
43.6.17	Customer Complaint Procedure .....	1024
43.6.18	Audits, Reviews, and Recall Procedure .....	1025
43.7	ISO 9000 Standard, GMP, and HACCP System .....	1025
43.8	Benefits of GMP .....	1025
43.9	Application of GMP Principles .....	1026
43.9.1	Production of Fresh Produce.....	1026
43.9.2	Production of Unpasteurized Apple and Other Fruit Juice.....	1026
	43.9.2.1 Orchard Management.....	1026
	43.9.2.2 Harvesting Practices.....	1026
	43.9.2.3 Transportation .....	1026
	43.9.2.4 Fruit Storage.....	1027
	43.9.2.5 Fruit Sorting and Cleaning.....	1027
	43.9.2.6 Fruit Inspection and Processing.....	1027
43.9.3	Production of Fermented Dry and Semidry Sausage Products .....	1027
	43.9.3.1 Raw Material Treatment .....	1027
	43.9.3.2 Processing .....	1027
	43.9.3.3 Slicing and Packaging Equipment.....	1027
43.9.4	Poultry Processing .....	1028
	43.9.4.1 Inspection and Sorting .....	1028
	43.9.4.2 Washing and Other Preparations .....	1028
	43.9.4.3 Preparation and Processing .....	1028
	43.9.4.4 Cooling and Refrigeration Requirements .....	1028
	43.9.4.5 Ice-Pack Containers .....	1028
References .....		1028

---

## 43.1 Introduction

Good manufacturing practices (GMPs), also known as current Good manufacturing practices (cGMPs), are a series of manufacturing and administrative procedures aimed at ensuring that products are consistently made to meet specifications and customer expectations. The regulations governing GMP cover a variety of consumer goods such as human pharmaceutical products and veterinary products (21 CFR 210–211); biologically derived products (21 CFR 600 and CFR 620); medical devices (21 CFR 820); manufacturing, packaging, or holding human food (21 CFR 110); and processed food (21 CFR 100) [1]. In relation to food, the implementation of GMP results in safe and quality food. In the United States, the Food and Drug Administration (FDA) has issued these regulations as the minimum requirement for manufacture. Most countries have their own GMP regulations for pharmaceuticals. The first formal set of GMPs was published by the U.S. FDA in 1963 as Part 133 [1].

---

## 43.2 GMP Activities

Figure 43.1 shows the various activities of GMP. It supports and brings together many programs, systems, and philosophies that lead to an effective food business providing safe and quality products. The three main elements of GMP are food safety, good practice, and quality. Their relationship to each other is shown in Figure 43.2, core food business. Food safety and quality management systems, and the standards provide a firm foundation for the survival of the business by adding attributes of quality and value to the product. This will enable the food business to gain competitive advantage.

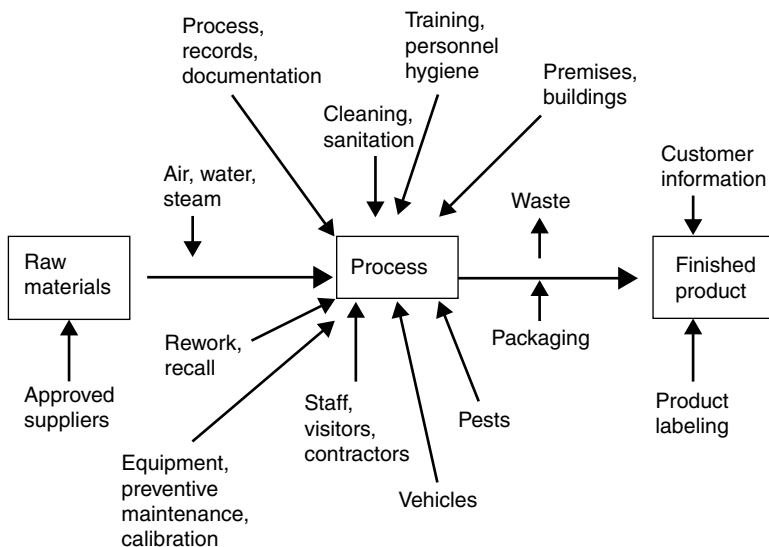


FIGURE 43.1 Activities of GMP.

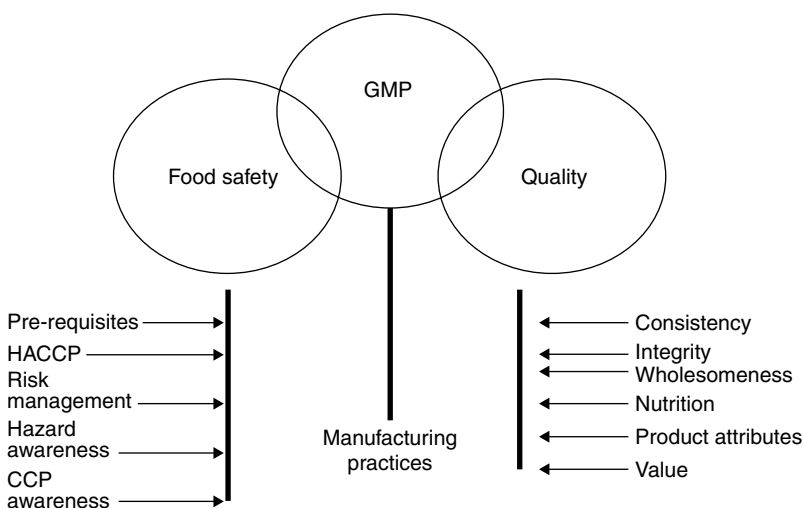


FIGURE 43.2 Core food business.

### 43.3 GMP Philosophy

The philosophy behind GMP is summarized [2] as: (i) GMP is closely aligned with disciplines such as quality, management, food safety, and food quality; (ii) GMP is designed by food manufacturers for food manufacturers; (iii) GMP involves the entire food business operation from the establishment of policy to its implementation; (iv) GMP is a proactive and hands-on document; (v) GMP has provision to exceed customer’s expectations and provides confidence in the product and consistency in the process; (vi) every activity within the food business impacts on the finished product; and (vii) through GMP, value is built into the product and loyalty to the brand.

---

## **43.4 Foundation of GMP**

GMP is based on two complementary and interacting components: effective manufacturing operations and effective food control operations. Complementary to these two components are the management functions of these two components.

### **43.4.1 Effective Manufacturing Operations**

GMP requires that every aspect of food manufacturing process is clearly defined and effective in achieving the desired result, and that all necessary facilities are provided, including [3] (i) adequate premises and space; (ii) correct and properly maintained equipment; (iii) appropriately trained personnel; (iv) correct ingredients and packaging material; (v) suitable storage and transport; (vi) documented procedures for all operations including cleaning; (vii) appropriate management and supervision; and (viii) adequate administrative, technical, and maintenance support. Record keeping is an integral part of the manufacturing operation and records provide evidence of completed activities in the plant. Procedures are necessary for all processes including training, written in a manner easily understood by the operators.

### **43.4.2 Effective Food Control**

Effective food control can be achieved by having an efficient food control management plan by (a) providing adequate facilities for inspection, sampling, and testing; (b) monitoring process conditions and the production environment; and (c) providing prompt feedback to manufacturing personnel to enable them to make adjustments when necessary. Control mechanisms are established for all tasks from receiving raw materials to the delivery of finished goods or disposal of nonconforming goods.

### **43.4.3 Effective Management**

The achievement of GMP objectives is the responsibility of senior management and requires active participation and commitment of personnel in many interacting departments at all levels within the organization and its suppliers. To accomplish the objectives, there must be a comprehensively designed and effective quality system incorporating the elements of GMP. The basic concepts of quality assurance, GMP, and quality control are interrelated. Senior management must have a formal commitment to be in compliance with the GMP requirements. The management has to ensure that the key personnel are suitably qualified and trained to carry out their tasks according to the prescribed procedures. Over the past 10 years, there has been a global attempt to formalize the management process that guides the establishment of GMP [4]. The result of this attempt is the ISO 9000 series of standards.

---

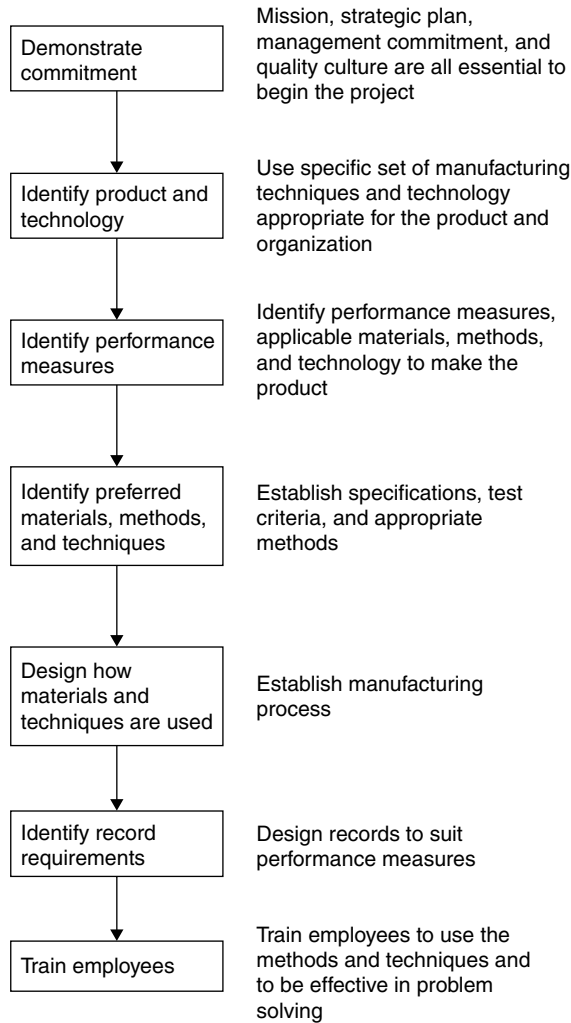
## **43.5 The Preliminary Process**

A manufacturing organization adopting the GMP principles is able to (a) consistently meet its own and customers' requirements, (b) meet industry standards and codes of practice, and (c) comply with regulatory requirements. To achieve this, the organization has to plan its activities. The preliminary process for GMP is shown in Figure 43.3. The scope of GMP is not only the production of a perfect end product but also the demonstration of activities that accomplish the end product.

---

## **43.6 GMP Activities**

GMP is intended to build quality into the product at all stages of the operation and the activities associated with GMP are [5,6] (i) organization and personnel, (ii) training and personnel hygiene, (iii) building and facilities, (iv) equipment, (v) control of components, (vi) production and process control, (vii) packaging and label control, (viii) storage and distribution, (ix) laboratory control, (x) documentation,



**FIGURE 43.3** Preliminary process for GMP.

(xi) cleaning and sanitization, (xii) maintenance and calibration, (xiii) pest management, (xiv) foreign matter control, (xv) waste management, (xvi) reworking material, (xvii) audits and review, (xviii) customer complaint procedure, and (xix) recall procedure.

### 43.6.1 Organization and Personnel

To implement the GMP program effectively, it is necessary for the organization to establish a structure appropriate for the business. It must have an adequate number of personnel who have the relevant qualifications and training to perform the required tasks. Their duties should be clearly explained before the commencement of the tasks. The training program should cover the principles of GMP, specific tasks, and personnel hygiene.

The three key personnel in a manufacturing organization are the quality control/quality assurance (QC/QA) manager, the production manager, and the purchasing manager. The QC/QA manager has the authority to (a) approve materials and finished goods; (b) reject, hold, or quarantine nonconforming products; and (c) recommend suppliers. The production manager is responsible for production, personnel, equipment, operations, and the management of records. It is the responsibility of the production

manager to ensure that products are manufactured to the relevant specifications within the budgeted cost. In consultation with the QC/QA manager, the production manager should (a) generate specifications for materials and products, (b) train manufacturing staff, and (c) control manufacturing environment and hygiene.

The purchasing manager has the authority to order raw materials that comply with established specifications and initiate action with the suppliers when the purchased product does not meet product specifications. The management must demonstrate support and commitment to the principles of GMP and create an environment where the employees take ownership. Leadership and motivation are key features of an effective business organization. The managers must adopt a proactive approach and promote a quality culture within the organization so that the employees take pride in their workmanship.

### **43.6.2 Training and Personnel Hygiene**

The organization has to ensure that the employees have appropriate facilities and are trained to promote personnel hygiene and safe food handling. The training program has to reflect the type of operation and the level of education of its employees.

#### **43.6.2.1 Recruitment and Induction**

The basis of recruitment and selection process is the ability to do the task at the time, unless the organization has a program to train the new recruit. The organization has to ensure that the person has the capability to perform the job either after training or with previous experience. The recruitment process and subsequent training are thus critical for food safety. Job descriptions have to be established for all positions. The relevant competence and training requirements are specified for each job. The aim of the induction process is to prepare the new employee to the company culture, and the process itself should commence with the introduction of the person to the business, its quality system, the organization's expectations, and the tasks. The person's responsibilities, reporting structure, and the disciplinary process have to be clearly defined.

#### **43.6.2.2 Competence and Training**

Competence is the demonstrated ability to apply knowledge and skills to a task correctly and completely first time without assistance. The organization should ensure that minimum levels of competence are maintained and that the employees perform the tasks without supervision.

The training program should include the principles of GMP and the demonstration of competence in company's hygiene practices, its quality management system, and the operating principles of the activity. It is essential that the trainer emphasizes the reason for maintaining food hygiene and compliance with legal requirements. At regular intervals, it is the manager's responsibility to review the training requirements and address the deficiencies.

#### **43.6.2.3 Food Hygiene Requirements**

Training in food hygiene is an essential part of the training program. The food hygiene requirements [7,8] include (i) clean protective clothing; (ii) hair and beard covers where necessary; (iii) washing hands before commencing work; (iv) keeping body, hands, and clothing clean; (v) prohibition of smoking within the premises; (vi) exclusion of personnel suffering from infectious diseases; (vii) covering wounds with water-proof plaster; (viii) first aid material; and (ix) prohibition of wearing jewelry or loose items.

### **43.6.3 Building and Facilities**

Buildings should be located, designed, and constructed to suit the type of operation that permits the separation of individual processing, manufacturing, packing, testing, and storage operations to avoid mix-ups, cross-contamination, and deterioration. At all times, the premises should be maintained in a clean and tidy condition. The processing areas should have (i) ceiling made out of materials that

prevent mold growth or buildup of dust; (ii) floors made of impervious material free from cracks or open joints; (iii) walls of smooth impervious material to facilitate easy cleaning; (iv) environmental controls such as adequate lighting, ventilation, heating, cooling, proper washing, and sanitary facilities; (v) entry points sealed off to prevent pest access and inhibit waste odors; (vi) drains that allow maximum flow of waste and have trapped gullies and proper ventilation; (vii) changing rooms segregated from processing areas; (viii) provision to contain waste in covered containers regularly disposed; (ix) protection for receiving and dispatch of materials and products in storage from weather; (x) written procedures for cleaning all processing areas; and (xi) pest control devices placed at appropriate locations away from open product.

#### 43.6.4 Equipment

All equipment used in the manufacturing area should be suitable for its intended use and properly maintained and cleaned. It is a good practice to use protective covers on equipment where there is a threat of contamination from external sources. All precautions must be taken to prevent contamination from hands and equipment during maintenance when processing takes place. All surfaces that come into contact with food should be (a) inert to the food and should not contaminate the food; (b) microbiologically cleanable, smooth, and nonporous; (c) visible for inspection and cleaning; and (d) set to enable self-emptying or self-draining. The equipment should be arranged to protect the contents from external contamination from leaking joints, lubricants, and broken metal parts. A program of preventive maintenance should be scheduled for all equipment, and during preventive maintenance it is essential that the engineer reports the missing parts such as nuts, bolts, and springs so that appropriate action can be taken. Before and after every use, it is a good practice to clean all equipment. Documented cleaning procedures should be available at all workstations. Power-driven equipment can sometimes generate fumes, and appropriate precautions should be taken to prevent the food from contamination.

#### 43.6.5 Control of Components

To ensure that the finished product has right quality attributes and is safe to consume, the raw materials, including packaging that directly come into contact with food, are purchased from approved suppliers. The criteria for the approval of suppliers should include the following: (i) the supplier should be able to meet the organization's requirements, (ii) the quality is acceptable, (iii) the supplier can meet the delivery needs, (iv) the price is acceptable, and (v) the supplier has an effective food safety program in place.

Adequate precautions should be in place to prevent any contamination before and after delivery to the premises. They are held in a segregated area in quarantine until their status has been determined after appropriate inspection. Segregation should also be extended to electronic documentation to prevent the material from being used in production before their status has been determined. The organization's inspection criteria may include (a) conformance certificates, (b) provision of test results, (c) identification on receipt, and (d) full analysis or any combination of these criteria. While in storage, all raw materials are checked regularly to ensure that they remain in an acceptable condition. The storage areas are maintained in a hygienic condition and in conditions appropriate for the type of raw material.

During the receipt and issue of raw materials, the organization has to ensure that the details of products are traceable through appropriate record keeping. Further controls may include checking weights/volumes, stock rotation, and identification. It is essential that appropriate stickers are applied following inspections. The status stickers generally in use are

HOLD: materials whose status is in doubt

QUARANTINE: materials whose status is yet to be determined

REJECT: materials unsuitable for use

PASSED: materials suitable for use

The reasons for HOLD, QUARANTINE, or REJECT and the date should be clearly stated on the label.



### 43.6.6 Production and Process Control

A fundamental requirement of any manufacturing organization is that the processes are capable of consistently producing finished goods, which conform to established specifications and that food products are free from contaminants. The effectiveness of the process has to be determined prior to production by means of controlled trials. Similar evaluations are done whenever there is a change in the raw materials, methods of manufacture, or equipment. Before commencing production, checks should be carried out to ensure that (a) the processing area is free from potential contaminants, (b) correct materials and methods are used, (c) correct set-up procedures are used, and (d) all equipment are clean and ready for use. Work instructions are kept at all workstations and are written in a clear and simple style for easy comprehension by the operators.

#### 43.6.6.1 Controls during Production

Accurate records have to be maintained of all production data, including the operating conditions and quality parameters. Statistical control charts are used to identify deviations from the normal. Problems that cause stoppages, breakdowns, and emergencies are identified, recorded, and promptly addressed. Process controls specify the type of tests to be conducted, the frequency of checks, and the operating limits. Suitable methods should be used to identify the batches of production, delivery vehicles, container numbers, etc. to enable effective traceability. The controls ensure that the product is not contaminated and is capable of preventing the growth of microorganisms. This is achieved by careful monitoring of physical factors such as time, temperature, humidity,  $a_w$ , pH, pressure, flow rate, and others as appropriate. Suitable conditions are maintained throughout the process to prevent the decomposition of the product and the growth of microorganisms.

During processing, steps are taken to ensure that the food is protected against inclusions of metal and other extraneous material. This can be achieved by the use of magnets, metal detectors, etc. Food processing operations often involve processes such as washing, peeling, cutting, sorting, and inspecting, and these are performed in a manner that prevents the food from contamination from hands, equipment, utensils, etc. The processing areas used for food production are not used for the manufacture of nonhuman food.

#### 43.6.6.2 Control of Finished Product

Finished products are not released until they are tested and approved by the authorized person. Nonconforming products are segregated and quarantined. Appropriate storage conditions are adhered to before and during delivery of finished goods.

### 43.6.7 Packaging and Delivery

Very often in packaged food items, packaging material comes into direct contact with the food. The organization must ensure that packaging materials possess the following features: (i) made with approved food-grade material; (ii) capable of protecting the food item during its expected life under normal conditions; (iii) appropriate for the production in terms of moisture absorptions, moisture loss, etc.; (iv) capable of standing up to recommended operations such as microwave heating and pressure; (v) no interaction between the food and the packaging material; (vi) capable of maintaining the characteristics and the integrity of the product; (vii) correct for the product being manufactured; and (viii) pass the test criteria.

Over the last few years, consumers have become increasingly aware of the characteristics of the product that they purchase through effective communication. The regulatory measures ensure that appropriate information is displayed on food products either on the label or on the immediate package. The label is not only a marketing tool but also a source of information to the consumer. The finished product should carry mandatory information and other information such as instructions for reconstitutions, storage conditions, and target consumer group as applicable. A unique code identifies the food product for recall purpose, if necessary. In many countries, attention is now focused on the declaration of allergens, and whether the food is genetically modified.

### **43.6.8 Storage and Distribution**

Storage and distribution are significant elements in the food supply chain. The primary purpose of storage and distribution of food products, ingredients, and packaging is to protect them from physical, chemical, and microbial contamination as well as the deterioration of the food and the container. The principles of good hygiene practice apply not only to food and the ingredient but also to packaging components that come into direct contact with food. The buildings, grounds, and equipment of food storage warehouses have to be designed, constructed, and maintained in a manner that does not compromise on food safety standards.

#### **43.6.8.1 Storage**

Storage, transport, and distribution are an important link between the producer and the consumers. Even if sufficient care has been taken to ensure the quality and the safety of food, uncontrolled storage and transport conditions can severely affect the food products. The storage conditions have to be appropriate for the type of food production facility, and the controlled conditions include (i) regular inspection of material for signs of deterioration, (ii) maintaining correct storage conditions for the type of product, (iii) regular cleaning to maintain storage areas in hygienic conditions, (iv) pest control program, (v) maintaining stock rotation, (vi) maintaining the integrity of the stock during internal and external transport, and (vii) segregation of products that have not been released for distribution.

#### **43.6.8.2 Distribution**

It is essential that transport and distribution are carried out by approved suppliers. The organization should ensure that vehicles used for transporting food products are not used for carrying animals, harmful articles, chemicals, or biological products. It is a good practice to ensure that the transporting facility has a good cleaning program, and it is the responsibility of the organization to inspect the vehicle for general cleanliness, accumulation of water, presence of foreign material, or damage that could cause contamination of the food product. The inspection checklist may include (i) openings that permit the entry of pests, rodents, birds, or insects; (ii) foreign odors; and (iii) presence of nails, splinters, oil, grease, dirt, or bird droppings. Security precautions deter any tampering with products during transport. Distributing the load in a uniform manner can avoid damage to the products and people or the vehicle during transport. All instruments necessary to maintain the environmental conditions inside the vehicle should be regularly inspected and maintained.

### **43.6.9 Laboratory Controls**

Laboratory testing is an integral part of the production process and it provides its customers, both internal and external, with accurate test results at all relevant times to fulfill the GMP requirements. The minimum requirements for laboratory practice are shown in Table 43.1. It is important to maintain the integrity of the testing laboratory. This may be achieved by accreditation of the laboratory to a national standard.

### **43.6.10 Documentation**

The documents in the production facility provide evidence that a particular activity has been followed and has been successful or failed. The aims of documentation are as follows: (a) define materials, processes, control measures, and products; (b) record and communicate information needed before, during, and after production; (c) reduce the risk of error arising from poor communication; and (d) permit investigations and traceability in case of failures of product or process. Documents fall into three main categories: instruction and procedures, programs, and records and reports.

#### **43.6.10.1 Instructions and Procedures**

Instructions and procedures are essential for any plant's effectiveness and efficiency. They provide information about how to perform tasks safely, effectively, and efficiently. They can be used for the training of employees. Instructions and procedures incorporate the best practice that result from

**TABLE 43.1**

## Requirements for Good Laboratory Practice

<b>Control Item</b>	<b>Requirements</b>
Personnel	Qualified and competent Suitably trained
Sample control	Documented criteria for receiving, accepting, and rejecting samples Clear traceability information Procedure for handling and storage of samples Sampling plans and equipment for sampling
Facilities and environment	Facilities and environment compliant with regulations Good housekeeping Monitored environmental conditions Prevention of cross-contamination Appropriate facilities and environment for conducting tests
Equipment control	Suitable equipment for effective performance of tests Calibration schedule for equipment Maintenance of current equipment Procedure for the purchase of new equipment Clear operating instructions at workstations Reference materials such as weights, thermometers, and hydrometers
Test methods	Validated and documented test methods Performance monitoring Validated quality control standards such as media, pH, and buffers Procedure for "suspect" test results
Record control	Management of records of test results Traceability of a record to a standard sample Inclusion of information such as the operator, signature of the authorized person for approval, and amendments and deviations from expected results Preserved from deterioration Easy retrieval
Test reports	Testing laboratory name and the customer Sample details Test method Accuracy of the test method Appropriate dates Authorized signature Results of tests as required by the customer
Documentation control	Scope of the laboratory function Recruitment of staff and necessary qualifications Management of samples Management of equipment Test methods Performance reviews Reviews of corrective action reports and audits

previous learning experiences. The user is actively involved in the development of procedures and instructions and they have to be helpful and intelligible. A good procedure (a) describes the purpose of the task; (b) emphasizes significant steps sequentially; (c) defines responsibilities; (d) provides guidance in the case of a problem and identifies decision points; and (e) is supported by flow diagrams, photos, and drawings in color. The documents that provide instructions and procedures are shown in Table 43.2.

**TABLE 43.2**

## Instructions and Procedures

<b>Document</b>	<b>Description</b>
Specifications	Raw materials, packaging materials, in-process controls, finished goods, customer requirements
Procedures	Manufacturing instructions Purchase procedures Quality policy and quality system procedures Product recall procedures Standard operating procedures Cleaning instructions Plant operating instructions
Schedules	Maintenance schedule Calibration schedule Audit schedule Review schedule

**43.6.10.2 Programs**

These are the scheduled activities carried by the organization to meet its targets. These include production programs, training programs, pest management programs, waste disposal programs, and environmental management programs.

**43.6.10.3 Records and Reports**

The records and reports include data entered before, during, and after manufacture to provide evidence of controls in place for the production of safe food. Some examples of records and reports are (i) records of receipt, inspection, approval, and issue of raw materials; (ii) records of tests and release information on bulk products, finished products, and intermediates; (iii) in-process control charts and calibration records; (iv) weight/volume control records; (v) batch manufacturing records; (vi) customer complaint reports; (vii) quality control records, audit reports, and reviews; and (viii) corrective action reports. Documents and records are maintained for a period after the end of the expected shelf life of the product as specified by the regulatory bodies or as required by the organization. These also include electronic data and documents that should be backed up according to a scheduled program.

**43.6.10.4 Document Control System**

An effective documentation control system ensures that the documents and critical control records are available, up to date, and correct. The following information is essential for a document control system: (i) title, (ii) issue date and issue number, (iii) signature of the authorized person, (iv) reference number of the document, (v) page number, and (vi) changes made.

**43.6.11 Cleaning and Sanitation**

Cleaning is the complete removal of food soil using appropriate chemicals as recommended. Sanitation is the process of reduction of microorganisms to a safe level. Cleaning and sanitation are the most important aspects of the hygiene program. Detailed procedures have to be established for all surfaces that come into contact with food products as well as for others such as overhead structures, walls, and ceilings. The objective of any cleaning and sanitization program is to remove food soil on which microorganisms can grow and kill the microorganisms present. The cleaning program has to be evaluated for its effectiveness by carrying out appropriate tests. The procedures should specify the cleaning and type of chemical used for each production line.

### **43.6.11.1 Cleaning and Sanitization Steps**

Cleaning and sanitization consists of four steps [9,10]: (i) Physically remove food particles and foreign matter by sweeping, wiping, or prerinsing in cold water. Rinse any equipment containing high protein substances with cold water (hot water will cause proteins to be baked onto surfaces). (ii) Wash equipment in hot water and detergent to remove grease and dirt. (iii) Rinse with hot water again to remove dirt and detergent and air dry. (iv) Sanitize equipment and surfaces with a chemical or by immersing in water at 82°C.

### **43.6.11.2 Cleaning Methods**

Mechanical cleaning, also referred to as cleaning-in-place (CIP), employs automated programs. It does not require disassembly or partial assembly. The temperature and contact times are automatically controlled. Cleaning out of place (COP) allows partial disassembly and involves cleaning in specialized pressurized tanks. Manual cleaning requires total disassembly for cleaning and inspection.

### **43.6.11.3 Sanitization Methods**

Effective sanitization of food product contact surfaces achieves a reduction of contamination level by 99.999% (5 logs) in 30 s [10]. Nonproduct contact surfaces require a contamination reduction of 99.9% (3 logs) using the test organisms *Staphylococcus aureus* and *Escherichia coli*. There are two types of sanitization methods: (a) Thermal sanitization, which involves the use of hot water or steam at a specific temperature for a specific contact period. (b) Chemical sanitization, which involves the use of an approved chemical sanitizer at a specified concentration and contact time.

## **43.6.12 Maintenance and Calibration**

Repair, maintenance, and calibration of plant and equipment are essential for the effective operation of the processes.

### **43.6.12.1 Repair**

When repairs are done by outside contractors, such as electricians, fitters, builders, and plumbers, the standard of service required has to be specified. The organization must ensure that they comply with food hygiene and other requirements and that the work has been carried out to the expected standard.

### **43.6.12.2 Preventive Maintenance**

An effective preventive maintenance program will avoid unnecessary downtime due to machine breakdowns. Suitably qualified and skilled personnel have to be employed to carry out maintenance activities. In addition to the preventive maintenance schedule, the management must respond to breakdowns or unusual occurrences observed or detected by the operators.

### **43.6.12.3 Intrusive Maintenance**

Intrusive maintenance is the activity of carrying out maintenance while production is in progress. When intrusive maintenance is carried out, the safety of the product is not compromised. Adequate precautions have to be taken to ensure that the product in progress is carefully controlled and protected to prevent any contamination as a result of maintenance or change in environmental conditions.

### **43.6.12.4 Calibration**

It is necessary to calibrate measuring equipment to maintain the integrity of the measurements. Calibrations are carried out by certified organizations to enable traceability so that a national standard can be established. The calibration schedule has to reflect the critical nature of the measurement, the environment in which the instrument is placed, and the previous history of deviations. The equipment and instruments that are out of calibration should be promptly removed from use.

### **43.6.13 Pest Management Program**

The most effective method of controlling infestation is by maintaining good housekeeping standards. Control of pests is important to prevent the spread of disease and contamination of product. To maintain the pest management program, it is essential to have appropriately trained personnel or employ a professional pest control organization. A documented pest management program contains the following information: (i) location of baits; (ii) the date when the baits are placed; (iii) record of use (quantity, areas, frequency) of pesticides; (iv) chemicals used for rodents, birds, and insects; (v) record of signs of pest activity; and (vi) procedure for updating the program when the system or building changes.

The program manager ensures that all materials, products, packaging, utensils, and surfaces in contact with food are protected from contamination by pest control substances. An effective system of internal communication is essential so that the production personnel can prepare the plant for pest control. Products and equipment are stored at a distance of 50cm from adjacent walls to facilitate cleaning and inspection for infestation. Site inspections are carried out at regular intervals and records of inspections are maintained as evidence.

Pest control devices include electric fly killers, rodent traps, nest for birds, scaring devices, shooting of birds, baits, and insecticides. The entry of pests can be prevented by (a) careful design and maintenance of buildings to prevent any access, (b) clearing of nesting sites, and (c) providing appropriate screens on doors and windows. A good housekeeping program reduces the risk of infestation. This is achieved by (a) effective waste management, (b) inspection of food products on receipt, (c) proper storage in pest-proof environment, and (d) closing all possible entry points.

### **43.6.14 Foreign Matter Control**

Foreign matter can originate from incoming goods and during processing operations. To minimize the risk of contamination, controls are applied at various locations in the production chain, i.e., supply, manufacturing, packaging, storage, and distribution.

#### ***43.6.14.1 External Sources of Contamination***

The external sources are often associated with contaminants such as pests. Similarly, methods of handling, production, and packaging can give rise to foreign matter, e.g., stones in peanuts and pieces of wood in herbs. Since raw materials are the primary source of contamination, the specifications should be designed to include limits on exclusion of foreign matter.

#### ***43.6.14.2 Internal Sources***

There are several internal sources of foreign matter: (i) building, installation, plant and equipment; (ii) surface coatings and finishers; (iii) maintenance tools; (iv) personnel; and (v) recovered product.

#### ***43.6.14.3 Foreign Matter Control***

Plant, equipment, and buildings are inspected regularly to detect and address any deterioration, soiling, or detachments. During processing, precautions can be taken to minimize the risk of contamination with foreign matter, and such precautions include (i) the use of metal detectors; (ii) sieving, filtering, sifting, washing, inspection, and sorting; (iii) magnetic grids and plates; (iv) keeping containers not in use inverted; and (v) closely monitoring glass breakages and implementing an effective cleanup procedure. Implementing a hazard analysis and critical control point (HACCP) program minimizes the potential for contamination of food with foreign matter, chemicals, and microorganisms.

### **43.6.15 Waste Management**

With focus on environmental management globally, waste and effluent disposal have become important issues for organizations as well as for regulatory bodies. The organization has to ensure that waste is

**TABLE 43.3**

## Guidelines for Managing Waste

<b>Item</b>	<b>Guidelines for Managing</b>
Waste bins	Require covers and located well away from food production and storage areas Easily accessible for removal
Wet refuse	Metal or plastic containers with tight filling lids Collected from the premises daily or if this is not possible, precautions are taken to prevent rotting and pest access Regularly cleaned in suitable washing areas
Dry refuse	Metal or plastic containers with tight-fitting lids or in paper or plastic sacks held firmly with a close-fitting lid
Yard areas	Kept clean and dry Areas designated for storage of waste are included in the cleaning schedule
Waste on the floor	Cleaned immediately
Raw material packaging	Not used for storing food products Empty packaging disposed immediately
Old food containers	Not used for storing chemicals or nonfood items Label contents of the container
Emergencies	Establish emergency response procedures Contact numbers readily available
Environmental spills	Environmental spill kits

controlled so that there is no contamination of the finished product. Contamination could occur from spills, waste plastic drums/containers, harmful chemicals, etc. Food scraps are also a major source of food for bacteria, insects, and rodents. Packaging may be a source of food. A well-planned waste management program with procedures, accountabilities for those managing waste, and accurate records will minimize not only regulatory noncompliances but also chances of contamination. ISO 14001 [11], the Environmental Management System, is an ideal standard to manage the environment. Table 43.3 provides guidelines for managing waste [12].

#### **43.6.16 Reworking Material**

Defective products may be reworked or reprocessed provided the resultant product complies with relevant specifications and is safe for consumption. Procedures should clearly define the standards for reworking or reprocessing. If defective products cannot be reworked, rejection may be the only viable option. All rejected products must be clearly labeled and physically segregated. The manner of disposal depends on the nature of the rejected product, but the organization has to consider (a) the means of recovering the cost, (b) safeguarding the reputation of the company, (c) protecting the consumer, and (d) compliance with regulatory requirements.

#### **43.6.17 Customer Complaint Procedure**

Governments have enforced regulatory controls to ensure the rights of consumers. Customer complaints can be a valuable source of information on food quality and safety. A customer complaint procedure covers: (i) written instructions to deal with complaints, (ii) authority to decide on the extent of the investigation and subsequent corrective action, (iii) documented recall procedure, (iv) process for investigating and responding to the consumer within the shortest possible time, (v) procedure to prevent a recurrence if the complaint is justified, and (vi) regular reviews of complaint reports for trends or any specific process requiring attention. A customer complaint involves the customer, the organization, and

sometimes the regulatory authority. The organization has to ensure that all complaints are resolved promptly to avoid possible harm to the consumer.

#### **43.6.18 Audits, Reviews, and Recall Procedure**

Audits and reviews are used to verify whether the GMP activities are working correctly as planned. Audits are systemic and independent examinations involving on-site observation, interviews with staff involved with operations, and review of records. On-site observation includes the inspection of documents, processes, and records. Records of monitoring activities, corrective actions, audits, and calibration of equipment are checked for compliance with the GMP plan.

Reviews are carried out regularly to ensure that activities of the GMP plan are still relevant. It gives an opportunity for the organization to make any changes in the manner in which food is prepared or handled, leading to continuous improvement.

An effective recall procedure ensures that harmful food products are not available for consumption. The organization should ensure that effective procedures are in place to deal with food safety hazards to enable the complete recall of any defective products rapidly from the market. When a product has been withdrawn because of a health hazard, the recall of other products made under similar conditions should be seriously considered. Recalled products should be held under quarantine until the manner of disposal has been established and the product is disposed of. These are discussed in the chapter on HACCP.

---

### **43.7 ISO 9000 Standard, GMP, and HACCP System**

ISO 9000 standard is a management system for controlling and improving the performance of the organization. In contrast, GMP is a code of practice that controls all aspects of manufacture. ISO 9000 standard provides a management structure for the effective implementation of the GMP program. The revised FDA Medical Devices GMP [13] places considerable emphasis on quality management systems. Quality policy, quality objectives, and management commitment are all essential features of this program [14]. The current regulations were designed after the publication of the ISO 9000 series (1994 version) [15] and 17 clauses have been adopted by the Medical Devices GMP regulations. The HACCP system is a food safety program that provides an effective structure to GMP by providing a system that identifies, evaluates, and controls hazards that are significant to the production of safe food. Prior to the development of HACCP plans, it is necessary to review the existing programs and verify that all good manufacturing practices are in place and effective. The GMP program ensures that HACCP plans focus specifically on critical control points for product safety. If the GMP program is not adequately implemented, the HACCP plan will be less effective in ensuring product safety. ISO 9000 standard, GMP, and HACCP systems are thus complementary to each other, and together they contribute to the production of safe food while making a profit for the organization by minimizing waste and having effective systems.

---

### **43.8 Benefits of GMP**

GMP is a dynamic program that enables the organization to make and maintain quality improvements. The principles of GMP offer greater assurance of food safety and quality through broad-based prerequisite programs and emphasize prevention and control of processes throughout the food chain. They are designed to introduce online process controls that can respond quicker in potentially hazardous situations and provide continuous measures of quality that can uncover problems and fluctuations as they happen and before the product is released. Combined with an effective HACCP plan, the safety of the food being processed can be readily detected and corrected at critical locations before the product is completely processed and packaged. Because of the generic nature of GMP, it is flexible enough to be adapted to different industries. An effective GMP program can offer several benefits to the organization, and some of the benefits are summarized in Table 43.4.



### 43.9 Application of GMP Principles

The GMP program ensures favorable conditions for the production of safe food. In combination with a proper HACCP plan, a robust food safety program can be developed. The generic principles behind the management of GMP activities listed in Section 43.6 can be conveniently applied to all food processing operations. However, control of components, production and processes, packaging and labeling, and storage and distribution may require specific consideration depending on the nature of the food product. These are discussed in the following applications.

**TABLE 43.4**

Benefits of GMP

Benefits
1 Creates awareness of food quality and safety among the staff
2 Increases confidence in product safety
3 Provides a starting point for the HACCP program
4 Recognition internationally
5 Prevents regulatory noncompliances by meeting regulatory requirements
6 Prevents expensive failures
7 Reduces customer complaints and recalls
8 Improves profits

#### 43.9.1 Production of Fresh Produce

The production of fresh produce involves growing, harvesting, packing, processing, and transporting to the facility. The FDA has published [16] eight guidelines to ensure the microbial food safety of fresh produce. (1) Prevention of microbial contamination of fresh produce is more important than corrective actions following a contamination. (2) Growers and packers should adopt good agricultural practices in areas over which they have control while not increasing risks to the food supply or the environment. (3) Human or animal feces in the orchard are a major source of contamination. (4) When water is used for agricultural purposes and processing, its quality must be considered to minimize the risk of contamination. (5) Use of manure or municipal biosolids should be closely monitored to minimize the potential for contamination. (6) Personnel hygiene and sanitation practices in the processing areas play a critical role in minimizing the potential for microbial contamination. (7) Growers and packers must adhere to all regulatory requirements. (8) Define authorities and responsibilities of personnel involved in all operations from growing to transporting of fresh produce.

#### 43.9.2 Production of Unpasteurized Apple and Other Fruit Juice

A variety of pathogenic organisms have been known to cause illness as a result of consumption of juice [17]. The most likely source of contamination is from fruits coming into contact with animal feces, water, containers, workers, or contaminated processing equipment. Therefore, GMP principles have to be applied to all stages from harvesting to the delivery of finished goods.

##### 43.9.2.1 Orchard Management

A means to exclude domestic and wild animals should be used to prevent access of animals into the orchard. In locations where bird roosting is a problem, a means to scare birds should be used. To reduce the risk further, it is advisable to avoid animal manure. Water used to dilute pesticides can be a source of contamination, and therefore orchard owners should be aware of the water quality. Records of pesticide and fertilizer applications have to be maintained.

##### 43.9.2.2 Harvesting Practices

Sound ripe fruits should be picked in clean bins and transported directly to the storage facility, sorting station, or juice processing plant, as appropriate. Drop fruits or rotten fruits should not be used for further processing. All bins should be labeled to show the orchard location, picking date, and picking crew.

##### 43.9.2.3 Transportation

The vehicles used for transportation should be kept clean, and care should be taken to avoid damage and contamination during transport. The vehicle must be inspected prior to loading to ensure cleanliness and suitability.

#### **43.9.2.4 Fruit Storage**

Ideally, fruits should be pressed as soon as possible to prevent the increase in pH that would favor pathogen growth during storage. However, if fruits need to be stored, rapid cooling to 0°C will maintain fruits in good condition. During storage and subsequent operations, fruits should be handled gently to minimize physical damage.

#### **43.9.2.5 Fruit Sorting and Cleaning**

Inspection for sorting should be done in a clean, dry, well-lit environment and decayed, damaged, or otherwise spoiled fruits should be removed to prevent contamination of juice.

Fruit cleaning is done by effective washing, brushing, and rinsing. Food-grade sanitizers can be used for washing and sanitizer levels are monitored during use. Sanitizers are rinsed from fruits unless otherwise instructed by manufacturer's instructions. The water used for washing and rinsing should be free from pathogens and maintained at least 5°C warmer than the temperature of fruits. Wash and rinse water should not be recycled, and records of water quality have to be maintained in the facility.

#### **43.9.2.6 Fruit Inspection and Processing**

Processing apples in cold storage should be kept between 0°C and 4°C or at the recommended atmosphere and temperature for a variety.

Pressing, filling, and sealing areas have to be enclosed to prevent access to pests. The processing areas should be separated from areas where fruits are sorted and washed. Appropriate filter cloth and tubing should be used in production, and tubing should be sanitized and cleaned before commencing the operations. Pomace residue is disposed of after each day's production.

### **43.9.3 Production of Fermented Dry and Semidry Sausage Products**

Dry sausages are chopped or ground meat products with a pH of 5.3 or less and dried to remove 25%–50% of the moisture. Semidry sausages are dried to remove 15% of the moisture. In their manufacture, special attention is paid to the microbiological condition of the products [18]. Testing requirements for *E. coli*, *Listeria* sp., *Salmonella* sp., and *S. aureus* are part of GMP.

#### **43.9.3.1 Raw Material Treatment**

Because of potential microbiological contamination, a strict, comprehensive sanitation program is necessary. Control program begins at the source of raw products, and the sanitization procedures must ensure that containers shipping raw products to the factory, including cartons, boxes, tankers, and trucks, are kept clean.

#### **43.9.3.2 Processing**

During slaughter and processing, product flow must prevent cross-contamination between raw and finished product. Possibilities of cross-connection, including human, equipment, water, air, or piping arrangements, should be investigated to eliminate potential cross-contamination. pH and time-temperature are essential controls for fermentation and direct acidulation, and these are maintained at levels that inhibit the growth of microorganisms.

Separate wash areas have to be established for raw and ready-to-eat (RTE) products, and they should be located where clean RTE equipment does not cross raw meat areas of the plant.

#### **43.9.3.3 Slicing and Packaging Equipment**

Complete mechanical disassembly is required to allow thorough cleaning and prevent contaminants from accumulating. All food contact surfaces have to be cleaned and sanitized daily. During production and breaks, the moisture level of the environment needs to be carefully controlled. Protective covers on control panels, motors, equipment, and other food contact surfaces can be a source of contamination and should be cleaned regularly. Heat shrinking equipment, including exhaust ducts, should be cleaned and sanitized daily to avoid spreading contamination from water and steam to packaging lines.

### 43.9.4 Poultry Processing

Poultry processing includes the processing of poultry, poultry parts, and other edible materials from poultry that have not yet been treated in any way to ensure their preservation [19]. They are chilled or frozen and intended for human consumption.

#### 43.9.4.1 Inspection and Sorting

Different domesticated birds should be processed separately to protect against the risk of cross-contamination. All poultry should be subjected to ante- and postmortem inspection as required by regulations or established protocols. All unfit poultry should be removed, segregated, and disposed of appropriately.

#### 43.9.4.2 Washing and Other Preparations

After evisceration and inspection, carcasses are washed in clean water. Wash water should not be recycled. The water used during the preparation, handling, packing, and storing of poultry carcasses, poultry parts, and other edible material should be potable.

#### 43.9.4.3 Preparation and Processing

All operations leading to the finished product and packing should be carried out in a timely manner to enable rapid handling of consecutive operations that would prevent contamination, deterioration, spoilage, or the development of infectious or toxigenic microorganisms.

Bleeding and blood collection, scalding, plucking, and evisceration should be carried out under controlled conditions to prevent any contamination. Bleeding equipment, scalding tanks, plucking machines, and evisceration troughs should be maintained in good condition and cleaned regularly.

Special precautions must be taken with wax-dipped poultry so that set wax and removed feathers fall into suitable containers. Only clean wax should be used for wax dipping. Reclaimed wax should not be reused unless it has been heated to 80°C for at least 20 min. Before reuse the wax is skimmed, washed, and filtered.

#### 43.9.4.4 Cooling and Refrigeration Requirements

After preparation, carcasses are cooled rapidly to an internal body temperature of 4°C or less. When cutting takes place before cooling, it is done within 1 h of slaughter. Immediately after cutting, the parts are stored at 4°C. When cutting is done after cooling, the internal body temperature is not allowed to exceed 10°C.

Poultry carcasses, poultry parts, and other edible material are stored in an environment that prevents deterioration and mold growth. They should be regularly inspected and used in strict rotation.

#### 43.9.4.5 Ice-Pack Containers

The ice used in ice packing should be made from potable water and should be manufactured, handled, stored, and used so as to prevent contamination. When poultry carcasses are ice packed in barrels or other containers, they are wrapped in plastic or other suitable material to protect them from contamination. The barrels and containers should have holes to permit the water to drain out and must be covered. Wooden barrels or containers should not be used for this purpose because wood can be a source of contamination.

---

## References

1. cGMP Resources, Resources, Retrieved March 3, 2004 from <http://www.cgmp.co/resources.htm>
2. New Zealand Institute of Food Science and Technology, *Food Industry Guide to Good Manufacturing Practice*, New Zealand Institute of Food Science and Technology (Inc.), Auckland, 1999, p. 5.
3. K.G. Anderson and J.R. Blanchfield, *Food and Drink Good Manufacturing Practice: A Guide to Responsible Management*, 3rd Edition, Institute of Food Science & Technology, London, 1991, p. 7.

4. D.R. Hills, Establishing Waste Reduction Benchmarks and Good Manufacturing Practice for Open Mold Laminating, Retrieved March 25, 2004 from <http://www.p2pays.org/ref/01/00372.pdf>
5. E.F. Greenberg, FDA wants more 'current' Good Manufacturing Practices, *Packaging Digest*, Retrieved February 20, 2007 from <http://www.packagingdigest.com/Legal/1002legal.php>
6. New Zealand Institute of Food Science and Technology, *Food Industry Guide to Good Manufacturing Practice*, New Zealand Institute of Food Science and Technology (Inc.), Auckland, 1999, pp. 39–97.
7. K.G. Anderson and J.R. Blanchfield, *Food and Drink Good Manufacturing Practice: A Guide to Responsible Management*, 3rd Edition, Institute of Food Science & Technology, London, 1991, pp. 13–16.
8. Food and Drug Administration, Part 110—Current Good Manufacturing Practice in Manufacturing, Packing or Holding Human Food, Retrieved March 30, 2004 from [http://www.access.gpo.gov/nara/cfr/waisidx\\_01/21cfr110\\_01.html](http://www.access.gpo.gov/nara/cfr/waisidx_01/21cfr110_01.html)
9. New Zealand Institute of Food Science and Technology, *Food Industry Guide to Good Manufacturing Practice*, New Zealand Institute of Food Science and Technology (Inc.), Auckland, 1999, pp. 53–55.
10. Arizona Department of Health Services, Food Equipment Cleaning and Sanitizing, Retrieved April 2, 2004 from [http://www.hs.state.az.us/phs/oe/fses/food\\_eq\\_cl\\_san.htm](http://www.hs.state.az.us/phs/oe/fses/food_eq_cl_san.htm)
11. Australia New Zealand Standard, ISO 14001:1996, Environmental Management Systems—Specifications with Guidance for Use, Standards New Zealand, October 21, 1996.
12. New Zealand Institute of Food Science and Technology, *Food Industry Guide to Good Manufacturing Practice*, New Zealand Institute of Food Science and Technology (Inc.), Auckland, 1999, pp. 83–84.
13. Food and Drug Administration, 21 CFR Parts 808, 812 and 820, Medical Devices; Current Good Manufacturing Practices (cGMP); Final Rule, October 7, 1996.
14. J.E. Carter, Quality policies—key to GMP compliance, *Pharmaceutical Technology* 22: 102 (1998).
15. Australia New Zealand Standard, ISO 9001:1994, Quality Systems—Model for Quality Assurance in Design, Development, Production, Installation and Servicing, Standards New Zealand, August 1, 1994.
16. Food and Drug Administration, Guide to Minimize Microbial Food Safety Hazards for Fresh Fruits and Vegetables, Retrieved October 14, 2004 from <http://www.cfsan.fda.gov/~dms/prodguid.html>
17. Canadian Food Inspection Agency, Code of Practice for the Production and Distribution of Unpasteurized Apple and Other Fruit Juice/Cider in Canada, Retrieved October 5, 2004 from <http://www.inspection.gc.ca/english/plaveg/protra/codee.shtml>
18. American Meat Institute Foundation, Good Manufacturing Practices for Fermented Dry & Semi-Dry Sausage Products, Retrieved October 8, 2004 from <http://www.amif.org/FactsandFigures/SAUSAGE.pdf>
19. Codex CAC/RCP 14-1976, Recommended Code of Hygienic Practice for Poultry Processing, Retrieved February 20, 2007 from [http://siweb.dss.th/standard/Fulltext/codex/CXP\\_014E.pdf](http://siweb.dss.th/standard/Fulltext/codex/CXP_014E.pdf)



# 44

## *Commercial Considerations: Managing Profit and Quality*

Anne Perera and Gerard La Rooy

### CONTENTS

44.1	Managing Profit.....	1032
44.1.1	Business Environment .....	1032
44.1.1.1	Management Structures and Practices .....	1032
44.1.1.2	Changing Role of the Food Profession.....	1033
44.1.2	Commercial Requirements.....	1034
44.1.2.1	Revenue, Cost, and Assets .....	1034
44.1.2.2	Fixed and Variable Costs.....	1035
44.1.2.3	Price, Margins, and Costs .....	1036
44.1.3	Technical Impact on Business .....	1037
44.1.3.1	Impact on Revenue .....	1037
44.1.3.2	Impact on Costs .....	1038
44.1.3.3	Impact on Assets .....	1038
44.1.3.4	Impact on Cash .....	1039
44.1.4	Technical Responsibilities .....	1039
44.1.4.1	Research and Development.....	1039
44.1.4.2	Quality Assurance .....	1041
44.1.4.3	Other Technical Services .....	1042
44.2	Managing Quality .....	1042
44.2.1	Quality Scene .....	1042
44.2.1.1	Importance of Quality .....	1042
44.2.1.2	Origins, Sources, and Causes of Quality Problems .....	1043
44.2.1.3	Quality Culture and Processes .....	1043
44.2.2	Understanding and Reducing Variability .....	1044
44.2.2.1	Costs Associated with Variability .....	1044
44.2.2.2	Managing and Reducing Variability .....	1045
44.2.3	Managing Customer Complaints .....	1048
44.2.3.1	Assessing the Situation .....	1048
44.2.3.2	Developing a New Approach .....	1049
44.2.3.3	Recording, Monitoring, and Reporting.....	1050
44.2.3.4	Improving Process.....	1052
44.2.3.5	Management Commitment .....	1053
44.2.3.6	Consistency Is All-Important .....	1053
	References .....	1053

We were delighted to be invited by the editor to write this last, but in our view by no means the least important chapter of the first edition of this handbook. Now, with this second edition, we remain confident that the book will continue to make a significant contribution to the international food preservation profession and be used by many in the field. While the handbook is essentially a technical publication

written for technical people, it is appropriate to keep in mind the book's fundamental purpose, which can be stated in its simplest form as "caring for the customers." Putting caring for the customers in a practical context, we can say that organizations must have the intent and appropriate capability to develop and produce wanted and risk free products and services. When we say risk free, we mean not only risk free for the customer, however important that requirement is, but it is also very much applicable to the organization's objectives. Indeed, the proper management of risk is particularly about not endangering the continuity of existence of the business enterprise. In determining the content of this chapter, we had to make a choice between breadth and depth. We felt it was more appropriate to go for breadth to provide the reader with a reasonable range of topics so that anyone interested can undertake further reading as they see fit.

When working on the structure of this chapter, we were mindful of the thrust of this part of the handbook—enhancing food preservation by indirect approach. For us, this means that the food preservation profession must be prepared to go beyond their traditional fields of expertise and see their contribution in a much wider content. It also reinforces our view that irrespective of the method of preservation employed, the selection of the method must not only be based on sound technical grounds, but also on appropriate business considerations. Please note that while the chapter as a whole was compiled by us jointly, the specialized sections were contributed by either Anne or Gerard individually.

---

## **44.1 Managing Profit**

### **44.1.1 Business Environment**

For a business to be successful, it must have sound processes, up-to-date and profitable products, and well-managed services. Successful companies, besides being highly competent in their respective technical fields, also need to be very skilled in business management. While this need for business skill is generally accepted, it should be appreciated that there has been a fundamental change in what business management ought to be about. Many business structures have changed from "tall" to ones with few levels and with fewer "functional silos." This means, for example, that food preservation is becoming more fully integrated with marketing, production, and customer service. To illustrate the points made so far, we will look at the case of "flat-Earth thinking" versus "round-Earth thinking."

#### **44.1.1.1 Management Structures and Practices**

Peter Scholtes of Joiner Associates has likened the traditional style of management with the belief that the Earth was flat. He explains that people who believed that the Earth was flat would ask questions like: "What happens when I sail my ship until I reach the edge?" Once science proved that the Earth was round, a sudden shift in thinking occurred, and questions about falling off the edge became irrelevant.

What this means is that organizations, which are flat-Earth based (and we believe that a considerable number still are), will need to undergo some revolutionary rather than evolutionary change. The revolutionary changes required will make their current management practices irrelevant, redundant, and in many cases quite wrong. However, once the big change in thinking has been accepted and the practices implemented, we can employ the process of evolutionary change for further development and improvement.

To illustrate how structures and practices have become irrelevant or inappropriate, we can construct a simple comparative table (Table 44.1). Looking at the table, we can observe that some of the items are either one way or the other, e.g., directive driven or direction led. Other items are more continuous (tall versus flat). If we consider the complete table, however, there can be little doubt that we are dealing with a dichotomous situation—the traditional versus the new. Expecting "traditional" organizations to gradually change into "new age" ones is a bit like expecting an ocean liner to start sprouting wings and gradually change into a 747 aircraft. Putting it another way, we sometimes need revolution before there can be evolution. These changes in business have had and continue to have a profound effect on the food preservation profession, and practitioners need to be fully aware of these changes lest they be left behind with their flat-Earth thinking.

**TABLE 44.1**

The Changing Business Environment

Traditional (Flat Earth)	New Age (Round Earth)
1. Directive driven	1. Direction (vision) led
2. Management through power and position	2. Management through earned influence
3. Controlled by rules	3. Guided by values
4. Compliance	4. Commitment
5. Corporate/center/CEO focused: Executives near CEO Tall (many levels)	5. Customer focused: Executive near staff Flat (fewer levels)
6. Vertical functional silos	6. Integrated value chain
7. Functional specialists	7. Integrated resources
8. Internal customer is the next level	8. Internal customer is the next process in the value chain
9. Emphasis on control: Centralized decision making Risk aversion Reliance on experience Imposed results Low rate of improvement	9. Emphasis on improvement: Dispersed decision making Experimentation Learn to learn Agreed achievements Fast rate of improvement
10. Industrial relations	10. People development
11. Huge differences in reward levels	11. Smaller differences in reward levels
12. Staff are data gatherers (information for the center)	12. Staff are information users (information for the coalface)
13. Information belongs to the selected few	13. Information sharing and openness

**TABLE 44.2**

Conventional and Business-Aligned Approaches

Conventional	Business Aligned
Narrow view	Wider role
Advisory	Accountable
Product emphasis	Customer focus (external and internal)
Production driven	Market led
Cost unawareness	Profit appreciation
Quality control	Quality management
Risk avoidance	Quantified assessment of exposure
Functional skills	Business knowledge
Functional/personal objectives	Company/organization objectives

**44.1.1.2 Changing Role of the Food Profession**

The science of food preservation too is undergoing much change. It should be appreciated, however, that we are not just concerned with technological change. On the contrary, we believe that the major changes and challenges facing the profession will continue to come from the changes to the business environment referred to earlier.

Consequently, there is a need for the profession to become more and more integrated with the totality of the business. What this means in practice is that professionals have to assume a wider role and accept greater responsibility for the success of the companies that employ them. To identify the specific change in emphasis which we

believe is necessary to ensure the profession’s further effectiveness and relevancy, it is useful to employ another comparative table (Table 44.2). While most items in the table are fairly self-explanatory, the question of functional (personal) objectives versus company objectives warrants some examination. For many technical personnel, the main work focus tends to be on objectives that are very close to the person in question and on the quality of the actual process. “Doing things right,” it could be called. For example, a product development professional will have expectations about the quality of the development process itself and what is to be ready by when. He or she will also be concerned with the robustness of data and with the appropriateness and quality of any tests and experiments. It is our view that this almost exclusive focus on functional objectives is not sufficient in today’s commercial environment, let alone in tomorrow’s. What is required of the new-age professional is, in addition to technical competence and focus, a marked increase in appreciation of company objectives, overall results, and the commercial “levers” that drive them. We can term this demand for additional understanding and emphasis ensuring



that we “do the right things.” The important point is that unless we do the right things as well as doing things right, our efforts may be ill-directed and as a consequence largely wasted.

### 44.1.2 Commercial Requirements

Most food preservation technologists are bound to be employed in a commercial enterprise of one type or another at some time during their working lives. Even for those with entirely academic careers, there is still the issue of continuing demand for greater commercialism in the management of academic institutions. Consequently, it is important for professionals in any technical field to have a reasonable appreciation of business fundamentals as well as the commercial and other expectations of the enterprise for which they work. A proper understanding of these fundamentals and expectations will enable the technologist to contribute to the organization’s success to the fullest extent possible.

The work of technical staff can profoundly affect, both positively and negatively, the financial performance of most organizations. Sound technical developments can open up new business opportunities, lead to greater efficiency, and secure a stronger position in the marketplace. Misdirected efforts, on the other hand, are likely to result in increased and unnecessary complexity, higher costs, poorer asset utilization, and lower profitability. It is perhaps worth noting that profit is not a dirty word, but is in fact a vital prerequisite for growth and long-term success. Profitability is a must if funds are to be available for investment in new products, processes, and technologies.

#### 44.1.2.1 Revenue, Cost, and Assets [4]

Of the many factors that impact on a business’s financial performance, the following are the most critical:

- Revenue
- Costs
- Assets employed

Food professionals can and often do have a very significant impact on all three. Before looking at how this may come about, it is important to understand the way the factors affect overall financial performance and their interrelationship.

##### 44.1.2.1.1 Revenue

Assume there are two firms, X and Y, with annual sales revenues of \$50 million and \$40 million, respectively (Figure 44.1). Which is the better performing company? In terms of sales revenue the answer is firm X, but more information is needed to determine which is the sounder firm, e.g., costs.

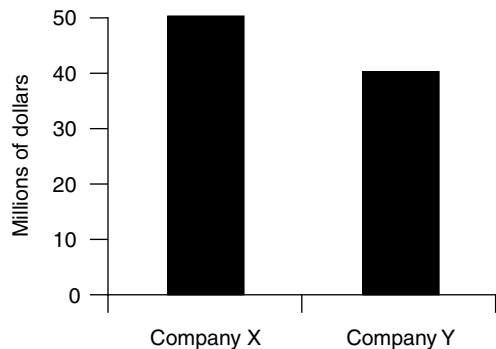


FIGURE 44.1 Revenue companies X and Y.

##### 44.1.2.1.2 Costs

Assume the costs are \$40 million for company X and \$20 million for company Y (Figure 44.2). With a margin of \$10 million for firm X and \$20 million for firm Y, which is the better company? Looking at just the margin, it is clearly firm Y, but before we award them the annual prize for performance we need to look at the resources employed to generate the \$20 million.

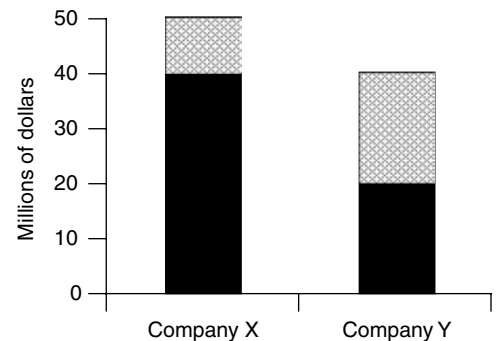


FIGURE 44.2 Costs companies X and Y.

##### 44.1.2.1.3 Assets Employed

When assessing financial performance, the resources are considered to comprise the assets employed by

the organization, such as buildings, land and plant (fixed assets), and funds tied up in inventories and debtors (current assets—these can be turned into cash reasonably quickly). If the total assets used by the companies are \$20 million for X and \$50 million for Y, which now shows the better performance?

$$\text{Performance} = \frac{\text{Margin}}{\text{Assets}} \times 100\%$$

$$\text{Performance for company X} = \frac{\$10}{\$20} \times 100\% = 50\%$$

$$\text{Performance for company Y} = \frac{\$20}{\$50} \times 100\% = 40\%$$

### Observations

For company X:

The lower margin may mean the business deals in low-value items. Lower use of assets could mean quick turnover of stocks, calculated as follows:

$$\frac{\text{Annual sales}}{\text{Average inventory value}}$$

If, for example, half of the \$20 million were tied up in inventories, the stock turnover per year would be  $50/10=5$  times per annum. The low asset figure may also mean low plant book values (plant could be obsolete). The old plant may be costly to operate and hence be the reason for the low margin.

For company Y:

This company appears to deal in higher-value items. The higher margin may attract competitors to move in on the market. Stock turnover (again assuming half of the assets are tied up in inventory) would be  $40/25=1.6$  times per annum. The company may have a more modern plant, which may mean a lower cost structure and hence higher margin.

### 44.1.2.2 Fixed and Variable Costs [5]

Many actions and decisions made by technical staff have a significant effect on costs. It is therefore important for the decision makers to appreciate the difference between fixed and variable costs. Let us consider the basic definitions first.

#### 44.1.2.2.1 Fixed Costs

In brief, fixed costs are those costs not affected by changes in output. An example of a fixed cost would be the cost of monthly machine rental, which we would incur no matter what the output. Note, however, that any production beyond machine capacity would mean a step in our fixed costs, i.e., cost of renting another machine. Also, the passage of time can lead to increases or decreases in fixed costs. Consequently, the earlier statement on fixed costs needs some qualification: fixed costs are not affected by changes in output within a specified output range, and fixed costs remain constant within a specified time period.

#### 44.1.2.2.2 Variable Costs

Variable costs vary with changes in output, and the unit cost is generally deemed to be constant, although that is by no means always the case in reality. For example, bulk purchase may bring the cost per unit down, or in other cases the cost of additional units may be higher than the average. When comparatively small quantity ranges are considered, however, variable costs may be taken as truly variable, i.e., the cost per unit stays constant and total variable cost can be found by multiplying the unit costs by the quantity used.

#### 44.1.2.2.3 Fixed versus Variable Costs

In many business situations, including the technical field, there are often trade-offs to be considered between fixed and variable costs. It is important to have a clear understanding of the difference between

fixed and variable costs as well as the relationship between the two. Assume a company wishes to launch a new product and has been given two different manufacturing proposals.

1. *Proposal 1.* Low fixed cost, high variable cost  
Fixed cost (equipment, etc.) = \$100,000 pa  
Variable (material, labor) = \$10 per unit  
Selling price = \$15 per unit  
Sales volume = 40,000 units pa
2. *Proposal 2.* Higher fixed cost, lower variable costs: the second proposal is more mechanized and hence requires less expensive material and less labor. Fixed costs are consequently \$100,000 higher, but variable costs are lower at \$7 per unit.
3. *Initial comparison.* The two proposals can be readily compared by means of a table (Table 44.3).
4. *Comparing profit and break-even points.* To determine which of the two proposals is better in terms of the data supplied, we need to calculate (a) total profit for the year and (b) the break-even point, i.e., the volume at which total revenue equals total cost. Again the two proposals can be compared (Table 44.4).
5. *Observations.* While proposal 2 is more profitable, proposal 1 is less risky. If sales are evenly spread throughout the year, it would take the first proposal 6 months to break even, while for the second proposal the break-even point would occur at 7½ months. The break-even analysis, while not a sophisticated tool, is quite useful in illustrating the differences between proposals. Take care, however, as in reality fixed costs have a habit of going up (or sometimes down), for example, when needing to rent an extra piece of equipment. Also, variable costs are rarely as linear as assumed here, although as said earlier, they can usually be taken as linear between reasonably small quantity intervals.

#### 44.1.2.3 Price, Margins, and Costs

Before discussing the impact of technical staff on costs, it is necessary to introduce a number of cost-related concepts. The approach to the management of costs in an organization is very much dependent on how costs are viewed—as a starting point or as the end point. Figure 44.3 illustrates different ways of considering costs.

##### 44.1.2.3.1 Traditional Cost Plus

The traditional method of determining a selling price was to add up all direct and indirect costs (e.g., overheads) and add a suitable margin. This approach works when there is little or no competition (e.g., due to import control). Unfortunately, some companies will persist with this approach even when, because of changed conditions, it is no longer appropriate (Figure 44.3, method 1).

**TABLE 44.3**

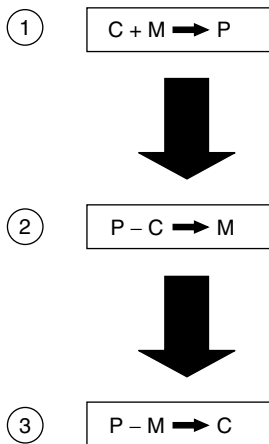
Comparing Fixed and Variable Costs

	Proposal 1	Proposal 2
Fixed cost pa (\$)	100,000	200,000
Variable cost per unit (\$)	10	7
Selling price per unit (\$)	15	15
Sales volume units pa	40,000	40,000

**TABLE 44.4**

Comparing Profits and Break-Even Points

	Proposal 1	Proposal 2
Sales revenue = quantity × selling price	600,000	600,000
Fixed cost	(100,000)	(200,000)
Variable cost = quantity × variable cost per unit	(400,000)	(280,000)
Profit	<u>100,000</u>	<u>120,000</u>
Contribution margin = selling price – variable cost	\$5	\$8
Break-even point = fixed cost/contribution margin	20,000 units	25,000 units



**FIGURE 44.3** C, M, P relationships, where C=cost, M=margin, and P=price.

adequate. Since prices are largely beyond the control of the organization and margins must be achieved, the real situation is that:

$$\text{Price} - \text{Margin} \rightarrow \text{Cost}$$

This means that cost is the important element and one that management needs to focus on constantly.

### 44.1.3 Technical Impact on Business

Most managers do not fully appreciate the impact that technical resources have (or could have) on the business in general and on revenue generation in particular. What is more, it is quite likely that the majority of technical staffs are also not completely aware of their contribution to the success of the enterprise. We will look briefly at four classes of impact:

- Impact on revenue
- Impact on costs
- Impact on assets
- Impact on cash

#### 44.1.3.1 Impact on Revenue

In many cases, the technical staff provide the lifeblood for the organization's future, as all products and processes require constant renewal and replacement if there is to be security of future revenue.

##### 44.1.3.1.1 Types of Impact

When considering the impact that technical professions have on an organization's revenue generation, it is necessary to appreciate that there are short- and long-term impacts: (i) Short-term impacts (tactical or current revenue): projects coming under this heading are generally concerned with existing products and processes or new products within existing competencies (e.g., product line extensions, product improvements, and ingredient substitutions). (ii) Long-term impacts (strategic or future revenue): these are concerned with new technology and products outside current competencies.

##### 44.1.3.1.2 Conceptual and Analytical Soundness

An important point to note is that a project can be analytically correct but conceptually wrong at the same time. In other words, the arithmetic is fine but the underlying premises are flawed. Technical staff should seek advice if required and take particular care in (a) setting out all underlying assumptions clearly, (b) defining the scope of the project accurately (including in some cases any matters that, while outside the project,

#### 44.1.2.3.2 Market Price

In a free market, the price is set by that market and has nothing to do with costs or margins. The change from "tradition" to "market-price" method took place in some countries during the 1950s and 1960s, but in many other countries during the 1970s and early 1980s. The principal effect of the change to a market (and as a rule lower) price was reduced margins, since costs were generally considered as "fixed" (Figure 44.3, method 2).

#### 44.1.2.3.3 Required Margins

The squeeze on margins meant that many organizations experienced unsatisfactory returns on their invested capital. However, to attract new capital, returns and hence margins must be adequate.

may still be relevant), (c) listing all agreed expectations in terms of both magnitude and probability, and (d) assessing the economies of the proposal soundly and presenting the justification in a logical manner.

#### *44.1.3.1.3 Reliable Tangible Cost and Benefit Information*

Proposals need details about the various types of costs and benefits, that is, one-off costs and benefits (e.g., purchase of new packaging printing dies and the sale of some piece of equipment made possible by the project) and ongoing costs and benefits (e.g., increased production energy costs and reduced labor costs).

#### *44.1.3.1.4 Intangible Cost and Benefit Information*

It is important to include all intangibles, even if it is difficult to estimate dollar figures. It may in fact be better not to try to show dollar figures, as it often leads to much argument and debate. Make sure, however, that all intangibles are clearly identified and list them separately, preferably at the end of the presentation. Examples of intangibles include:

- Enhanced brand image
- Improved competitive position
- Increased customer satisfaction
- Improved staff morale
- Adverse impact on the quality of life of people in the neighborhood
- Waste generated by proposed process not suitable for recycling

The point to remember is that intangibles should not be dismissed as of little importance because of our inability to put precise dollar figures on them. On the contrary, with many projects, the intangibles (the “soft” issues) are often more important than the “hard” (dollar) issues.

#### *44.1.3.1.5 Technical Revenue Contribution Reporting*

When it comes to ongoing management, technical function professionals may assist their cause by ensuring that the revenue contribution is duly reported on and acknowledged (Table 44.5).

### **44.1.3.2 Impact on Costs**

Technical staff can and often do have a very significant impact on costs. Frequently, the technical professionals are the members of an organization who make the decisions that affect not only the total costs of a development, but more particularly determine the balance between fixed and variable costs. Understanding that balance is important especially when dealing with new proposals. Some examples are outlined below.

1. Increased R&D costs: deciding to spend more on R&D (higher fixed cost) to gain lower product costs (variable costs).
2. Higher specification levels: insisting on a higher specification than may be necessary is likely to push up the costs of production (higher variable costs). The decision can also result in higher fixed cost if, for example, the close tolerances specified require a more expensive piece of equipment than would be the case with a less demanding specification.
3. Product line extension: every time a new product is added to a company’s product portfolio, it is likely that production-run sizes and frequencies will be affected (usually adversely). Consequently, the setup cost (a fixed cost) has to be recovered over a smaller number of units, thus driving up the total cost per unit.

### **44.1.3.3 Impact on Assets**

We have already considered briefly the importance of the assets employed when assessing a company’s performance. As with costs, the actions and decisions of the technical professional can have considerable impact. Again some examples can illustrate the position.

**TABLE 44.5**

Sample of Technical Revenue Contribution Report

	Year to Date	Budget	Variance	Last Year	Estimate for Remainder of Year
Net sales \$ "old" revenue					
Net sales \$ "new" revenue					
Total net sales					
% New revenue of total net sales					
Technical costs					
% Technical costs of new revenue					

#### 44.1.3.3.1 *Current Assets*

When launching a new product, a company invariably needs to increase its working capital (current assets), for example, (a) extra funds tied up not only in finished goods but also in new ingredients and components and (b) additional funds required to finance the increased debtors resulting from the sales of the new product.

#### 44.1.3.3.2 *Fixed Assets*

Technical developments often lead to companies investing in new processes and equipment. It is important that this new investment does not dilute the company's financial performance, that is, the return on the new investment should not be less than the norm for that particular industry and preferably be better than the company's current average return. Exceptions may occur when companies invest in new processes and facilities for strategic reasons, provided of course that this fact is understood and accepted by the decision makers.

#### 44.1.3.4 *Impact on Cash*

Companies may be profitable but still fail if they run out of cash and cannot pay their bills. While a proper discussion on cash management is beyond the scope of this chapter, it should be noted that profit and cash are not the same things. It is important that the technical professional has some understanding of that difference, since again technical decisions can have considerable impact. (If you wish to pursue this topic, we suggest you talk to the financial staff in your organization about how organizations absorb and release cash. You may also like to find out about cash flow evaluations.)

#### 44.1.4 *Technical Responsibilities*

Companies employ food professionals to carry out specific roles in various technical areas, such as research and development, quality assurance (QA), and technical services.

In these roles, food professionals have the opportunity to put into practice what they have learned during academic training. Professional development, recognition, and experience gained are part and parcel of the rewards.

##### 44.1.4.1 *Research and Development*

Research and development, commonly referred to as R&D, is a vital activity for any progressive company. Failure by companies to develop new products and processes will not only hamper growth, it may lead to the decline and possible demise of the organization. We believe that this is especially so in the case of food companies.

Food companies depend on their technically qualified professionals to carry out the functions of new product/process developments to move their companies forward. This is achieved by identifying products/processes that have the potential to increase the profitability of the company. The R&D function

of a food company must thus be closely associated with both marketing and production functions. New product ideas are generated by companies through:

- Study of market trends
- Brainstorming
- Requests from customers
- Competitive pressures

Ideas that show promise and fit the company's criteria are passed on to the R&D department for development.

#### 44.1.4.1.1 Product Development Processes and Procedures

The product development process will depend on the type of company, the nature of the business, the company philosophy, and management style. Some companies have a formal procedure in place to ensure that product/process development is carried out systematically, while others may develop new products in an informal manner.

As a rule, a more formal approach gives better and more reliable results, especially in larger companies. The main steps comprising a product development procedure are shown in Figure 44.4.

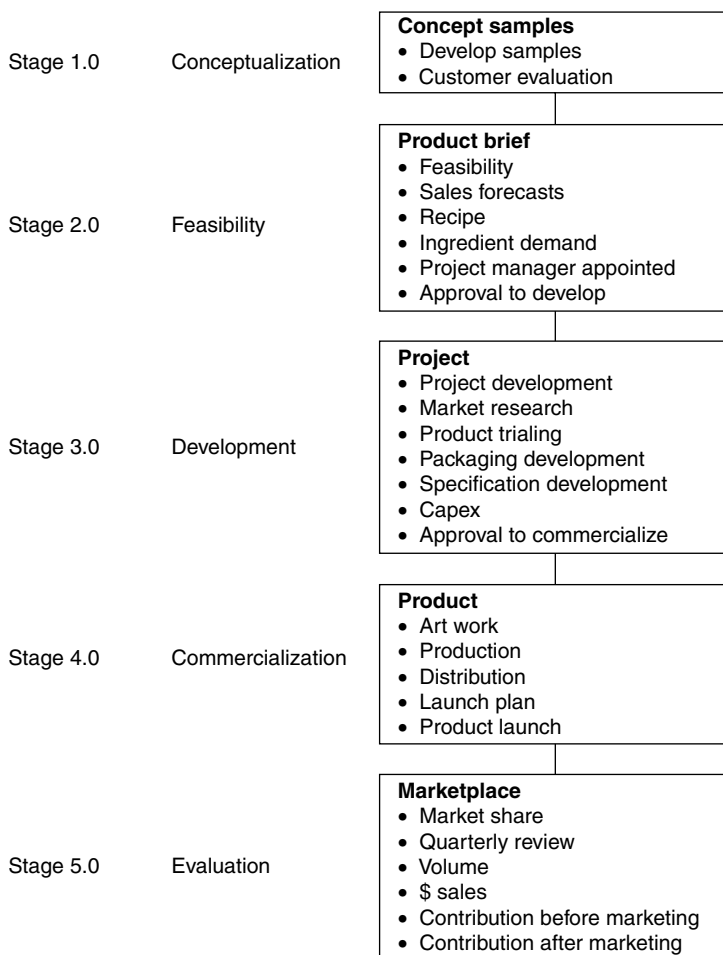


FIGURE 44.4 Main steps in product development procedure.

Since developing new products is generally an expensive process, companies must subject all new ideas to rigorous screening and prioritizing to ensure that only those ideas with a high probability of success are approved for development. Also, if a partially developed product is no longer likely to meet expectations, it is better to abandon the idea. The costs incurred must be considered as “sunk costs,” and it would be incorrect to spend any more resources. Another point to note is that products developed at considerable expense principally as technical projects but without a proper input of marketing requirements or with insufficient understanding of business objectives, are unlikely to see the light of day. It is possible to prevent such situations by more formal approach in managing the product-development process.

#### *44.1.4.1.2 Product Development Considerations*

Food professionals as members of an R&D team need to have access to information on new product launches in their specific product categories, preferably from around the world, and set up a product-awareness library. They also need to build their own networks with other professionals in the areas of ingredients, packaging, and analytical laboratories related to product quality food composition, and nutrition. Some large food companies have their own technical centers and in-house support services, while others have to depend on outside facilities to provide such services. In dealing with organizations and personnel outside their own company, food professionals involved especially in new product development, need to be aware of the importance of maintaining confidentiality about commercially sensitive information.

Professionalism in R&D requires practitioners to be familiar with rules and regulations pertinent to their area of work and to abide by them at all times. There are no universal food regulations, and it is the responsibility of the food professionals to know the food regulations of their own country as well as the relevant information on regulations of countries importing their products. In this regard, it is important to understand that different countries have different labeling requirements. While the artwork on packages is normally handled by the marketing department, R&D personnel have to take an active role in providing or approving information that is to be shown on the labels of new products.

In addition to new product development, most food companies carry out continuous product improvement through ingredient substitution or process improvement. No matter which R&D activity food professionals are involved in, they need to be aware of the cost implications and try to avoid unnecessary expense. Developing product specifications is a function that R&D staff must carry out with essential input from the marketing and production departments. Such teamwork is necessary to ensure that the marketing expectations are matched by the production capabilities of the company. Once the specifications are developed and approved, they become the basis for QA, which is another area in which food professionals are employed.

#### **44.1.4.2 Quality Assurance**

The primary role of the QA function is to assure that the quality of the products processed and marketed by the company is of the standard required, in other words, that the products are made in accordance with specifications. It is the responsibility of the QA function to ensure that the raw materials received comply with the standards that have been mutually agreed to by the company and the supplier. If the incoming material is not of the agreed quality, the QA department should intervene and take the necessary action. In most cases, this means rejection of the incoming material. Only in exceptional circumstances should reworking be considered. In any case, reworking is as a rule a costly exercise, which should be avoided if possible.

During processing, samples are generally taken for routine checks of quality. Specific quality parameters of the product in question are recorded on QA forms, which are held in a file. This enables the product history to be traced back if required. Such records also provide valuable process performance information and may serve as evidence when responding to consumer complaints or in the event of a product recall. Staff involved in QA must take all precautions and all necessary steps to prevent any problems from occurring. Such problems may be related to the contamination of a product with undesirable substances, be they of physical, chemical, or microbiological origin. Programs such as hazard analysis critical control point (HACCP; see Chapter 42) have become increasingly important to food companies in monitoring and preventing potential problems. It should be noted that hazards are not confined to just the actual food products. On the contrary, manufacturing hazards can and do impact significantly on the environment.



#### **44.1.4.3 Other Technical Services**

R&D and QA are not the only technical functions of food professionals. For example, those with interests in sales and marketing can become technical sales personnel or product managers. Their skills are valuable in providing technical background on the products, ingredients, and equipment/machinery that they sell or market. In addition, they are in a good position to relate to a client company's R&D and QA staff, who generally are the customers for such goods and services.

Although cost is often a considerable factor in decision making, in many instances the decision of a client company to purchase from one supplier and not the other is determined by the type of technical service provided. Leading ingredient companies employ food professionals to work closely with their clients and often produce tailor-made ingredients, products, or equipment to suit their specific needs. Some food professionals from supplier companies work in close association with the product development staff of client companies in developing new products. In such cases, the client company may negotiate exclusive rights for the ingredient and or the production system for a given period of time. In situations where new ingredients are not yet permitted by the regulatory authorities of some countries, the supplier companies or their agents in the countries concerned may intervene and often succeed in obtaining approval. Food professionals play an important role in preparing submissions for approval, which often require substantial technical input by way of research and supporting evidence on the safety of the ingredient in question.

---

## **44.2 Managing Quality**

### **44.2.1 Quality Scene**

Over the last few decades, there has been a considerable increase in the understanding and acceptance of the importance of quality. The technical professional needs not only to be in tune with this change in thinking, he or she must also take a proactive stance because it often is the technical area in which one finds the origins of both quality successes and failures as well as the remedies.

#### **44.2.1.1 Importance of Quality [1]**

To assess the nature (or the customer's perception) of quality, it is useful to employ Dr. Kano's model of quality, which identifies three different aspects of quality: basics, satisfiers, and delighters.

##### *44.2.1.1.1 The Basics*

The basics are the fundamental aspects and features of a product (or service) that are considered to form part of its inherent functionality. Basics are all those ordinary things that the customer expects to be up to the mark (e.g., size, flavor, and functionality). The important point to realize is that failure to meet the basics usually makes the customer angry.

##### *44.2.1.1.2 The Satisfiers*

Satisfiers are those aspects and features that make the customer feel happy about his or her purchase. They are important to the customer but are only effective if the basic requirements have been met.

##### *44.2.1.1.3 The Delighters*

Delighters are those extra features or services that clearly exceed the customer's expectations. They can however be counterproductive if the basics are not met. A faulty product coupled with a delighter will make the customer cynical.

*Points to Note.* The following are worth noting: (i) most customer complaints are likely to be concerned with the basics; (ii) remember, failure to meet the basics tends to make the customer angry; and (iii) the quality model is very relevant in all areas of management, be it marketing, product development, or production.

### **44.2.1.2 Origins, Sources, and Causes of Quality Problems**

Quality problems usually manifest themselves when a customer complains or when QA staff detect an out-of-specification product. To find the root causes of complaints, we need to dig deep. It is a bit like peeling an onion—each layer needs to be removed before the next one is revealed.

#### *44.2.1.2.1 Origins*

First, we need to identify the three fundamental origins of quality failures. These are: (i) faulty design (design mistakes and specification shortcomings), (ii) faulty execution (faults in manufacture or assembly and shortcomings in delivery or service), and (iii) incorrect use (intentional or unintentional).

It should be noted that many, if not most, of the quality failures experienced by firms are the result of faulty design, even though they appear to have their origins in faulty execution. For example: (i) In many cases, firms settle on design features and specifications without having a proper understanding of what the operational systems are capable of delivering in a consistent manner, e.g., unrealistic mix tolerances. (ii) Quite often designs will carry within them the seeds of faulty execution: parts that can be assembled incorrectly, awkward design that will encourage assembly shortcuts, unwarranted production complexity, and lack of standardization.

#### *44.2.1.2.2 Sources*

Once we have identified the fundamental origin of failure, we can look for the source by identifying each specific process, operation, or procedure involved with the failure. In most instances, we will need a concise description of the process or operation concerned. When faulty execution is the origin of failure, two types of sources are possible: those within the organization and hence under our direct control (internal) and those outside of the organization, usually because of faulty materials or services (external). Even where the source is external, there will always be some contributing internal factor. For example: (i) When a supplier is responsible for poor-quality components (external source), we also need to identify the appropriate internal contributing factors (e.g., inadequate or unrealistic purchasing specification, price-only purchasing policy, or undue emphasis on credit). (ii) Management of the inward goods acceptance process is inadequate. (iii) The line staff is unable to react quickly when faulty materials are encountered.

#### *44.2.1.2.3 Causes*

While having an understanding of the origins and sources of quality failures is a necessary first step, there is little we can do about prevention and improvement unless we also understand the cause of our problems. All quality problems arise from a failure to meet customer expectations. Most of the time a failure is the result of variability in one or more processes. While the question of process variability is discussed in more depth below, it is worth noting here that understanding the variability of processes is an essential prerequisite to reducing quality problems. To reduce the variability in processes we need to appreciate what causes it. There are two different types of causes of variability: common causes and special causes.

Common-cause (statistical) variability includes the random variation in results or performance, which is due to the system itself rather than any specific action. This variation is considered “normal” for the particular system. As common-cause variability is an inherent feature of the process, improvement in process performance is dependent on making changes to the system. Pep talks to staff, exhortations, or slogans are quite useless in this situation. Unless the actual system is changed for the better, variability will not decrease. Special causes are those extraordinary and often one-time events that cause a temporary increase (or decrease) in variability. There is no need to change the system of operation to avoid variability due to a special cause.

### **44.2.1.3 Quality Culture and Processes**

It is important to note that in the end improved quality can only come about if there exists in the organization an all-pervading quality culture. This means not quality one day and quantity the next. It means that the entire organization should be quality aligned with regard to management practices and systems. In addition, there needs to be an organization-wide agreement to regard quality issues principally as opportunities for improvement rather than as problems to blame on someone. In practice, it means that

all quality issues need to be viewed in terms of origin, source, and cause (as outlined earlier) and that there are in place sound, standard, and accepted process-improvement techniques in the company. It is important to appreciate that it is only when the underlying processes are improved in a permanent fashion that one can expect a sustainable increase in quality performance.

#### 44.2.2 Understanding and Reducing Variability [2,3]

It is very important for technical staff to thoroughly appreciate the effect process variability can have on business performance. There are two principal impact areas:

1. At the time of product and process development, the R&D specialist has a major role in ensuring that potential process variability is understood and minimized.
2. During production, the QA professional can do much in introducing the right monitoring systems and training so that operational staff can learn about process performance and subsequently work to reduce its variability.

##### 44.2.2.1 Costs Associated with Variability

To introduce how variability can reduce quality and performance and drive up costs, we will use as an example the costs involved in maintaining a painted house. The lasting quality of paint on a wooden house provides a classic demonstration of the effects of variability in performance and the costs associated with it.

###### 44.2.2.1.1 Variability in Paint Performance

Have you ever had the unenviable task of preparing a clapboard house for repainting? You must have wondered as you toiled away why some of the paint had flaked away while other bits stubbornly remained in spite of vigorous wire brushing and scraping. You may also have seen houses that obviously have not been repainted for several decades yet still have some paint showing. While some of the remaining paint would be easy to peel off, other remnants would still be difficult to remove.

###### 44.2.2.1.2 Costs of Paint System Performance

Consider the case of a house with painting costs over the first 35 years of its life as shown in Table 44.6. If there was no variability in the performance of the paint, all the paint would last exactly the same length of time. Remember that some small parts of the paint system remain intact for several decades, so if all the paint performed as well as the best parts a 35-year life could be possible. If there was absolutely no variability, we could predict the life of the paint system with total confidence. We could plan the job of

**TABLE 44.6**

Costs Associated with Variability in Paint Performance

				\$ per m <sup>2</sup> (Labor and Material)
A. When new: three-coat finish				8
B. After 7 years: making good spot failures, spot prime, and two coats				7
C. After 14 years: making good spot failures, spot prime, and two coats				12
D. After 21 years: complete repaint including sand back, refill prime, and coat				12
Paint life costs:				
Year	Job	\$	Accumulated	
0	A	8	8	
7	B	7	15	
14	C	7	22	
21	D	12	34	
28	B	7	41	
35	C	7	48	

painting (Job A) with precision, as on a given day (known in advance) all the paint would fall off the house. In addition, there would be no need for scraping and sanding. The table shows that the difference in per square meter cost between the two scenarios is \$32 (\$48–\$16), which is the cost due to the variability in performance of the paint system. Even if we take a more modest paint life of 21 years, the cost would still be considerably less. What the example shows very clearly is that there are costs associated with variability and that high variability means high costs.

#### 44.2.2.1.3 Other Costs

While the dollar costs associated with high variabilities are very important, they are in the majority of cases reasonably self-evident and quantifiable. But there can be other important costs.

1. *The costs of a poor reputation.* Without any doubt, the most important of all costs is the detrimental effect variability has on one's reputation in the marketplace. If there is one thing that annoys customers more than anything else, it is a lack of consistency. Nothing will damage a reputation more quickly and more permanently than a high level of variability in the quality of products and services.
2. *Staff-related costs.* These costs are associated with pride of workmanship and staff morale. High variability in our processes is likely to cause many internal problems, such as scheduling difficulties, quality-of-fit problems, and reworking—all of which are bound to lead to reduced job satisfaction and, as a consequence, to poorer performance.

#### 44.2.2.2 Managing and Reducing Variability

In many organizations, process variability is given insufficient weight, resulting in quality problems and subsequent loss of customer confidence. It should also be appreciated that variability reduction is not something that happens by itself. On the contrary, it requires focused management attention, sound systems, and properly trained staff.

##### 44.2.2.2.1 Reasons for Variability in Performance

To understand why we often experience quite large variability in performance, we need to identify the various sources. In the case of the painted house, they can be divided into four categories:

*Timber surface.* The original timber surface is likely to be a source of considerable variability in the performance of the paint system. Variation in surface finish, moisture, and resin content will all contribute to that variability.

*Materials.* If you buy paint supplies from a reputable source, you can be fairly certain that the variability will be low. However, in spite of a manufacturer's best efforts to keep paints uniform, there will always be some variability. This is likely to be greater if a particular paint comes from more than one batch. The upshot is that some of the paint will perform better than average and some worse.

*Application.* The way the paint is applied provides an enormous potential for variability in performance. Using a brush, for example, results in large differences in coat thickness. Even employing different painters for different parts of the job is likely to lead to an increase in variability. In addition, one must take into account the varying painting conditions, such as air temperature and humidity, which will increase variability in performance.

*Position.* This is a critical factor in how long a paint system is going to last. Areas of paint exposed to wind, rain, and full sun are likely to fail earlier than those protected by porches or eaves.

##### 44.2.2.2.2 Understanding Variability

When advocating the reduction of variability, we should remember that most if not all regular company reporting is about reporting averages. For example, most standard costing systems are designed to report

average monthly performance against some predetermined (average) standard. Averages by their very natures will mask variability, so while we may aim to meet a particular better average performance, we could be unwittingly steering our ship in the wrong direction.

Take, for instance, a case involving three teams with the average daily outputs over a month as shown in Tables 44.7 and 44.8: On the face of it, Team B is the best, and if we did not look further we could conclude that Teams A and C should pull their socks up and work like Team B. If we were to dig a little deeper, we would learn that the highest and lowest daily figures were as shown in Table 44.8. If we also learned that production in excess of 1200 units per day was considered to be too hard on the equipment and that such high rates of throughput tended to lead to quality problems, which is now the better performing team? In terms of output variability, it is Team A, because it turns in the most consistent performance. Perhaps Teams B and C could learn something from Team A about how to avoid very low throughput days, while Team A could be encouraged to talk to Team C about what they do to reach 1200. As for Team B, the first aim needs to be “no production beyond 1200 units per day” with the subsequent focus on reducing throughput variability further by improving low-day output.

**TABLE 44.7**

Case Study of Three Teams: Average Output

	Team A	Team B	Team C
Average (units/day)	1000	1100	1000

**TABLE 44.8**

Case Study of Three Teams: Highest and Lowest Output

	Team A	Team B	Team C
Highest daily	1100	1500	1200
Lowest daily	900	700	800

#### 44.2.2.2.3 *Best, Worst, or Average Performance*

In the case of the painted house, it is quite obvious that the worst performing parts of the paint system determine the painting costs over the lifetime of the house. The best performing parts are those difficult-to-remove bits that we strike when trying to get the house back to bare wood. While the average performance of the total paint system could be 20 years, is this useful information? After all, would a paint system with an average life of say 25 years necessarily be a better proposition? What about if in the latter case the performance range was 5–45 years (rather than 7–33 years)? Averages can be highly dangerous statistics, and while politicians and other public figures can be masters at using and misusing averages, in business we see much misunderstanding as well.

#### 44.2.2.2.4 *Accumulation of Effects*

Because customers experience the final result of the various processes, one needs to be aware of the potential accumulation of the variability effects of all processes. Considering the case of the painted house again, the accumulation of effects can be looked upon as a lottery. Some areas are unlucky, in that they have a combination of all of the worst aspects, while others have a combination of the best with the best. Between the two extremes, we have a multitude of combinations, which provide either better or worse-than-average performance. As a consequence, we see some early failures occurring in quite unexpected places (e.g., away from the weather), while other areas of paint continue to perform well in spite of being much more exposed.

If we apply this concept of accumulation of effects to several business processes, we can see why some customers can be “unlucky” when it comes to customer service. Take, for instance, the following situation. We supply goods to customers and have the following performance statistics: stock availability 90%, order accuracy 90%, and invoicing accuracy 90%. Table 44.9 shows the average effect on our customers (assuming the three statistics are independent of each other). We can observe that we have on average one “unlucky” customer per 1000 orders who experiences the “worst with Worst with worst” combination. They are the ones who are likely to tell their friends “Do not deal with that firm, they cannot do anything right.” Using this example, it is clear why some people end up with a “lemon” of a car, while other buyers of the same model are very satisfied. In the business of food preservation, the problems are very much the same.

TABLE 44.9

Customer Performance Statistics	
Problems	Percentage
None	72.9
One	24.3
Two	2.7
Three	0.1
Total	100

#### 44.2.2.2.5 Improvement Opportunities

The important point to note is that process variability will, generally speaking, not reduce by itself. On the contrary, it requires special effort and attention to detail. There are many techniques available, but any detailed discussion is beyond the scope of this chapter. We will therefore confine ourselves to identifying opportunities to reduce variability and to the principles underlying improved process performance.

#### 44.2.2.2.6 Minimizing Potential Variability

It is by seeking to minimize variability in the first place that the technical professional can make a significant contribution to the ultimate performance of the product. During the development phase there are many opportunities for this, but unfortunately the opportunities are seldom taken advantage of to their full extent. Some examples include:

- Understanding the capability of the processes and developing the product and specifications accordingly. There is little point in specifying a process to  $\pm 1^\circ\text{C}$  when the actual variability is  $\pm 2^\circ\text{C}$ .
- Looking for opportunities to standardize materials and processes wherever appropriate. Undue and unnecessary diversity does invariably lead to higher variability of output.
- Making the definition of the process control methods and information required part of the product or process design and specification.

#### 44.2.2.2.7 Minimizing Operational Variability

Assuming we have taken all important steps to minimize potential variability, we must now put in place the systems and procedures necessary to understand and minimize operational variability. The main point is that processes must be monitored and properly understood before changes and adjustments are made, as shown in Figure 44.5.

#### 44.2.2.2.8 Benefits of Reducing Variability

In spite of what intuition may sometimes tell you, reducing variability through systematic improvement of the process will invariably lead to reductions in cost, increased customer satisfaction, and other benefits.

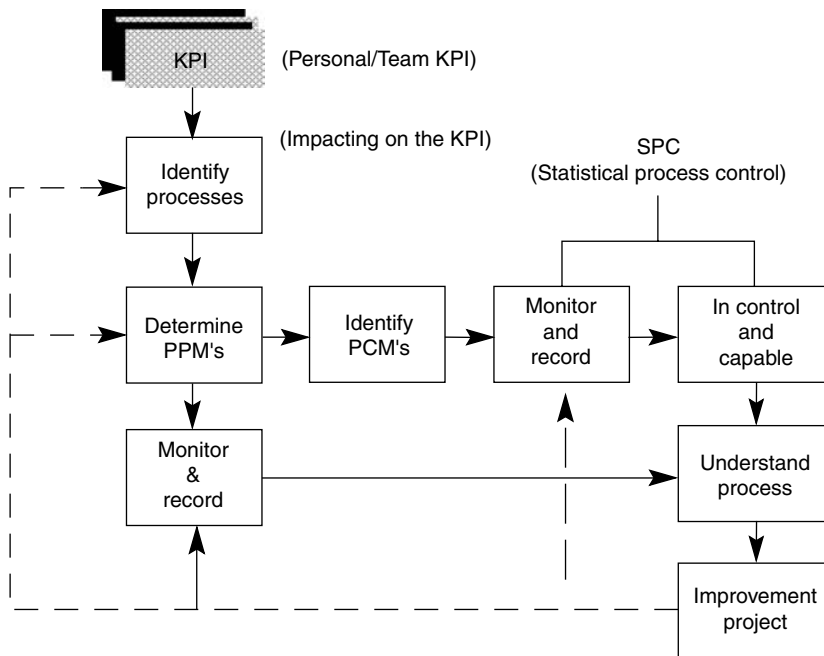
*Lower costs.* The ability to set a lower target weight when packing a valuable product and being sure that the customer is not shortchanged.

*Happier customers.* Lack of consistency in products and services will harm company's reputation. Customers will be happy when their expectations are understood and satisfied. If you aim to exceed their expectations, be confident that you can exceed them in a consistent manner. Make sure the statement "exceeding customer expectations" is not just a slogan. Raising customers' expectations without the possibility of consistent delivery is bound to have an adverse affect on your business.

*Inventory savings.* Reduced product variability also makes possible savings in inventory. Improved consistency is a prerequisite for just-in-time (JIT) management. It should be remembered that "out-of-spec" products as a rule become a liability to the company, requiring "write-downs" or additional expense or both.

*Increased capacity.* Processes that are under proper control as a rule operate better with resulting increases in output.

*Happier staff.* Reduced process variability means fewer production problems, less panic, and fewer complaints, all of which help staff to feel better about their jobs and themselves.



**FIGURE 44.5** Systematically reducing variability. KPI=key performance indicator, PPM=process performance measure, and PCM=process control measure.

### 44.2.3 Managing Customer Complaints [1]

It is no secret that many companies do not like receiving customer complaints. They are usually seen as embarrassing, troublesome, and possibly frivolous. But we need to manage them well if we are to maintain good customer relations and turn the complaints into opportunities for improvement. To do this we need to (a) ensure we have the correct culture, (b) design the right system and operate it properly, and (c) carry out proper analysis, report, and follow-up.

#### 44.2.3.1 Assessing the Situation

##### 44.2.3.1.1 Correct Culture

Before one designs and implements any system it cannot be overemphasized how important it is to have the correct culture in place. This means treating a customer who complains as a person doing us a considerable favor. The customer is telling us something about our product or service that we probably did not know but ought to. We should accept that many other customers may have similar feelings about our product or service except that they do not bother to complain. Instead they decide not to buy the product again, as well as telling their friends about their unhappy experience.

Points to remember include:

- Are customer complaints principally seen as a nuisance?
- Who is responsible for managing complaints, and who actually handles them?
- Are complaints dealt with by some junior and possibly untrained person?
- Is it possible for customers to get “shoved around”?
- Are we sure that complaints are handled professionally every time?
- Are complaints seen as important?
- A good check on the perceived importance of customer complaints is to look at how they are reported. Are they included in the monthly report? If yes, are they hidden somewhere at the back, or do they form part of the important summarized results?

#### 44.2.3.1.2 Do We Have the Right System?

Once an organization has accepted that customer complaints are extremely important and introduced the necessary managerial and cultural changes, it should ensure that it also implements a sound customer complaint-management system and related procedures. The most important requirement is confidence that the system and procedures will ensure the appropriate response in every situation. In addition, the procedures should ensure a good standard of recording to provide the organization with a proper source of information for any required follow-up and subsequent improvement of the processes. If they are not up from scratch, redesign them.

Points to consider include:

- Is there in place an up-to-date written procedure for dealing with complaints?
- Does the procedure ensure an appropriate response in every case?
- Can we be confident that all (or at least most) of our customers are happy with the way the organization deals with complaints?
- Does the system ensure proper recording, monitoring, and reporting?
- Do the complaints lead to improvements?

#### 44.2.3.2 Developing a New Approach

If an organization considers customer complaints to be important, it must be prepared to develop, implement, and maintain a sound management system.

##### 44.2.3.2.1 Defining the Rules

A crucial part of any new customer complaint-management system is defining the rules that are to govern its operation. It is important to identify all likely incidents and link each one of them to an appropriate response. A useful tool for doing this is a decision table, which will enable the organization to define precise rules for action in each case. To construct a decision table it is necessary to identify all situations (conditions). These would include product or service faults (e.g., wrong weight, minor contaminant, serious contaminant, life-threatening fault, rude salesperson, and poor after-sales service) and disposition of the customer (e.g., happy, neutral, angry, and threatening action). It is also necessary to agree what is the appropriate response (e.g., days to respond and call on the customer).

##### 44.2.3.2.2 Complaint Classification

Once all conditions have been identified, a complaint classification table can be constructed. The classifications are to identify a predetermined response for every situation. Table 44.10 shows five different responses denoted by the letters A, B, C, D, and E. If all of the conditions, actions, and appropriate response rules have been defined, there will be a basis for a sound and reliable procedure.

**TABLE 44.10**

Complaint Classifications

Complaint	Customer Disposition			
	Happy	Neutral	Angry	Threatening Action
Wrong weight	A	A	B	C
Minor contaminant	A	A	C	D
Serious contaminant	B	C	D	E
Life threatening	E	E	E	E
Rude salesperson	A	B	C	D
Poor service	A	B	C	D



**TABLE 44.11**

The Response Rules

	Customer				
	A	B	C	D	E
Action	A	B	C	D	E
Days to respond	3	1	1	1	1
Standard letter	Y	N	N	N	N
Special letter	N	Y	O	N	N
Vouchers	2	3	N	N	N
Call on customer	N	O	Y	Y	Y
Retrieve product	N	O	Y	Y	Y
Recall procedures	N	N	N	O	Y
Advise Q/A manager	N	O	Y	Y	Y
Advise GM	N	N	O	Y	Y

**TABLE 44.12**

Responsibilities for Customer Complaints

Functions or Actions	Staff Responsible			
	Customer Services Clerk	Customer Manager	Area Sales Representative	Dispatch Clerk
Complaint receipt	R			
Fill out form	R	A		
Determine classification	A	R		
Initiate response	A	R		
Call on customer			R	
Send replacement				R

R=response; A=assist.

#### 44.2.3.2.3 *Appropriate Responses and Operation*

Once there is agreement on the complaint classifications, the appropriate responses need to be linked to them. Table 44.11 shows the general idea: by determining the complaint classification the person dealing with the complaint can select the correct response every time. If required, another column ("else") can be added to meet any situation that does not fit A, B, C, D, or E.

#### 44.2.3.2.4 *The Responsibility Matrix*

To help define who is responsible for what, one can employ a responsibility matrix. The idea is to relate people and required actions in a single table (see Table 44.12).

#### 44.2.3.3 *Recording, Monitoring, and Reporting*

To turn quality problems into improvement opportunities, it is essential to record and monitor all relevant information. Depending on the size of the organization and the number of complaints, anything from a simple manual system to a sophisticated computer system may be required. For most organizations a modest PC-based system will prove the best solution. However, irrespective of whether the system is computer-based or not, the general principles are essentially the same: the system must provide for ease of monitoring, analysis, and subsequent reporting.

##### 44.2.3.3.1 *Origins, Sources, and Causes*

In an earlier section, we looked at the origin, sources, and causes of quality problems. It is important that the customer-complaint system and procedures and the staff operating it are capable of differentiating

No.	Origin			Use	Source'	Cause	
	Design	Execution				Description of source	Common
		Int	Ext				
001	✓				Specification limits beyond machine quality.	✓	
002		✓			New operator		✓
003	✓				Scraps of packing material can occasionally enter the product.	✓	
004			✓		Outside contractor working on machine failed to clean grease off weighing bucket.		✓
031							
032							
Total	10	19	2	1		22	10

FIGURE 44.6 Origins, sources, and causes of complaints.

between origins, sources, and causes. If there is no such distinction, it is unlikely that the management of customer complaints will lead to process improvement and a subsequent reduction in quality failures. Of particular concern is that many organizations not appear to appreciate the difference between common- and special-cause quality problems.

In organizations where the difference between common and special causes is not understood, one often finds major changes to systems and procedures because of some out-of-the-ordinary failure. Also, failures due to common-cause variability may be explained to customers as one-time problems that are unlikely to recur.

44.2.3.3.2 Recording Details

For a customer complaint system to be effective, the proper recording of all necessary details is essential. Figure 44.6 shows an example of monthly recording of the details of origins, sources, and causes. Similarly, other information such as complaint classification and the nature of the complaint (basic, satisfier, or delighter) should be recorded. An action and improvement log should also be maintained.

44.2.3.3.3 Analysis and Reporting

If a good recording and monitoring system is in place, subsequent analysis and reporting can be tailored to fulfill particular needs. A company may settle for a simple form of analysis and reporting, in which case the task is fairly straightforward. In contrast, it may decide to be quite sophisticated and opt to employ advanced analytical techniques and reporting methods. Whatever approach is adopted, it is crucial that the analysis and reporting have some real meaning leading to improvements in performance. The following points should be kept in mind:

*More sophisticated reports.* The information collected should allow one to identify possible correlations, for example, between (a) complaint classifications and origins; (b) particular types of complaints such as contamination and origins; (c) origins and causes; and (d) reductions in complaints and improvement projects. (A word of caution. When embarking on a program of more sophisticated analysis, be sure to employ a suitable numerate employee. Basic conceptual errors can make any analysis at best useless, at worst dangerous.)

*Action/improvement reporting.* The main source of information for this will be the action and improvement log, although information may also come from other sources such as customers and operations. Control of dates is important (e.g., date items first raised, original agreed completion date, and latest agreed completion date).

*Place in company reporting.* Once the analysis to be done and reports to be produced have been determined, it is necessary to decide on the content of the regular monthly report. It is also necessary to decide who will be responsible for the reporting and where the report should be included.

#### **44.2.3.4 Improving Process**

Ensuring the correct customer response in every case is a crucial feature of any complaint system. This part of the system is “outward focused,” which is very important to maintaining good customer relations. However, to improve performance and hence the reputation as a quality company, it is necessary to have an inward focus as well.

Customer complaints can provide valuable information about underlying weaknesses. However, the important point to note here is that what shows up as customer complaints are effects or results and that to prevent or lessen complaints we must identify and improve the underlying processes. It may be said that this statement is rather obvious; however, it is a fact that many organizations do not bother to search out the processes involved with the object of affecting permanent improvements. It should be remembered that most management reporting (not just customer complaints) is about results with little or no appreciation of what are the relevant processes.

##### *44.2.3.4.1 Managing Improvements*

A system of recording and monitoring will identify many areas where improvements are both possible and necessary. Improvements should be managed in a structured and somewhat formal manner. Some points to remember include:

- The customer complaint system, if managed correctly, will provide factual information as a basis for improvement rather than emotive assertions, such as: we always have the wrong weights; we never deliver on time; or our product is full of contaminants.
- The emphasis needs to be on prevention and improvement rather than culprit-finding. It must be quite clear whether problems are common cause (systems) or special cause types.
- Generally speaking, improvements in results or a reduction in complaints, comes about by focusing on and improving the underlying processes.
- It is necessary to exercise patience. Improvement of the process will take time, but if done properly the improvement will be permanent and hence very worthwhile.

##### *44.2.3.4.2 Identifying Processes*

If it is working correctly the system will identify the process that needs to be improved, e.g., staff induction/training, design procedures, specification development, production tolerances, or process monitoring. Of particular interest are complaints that have their origin in product design and development. Design is the start of the sequence of operation, and hence any failings in design will affect all subsequent processes.

As mentioned earlier, a large number of firm’s quality failures have their origin in faulty design, although they may, at first sight, appear to have their origin in faulty execution. If products are designed and developed with problem prevention in mind, many subsequent quality failures can be avoided. Important areas to consider include: (i) standardization of ingredients where appropriate, (ii) simplifying processes where possible, and (iii) designing intermediate tests into the process, including statistical process control.

Once a reasonable quantity of data has been collected, it should be possible to identify the specific processes giving rise to particular complaints, such as: (i) ingredient quantity control, (ii) mixing, and (iii) cooking. Note, however, that to find the real source of the problem, considerably more investigation is usually needed. For example, complaints may be traced to the cooking process, but the real source may be insufficient operator training, out-of-date manuals, or a lack of maintenance of the temperature-control equipment.

#### **44.2.3.5 Management Commitment**

As should by now be clear, the proper management of customer complaints requires much thought and effort as well as attention to detail. In addition, considerable management support and involvement is required, especially if improvements are to be made. It really comes down to the following questions: (i) Is the organization serious about customer's expectations and company's reputation? (ii) Is it prepared to make the effort to turn problems into opportunities? Even if not all problems can be solved, we can still benefit from some of the concepts and techniques discussed, provided the organization knows where it wants to go and ensures a consistency of signals.

#### **44.2.3.6 Consistency Is All-Important**

Consistency of signals to both customers and staff is vital if one is to succeed in reducing complaints. For example, do not allow quality policies and procedures to be overridden arbitrarily by edicts from above. Be sure to provide ongoing support for complaint system's operation and resulting improvement projects. To ensure that output from the system is given due recognition, it is important to (a) check company's current culture and practices, (b) decide what the current shortcomings are and what changes are warranted, (c) obtain agreement from affected managers and staff to develop a plan of action, and (d) implement and enjoy the improvements in performance. The process of improving organization's performance and enhancing its reputation as a quality company is all about doing many things better. Focusing on customer complaints is a good starting point.

---

## **References**

1. G. La Rooy, How to handle customer complaints, *NZ Business Magazine*, April (1993).
2. G. La Rooy, Variability in business—hidden impediments or latent opportunities, *NZ Business Magazine*, February (1995).
3. G. La Rooy, Opportunities in waiting, *NZ Business Magazine*, March (1995).
4. G. La Rooy, Getting a grip on costs, *NZ Business Magazine*, February (2000).
5. G. La Rooy, Breakeven revisited, *NZ Business Magazine*, August (1997).



---

# *Index*

---

- Acetaldehyde formation, 646
- Acetic acid bacteria, 219
- Acidulants, 542
- Active packaging, 12, 14, 320, 883
- Adaptation, 461
- Adverse atmosphere injury, 40
- Adhesive forces, 390
- Adhesion testing, 396
- Aeration, 106
- Aging, 189
- Agitating retorts, 592
- Air blast freezing, 654
- Air drying, 407–410
- Air makeup systems, 590
- Alcoholic beverages, 221
- Alginates, 145
- Alkaline phosphatase (ALP), 573
- Amorphous structure, 388
- Angle of repose, 399
- Animal physiology
  - metabolic reactions, 174
  - muscle structure, 174
  - postmortem, 174
  - rigor mortis, 174
- Antibiotics, 181
- Antifreeze proteins, 649
- Anticaking agents, 399
- Antimicrobial agents
  - green chemicals, 238
  - how safe, 11
  - milk, 209
  - nisin, 232
  - organic acids, 179
  - packaging, 909
  - risk-benefit, 11
- Antinutritional factors, 16
- Antioxidants
  - activity, 280
  - analysis, 278
  - applications, 10, 276, 422
  - definition, 264
  - health benefits, 265–266
  - herbs and spices, 272
  - legal permitted levels, 278
  - mechanism of action, 266
  - natural, 268
  - necessary, 264
  - structure, 267
  - synthetic, 267
  - tocopherols, 268
  - types, 264, 492
- Ascorbic acid oxidation, 140, 579, 746
- Aseptic processing
  - energy, 620
  - equipments, 609
  - filling, 612
  - packaging, 611
  - quality, 616
- Audit, 993, 1025
- Avoid recontaminations, 8
- Bacterial growth
  - mesophilic, 7
  - minimum temperature, 7
  - optimum temperature, 7
  - psychophilic (cryophilic), 7
  - thermophilic, 7
- Bacteriocin, 246, 251
- Bactofugation, 210
- Baking, 698
- Ball drying, 410
- Barley, 76
- Batch cooker, 629
- Batch retorts, 588
- Beer, 221
- Belt freezing, 655
- Best-before date, 5
- BET-monolayer, 339, 343, 352, 456, 463
- Biopreservatives, 10
- Biostrips, 573
- Biotechnology, 15
- Biotic factors, 159
- Blanching
  - applications, 417
  - equipment, 630
  - frozen products, 647
  - microwave, 698
  - ohmic heating, 747
- Blow molding, 920
- Bound water, 639
- Bread, 228
- Browning
  - dried products, 421
  - enzymatic, 25
  - factors affecting, 464
  - maximum region, 465
  - non-enzymatic, 8
  - oxidative, 140
  - types, 464
- Bruise, 25, 30, 51–52
- Butylhydroxyanisole (BHA), 267
- Butylhydroxytoluene (BHT), 267

- Cabinet freezing, 654
- Caking
  - crystallization, 398
  - definition, 396
  - factors, 397, 426
  - index, 399
  - measurement, 399
  - moisture absorption, 398
- Canning. *See* Sterilization
- Cans
  - aluminum, 605
  - collapsible, 605
  - composite, 605
  - three pieces, 604
  - tin plate, 604
  - two piece, 605
- Capillary condensation, 451
- Capillary force, 406
- Cartons, 581
- Carvone, 244
- Cascading water retorts, 592
- Case hardening, 423
- Cavitation, 716
- Cheese, 223, 245, 375, 724
- Cheese ripening, 224
- Chemical treatments
  - decay control, 64
  - disinfestation, 64
  - nitrogen trichloride, 65
- Chilled storage
  - based on hurdle technology, 882
  - fish, 166
  - meat, 177, 189
  - methods, 189
- Chilling injuries, 38–39, 52, 58
- Chlorine, 9, 55, 142, 167, 178
- Chlorogenic acid, 43
- Chlorophyll degradation, 33
- Chlorine dioxide, 9, 167
- Chung equation, 93
- Cinnamaldehyde, 243
- Circular-tube type crystallizer, 679
- Clarification, 210, 371
- Cleaning, 9, 59, 125, 208, 964, 1021
- Climacteric fruits, 28–30
- Climate zone, 38
- Climatic factor, 20
- Clorants, 546
- Coacervation, 535
- Coating, 59
- Cocrystallization, 538
- Cohesion testing methods
  - blow test, 392
  - cyclone, 393
  - fluidization, 393
  - optical probe, 392
  - propeller-driven, 392
  - thermal mechanical compression test, 395
- Cohesive forces
  - electrostatic forces, 390
  - liquid bridges, 389
  - mechanical interlocking, 390
  - solid bridges, 389
  - testing, 392–395
  - van der Waals forces, 389
- Cold chain, 652
- Cold shortening, 182
- Cold spot, 745
- Color retention, 426, 600, 644
- Collapse, 424
- Combine harvester, 84–86
- Combined preservation techniques. *See* Hurdle technology
- Come up time, 701
- Compatibility
  - factors, 58
  - groups, 54
- Concentration polarization, 380
- Consolidation, 398
- Continuous cooker, 630
- Continuous pallet sterilizer, 596
- Constant period, 406
- Continuous steam pasteurizer, 574
- Continuous rotary sterilizers, 592
- Control of atmosphere
  - active packaging, 12, 320
  - definitions, 319
  - grains, 117
  - modified atmosphere, 12, 316–319
  - modified humidity, 12, 321
  - packaging design, 321–324
  - passive atmosphere, 12
  - vacuum, 12
- Controlled release
  - biodegradation, 556
  - diffusion, 554
  - fracture, 554
  - mechanism, 552, 553
  - melting activated, 556
  - pressure activated, 554
  - release rate, 553
  - solvent activated, 555
- Controlled ripening, 67
- Convection air drying, 409
- Conveyors
  - bucket elevators, 117
  - en-masse, 116
  - pneumatic, 117
  - shrouded, 116
  - U-troughs, 117
- Cooking
  - dry heat, 626
  - effects on nutrients, 631
  - equipments, 629–631
  - frying, 627
  - heating methods, 628
  - methods, 626–627
  - microwave, 627
  - moist heat, 626
  - purposes, 625
  - slow, 627
  - ultrasound assisted, 727

- Cooling curves, 340–341
- Cooling of milk, 208
- Corn, 77
- Cracking, 424
- Crateless retort systems, 591
- Critical control pint
  - classifications, 986
  - correction actions, 991
  - decision tree, 987
  - determination, 986
  - establishing critical limits, 990
  - hurdle technology, 889
  - identification, 987
  - location, 986
  - procedures, 990
  - pulsed electric heating, 790
- Critical moisture content, 406
- Crust formation, 351, 423
- Crystalline structure, 388
- Cryogenic freezing, 655
- Cryoprotection, 649
- Crystallization
  - above and below glass, 350
  - definition, 398
  - ice, 340
  - nucleation, 340
- Curing, 62, 418, 435, 724
  
- Dean number, 696
- Decision tree, 987, 1000
- Decontamination, 177, 180
- Degumming, 376
- Degreening hormone, 35
- Dehulling, 122
- Dehusking, 126
- Dewaxing, 378
- Dielectric constant, 693
- Dielectric loss factor, 693
- Dielectric properties, 694
- Differential scanning calorimetry (DSC), 344
- Diffusion process, 349
- Dipping pretreatments, 418–419, 648
- Direct-contact freezing
  - conventional, 670
  - definition, 669
  - eutectic freezing, 676
  - ice-crystallization unit, 671–673
  - ice separation unit, 673
  - melting unit, 675
  - refrigerant-brine interactions, 675
  - wash column, 674
- Distilled spirits, 223
- Dormancy, 26
- Dosimetry, 762
- Dough conditioners, 543
- Drip loss, 158
- Drum drying, 410
- Dry brushing, 59
- Drying
  - advantages, 11
  - background, 404
  - cohesion and adhesion, 391
  - curves, 406–407
  - end point, 405
  - energy efficiency, 412
  - equilibrium moisture content, 91–95
  - fundamentals, 405–406
  - grains, 91–98, 350
  - heated air, 95–98
  - heating methods, 405
  - methods, 405–417
  - microwave, 698
  - mode of preservation, 404
  - modified atmosphere, 415
  - natural air, 94
  - ohmic heating, 747
  - osmotic drying, 433–442
  - pretreatments, 417–419
  - principles, 91
  - quality, 420–426
  - state of water, 404
  - ultrasound assisted, 723–724
- D-value, 700, 704, 720, 721, 766
- Dynamic layer growth system, 679
- Dynamic mechanical thermal analysis (DMTA), 346
  
- Edible coatings
  - additives used, 489
  - applications, 496–497
  - coating techniques, 495
  - consumer attitudes, 498
  - creating modified atmosphere, 480
  - effect on water loss, 480
  - keeping structural integrity, 481
  - legal aspects, 497
  - materials used, 481–489
  - mechanism of action, 479
  - minimal processing, 145
  - preservatives used, 491
  - purposes, 12
  - rationale, 478
  - surface preparation, 495
- Edible films, 910
- Electrical conductivity, 744
- Electrical stimulation, 182, 184
- Electricity, use of
  - low electric field, 13
  - microwave heating, 13
  - ohmic heating, 13
- Electroporation, 746, 747
- Electrostatic forces, 390
- Emotional factors, 6
- Emulsification, 489, 528, 729
- Encapsulation
  - basis, 511
  - benefits, 512
  - coating materials, 514–527
  - techniques, 527–542
  - types, 512
- Encapsulation coating materials
  - acetoacylglycerols, 524
  - applications, 542–552



- Encapsulation coating materials (*contd.*)
  - carbohydrates, 514
  - cellulose, 520
  - chitin, 520
  - chitosan, 520
  - corn syrup, 515
  - cyclodextrins, 517
  - exudated gums, 522
  - gums, 521
  - lecithins, 525
  - lipids, 524–527
  - liposomes, 525
  - maltodextrins, 515
  - modified cyclodextrins, 519
  - modified starch, 516
  - proteins, 527
  - seaweed extracts, 521
  - sucrose, 519
  - waxes, 524
- Endoplasmic reticulum, 174
- End point of drying, 405
- Enzyme
  - applications, 768–775
  - effected by water activity, 465
  - encapsulation, 550
  - fish, 168
  - frozen products, 646
  - high pressure, 838–840
  - inactivation, 355, 727
  - irradiation, 768
  - legal aspects, 776
  - lysozyme, 11
  - lytic enzyme, 11
  - major problems, 775
  - meat, 188
  - microwave effects, 699
  - milk, 206
  - lipid oxidation, 262
  - reaction, 25, 41, 354
  - ultrasound assisted, 727
- Equilibrium distribution coefficients, 434
- Equilibrium moisture content, 91–95
- Equilibrium state, 340
- Essential oils, 241–243
- Ethylene formation
  - adverse effects, 36
  - classification, 35
  - pathways, 138–139
  - rate, 34
  - removal, 66–67
- Eutectic freezing, 676
- Evaporation, 747
- Evaporative cooling, 56
- Exhausting, 598
- Explosive puff drying, 409
- Extrusion, 532
  
- Falling period, 406
- Fermentation
  - benefits, 218
  - definition, 216–217
  - history, 216
  - microorganisms used, 218–221
  - ohmic heating, 247
  - sourdough, 228
  - starter cultures, 221
- Fermented foods
  - animal products, 225
  - based on hurdle technology, 878
  - benefits, 218
  - bread, 228
  - classification, 221
  - examples, 216, 218
  - fish, 227, 296
  - kefir, 231
  - sausages, 226
  - soy sauce, 231
  - tempeh, 231–232
  - vegetables, 225
  - vinegar, 229
- Filtration. *See* Membrane separation
- Fish and seafood, 247
  - cold chain technology, 166
  - color changes, 161
  - future prospects, 169
  - global production, 152
  - global trade, 153
  - HACCP, 1002
  - hydrolysis, 160
  - irradiation, 774
  - microwave tempering, 697
  - modified atmosphere, 161
  - odor changes, 164
  - oxidation, 160
  - prestorage treatments, 166
  - protein changes, 164
  - spoilage, 157–165
  - texture changes, 162
  - utilization, 153
  - UV applications, 755
- Flame heating, 588
- Flame sterilizers, 596
- Flow diagram, 976
- Flash pasteurization, 577
- Flavor retention, 645
- Flavor reversion rancidity, 260
- Fluidized beds, 392, 409, 531, 597, 654
- Food choice, 6
- Food safety, 3, 5–6
- Foods
  - definition, 4
  - deterioration, 7
  - preservation, 4
- Food packaging interactions
  - factors affecting migration, 945
  - legislative aspects, 950
  - metal-food interaction, 946
  - migration, 941
  - migrating substances, 941–943
  - migration testing, 945
  - paper-food interaction, 947
  - plastic-food interaction, 948

- plasticizers, 941
- prediction of migration, 943
- safety, 950
- scenario, 940
- Food preservation
  - avoid recontamination, 8
  - chemicals, 9
  - control of atmosphere, 12
  - for whom, 5
  - heat, 12
  - high pressure, 13
  - how long, 5
  - inactivation, 8, 12
  - inhibition, 8
  - methods
    - antibiotics, 11
    - antimicrobial agents, 11
    - antioxidants, 259–281
    - aseptic processing, 609–620
    - control of water, 11–12
    - control of structure, 11–12
    - cooking, 625–633
    - drying, 11, 404–427
    - edible coatings, 12, 477–498
    - encapsulation, 509–556
    - enzyme, 11
    - fermentation, 215–232
    - freezing, 12, 636–657
    - freezing–melting process, 667–685
    - glass transition and state diagram, 336–356
    - good hygiene practice, 961–964
    - good manufacturing practice (GMP), 15, 1011–1028
    - hazard analysis and critical control point (HACCP), 15, 969–1008
    - high-pressure, 13, 815–848
    - hurdle technology, 15, 867–890, 895–903
    - hygienic design, 957–961, 964–966
    - indirect approach, 14
    - irradiation, 761–777
    - light energy, 751–757
    - managing profit and quality, 1031–1053
    - magnetic field, 14, 855–865
    - membranes, 365–381
    - microwave heating, 691–709
    - minimal processing, 16, 137–147
    - modified-atmosphere packaging, 316–329
    - natural antimicrobials, 237–254
    - nitrites, 299–308
    - ohmic heating, 741–748
    - osmotic dehydration, 433–442
    - overview, 3–16
    - packaging, 907–914, 917–938, 937–951
    - pasteurization, 571–582
    - pH, 9–11, 287–296
    - postharvest handling, 19–43, 49–69, 74–129, 152–169, 173–192, 203–210
    - pulsed electric fields, 783–811
    - sterilization, 585–620
    - stickiness and caking, 387–400
    - ultrasound, 13, 713–732
    - use of chemicals, 9–11
    - use of electricity, 13
    - use of heat, 12
    - visible light, 756
    - water activity, 11, 447–471
  - principles, 896
  - techniques, 8–15
  - why, 4
- Food production stages, 5
- Forced air or pressure cooling, 55
- Forced convection systems, 591
- Fouling, 380
- Free volume theory, 347
- Free water, 639
- Freeze drying, 410
- Freezing
  - display, 651
  - enzymatic change, 12
  - functional properties, 641–643
  - future research, 656
  - meat, 190–191
  - methods, 653–656
  - microbial growth, 12, 636
  - mode of action, 636
  - non-enzymatic change, 12
  - pretreatments, 647–651
  - quality, 637–647
  - rate and quality, 637
  - storage, 651
  - ultrasound assisted, 726
- Freeze concentration. *See* Freezing–melting process
- Freezer burn, 641
- Freezing injury, 39–40
- Freezing–melting process
  - advantages, 667
  - applications, 685
  - classification, 669–685
  - definition, 667
  - disadvantages, 667
  - historical development, 668
  - state of the art, 668
  - vacuum freezing, 683
- Freezing point
  - definition, 346
  - measurements, 340, 346–347
- Fruit juices
  - heat treatment, 704
  - UV applications, 752
- Frying process, 627
- Fumigation, 494, 764
- Functional foods, 155
- Fusion foods, 901
- Fungicides, 489
- GAB-monolayer, 343, 457
- Gelatinization
  - high pressure, 842
  - ohmic heating, 744
- Genetic factor, 20
- Germination, 27
- Glass bottles, 580, 605

- Glass transition
  - applications, 349–356
  - background, 336–337
  - definition, 337
  - differential scanning calorimetry (DSC), 344
  - measurement methods, 344–346
  - microbial stability, 352, 471
  - theoretical progress, 347–349
  - thermal mechanical compression test (TMCT), 395
- Good manufacturing practice (GMP)
  - activities, 1012, 1014
  - applications, 1026
  - benefits, 1025
  - combination of pH and water activity, 291
  - definition, 15, 1012
  - foundation, 1014
  - implementing with HACCP, 1008
  - minimal processing, 142
  - philosophy, 1013
  - preliminary process, 1014
  - smokehouse, 415
- Grading
  - fruits, 50
  - grains, 81
  - technology, 81–82
- Grains
  - milling, 118–129
  - structure, 74–84
- GRAS, 239
- Gray (Gy), 762
- Green chemicals, 10
- Hammer mill, 127
- Harvesting methods
  - advantages, 23
  - disadvantages, 23
  - grains, 82–91
  - mechanically, 23
  - manually, 23
  - stripper harvester, 89–91
- Hazard
  - analysis, 788, 983–986
  - biological, 977
  - chemical, 979
  - controlling, 980–983
  - physical, 979
  - sources, 979–980
  - reduction, 177
- Hazard analysis and critical control point (HACCP)
  - applications, 26, 65
  - applications in pulsed electric field, 788
  - background, 970
  - benefits, 971, 994
  - critical control points, 986–990
  - definition, 15
  - development, 974
  - documentation, 991
  - flow diagram, 976
  - hurdle technology, 889
  - key tasks, 974
  - management, 992
  - minimal processing, 142
  - prerequisite programs, 973
  - record keeping, 991
  - risk analysis, 988
  - scope, 974
  - seven principles, 974
  - team, 975
  - terminologies, 972
  - training, 975
  - types of hazards, 977–979
  - validation, 992
  - verification procedures, 991
- Hazard and operability study, 790
- Heat exchanger pasteurizer, 575
- Heating methods, 610
- Heat pump drying, 410–413
- Heat treatment, 60, 648, 720
- Heat, use of, 12
- Heated air drying, 95–98
- High-density polypropylene, 699
- High moisture foods, 876
- High pressure
  - applications, 846
  - basics, 815
  - biochemical reactions, 836
  - chemical reactions, 836
  - combine with ultrasound, 720–721
  - commercial applications, 821
  - commercial equipment, 818
  - background, 13
  - effects on biological materials, 822
  - mechanism of action, 835
  - melting, 684
  - processing operation, 820
  - terminology, 816–818
- High-temperature injury, 40
- High-temperature-short-time (HTST)
  - aseptic, 609
  - microwave, 692, 700, 706
  - pasteurization, 573, 576
- Histological images, 183
- Homeostasis, 872, 897
- Homogenization, 729
- Hot sterilization, 597
- Hot water heating, 588
- Hot water sterilizers, 594
- Hot water treatment, 61
- Huller, 127
- Humectants, 448
- Hurdle technology
  - applications, 874–888
  - definition, 15, 896
  - combined with high pressure, 844
  - design, 888, 901
  - frozen products, 656
  - fundamentals, 897
  - homeostasis, 872, 897
  - hurdle effect, 868
  - metabolic exhaustion, 872–873, 898
  - multitarget preservation, 874, 899
  - potential hurdle, 871

- principles, 868, 872
  - rationale, 238
  - steps, 901
  - stress reactions, 873, 898
  - total quality, 899
- Hydrocooling, 55
- Hydrogen peroxide, 9, 167, 209, 264, 720
- Hydrolock, 594
- Hydrolysis, 354, 646
- Hydrostatic helix, 596
- Hydrostatic pressure sterilizer, 595
- Hygiene conditions
- buildings, 1016
  - equipment, 1017
  - milk, 205
  - packaging, 1018
  - personnel, 177, 1016
  - requirements, 1016
  - slaughterhouse, 176
  - storage, 1019
- Hygienic design
- ceilings, 959
  - definition, 957
  - doors, 959
  - equipment design, 959
  - factory site, 957
  - floors, 958
  - good hygienic practice, 961
  - lighting, 959
  - walls, 959
  - windows, 959
- Hygiene monitoring, 965
- Ice-crystallization unit, 671–673
- Ice nucleation, 649
- Ice separation unit, 673
- Ice storage, 162
- Immersion freezing, 653
- Impingement drying, 414
- Inactivation, 8, 12
- Indirect approach
- good manufacturing practice (GMP), 1012–1028
  - hazard analysis and critical control point (HACCP), 969–1008
  - hygienic design, 957–966
  - packaging, 14, 895–903, 907–938, 939–951
- Indirect contact freezers
- circular-tube type, 679
  - comparison with direct system, 680
  - definition, 677
  - dynamic layer growth system, 679
  - internally cooled, 677
  - layer crystallization unit, 677
  - progressive crystallization unit, 678
  - ripening vessels, 680
  - static layer growth freezing, 677
  - suspension crystallization unit, 679
- Infestation, insect, 109
- Inhibition, 8
- Injection molding, 920
- Ink bottle theory, 451
- Insects, 106, 111
- In-store drying, 408
- Intermediate moisture foods, 874
- Impact, 25, 30, 51
- Integer foods, 877
- Internal stress, 638
- Irradiation
- advantages, 763–764
  - applications, 63
  - consumers' attitude, 777
  - dose and dosimetry, 762
  - dose level, 765–766
  - effects on food components, 767–768
  - fish, 168–169
  - frozen products, 651
  - fruits and vegetables, 62
  - nitrites, 303
  - mode of action, 762, 765
  - scope, 763
  - sources, 762
- ISO standard, 15, 1008, 1025
- Kefir, 231
- Ketonic rancidity, 260
- Lactic acid bacteria, 167, 218–219, 245, 249, 573
- Lactic acid products
- cheese, 223
  - fish, 167
  - yogurt, 223
- Lamination, 926
- Layer crystallization unit, 677
- Leaf yellowing, 141
- Le Chatelier's Principle, 13, 816
- Light, 25
- Lipase, 43
- Lipid oxidation
- basic, 8
  - dried products, 422
  - encapsulation, 547
  - meat, 187
  - fish, 160
- Lipolytic rancidity, 260
- Liposome entrapment, 539
- Lipoxygenase, 43
- Low electric field applications, 13
- Lyophilization, 535
- Magnetic field
- applications, 14, 860–865
  - future needs, 865
  - generation, 858–860
  - imaging, 864
  - lines, 857
  - magnetism, 856
  - oscillation technique, 859
  - static technique, 859
  - terminology, 857
  - types, 858
  - ultra-high fields, 860
- Magnetic resonance imaging (MRI), 864

- Maillard browning, 421
- Managing customer complaints, 1048
- Managing variability, 1045
- Manual harvesting, 23
- Mature phase, 26
- Maturity
  - indices, 22
  - quality, 21
- Maximal-freeze-concentration conditions, 338–339, 641
- Mesophilic bacteria, 7
- Meat. *See* Muscle
- Mechanical harvesting, 23
- Mechanical injury or damage, 25, 51
- Mechanical interlocking, 390
- Melting unit, 675
- Membrane separation
  - applications, 370–380
  - bioreactors, 378
  - cleaning, 380
  - definition, 365
  - lipid, 377
  - materials, 368
  - modules, 367–369
  - performance, 368–370
  - principles, 366
  - selection, 372
  - ultrasound assisted, 725
- Metabolic exhaustion, 872–873, 898
- Metal-chelating agents, 275
- Metastable equilibrium, 340
- Methyl bromide, 9
- Microbiology
  - attachment, 180
  - contamination, 205, 217
  - control in drying, 420–421
  - destruction by microwave, 700
  - destruction by pulsed electric field, 792
  - encapsulation, 550
  - frozen products, 638–639
  - high pressure, 823–828
  - irradiation, 765
  - magnetic field, 861
  - osmotic syrup, 441
  - stability in glass, 352
  - ultrasound, 719
- Microfilm cooker, 631
- Microfiltration, 367
- Microfluidization, 539
- Microwave heating
  - advantages, 693–694
  - applications, 13, 692, 702–705
  - cooking, 627
  - dielectric constant, 693–694
  - dielectric loss factor, 693–694
  - dielectric properties, 694
  - factors, 694–696
  - frequency, 694
  - future, 708
  - limitations, 708
  - marker, 707
  - principles, 692–693
  - recent developments, 699
  - recommendations, 708–709
  - sterilization, 705–707
  - systems, 701–702
- Microwave tempering, 697
- Milk
  - bactofugation, 210
  - based on hurdle technology, 887
  - clarification, 210
  - composition, 203–204
  - contamination, 205
  - dairy products, 204, 247
  - microflora, 205, 375
  - microwave, 702–705
  - pulsed electric field, 800
  - quality, 205
  - structure, 203–204
  - thermization (thermalization), 210
- Milling
  - dry, 122
  - machinery, 127
  - operations, 118–119
  - pulse, 129
  - rice, 121
  - technologies, 123–125
  - wet, 120, 122
- Minimal processing
  - biochemical changes, 138–141
  - definition, 16, 137
  - edible coating, 145
  - physiological responses, 138–141
  - sanitation, 142–145
  - water loss, 141
- Mitochondria, 186
- Mixed structure, 388
- Modified atmosphere
  - drying, 415–417
  - fermentation reactions, 317
  - fish, 161
  - future outlook, 328
  - microbial growth, 318, 324–326
  - oxidative reactions, 317
  - packages, 318
  - rationale, 316
  - recommended conditions, 326–328
- Modified Henderson equation, 92
- Moisture hysteresis, 92
- Moisture isotherm
  - amorphous solids, 398
  - crystalline solids, 398
- Molds, 220
- Multitarget preservation, 874, 899
- Muscle
  - aging, 189
  - based on hurdle technology, 886
  - biology, 174
  - cold shortening, 182
  - color, 185
  - decontamination, 177
  - electrical stimulation, 182
  - encapsulation, 543

- freezing, 190
  - HACCP, 997
  - irradiation, 771–774
  - meat products, 246
  - metabolism, 174
  - microwave tempering, 697
  - mitochondria, 186
  - postmortem, 182
  - safety, 188
  - storage, 188
  - structure, 174, 184
  - tenderization, 189, 730
  - UV applications, 754
  - warm-over flavor, 188
- Myofibers, 174
- Nanofiltration, 367
- Natural air drying, 94
- Natural antimicrobial
- essential oils, 241–243
  - future outlook, 253
  - GRAS, 239
  - hurdle technology, 238
  - legislatory aspects, 253
  - microbial origin, 245–253
  - organic acids, 10, 241
  - phenolic compounds, 241
  - phytoalexins, 240
  - rationale, 238
- Nisin, 232, 249
- Nitrites
- antimicrobial aspects, 299–305
  - cycle, 300
  - efficacy factors, 300
  - functionality, 306–307
  - heating, 302–303
  - interaction with food components, 305
  - interaction with irradiation, 774
  - medical or health aspects, 307–308
  - mode of action, 303–305
  - oxygen, 301
  - pH, 300–301
  - safety, 308
- Nonclimacteric fruits, 28–30, 33
- Nonenzymatic browning, 8, 353, 463
- Nonequilibrium state, 340
- Nonperishable foods, 7
- Oats, 78
- Ohmic heating
- advantages, 742
  - applications, 742, 747–748
  - background, 746
  - cold spot, 745
  - components, 743
  - cost, 743
  - definition, 742
  - dehydration, 746
  - design, 743
  - electroporation, 746
  - extraction, 748
  - future research, 748
  - heat generation, 745
  - important parameters, 744–745
  - modeling, 745
- Ontogeny, 26
- Optimum storage
- freezing, 58
  - humidity, 58
  - temperature, 58
- Organic acids, 10, 241
- Oscillation magnetic fields, 859
- Osmotic dehydration
- agents, types of, 438
  - definition, 433–434
  - equilibrium distribution coefficients, 434
  - factors affecting process, 438–440
  - frozen products, 649
  - problems, 441
  - quality improvement, 436
  - ultrasound assisted, 724
- Oxidants, 264
- Oxidation
- by UV, 755
  - effects by water activity, 463
  - in glassy state, 353
  - lipid, 186
  - meat, 186
- Oxidative
- browning, 140
  - rancidity, 260
- Ozone, 9, 143, 264
- Pack date, 5
- Package icing, 55
- Packaged food pasteurization, 574
- Packaging
- absorbent, 51
  - adhesives, 927
  - antimicrobial, 909
  - barrier properties, 908
  - basic, 14
  - coatings, 927
  - convenience, 911
  - cushioning, 52
  - edible film, 910
  - environmental issues, 913
  - future direction, 914
  - heat seals, 927
  - history, 907
  - hygiene, 1018
  - ideal, 912
  - irradiation, 776
  - lamination, 926
  - materials, 913, 917–938
  - microwave, 699
  - modified atmosphere, 318
  - pasteurized foods, 580–581
  - presentation, 910
  - protection, 911
  - provide history, 912
  - purpose, 51, 908

- Packaging (*contd.*)
  - recycle, 913
  - reduce, 914
  - reuse, 913
  - sterilized foods, 604
  - types, 928
- Packaging materials
  - acrylonitrile, 925
  - aluminum, 930
  - cardboard, 934
  - cellulose, 924
  - cellulose acetate, 924
  - ceramics, 937
  - copolymers, 925
  - ethylene vinyl alcohol, 925
  - glass, 932
  - ionomers, 925
  - metalized films, 937
  - metals, 929–932
  - papers, 934
  - plastics, 917, 919
  - pliofilm, 925
  - polyamides (nylons), 924
  - polystyrene, 923
  - polyethylene, 918, 922
  - polytetrafluoroethylene, 923
  - polyvinylidene chloride, 923
  - polyvinyl chloride, 923
  - polyolefins, 922
  - rigid, 920
  - steel, 929
  - thermoplastic polyesters, 924
  - timber, 934
- Padding, 52, 53
- Pallet box, 51
- Pasteurization
  - definition, 571
  - energy aspects, 581–582
  - equipments, 574
  - high-temperature-short-time (HTST), 573
  - magnetic fields, 860
  - microwave, 699–700
  - quality, 578–579
  - processing conditions, 572
  - purpose, 572
  - testing, 573
  - types, 573
- Pearl millet, 79
- Pediocin, 250
- Peroxidase (PPO), 140
- Peroxide value, 422
- Perigo effect, 302–303
- Personal hygiene, 177, 962
- Pesticides, 21
- Perishable foods, 7
- Pervaporation, 379
- pH
  - basics, 9–11
  - combine with water activity, 291
  - controlling methods, 295
  - definition, 287
  - effects on enzymes, 293
  - effects on proteins, 294
  - effects on nitrites, 300
  - enhancement of preservatives, 292
  - food classifications, 292
  - heat stability of microorganisms, 292
  - limits for microbial growth, 289–290
  - mode of action, 290–292
  - values of foods, 287–288
  - vitamin stability, 295
- Pest management, 1023
- PET, 580, 699
- Phase transitions, 337
- Phenolic compounds, 241, 414, 492
- Phenylalanineammonialyase (PAL), 140
- Photoreactivation, 14, 756
- Physical aging, 348
- Physical treatments, 9
- Physiological disorders
  - chilling injuries, 38
  - common symptoms, 37
  - definition, 36
  - environmental factors, 38
  - mineral deficiencies, 38
- Phytoalexins or phenolic compounds, 240
- Phytohormones, 34
- Phytotoxic microatmosphere, 52
- Pin mill, 127
- Pitting, 125
- Plate freezing, 653
- Plate heat exchanger, 577
- Plasticizers, 489, 941
- Poikilothermic organisms, 111
- Polishing, 126
- Polyunsaturated fatty acids, 187
- Pore formation, 351, 424, 699
- Positive flow systems, 590
- Postharvest handling
  - grading, 50
  - management, 49
  - sorting, 50
  - value chain, 50
- Postharvest losses
  - fish, 156
  - mechanical damage, 159
- Postharvest physiology
  - adverse atmosphere injury, 40
  - chilling injury, 38–39
  - chlorophyll degradation, 33
  - development, 26
  - diseases or infections, 25
  - dormancy, 26
  - ethylene formation, 34–35
  - freezing injury, 39–40
  - germination, 27
  - high-temperature injury, 40
  - mature, 26
  - mechanical damage, 51
  - ontogeny, 26
  - phytohormones, 34
  - physiological disorders, 36–40
  - quality, 19
  - respiration, 27

- ripe, 26
- ripening, 32, 35
- senescence, 26, 32
- sprouting, 26
- texture, 34
- transpiration, 30
- water stress, 30
- young or premature, 26
- Postharvest treatments
  - antioxidants, 69
  - calcium, 69
  - chemicals, 63–66
  - cleaning, 9, 59
  - coating, 59
  - curing, 62
  - ethylene removal, 66
  - fish, 165–169
  - heat, 60
  - hot water, 61
  - physical, 59
  - waxing, 59
- Postmortem glycolysis, 181, 183, 186
- Postrigor meat, 185
- Precooling
  - advantages, 53
  - methods, 53–56
- Pressure cooker, 630
- Product recall, 994
- Profit
  - assets, 1034
  - business environment, 1033
  - commercial requirement, 1034
  - cost, 1034
  - fixed costs, 1035, 1038
  - impact on assets, 1038
  - impact on cash, 1039
  - impact on revenue, 1037
  - management, 1032
  - price, 1036
  - research and development, 1039
  - revenue, 1034
  - technical impact, 1037
  - variable costs, 1035
- Progressive crystallization unit, 678
- Protein denaturation, 354, 422, 632, 640, 728, 767, 805, 864
- Prerigor meat, 182
- Pretreatments
  - blanching, 417
  - cooking, 419
  - ethyl treatment, 417
  - freezing, 419, 647–651
  - methyl, 418
  - salting, 418
  - sulfur dioxide, 417
- Psychrometric chart, 32
- Psychrophilic (cryophilic) bacteria, 7
- Pulsed electric fields
  - applications, 791–810
  - basics, 783–785
  - bench top unit, 786
  - equipments, 785–792
  - lab scale pulser, 786
  - mechanism, 785
  - process design, 788
  - treatment chambers, 786
- Pulses
  - composition, 80
  - conditioning, 125
  - structure, 80–83
- Pulsed light, 14, 756
- PVC bottles, 580
- Quality
  - affected by UV, 755
  - assurance, 1041
  - aseptic packaging, 616
  - atmospheric gas, 24
  - causes problems, 1043
  - climatic, 20
  - cultural practices, 21, 1043
  - definition, 4–6, 19, 50
  - dried foods, 420–426
  - fish, 156
  - frozen products, 637–643
  - genetic, 20
  - grains, 99–101
  - harvesting factors, 21
  - harvesting methods, 23
  - humidity, 24
  - irradiation, 763
  - light, 25
  - managing, 1042
  - maturity, 21
  - meat, 183
  - mechanical injury, 25
  - milk, 205
  - pH, 26
  - pasteurized foods, 578–579
  - postharvest diseases, 25
  - postharvesting factors, 24
  - preharvest factors, 20, 49
  - sterilized foods, 599
  - technical services, 1042
  - temperature, 24
- Q<sub>10</sub>. *See* Temperature quotient
- Radiation, use of
  - mode of action, 14
  - ultraviolet (UV), 14
- Rancidity, 10
  - control, 264–267
  - effects on nutrition, 263
  - effects on sensory, 263
  - frozen products, 643–644
  - measurement methods, 262
  - mechanism, 260
  - oxidants, 264
  - steps, 261
  - types, 260
- Ready-to-eat, 137, 705
- Ready-to-use, 137
- Recall procedure, 1025
- Recording, 1050



- Recrystallization, 640  
 Reducing variability, 1044  
 Redox potential (Eh), 573  
 Refrigerant-brine interactions, 675  
 Rehydration, 425  
 Relaxation, 348–349  
 Respiration
  - classification based on, 28
  - coefficients, 28
  - definition, 27
  - heat, 27
  - minimal processed fruits, 139–140
  - pathway, 27
  - rate, 27–30
  - respiratory quotient, 27
 Retortable pouches, 606  
 Retrogradation, 640  
 Returnable bottles, 580  
 Reynolds number, 696  
 Reverse osmosis, 367  
 Review, 992, 1025  
 Rice, 74  
 Rigor mortis
  - changes, 174–175
  - development, 181
  - hastening, 183
 Ripening, 32, 67, 138  
 Ripening hormone, 35  
 Risk analysis
  - assessment, 988, 1002, 1006
  - communication, 989
  - definition, 988
  - management, 989
  - reduction, 1006
 Rodents, 112  
 Roller mill, 127  
 Room cooling, 55  
 Rotary cereal cooker, 630  
 Rotary drum drying, 410  
 Rye, 78  
  
 Sakacin, 250  
 Salting, 418, 435  
 Sanitization, 9, 208, 756, 957, 961, 1021  
 Sanitizers (or disinfection)
  - ammonium compounds, 9
  - bromine, 9
  - calcium hypochlorite, 143
  - chlorine, 9, 66, 142, 181, 167
  - chlorine dioxide, 9, 66, 181, 167
  - hydrogen peroxide, 9, 66, 167, 180, 209
  - hypochlorites, 66
  - iodine, 9
  - iodophore, 66
  - irradiation, 763
  - methyl bromide, 9
  - methylcyclopropene, 144
  - nitrogen trichloride, 65
  - ozone, 9, 65, 143, 180,
  - peracetic acid, 66
  - peroxyacetic acid, 9
  - sodium o-phenylphenate, 66
  - trisodium phosphate, 9
  - ultrasound, 722
  - UV light, 66
 Saturated steam heating, 588  
 Sauerkraut, 245–247  
 Sausages, 226, 245, 697  
 Saturated fatty acids, 187  
 Semiperishable foods, 7  
 Senescence, 26, 31, 67  
 Shrinkage, 424  
 Silos, 113  
 Singlet oxygen quenchers, 275  
 Skeletal muscles, 173  
 Slaughter
  - conditions, 176
  - equipments, 176
 Smoking, 10, 414  
 Sodium hypochlorite, 244  
 Solar drying, 408  
 Sonochemistry, 717  
 Sorghum, 76  
 Sorption isotherm
  - break, 452, 468
  - cycles, 451
  - definition, 449–452
  - hysteresis, 449
  - local, 453
  - shift, 452
  - theory, 451
 Sorting
  - acoustic, 51
  - color, 125
  - hand, 51
  - imaging, 51
  - optical, 51
  - purpose, 50
  - spectroscopy, 51
 Sourdough, 228  
 Soy sauce, 231  
 Spiral freezing, 655  
 Spoilage
  - fish, 157
  - meat, 176
  - microbial, 176–178
  - milk, 206–207
 Spouted bed drying, 409  
 Spray drying, 409, 527  
 Sprouting, 26, 67  
 Starter cultures, 221  
 State diagram
  - components, 338–340
  - definition, 337
  - different regions, 338
  - maximal-freeze-concentration, 338–339
 State of water, 343, 404  
 Static layer growth freezing, 677  
 Static magnetic fields technique, 859  
 Steam cooker, 629, 630  
 Steam kettles, 629  
 Steam retort, 590

- Sterilization
  - based on hurdle technology, 88
  - bulk canning, 587
  - definition, 586
  - energy aspects, 608
  - flavor, 601
  - heating medium, 588
  - magnetic field, 863
  - methods, 587–599
  - microwave, 699–700, 705–707
  - nutrients, 601
  - packaging, 930
  - theory, 586–587
- Stickiness
  - above glass, 350
  - adhesion, 396
  - cohesive forces, 389
  - definition, 388
  - factors, 426
  - packaging, 950
  - testing methods, 392–396
- Still retorts, 588
- Strong acid, 290
- Storage
  - bagged, 104
  - bulk, 105
  - grains, 98–118
  - on ground, 101
  - structure design, 114
  - types, 101–112
  - underground, 104
- Storage life (or shelf life), 7, 25, 57–58, 158, 162–163, 207, 763, 902
- Stress reactions, 873, 898
- Stripper harvester, 89–91
- Strong acid, 10
- Structure
  - dried foods, 423
  - osmotic dried foods, 435
- Subtropical zone, 38
- Sulfur dioxide treatment, 417
- Sun drying, 408
- Supercooling, 340
- Superheated steam drying, 413
- Surface energies, 390
- Suspension crystallization unit, 679
- Sustainable development, 3
- Sweeteners, 545
  
- Tempeh, 231
- Temperate zone, 38
- Temperature cycling, 652
- Temperature quotient (Q10), 24, 29
- Tenderization of meat, 189
- Texture
  - above and below glass, 339, 349
  - dried foods, 426
  - during ripening, 34
  - ohmic heated products, 744
  - sterilized foods, 599
  - water activity, 466
- Thawing
  - frozen products, 652
  - ultrasound assisted, 726
- Thermal drying, 405
- Thermization, 210
- Thermodynamic equilibrium, 340
- Thermoforming, 921
- Thermo-mechanical analysis (TMA), 339
- Thermophilic bacteria, 7
- Threshing, 82
- Time-temperature indicators, 652, 912
- Tocopherols, 268
- Transducers, 718
- Transgenic fruits and vegetables, 21
- Transient period, 406
- Transpiration
  - coefficient, 31
  - factors, 31
  - rate, 30
- Transportation, 52–53
- Trimming of muscle, 178
- Triple point, 411
- Tropical zone, 38
- Tunnel freezing, 655
- Tunnel pasteurization, 575
  
- Ultrafiltration, 367, 374
- Ultra-high magnetic fields, 860
- Ultra-high-temperature (UHT)
  - microwave, 700
  - pasteurizer, 578
- Ultraviolet (UV) light
  - applications, 14
  - definitions, 751
  - effects on flavors, 755
  - enhancement in preservation, 751–755
  - fish and seafood, 755
  - fruit juices, 753
  - fruits and vegetables, 753–754
  - meat, 754
  - mode of action, 756
  - quality defects, 755
  - sanitation, 756
- Ultrasound
  - amplitude, 715
  - applications, 13, 714, 719–732
  - bubble movement, 717
  - cavitation, 716
  - decontamination, 722
  - encapsulation, 540
  - frequency, 715
  - instruments, 718–719
  - intensity, 715
  - mass transfer enhancement, 723–725
  - protein denaturation, 728
  - sonochemistry, 717
  - sound waves, 714
  - transducers, 718
  - velocity, 715
  - wave characteristics, 715
  - wave length, 715

- Unfreezable water, 338, 343
- Use-by date, 5
- Vacuum cookers, 629
- Vacuum freezing
  - definition, 683
  - vapor absorption, 684
  - vapor compression, 683
- Vacuum cooling, 56
- Vacuum packaging, 320
- Vacreator, 578
- van der Waals forces, 389
- Variability, 1044
- Vat pasteurizing, 575
- Vegetable products, 248
- Vemuganti and Pfof equation, 93
- Vinegar, 229
- Visible light, 756
- Vitamins retention, 426, 466, 548, 578, 632, 644, 746, 768, 908
- Voltage field, 745
- Volatile development, 425
- Volatile retention, 425
- Volume expansion, 637
- Warehouses, 113
- Warm-over flavor, 188
- Wash column, 674
- Washing
  - fruits, 59
  - GMP, 1028
  - meat, 178
  - minimal processing, 142
  - organic acids, 179
- Waste management, 1023
- Water activity
  - above freezing, 455
  - adaptation, 461
  - basics, 448
  - below freezing, 455
  - browning, 464
  - definition, 337
  - effects of pressure, 456
  - effects of surface tension, 456
  - factors affecting, 454–456
  - fat oxidation, 463
  - humectants, 448
  - limitations, 336, 467
  - microbial activity, 457–464
  - mode of action, 459
  - monolayer concept, 456
  - sorption isotherm, 449–453
  - stability diagram, 457
  - stability range, 11, 94
  - terminologies, 448
  - vitamin loss, 466
  - why, 11, 448
- Water bath pasteurization, 574
- Water processing retorts, 591
- Water stress, 30
- Waxing
  - benefits, 59
  - formulations, 59
- Weak acids, 11, 290
- Wheat, 77
- White light, 14, 756
- Whole-crop harvesting system
  - McLeod system, 89
  - straight cut, 88
  - stripper header, 88
  - whole-crop baling, 89
  - windrow/combine, 87
- Williams-Landel-Ferry (WLF) equation, 347, 350
- Wine, 222, 379
- Wound response, 138
- X-rays, 62
- Yeasts, 220, 573
- Yogurt, 223

---

# Handbook of Food Preservation Second Edition

---

Recent advances in the multi-disciplinary science of food preservation now enable manufacturers to extend shelf-life, minimize risk, protect the environment, and improve functional, sensory, and nutritional properties. The ever-increasing number of food products and preservation techniques creates a great demand for an up-to-date handbook that will facilitate understanding of the methods, technology, and science involved in the manipulation of these conventional and sophisticated preservation methods.

Containing fundamental and practical aspects of today's current and emerging preservation methods, the **Handbook of Food Preservation, Second Edition** helps develop high-quality, safe products through a better understanding and control of the processes. Extensively revised, reorganized, and expanded from 25 to 44 chapters, it emphasizes practical, cost-effective, and safe strategies for implementing preservation techniques and dissects the exact mode or mechanism involved in each method by highlighting the effects on food properties. Divided into five sections the book begins with an overview of food preservation and handling including fresh fruits and vegetables, grains and pulses, fish, red meat, and milk. It presents comprehensive preservation methods based on chemical and microbiological additives, such as fermentation and pH-lowering agents. The book details methods of physical manipulation involving modified-atmosphere packaging, membrane technology, surface treatment, and edible coating. There is also an extensive description of preservation methods using thermal and other energies such as irradiation, high-pressure, and pulsed electric or magnetic fields. Finally, the book presents a range of indirect approaches to improve quality, safety, and good manufacturing practices.



**CRC Press**

Taylor & Francis Group  
an **informa** business

[www.taylorandfrancisgroup.com](http://www.taylorandfrancisgroup.com)

6000 Broken Sound Parkway, NW  
Suite 300, Boca Raton, FL 33487

270 Madison Avenue  
New York, NY 10016

2 Park Square, Milton Park  
Abingdon, Oxon OX14 4RN, UK

DK3871

ISBN 1-57444-606-1



[www.crcpress.com](http://www.crcpress.com)