

National Structural Concrete Specification for Building Construction

Fourth edition complying with BS EN 13670: 2009



The Concrete Centre™
PART OF THE MINERAL PRODUCTS ASSOCIATION

CONSTRUCT
concrete structures group

A technical committee of CONSTRUCT, the Concrete Structures Group, prepared this specification as the 4th edition of *National Structural Concrete Specification for Building Construction*, originally published in February 1998.

Technical Committee

Attending Members

Julian Maw (Chairman) – CONSTRUCT
Paul Toplis (Technical Editor) – Price & Myers
Edwin Bergbaum – Waterman Structures Ltd
Gordon Clark – Gifford
Andrew Cotter – MPA/The Concrete Centre
Alistair Craig – Carillon Building
Neil Crook – The Concrete Society
Roger Davies – Gifford
Richard Day – The Concrete Society
James Fudge – British Precast

Charles Goodchild – MPA/The Concrete Centre
Patrick Hallinan – Mace
Graham Hardwick – John Doyle Construction
Roger Hewitt – Scott Wilson Ltd
Mike Howard – Laing O'Rourke
Deborah Lazarus – Arup/Institution of
Structural Engineers
Neil Loudon – Highways Agency
John Webster – BAA Airports Ltd
Rob Westcott – Alan Baxter & Associates

Visiting Specialists

Kevin Bennett – Freyssinet Ltd.

Richard Digman – UK CARES

Corresponding Members

Rod McClelland – CBDG

Brian Spencer – Southern Water

Past Members

Clive Budge, Andy Butler, Peter Goring, John Mason

CONSTRUCT and the authors thank the numerous organisations from all sections of the industry whose views and comments have been sought and carefully reviewed for inclusion.

The work of preparing this specification was managed and funded by CONSTRUCT and MPA – The Concrete Centre.

CCIP-050

First edition published February 1998

This 4th edition published April 2010

ISBN 978-1-904818-96-0

Price Group P

© CONSTRUCT 2010

Published by The Concrete Centre,

part of the Mineral Products Association
Riverside House
4 Meadows Business Park
Station Approach, Blackwater, Camberley,
Surrey GU17 9AB

Tel: +44 (0)1276 606800

Fax: +44 (0)1276 606801

www.concretecentre.com

Prepared by CONSTRUCT

Riverside House
4 Meadows Business Park
Station Approach, Blackwater, Camberley,
Surrey GU17 9AB

Tel: +44 (0)1276 38444

Fax: +44 (0)1276 38899

www.construct.org.uk

All data, information and opinions contained herein aim to reflect accepted practices at the time of publication.

While every effort has been made to ensure accuracy, no responsibility can be accepted for errors and omissions, however caused. No responsibility for any loss occasioned as a result of material in the publication is accepted by the authors or publishers. Responsibility for interpretation of the material contained in this publication rests entirely with the user.

All rights reserved. No part of this publication may be reproduced, stored in a retrievals system or transmitted in any form or by any means, electronic, mechanical, photocopying, recording or otherwise without the prior permission of CONSTRUCT, except as noted.

Foreword

This fourth edition of the *National Structural Concrete Specification* (NSCS) has been completely reviewed and revised to encompass the requirements of the Eurocodes and BS EN 13670: 2009, *Execution of concrete structures*. It provides a BS EN 13670-compliant specification for use in structural concrete building construction designed to the Eurocodes. The adoption in the UK for the first time of a workmanship or execution standard in place of the workmanship requirements forming part of a design standard has necessitated some changes to the structure of this document and terminology, but this edition of the NSCS still has the same objective, that is to provide a definitive, simple and straightforward specification without unnecessary constraints. The section on execution management follows the introduction of this term in BS EN 13670 and the numbering of the specification sections follows that of the standard.

BS EN 13670 requires the use of an execution specification, consisting of documents and drawings to communicate additional and project-specific construction requirements between Client, Designer and Constructor. The NSCS for Building Construction forms part of the Execution Specification, called for in BS EN 13670: 2009, and has been designated by its National Annex as Non-Contradictory Complementary Information. The tolerance requirements of BS EN 13670 have been drawn up solely to assure structural safety of the building structure for a Eurocode design and are therefore not always sufficient to ensure reasonable construction coordination with following trades. The NSCS tolerances provide additional requirements aimed at coordination for normal circumstances and confirm the responsibility of different parties for ensuring the issues are carefully considered, where required, to suit the details of a particular project.

The NSCS contains three documents: the NSCS Standard Specification and NSCS Project Specification (which together form the BS EN 13670 Project Specification) and NSCS Guidance. The latter provides informative guidance for interpretation and usage of both Specifications. Clauses in BS EN 13670 have been repeated at times for clarity. The NSCS Standard Specification gives standards and technical data for use in the UK. The interrelationship of this Specification with BS EN 13670 and the contract documents is illustrated in Figure A. The NSCS Guidance to execution management describes how NSCS Standard Specification, a completed NSCS Project Specification, the drawings and other documents taken together provide all the information required to be included in the Execution Specification of BS EN 13670.

The functions of each part are summarised below.

The **NSCS Standard Specification** provides a base Specification with standard clauses on execution, materials and construction for the production of consistent and well-constructed reinforced concrete building structures.

The **NSCS Project Specification** provides the information and requirements specific to the project. It records, by exception, any amendments to the Standard Specification considered necessary by the designer and is the part of the Specification where information is provided by the tenderer. This enables tender documents or the contract for construction to consist of a Project Specification only, because it refers explicitly to the Standard Specification as its base document. To aid the task of preparing a Project Specification, permission is hereby expressly given for users of this document to copy the whole of Project Specification without infringement of copyright. A data disc, or download, is available from CONSTRUCT to enable easy electronic completion and distribution of the Project Specification. To aid the task the NSCS Project Specification has prompts to encourage specifications requiring best practice in sustainable

construction and environmental management. It is expected that standards for these issues will be evolving throughout the construction industry over the next few years and so specifiers should be adding their requirements on most projects.

The **NSCS Guidance** is a companion document to the specification and gives background information together with explanations of why certain clauses have been adopted. The information is intended to be of use to both the Designer and Constructor. The Guidance does not form part of the Execution Specification.

The NSCS assumes the Engineer remains responsible for using reasonable skill, care and diligence to design the structure and that the Constructor builds what is shown on the drawings to the specified standard. The Constructor is expected to exercise in the performance of his duties all such skill, care and diligence as may be expected of an experienced and competent Constructor used to working on projects of similar size, scope and complexity of structural concrete works using appropriately qualified and experienced staff. Prescriptive restraints have been avoided, so enabling the Constructor's experience to be used for efficient construction. The NSCS aims to ensure that the specification draws together all the day-to-day information needed by the Designers, Contract Administrator (CA) and the Constructor; it therefore includes information which may duplicate provisions in project preliminaries. It is important that, when the NSCS Standard Specification is used, all the project team make use of it and should the project preliminaries differ, the NSCS Project Specification should indicate the required changes.

The benefits of using NSCS will best be achieved by continuing the collaboration between Contractors, Specifiers and Designers that arose during its development. NSCS provides for agreement to be reached between the Constructor and the Designer on project-specific items that affect the pricing of the works.

A review panel will keep the document up to date in the light of comments and feedback received from all parts of the industry. Any inaccuracies and ambiguities found or proposals for future editions should be submitted to CONSTRUCT at enquiries@construct.org.uk

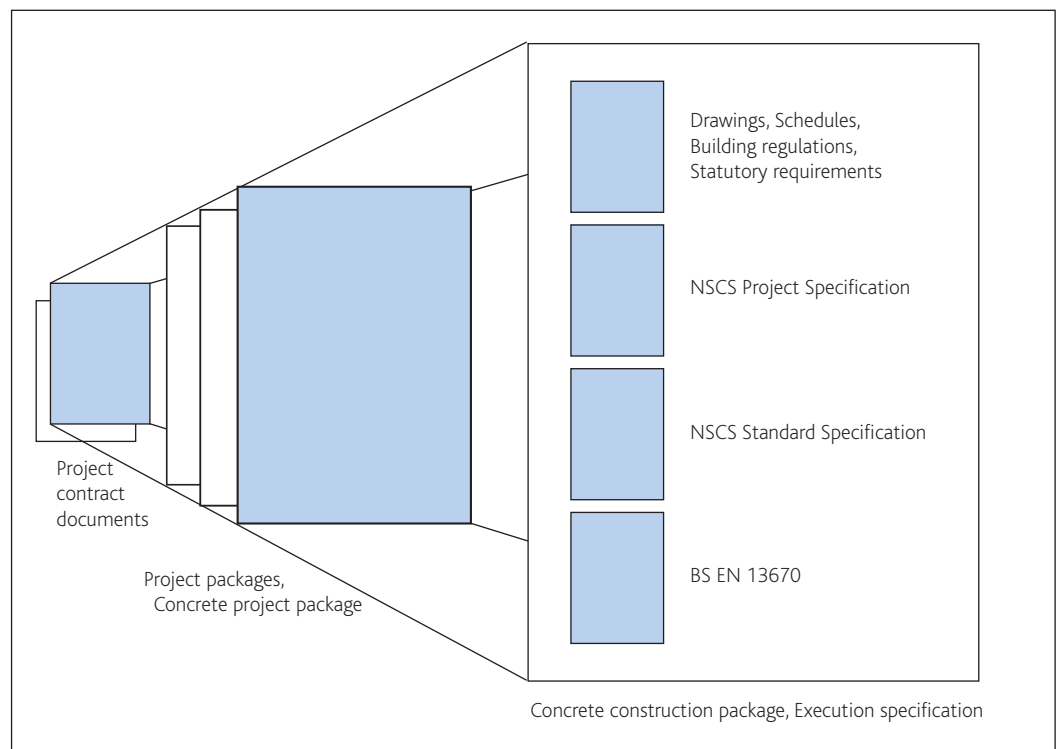

Figure A
The NSCS in context

National Structural Concrete Specification for Building Construction

Contents

| Standard Specification | | Standard Specification | Guidance Notes |
|-------------------------------|--|---------------------------|-------------------|
| Section 1 | Scope | 1 | 57 |
| Section 2 | Bibliography | 2 | 119 |
| 2.1 | Standards | 2 | 119 |
| 2.2 | General | 3 | 121 |
| Section 3 | Definitions | 3 | 57 |
| 3.1 | Agreement, acceptance | 3 | 57 |
| 3.2 | Contract administrator (CA) | 4 | 57 |
| 3.3 | Design calculations | 4 | 57 |
| 3.4 | Drawings and schedules | 4 | 57 |
| 3.5 | Employer | 5 | 58 |
| 3.6 | Engineer | 5 | 59 |
| 3.7 | Manufacturer | 5 | 59 |
| 3.8 | Project specification | 5 | 59 |
| 3.9 | Prestressed concrete | 5 | 59 |
| 3.10 | Reference panels | 5 | 59 |
| 3.11 | Site | 5 | 59 |
| 3.12 | Spacers | 5 | 59 |
| 3.13 | Temporary works coordinator | 5 | 59 |
| Section 4 | Execution management | 6 | 59 |
| 4.1 | General requirements | 6 | 63 |
| 4.2 | Documentation | 6 | 64 |
| 4.3 | Quality management | 8 | 66 |
| Section 5 | Falsework and formwork | 9 | 68 |
| 5.1 | Standards | 9 | 68 |
| 5.2 | Materials | 9 | 68 |
| 5.3 | Release agents | 9 | 69 |
| 5.4 | Formwork use | 9 | 70 |
| 5.5 | Block outs and cast-in items | 9 | 71 |
| 5.6 | Formwork ties | 9 | 71 |
| 5.7 | Loading, striking and backpropping | 10 | 72 |
| 5.8 | Construction joints and pour sizes | 10 | 72 |
| 5.9 | Water-resisting construction | 10 | 73 |
| Section 6 | Reinforcement | 11 | 74 |
| 6.1 | Materials | 11 | 74 |
| 6.2 | Execution | 13 | 77 |
| Section 7 | Prestressed concrete construction | 14 | 78 |
| 7.1 | Design and quality control | 14 | 78 |
| 7.2 | Materials | 14 | 79 |
| 7.3 | Execution | 15 | 80 |
| 7.4 | Records | 17 | 82 |
| Section 8 | Concrete and concreting | 18 | 82 |
| 8.1 | Concrete | 18 | 82 |
| 8.2 | Concreting | 20 | 91 |
| 8.3 | Curing | 20 | 92 |
| 8.4 | Inspection – post-concreting | 21 | 94 |

| | | Standard Specification | Guidance Notes |
|-------------------|---|---------------------------|-------------------|
| 8.5 | Surface cracking | 21 | 94 |
| 8.6 | Surface finishes | 21 | 95 |
| Section 9 | Precast concrete | 22 | 100 |
| 9.1 | General | 22 | 100 |
| 9.2 | Precast concrete products | 23 | 101 |
| 9.3 | Precast concrete elements | 23 | 101 |
| 9.4 | Handling and storage | 23 | 101 |
| 9.5 | Placing and adjustment | 24 | 101 |
| 9.6 | Jointing | 24 | 101 |
| Section 10 | Geometric tolerances | 24 | 102 |
| 10.1 | General | 24 | 102 |
| 10.2 | Overall structure | 25 | 104 |
| 10.3 | Base support (foundations) | 26 | 106 |
| 10.4 | Foundation bolts and similar inserts | 26 | 106 |
| 10.5 | Elements – columns and walls | 27 | 106 |
| 10.6 | Elements – beams and slabs | 29 | 107 |
| 10.7 | Section of elements | 31 | 107 |
| 10.8 | Position of reinforcement within elements | 31 | 108 |
| 10.9 | Surface straightness | 32 | 109 |
| 10.10 | Holes and fixings | 33 | 109 |
| 10.11 | Staircases | 34 | 110 |
| 10.12 | Precast concrete elements | 34 | 110 |

Project Specification

| | | | |
|-------------------|--|----|-----|
| Section P1 | Information to be supplied TO the Constructor | 38 | 111 |
| P1.1 | General information | 38 | 111 |
| P1.2 | Design | 40 | 112 |
| P1.3 | Drawings and calculations | 41 | 112 |
| P1.4 | Execution management | 42 | 114 |
| P1.5 | Materials | 44 | 115 |
| P1.6 | Project requirements | 45 | 116 |
| P1.7 | Water-resisting construction | 45 | 117 |
| P1.8 | Concrete | 46 | 117 |
| P1.9 | Surface finishes | 50 | 117 |
| P1.10 | Precast concrete | 51 | 117 |
| P1.11 | Prestressed concrete construction | 51 | 118 |
| P1.12 | Deflection allowances | 52 | 118 |
| P1.13 | Further information | 52 | 118 |
| Section P2 | Information to be supplied BY the Constructor | 52 | 119 |
| P2.1 | General information | 52 | 119 |
| P2.2 | Design | 53 | 119 |
| P2.3 | Drawings and calculations | 53 | 119 |
| P2.4 | Execution management | 53 | 119 |
| P2.5 | Materials | 53 | 119 |
| P2.6 | Project requirements | 54 | 119 |
| P2.7 | Water-resisting construction | 54 | 119 |
| P2.8 | Concrete and concreting | 54 | 119 |
| P2.9 | Further information | 54 | 119 |

National Structural Concrete Specification for Building Construction

Fourth edition complying with BS EN 13670: 2009

Standard Specification

Section 1 Scope

The NSCS has the same scope as BS EN 13670 for Building Structures.

The NSCS is laid out in terms of processes, and it uses the same sequence as BS EN 13670. European and British Standards are referenced rather than reproduced within the document.

The NSCS covers requirements for the construction of concrete building structures of in-situ concrete, precast concrete, and hybrid concrete systems. It is intended for use with structures designed to BS EN 1992, although it can be used when other design standards are used. Where the NSCS is to be used for structures in extreme environments, those produced by specialist construction techniques or those of a specialist design nature, the Project Specification should include the particular requirements where appropriate.

It is expected that the requirements for concrete in more specialist geotechnical works will be covered by a specification such as the ICE *Specification for piling and embedded retaining walls* (SPERW). The NSCS should be coordinated where required with other project specifications such as the SPERW.

The NSCS is written with safety in mind but does not specify Health and Safety requirements as they are legal regulations that apply to all construction and are inherent within this specification.

Where specifications, standards or regulations are referred to they shall refer to the latest editions unless reference is made to a specific dated clause in a standard.

Specific obligations are placed on the Constructor, the Employer and the Engineer. In some cases these will be different organisations; sometimes any or all will be represented by the same organisation. However, their responsibilities remain as required under the Contract.

The NSCS Project Specification is to be read in conjunction with this Standard Specification and outlines project information specific to a particular project that is additional to the requirements of Standard Specification.

The NSCS Project Specification covers the exchange of information necessary between the Employer and Constructor at tender stage and contract stage. Completion of the Project Specification is intended to be as required for the stage for which it is being used, i.e. at time of tender or contract commencement.

The NSCS Project Specification allows the Engineer responsible for the design the freedom to incorporate specific clauses to vary and add to the Standard Specification clauses. It is emphasised that the Standard Specification has been produced as a non-prescriptive specification to meet the standards required by BS EN 13670 and therefore any amendments through the Project Specification should be as few as possible.

The pro-forma layout of NSCS Project Specification acts as an aide memoire to the disclosure of relevant information for most types of project.

NSCS Guidance provides background information on the content and explains why certain clauses have been adopted. NSCS Guidance is designed to be 'dipped into', and read with the relevant clause in Standard and Project Specification; as a result there is some intentional duplication.

Section 2 Bibliography

2.1 Standards

| | |
|----------------------|---|
| BS 4449: 2005 | <i>Steel for the reinforcement of concrete – Weldable reinforcing steel – Bar, coil and decoiled product – Specification.</i> |
| BS 4483: 2005 | <i>Steel fabric for the reinforcement of concrete – Specification.</i> |
| BS 4486: 1980 | <i>Specification for hot rolled and hot rolled and processed high tensile alloy steel bars for the prestressing of concrete.</i> |
| BS 5896: 1980 | <i>Specification for high tensile steel wire and strand for the prestressing of concrete.</i> |
| BS 5975: 2008 | <i>Code of practice for temporary works procedures and the permissible stress design of falsework (incorporating corrigendum No. 1).</i> |
| BS 7973-1: 2001 | <i>Spacers and chairs for steel reinforcement and their specification – Product performance requirements.</i> |
| BS 8102: 2009 | <i>Code of practice for protection of structures against water from the ground.</i> |
| BS 8500-1: 2006 | <i>Concrete – Complementary British Standard to BS EN 206-1 – Part 1: Method of specifying and guidance for the specifier.</i> |
| BS 8500-2: 2006 | <i>Concrete – Complementary British Standard to BS EN 206-1 – Part 2: Specification for constituent materials and concrete.</i> |
| BS 8666: 2005 | <i>Scheduling, dimensioning, bending and cutting of steel reinforcement for concrete – Specification (incorporating amendment No. 1).</i> |
| BS EN 197-1: 2000 | <i>Cement – Compositions, specifications and conformity criteria for common cements.</i> |
| BS EN 206-1: 2000 | <i>Concrete – Specification, performance, production and conformity.</i> |
| BS EN 287-1: 2004 | <i>Qualification test of welders – Fusion welding – Steels (AMD Corrigendum 15578) (AMD 16275) (AMD Corrigendum 16831).</i> |
| BS EN 446: 2007 | <i>Grout for prestressing tendons – Grouting procedures.</i> |
| BS EN 447: 2007 | <i>Grout for prestressing tendons – Basic requirements.</i> |
| BS EN 1011-2: 2001 | <i>Welding. Recommendations for welding of metallic materials – Arc welding of ferritic steels (AMD 14926).</i> |
| BS EN 1090-2: 2008 | <i>Execution of steel structures and aluminium structures – Technical requirements for the execution of steel structures.</i> |
| BS EN 1990: 2002 | <i>Eurocode – Basis of structural design.</i> |
| BS EN 1991 | <i>Eurocode 1 – Actions on structures (10 parts). BSI, 2002–2006.</i> |
| BS EN 1992 | <i>Eurocode 2 – Design of concrete structures (3 parts). BSI, 2004–2006.</i> |
| BS EN 12350: 2009 | <i>Testing fresh concrete (7 parts).</i> |
| BS EN 12390: 2009 | <i>Testing hardened concrete (8 parts).</i> |
| BS EN 12812: 2004 | <i>Falsework – Performance requirements and general design.</i> |
| BS EN 13139: 2002 | <i>Aggregates for mortar.</i> |
| BS EN 13369: 2004 | <i>Common rules for precast concrete products.</i> |
| BS EN 13391: 2004 | <i>Mechanical tests for post-tensioning systems.</i> |
| BS EN 13670: 2009 | <i>Execution of concrete structures, and National Annex to BS EN 13670.</i> |
| BS EN ISO 4157: 1999 | <i>Construction drawings – Designation systems (3 parts).</i> |
| BS EN ISO 9000: 2005 | <i>Quality management systems – Fundamentals and vocabulary.</i> |
| BS EN ISO 9001: 2008 | <i>Quality management systems – Requirements (incorporating corrigendum July 2007).</i> |

| | |
|---------------------------|---|
| BS EN ISO 14001: 2004 | <i>Environmental management systems – Requirements with guidance for use.</i> |
| BS EN ISO 15614 | <i>Specification and qualification of welding procedures for metallic materials – Welding procedure test. (13 parts). BSI, 2002–2008.</i> |
| BS EN ISO/IEC 17025: 2005 | <i>General requirements for the competence of testing and calibration laboratories (AMD corrigendum 16767).</i> |
| BS OHSAS 18001:2007 | <i>Occupational health and safety management systems.</i> |

2.2 General

BAMFORTH, P. B. *Early-age thermal crack control in concrete*, C660. CIRIA, 2007.

CARES and European Technical Approvals:

CARES Post-tensioning systems, Part 2 – *The supply and/or installation of post-tensioning systems*. November 2007.

CARES Post-tensioning systems, Part 9 – *CARES Registration scheme for post-tensioning operatives*. November 2007.

CARES Steel for reinforced concrete, Appendix 6 – *Quality and operations assessment schedule for the tack welding of reinforcing steel*. January 2006.

CARES Steel for reinforced concrete, Appendix 10 – *Quality and operations assessment schedule for pre-assembled welded fabrications using welded semi-structural and/or structural joints*. January 2006.

EOTA. ETAG 013 *Guideline for European Technical Approval of post-tensioning kits for prestressing of structures*. Brussels, EOTA, 2002.

fib. *Corrugated plastic ducts for internal bonded post-tensioning*, fib Bulletin 7. fib, 2000.

HARRISON, T. A. *Formwork striking times – criteria, prediction and method of assessment*, R136. CIRIA, 1995.

ICE. *ICE Specification for piling and embedded retaining walls*, 2nd edition. Thomas Telford, 2007.

INSTITUTION OF STRUCTURAL ENGINEERS. *Standard method of detailing structural concrete. A manual for best practice*, 3rd edition. IStructE, 2006.

PALLET, P F. *Guide to flat slab falsework and formwork, CS140*. The Concrete Society, on behalf of CONSTRUCT, 2003.

THE CONCRETE SOCIETY. *Formwork – A guide to good practice*, CS030, 2nd edition. The Concrete Society, 1995.

THE CONCRETE SOCIETY. *Post-tensioned concrete floors – Design handbook*, TR43, 2nd edition. The Concrete Society, 2004.

Section 3 Definitions

The following definitions, in addition to those given in BS EN 13670: 2009, apply for the purpose of this Specification.

3.1 Agreement, acceptance

When by or of the CA, agreement or acceptance shall have the following limitations.

3.1.1 Samples

When given in respect of samples of materials, execution or proposals for methods of construction submitted in accordance with this Specification, shall not be interpreted as denoting any degree of satisfaction with the materials used in, or the execution of the Works.

3.1.2 Documents

When given in respect of drawings, documents, or schemes called for by the Specification or proposed by the Constructor, is only for conformity with the design concept and design information given in the Contract Documents or contained in subsequent instructions from the CA.

Acceptance or agreement shall not diminish or relieve the obligations of the Constructor under the Contract.

3.2 Contract Administrator (CA)

The named individual or company, engaged to act for and on behalf of the Employer for the purpose of accepting proposals from the Constructor, issuing technical information to the Constructor and monitoring the work of the Constructor.

3.3 Design calculations

The calculations produced generally by the Engineer. For some specialist work they may be produced by the Constructor.

3.4 Drawings and schedules

3.4.1 General arrangement drawings (GAs)

Plans and sections indicating the layout and dimensions of each floor of the Works. The drawings will be in sufficient detail to allow the formwork to be constructed and will show or reference all inserts or cast-in items and holes. Drawings should indicate the locations of concrete grades and finishes.

3.4.2 Design information drawings

Drawings prepared to show the design information required to enable reinforcement detail drawings to be produced.

3.4.3 Specialist drawings – prestressed concrete

Fully dimensioned drawings, plans and cross-sections of tendons and anchorage layouts indicating tendon profiles at regular intervals along each length, support details, stressing sequences etc. Stressing end, dead end anchorages, and any ordinary reinforcement sizes and locations required to supplement the post-tensioning design and bursting reinforcement at anchorages to suit anchor type and layout, shall be clearly defined.

3.4.4 Reinforcement detail drawings

Drawings prepared to show the layout of the various types of reinforcement used in the construction of the Works. They shall be prepared in accordance with the requirements of BS EN 1992 and the *Standard method of detailing structural concrete – A manual for best practice* (IStructE).

3.4.5 Builders' work drawings

Drawings prepared to show coordinated builders' work – holes, cast-in services and fixings, etc.

3.4.6 Temporary works and erection drawings

Drawings prepared to show necessary falsework, formwork and propping that are employed to construct the Works in a safe manner.

3.4.7 As-built drawings

Drawings to indicate what was built.

3.4.8 Reinforcement schedules

Schedules prepared to show the details of each bar to be cast into the concrete. They shall be prepared in accordance with BS 8666

3.4.9 Construction sequence information

Drawings, sketches or other information, prepared by the CA, indicating any special requirements or methods, which the Constructor must consider in the preparation of their temporary works in order to erect the Works in a safe manner.

3.5 Employer

The individual or company placing the contract with the Constructor.

3.6 Engineer

The individual or organisation responsible for the overall design of the Structure.

3.7 Manufacturer

For precast concrete proprietary products the manufacturer is the individual or organisation responsible for the design of the precast proprietary products.

3.8 Project specification

National structural concrete specification for building construction – NSCS Standard Specification and NSCS Project Specification.

3.9 Prestressed concrete

Concrete that is subjected to pre-tensioning or post-tensioning.

3.10 Reference panels

Full size concrete panels of Plain and Ordinary formed finishes located regionally by CONSTRUCT.

3.11 Site

The designated place where the Constructor will construct the Works.

3.12 Spacers

All chairs, blocks, supports and devices of a special nature required to hold the reinforcement in the correct position during concreting.

3.13 Temporary Works Coordinator

The named individual employed by the Constructor responsible for coordinating the temporary works for construction of the works.

Section 4 Execution management

4.1 General requirements

4.1.1 Standards

Execution shall be in accordance with BS EN 13670 as supplemented by the Project Specification and all statutory requirements.

Where there is a difference between the requirements of BS EN 13670 and the Project Specification, the Project Specification takes precedence.

4.1.2 Materials

4.1.2.1 General

All materials used in the structure shall comply with the Project Specification and current versions of standards referred to therein. The CA may specify samples for testing and the Constructor shall arrange for such samples to be supplied, identified, stored and tested and the results delivered to the CA in accordance with the relevant standards and the Project Specification requirements.

4.1.2.2 Proprietary products and materials

These shall be used in accordance with the manufacturer's written instructions and relevant European Product Standards where available.

4.1.2.3 Third-party inspections

Allow reasonable access to the site for technical inspection by third parties at all times.

4.1.2.4 Water-resisting construction

Where water-resisting construction is specified, submit to the CA for agreement: details of the materials used and the execution, which are to be in accordance with BS 8102; and written confirmation from the supplier of the water-resisting materials that they will not be adversely affected by the proposed environment, concrete, curing and release agents, placing methods, joints, finishes, reinforcement and its support details, or loads.

4.2 Documentation

4.2.1 Quality plan

Operate an agreed quality management system to BS EN ISO 9000 unless otherwise agreed with the CA. The system shall be accessible for audit.

If it is agreed that a quality management system to BS EN ISO 9000 is not required the Constructor shall prepare a quality plan for the project.

The Quality Plan shall be given to the CA for acceptance at least five working days before the works start.

4.2.2 Execution documentation

Produce the documents as required and provide one copy to the CA at the time stated in the NSCS Project Specification or no later than five working days after each is prepared.

4.2.3 Information coordination and availability

4.2.3.1 NSCS Project Specification

When NSCS Project Specification is revised all changes must be clearly identified.

4.2.3.2 Availability

Copies of all documents required for the construction of the structure, including all inspection reports, shall be available for review on site during the contract period.

4.2.3.3 Coordination

The Constructor shall ensure that the coordinated information they prepare (as required by the NSCS Project Specification Cl. P1.3, P1.4, P1.8, P1.10 & P1.11 and Section P2) is submitted to the CA for agreement in accordance with the requirements of NSCS Project Specification Tables P1.3 & P1.4.2.

4.2.4 Drawings and reinforcement schedules

4.2.4.1 Standards

To be in accordance with BS EN ISO 4157. Revisions, with the date made, and status shall be clearly shown. A circle or cloud around drawing revisions should identify the changes made for the latest revision symbol. The changes should be described in notes on the drawing corresponding to the latest revision symbol.

4.2.4.2 Register

The Constructor shall maintain a register of all drawings they receive and issue, identifying the source of the drawing, revision symbol and date received or issued by the Constructor.

4.2.4.3 Production

Drawings are to be produced as detailed in NSCS Project Specification Table P1.3. Where the drawings are to be prepared by a manufacturer of precast concrete products, or a specialist post-tensioning contractor, the Constructor is to ensure that the drawings are issued to the CA in accordance with the requirements of NSCS Project Specification Table P1.3.

4.2.4.4 Circulation

The method of circulation, number of drawings to be issued and dates for issue of drawings shall be in accordance with NSCS Project Specification Table P1.3, agreed with the CA and recorded in the quality plan.

4.2.4.5 Reinforcement schedules

The Constructor shall be responsible for the accuracy of any schedules that they produce.

4.2.4.6 As-built drawings

The Constructor shall provide sufficient information to the CA to allow coordination of the production of as-built drawings, where these are to be produced by the CA.

4.2.4.7 Builders' work drawings

Where the Constructor is to produce coordinated builders' work drawings the CA shall provide the required information in accordance with an agreed programme.

4.2.5 Construction planning – temporary works

The CA's construction sequence information must be considered in the preparation of the Constructors' temporary works drawings showing all stability requirements during erection.

Method statements for erection and dismantling of temporary works including all details of propping/repropping and backpropping through the structure are to be prepared by the Constructor and agreed with the CA.

4.3 Quality management

4.3.1 Execution class

The works are to be built in accordance with Execution Class 2, other than for post-tensioned construction where Class 3 is to be used, unless otherwise specified in NSCS Project Specification.

4.3.2 Setting out

Set out the structure to the given setting out information.

4.3.3 Inspection

In addition to the Constructor's inspection of the materials and execution in accordance with BS EN 13670 the Constructor is to give reasonable notice, as given in NSCS Project Specification, to allow inspection by the CA at the following stages:

- Before each concrete pour.
- Before prestressing work starts.
- Before covering up or backfilling.
- For water-resisting construction to allow inspection jointly with Constructor as Cl. 8.4.2 of this Specification.

4.3.4 Modifications

Obtain the written agreement of the CA to any modifications of this Specification before any work is started.

4.3.5 Storage

All materials shall be stored in an agreed manner that prevents damage or degradation and is in accordance with all manufacturers' requirements.

4.3.6 Acceptance procedure

The CA shall comment on all information supplied within five working days of receipt.

Acceptance or agreement by the CA shall have no effect unless given in writing.

4.3.7 Testing

Supply three copies of all test reports to the CA as soon as they are available.

4.3.8 Action in the event of a non-conformity

- Any test or inspection reports that show that any part of the structure does not meet the specified criteria shall be reported to the CA, as soon as the results are available.
- Provide proposals for dealing with the non-conformity to the CA within five working days of reporting the results.
- A course of action shall be agreed within a further five working days.

The cost of all additional testing and remedial works shall be at the Constructor's expense.

Section 5 Falsework and formwork

5.1 Standards

Design and construction should be in accordance with the following where applicable:

- BS 5975: *Code of practice for temporary works procedures and the permissible stress design of falsework*
- *Formwork: a guide to good practice* (Concrete Society Publication) CS030
- *Guide to flat slab falsework and formwork* CS140 (Pallet, 2003, Concrete Society publication on behalf of CONSTRUCT)
- CIRIA Report 136 *Formwork striking times – Criteria, prediction and method of assessment* (Harrison, 1995)
- BS EN 1990 & BS EN 1991
- BS EN 12812

5.2 Materials

Permanent formwork may be used subject to the agreement of the CA.

New timber and wood products should all be certified as legally sourced by CPET (The Central Point of Expertise on Timber) recognised schemes.

5.3 Release agents

Release agents shall be chosen to suit the method of construction and the finish required, and shall take note of the requirements of following trades. They shall not be adversely affected by the weather.

5.4 Formwork use

5.4.1 Ground support

Concrete shall not be cast directly against existing construction or faces of excavations without prior agreement of the CA. Where structural concrete relies on permanent or temporary support from the ground, ensure that the support is firm enough for concreting operations.

5.4.2 Cleanliness

Formwork shall be clear of all debris, water, snow and ice before concrete is placed.

5.5 Block outs and cast-in items

Set out and fix all cast-in items shown or referenced on the drawings. Any clashes between holes, cast in items and reinforcement shall be resolved to the agreement of the CA before any concrete is placed.

Block out items shall be cleared out after concreting.

5.6 Formwork ties

Through ties may be used to support vertical faces of formwork other than in water-resisting construction or as agreed with the CA.

No ferrous metals shall be left in the concrete cover zone when formwork has been struck.

Any holes left exposed to view in the faces of the concrete shall be filled to the agreement of the CA.

5.7 Loading, striking and backpropping

5.7.1 Temporary construction loads

Ensure the structure is not subjected to temporary loads during construction that will cause distress, taking account of the maturity of the concrete at the time of loading.

5.7.2 Striking

Falsework and formwork shall be struck at a time determined by the Constructor to comply with this Specification.

Formwork shall be removed carefully so as to avoid damage to the concrete surface.

5.7.3 Backpropping

The exact sequence of propping/repropping and backpropping through the structure, set out in a method statement by the Constructor, shall be agreed with the CA in advance, and should have no damaging effect on the Permanent Works

5.7.4 Cold weather concreting

Any special requirements for the formwork design, including any use of heated forms or changes in design formwork pressure for concreting in cold weather, shall be agreed with the CA in advance.

5.8 Construction joints and pour sizes

5.8.1 Geometry

Produce drawings showing the layout of construction joints and agree their location with the CA. Joints are to be positioned so as not to cause the structure any distress.

Pour sizes for different types of construction, except as agreed otherwise with the CA, shall be as shown below.

| Construction | Maximum area (m ²) | Maximum dimension (m) |
|--|--------------------------------|-----------------------|
| Water-resisting walls | 25 | 5 |
| Water-resisting slabs | 100 | 10 |
| Slabs with major restraint at both ends | 100 | 13 |
| Slabs with major restraint at one end only | 250 | 20 |
| Slabs with little restraint in any direction | 500 | 30 |
| Walls | 40 | 10 |

5.8.2 Joint preparation

Carefully prepare construction joint surfaces to expose the coarse aggregate to provide a key by a method to be agreed with the CA.

5.9 Water-resisting construction

5.9.1 Waterstops

Use waterstops in all construction joints and movement joints in accordance with the manufacturer's written instructions. Obtain the agreement of the CA for the methods to be used to

maintain them in their correct locations and prevent damage while the concrete is being placed and during or after removal of the Formwork.

Submit for agreement with the CA drawings indicating the positions of joints and details of waterstops to be used. Details shall include schedules of all junction pieces, which shall be purpose made, and isometric layouts of waterstops.

Where centre section waterstops are proposed submit to the CA for agreement the methods to be used to ensure full compaction of the concrete around the waterstop.

5.9.2 Formwork ties

Methods of fixing formwork that result in holes through the concrete section when formwork is removed shall not be used, unless agreed with the CA.

Formwork ties used shall be of a type to maintain water resistance of the construction.

Section 6 Reinforcement

6.1 Materials

6.1.1 General

6.1.1.1 Standards

All reinforcement shall comply with the requirements of BS 4449, BS 4483, and BS 8666 as appropriate.

Reinforcement in accordance with BS 4449 shall be Grade 500 unless otherwise specified in NSCS Project Specification.

6.1.1.2 Certification – supplier

Unless otherwise agreed by the CA, all reinforcement suppliers shall hold a valid Certificate of Approval for manufacture and/or fabrication issued by the UK Certification Authority for Reinforcing Steel (CARES), or equivalent. A supplier Certificate of Approval Reference shall be stated on all documentation.

6.1.1.3 Certification – cutting and bending

If reinforcing steel is cut and bent by other than a CARES-approved supplier, the fabricator shall operate a quality management system to BS EN ISO 9001, which shall be approved as part of the Constructor's quality management system and comply with BS 8666.

6.1.2 Reinforcement handling

6.1.2.1 Storage

All reinforcement shall be delivered in properly identifiable tagged bundles, mats or prefabricated assembly and shall be stored on site in a manner so as not to become contaminated by deleterious materials or otherwise damaged; fabric shall be stored flat.

6.1.2.2 Handling

Reinforcement shall not be dropped from height, mechanically damaged or shock loaded in any way.

6.1.2.3 Pre-assembled welded fabrications delivered to site

Only firms that have achieved certification to CARES SRC Appendix 10 – *Quality and operations assessment schedule for the manufacture of pre-assembled welded fabrications using welded semi-structural and/or structural joints*, or equivalent, shall be permitted to supply pre-assembled welded fabrications.

Only firms that have achieved certification to CARES SRC Appendix 6 – *Quality and operations assessment schedule for the tack welding of reinforcing steel*, or equivalent, shall be permitted to bid for or undertake contracts to supply pre-assembled tack-welded fabrications.

6.1.3 Spacers

6.1.3.1 General

Supply, detail and fix all spacers. The materials and workmanship shall be in accordance with BS 7973: *Spacers and chairs for steel reinforcement and their specification – Product performance requirements*. Ensure that the spacers have the required performance characteristics.

6.1.3.2 Exposed finishes

In exposed finish work the type of spacer used shall be agreed with the CA before any work is started.

6.1.4 Continuity strips

6.1.4.1 Supply

Proprietary continuity strips can be used subject to agreement by the CA.

6.1.4.2 Quality

All continuity strip manufacturers shall hold a valid CARES Technical Approval certificate or equivalent, unless otherwise agreed by the CA.

6.1.5 Couplers

6.1.5.1 Supply

Details of the source and suppliers shall be forwarded to the CA for agreement.

6.1.5.2 Quality

All coupler manufacturers shall have a valid Technical Approval certificate issued by CARES, or equivalent, unless agreed otherwise by the CA.

All coupler suppliers shall have a valid Technical Approval certificate issued by CARES, or equivalent, for the application of couplers, unless agreed otherwise by the CA.

Reinforcing bars shall be adequately and appropriately prepared by the supplier to receive the agreed couplers.

6.1.6 Punching shear reinforcement systems

6.1.6.1 Supply

Details of the source and suppliers shall be forwarded to the CA for agreement.

6.1.6.2 Quality

All punching shear reinforcement system manufacturers shall hold a valid Technical Approval certificate issued by CARES, or equivalent, unless otherwise agreed by the CA.

6.1.7 Fibre reinforcement

Unless fully described in NSCS Project Specification, details of the proposed fibres, dosage, source and suppliers shall be forwarded to the CA for agreement.

6.2 Execution

6.2.1 General

All reinforcement shall be fixed in position in accordance with the reinforcement detail drawings and reinforcement schedules. Any alterations of reinforcement shall be carried out only with the prior written agreement of the CA.

6.2.2 Tying

All tying of reinforcement shall be carried out with black annealed mild steel 16 gauge tying wire, unless agreed otherwise with the CA. All ends shall be bent away from the concrete face and all loose ends shall be removed prior to placing the concrete.

6.2.3 Welding

6.2.3.1 General

The location of all welded joints shall be agreed the CA. Tack welding on site will not be permitted, unless agreed with the CA in exceptional circumstances. Provide the CA with evidence of the competence of welders and details of the welding procedures for all loadbearing welds for agreement. When welding on site ensure the welding has adequate protection from the weather.

6.2.3.2 Quality

Welding shall be carried out in accordance with the requirements of BS EN 287-1, BS EN ISO 15614, BS EN 1011-2 and Appendices 6 and 10 to the CARES Steel for the Reinforcement of Concrete Scheme, or equivalent. Details for welding of reinforcement with a carbon equivalent greater than 0.42 must be agreed with the CA.

6.2.4 Projecting reinforcement

All reinforcement ends left projecting from cast concrete shall be free of release agents and shall be protected against damage and corrosion. Light surface rusting will be accepted, unless detrimental to the finished structure or causing rust staining to adjacent exposed concrete surfaces or formwork.

6.2.5 Site bending

6.2.5.1 Conditions

- Bending of reinforcement, including straightening, at temperatures less than -5 °C is not permitted.
- The curvature should be as constant as practicable.
- Bending should be in one operation at a constant rate.
- Reinforcement should not be warmed above 100 °C .
- The bend radius shall be not less than that given in BS 8666 and Cl. 6.3(2) of BS EN 13670: 2009 unless the documented re-bend properties show this can be adjusted.

6.2.5.2 Agreement

A method statement must be prepared for agreement with the CA.

6.2.5.3 Inspection

Inspect each bar bent for any sign of fracture. Any fractured bars must be considered as non-conforming.

Section 7 Prestressed concrete construction

Note: This section is for in-situ concrete post-tensioned construction.

7.1 Design and quality control

7.1.1 General

To be in accordance with CARES, or equivalent, procedures unless agreed in advance with the CA.

7.1.1.1 Contractors

Post-tensioning contractors shall have the necessary experience, knowledge, resources and equipment and CARES certification for the installation of post-tensioning systems in concrete structures as required by CARES Post-tensioning systems, Part 2 – *The supply and/or installation of post-tensioning systems*, or equivalent accredited product certification.

7.1.1.2 Operatives

All post-tensioning operations shall be carried out by operatives with appropriate knowledge, training and proven experience in carrying out similar operations. Supervisors and operators shall be trained and certified to meet the requirements given in the CARES Registration scheme for post-tensioning operatives, 2007, or equivalent. Trainee post-tensioning personnel shall be adequately supervised when performing post-tensioning activities.

7.1.1.3 Quality plan

Details required: Proposed materials, equipment, method statements, quality procedures, records, acceptance procedures, inspection and test arrangements.

7.1.1.4 Stressing calculations

The theoretical extensions shall be calculated by the post-tensioning Contractor. However, the CA may undertake the calculations but should request the values of the necessary parameters from the post-tensioning Contractor. All relevant system data shall be stated e.g. p, k, strand E value and area, wedge draw-in on lock off and any assumed movement at dead end, etc. Extension calculations shall be submitted to the CA for acceptance at least ten working days before stressing. The CA shall confirm agreement, or comment otherwise at least five working days before stressing.

7.1.1.5 Grout testing

Grout shall be tested as required by BS EN 446 and BS EN 447.

7.2 Materials

7.2.1 General

To be in accordance with the relevant parts of this Specification.

7.2.1.1 Grout

The properties of the grout, made with materials and plant proposed for use on site, shall be assessed for suitability for the intended purpose sufficiently in advance of grouting operations to enable adjustments to be made to the materials plant. Personnel proposed for grouting shall be suitably experienced in such work; provide details to the CA sufficiently in advance of such work to enable experience to be reviewed.

Grout shall consist of pre-bagged material requiring only the addition of a measured amount of water and shall comply with the requirements of BS EN 447.

7.2.1.2 Strand

Strand shall comply with BS 5896. The grade and diameter shall be specified and shall be relaxation class 2 and shall be obtained from firm(s) holding a valid CARES certificate of approval, or equivalent.

7.2.1.3 Stressing bar

Bar shall comply with BS 4486. The grade and diameter shall be specified and shall be obtained from firm(s) holding a valid CARES certificate of approval, or equivalent.

7.2.1.4 Coating material (unbonded tendons)

The coating to unbonded strand shall be 1 mm polypropylene unless otherwise stated in NSCS Project Specification.

7.2.1.5 Anchorages

Anchorages for post-tensioning systems shall comply with the minimum performance requirements of BS EN 13391. Documentary evidence of compliance shall be provided if requested.

7.2.1.6 Ducts and vents

Duct, vent and connection material shall be sufficiently robust to resist damage during construction. It should be smooth galvanised steel with a minimum wall thickness of 0.35 mm or corrugated galvanised steel with a minimum wall thickness of 0.30 mm. Where plastic ducts are used they should comply with fib Bulletin 7: *Corrugated plastic ducts for internal bonded post-tensioning*.

Ducting shall prevent the entrance of paste from the concrete, and shall not cause harmful electrolytic action or any deterioration of the tendon or tendon components. The internal cross-sectional area of the duct shall be at least twice the net area of the tendon's prestressing steel.

Ducting shall be capable of transmitting forces from grout to the surrounding concrete.

7.2.1.7 Other materials

All materials are to be in accordance with ETAG 013 Annex C.

7.3 Execution

7.3.1 Tendons

7.3.1.1 Location

Unbonded tendons may be deviated to avoid obstructions such as openings and columns with the agreement of the CA. The change of direction of the tendon should occur away from the opening and trimmer bars should be provided to avoid any possible cracking at the corners in accordance with TR43 *Post tensioned concrete floors – design handbook*, 2004, Cl. 6.7.

7.3.1.2 Fixing and support

Tendons shall be fixed and supported at centres not exceeding 1 m and shall be securely fixed to prevent movement and flotation during the construction process.

7.3.1.3 Cutting

Tendons shall be cut to length using mechanical means.

7.3.1.4 Marking

The actual position of tendons shall be marked on the slab soffit to indicate the location in both plan and elevation within the slab. The system of marking shall be agreed with the CA.

7.3.2 Vents

Vents shall be fixed at injection and exit points and, where tendon drape exceeds 500 mm, intermediate vents shall be fixed at tendon high points. Vents shall extend approximately 500 mm above the slab surface.

Intermediate vents should be used on tendons over 20 m in length.

7.3.3 Cutting or drilling into prestressed slabs

Where the tendon position is not accurately and authoritatively documented, reinforcement detection equipment must be used to locate tendon positions prior to any cutting or drilling work on the slab.

7.3.4 Stressing

7.3.4.1 Jacking force

The jacking force should not normally exceed 75% of the tendon's characteristic strength but may be increased to 80% provided that additional consideration is given to safety and the load extension characteristics of the tendon. At transfer, initial prestress shall not normally exceed 70% of the tendon's characteristic strength, and in no case shall exceed 75%.

7.3.4.2 Measurement

For routine stressing, load/extensions shall be measured prior to commencement of stressing, and after stressing and locking off to an accuracy of 2% or 2 mm whichever is more accurate. Measurements shall take into consideration the possible strand movement at the dead end anchor.

Any restrictions on stressing sequence and increments as specified in NSCS Project Specification shall be observed.

7.3.4.3 Commencement

Stressing shall not commence without prior agreement on theoretical extensions nor before the concrete has achieved the transfer strength specified in NSCS Project Specification. The concrete transfer strength shall be based on cubes taken from the last concrete load and cured in similar conditions to the concrete to which they relate.

7.3.5 Stressing equipment

Stressing jacks and their load measuring system should have an appropriate and current calibration certificate, which is traceable to national standards, and no more than 6 months old at the time of stressing. The calibration certificate should be provided by a NAMAS accredited laboratory and should include a calibration curve establishing a correlation between the values given by the measuring system and the loads applied by the jacks. The stressing equipment shall be capable of establishing a tendon load to an accuracy of $\pm 2\%$.

7.3.6 Anchorage protection

The method of anchorage sealing shall be agreed with the CA if not shown on the drawings.

For unbonded tendons anchorage components shall be coated with grease of similar specification to that used in the tendon and a watertight cap shall be applied over the coated area. The minimum concrete end cover to the cap shall be 25 mm.

7.3.7 Grout trials

Where required, full-scale grouting trials shall be carried out using the same personnel, equipment,

materials and procedures as proposed for the Works. The trial shall demonstrate that the proposed grouting method, materials and equipment fills the ducts to the satisfaction of the CA.

Trials shall be undertaken as early as possible to allow proper inspection and any necessary modifications or adjustments. The details of the trials to be carried out shall be agreed with the CA.

The trials shall reflect the actual duct geometry and shall include typical tendon arrangements. The tendons shall be nominally stressed to ensure that they assume the proper position with respect to the ducts. Trial beams shall normally be cut at five sections for examination but more sections may be specified for complex tendon profiles.

Grouting of the ducts shall normally be shown to leave no void which has a radial dimension greater than 5% of the maximum duct sectional dimension or which poses a risk to the integrity of the tendon. Particular attention shall be given to avoiding bleed collection or void formation at high points in the ducts or anchorages.

There shall be a procedure such as backup equipment or flushing out of ducts for corrective action in the event of breakdown or blockage.

Where it is agreed that a grout trial is not necessary, prior to starting work on site, inform CARES, or equivalent, of the commencement of operations and request an audit of the post-tensioning works. Provide the CA with the outcome of the audit. Should the audit highlight any areas of concern, demonstrate to the satisfaction of the CA that any works carried out before the audit are not defective.

7.3.8 Grouting equipment

Grouting equipment shall comply with the requirements of BS EN 446.

7.3.9 Grouting

Grouting shall be in accordance with BS EN 446.

7.4 Records

7.4.1 General

One copy of the following records shall be sent to the CA not more than five working days after each operation.

7.4.1.1 Anchorages

Data sheets and method statements for anchorage sealing.

7.4.1.2 Tendon installation

- Strand source and cast number
- Anchorage batch number
- Wedge batch number
- Duct batch number
- Location of the products within the structure

7.4.1.3 Stressing

- Date of stressing
- Strength and age of concrete samples, minimum age of concrete at transfer
- Equipment calibration date, operator name

- Serial numbers of gauges and jacks
- Tendon identification
- Theoretical extension, actual extensions and corresponding loads (where required), initial and final jacking loads

7.4.1.4 Grouting

- The materials used, including batch numbers
- Grout properties including temperatures
- Ambient temperature and weather conditions
- The date and time
- Details of any interruptions and any problems encountered during the grouting process, e.g. blockages, loss of grout or loss of grout pressure
- Name of the supervisor responsible for the operation
- Records for each individual duct, including inspection of end caps and vent tubes

Section 8 Concrete and concreting

8.1 Concrete

8.1.1 General

8.1.1.1 Standards

Concrete shall conform to BS 8500–2 and BS EN 206–1, and shall be as specified in NSCS Project Specification.

8.1.1.2 Materials

Portland cement, fly ash, ggbs and silica fume products shall be produced by certified suppliers operating BS EN ISO 14001 and BS OHSAS 18001 certified systems.

The chloride content of the proposed concrete including chlorides contained in the admixtures shall be limited in accordance with BS EN 206–1: 2000, Cl. 5.2.7 and BS 8500–2: 2006, Cl. 5.3. Provide evidence of conformity.

Calcium chloride shall not be included in any concrete.

Provide evidence of conformity to the provisions to minimise the risk of damage by alkali-silica reaction given in BS 8500–2: 2006, Cl. 5.2.

Recycled aggregate (RA) and recycled concrete aggregate (RCA) shall conform to BS 8500–2: 2006, Cl. 4.3.

Precautions shall be taken to restrict the amount of sulfate in the proposed concrete, based on past experience or when using RCA in accordance with BS 8500–2: 2006, Cl. 4.3.

No additions or changes to the fresh concrete shall be made after batching, without prior agreement of the CA.

8.1.1.3 Records

Submit, as appropriate, details of the proposed concretes in accordance with BS EN 206–1: 2000, Cl. 7.2 and BS 8500–1: 2006, Cl. 5.2 to the CA for approval.

Daily maximum and minimum atmospheric shade temperatures shall be recorded using a calibrated thermometer(s) located close to the structure.

8.1.1.4 Site addition of water to ready-mixed concrete

Water should not be added on site but IF it is added to the concrete truck mixer drum, before discharge on site, the concrete shall be deemed non-conforming – until identity testing for strength shows that the concrete is acceptable – unless the addition is made by the producer using a procedure agreed in advance with the CA.

8.1.2 Testing

8.1.2.1 Testing of fresh concrete

Where required to be in accordance with BS EN 12350.

8.1.2.2 Conformity testing

The concrete producer shall carry out testing of the concrete in accordance with BS EN 206 and BS 8500. Where the producer identifies a non-conformity that was not obvious at the time of delivery, this shall be reported to the CA and the Employer within 24 hours of the Constructor receiving notification.

8.1.2.3 Identity testing

Inform the producer if identity testing is required by NSCS Project Specification. The criteria for acceptance will be those given in BS EN 206–1: 2000, Appendix B and BS 8500–1: 2006, Annex B5.

8.1.2.4 Compression testing

Concrete test cubes prepared by the constructor, or his authorised agent, shall be manufactured, initially cured and subsequently transported to an independent laboratory, in accordance with BS EN 12390–2, for subsequent density and compressive strength testing in accordance with BS EN 12390–7 and BS EN 12390–3 respectively.

The independent laboratory shall be accredited by UKAS as conforming to BS EN ISO/IEC and hold a current schedule of accreditation for the required tests.

8.1.2.5 Delivery tickets

Delivery ticket information shall be in accordance with BS EN 206–1: 2000, Cl. 7.3 and BS 8500–2: 2006, Cl. 11 as relevant and shall be completed and available before discharging concrete into the structure. Where the Constructor authorises the addition of extra water this shall be recorded on the delivery ticket; see NSCS Standard Specification Cl. 8.1.1.4. All delivery tickets shall be retained by the Constructor until the structure is handed over to the Employer. Where a ticket is marked 'non-conforming' a copy shall be passed to both the Constructor and the CA within 24 hours of placing the concrete.

8.1.3 Plant – ready-mixed concrete

8.1.3.1 Third-party accreditation

Ready-mixed concrete shall be supplied by a producer from a plant holding current accredited third-party certification meeting requirements of BS EN 206–1: 2000, Annex C. Provide the CA with confirmation of the producer's certification in accordance with BS EN 206–1: 2000 Annex C.3.

8.1.3.2 Information required

Details of a ready-mix concrete plant proposed for use shall be forwarded to the CA. Contingency plans shall be in place prior to commencement of work should supplies be interrupted during a pour due to a plant breakdown. Where feasible, details of a suitable backup plant/supplier should be submitted to the CA for agreement.

8.1.4 Plant – other concrete

For supplies of concrete from sources other than plants holding current third-party certification, submit information to the CA that the production and conformity control systems used are in accordance with BS EN 206-1: 2000, Cl. 8, 9 and 10.1 and also BS 8500-2: 2006, Cl. 12 to 14.

8.1.5 Supply and transport

All concrete shall be supplied and transported to the point of discharge from the mixer/agitator truck in accordance with the requirements of BS EN 206-1: 2000, Cl. 7 and BS 8500-2: 2006, Cl.14.

8.2 Concreting

8.2.1 Placing and compaction

8.2.1.1 Placing

Concrete shall be placed and fully compacted so as to avoid cold joints, honeycombing and to minimise segregation, excessive blemishes or other defect in the hardened concrete.

8.2.1.2 Compaction

Compaction shall be carried out without causing damage or displacement of the formwork, reinforcement, tendons, ducts, anchorages, inserts etc.

8.2.1.3 Kickers

Where kickers are used, they shall be made with concrete of the same strength as that used in the wall or column, of sound construction and a minimum of 100 mm high generally and 150 mm high cast monolithically for water-resisting construction.

Where kickerless construction is used provide details of the proposed method of securing and sealing the column and wall shutters at floor joints to the CA for agreement.

8.2.1.4 Premature cessation

Suitable arrangements for premature cessation of a pour shall be agreed and in place before work starts. Should premature cessation of a pour arise, agree with the CA the extent and timing of any necessary remedial work before resumption of placing.

8.2.2 Concreting in extreme conditions

8.2.2.1 Cold weather

For concreting in cold weather, air temperature below 5 °C, agree in advance with the CA any changes to the cement, admixtures or concrete temperature to prevent freezing of the concrete, to limit extended stiffening times and to maintain the required concrete strength development.

8.2.2.2 Hot weather

For concreting in hot weather, air temperature above 30 °C, agree in advance with the CA any changes to the cement, admixtures or concrete temperature to minimize high temperature rises and reduction in the useful working life of the fresh concrete.

8.3 Curing

8.3.1 General

The Curing Class is 2 in accordance with BS EN 13670, unless otherwise specified in NSCS Project Specification. The surface of the concrete shall be cured to avoid premature drying out. Methods of

curing shall be agreed with the CA. Curing membranes shall be compatible with any finishes to be applied subsequently.

8.3.2 Early age thermal cracking

When concrete is to be placed in conditions or in an element where early age thermal cracking is likely, measures shall be adopted that minimise the risk of early age thermal cracking to a level acceptable to the CA. Ensure that the temperature of the concrete does not exceed 65 °C and that the temperature differential does not exceed the appropriate values given in CIRIA Report C660 (Bamforth, 2007), Table 7.1. Where a risk of thermal cracking is identified, the location of monitoring apparatus and interpretation of the values recorded shall be agreed with the CA prior to installation.

8.4 Inspection – post-concreting

8.4.1 General

At the end of the specified period of curing, the relevant work shall be inspected by the Constructor.

8.4.2 Water-resisting construction

For water-resisting construction, inspection shall be carried out jointly with the Constructor and CA before backfilling or covering up to identify defects which may lead to water penetration. Further inspection shall be jointly carried out to identify any water penetration after backfilling.

8.5 Surface cracking

8.5.1 General

Take all reasonable actions to minimise surface cracking, from all causes. Where cracking occurs that it is expected will result in corrosion of the reinforcement, unacceptable water leakage, impaired durability or reduced structural adequacy, it will be rectified as agreed with the CA.

Limits on cracking, unless specified in NSCS Project Specification, are:

- In general reinforced concrete superstructure isolated crack widths up to 0.3 mm
- In ground bearing slabs isolated crack widths up to 2.0 mm between panel joints
- In concrete slabs cast on metal deck formwork as part of a composite structure isolated crack widths up to 1.0 mm.

8.6 Surface finishes

8.6.1 Formed finishes

An Ordinary finish is to be provided unless otherwise specified in NSCS Project Specification.

8.6.1.1 Basic finish

There are no requirements for finish other than to enable adequate compaction, to provide adequate cover to reinforcement and to achieve specified tolerances.

8.6.1.2 Ordinary finish

There are no special formwork requirements for this finish. Concrete should be thoroughly compacted and the formed surface should be free from major inherent blemishes and honeycombing. There is no requirement for consistency of colour for the struck surface. Surface defects may be made good subject to agreeing a method with the CA. Steps at joints between forms to be a maximum of 5 mm.

Note: This type of finish can be seen at the CONSTRUCT regional reference panels. See NSCS Guidance Cl. 8.6.1.

8.6.1.3 Plain finish

A Plain concrete finish requires the careful selection of the concrete, release agent, and the use of good quality formwork. The concrete must be thoroughly compacted and all surfaces should be true with clean arrises. Only very minor inherent surface blemishes should occur, with no discolouration from the release agent or grout runs from adjacent pours. The struck surface should be of a consistent colour from the materials used. The arrangement of formwork panels and tie-bolt holes should be in a regular pattern. Steps at joints between forms to be a maximum of 3 mm. It is expected that this finish will not require making good. Details of any sample panels required are given in NSCS Project Specification.

Note: This type of finish can be seen at the CONSTRUCT regional reference panels. See NSCS Guidance Cl. 8.6.1.

8.6.1.4 Special finish

A Special finish requires the careful selection of the concrete, release agent, the use of good quality formwork and thorough compaction. Detailed requirements of the surface finish required, and any permitted further working or improvements to the as-struck finish are given in NSCS Project Specification. A sample panel will be required as described in NSCS Project Specification.

8.6.2 Unformed finishes

A Basic finish is to be provided unless otherwise specified in NSCS Project Specification.

8.6.2.1 Basic

The concrete shall be leveled by skip float, or similar process to produce a closed uniform surface. No further work shall be carried out.

8.6.2.2 Ordinary

The concrete shall be finished by floating or panning or a similar process, to produce a level, uniform surface. No further work shall be carried out.

8.6.2.3 Plain

The concrete shall be finished by trowelling, or a similar process, to produce a dense, smooth, level, uniform surface. No further work shall be carried out.

8.6.2.4 Special

To be produced by further working of a finish or other improvements as specified in NSCS Project Specification.

Section 9 Precast concrete

9.1 General

This section deals with additional considerations particular to structures partly or wholly of precast construction.

9.1.1 Details

The manufacturer shall operate an agreed quality management system to BS EN ISO 9000 unless agreed with the CA. Records of the unit mark, unit composition, date of casting, and curing regime

for each precast element shall be made by the manufacturer and kept available for inspection at the precast works.

9.1.2 Connections

Connection details are to be compatible with the design assumptions and should allow for the expected tolerances. Details are to be submitted to the CA for agreement.

9.1.3 Erection specification and work programme

An erection specification and work programme shall be prepared and agreed with the CA.

9.1.4 Identification

All marks shall be made so that they are hidden when unit is placed in position, or may be removed without marking the concrete surface.

9.2 Precast concrete products

Delivery notes are required for all products delivered to the site and must show relevant details of product conformity, as required by BS EN 13369 and the relevant product specification.

9.3 Precast concrete elements

All site-manufactured concrete elements must conform to the requirements of Sections 5, 6, 7 & 8 of NSCS Standard Specification.

9.3.1 Striking

The minimum period before removing the formwork is at the discretion of the Constructor on the basis of the assessed compressive strength of the precast element.

9.3.2 Lifting

No precast element shall be lifted from the base on which it was cast before the concrete has attained its design demoulding strength and is strong enough to prevent the precast element from being damaged, overstressed or distorted giving regard to the demoulding equipment to be used.

9.4 Handling and storage

9.4.1 General

Precast components shall be clearly marked before delivery in accordance with the erection specification to indicate their weight, location and orientation in the works in order to facilitate correct erection. Where delivery cannot be timed for direct final positioning, arrange suitable storage to ensure no deterioration or damage. Storage shall be on firm supports ensuring units are clear of the ground. Provide the CA with the storage proposals.

9.4.2 Protection

Precast component faces to be exposed in the finished construction are to be protected from mechanical damage, dirt, staining, rust marks and other disfiguration.

9.4.3 Reinforcement and fixings

The manufacturer shall determine the need for any additional reinforcement or fittings necessary for handling the precast components or other provisions required for temporary structural purposes

until the precast components are incorporated into the structure, including details for the making good of any provision made for lifting etc.

Any inserts or fixings required to be cast within the concrete and permanently exposed either externally or within the cavity of the building envelope shall be of stainless steel unless otherwise accepted by the CA. In other cases any protective treatment shall be as agreed with the CA.

9.5 Placing and adjustment

9.5.1 Temporary stability

Ensure that any precast concrete component to be incorporated into the structure shall be kept stable in its erected position until such time as the component can safely carry the construction loads without distress. The overall stability of the structure shall be maintained at all times during the erection process.

9.5.2 Bearings for precast products

Are to be level and not less than the minimum recommended by the manufacturer.

9.5.3 Cutting and drilling precast products

Submit proposals, agreed with the manufacturer, for acceptance by the CA.

9.5.4 Alignment of units

The units shall be positioned in the Frame to the tolerances given in Section 10, Geometric tolerances.

9.6 Jointing

9.6.1 General

All jointing to be as shown on the erection specification or agreed with the CA.

9.6.2 Materials

Grout material to comply with BS EN 197-1 and BS EN 13139.

Section 10 Geometric tolerances

10.1 General

The tolerances given in this section are NOT cumulative.

Carry out regular checks on the structure. If an element size or position is out of tolerance propose remedial measures for agreement with the CA.

10.1.1 Precedence

The following are the permitted tolerances for the structure as defined on the drawings. These tolerances take precedence over those given in BS EN 13670. All appropriate BS EN 13670 tolerances have been repeated for completeness of NSCS Standard Specification. The tolerances for position refer to the tolerance from the reference lines and datum given in NSCS Project Specification. Any deviation in secondary lines are included in the tolerances given.

The hierarchy of tolerance adopted in the NSCS is such that the tolerance of each level must be contained within the tolerance level of the level above where 1 is the highest level:

- First – The overall tolerance of the structure, Cl. 10.2, 10.3 and 10.4
- Second – The positional tolerance of all parts of elements of the structure within the overall tolerance, Cl. 10.5 and 10.6
- Third – The dimensional tolerance of the individual elements within their positional tolerance, Cl. 10.7, 10.11 and 10.12
- Fourth – The position tolerance of reinforcement and fixings within the individual elements dimensional tolerance, Cl. 10.8, 10.9 and 10.10

10.1.2 Tolerance class

Tolerance Class 1 is considered to be the normal tolerance as set out in BS EN 13670. Lesser deviations to meet design, fit requirements or any other reason shall be considered Class 2 and the required deviations are given in NSCS Project Specification.

Class 2 tolerances specified in NSCS Project Specification may apply to the whole structure or any part.

10.1.3 Execution class

Where Class 2 tolerances are given in NSCS Project Specification the execution will be to Execution Class 3.

10.1.4 Measurement

The tolerances given in Cl. 10.2.2, 10.6.5 & 10.6.6 below apply before the striking of the formwork. The tolerances given are before deformation caused by loading and time-dependent effects.

10.1.5 Reference grids

The location of the reference grids or primary lines and levels for the overall positioning of the Works shall be agreed by the CA and the Constructor before the structure is set out.

10.1.6 Box principle

The 'box principle' can be applied to the tolerances in NSCS Standard Specification. Where it is applied to the whole building the tolerances is as given by Cl. 10.2.1; where it is applied to an individual element the tolerance is ± 20 mm.

10.2 Overall structure

10.2.1 Inclination

Location of any column, wall or floor edge, at any storey level, from any vertical plane through its intended design centre at base level in a multi-storey structure.

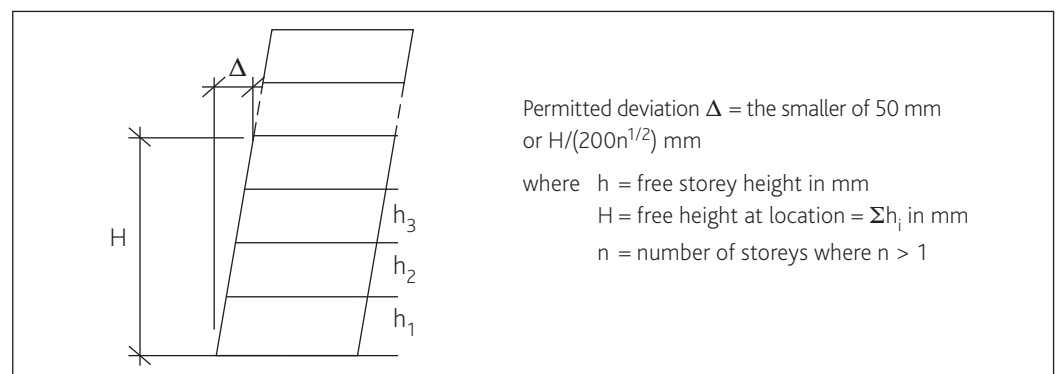

10.2.2 Level

Level of floors measured relative to the intended design level at the reference level.

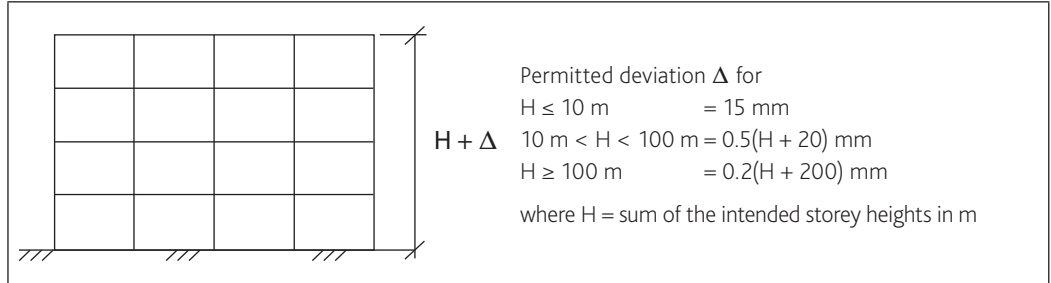

10.3 Base support (foundations)

Base supports shall include direct foundations and pile caps, etc. but not deep foundations such as piles, slurry walls, diaphragms, special anchorages, etc.

10.3.1 Plan section

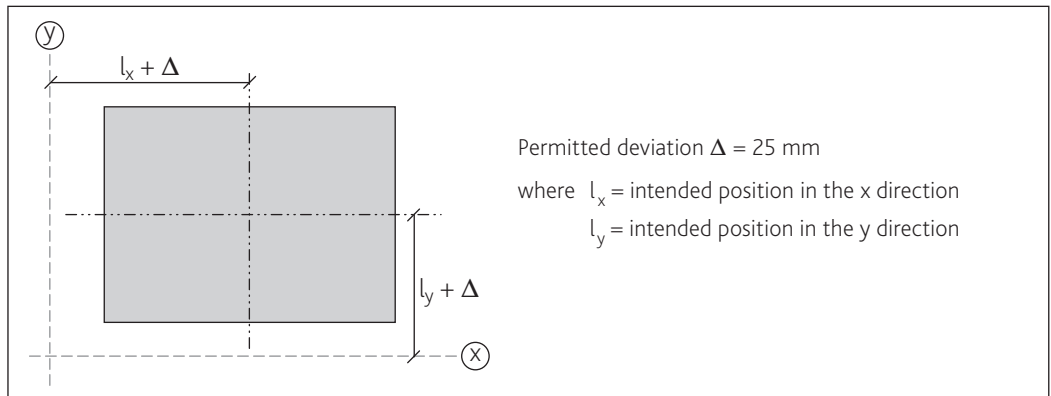

10.3.2 Vertical section

Position in the vertical direction of a base support relative to the intended design position.

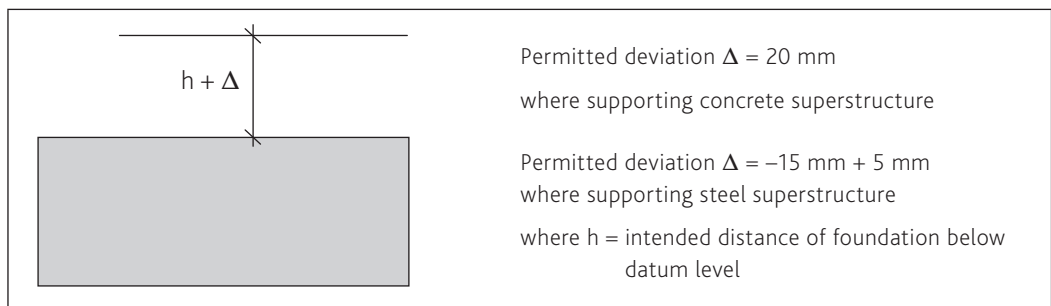

10.4 Foundation bolts and similar inserts

Note: Deviations are coordinated with BS EN 1090–2: 2008 Cl. D.2.20.

10.4.1 Preset bolt prepared for adjustment

- Distance of centre of a bolt group from intended design position
Permitted deviation = 6 mm
- Location of bolt at tip, from centre of bolt group
Permitted deviation $\Delta_y, \Delta_z = 10$ mm
- Protrusion
Permitted deviation $\Delta_p: -5 \text{ mm} \leq \Delta_p \leq 25$ mm

10.4.2 Preset foundation bolt not prepared for adjustment

- Distance of centre of a bolt group from intended design position
Permitted deviation = 3 mm
- Location of bolt at tip, from centre of bolt group
Permitted deviation $\Delta_y, \Delta_z = 3$ mm
- Vertical protrusion
Permitted deviation $\Delta_p: -5 \text{ mm} \leq \Delta_p \leq 45$ mm
- Horizontal protrusion
Permitted deviation $\Delta_x: -5 \text{ mm} \leq \Delta_x \leq 45$ mm

10.5 Elements – columns and walls

The deviation or sum of any deviations of any individual element must not exceed the overall building structure tolerance given in 10.2.

10.5.1 Position on plan

Position of the element centre line relative to:

- At base level the intended design position.
- At any upper level the actual location of the element at the level below.

Permitted deviation $\Delta = 10$ mm
where l = distance to centreline from grid line

10.5.2 Verticality by storey of the structure

Inclination of a column or wall at any level in a single- or multi-storey building.

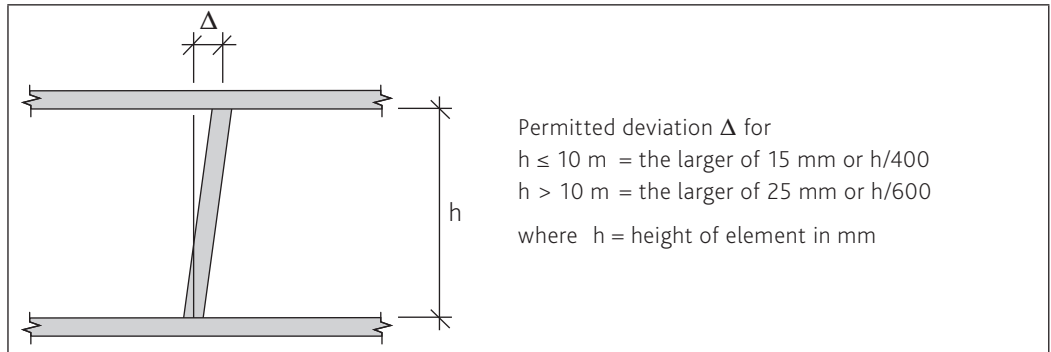

10.5.3 Offset between floors

Deviation between centrelines at floor level.

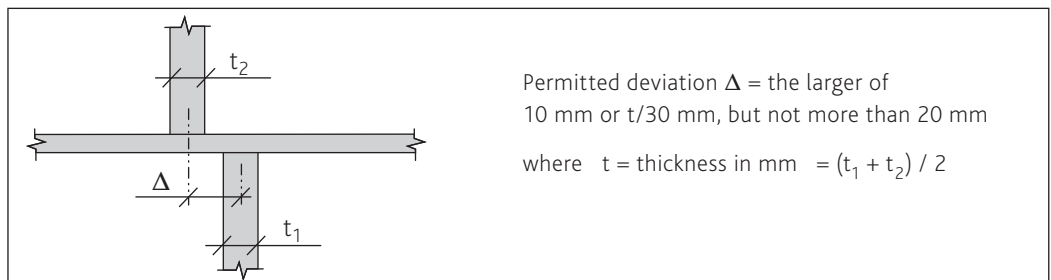

10.5.4 Curvature between adjacent floors

Curvature of an element between adjacent storey levels.

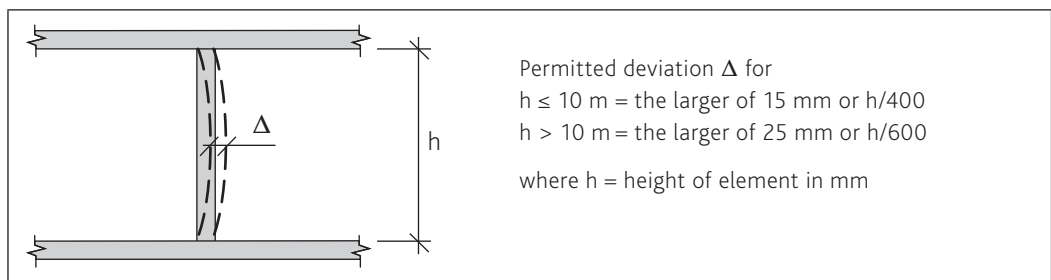

10.5.5 Level per storey of structure

Level of adjacent floors at supports.

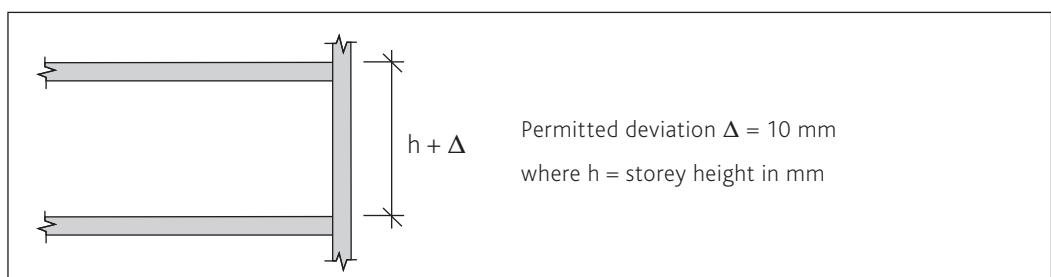

10.5.6 Distance between adjacent columns and walls

Distance between adjacent columns and walls, measured at corresponding points.

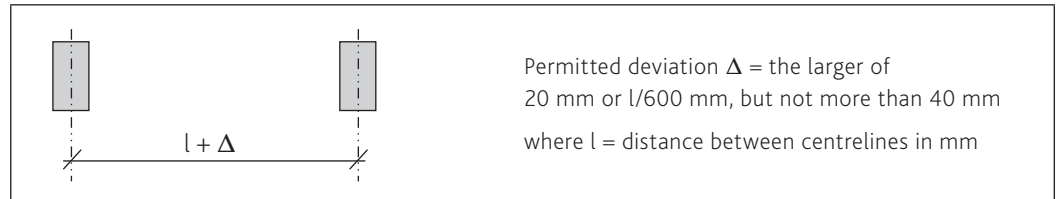

10.6 Elements – beams and slabs

10.6.1 Location of beam to column connection

Location of a beam to column connection measured relative to the column.

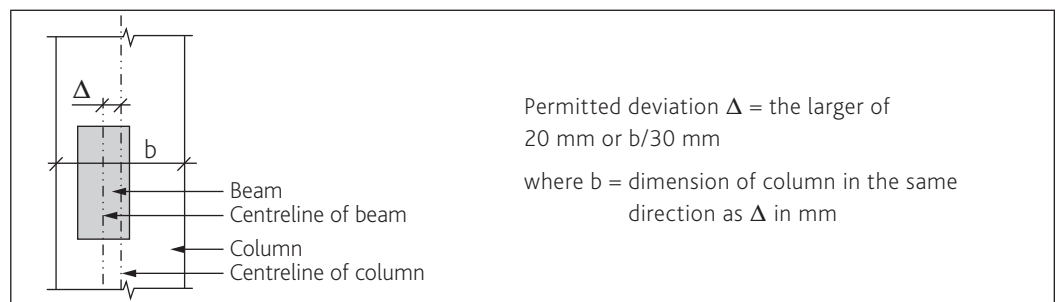

10.6.2 Position of bearing axis of support

Position of bearing axis of support when structural bearings are used.

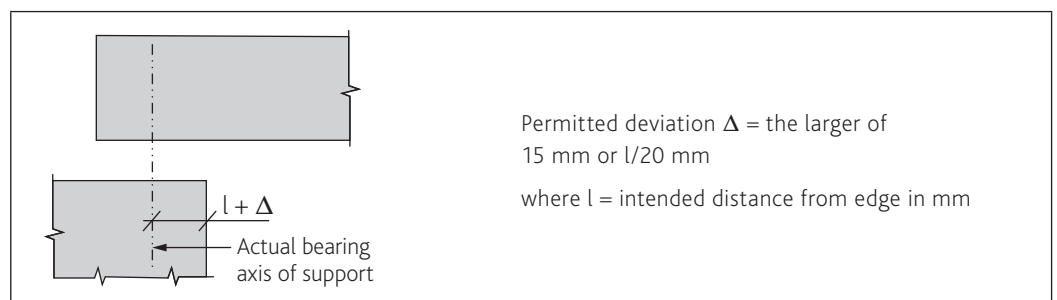

10.6.3 Straightness of beams

Horizontal straightness of beams.

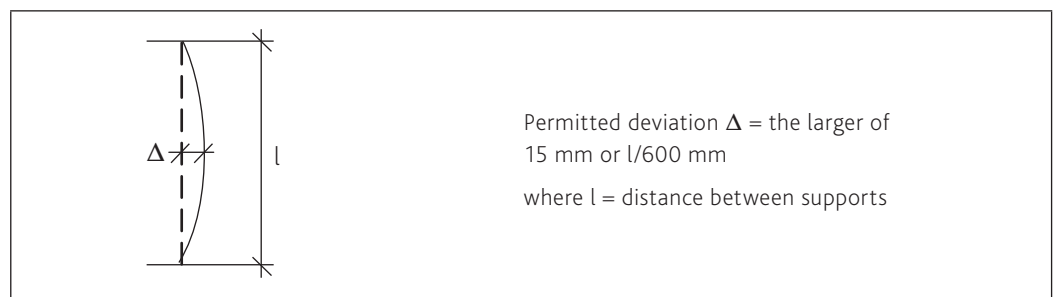

10.6.4 Distance between adjacent beams

Distance between adjacent beams, measured at corresponding points.

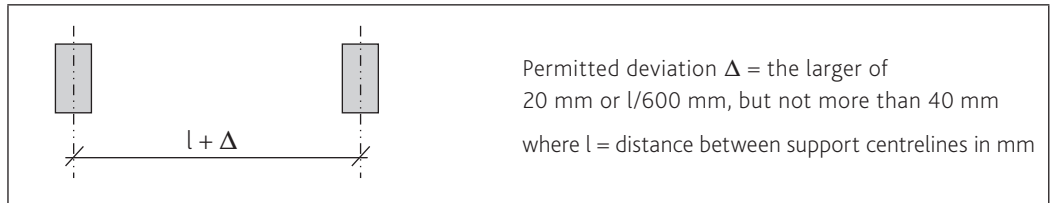

10.6.5 Inclination of beam or slab

Difference in level across a beam or slab at corresponding points in any direction.

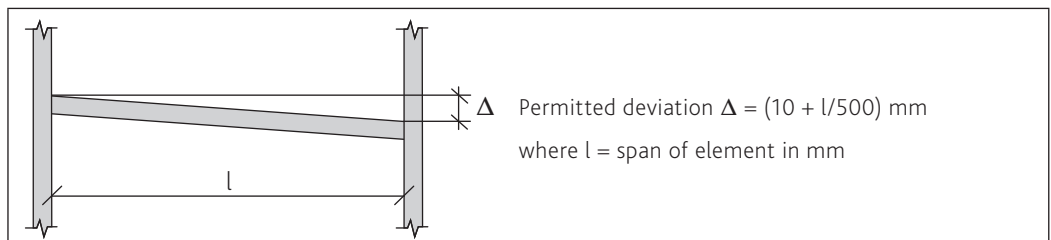

10.6.6 Level of adjacent beams

Level of adjacent beams, measured at corresponding points.

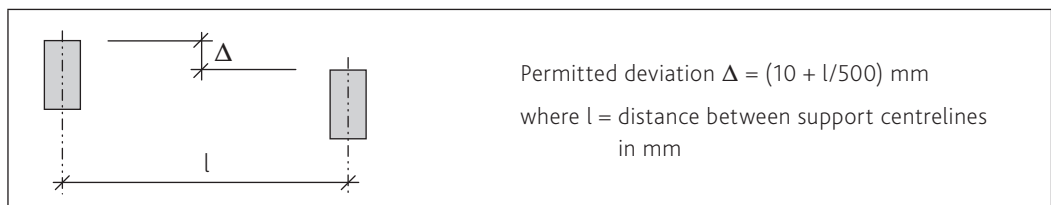

10.6.7 Position of slab edge

Position of slab edge relative to actual slab edge position on the floor below.

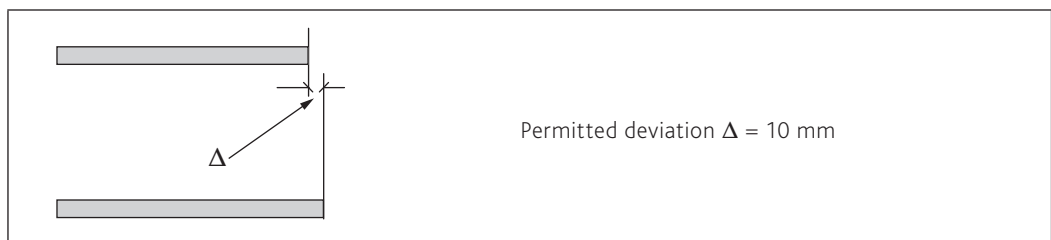

10.7 Section of elements

10.7.1 Cross-section dimension of elements

Applicable to beams, slabs, columns and other elements covering length, breadth and depth.

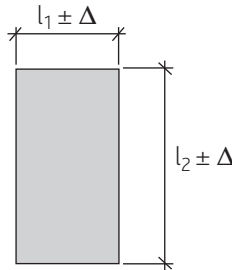

Permitted deviation Δ = for

- $l \leq 150 \text{ mm} = 10 \text{ mm}$
- $l = 400 \text{ mm} = 15 \text{ mm}$
- $l \geq 2500 \text{ mm} = 30 \text{ mm}$

with linear interpolation for intermediate values
where l_1, l_2 = intended dimensions

10.7.2 Squareness of element

Applicable to beams, slabs, columns and other elements.

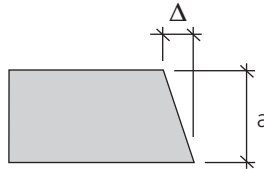

Permitted deviation Δ = the larger of
10 mm or $a/25$ mm, but not more than 20 mm
where a = length in mm

10.8 Position of reinforcement within elements

10.8.1 Location of reinforcement

Gives the tolerance of cover to reinforcement within an element.

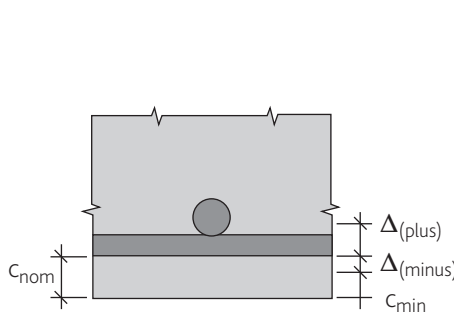

Permitted deviation $\Delta_{(\text{plus})}$ for

- $h \leq 150 \text{ mm} = +10 \text{ mm}$
- $h = 400 \text{ mm} = +15 \text{ mm}$
- $h \geq 2500 \text{ mm} = +20 \text{ mm}$

Permitted deviation $\Delta_{(\text{minus})} = 10 \text{ mm}$
where c_{min} = required minimum cover
 c_{nom} = nominal cover given on drawings
 Δ = permitted deviation from c_{nom}
 h = height of cross section

For foundations and members in foundations, permitted plus-deviations may be increased by 15 mm. The given minus-deviations apply.

10.8.2 Length of reinforcement lap joints

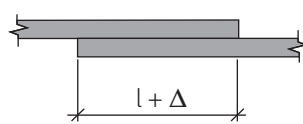

Permitted minus-deviation $\Delta = 0.06l \text{ mm}$
where l = intended lap length in mm

10.8.3 Location of reinforcement and ducts in prestressed elements

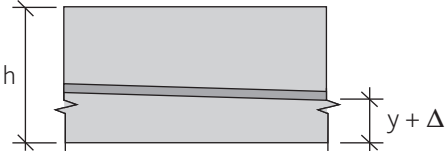

- Anchorages
Permitted location deviation Δ
= 25 mm horizontally
5 mm vertically
- Tendons
Permitted deviation Δ
Horizontally
in beams = $0.03h$ (width) ≥ 5 mm ≤ 30 mm
in slabs = 150 mm
Vertically
 $\Delta_{(\text{plus})}$ if $h < 200$ mm = $+h/40$
if $h > 200$ mm = +15 mm
 $\Delta_{(\text{minus})}$ all h = -10 mm
where h for vertical section = depth in mm
 h for plan section = width in mm
 y = intended location in mm

10.9 Surface straightness

10.9.1 Flatness

Flatness of surface of any element.

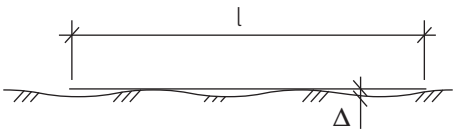

- Basic unformed surface (Cl. 8.6.2.1)
Permitted global deviation $\Delta = 12$ mm
Permitted local deviation $\Delta = 5$ mm
- Ordinary unformed surface (Cl. 8.6.2.2)
Permitted global deviation $\Delta = 9$ mm
Permitted local deviation $\Delta = 3$ mm
- Ordinary surfaces (Cl. 8.6.1.2)
Permitted global deviation $\Delta = 9$ mm
Permitted local deviation $\Delta = 5$ mm
- Plain surfaces (Cl. 8.6.1.3)
Permitted global deviation $\Delta = 9$ mm
Permitted local deviation $\Delta = 3$ mm

10.9.2 Edge straightness

Straightness of edge of floor slab or element.

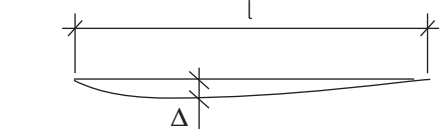

Permitted deviation Δ for
 $l < 1$ m = 8 mm
 $l > 1$ m = 8 mm/m, but no greater than 20 mm
 where l = length of edge

10.10 Holes and fixings

10.10.1 Holes

Size and location of hole relative to design position.

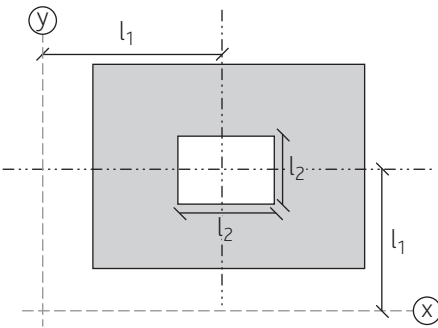

- Position
Permitted deviation $\Delta_1 = 10 \text{ mm}$
where $l_1 =$ intended distance to centre line
- Size
Permitted deviation $\Delta_2 =$
 $l_2 \leq 150 \text{ mm} = 6 \text{ mm}$
 $l_2 = 400 \text{ mm} = 15 \text{ mm}$
 $l_2 \geq 2500 \text{ mm} = 30 \text{ mm}$
 with linear interpolation for intermediate values
 where $l_2 =$ intended dimension

10.10.2 Cast-in fixings

Location of fixing or groups relative to the intended design position.

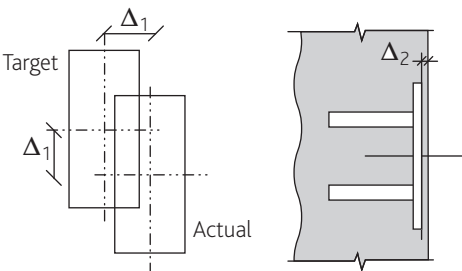

- Deviation in plane
Permitted deviation $\Delta_1 = 10 \text{ mm}$
- Deviation in depth
Permitted deviation $\Delta_2 = 10 \text{ mm}$

10.10.3 Cast-in bolts and similar fixings

Location of fixing or groups relative to the intended design position.

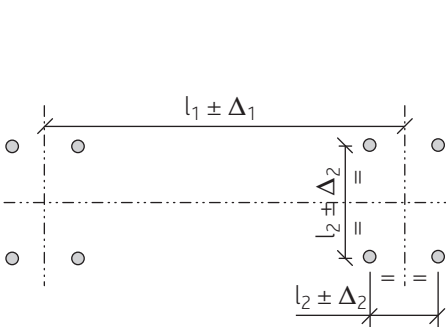

- Location of fixing or groups relative to the intended design position
Permitted deviation $\Delta_1 = 6 \text{ mm}$
where $l_1 =$ distance between bolt groups
- Internal distance between fixings in a group relative to the intended design position
Permitted deviation $\Delta_2 = 3 \text{ mm}$
where $l_2 =$ distance between bolts
- Protrusion of fixing
Permitted deviation = $\Delta_{(\text{plus})} + 25 \text{ mm}$
 $\Delta_{(\text{minus})} - 5 \text{ mm}$

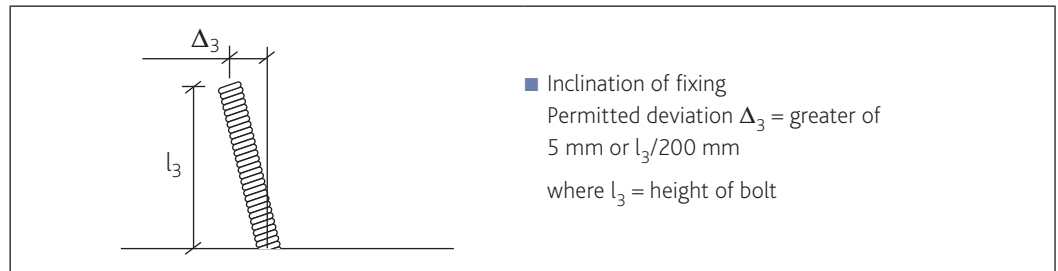

10.11 Staircases

The permitted deviation in the height of any riser is 5 mm of the intended design value.
The permitted deviation in the length of any going is 5 mm of the intended design value.

10.12 Precast concrete elements

10.12.1 Standard precast products

Standard precast products shall comply with the tolerances given in the relevant product standards.

10.12.2 Project designed precast elements

Concrete elements produced for the project shall comply with the tolerances for: sections of elements; position of reinforcement within elements; surface straightness; and holes and fixings given above.

National Structural Concrete Specification for Building Construction

Fourth edition complying with BS EN 13670: 2009

NSCS Project Specification

Foreword

The Specification that follows shows what is required in a Project Specification using the NSCS Standard Specification.

This specification as shown in this document is not intended to be completed. An interactive copy of the Project Specification has been produced for electronic completion without infringement of copyright.

The interactive NSCS Project Specification is available by downloading from www.construct.org.uk

or by obtaining a CD from

CONSTRUCT, Riverside House, 4 Meadows Business Park, Station Approach, Blackwater, Camberley, Surrey GU17 9AB, UK

Tel +44 [0]1276 38444 **Fax** +44 [0]1276 38899 **Email** enquiries@construct.org.uk

NSCS Project Specification

- i) The specification for the structure shall be the National Structural Concrete Specification for Building Construction (NSCS).
- ii) The NSCS Project Specification is provided by the Employer and identifies the appropriate information specific to the structure over and above that stated in NSCS Standard Specification. Clauses in the Standard Specification may be modified by information given in the Project Specification.

Project name

Project ref.

Revisions

| Revision | Date | Clauses | | | Notes |
|----------|------|---------|---------|-------|-------|
| | | Deleted | Amended | Added | |
| | | | | | |

Prepared by

Date

Section P1 Information to be supplied TO the Constructor

P1.1 General information

P1.1.1 Project contacts

| | |
|--------------|--|
| Project name | |
| Project ref. | |
| Address | |

Employer

| | | | |
|--------------|--|-------|--|
| Name | | | |
| Address | | | |
| Contact name | | | |
| Telephone | | Email | |

Principal Contractor

| | | | |
|--------------|--|-------|--|
| Name | | | |
| Address | | | |
| Contact name | | | |
| Telephone | | Email | |

Engineer

| | | | |
|--------------|--|-------|--|
| Name | | | |
| Address | | | |
| Contact name | | | |
| Telephone | | Email | |

Contract administrator (CA)

| | | | |
|--------------|--|-------|--|
| Name | | | |
| Address | | | |
| Contact name | | | |
| Telephone | | Email | |

Other named parties to the Contract:

| | | | |
|------|--|--|--|
| Name | | | |
| Name | | | |

P1.1.2 Description of the project works

Nature of building and intended use, number of floors, column grids, stair and core, stability system, foundations, basements, location of water-resisting construction, special finishes, relevant project sustainability targets and procedures, etc.

| |
|--|
| |
|--|

P1.1.3 Construction planning requirements

Note: the information here is largely reproduced from the Contract Documents to assist the Constructor in the preparation of Section P2. The Constructor should notify the CA if any discrepancy is identified between the Contract Documents and the Specification.

Where details of the site conditions are provided, such as underground services, overhead cables, adjacent buildings and site obstructions, they are given to assist the Constructor in their tender stage planning. The Constructor should always confirm the accuracy of this information when on site, before starting work.

General

Positions of the Reference Line (as defined in BS EN 13670) datum level and setting-out lines, width and level of access, level of the prepared working area for site traffic, cranes and pumps, and areas available for storage and site accommodation are shown on drawing numbers:

Details of underground services, overhead cables, adjacent buildings, site obstructions or other constraints on the Constructor:

Availability of site services and any prearranged procedures for sole or shared use:

Factors affecting construction sequence, including working restrictions on time or special nuisance (including noise); or other aspects that may create an unusual hazard:

Special requirements for temporary propping:

Restrictions on dimensions and/or weights of units to be delivered to site:

Interface requirements/restrictions between the works and following trades:

Special requirements for headroom:

A programme showing clearly any phased requirements and the earliest and the latest release dates of work to following trades or to the Employer is shown on drawing numbers:

Access will be made available to the Constructor on:

Environmental factors relating to achievement of Considerate Constructors or Site Waste Management requirements:

P1.2 Design

P1.2.1 General

The design has been carried out in accordance with BS EN 1990, BS EN 1991 and BS EN 1992. Any design by the Constructor is to be carried out in accordance with these codes and the design data given in this specification.

| |
|--|
| |
|--|

P1.2.2 Loading

| Loading (kN/m ²) | | Location | Location | Location | Location | Location |
|------------------------------|-------------|----------|----------|----------|----------|----------|
| Imposed | General | | | | | |
| | Partitions | | | | | |
| Total imposed | | | | | | |
| Dead load | Self-weight | | | | | |
| | Partitions | | | | | |
| | Flooring | | | | | |
| | Screed | | | | | |
| | Services | | | | | |
| | Ceiling | | | | | |
| Total dead load | | | | | | |
| Cladding | | | | | | |
| Wind | | | | | | |
| Other | | | | | | |

P1.2.3 Other design data

| Design data | Location | Location | Location | Location | Location |
|-------------------------------------|----------|----------|----------|----------|----------|
| Fire rating (hours) | | | | | |
| Exposure Class | | | | | |
| Design life (years) | | | | | |
| Maintenance/replacement assumptions | | | | | |
| Other | | | | | |

P1.2.4 Special requirements for composite structures

| |
|--|
| |
|--|

P1.3 Drawings and calculations

Project values should be entered in the grey panels.

| Item Type ¹ | Preparation | | | Tender issue | | Acceptance issue | | | | Construction issue | | | | | | |
|---|-------------|-------------------------|------------------|--------------|------------------|------------------|------------------------------------|---------|------------------|--------------------|------------------------------------|-------------------------|---------|--|----|--|
| | Prepared by | Format ² | Number of copies | | Number of copies | | Period before construction (weeks) | | Number of copies | | Period before construction (weeks) | | | | | |
| | | | Project | Default | Project | Default | Project | Default | Project | Default | Project | Default | Project | | | |
| General arrangement drawings | RC | CA | | 2 | | | | | | | | 11 | | | | |
| | PCP | CA | | 2 | | | | | | | | | | | 11 | |
| | PCE | CA | | 2 | | | | | | | | | | | 11 | |
| | PSC | CA | | 2 | | | | | | | | | | | 11 | |
| Design Information drawings | RC | CA | | | | | | | | | | 11 | | | | |
| | PCP | CA | | | | | | | | | | | | | 11 | |
| | PCE | CA | | | | | | | | | | | | | 11 | |
| | PSC | CA | | | | | | | | | | | | | 11 | |
| Construction sequence info | All | CA | | 2 | | | | | | | | 11 | | | | |
| Design calculations | RC | Constructor | | | | 3 | | 8 | | 5 | | 5 | | | | |
| | PCP | Manufacturer | | | | 3 | | 8 | | 5 | | 5 | | | | |
| | PCE | Constructor | | | | 3 | | 8 | | 5 | | 5 | | | | |
| | PSC | Constructor | | | | 3 | | 8 | | 5 | | 5 | | | | |
| Specialist drawings | RC | Enter CA or Constructor | | | | 3 | | 8 | | 5 | | 5 | | | | |
| | PCP | Constructor | | | | 3 | | 8 | | 5 | | 5 | | | | |
| Enter details as required | PCE | Constructor | | | | 3 | | 8 | | 5 | | 5 | | | | |
| | PSC | Constructor | | | | 3 | | 8 | | 5 | | 5 | | | | |
| Reinforcement detail drawings and schedules | RC | Enter CA or Constructor | | | | 3 | | 7 | | 5 | | 5 | | | | |
| Precast concrete elements | PCP | Manufacturer | | | | | | | | | | | | | | |
| | PCE | Constructor | | | | 3 | | 3 | | 5 | | 3 | | | | |
| | PSC | Constructor | | | | 3 | | 3 | | 5 | | 3 | | | | |
| Builders' work information | All | CA | | | | 3 | | 3 | | | | | | | | |
| Coordinated builders' work drawings | All | Enter CA or Constructor | | | | 3 | | 3 | | 5 | | 2 | | | | |
| Temporary works and erection drawings and/or calculations and method statements | All | Constructor | | | | 3 | | 3 | | 5 | | 2 | | | | |
| As-built drawings | All | Enter CA or Constructor | | | | | | | | 3 | | Months after completion | | | | |
| | | | | | | | | | | | | 3 | | | | |

Footnotes

1 Types of construction:

RC: Reinforced concrete

PCE: Precast concrete elements

PCP: Precast concrete products in accordance with product standards

PSC: Prestressed concrete

2 Enter P = paper; E = electronic; B = both

P1.4 Execution management

P1.4.1 Execution Class

The following parts of the structure are to be constructed in accordance with execution Class 3:



P1.4.2 Execution documentation

The following documentation is required:

Project values should be entered in the grey panels.

| Information | When required | | Format/Notes | |
|---|--|---------|-------------------------|---------|
| | Default | Project | Default | Project |
| Contractor's Quality Assurance Certification | At tender | | Paper | |
| SpeCC registration, or equivalent | As requested | | Paper | |
| Detailed construction programme | 20 | | Paper | |
| Falsework and formwork: design | 20 | | Calculations & drawings | |
| Falsework and formwork: pre-concreting cleanliness | As requested | | Paper | |
| Reinforcement: source and supplier | 20 | | Paper | |
| Reinforcement: Certification | 20 | | Paper | |
| Reinforcement: pre-concreting location | As requested | | Paper | |
| Spacers | As requested | | Paper | |
| Couplers: source and supplier | 20 | | Paper | |
| Couplers: Certification | 20 | | Paper | |
| Continuity strips: source and supplier | 20 | | Paper | |
| Continuity strips: Certification | 20 | | Paper | |
| Post-tensioning work: | | | | |
| Certification | 20 | | Paper | |
| Specific quality plan | 20 | | Paper | |
| Other information | As Cl. P1.14 | | Paper | |
| Concrete: ready-mix plant details | 20 | | Paper | |
| Concrete: ready-mix producers' certification | 20 | | Paper | |
| Concrete: delivery ticket | As requested | | Paper | |
| Concreting: method statement and pour sequence for each section of the work | 5 | | Paper | |
| Precast concrete | As Table P1.10 | | Paper | |
| As-built geometry: setting out and dimensions | 10 working days after the construction is complete at each level | | Paper | |
| As-built geometry: reinforcement cover | As requested | | Cover meter survey | |
| Environmental certification and responsible sourcing documentation where required: relating to reinforcement, aggregate, cementitious materials, formwork and concrete supply | 20 | | Paper | |

P1.4.3 Approvals timing

The timings given in NSCS Standard Specification apply to all approvals except as noted below.

Project values should be entered in the grey panels.

| Standard Specification clause ref. | Item | Requirements Before or after as appropriate Working days unless stated | |
|------------------------------------|---|--|---------|
| | | Default | Project |
| 4.1.2.1 | Material test results | 10 | |
| 4.2.1 | Quality plan | 5 | |
| 4.3.3 | Notice to CA for concrete pour inspection | 1 | |
| 4.3.3 | Before prestressing work starts | 1 | |
| 4.3.3 | Before covering up or backfilling | 5 | |
| 4.3.3 | For water-resisting construction to allow joint inspections | 5 | |
| 4.3.4 | Response by CA to request for modifications | 5 | |
| 4.3.7 | Copies of test results | 3 No. | |
| 4.3.8 | Proposal and response time for work rectification | 5 & 5 | |
| 6.2.1 | Notice to CA for site changes to reinforcement | 1 | |
| 7.1.1.4 | Extension calculations for post-tensioning tendons | 10 | |
| 7.3.1.1 | Notice to CA for site changes to post-tensioning tendons | 1 | |
| 7.4.1 | Grouting records | 5 | |
| 8.1.2.1 | Concrete non-conformity | 24 hours | |
| 8.2.1.3 | Method of fixing kickerless shutters | 5 | |
| 8.2.1.4 | Premature cessation of a pour | 2 hours | |
| 9.1.2 | Precast connection details | 15 | |
| 9.1.3 | Precast erection specification and work programme | 5 | |
| 9.5.3 | Proposals for cutting standard precast products | 5 | |
| Other | | | |

P1.4.4 Inspection

Items not defined in table 1 of BS EN 13670 shall be inspected as follows:

Additional third-party inspection, carried out by is required of the following parts of the structure:

P1.4.5 Documents

The following **special documentation** is required:

Requirements for **responsible sourcing** documentation:

P1.4.6 As-built geometry

The **overall concrete** dimension shall be checked:

| List of requirements | Frequency |
|----------------------|-----------|
| | |

The **cover to reinforcement** shall be checked:

| List of requirements | Frequency |
|----------------------|-----------|
| | |

P1.4.7 Curing class

List where curing classes other than 2 shall be used:

| Class | Location |
|-------|----------|
| | |

P1.4.8 Protection

The following special protection is required:

| |
|--|
| |
|--|

P1.5 Materials

P1.5.1 Reinforcement

Stainless steel reinforcement shall be used in the following locations:

| |
|--|
| |
|--|

Epoxy coated steel reinforcement shall be used in the following locations:

| |
|--|
| |
|--|

Anchorage and couplers shall be:

| |
|--|
| |
|--|

Fibres shall be used as follows:

| Type of fibres | Location & dosage |
|----------------|-------------------|
| | |

Requirements for responsible sourcing of reinforcement:

| |
|--|
| |
|--|

P1.5.2 Timber

Requirement for **responsible sourcing** of timber or timber products:

| |
|--|
| |
|--|

P1.5.3 Other materials

Materials not permitted:

Materials requiring special consideration:

Items supplied by the Employer:

Requirement for **responsible sourcing** of materials:

Materials to be supplied under **Constructor-specified supply**:

P1.6 Project requirements

Enter variations from NSCS Standard Specification

| Standard Spec. clause ref. | Change N: new D: deleted M: modified | Description |
|----------------------------|--|-------------|
| | | |

P1.7 Water-resisting construction

P1.7.1 Detail

The required performance for water-resisting construction is to be achieved by the use of materials and details listed below and as shown on construction drawings.

| Location | Detail | Waterstops | Separation membranes | Joint fillers |
|--------------------------------------|--------------|------------|----------------------|---------------|
| | Manufacturer | | | |
| | Material | | | |
| Slab: horizontal construction joints | Type | | | |
| Slab: horizontal movement joints | Type | | | |
| Wall: horizontal slab/wall junction | Type | | | |
| Wall: vertical construction joint | Type | | | |
| Wall: vertical movement joint | Type | | | |

or

Constructor selection and installation of materials and systems, as appropriate, to achieve a Grade environment using the grade classification in BS 8102: 2009, Table 2.

The water table classification in accordance with BS 8102: 2009, Table 1 is

The risk associated with groundwater is considered to be

Note: Section P2.6 to be completed.

P1.7.2 Crack widths

These should be should be limited to mm.

P1.8 Concrete

P1.8.1 Designated concrete

To be In accordance with BS 8500–2 and BS EN 206–1

Project values should be entered in the grey panels.

| | Requirements | Defaults | Project | Project | Project | Project |
|----|---|-----------------|---------|---------|---------|---------|
| 1 | Concrete designation (Ref. BS 8500–2: 2006, Table 5) | | | | | |
| 2 | Maximum aggregate size (mm) Enter 10, 14, 20 or 40 | 20 | | | | |
| 3 | Consistence class S1, S2, S3, S4 or other value | S3 | | | | |
| 4 | Special restrictions on cement types (enter reference if required) | None | | | | |
| 5 | Special requirements for aggregates (enter reference if required) | None | | | | |
| 6 | Use of RCA permitted? Maximum mass fraction of total coarse aggregate enter a higher mass fraction of total coarse aggregate, where permitted (Ref. BS 8500–1: 2006, Cl. 4.2.3c) | Yes | | | | |
| | | 20% | | | | |
| 7 | Requirements for accelerated or retarded set | None | | | | |
| 8 | Special colour requirements None or see S1.9 | None | | | | |
| 9 | Type and dosage of fibres | See P1.5.1 | | | | |
| 10 | Chloride class Cl 1,0 for GEN series, Cl 0,20 for SRPC, Cl 0,40 for all other concretes or enter special requirements | As BS 5800–1 | | | | |
| 11 | Minimum air content | None | | | | |
| 12 | Method of placing concrete | | | | | |
| 13 | Requirement for finishing concrete | See P1.9 | | | | |
| 14 | Identity testing for consistence or other properties required in accordance with BS EN 206–1: 2000 Annex B and BS 8500–1: 2006 Annex B) (If YES then details to be added into P1.13) | No | | | | |

Notes

- 1** All sections of the Specification must be completed before it is passed to the Producer. The person sending the final specification to the producer must send copies of the document to all other parties (CA, Engineer, Employer, as appropriate) who have contributed to the Specification.
- 2** Where 'None' is entered in the table this is a default value to ensure that the Specification is complete. All those involved in completing the specification need to check if 'None' is appropriate.
- 3** Guidance on specification of designated concrete can be found in BS 8500–1: 2006, Section 4.2.

P1.8.2 Designed concrete

To be in accordance with BS 8500–2 and BS EN 206–1.

Project values should be entered in the grey panels.

| | Requirements | Defaults | Project | Project |
|----|---|---|---------|---------|
| 1 | Concrete reference | | | |
| 2 | Strength class | | | |
| 3 | Maximum water-cement ratio | | | |
| 4 | Minimum cement content kg/m ³ | | | |
| 5 | DC-Class where appropriate | | | |
| 6 | Permitted cement types – See BS 8500–1: 2006, Cl. 4.3.2, Note 3 | | | |
| 7 | Maximum aggregate size (mm) – Enter 10, 14, 20 or 40 | 20 | | |
| 8 | Chloride class (a value must be entered unless Cl 0,40 is acceptable) | Cl 0,40 | | |
| 9 | Target density/density class (for lightweight and heavyweight concrete) | N/A | | |
| 10 | Consistence class S1, S2, S3, S4 | | | |
| 11 | Method of placing concrete | | | |
| 12 | Requirement for finishing concrete | See P 1.9 | | |
| 13 | Type and dosage of fibres | See P1.5.1 | | |
| 14 | Use of RA conforming to BS 8500–2: 2006, 4.3, permitted? If YES: enter requirements for the following in P1.13: Maximum acid-soluble sulfate, method for determination of the chloride content classification with respect to ASR, method for determination of alkali content, any limitations on use in concrete, e.g. exposure classes, maximum mass fractions, etc. (Enter details in P1.13) | Yes RCA permitted to 20% mass fraction | | |
| 15 | Special requirements for aggregates | None | | |
| 16 | Minimum air content, or other requirements to resist freeze-thaw attack | None | | |
| 17 | Special requirements for temperature of fresh concrete | None | | |
| 18 | Special requirements for strength development | None | | |
| 19 | Special requirements for heat development during hydration | None | | |
| 20 | Special requirements for retarded stiffening | None | | |
| 21 | Special requirements for resistance to water penetration | None | | |
| 22 | Special requirements for resistance to abrasion | None | | |
| 23 | Requirements for tensile splitting strength | None | | |
| 24 | Additional technical requirements See BS 8500–1: 2006, Cl. 4.3.3 sections n & m | None | | |
| 25 | Identity Strength testing required? (If YES then details to be added into P1.13) | None | | |
| 26 | Identity Consistence testing required? (If YES then details to be added into P1.13) | None | | |
| 27 | Other properties Identity testing required? (If YES then details to be added into P1.13) | None | | |

Notes

- All sections of the specification must be completed before it is passed to the producer. The person sending the final specification to the producer must send copies of the document to all other parties (CA, Engineer, Employer as appropriate) who have contributed to the specification.
- Where 'None' is entered in the table this is a default value to ensure that the specification is complete. All those involved in completing the specification need to check if 'None' is appropriate.
- Guidance on specification of designed concrete can be found in BS 8500–1: 2006, Section 4.3.

P1.8.3 Prescribed concrete

To be in accordance with BS 8500–2 and BS EN 206–1.

Project values should be entered in the grey panels.

| | Requirements | Defaults | Project | Project | Project | Project |
|---|---|----------|---------|---------|---------|---------|
| 1 | Concrete reference | | | | | |
| 2 | Cement type, class and content | | | | | |
| 3 | Water/cement ratio | | | | | |
| 4 | Consistence Class S1, S2, S3, S4 | | | | | |
| 5 | Type, category and maximum size of aggregate | | | | | |
| 6 | Special requirements for density (for lightweight and heavyweight concrete) | None | | | | |
| 7 | Concrete chloride class or maximum chloride content of aggregate | | | | | |
| 8 | Required admixtures – quantity and source of material | | | | | |
| 9 | Additional requirements for source of materials | None | | | | |
| 10 | Requirements for proportion of fine aggregate | | | | | |
| 11 | Special requirements for temperature of fresh concrete | None | | | | |
| 12 | Additional technical requirements | None | | | | |
| 13 | Use of RCA permitted? | Yes | | | | |
| | Maximum mass fraction of total coarse aggregate Enter a higher mass fraction of total coarse aggregate, where permitted (Ref. BS 8500–1: 2006, Cl. 4.2.3c) | 20% | | | | |
| <p>Notes</p> <p>1 All sections of the Specification must be completed before it is passed to the Producer. The person sending the final specification to the Producer must send copies of the document to all other parties (CA, Engineer, Employer as appropriate) who have contributed to the specification.</p> <p>2 Where 'None' is entered in the table this is a default value to ensure that the Specification is complete. All those involved in completing the Specification need to check if 'None' is appropriate.</p> <p>3 Guidance on specification of Prescribed concrete can be found in BS 8500–1: 2006, Section 4.4.</p> | | | | | | |

P1.8.4 Standardised prescribed concrete

To be in accordance with BS 8500–2 and BS EN 206–1.

Project values should be entered in the grey panels.

| | Requirements | Defaults | Project | Project | Project |
|---|---|--------------|---------|---------|---------|
| 1 | Concrete reference | | | | |
| 2 | Designation | | | | |
| 3 | State if concrete is reinforced | Unreinforced | | | |
| 4 | Maximum aggregate size (mm) Enter 10, 14, 20 or 40 | 20 | | | |
| 5 | Consistence class: S1, S2, S3, S4 | | | | |
| 6 | Restrictions on cement types | None | | | |
| 7 | Restrictions on aggregate types | None | | | |
| 8 | Any other special requirements | None | | | |
| <p>Notes</p> <p>1 All sections of the Specification must be completed before it is passed to the Producer. The person sending the final Specification to the Producer must send copies of the document to all other parties (CA, Engineer, Employer as appropriate) who have contributed to the Specification.</p> <p>2 Where [None] is entered in the table this is a default to ensure that the Specification is complete. All those involved in completing the Specification need to check if 'None' is appropriate.</p> <p>3 Guidance on specification of standardised prescribed concrete can be found in BS 8500–1: 2006, Section 4.5.</p> <p>4 Standardised prescribed concrete produced using sulfate-resisting Portland cement is not intended to produce sulfate-resisting concrete.</p> | | | | | |

P1.8.5 Proprietary concrete

To be in accordance with BS 8500–2: 2002 and BS EN 206–1: 2000.

Project values should be entered in the grey panels.

| | Requirements | Defaults | Project | Project | Project |
|--|--|------------|---------|---------|---------|
| 1 | Concrete reference | | | | |
| 2 | Strength class | | | | |
| 3 | Exposure class | | | | |
| 4 | State if concrete is reinforced | Reinforced | | | |
| 5 | Requirement for finishing concrete | See P1.9 | | | |
| 6 | Any other special requirements, including restrictions on constituents. | | | | |
| 7 | Use of RCA permitted? | Yes | | | |
| | Maximum mass fraction of total coarse aggregate. Enter a higher mass fraction of total coarse aggregate, where permitted (Ref. BS 8500–1: 2006, Cl. 4.2.3c) | 20% | | | |
| 8 | Producer to provide confirmation, in accordance with BS 8500–1: 2006, Section 5.2j that concrete complies with the above performance requirements | Yes | | | |
| 9 | Identity strength testing required (If YES then details to be added into P1.13 in accordance with BS EN 206–1 Annex B) | | | | |
| 10 | Identity consistence testing required (If YES then details to be added into P1.13 in accordance with BS 8500–1 Annex B) | | | | |
| 11 | Identity other properties testing required (If YES then details to be added into P1.13 in accordance with BS 8500–1 Annex B) | | | | |
| <p>Notes</p> <p>1 All sections of the Specification must be completed before it is passed to the Producer. The person sending the final Specification to the Producer must send copies of the document to all other parties (CA, Engineer, Employer as appropriate) who have contributed to the Specification.</p> <p>2 Guidance on Specification of proprietary concrete can be found in BS 8500–1: 2006, Section 4.6.</p> | | | | | |

P1.9 Surface finishes

P1.9.1 Reference panels

The Ordinary and Plain Formed Reference Panels for this project are at:

| |
|--|
| |
|--|

P1.9.2 Special finishes

Special finishes (other than formed or unformed, Basic and Ordinary finishes) are required as follows:

| | |
|-------------------------------|--|
| Type | |
| Location on site | |
| Similar finish can be seen at | |
| Concrete mix | |
| Sample/special requirements | |

P1.10 Precast concrete

This is information to be provided for precast concrete works:

| Details to be provided | | At tender Y/N | 8 weeks before construction Y/N |
|-----------------------------|---------------------------------|---------------|---------------------------------|
| Production plant | Details | | |
| | QA certification | | |
| Lifting | Method | | |
| | Equipment details | | |
| | Design of lifting point/devices | | |
| Handling | Location of lifting devices | | |
| | Minimum age | | |
| | Additional reinforcement | | |
| | Storage details | | |
| Erection | Transport storage details | | |
| | Specification | | |
| | Work programme | | |
| | Temporary supports/details | | |
| Connections | Details of protection | | |
| | Details | | |
| | Preparation | | |
| | Grouting/packing | | |
| Concrete | Removal of temporary shims etc. | | |
| | Designation | | |
| Finishes | Samples of finishes | | |
| | Details of spacers | | |
| | Formwork details | | |
| Environmental certification | Enter requirements | | |

P1.11 Prestressed concrete construction

The requirements for the prestressed construction are:

P1.11.1 Quality audit

A quality audit carried out by CARES, or equivalent, is required. Yes/No

P1.11.2 The stressing sequence required:

| Location | Requirement |
|----------|-------------|
| | |

P1.11.3 Other prestressing information required

| | |
|--|--|
| Transfer strength required for stressing, N/mm ² | |
| Load/extension graphs shall be plotted for at least four points on in-situ trial tendons – list locations | |
| Definition of a tendon group | |
| Specific requirements for anchorages | |
| Specific requirements for tendon coating materials | |
| Specific requirements for duct materials | |
| Method of anchorage sealing | |
| Full scale grouting trials to be carried out | |
| Documentary evidence of compliance of anchorage | |
| Vent labeling is required | |
| Actual position of tendons to be marked on slab soffit to indicate location in both plan and elevation within the slab | |
| Special requirements for crack widths | |
| Other | |

P1.12 Deflection allowances

P1.12.1 To be used in calculating formwork pre-camber

| Location | Design deflection |
|----------|-------------------|
| | |

P1.12.2 Design pre-camber required for precast concrete elements

| Location | Design deflection |
|----------|-------------------|
| | |

P1.13 Further information

Further information to expand data given in Cl. P1.1 to P1.12

| Clause reference | Additional information |
|------------------|------------------------|
| | |

Section P2 Information to be supplied BY the Constructor

Required at tender stage unless noted, with updated information issued for construction.

P2.1 General information

P2.1.1 Project contacts

| | | | |
|--------------|--|-------|--|
| Project name | | | |
| Project ref. | | | |
| Address | | | |
| Telephone | | Email | |

Constructor

| | | | |
|----------------------------------|--|--------------------------------|--|
| Name | | | |
| Address | | | |
| Contact name | | | |
| Telephone | | Email | |
| SpeCC Registration Number: | | Required / Not required: | |

Designer

| | | | |
|-----------|--|-------|--|
| Name | | | |
| Telephone | | Email | |

Temporary works coordinator

| | | | |
|-----------|--|-------|--|
| Name | | | |
| Telephone | | Email | |

Other specialist contractors to be used by Constructor

| | | | |
|-----------|--|-------|--|
| Name | | | |
| Telephone | | Email | |

P2.2 Design

Details of any Constructor-designed structure as defined in Table P1.3.

| |
|--|
| |
|--|

P2.3 Drawings and calculations

Details of any proposed variation of values in Cl. P1.4 and other specification changes:

| |
|--|
| |
|--|

P2.4 Execution management

P2.4.1 Construction planning

An information requirement schedule, based on the construction programme and this Specification is to be issued to the CA within ten working days of Constructor being appointed.

P2.4.2 Other execution management proposals by Constructor

Details of any other proposals for execution management from the Constructor:

P2.5 Materials

List any alternative materials, or material sources, proposed by Constructor:

P2.6 Project requirements

Details of any proposals for alternative specification or workmanship from the Constructor:

P2.7 Water-resisting construction

When the Constructor is responsible for the detailed design of water-resisting construction the following materials will be used:

| Location | Detail | Waterstops | Separation membranes | Joint fillers |
|---------------------------------------|--------------|------------|----------------------|---------------|
| | Manufacturer | | | |
| | Material | | | |
| Slabs: horizontal construction joints | Type | | | |
| Slabs: horizontal movement joints | Type | | | |
| Walls: horizontal slab/wall junctions | Type | | | |
| Walls: vertical construction joints | Type | | | |
| Walls: vertical movement joints | Type | | | |

P2.8 Concrete and concreting

Any proposed concrete specification variations, in addition to the Constructor’s input to the tables in section P1.8:

P2.9 Further information

Further information to expand data given in sections P2.1 to P2.8:

| Clause reference | Additional information |
|------------------|------------------------|
| | |

National Structural Concrete Specification for Building Construction

Fourth edition complying with BS EN 13670: 2009

NSCS Guidance

Introduction

This Guidance has been produced to be used in conjunction with the *National Structural Concrete Specification for Building Construction*. It is not part of the Specification and has no legal standing, but is intended to guide the user of the NSCS. While it is written in less formal style, it still adheres to the numbering system used for the NSCS.

The Guidance includes current best practice information to assist in completion of NSCS Project Specification and provides prompts to encourage specification of best practice in sustainable construction and environmental management. It is expected that standards for these issues will be evolving throughout the construction industry over the next few years and so specifiers should be adding the current requirements on most projects.

Section 1 Scope

Section 2 Bibliography

The bibliography given in NSCS Standard Specification lists Standards and other documents referred to in that document. Further documentation used in NSCS Guidance is given in a separate bibliography at the end NSCS Guidance.

Section 3 Definitions

The definitions that apply to NSCS are NSCS Standard Specification Section 3, as well as those in BS EN 13670, Section 3 Definitions. Where a definition is not listed below no guidance is given.

3.1

3.2 Contract administrator (CA)

The Contract Administrator may or may not be the Engineer. Where he is not, appropriate arrangements should be in place so that relevant information is referred to and obtained from the Engineer when required. Note that the CA is designated as the formal approving authority.

3.3 Design calculations

For design by the Constructor these are needed for acceptance by the CA and for sending to Building Control or other checking authority as required.

3.4 Drawings and schedules

3.4.1 General arrangement drawings (GAs)

Sometimes referred to as 'Outline drawings', these should set out clearly the locations of concrete grades and finishes if there are various types in the structure and should also detail the loadings (e.g. floor loadings) on elements of the structure. They are not intended to include any precast specialist layout drawings since these would be categorised in the appropriate part of the table. It is expected that these will always be issued to the Constructor.

3.4.2 Design information drawings

These are needed if the Constructor is to detail any of the structure and must make clear the design required by the Contractor. Design information drawings should provide, sometimes in electronic format, the following information: Comprehensive typical details, simplified detailing instructions, in some cases non-standard project-specific details, requirements for reinforcement ductility grade, requirements for minimum reinforcement design lap lengths, the minimum design cover for each concrete element, requirements for detailing around holes, and any key design requirements for dealing with clashes should these occur.

3.4.3 Specialist drawings - prestressed concrete

These are the detailed general arrangement drawings for specialist units such as precast plank layouts or mould drawings for special precast units. If more specialist drawings are needed then this type of information would be repeated.

3.4.4 Reinforcement detail drawings

It is not expected that these are needed for standard precast units such as planks. They will indicate all reinforcement types, bar sizes, quantity, spacing, shape, length, extent, location within the concrete, covers etc. All reinforcement will be given marks for easy identification. The drawings will have sufficient information when read with all the other information and drawings to enable reinforcement schedules to be produced and reinforcement to be accurately placed on site.

3.4.5 Builders' work drawings

These should include such things as cast-in items, blockouts and holes for mechanical and electrical services that have not been shown on the GAs due to their small size, etc.

3.4.6 Temporary works and erection drawings

These cover the work necessary for the construction; they may be prepared by any party but are usually produced under the direction of the Temporary Works Coordinator. It is expected that these will always be issued as necessary and will form part of the Safety Plan under CDM regulations.

3.4.7 As-built drawings

It is often unclear who is responsible for producing these. This should be clarified at tender stage, together with the required content and the appropriate party identified in NSCS Project Specification. These may be different from the 'final record' drawings produced by consultants; they may well be produced, by agreement, by the Constructor and will constitute the structural record drawings for the Health and Safety File. They should contain sufficient information to enable an experienced engineer at a later date to plan structural alterations.

3.4.8 Reinforcement schedules

Schedules must identify the structural element, and its location, in which the reinforcement is to be placed. The bending schedules are the only information sent to the reinforcement supplier and they must therefore make clear any special requirements for reinforcement grade. The schedule is therefore the place where bars other than 'H' must be specified, although this information can also be included in NSCS Project Specification. Scheduling Grade B500A, B500B or B500C will ensure that the correct grade will be used, (albeit Grade B allows B or C to be supplied).

3.4.9 Construction sequence information

Drawings, sketches and notes that cover the construction sequences and stability requirements required by the design of the permanent structure. The Engineer or CA should always make clear any specific requirements or design assumptions made about the sequence of construction.

3.5 Employer

This term covers a variety of meanings depending on the form of contract, for example, it could mean the Main Contractor, who employs the Constructor. It is not necessarily the Employer as defined in JCT or other types of contracts.

The **Constructor** is the organisation executing the works (BS EN 13670: 2009, Cl. 3.4). This is the contractor constructing the Structure who may be a main contractor, specialist or a combination of both. It is noted that the NSCS is written as though the Constructor carries out all specialist operations – thus the Constructor will cover the prestressing specialist or precasting sub-contractor who may be a sub-contractor to the Constructor.

Note that the Constructor may be expected to conform to good site management practice to meet project requirements for schemes such as 'Considerate Contractors'; this will be specified elsewhere in the tender documents.

3.6 Engineer

This is the individual or organisation responsible for the structural design of the works and may or may not be the CA depending upon the type of contract.

The NSCS has been so written that the CA, whoever it may be, should obtain agreement by the Engineer on certain matters. This is important since the Engineer is responsible for the design and must advise which items or activities have an effect on the structural design during the construction. It is expected that the CA would meet the Engineer prior to construction and establish a working method for liaising with the Engineer under the contract. Any changes to these responsibilities resulting from contractual arrangements are expected to be noted in NSCS Project Specification.

In circumstances where there is more than one Engineer, e.g. Client's Engineer and Design and Build Contractor's Engineer, the responsibilities of each should be clarified in writing.

It must be clear who is the Engineer having overall responsibility for the stability of the structure; they must ensure the compatibility of the component parts including any elements not designed in detail by themselves. It is possible that the Engineers' briefs do not require them to visit the site and inspect the works.

3.7 Manufacturer

The responsibility of any manufacturer should be made clear in the contract documents. For proprietary products such as precast hollowcore planks the manufacturer will generally prepare the detailed design and drawings for the units. For other precast components such as stairs, the manufacturer may provide units to a design prepared by the Engineer or CA or may supply their own standard product to their design. See the note in Cl. 3.6 above about the need for an Engineer to have overall responsibility for the design of any structure.

3.8 to 3.13

Section 4 Execution management

This section of the Specification has not existed, as such, in the NSCS before but is now needed as BS EN 13670 has introduced specific requirements for documentation and supervision. Much of this has been included within previous editions of the NSCS but has now been drawn together in this section to align with the Standard.

Eurocode design requires construction to be in accordance with BS EN 13670, which gives specific requirements for quality management, inspection of work and documentation that needs to pass between the CA and the Constructor. This section of the specification deals with the requirements for the quality of information to be communicated between the Designer and the Constructor, the minimum standards of site inspection the Designer requires from the Constructor and systems for recording the quality of materials used for the project.

Appendix A of the Standard lists specific information that is required to be communicated. The National Annex to the Standard requires the information to be in the Project Specification in the UK. The NSCS provides some of this information as standard for building structures in the UK either in NSCS Standard Specification or lists the project specific requirements in NSCS Project Specification. It clarifies in Cl. P1.3 of NSCS Project Specification the paperwork the Designer needs the Constructor to produce for the project as part of the information flow for execution management. The table below shows the information required by the Standard and where it is provided within NSCS Standard Specification, if it is not project-specific.

Requirement for Execution Specification described in BS EN 13670: 2009 table A1 – Clauses where information is provided in NSCS Standard Specification:

| Clause | Requirement | NSCS Standard reference |
|-------------------------------|---|-------------------------------|
| Normative references | | |
| 2 (1) | Add all relevant national standards or provisions valid at the construction site | Section 2 |
| Execution management | | |
| 4.1 (1) | All necessary technical information to be set out in the Execution Specification | Section 2 Bibliography |
| 4.1 (4) & 4.2.1 (2) | National provisions which need to be respected | Section 2 |
| 4.2.1 (3) | Include procedure for altering Execution Specification | 4.5.1 |
| 4.2.1 (3) | Requirements for document distribution | 4.4 & 4.6.1 |
| 4.2.2 (1) | State if a quality plan is required | Yes 4.3 |
| 4.3.1 (6) | Specify execution class and define who is responsible for the inspection | Class 2 or as P1.4.1 & P1.4.2 |
| 4.3.1 (7) | If necessary, specify further requirements for the quality management regime | 4.3 |
| 4.4 (3) | If required specify rectification of possible non-conformances | 4.15 |
| Falsework and formwork | | |
| 5.3 (1) & 5.4 (1) | If required specify if method statements shall be worked out | 5.7.3 |
| 5.6.2 (1) | Requirements for filling temporary holes etc. | 5.6 |
| 5.7 (1) | Requirements for removal of falsework and formwork to avoid deflections | 5.7.1 & 5.7.2 |
| 5.7 (4) | If relevant, specify sequence of removal, where backpropping and/or repropping of the structure is used | 5.7.3 |
| Reinforcement | | |
| 6.2 (1) | Specify types of reinforcement | 6.1.1 |
| 6.3 (1) | Is bending at temperatures below -5 °C permitted and if so specify the precautions to be taken | 6.12.1 |
| 6.3 (1) | State if bending by heating in permitted | 6.12.1 |
| 6.3 (2) | Specify mandrel diameter for bending bars | 6.12.1 |
| 6.3 (3) | Specify mandrel diameter for welded reinforcement and fabric bent after welding | 6.12.1 |
| 6.3 (5) | Specify any requirements to straighten bent bars | 6.12.1 |
| 6.4 (1) & 6.4 (2) | Provisions for welding of reinforcement | 6.10 |
| 6.4 (3) | Specify if spot-welding is not permitted | Permitted by default |
| 6.6 (3) | Specify special requirements if any | None by default |

| Clause | Requirement | NSCS Standard reference |
|--|--|----------------------------------|
| Prestressing | | |
| 7.1 (2) | Requirements for installation of post-tensioning kits and qualification of personnel to perform the installation | 7.1.1 & 7.1.2 |
| 7.2.1 (1) | Requirements to the post-tensioning system | 7.1.1 |
| 7.2.3 (1) | Specify requirements for the prestressing steel | 7.2.2 & 7.2.3 |
| 7.2.5 (2) | Description of tendon support | 7.3.2 |
| 7.4.1 (1) | Provisions for assembling of prestressing tendons | 7.3.1, 7.3.2 & 7.3.3 |
| 7.5.2 (1) | Actions to be taken when accuracy of elongation of pre-tensioning tendons cannot be achieved | 4.3.8 |
| 7.5.3 (1) | Actions to be taken when accuracy of elongation of post-tensioning tendons cannot be achieved | 4.3.8 |
| Concreting | | |
| 8.5 (16) | Specify if special measures to reduce the risk of thermal cracking are needed | 8.9 |
| Execution with precast elements | | |
| 9.4.1 (1) & 9.4.1 (3) | Specify special requirements to handling, storage, protection and position | 9.3 & 9.4 |
| 9.4.2 (3) | Specify requirements to product identification | 9.1.1 |
| 9.5.1 (1) | Requirements for placing and adjustments | 9.8, 9.9, & 9.11 |
| 9.5.2 (4) | Input for the erection if relevant | 9.1.3 |
| Geometric tolerances | | |
| 10.1 (2) | Specify if tolerance class 2 applies (and where) | Class 1 modified by default |
| 10.1 (3) | Specify if the tolerance requirements in Annex G do not apply | NSCS Section 10 tolerances apply |
| 10.1 (4) & 10.1 (5) | Specify if 'box-principle' applies and with what tolerance, if different from ± 20 mm | Applies – see 10.1.6 |
| 10.2 (3) | State any requirements for the secondary lines | Inclusive – see 10.1.1 |

Requirement for Execution Specification described in BS EN 13670: 2009 table A1 – Clauses where the Information is project-specific and must be provided in NSCS Project Specification:

| Clause | Requirement | Where to insert in NSCS Project Specification |
|-----------------------------|--|---|
| Scope | | |
| 1 (2) | Specify all the specific requirements relevant for the particular structure | |
| 1 (4) | If required, specify any additional requirements regarding lightweight concrete, other materials or special technology | |
| 1 (5) | State any requirements on concrete members used as equipment for the execution | |
| Definitions | | |
| 3.17 | Define the reference line for setting out | Drawings |
| Execution management | | |
| 4.1 (3) | Specify requirements related to qualifications of personnel | |
| 4.2.4 (1) | State extent of special documentation if required | P1.4.2 |
| 4.3.1 (5) | Specify execution class and define who is responsible for the inspection | Class 2 or as S1.4.1 & S1.4.2 |
| 4.3.1 (6) | Specify provisions related to inspection personnel | |
| 4.3.2 (1) Table 1 | Define inspections and acceptance testing of products without a CE-marking or third-party certification | |
| 4.3.3 (1) Table 2 & 3 | Check if the scopes of these inspections are adequate. If not give additional requirements | S1.4.2.1 |

| Clause | Requirement | Where to insert in NSCS Project Specification |
|--------------------------------|---|---|
| Falsework and formwork: | | |
| 5.3 (4) | Specify requirements to temporary support structures, if any | |
| 5.4 (5) | Specify any requirements for surface finish | Table P1.9 |
| 5.4 (6) | Specify any requirements for special finishes or trial panels | Table P1.9 |
| 5.4 (7) | Specify any requirement for temporary support of the permanent structure | |
| 5.5 (1) | Specify any requirements for special formwork | Table P1.9 |
| Reinforcement | | |
| 6.2 (3) | Specify permitted types of anchorages or couplers | 6.5 & P1.5.1 |
| 6.2 (6) | Requirement for reinforcement materials other than steel if used | P1.5.1 |
| 6.3 (1) | Provide cutting and bending schedules or identify that this is a task for the Constructor | Table P1.3 |
| 6.5 (1) | Specify the position of reinforcement including cover, the position of laps and joints etc. | Drawings |
| 6.5 (2) | Specify if reinforcement by <i>running meters</i> is permitted | |
| 6.5 (3) | Specify Special requirements if any | |
| 6.5 (4) | Specify nominal concrete cover, i.e. the required minimum cover + the numerical value of the permitted minus-deviation (ref. NSCS Standard Specification Cl. 10.8.1) | Drawings |
| Prestressing | | |
| 7.2.3 (2) | State if alternatives to prestressing steel are permitted, and the requirements | |
| 7.4.1 (3) | Specify if welding of local anchorage zone reinforcement, anchor plates and spot welding of perforated plates is permitted | |
| 7.5.1 (3) | Identify stressing anchors and passive/dead end anchors. | |
| 7.5.1 (6) | Requirement relating to minimum compressive strength of concrete when application and/or transfer of prestressing force to the structure | P1.11.3 |
| Concreting | | |
| 8.1 (1) | Check that all the required concrete properties have been specified according to BS EN 206–1 and national standards or provisions valid in the place of use of the concrete | Tables P1.8 |
| 8.1 (3) | State the minimum upper sieve size, D, for the concrete | 8 mm or Tables P1.8 |
| 8.2 (1) | State if a concreting plan is required | P1.4.5 |
| 8.2 (2) | State if a trial casting is required | Table P1.9 |
| 8.2 (4) | State requirements to construction joints where relevant | 5.8.1 |
| 8.2 (6) | State if an increased cover to the reinforcement is needed when casting directly on ground | |
| 8.3 (4) | State if samples shall be taken | Tables P1.8 |
| 8.3 (5) | State if contact with aluminium alloy is permitted e.g. aluminium | |
| 8.4.4 (1) | If sprayed concrete is applied, the Execution Specification shall be according to BS EN 14487–2 | |
| 8.4.5 (2) | If slipforming is applied, the detailing and the equipment used shall be compatible | |
| 8.4.6 (1) | Specify special requirements to underwater casting, methodology etc. if any | |
| 8.4.6 (2) | If the concrete is to be cast under water, the detailing and the concreting method shall be compatible | |
| 8.5 (2) | Specify if there is any need to protect the concrete in its early age from aggressive agents | |
| 8.5 (7) | Specify the curing class to be applied | 8.8 or P1.4.7 |
| 8.5 (8) | Specify if special measures to reduce the risk of thermal cracking are needed | |
| 8.8 (1) | Specify possible surface finish requirements | Table P1.9 |

| Clause | Requirement | Where to insert in NSCS Project Specification |
|--|--|---|
| Execution with precast elements | | |
| 9.1 (2) | Specify the precast concrete elements to be used. | |
| 9.6 | In-situ works required for completion | Drawings |
| 9.6.3 (1) | Detailing of structural connections | |
| 9.6.3 (2) | Specify acceptable specific technologies | |
| 9.6.3 (3) | Specify requirements to connections, inserts for joint connections and welded structural connections | Drawings |
| Geometric tolerances | | |
| 10.1 (2) & 10.1 (4) | Specify any special tolerances and the elements to which they apply | P1.12 or Drawings |
| 10.1 (6) | Specify requirements for surfaces with full contact bearing | |
| 10.1 (7) | Specify tolerances for sections that are to be cast under water | |
| 10.1 (10) | Possible requirements for the combination of construction tolerances and structural deflections | P1.11 |

When the Designer provides all the above information in the specification this should: ensure fair pricing at tender stage; reduce misunderstanding between the Designer and Constructor; and start the process of collaborative working between the Designer and the Constructor, essential during the construction phase of a project, to produce the best quality building for the Client for the best price.

4.1 General requirements

4.1.1 Standards

It is essential that the document hierarchy is clear; NSCS Project Specification must always be the master document stating the other appropriate standards to be used. The specifier should ensure that any changes do not allow a lower standard than the normative requirements of BS EN 13670.

4.1.2 Materials

The CA has the right to take any materials from the structure for testing to check that they meet the specification. This should boost the Employer's confidence in the quality of the structure. The normal method of payment for such additional tests, where for example, a defect is suspected, is that the Employer pays if everything is found to be in accordance with the NSCS, otherwise the Constructor bears the cost. This relates to additional testing over and above routine testing, for example of concrete cubes, carried out under the contract, payment for which will normally be covered in the main contract.

Sustainable construction

There are a number of steps that can be followed to satisfy increasing requirements for construction projects to be more sustainable. These are to manage materials well on site, to ensure compliance with basic environmental management requirements for the production and supply of materials through BS EN ISO 14001 and then to tackle wider sustainability issues and the responsible sourcing of materials.

Requirements will be given elsewhere in the tender documents to encourage the responsible use of materials, e.g. using Site Waste Management Plans and compliance with the Considerate Constructors scheme.

Suppliers can gain third-party certification for their environmental management through BS EN ISO 14001 and in addition can participate in an industry sector third-party accredited responsible sourcing scheme, which will also cover broader sustainability goals and supply chain management.

Requirements for responsible sourcing of construction materials are increasing. All construction projects have a part to play in achieving the UK strategy for sustainable construction target of 25% responsibly sourced construction products by 2012. BS 8902 provides a framework for the development of sector certification schemes for responsible sourcing of construction products; and BES 6001, produced by BRE (Young, 2009), which pre-dated the publication of BS 8902, provides a detailed interpretation of the issues of responsible sourcing. BS 8902 includes a list of 27 issues that fall under three main headings: Environmental, Social and Economic. The 27 issues should be considered during the development of a sector responsible sourcing scheme.

All parts of the material supply chain for reinforced concrete have developed initiatives aimed at achieving this target. Specification is needed to support participation and Clients can expect to gain credits in rating systems such as BREEAM for responsibly sourced materials. Specifiers should use the most up to date scheme information available and discuss with the client the specific requirements for each project. Guidance on responsible sourcing for specific materials is given in each section of NSCS to accord with the basic definition and principles, taken from BS 8902.

4.1.2.1 & 4.1.2.2

4.1.2.3 Third-party inspections

CARES inspectors for prestressed work will always require access to site, as may QSRMC or other concrete quality assessors. Access is sometimes needed without prior warning and the Constructor must accept this and plan accordingly.

4.1.2.4 Water-resisting construction – materials

Specialists, such as Cementaid (Caltite) or David Ball Group (Pudlo), can provide additives and may offer a guarantee for 'waterproof concrete'. The client should always be made aware what it is they are getting from this method of construction and it is only appropriate for some basements depending on their use; the grade of basement for a project should always be agreed early on in the design process with the client using the guidance in BS 8102. A guarantee will generally only cover the cost of sealing any leaks that are found and will not cover the often greater costs of removing and replacing finishes or the loss of use of a space.

4.2 Documentation

4.2.1 Quality plan

The Constructor must be able to demonstrate how the quality management system enables responsibilities to be executed according to the Contract and the NSCS.

SpeCC, the Registration Scheme for Specialist Concrete Contractors, is well established and has a growing membership. The specifier should consider making registration with SpeCC a requirement of the Specification, especially for larger projects, as this may help to obtain tenders of equal quality. SpeCC requires members to have a BS EN ISO 9000 series quality management system and this should help in dealing with the execution management of the project. If SpeCC-registered contractors are required this is made clear in NSCS Project Specification and they should confirm their registration number when returning the tender.

The Constructor may require documentation to be available for a stated period beyond the contract period and this should be stated in NSCS Project Specification.

4.2.2 Execution documentation

The documentation required by the Designer for a project is listed in NSCS Project Specification, Cl. P1.3. It may be useful to agree a schedule of dates detailing when this information will be required to assist in the smooth flow of information between the parties.

It is important that information is passed between parties promptly so that decisions can be made based on up to date information.

4.2.3 Information coordination and availability

4.2.3.1 Project specification

The Designer must ensure any changes issued are clearly shown. Highlighting changes and listing them on the cover pages is the expected method.

4.2.3.2 Availability

There are many occasions when this requirement will be essential to ensuring that a query does not become a problem.

4.2.3.3 Coordination

All aspects of the construction sequence and responsibilities must be understood by all parties before work starts. Work interfaces between trades are potential problem areas, and can result in non-performance of the work. This is particularly important with cladding, finishes and below-ground work such as basement construction where temporary works, shoring and groundwater pumping are critical.

4.2.4 Drawings and reinforcement schedules

4.2.4.1 Standards

This section sets a minimum standard for drawn information. It is good practice to draw a circle around revisions to drawings, rather than just relying on the description in the notes box. Such marks should be removed before the next revision is made.

4.2.4.2 Register

It is common sense to keep good records. Those who omit to do this always live to regret not being able to find the information they want.

4.2.4.3

4.2.4.4 Circulation

The Designer must ensure that Table P1.6 in NSCS Project Specification is adjusted where required to suit the project requirements. It can then be useful for Designer and Constructor to meet to review the requirements before incorporating the table into the Quality Plan so that no misunderstandings affect the programme.

4.2.4.5 Reinforcement schedules

The bending schedules are the only information sent to the reinforcement supplier and they must therefore make clear any special requirements for reinforcement grade. The schedule is therefore where bars other than 'H' must be specified, although this information can also be included in NSCS Project Specification. Scheduling Grade A, B or C will ensure that the correct grade will be used, (albeit Grade B allows B or C to be supplied).

4.2.4.6 As-built drawings

It is important for the Designer/CA and Constructor to discuss and agree who will produce these at an early stage in the construction process.

As-built drawings form part of the CDM Health and Safety File and are thus an essential requirement on any building project. All parties should agree the content of these drawings. The drawings should contain enough detailed information to enable structural assessments to be made for future alterations.

4.2.4.7 Builders' work drawings

These are essential to ensure follow-on trades only need a minimum of holes and fixing drilled into the concrete.

Builders' work drawings or the information needed to produce them must be provided to the Constructor as early as practicable if construction on site is to be right first time. The holes and fixing inserts needed may be shown on a wide range of drawings including the GA's, mechanical and electrical sub-contractor's drawings, and specialists' drawings for windows, cladding, fixings, etc. It is important to ensure that sub-contractors who are required to produce this information are appointed in good time to allow them to produce the drawings.

Early in the project the CA and Constructor need to agree who will produce and coordinate these drawings. NSCS Project Specification Cl. P1.3 can identify who produces these coordinated drawings. It is important that enough time is allocated to the production and review of these drawings so that any potential clashes can be designed or detailed out. It can cause huge frustration on site if a pour has to be delayed because there is a clash between the requirements for different cast in items.

4.2.5 Construction planning – temporary works

The Engineer will give consideration during the design stage to the sequence of construction on which the design is based. Any special requirements will be given to the Constructor on the Design Information Drawings. This information must be included with the pre-tender Health and Safety Pack. The Constructor's temporary works information will depend on the complexity of the project and will include drawings except in the simplest of projects. The contractor may submit an alternative sequence to the Engineer for agreement. It is expected that the Contractor's design will be carried out by the Temporary Works Coordinator, and that for all but the smallest of projects they will be an experienced engineer. In any event the final sequence of construction must be understood by all parties before work starts.

It is inevitable that construction loads will be added to the structure from, for example, storage of materials and equipment by the Constructor or by others working on the project. The effects of backpropping on loading on recently cast slabs will also need consideration. The Constructor must ensure these loads do not cause distress to the structure. There will also be changes on most projects to the temporary works to deal with changes to the programme; the Temporary Works Coordinator employed by the Constructor is best placed to deal with the resultant design changes but should always agree them with the permanent works designer.

4.3 Quality management

4.3.1 Execution class

Eurocode 2 states that for normal structures Execution Class 2 is required. The less onerous class 1 should not generally be specified; the more onerous class 3 should be considered for critical

structures or critical parts of structures. It is possible to specify class 3 for a part of a project only. It is expected that Execution Class 3 will be specified for structures in Building Class 3 to table 11, Approved Document A of the Building Regulations.

4.3.2 Setting out

The Constructor should be given the required location of the structure; see Cl. P1.1.3 of NSCS Project Specification.

4.3.3 Inspection

Clause 4.4.2a) of BS EN 13670 requires the investigation of non-conformity to include considerations of 'fitness for purpose'. Consultants will therefore need to take care when resolving non-conformities as their Professional Indemnity Insurance will not allow them to confirm 'fitness for purpose'.

It can be helpful for the CA to give more guidance to the Constructor on the inspection required. If the Designer requires third-party inspections by CARES or a concrete testing specialist, for example, this can be noted in NSCS Project Specification Cl. P1.4.4. Designers should always think about double checking the Constructor's checks, especially at the early stages of a project so that they can be confident that the standard of checking is acceptable and as expected. Inspection of water-resisting construction requires special attention and may need to involve the specialist, such as Cementaid or David Ball Group, who have provided any additives and may be offering a guarantee. A guarantee will generally only cover the cost of grouting up any leaks that are found and will not cover the often greater costs of removing and replacing finishes or the loss of use of a space.

4.3.4 Modifications

The intention of this clause is that the Constructor may make suggestions to improve or speed up the work. Any suggestions should be considered carefully by the CA. If such suggestions are accepted and agreed it is important that they are put in writing (including drawings or sketches if necessary), so that there is no misunderstanding.

Any modifications instructed by the CA must similarly be documented. NSCS Project Specification Cl. P1.6 and P2.3 are the appropriate locations for this purpose.

4.3.5 & 4.3.6

4.3.7 Testing

If the CA requires more testing to be carried out than specified it shall be at the Constructor's expense if the results do not meet the specification requirements. Otherwise all costs shall be additional to the contract. The Constructor is expected to arrange for all inspections and tests whether or not they are specified in the NSCS or instructed by the CA in addition to routine testing.

4.3.8 Action in the event of a non-conformity

In the event of a test non-conformity the onus is on the Constructor to propose a course of action. The first essential action is to report the non-conformity and this must be done as soon as the information is available; giving a specific fixed timescale for this is not possible as different test results will become available at different times.

Several alternative proposals may need to be submitted until one is found which the CA accepts. It is possible subject to further investigation that no further action will be needed but this must always be a joint decision.

It is when things go wrong that the importance of teamwork on a project, with all parties working together for the benefit of the client, is essential. The NSCS makes the Constructor responsible but this does not prevent the project team adopting a cooperative approach to resolving any problems caused by non-conformities and the CA or Engineer is advised not to just sit back and make the Constructor come up with suggestions without making their own contribution.

The CIRIA publication *C519 Action in the case of non-conformity of concrete structures* (Ainsworth & Hopkins, 1999) gives a great deal of helpful advice on this subject.

Section 5 Falsework and formwork

5.1 Standards

Clause 5.1.3 of BS EN 13670: 2009 requires falsework and formwork to comply with Standards where available or be 'demonstrably fit for the intended use'. It is understood the aim of the clause in the standard was to deal with simple timber systems commonly used in southern Europe. Consultants will need to take care therefore if involved in the design of formwork and falsework as this requirement would conflict with their Professional Indemnity Insurance which will not allow them to confirm 'fitness for purpose'.

Design to the standards referred to in NSCS Standard Specification is current best practice in the industry.

The CONSTRUCT publication CS140, *Guide to flat slab falsework and formwork* (Pallet, 2003) may be used where applicable in lieu of CIRIA Report 136, *Formwork striking times – Criteria, prediction and method of assessment* (Harrison, 1995). The Guide identifies techniques for assessing early concrete strength and criteria for striking and backpropping of flat slabs. It emphasises the degree of control necessary for site operations if these are to be adopted; there is also a need both for close coordination between the Designer and the Constructor and for all concerned to have a clear understanding of the processes involved.

There are also safety requirements which will be linked to the CDM Regulations and the requirements of the Health and Safety Executive.

5.2 Materials

Sustainable construction

The requirement for timber products to be legally sourced, i.e. coming from a supplier operating legally in the timber's country of origin, is to discourage the use of illegally sourced timber which has been a problem in the UK. The Central Point of Expertise on Timber (CPET) recognised schemes include the Forest Stewardship Council (FSC) and Programme for the Endorsement of Forest Certification (PEFC) schemes.

It is important that the formwork use is considered carefully to minimise its impact on the environment; using recycled formwork and obtaining the maximum reuse out of timber formwork should always be the aim to reduce waste. The specification of responsibly sourced timber and timber products for formwork should always be considered – see listing NSCS Project Specification Cl. P1.6.2.

General

The choice of material in face contact with the concrete has a significant effect on the resultant finish. The main features requiring consideration are the hardness, permeability and surface texture. The choice of materials will usually depend on the requirements for reuse and the required finish. High reuse potential is in most cases the reason for the choice of a steel form. If a specific material is needed for a particular application this must be specified in NSCS Project Specification as NSCS Standard Specification allows the Constructor to choose an appropriate formwork material. Where timber and wood-based materials are used, account must be taken of the permissible stresses in design. Detailed guidance on different materials is given in Concrete Society publication TR52 *Plain formed concrete finishes*.

The nature of the structure to be built may be such that the use of permanent formwork is essential. If the use of permanent formwork is optional, the final decision should be made at tender stage after the evaluation of the likely costs and benefits by the Constructor. The embodied energy impacts of metal and precast concrete permanent formwork are often high. The use of permanent formwork should be accepted where it is part of a structural system; where it can contribute to the overall performance of the building by providing an architectural finish or exposed thermal mass; or where it is inaccessible after construction of the element.

Specific issues for consideration when special finishes (visual concrete) are required

General The quality of formwork and joinery will be a major influence on the quality of the concrete finish. It is essential that the formwork is robust and well constructed and does not deflect during concreting. The design of the formwork support is therefore essential in getting a good visual concrete. All joints must be, as far as possible, grout-tight – careful detailing of joints and corners can help in getting grout-tight joints.

Materials Plywood is the most common formwork face material – it comes in a range of qualities from untreated fir through resin- and paper-faced ply to natural birch ply. The quality of the ply and the type of facing material will have a bearing on the number of potential reuses. Resin-faced plywood e.g. high density overlay (HDO) is shiny and produces a shiny finish to the concrete. Paper-faced ply can be medium density overlay (MDO) and produces a matt finish to the concrete. The HDO plywoods are much less likely to allow tannins in the wood to leach out and stain the concrete. Birch-faced ply with a film face density of 120 g/m² sanded and treated with an acrylic lacquer will also give a good surface finish. Generally sheets come in imperial sizes – 8 ft x 4 ft (2440 mm x 1220 mm). Layouts should use full panels to avoid cut edges. Panel layouts should be detailed along with tie bolt locations on drawings. Consider asking for 'shop' drawings from the contractor.

5.3 Release agents

If there are special requirements for the release agents to be used they should be specified in NSCS Project Specification Cl. P1.6. It is recommended that they are referred to by generic type rather than trade name.

Information on suitable release agents is outlined in Concrete Society publication CS030 *Formwork: A guide to good practice*. The type of release agent to be used will depend on the standard of formed finish required in NSCS Standard Specification Cl. 8.6 and NSCS Project Specification, Cl. P1.9 and any other finish to be applied to the formed surface subsequently. Release agents can affect the colour of the surface so special care with their selection is needed for visual as-struck concrete finishes.

5.4 Formwork use

The Constructor needs to satisfy himself that the fresh concrete will not sag or settle unduly due to settlement or deflection of the supporting formwork and falsework. It is common practice to set flat slab formwork uniformly high to allow for elastic settlement of the temporary works. The manufacturer of the particular formwork system to be used should be able to provide the relevant information to the Constructor.

Proper allowance needs to be made for self-weight deflections when elements are struck. Responsibility for this lies with the Engineer, although in practice both the Engineer and the Constructor have a joint obligation to ensure that such deflections are not excessive. The concrete strength at the time of striking and the design of backpropping can influence the deflection of slabs after striking. Any requirements for pre-cambering or other solutions to limit deflections (e.g. altering reinforcement provision) should be clearly identified at tender stage and stated in NSCS Project Specification. The widespread use of relatively long stiff aluminium or timber girder primaries and secondaries frequently make it impractical to incorporate pre-cambers in slab soffits. The specification for pre-camber must allow for the fact that the pre-camber may not all drop out.

Useful information can be found in Concrete Society publication CS123, *Checklist for erecting and dismantling formwork*.

Consideration should always be given to the effect of the formwork selected on curing of the concrete – timber forms may be better than steel in this respect.

Flat soffits are preferable as they simplify the design and construction of formwork, leading to productivity improvement; downstands should be avoided whenever possible.

For composite floor slabs profiled metal decking is usually selected so that temporary propping is not required during construction. Where temporary propping is required either for structural capacity or to control deflections during casting, the floor designer should clearly specify the propping requirements; see the ACIFC and The Concrete Society publication *Composite concrete slabs on steel decking – Guidance on construction and associated design considerations*. (Good Concrete Guide 5, 2008).

5.4.1 Ground support

The supporting formation or sub-base for any ground supported floor slab must not settle significantly under the weight of the fresh concrete. The Constructor must be satisfied that the ground is adequately prepared and compacted. Settlement of the supporting formation may affect the structural performance of the slab and adversely affect the surface levels. Consideration should be given to the suitability of reinforcement supports bearing on the formation prior to the start of work. This also applies in the short term in cases where the ground slab will ultimately rely on piles or other foundations for support rather than the soil/sub-base.

Casting against vertical faces of existing construction or excavations may be permitted, although a separating board will often be specified against existing construction. This will require the CA's agreement since there may be a design implication. In some circumstances there are positive advantages to this approach. It is generally acceptable for shallow foundations to be cast against earth faces in most situations.

Where the concrete is to be cast on absorbent formwork or subgrade, provision should be made to protect against loss of moisture from the newly placed concrete. The continuous impermeable

membrane often placed over the sub-base or formation for slabs cast on the ground as a slip, water or damp-proof or gas protection membrane would also serve this purpose. The Engineer or CA will need to specify in NSCS Project Specification the requirements for the membrane and its protection. The coordination of placement of concrete must be clearly established with other trades through the CA. This will include the timing when excavations are carried out and the actual placement of concrete.

5.4.2

5.5 Block outs and cast-in items

It is usually impracticable to show requirements for all holes, recesses and cast-in items on the General Arrangement drawings. This is particularly the case where certain specialised trades (e.g. building services and cladding contractors), may not be appointed until after General Arrangement drawings have been issued for construction. The location of major zones where openings are not permitted should be defined in the NSCS Project Specification, or on the drawings.

In the early stages of the contract the CA should coordinate the requirements for all cast-in items, holes and recesses required in the structure to ensure their specifications are clearly communicated to the Constructor. The responsibility for the preparation of the builders' work information will be defined in NSCS Project Specification, Cl. P1.3

The NSCS Project Specification should clearly identify who is supplying information on holes, recesses and cast-in items and who supplies the cast-in items. It is normal practice for suitable draws and tapers to be used by the Constructor to aid striking of block out items.

Block out items should be cleared out by the Constructor, since other trades are likely to have less experience in such operations, resulting in possible damage to the structure. It also gives the Constructor opportunity to inspect the concrete around the area concerned. However, any void former to a cast-in item should be removed by the following trade that will fix into that item.

5.6 Formwork ties

Consideration needs to be given to the final surface finish required. Depending on the type of tie used and the appearance required, no filling of the holes may be needed. If no through ties are permitted, or there are particular requirements for making good after ties are removed, this should be specified in NSCS Project Specification.

In water-resisting construction it should be recognised that certain types of tie may permit moisture penetration even after careful sealing. Types of wall ties and sealing methods need to be agreed between the Constructor and the CA prior to commencement of work. If a waterproofing system is to be applied to the structure, then through ties, properly sealed, may be acceptable if the Constructor can obtain agreement with the CA and the waterproofing system supplier.

Care needs to be taken with filling the holes to ensure the 'plug' does not become detached in the future. If holes need to be filled for acoustic or fire separation reasons in concrete not left exposed to view, this needs to be stated in NSCS Project Specification or on the drawings. The making good method should include thorough cleaning of the concrete surface, the application of a making good material and compatible bonding aid.

5.7 Loading, striking and backpropping

Detailed guidance on early striking of slab soffits and backpropping is given in CONSTRUCT publication CS140, *Guide to flat slab falsework and formwork* (Pallet, 2003). In situations where this is not relevant and requirements are not included in the formwork design or specification, guidance is given in BS EN 13670: 2009, Cl. C.5.7.

Selecting the right striking time for the formwork is a decision that needs to involve the permanent works designer, the Temporary Works Coordinator and the concrete supplier. The rate of gain of strength for concretes made using cement replacement materials varies considerably from that for concrete made from Portland cements. The concrete Producer is best placed to advise on the rate of strength gain and the Engineer and Temporary Works Coordinator can use this information to agree on striking times – balancing the short-term benefit of a fast turnaround with the longer term and environmental advantages of using less cement.

In all cases a minimum concrete strength of 2 N/mm² is required, but 5 N/mm² is recommended to minimise the risk of mechanical damage. With some formwork systems, part of the soffit formwork may be removed without disturbing the supports in contact with the slab.

Guidance on backpropping requirements and design is given in the CONSTRUCT publication CS140, *Guide to flat slab falsework and formwork* (Pallet, 2003). In most cases the slab immediately beneath that which is being concreted is likely to be the most critically loaded. In general, backpropping should be installed at the earliest available opportunity to ensure maximum distribution of loads through to the supporting slabs. Under no circumstances should any backpropping be removed until the slab most recently cast has been struck and is self-supporting.

Adequate backpropping is a crucial element in the construction of in-situ concrete frame structures; accordingly Constructors must make adequate provision when tendering for work, clearly specify backpropping requirements on the drawings or in the method statements and should exercise appropriate control over site operations.

5.7.1 to 5.7.4

5.8 Construction joints and pour sizes

5.8.1 Geometry

Details and locations of construction joints should be agreed well in advance of any construction. The Constructor shall position and form construction joints to suit the structure and so as to not cause any long or short term distress to the structure particularly from thermal and shrinkage effects. The CA should liaise with the Engineer prior to final agreement with the Constructor.

Many contractors will want to pour a minimum of 100 m³ of concrete in a day and this will mean quite large area pours, greater than the limits given in NSCS Cl. 5.8.1, especially for thinner slabs. The Contractor must then give advice to the CA on the pour areas expected and agree well in advance of concreting if this causes any change to the slab design. The maximum pour size values given in NSCS Cl. 5.8.1 are for guidance and represent a conservative safe default, especially for those who have limited experience of large pours. The CA should not insist on application of these safe defaults by an experienced Contractor, but should be careful about relaxing the defaults for those without experience. The Constructor is responsible for ensuring the supply of concrete is adequate for large pours and that they have the plant and operatives needed for carrying out

large pours. The maximum pour size is related to the restraints to shrinkage movement. The size and location of restraints and the amount of shrinkage define where additional measures, such as changes to the design reinforcement, may need to be taken regardless of pour sizes. Pour layouts and casting sequence should take into account where most of the shrinkage is likely to occur; particular requirements should be identified in NSCS Project Specification.

Where the maximum size of pour permitted differs significantly from the values suggested by NSCS Standard Specification, Table 1, the actual size should be specified in NSCS Project Specification Cl. P1.13 Special requirements. The Constructor may also propose his own variation under Cl. P2.6 of the NSCS Project Specification.

Due to the inherent restraint to shrinkage provided by composite profiled metal deck slabs, restrictions on pour size are not usually required.

Controlled large area pours are frequently carried out where the economic conditions are suitable and appropriate construction methods are available. Ideally pours should be restricted to the area that the contractor can place in a working day. Large areas of lightweight concrete in composite slabs can be poured where supplies are available. Pours in post-tensioned slabs may also be significantly larger, particularly where there is stressing from both ends. Further guidance can be obtained by reference to *Large area pours for suspended slabs* in Reinforcing LINKS Issue 3 from the RCC published by BCA in 1993 and available from MPA-Cement or IHS or similar.

The advice on pour sequencing and joint details is different for ground-supported slabs. Guidance for this is given in a number of documents such as Concrete Society publication TR34, *Concrete ground floors – A guide to their design and construction* and Concrete Society publication TR66, *External in-situ concrete paving*. Particular requirements should be given in NSCS Project Specification.

5.8.2 Joint preparation

Where a high level of confidence in water-resistance quality is required, the use of left-in-place expanded metal mesh might be considered questionable. Problems have been found with water ingress through increased difficulty of obtaining compaction and/or the preferential pathway with the Hi-Rib type mesh.

5.9 Water-resisting construction

Unless specified otherwise in NSCS Project Specification, water stops should be provided at all construction joints taking care to ensure they are held in place when the concrete is poured around them. External water stops are generally preferred for slab joints but will not be suitable for all other locations. Hydrophilic water stops may be used where the conditions are permanently damp.

Where larger pour sizes are used, a risk assessment on the consequences of cracking may be needed. The Engineer must clarify in NSCS Project Specification any special requirements such as the need to use or avoid a chequer board pattern of pours.

5.9.1 to 5.9.2

Section 6 Reinforcement

6.1 Materials

Throughout the NSCS Specifications, CARES or equivalent has been referenced to prevent any restriction of trade but at the time of drafting no equivalent organisation operating in the UK was known.

6.1.1 General

Cut and bent reinforcement for concrete is specified and supplied to BS 8666: *Scheduling, dimensioning, bending and cutting of steel reinforcement for concrete – Specification*. Within BS 8666, 'conventional' reinforcement is required to conform to BS 4449: *Steel for the reinforcement of concrete – Weldable reinforcing steel – Bar, coil and decoiled product – Specification*.

BS 4449 refers to three ductility Grades for steel with a 500 yield strength; A, B and C, which align with the three ductility classes A, B, C in BS EN 1992-1-1 Annex C. Choosing the correct grade of ductility is important as greater ductility assists in ensuring plastic rotation of sections and general robustness. BS EN 1992-1-1 requires that a minimum of Class B is needed if more than 20% moment redistribution has been used in the design.

Generally, straight reinforcing bar available in the UK is Grade B or C, but can be Grade A for smaller bar sizes up to and including 12 mm diameter. Grade A bars are generally cold formed and drawn from a coil, and are better suited for use in link bending machines. They produce more accurate shapes – which is why they are in common use. They can also be easier to bend to more complex shapes. Their use in links minimises the risk of over-size links reducing the actual concrete cover.

Scheduling using the standard 'H' designation to BS 8666: 2005 permits use of ductility Grades A, B or C for bar sizes up to and including 12 mm diameter, and Grades B or C for larger bars. If there are no special requirements for ductility the standard 'H' designation should be used as this allows the fabricator choice in selecting the grade of bar to suit variations in availability. Grade A material is usually acceptable for use in links. However, care should be taken to avoid inappropriate use of Grade A material in flexural situations, such as in yield-line designs, because of its lower ductility.

The bending schedules are the only information sent to the reinforcement supplier and they must therefore make clear any special requirements for reinforcement grade. The schedule is therefore where bars other than 'H' must be specified, although this information can also be included in NSCS Project Specification. Scheduling Grade A, B or C will ensure that the correct grade will be used, (albeit Grade B allows B or C to be supplied). Grade C, with the highest ductility, is likely to be needed only in special circumstances or for design to resist seismic forces.

Reinforcing fabric will almost always be Grade A material, and obtaining any other grade is likely to be very difficult. Care should therefore be taken when specifying fabric for a structural application that its ductility and localisation of strain does not cause a problem. Particular care should be taken if using small fabrics as the ductility requirements for small bars in mesh are very low.

It is implicit in this Specification that conventional steel reinforcement will be used. When specifying special types, e.g. stainless and possibly grade C, the Designer should consider availability.

Sustainable construction

Steel mills and fabricators can take steps to reduce the environmental impact of their processes and

ensure as far as possible the responsible sourcing of their materials. Most UK fabricators and mills (both UK and overseas) supplying rebar to the UK market have, or are working towards, certification to BS EN ISO 14001.

Two third-party accredited sustainability schemes are available in the UK for reinforcement, which address both production of the material and fabrication. These are the Eco-Reinforcement scheme operated by BRE Global, and the Sustainable Reinforcing Steel Scheme operated by CARES. Both these sustainability schemes are very new and a period of development is expected before they are both fully aligned with BS 8902 or each other. Further information about the schemes can be obtained from the UK Cares or Eco-Reinforcement websites allowing specifiers to identify any key project issues that may require selection of either scheme.

The recycled content of the steel is often seen as a key issue, especially when using the American Leadership in Energy and Environmental Design (LEED) assessment tool. It can be assumed that the average recycled content of reinforcement installed in the UK is greater than 90%. Further information on recycled content and other Life Cycle Assessment indicators can be found from the two schemes noted above.

Special reinforcement

In special circumstances (e.g. in extremely severe exposure conditions) the use of alternative materials might be considered; this would need to be referred to in NSCS Project Specification. These include epoxy-coated, galvanised and stainless steel reinforcement and non-ferrous reinforcement (i.e. fibre reinforced plastics). Where use of these alternative reinforcement materials is considered, specialist advice is required.

Fibres are increasingly used and may be proposed by the Constructor. Fibres can be specified for designed concrete in NSCS Project Specification using Cl. P1.5.1.

Fibres are added to the concrete at the batching plant along with any admixtures needed to ensure distribution. They can also be added under supervision at the site. Fibres are classified as micro-fibres or macro-fibres. Polypropylene micro-fibres can; improve the impact resistance and hardness, reduce bleeding, improve freeze-thaw resistance and reduce explosive spalling in fires. They have no post-crack capacity and do not replace structural reinforcement. Macro-fibres i.e. steel and synthetic fibres have post-crack capacity and can therefore replace reinforcement in certain applications, e.g. floor slabs and composite steel decks. Guidance can be found in Concrete Society publications TR63 *Guidance for the design of steel-fibre-reinforced concrete* and TR65 *Guidance on the use of macro-synthetic fibre reinforced concrete*.

The introduction of CARES Certification or equivalent into the specification results in a reduction of the risk of receiving reinforcement not in accordance with the specification and standards

The following references may be useful for special reinforcement and specialist advice should also be obtained.

Epoxy coated reinforcement, hot dip galvanising, PVC coating:

Comité Euro-International du Béton (CEB), *Coating protection for reinforcement. State of the art report*, Thomas Telford, London, 1995.

Concrete Society publication TR61: *Enhancing reinforced concrete durability*.

BS ISO 14654: *Epoxy coated steel for the reinforcement of concrete*.

Non-ferrous reinforcement:

Institution of Structural Engineers, 1999: *Interim guidance on the design of reinforced concrete structures using fibre composite reinforcement.*

FBE Report 8: *Effective use of fibre reinforced polymer materials in construction* (Halliwell & Reynolds, 2004).

American Concrete Institute, *Guide for the design and construction of structural concrete reinforced with FRP bars* technical committee document 440.1R-06, 2006.

Stainless steel

BS 6744: *Stainless steel bars for the reinforcement of and use in concrete – Requirements and test methods.*

Concrete Society publication TR51: *Guidance on the use of stainless steel reinforcement.*

6.1.1.1 to 6.1.1.3

6.1.2 Reinforcement handling

It is important that reinforcement is treated with care and used in the correct location so marking/ tagging is very important. Further guidance can be found in CIRIA Report 147: *Care and treatment of steel reinforcement and the protection of starter bars* (Bussell & Cather, 1995).

6.1.2.1 to 6.1.2.3

6.1.3 Spacers

Typically spacers will be at 1 m centres, or as otherwise necessary, to support the reinforcing steel as recommended in BS 7973–1 *Spacers and chairs for steel reinforcement and their specification – Product performance requirements.* Responsibility for fixing reinforcement with the correct cover and for ensuring that spacers and chairs are correctly spaced and have the required performance characteristics rests with the Constructor. The requirements set out in BS 7973 should be regarded as a minimum. Spacers are not usually shown on drawings; they are an important element in ensuring correct cover is provided to the reinforcement as lack of cover leads to premature loss of durability. Further guidance can be found in CIRIA publication C568, *Specifying, detailing and achieving cover to reinforcement* (King & Dakin, 2001).

The use of in-situ spacers is beneficial, for example in thick raft slabs, where the self-weight of the reinforcement is high and the base is uneven so there is the potential for a lot of variation in the cover. Casting in-situ strips in the structural concrete, not a blinding concrete, deals with the variation in base tolerance; gives a clear, safe, level base for fixing the reinforcement; and gives a quality-assured concrete in the cover zone.

6.1.3.1 & 6.1.3.2

6.1.4 Continuity strips

These can be specified on the drawings – any alternative proposal by the Contractor should be checked to ensure that the required performance is obtained. Specifiers should ensure that any continuity strips referenced on drawings are covered by the CARES scheme.

6.1.4.1 & 6.1.4.2

6.1.5 Couplers

Coupler locations required by the Designer must be shown on the drawings. Bars requiring

connection using a coupler are best scheduled as a shape code 99 identifying the end of the bar where a coupler is to be used so that it can be prepared as required.

It is best if only one coupler type is used at any one site. Specifiers should ensure that any couplers referenced on drawings are covered by the CARES scheme. Once agreed the coupler type should not be changed.

Where threaded couplers are used, care should be taken to avoid damaging the threads on the end of the bars and to ensure that an adequate length of thread is contained within the coupler. This is most simply achieved by marking the bar at half the length of the coupler and ensuring that the coupler is screwed firmly up to this mark.

6.1.5.1 & 6.1.5.2

6.1.6 Punching shear reinforcement systems

These can be specified on the drawings; any alternative proposal by the Constructor should be checked to ensure that the required performance is obtained. Specifiers should ensure that any punching shear reinforcement systems referenced on drawings are covered by the CARES scheme.

6.1.6.1 & 6.1.6.2

6.1.7 Fibre reinforcement

Fibres are added to the concrete at the batching plant along with any admixtures needed to ensure distribution. They can also be added under supervision at the site. Fibres are classified as micro-fibres or macro-fibres. Polypropylene micro-fibres can improve the impact resistance and hardness, reduce bleeding, improve freeze-thaw resistance and reduce explosive spalling in fires. They have no post-crack capacity and do not replace structural reinforcement. Macro-fibres i.e. steel and synthetic fibres have post-crack capacity and can therefore replace reinforcement in certain applications, e.g. floor slabs and composite steel decks. Guidance can be found in Concrete Society publications TR63, *Guidance for the design of steel-fibre-reinforced concrete* and TR65, *Guidance on the use of macro-synthetic fibre reinforced concrete*.

6.2 Execution

6.2.1 General

Any written instruction to cut reinforcement must come from the Engineer, irrespective of the contractual arrangements on the project.

Achieving the correct cover is vital. Too little cover has a fundamental influence on durability and fire resistance. A BRE study carried out in conjunction with the University of Birmingham on achieving the correct concrete cover in buildings has shown that the specified cover has often not been achieved. See *How can we get the cover we need?* (Clark et al., 1997) and CIRIA publication C568: *Specifying detailing and achieving cover to reinforcement* (King & Dakin, 2001), for advice on how to ensure the correct cover is achieved.

6.2.2 Tying

There is much evidence that tying wire ends left with insufficient cover corrode and cause concrete to spall. The need for carefully bending ends of tying wire away from the surface therefore cannot be over-emphasised.

Stainless steel tying wire may be necessary in some locations to avoid surface rust staining.

Some machines for tying prefabricated cages cannot use 16 gauge wire but will use thinner wire – if this is to be done it should be agreed with the CA in advance.

6.2.3

6.2.4 Projecting reinforcement

A grout wash consisting of a slurry of cement and water applied to reinforcement is the most commonly used protection for bare reinforcement, but this is not always cost effective as it has to be applied quite often, and may cause staining of finishes below when not applied carefully. If other methods are used it is important to ensure that the bond to the next lift of concrete will not be reduced. Further information is given in CIRIA Report 147, *Care and treatment of steel reinforcement and the protection of starter bars* (Bussell & Cather, 1995).

Projecting reinforcement may raise health and safety concerns; these concerns are reduced if projecting reinforcement is of U bars or can be avoided if couplers cast-in flush with the surface of the concrete or other proprietary products are used.

6.2.5 Site bending

Bending on site is best avoided as bars can get damaged – the inspection for cracks is essential.

6.2.5.1 to 6.2.5.3

Section 7 Prestressed concrete construction

7.1 Design and quality control

7.1.1 General

7.1.1.1 Contractors

Part of the CARES certification requires the contractor to declare all their post-tensioning jobs to CARES so that they can, if required, be audited. It may be worth the CA checking that this declaration is taking place.

Evidence of certification should be obtained at tender stage – it is available from the CARES website www.ukcares.com

The CA must check alternative schemes carefully to ensure they are equivalent; if an alternative accredited product certification is acceptable it is the responsibility of the post-tensioning contractor to ensure all necessary testing has been satisfactorily carried out on the strand or bar.

7.1.1.2 Operatives

The number of trainees should be limited and the ratio of trainees to experienced trained staff should be balanced according to circumstances and normally not exceed 50% of the post-tensioning personnel.

7.1.1.3 Quality plan

This must be agreed in advance with the Constructor. An independent inspection is to enable CARES or equivalent organisation to satisfy themselves that approved materials from approved suppliers are being supplied to and used on the site. It is not concerned with workmanship issues, which remain solely the responsibility of the Constructor.

7.1.1.4 Stressing calculations

Consideration may be given to requesting sample calculations prior to commencement. This will enable a review of the data to be undertaken but does not require subsequent submissions. Theoretical extensions are used as an indication that tendons have the correct load applied during stressing. The accuracy of extension calculations will depend on the accuracy of, among other things: the tendon profile, the assumptions made for movement at the anchorages, friction and wobble coefficients.

7.1.1.5

7.2 Materials

7.2.1 General

7.2.1.1 Grout

Bleed water is excess water in the grout that is not chemically bound and can lead to low density grout, producing cracking, shrinkage and porosity. Therefore the w/c ratio should be kept as low as possible. The necessary grout properties can be achieved with properly formulated grout materials and the addition of minimum quantities of water. The properties and quality of commonly available bagged cement can vary considerably and this can lead to an unacceptable and inconsistent quality of grout. Therefore pre-bagged grout is recommended. Bagged materials have a specified shelf life and the bags are normally date marked. Material must be used by the specified date.

7.2.1.2 & 7.2.1.3 Strand and stressing bar

Confirmation of the strand or bar supplier's approval status can be obtained from the CARES website www.ukcares.com

7.2.1.4 Coating material (unbonded tendons)

The coating will be either high density polyethylene or polypropylene. Specify the requirement in NSCS Project Specification. High density polyethylene is more flexible and less liable to embrittlement at extremely low temperatures, while polypropylene is more stable at high temperatures. Both materials have high resistance to abrasion and creep, although polypropylene is slightly superior in these respects. The use of PVC is not recommended since it is known that chloride ions can be released in certain conditions.

The coating thickness should normally be 1.0 mm to 2.0 mm depending on exposure conditions. Where there are particular requirements for more onerous exposure conditions e.g. car parks, reference should be made to Concrete Society publication TR47, *Durable post-tensioned concrete bridges*.

The interstices between wires are normally filled with grease to repel moisture. The pattern of the strand should not normally be clearly visible through the coating as this can be an indication of insufficient grease or coating thickness.

7.2.1.5 Anchorages

Evidence of qualification in post-tensioning kit and/or anchorage should be obtained at tender stage if possible.

7.2.1.6 Ducts and vents

Ducts are usually steel with a folded seam and are not leak tight. Currently the UK Highway Authority requires bridge ducting system to be non-metallic whilst most buildings use metallic. This is reasonable due to the less aggressive exposure conditions in buildings. Car parks, however, fall

between the two cases. There are at least two plastic duct systems suitable for car parks but these will lead to marginally higher costs. Currently it is recommended that plastic ducting is considered for car parks, particularly where they are part of a structure with a service life longer than 50 years. This would be high density polyethylene or polypropylene with a minimum wall thickness of 2.0 mm. The use of PVC is not recommended since it is known that chloride ions can be released in certain conditions. It should be noted, however, that in car parks the surface reinforcement is more likely to cause local problems than the post-tensioning and so plastic ducts are probably only worth considering seriously if stainless steel reinforcement is also used in critical areas – further guidance on this can be found in TR47, *Durable post-tensioned concrete bridges*. Specify any alternative requirements in NSCS Project Specification.

7.2.1.7

7.3 Execution

7.3.1 Tendons

7.3.1.1 Location

Flat/oval ducts are relatively stiff in the transverse direction and it may not be possible for tendons with this type of duct to be deviated around obstructions without cutting the ducting; this should be avoided if possible.

7.3.1.2 Fixing and support

Flat ducts are quite flexible in the vertical direction and it is common to install the strand within the duct and then place the tendon, which increases the stiffness and aids the achievement of a smooth tendon profile.

7.3.1.3

7.3.1.4 Marking

Where services, etc. are to be fixed to a slab, it is important that the slab is clearly identified as post-tensioned construction on all drawings and relevant documents. The actual position of tendons must be known accurately in both plan and elevation so that cutting into the slab for future fixings and holes can be done well away from the tendons; this should avoid tendon damage.

7.3.2 Vents

In many slabs the duct layout is simple and repetitive and vent labeling may not be necessary. However, with more complex duct/vent configurations where it is possible to confuse vents from different ducts, it is important to mark and identify the vents. Where this is required, it is specified in NSCS Project Specification. The default requirement for intermediate vents for ducts over 20 m in length may be relaxed in some circumstances; where appropriate this is noted in NSCS Project Specification – further guidance on this can be found in Concrete Society publication TR47, *Durable, post-tensioned concrete bridges*.

7.3.3 Cutting or drilling into prestressed slabs

Holes that cut through a tendon can seriously weaken a slab and so holes must not be cut before the tendon location has been checked. Where soffit marking has been used to indicate tendon position, caution is urged, especially if cutting close to the theoretical position, as the actual position may vary from the theoretical marked position. Where the tendon position is not accurately and authoritatively documented, reinforcement detection equipment should be used to locate tendon positions prior to any cutting or drilling work on the slab.

7.3.4 Stressing

Note that while the Specifier may not be the 'Designer' for the post-tensioning, it is important to be satisfied that the stressing operations will not impose unacceptable forces on the cores and columns as designed.

7.3.4.1

7.3.4.2 Measurement

A tendon 'group' is usually taken to be a whole panel for flat slab construction. If this is not the case it must be specified in NSCS Project Specification. Theoretical extensions are used as an indication that tendons have the correct load applied during stressing. The accuracy of extension calculations will depend on the accuracy of, among other things, the tendon profile and the assumptions made for movement at the anchorages, friction and wobble coefficients. Note that when stressing to 80% of characteristic strength, 15% extension for an individual tendon is considered to be too high. In such cases the extension should be limited to 10%. If load/extension graphs for more than four points on trial tendons are required this must be stated in NSCS Project Specification.

7.3.4.3 Commencement

There can be significant differences in concrete strength between the first and last loads to be poured; therefore the slab's concrete transfer strength should be based on cubes taken from the last concrete load.

7.3.5

7.3.6 Anchorage protection

In the case of grouted tendons, special mortars/renders are recommended. Anchors are usually cast into pockets in edge beams and the pockets sealed with mortar/render. The detailing of this area requires some attention, as mortar/render can be permeable and subject to shrinkage. Appropriate materials and application are required.

The tendon encapsulation (i.e. the ducts and anchorage system enclosing the tendon) for bonded flat slabs cannot usually be sealed to the same degree as that used for civil engineering structures designed to Concrete Society publication TR47, *Durable, post-tensioned concrete bridges* where steel ducts are often used and the anchors are usually sealed with render instead of grout caps. Additionally flat slabs are thinner in section and contain significantly less reinforcement and can be damaged by high grout pressure.

7.3.7 Grout trials

For slabs it is expected that the trials will consist of two trials of a horizontal duct arrangement to simulate the slab arrangement.

Independent evidence of previous successful trials may be acceptable subject to the agreement of the CA.

Where it is agreed that a grout trial is not necessary, it is recommended that the audit is carried out as early as possible in the work.

Grout suitability tests are usually undertaken prior to works commencement to prove the proposed grouting system. Acceptance tests are undertaken during the works to ensure grout complies with the NSCS Project Specification.

7.3.8 Grouting equipment

Excessive grout pressure can damage the ducting and the structural element; it is therefore necessary to have systems/equipment in place to prevent excessive grout pressure. Where the grout injection point is remote from, or on a different level to, the grout pump it is necessary to employ some means of preventing excessive grout pressure at the injection point, such as a pressure gauge and stop valve.

7.3.9

7.4

Section 8 Concrete and concreting

8.1 Concrete

Concrete is specified to comply with BS EN 206–1 and the complementary British Standard BS 8500. Specifiers are expected to be familiar with these standards and the language they use as extensive guidance on this has been available for several years. These standards define specification as 'final compilation of documented technical requirements given to the Producer in terms of performance or composition' and the specifier as the 'person or body establishing the specification for the fresh and hardened concrete'.

The supply of most concrete in the UK is from ready-mixed concrete plants; there is a plant within 15 miles of almost any location in the country, and the suppliers' technical departments have extensive experience of design and the effect on concrete of varying the mix constituents and of additives.

Concrete selection

Concrete has a dual strength classification e.g. C28/35 to allow for both cylinder and cube strengths. The second number is the cube strength. It is important that full classification is to be given to avoid misunderstanding.

BS 8500 covers the selection of concrete and cover to reinforcement to suit design exposure conditions. There are six exposure classes to BS EN 206–1:

- No risk of corrosion or attack (XO)
- Corrosion induced by carbonation (XC)
- Corrosion induced by chlorides other than from sea water (XD)
- Corrosion induced by chlorides from sea water (XS)
- Freeze/thaw attack (XF)
- Chemical attack from natural soil and groundwater (XA)

The concrete selected for any application must be suitable for all the applicable exposure classes as there can be more than one at any one location or for any one element.

In the UK the XA class has been replaced in BS 8500 by a system based on the guidance given in BRE Special Digest 1, using the route of design sulfate (DS) class and hence ACEC (aggressive chemical environment for concrete) class to classify the ground conditions and give the requirements for concrete as a design chemical (DC) class.

The BS 8500 tables refer to minimum cover to which an allowance for tolerance must be added to give the nominal cover to be noted on the drawings. This tolerance is 10 mm by default in the UK in accordance with the UK National Annex to BS EN 1992-1-1; a reduced tolerance could be specified, particularly for precast work. The Institution of Structural Engineers publication *Standard method of detailing structural concrete – A manual for best practice* suggests that, when use of a SpeCC Registered Contractor is specified, Δc_{dev} could be reduced to 5 mm. It is recommended that this reduction in tolerance should only be permitted if records from the Contractor's quality system show that this level of accuracy in fixing the reinforcement is being achieved on site.

Generally, consistence for most structural concretes is expected to be a slump in the S3 range. However, a different consistence can be appropriate, depending on the proposed method of placement.

Sustainable construction

The most important sustainability issue to be considered in the specification and supply of concrete is the minimisation of the Portland (CEM I) cement content and hence maximisation of secondary cementitious material content; this should not be compromised by the other issue, which is that of maximisation of the recycled or secondary aggregate content. This is because the embodied CO₂ associated with ggbs, fly ash or limestone fines is significantly less than that of Portland cement clinker.

Some environmental impact assessments include a measure of resource use based on the mass of the material used rather than the amount used compared to its availability. In these assessments heavyweight building materials such as cement and concrete are penalised irrespective of the relative abundance and continued availability of the raw materials. Due to this type of impact assessment there is a lot of pressure to incorporate recycled concrete aggregate, recycled aggregate or secondary aggregates in concrete, but care must be taken to ensure that the use of these materials does not compromise durability.

The BRMCA *Guidance document on sustainable concrete design and rating systems* contains a summary of how concrete design relates to systems such as BREEAM.

Identity testing and conformity

'Identity testing and conformity testing' are specified under the new standards – not 'acceptance and compliance testing' as was UK practice until 2003. Conformity testing is under the control of the Producer. Producers are required to provide testing, called 'conformity', to verify that the concrete fulfils the specified requirements. Site testing is 'identity testing' to indicate that concrete comes from a conforming population. Any requirement for on-site testing must therefore be fully defined in NSCS Project Specification. This will include any requirements for testing fresh concrete properties such as consistence and air content.

8.1.1 General

8.1.1.1 Standards

Reference is made throughout to BS 8500 and BS EN 206-1. These are the current British Standards dealing with specifying concrete as a material. Unless modified by this specification the procedures to be used in producing, transporting, sampling and testing of the concrete should conform to the relevant parts of these standards.

BS 8500: 2006, *Concrete – Complementary British Standard to BS EN 206-1* is in two parts:

Part 1: *Method of specifying and guidance for the specifier.*

Part 2: *Specification for constituent materials and concrete.*

8.1.1.2 Materials

General

The final specification given to the concrete Producer will include information from the Designer(s) of the structure and the Constructor, and it is important that all parties are aware of the specified information given to the Producer by others.

Selection of the correct concrete for use in any application must consider the exposure conditions, the effect of tolerances on the specified concrete cover, the intended working life, the required finish, the method of placing and the means of compacting the concrete. Specifications therefore should, where appropriate, include requirements other than strength, such as maximum water/cement ratio, cement and aggregate type.

The location at which there is a change to concrete specification could in some instances be critical (e.g. monolithic kickers); see NSCS Guidance to Cl. 8.2.1.3.

Concretes can be subject to chemical attack and the restrictions on mix constituents to avoid problems with chlorides, sulfates and alkali-silica reaction (ASR) are given in BS 8500–1: 2006, Annex A, dealing with durability. More comprehensive guidance on ASR is given in BRE Digest 330, *Alkali-silica reaction in concrete* and Concrete Society publication TR30, *Alkali-silica reaction – minimising the risk of damage to concrete*, 3rd edition, 1999. Guidance on resistance to chemical attack from materials in the ground is given in BRE Special Digest 1 (2005).

When freezing and thawing occurs under wet conditions, enhanced durability can be obtained by the use of suitable air-entrained concrete. The specific recommendations are given in BS 8500–1: 2006, Annex A. Where severe freeze/thaw conditions are identified the specification should include a requirement for freeze/thaw resisting aggregates see BS 8500–1: 2006, Annex A, Cl. A.7.5.

Sustainable construction – Cement

The specification must achieve a balance, which ensures workability, durability, appropriate rate of strength gain and, for visual concrete, the required colour. The specification can also make a significant contribution to the reduction of global warming potential of the concrete through the minimisation of Portland (CEM I) cement content and hence maximisation of the use of other cementitious materials.

The practical minimum cement content will vary with many factors including concrete strength class, water/cement ratio, cement type, placement method (e.g. skip/pump) and aggregate type and grading. Concrete suppliers should be encouraged to employ admixture technology to enable use of the minimum cement content commensurate with the overall properties required of the concrete.

The inclusion of other cementitious materials, such as fly ash, ground granulated blastfurnace slag (ggbfs), limestone fines and silica fume has been established over many years due to the positive benefits to the properties of the resulting concrete in certain circumstances.

A reasonable specification for cement replacement might be either:

Fly ash to BS EN 450–1 in the following proportions:

- 35% by mass of cement in structural elements (cement type IVB-V).
- 40% by mass of cement in foundations (cement type IVB-V).
- 55% in HVFAC applications (cement type IV-B).

Or

Ggbs to BS EN 15167–1 in the following proportions:

- 40–60% ggbs by mass of cement in structural elements (cement type IIIA).
- 70–75% ggbs by mass of cement in foundations (cement type IIIB).

Where it is not possible to obtain these proportions, a reduced quantity is better than none at all.

It is better to allow the use of either fly ash or ggbs as ready-mixed concrete suppliers are likely to stock only one of the two materials at any given plant.

Both fly ash and ggbs offer a significant saving in embodied CO₂ content over CEM I concrete. For a typical RC40 mix, the use of 30% fly ash will give a saving of approximately 60 kg CO₂/m³ and the use of 50% ggbs will give a saving of approximately 145 kg CO₂/m³. Accurate figures are difficult to obtain but, for a typical reinforced concrete element, some estimates would put these CO₂ savings as representing of 15% and 38%, respectively.

Strength gain of concrete with higher proportions of fly ash or ggbs will be slower under cooler temperatures and may result in increased striking and/or de-propping times; the concrete Producer is usually able to advise on the expected rate of strength gain for any particular concrete. At normal placing temperatures ggbs, fly ash or limestone fines do not contribute to early strength, that is strength from 1 to 3 days. So if the cement or combination cement of CEM I and either ggbs, fly ash or limestone, include 50% of these materials then the early strength can be assumed to be 50% lower than would be obtained with a CEM I concrete. Where there are technical requirements for high early strength gain it may be appropriate to use a reduced fly ash or ggbs proportion, or plain CEM I cement. Each situation should be judged on its own merit and where permission is granted it should be restricted to only those elements, such as post-tensioned and precast concrete, or other areas where it is essential. For example, the need to erect a tower crane should only affect the part of a slab where it is sited and not the whole slab.

An excess of fly ash is available in the UK; hence its inclusion in concrete is to be encouraged, not only for its properties, but also to avoid the generation of waste. Supply of ggbs is limited and so some is imported; even taking account of substantial travel distances it will have a lower global warming potential than Portland cement.

Sustainable construction – recycled and secondary aggregate

The replacement of primary aggregates is encouraged in rating systems such as BREEAM and the Green Guide to Specification.

BS 8500 covers the use of recycled concrete aggregate (RCA) and recycled aggregate (RA); RCA is primarily crushed concrete and RA is usually crushed demolition material (see table 3 of BS 8500–2: 2006).

The use of secondary aggregates such as china clay stent (crushed granite), air-cooled blastfurnace slag, and sintered fly ash lightweight aggregate or the by-products of other process are not explicitly covered by BS 8500. This can be overcome by showing that secondary aggregates can comply with the requirements for aggregates in the code. Research on secondary aggregate is probably only worthwhile on larger projects.

In the UK there is sufficient demand for RCA to be locally used in place of primary aggregates in applications such as landscape filling, road construction and hardcore for buildings; it is unlikely to be sent to landfill. It does not need to be specified for use in structural concrete to ensure

it is recycled. Inclusion of RCA in structural concrete does not reverse the downcycling during the crushing of concrete where high environmental impact cement is converted to low impact aggregate.

Up to 20% RCA should be permitted in NSCS Project Specification except in the following circumstances:

- Coarse RCA shall not be used in concrete with a strength class greater than C40/50.
- Coarse RCA may be used in exposure classes other than X0, XC1, XC2, XC3, XC4, XF and DC-1 only if it has been demonstrated that the resulting concrete is suitable for the intended environment.
- For FND or PAV concrete in accordance with BS 8500-2: 2006, Cl. 6.2.2.

Material obtained by crushing hardened concrete of known composition that has not been in use and not contaminated during storage and processing may be used in any strength class.

However, despite the push from rating systems, any project specification of recycled and secondary aggregates should carefully consider the following principles:

- RA can be a highly variable and is generally suitable for use only in low-grade concrete; it is not recommended for use in structural concrete.
- RCA should only be used if it is locally available (within roughly 30 miles) or would otherwise go to landfill. Long distance road transport of RCA is to be discouraged.
- The deployment of RCA to replace primary aggregates in situations where both fine and coarse portions can be used (e.g. as fill) should be given preference to its deployment in structural concrete.
- In the UK there are secondary aggregates available to some locations, but not all, which would otherwise be stockpiled or treated as waste. Secondary aggregates may be transported a significant distance by rail or water if they would otherwise be treated as a waste.
- The primary aggregate replacement level should be chosen to ensure that the Portland cement content is not significantly raised.

Designated concretes are concretes identified by the application for which the concrete is to be used to satisfy requirements for strength and durability. Use of designated concretes is intended to encourage standardisation. Their use should maximise the input to the design of the concrete by the Producer and make the task of the specifier easier.

Designated concretes cannot be used in XD or XS exposure classes and the range of strength classes available is limited (to the normal structural range of C20/25 to C40/50). The concrete is specified by considering the exposure conditions and then identifying from BS 8500-1: 2006, Annex A, Tables A.13 or A.14 the application for which the concrete is to be used, or the application that most closely resembles it, and citing the corresponding designation. Specifiers should note that for many applications more than one exposure class can apply to the concrete and the concrete selected must be suitable for all classes, with adjustments made if needed to the cover required to suit the different conditions. The Producer is responsible for producing a concrete that meets the requirements and for ensuring that the constituent materials conform to the requirements of the standards.

Responsibility for testing and assuring conformity rests with the concrete Producer via their Quality Assurance (QA) system. Designated concrete can be produced only by Producers who have a third-party accreditation for their quality assurance scheme; see Cl. 8.1.3.1 of this Guidance.

Designed concretes are specified by their required performance in terms of a strength class, subject to any special requirements for materials, minimum or maximum cement or combination content, maximum free water/cement ratio and any other properties or limitations on composition. The Producer prepares a concrete design to meet the requirements of the specification based on these requirements. The use of designed concrete covers all exposure classes.

The Specifier is responsible for ensuring that the special requirements for the concrete are in accordance with the standards and the requirements of the Designer. Specifying designed concrete therefore requires more input from the Specifier than for designated concrete.

The Producer is required to test and assess the conformity of these concretes for properties including strength. The Specifier may wish to have additional strength testing in some circumstances. This is 'identity testing' and it identifies whether the batches under investigation meet the requirements of the specification.

Where there is a critical element, e.g. very high strength columns or concrete production is not covered by third-party certification, routine identity testing is recommended. Identity testing needs to be carried out with great care to avoid unnecessary dispute over quality of concrete. The Constructor carries out identity testing.

Prescribed concretes are specified by giving the Producer full details of their constituent materials and properties or quantities of those constituents required to produce a concrete with the required performance. Specification of a prescribed concrete is unlikely to be an economic way of producing a concrete with a required strength and leaves the Specifier alone responsible for ensuring that the concrete conforms to the standards, as the Producer has no involvement in the selection of the constituent materials.

In prescribed concretes the assessment of the mix proportion forms an essential part of the conformity requirements. Strength testing is not used to assess conformity. A prescribed concrete should be specified only where there is reliable previous evidence or data, established from initial testing, that with the materials and workmanship available the concrete produced will have the required characteristics. This type of concrete may be required to produce a concrete having particular properties, e.g. to obtain an exposed aggregate finish.

Standardised prescribed concretes suitable for use only in limited structural applications such as trench fill footings for housing, or similar projects, blinding and other minor work in unreinforced concrete. The Producer provides a concrete with the proportions defined by BS 8500-2: 2006, Section 9.

Proprietary concretes These are concretes that depend on the use of a proprietary admixture and cannot be made without the admixture suppliers input on dosage, etc. This method of specification requires the specifier to check the claims made by each different supplier so that at tender stage they may be specified as a particular supplier's product or similar approved. If alternatives are to be offered by the Constructor this should be made clear in NSCS Project Specification, Section P2.5 so that the specifier can check that the alternative proposal is acceptable. Self-compacting concrete is a fairly common example. Care is needed when completing table P1.8.5 in NSCS Project Specification for these concretes, especially when considering the need for testing, which will need to be agreed between the Designer and the Constructor.

8.1.1.3

8.1.1.4 Site addition of water to ready-mixed concrete

Most structural concrete should be consistence class S3 (slump class limits of 100 to 150 mm). This should reduce the effort in placing and compacting the concrete and minimise the occasions when water is added on site. These advantages should outweigh the apparent cost, in terms of minimum material cost, of buying concrete with a traditional 50 mm slump. It should also be noted that water addition on site will almost certainly result in non-conforming concrete, the need for additional testing and a transfer of responsibility for the concrete quality from the Producer to the Constructor who asks for the addition of water. Guidance given in Cl. 8.1.2.2 of this document also applies.

8.1.2 Testing

8.1.2.1

8.1.2.2 Conformity testing

BS EN 206–1 requires producers of concrete to undertake conformity testing of all the concretes they supply. This may be based on testing individual concretes or on concrete families. When a concrete fails the conformity criteria, the Producer is required to inform the specifier. The NSCS then requires this information to be passed on to the CA and the Employer. The non-conformity can be for properties other than strength.

Additional independent testing can be specified, called identity testing, to check that concrete delivered to the site comes from a conforming population (meets the requirements of the specification) and to give confidence to the CA. This needs to be indicated in NSCS Project Specification so the Producer can take this into account. (The risks to the Producer of routine identity testing of groups of results are higher than those from application of the continuous production conformity criteria for groups of results.) The identity testing criteria for the lowest acceptable value of individual results are the same as the Producer's conformity criteria for individual results.

Additional testing may also be carried out, for example, to check the concrete strength is acceptable for early striking of formwork – this is not covered by the NSCS.

The NSCS approach to testing makes a clear distinction between designated and designed concretes. For designated concretes no identity testing is specified (except for cases when water is added on site). For designed concretes identity testing is identified in NSCS Project Specification (Rows 25, 26, & 27 of table P1.8.2) and the specifier needs to make a decision on whether this is required.

8.1.2.3 Identity testing

Identity testing for strength This requires careful consideration by the Specifier. The following issues should be considered when reviewing the conformity testing method of acceptance for concrete. In selecting the concrete and testing required for a project, consider:

- Is strength a key criterion in the performance of the concrete?
- Will a concrete with strength marginally below that specified have any affect on the performance of the completed structure?
- Why test for a non-critical property?
- The concrete may not have been sampled correctly, and hence the sample is not representative of the supply.
- Testing for strength will not reveal if the wrong concrete has been placed in an element of the structure.

- Site-made test cubes may not be properly made or cured and this will affect the results of tests.
- Has the specifier fully understood the statistics of the design partial safety factors and their relationship to the acceptance criteria for tests on concrete?

The volume of concrete at risk of non-conformity is not necessarily related to the sampling rate; the rate of sampling is left to the specifier to determine as no guidance is given in Annex B of BS EN 206–1: 2000, or Annex B.5 of BS 8500–1: 2006. However the specification must make clear the 'defined volume' to be tested e.g. all the columns at one level in a building and the level of testing required for each volume. Each volume identified would then be assessed for conformity by grouping the test results into non-overlapping groups of not more than six results taken in chronological sequence.

Note: a test result is the average of the results of two or more specimens made from one sample for testing at the same age.

The procedure and conformance criteria for determining whether a defined volume of concrete comes from a conforming concrete of the specified strength class are outlined in BS EN 206–1: 2000, Annex B, with clarification given in BS 8500–1: 2006, Annex A.10 and Annex B.5. Any failure to satisfy the identity testing criterion should be discussed with the Producer prior to requiring any other action to be taken.

If the Specifier considers that identity testing is required, a guide to the rate of identity testing might be:

- | | |
|---|----------------------------|
| ■ Very critical (contract defined) | 1 sample per load |
| ■ Critical elements (very high strength columns, masts, cantilevers etc.) | 1 sample per 2 loads |
| ■ Typical elements (beams, slabs etc.) | 1 sample per 4 to 10 loads |
| ■ Low risk elements (rafts etc.) | May not be required |

It is essential that the specifier ensures that the concrete Producer is aware of any requirements for regular identity testing as this may require the Producer to adjust their production margin as the risk of a test failure is statistically higher for identity testing than for conformity testing.

Identity testing for properties other than strength If testing for properties other than strength is required either by the CA or the Constructor, this needs to be outlined in NSCS Project Specification and must be communicated to the Producer. These tests, for consistence, air content, etc. are carried out by the Constructor in accordance with BS EN 12350.

Testing after site addition of water In the past the addition of water to ready-mixed concrete on site has caused problems and misunderstanding. BS EN 206–1 states that it is, in general, forbidden and the specification of concrete with a higher consistence should reduce the need for addition of water on site, as the usual reason for adding water is to improve the consistence. However, it is expected that there are occasions when it could make more sense to add water on site than to send the concrete away. Any water added on site should be noted on the concrete delivery ticket and it should be clear who accepts responsibility for the addition, the Producer or the Constructor. BS EN 206–1 requires the delivery ticket to be marked as 'non-conforming' unless the Producer takes responsibility for the addition, and the addition of water on site results in the total water content of the concrete being within the design limits. (For instance, if the water/cement ratio of the concrete was 0.55 but the specified maximum value was 0.6, water addition could be acceptable if the addition changed the ratio by less than 0.05 – provided the specified maximum strength also

can still be guaranteed.) However, to give confidence to the CA, the NSCS requires identity strength testing for designed AND designated concretes whenever water is added on site.

Early age strength testing The assessment of early age concrete strength takes on particular significance in the context of early striking. Guidance on such assessment is given in the CONSTRUCT publication *Guide to flat slab falsework and formwork*.

Guidance on the use of in-situ test methods such as the Lok test as an alternative to conventional cube testing for early age strength determination is given in an European Concrete Building Project (ECBP) Best Practice Guide, *Early age strength assessment of concrete on site* (BCA, 2000).

8.1.2.4

8.1.2.5 Delivery tickets

These are very useful if it appears that there may be a problem with concrete on site, and in this situation should be the first evidence to be examined by the CA or Designer. Double checking the delivery ticket must be done before asking for concrete testing as if a mistake has happened and the wrong concrete has been used this should affect the testing required.

8.1.3 Plant – ready-mixed concrete

8.1.3.1 Third-party accreditation

The NSCS Standard Specification requires the use of ready-mixed concrete suppliers that hold third-party certification such as The Quality Scheme for Ready Mixed Concrete (QSRMC), or equivalent certification, and encourages the use of designated concretes. If supplies from other plants are to be used this must be noted in NSCS Project Specification.

QSRMC requires certified suppliers to operate a process control system for all the concretes they produce. This includes random sampling and testing of the concrete to monitor conformity with the specification. The compressive testing of concrete specimens should be carried out in a laboratory either accredited by UKAS as conforming to BS EN ISO IEC 17025, *General requirements for the competence of testing and calibration laboratories* or certified by QSRMC as conforming to the QSRMC Quality and Product Conformity Regulations, in particular Regulation 8.2.4(4).

BS 8500–2: states that designated concretes can be supplied only by ready-mixed concrete companies holding current product conformity certification based upon product testing and surveillance coupled with approval of the quality system to BS EN ISO 9001 by a certification body accredited by the Secretary of State (or equivalent) for the relevant areas of product and systems conformity certification. Certification from QSRMC meets this requirement.

It is recognised that the most effective way of meeting the quality requirements of all appropriate standards and specifications is to specify QSRMC certification, or equivalent, for the supply of all concrete.

It should be noted that other forms of certification, which do not meet the QSRMC Quality and Product Conformity Regulations, are also available to specifiers/users of ready-mixed concrete. However, not all third-party certification schemes are the same, and the stringency of the certification process may not be what the consumer requires in all cases.

To determine which certification scheme is appropriate the purchaser/specifier should examine the published regulations produced by the certification body and seek confirmation of what industry representation have been involved in their preparation together with confirmation of the assessment team's experience and ability.

For any third-party certification body acting on behalf of the specifier/user in assessing a concrete producer's capability, appropriate expertise of assessors is paramount. QSRMC is the only scheme dedicated to the concrete industry specialising in ready-mixed concrete. It is controlled by a governing board, on which organisations with an interest in the quality of concrete are represented. These organisations include The Concrete Society, the Institutions of Civil and Structural Engineers, and Government bodies such as the Highways Agency and the National House Building Council.

BSI operates a Kitemark scheme, which certifies some ready-mixed concrete suppliers.

8.1.3.2

8.1.4 Plant – other concrete

This clause is intended to cover site or precast yard batched concrete, which is not normally covered by third-party certification. If a Company certified by QSRMC, or equivalent, erects a dedicated site plant or provides a plant to supply concrete to manufacture precast products, such plants will hold third-party certification from QSRMC, or equivalent.

8.1.5 Supply and transport

The addition of water to ready-mixed concrete on site can cause problems and misunderstanding. BS EN 206–1 states that it is, in general, forbidden and the specification of concrete with a higher consistence should reduce the need for addition of water on site, as the usual reason for adding water is to improve the consistence. However, it is expected that there are occasions when it would make more sense to add water on site than to send the concrete away. Any water added on site should be noted on the concrete delivery ticket and it should be clear who accepts responsibility for the addition, the Producer or the Constructor. BS EN 206–1 requires the delivery ticket to be marked as 'non-conforming' unless the Producer takes responsibility for the addition and the total water content of the concrete remains within the design limits (i.e. if the water/cement ratio of the concrete was 0.55 but the specified maximum value was 0.6 then water addition could be acceptable if the addition changed the ratio by less than 0.05). However, to give confidence to the CA, the NSCS requires identity strength testing for designed AND designated concretes whenever water is added on site. Cl. 8.1.2.2 in this Guidance applies.

8.2 Concreting

8.2.1 Placing and compaction

8.2.1.1 Placing

For certain operations e.g. where there is congested steel, deep lifts, etc. it may be necessary to specify a higher consistence, the use of a small size (10 mm) aggregate or self-compacting concrete to help achieve full compaction and the required finish. However, any concrete used must still be cohesive enough to prevent segregation occurring. Discussion in advance of placing with the Producer on the requirements of the concrete is paramount.

8.2.1.2

8.2.1.3 Kickers

Kickerless construction is often chosen by the Constructor; as it helps to speed up the construction process since the shutters can be set up the day after the slab has been poured, whereas if kickers are used it can take at least a day to form and concrete the kicker. There are a variety of methods

that can be used for kickerless construction – the choice of method is best left to the Constructor. Where kickers are used they must be formed using the same concrete as that in the columns, not a site-made bucket of dubious quality concrete, and should be of sufficient height to properly locate and help stabilise the column formwork.

Kickerless construction is not recommended for water-resisting construction as monolithic kickers have generally been found to be better at limiting water penetration.

Guidance is given in Concrete Society publication TR49, *Design guidance for high strength concrete*, on the effect of any difference in strength of slab and column whether or not kickers are used. In summary, no problems should be experienced where the column strength is not greater than 1.4 times the slab strength.

8.2.1.4 Premature cessation

When a pour has been prematurely stopped it is often acceptable to cut back by mechanical means or by jetting until an acceptable, sound vertical face is formed. Any such procedure would need to be agreed in advance with the CA.

8.2.2 Concreting in extreme conditions

When it is possible that construction may take place during extreme climatic conditions then suitable precautions should be put in place by the Constructor before work starts.

8.2.2.1 Cold weather

Possible measures to reduce risks from the concrete freezing, low rates of strength gain or extended stiffening times as outlined in BS 8500 include:

- Increasing the cement content to increase the heat of hydration.
- Using a cement or combination with a higher heat of hydration.
- Using admixtures to reduce the setting time or increase the rate of strength gain.
- Heating the concrete.

Guidance is given in Concrete Society publication CS164, *Concrete practice – Guidance on the practical aspects of concreting* – Good Concrete Guide 8.

8.2.2.2 Hot weather

Possible measures to reduce risks from reduction in working life due to evaporation or accelerated hydration, or the risk of high temperature rises causing early age thermal cracking are outlined in BS 8500. They include:

- Using admixtures to retard hydration or increase consistence.
- Using a cement or combination with a low heat evolution.
- Cooling the concrete.

8.3 Curing

8.3.1 General

Curing is the process of preventing the loss of moisture from the concrete whilst maintaining a satisfactory temperature regime. The curing regime should prevent the development of high temperature gradients within the concrete.

Curing and protection should start immediately after the compaction of the concrete to protect it from:

- Premature drying out, particularly by solar radiation and wind.

- Leaching by rain and flowing water.
- Rapid cooling during the first few days after placing.
- High internal thermal gradients.
- Low temperature or frost.

Where members are of considerable bulk or length, the cement content of the concrete is high, the surface finish is critical, or special or accelerated curing methods are to be applied, the method of curing should be specified in detail.

It should be noted that BS EN 13670 requires that during the curing period no part of the concrete surface should fall below a temperature of 0 °C until the concrete has attained a strength of 5 N/mm². In the UK this temperature has in the past been specified as 5 °C and in fact problems have been noted if the temperature falls below 7 °C.

The surface temperature is lowest at arrises and depends upon several factors:

- The size and shape of the section.
- The cement class and cement content of the concrete.
- The insulation provided by the formwork or other covering.
- The temperature of the concrete at the time of placing.
- The temperature and movement of the surrounding air.

If not measured or calculated, the surface temperature should be assumed equal to the temperature of the surrounding air see CIRIA Report 136 *Formwork striking times – Criteria, prediction and method of assessment* (Harrison, 1995).

The most common methods of curing are:

- Maintaining formwork in place.
- Covering the surface with an impermeable material such as polyethylene, which should be well sealed and fastened.
- Spraying the surface with an efficient curing membrane. An efficiency index of 90% should be obtained when tested in accordance with BS 7542: *Method of test for curing compounds for concrete*.
- Continuous or frequent applications of water to the surface, avoiding alternate wetting and drying and the application of cold water to warm concrete surfaces; this method should not be used when there is the possibility of freezing conditions.
- Using insulating concrete formwork systems.

8.3.2 Early age thermal cracking

This commonly occurs when concrete is to be placed in a large volume pour, where concrete with a high cement content is used, or where the section thickness exceeds 500 mm.

The NSCS Standard Specification requires that the temperature of the concrete does not exceed 65 °C. The temperature gradient across a section should be controlled to limit the temperature differential to 20 °C. Higher values may be appropriate for concretes made with coarse aggregates, which have a lower coefficient of thermal expansion and higher tensile strain capacity, see Table 7.1 of CIRIA Report C660, *Early-age thermal crack control in concrete* (Bamforth, 2007). Temperatures should be monitored until the hottest part of the section is less than 20 °C above the minimum daily ambient temperature. Concrete should be protected from abrupt changes in temperature at the end of the curing period. The peak temperature achieved by the concrete is affected by the type of mix, additives, protection, type of formwork, stripping times, etc. and by the ambient temperature.

Temperature variation across a section can be controlled by various methods such as the use of insulation and the timing and method of formwork removal. External restraints need to be taken into account. Further information can be found in CIRIA Report 135, *Concreting deep lifts and large volume pours* (Bamforth & Price, 1995), and CIRIA Report C660, *Early-age thermal crack control in concrete* (Bamforth, 2007).

8.4 Inspection – post-concreting

8.4.1 General

It is important that the works are inspected before any areas are handed over to other sub-contractors to avoid future arguments about who caused any damage. Damage caused by any means should be made good by the Constructor (obviously to the agreement of the CA). If others have caused the damage it is presumed that compensation will be sought under the terms of Contract.

8.4.2

8.5 Surface cracking

8.5.1 General

All parties should be aware that concrete will crack and that in most cases this is not harmful. The 0.3 mm surface crack width limit for superstructures is taken from NA to BS EN 1992-1-1: 2004 Table NA.4.

The 1 to 2 mm surface crack width limit for ground-bearing slabs is taken from Concrete Society report TR34, *Concrete industrial ground floors – A guide to their design and construction* (edition 3). In ground-bearing slabs, in-panel cracking of width up to 2 mm might occur but may not be acceptable in-service. Ground-bearing slabs require careful detailing to ensure that cracking is limited. During the 1990s, floor laying became increasingly mechanised: floors were laid in large areas and sawn into panels of about 6 × 6 m. Thermal contraction and drying shrinkage are accommodated by the cracks induced below these saw cuts. The fabric limits the opening of these induced cracks to a typical width at the top surface of 1 to 2 mm. If mid-panel cracks occur because of shrinkage, the fabric will provide some restraint to opening of the crack, the width at the top surface again being 1 to 2 mm. If these crack widths are not acceptable e.g. edge breakdown is causing truck operation issues, remedial methods should be agreed. Large area jointless slabs (50 m × 50 m) are also constructed, generally using steel fibres. Occasionally these large areas exhibit in panel cracks and remedial methods should be agreed.

In locations where the Engineer requires crack widths to be limited to less than the value given in NSCS Standard Specification, the design should be carried out accordingly. In particular the reinforcement detailed must be adequate, as otherwise the Constructor will not be able to achieve smaller crack widths however much care is taken during construction. Any restriction or variations on crack widths that the Engineer may require in water-resisting or prestressed structures, for example, should be highlighted in NSCS Project Specification. Extra care will be needed in concrete selection and on site during construction if lower crack widths are to be achieved.

Cracking may only become visible some time after construction when most shrinkage has taken place and full service loads are applied. Guidance on non-structural cracking in concrete can be found in Concrete Society publication TR22, *Non-structural cracks in concrete* (4th edition, due 2010).

8.6 Surface finishes

8.6.1 Formed finishes

It is important not to 'over-specify' the quality of finish, particularly where it will be covered up by following work. But whatever finish is specified, the concrete must be fully compacted. The lighting of, and viewing distance of, a finish can make a great difference to its acceptability for a particular use. Unless otherwise specified, it is normally assumed that finishes are judged when viewed from 3 m. Closer assessment should only be made where such in-service viewing conditions exist.

The quality of formwork and joinery will be a major influence on the quality of the concrete finish. It is essential that the formwork is robust and well constructed and does not deflect during concreting. The design of the formwork support is therefore essential in achieving good visual concrete. All joints must be, as far as possible, grout tight; careful detailing of joints and corners can help achieve this.

Release agents can affect the colour of the surface so special care with their selection is needed for fair faced concrete finishes.

Plywood is the most common formwork face material – it comes in a range of quality from untreated fir through resin- and paper-faced ply to natural birch ply. Guidance on type and use for plywood is given in this Guidance Cl. 5.2: Formwork materials. There is a large variety of other materials, e.g. steel, GRP, plastic, rubber, fabrics or plastic-lined cardboard tubes, and some can be left in place as permanent formwork.

Controlled permeability materials act as a filter and drain to remove water and air from the concrete surface. They are usually positioned over a structural backing to become a type of form liner. The concrete surface finish produced tends to have fewer blowholes, is slightly textured and has improved surface durability characteristics.

Each type of face material has its own benefits and applications, particularly where timber sheet material cannot be shaped to meet the design requirements. Those materials which are impervious and very smooth will tend to produce a shiny surface with a mottled appearance and result in a high probability of small blowholes occurring. If permitted, fine abrasion of the formwork face prior to use will tend to reduce the instances of blowholes and mottling of the concrete surface, but will produce a less shiny surface.

The default formed finish assumed for all work is Ordinary, as it is expected that usually concrete used for the frame will not be exposed when the building is finished. Finishes of higher quality may cost more but the costs may be offset if applied finishes are not then required. Guidance on specification is given so that all the concrete on a project can be covered in one specification and a separate 'architectural' specification is not needed.

Reference panels

Reference panels illustrating Ordinary and Plain finishes have been erected by CONSTRUCT at six regional locations around the UK. They are physical and visual benchmarks of structural concrete finishes enabling all concerned to agree on an acceptable standard both before and after the concrete is poured. The panels provide a true representation of site-formed finishes rather than laboratory made simulations.

Location and viewing arrangements of the panels are given on CONSTRUCT website www.construct.org.uk/surfacefinishes

8.6.1.1 Basic finish

A Basic finish is that normally applicable to such items as the sides of foundations and ground beams where no particular requirement is needed other than to ensure compliance with all other clauses of the specification such as concrete compaction and cover to reinforcement.

8.6.1.2 Ordinary finish

This is for use where visual quality is not important or it is to receive applied finishes. It is recommended that this finish is not used where surfaces are only to be painted. The use of small panel forming systems is considered suitable for producing this finish. Joints between formwork panels will show and the step may be up to 5 mm. Grain marks are generally due to slight absorbance variations causing local colour variation, but the surface is generally smooth. Panels and bolt holes may not be in a regular pattern. Colour of the finish will vary with the concrete delivered, the release agent used and reuse of the forming material. Project sample panels should not be specified for this finish. As the concrete finish is not important visually, making good is acceptable and so blowholes and minor surface blemishes can either be dealt with or accepted untreated by agreement between the CA and Constructor based on achieving an overall standard similar to the reference panels. If a system formwork is to be used e.g. Peri Trio/Duo, the finish off the formwork will generally be acceptable and the CA is expected to be aware of its quality.

8.6.1.3 Plain finish

A Plain finish is for use where visual quality is of some importance such as areas occasionally seen or to be directly painted. The use of sheet material to limit jointing in forming material is considered suitable for producing this finish. In any one visible elevation the sheets should be of the same type and have had the same number of previous uses. Joints between formwork panels will show and the step may be up to 3 mm. Tie-bolt holes should ideally be recessed, or alternatively filled flush, although this may not be so aesthetically pleasing. Panels and bolt holes should be in a regular pattern. Colour of the finish will change with concrete delivered and reuse of the forming material. A special project sample panel should not be specified for this finish, but a project example should be produced as one of the first areas of concrete poured on the project and used as the benchmark for the rest of the concrete.

8.6.1.4 Special finish

A Special finish should be specified in NSCS Project Specification for architectural formed finishes and when a worked finish is required. Sample panels will be required using the forming system and concrete to be used on the project for producing the particular finish. The size and complexity of the sample should be agreed to test the project detail and confirm that the execution can produce the finish on a repetitive basis.

Specification considerations for producing Special finishes:

- Required surface regularity must be achievable.
- Allowable colour variation of the surface based on generic colour of the concrete.
- Extent of acceptable blowholes. These depend on formwork type, concrete, release agent and compaction – some blowholes are inevitable.
- How much making good may be expected – some is inevitable.
- Arris type required.
- Use of cover spacers.
- Arrangement of formwork joints and tie holes (filled but ideally left recessed).
- Location of a 'sample' or similar finish.
- Special tolerances – must be achievable.
- Light reflectance.

The concrete quality of a Special finish is likely to be higher than that required just for structural performance and durability.

The following issues should be considered when producing a Special finish:

- **Early discussion and teamwork** between Architect, Engineer and the Constructor's, to ensure understanding of the project finish required. This may include using existing examples as a basis for discussion about what is required. These may be as examples of the Constructor's previous execution as well as the specifier's requirement; both these are useful at tender stage.
- **Particular care** in the choice of materials, for both formwork and concrete, good site care and satisfactory supervision of the work.
- **Site practice – formwork** Formwork should be protected from rainwater damage and standing water. Prefabricated panels should not be left flat on the ground after use, but stored upright and covered to prevent the top surfaces absorbing moisture and swelling. Sheets of ply shall be made into a rigid assembly that does not twist or warp when lifted nor cause individual sheets to bow or move out of alignment during erection.

When handling formwork do not allow any metal or hard objects to contact the form face and damage it. Unless otherwise agreed, all contact panels should be back fixed to avoid damaging, splitting or marking the contact face with nails, screws, hammers or sharp implements.

Formwork panels should be drilled and cut to length in a suitably protected workspace on site. All cut edges must be made with sharp saw blades and should be straight with no tear or damage to the panel edges. Cut edges should be sealed before assembling into the formwork.

When cleaning formwork use plastic-faced cleaning tools and wipe the surface with a cloth. Avoid scratching or indenting the surface with metal-faced tools or abrasive papers.

- **Site practice – concrete** The use of trials is strongly recommended where a particular appearance is envisaged.
- **Colour** The colour is dictated by the smallest particles in the concrete, that is mainly by the cement and to a lesser extent the sand. The coarse aggregate has little effect on the colour. Reference to previous projects is important in defining colour; a sample is of little use as the long term colour can take 1 to 2 years to appear.

The addition of ggbs makes the finish lighter (although it is often seen with an initial deep blue/green colour that normally fades in a few weeks), while fly ash makes it darker.

Very white concrete requires white cement, silver sand and sometimes white pigment. These are difficult to source in the UK and so are not a very sustainable choice. In addition this can cost substantially more than normal concrete as it will involve the supply plant cleaning out the mixer and supply bins to allow white concrete to be provided.

It is possible to produce a 'whitish' concrete using a high proportion of ggbs and suitable sand at a much reduced cost.
- **Materials** For ready-mixed concrete these will generally be dictated by what is available at the plant as any variation in materials is difficult to organize as it involves cleaning out supply hoppers. So if a concrete using particular materials has been identified as giving the colour needed the supplying plant may need to be specified, if this is contractually acceptable.

When the materials have been determined no changes must be made to the mix proportions or water/cement ratio. Even small changes in water content can alter the final colour. This means a single source of supply for the cement and sand. The cement content should be at least 350 kg/m³, and the water/cement ratio should not exceed 0.5. The sand should be well graded

and limited to approximately twice the weight of the cement. For a concrete using 20 mm maximum size aggregate, the proportion passing the 10 mm sieve size should be limited to approximately 20% of the total coarse aggregate. The concrete should have a default S3 slump consistence, using a water-reducing admixture if required, unless the placement method necessitates a different consistence.

- **Trial panels** These are best done full size in a location where any unacceptable finishes will not matter. They should include reinforcement, details of all the expected joints and features, and use the proposed methods for concrete placing, compacting, etc. to allow an assessment of the formwork quality, placing methods and other procedures. It is important to recognize that the colour produced will not be the final colour as it would have had insufficient time to dry and carbonate, so this should not be judged on the trial panel.
- **Concreting** This should take place as soon as possible after fixing the reinforcement to minimise the risk of rust stains from the rebar getting onto the shutters and then being absorbed into the finished concrete surface.

Concrete skips, chutes, pumps and conveyors and any other concrete handling plant should be cleaned and wetted before use.

Concrete should be placed in level layers not thicker than 500 mm before vibrating. Placing should be at a vertical rate of approximately 2 m/hour to avoid cold joints, but not excessively fast otherwise segregation or inadequate compaction can occur.

The poker size, its radius of influence and its location of insertion into the fresh concrete should be chosen to ensure the whole concrete cross-section is fully compacted. The poker must be used with care; in swiftly and out slowly should minimise the number of blowholes. Except for the first layer, poker work should start in the previous compacted layer. The poker should not touch the rebar or formwork, or be used to move the concrete into place.

The top 0.5–1 m of walls and columns should be re-vibrated as late as possible after the concrete is placed. This will reduce the increased incidence of blowholes in this top section. The timing of re-vibration will vary depending on the concrete used and the ambient conditions.

- **Post-concreting** The time to strike should be kept constant at about 24 to 36 hours (be careful if pouring on a Saturday), to minimize the risk of discolouration from the release agent or formwork. Consistency in striking time also keeps the colour consistent.

Formwork left in place for a significant time (e.g. soffit formwork) will tend to produce an initial dark colouring due to the extended curing time and lack of exposure to the environment.

A water-repellant treatment, post-applied or incorporated in the mix, helps to keep the surface dirt free, particularly in the first few years of service.

Projecting rebar should be covered or coated with cement mortar to prevent rust streaks running down the concrete face.

Making good is best avoided as it can make things worse! However, it is likely that some making good will be necessary. When carrying out this work ensure a trial is done where it cannot be seen. The surface needs to be repaired with a mortar matching as close as possible the colour of the parent concrete.

Further guidance can be obtained from the following publications:

- Appearance Matters series published by BCA, Wexham Springs:
 1. *Visual concrete: design and production*, 1988 (Ref: 47.101)
 2. *External rendering*, 1992 (Ref: 47.102)
 3. *The control of blemishes in concrete*, 1981 (Ref: 47.103)

4. *Efflorescence on concrete surfaces*, 1982 (Ref: 47.104)
5. *Removal of stains and growths from concrete*, 1982 (Ref: 47.105)
6. *The weathering of concrete buildings*, 1986 (Ref: 47.106)
7. *Textured and profiled concrete finishes*, 1986 (Ref: 47.107)
8. *Exposed aggregate concrete finishes*, 1985 (Ref: 47.108)
9. *Tooled concrete finishes*, 1985 (Ref: 47.109)

This series is out of print. The Concrete Society has developed a new four-part series based on it, which is due in 2010. Until then the original titles are available from IHS or similar.

- Dawson S. *Cast in concrete – a guide to the design of precast concrete and reconstructed stone*. Architectural Cladding Association, Leicester, 2003.
- The Concrete Society and CONSTRUCT. *Plain formed concrete finishes*. Technical Report 52. The Concrete Society, 1999.

8.6.2 Unformed finishes

It is important not to 'over-specify' the quality of finish, particularly where it is covered up by following work; but whatever finish is specified, the concrete must be fully compacted.

The default formed finish assumed for all work is Basic. Finishes of higher quality will usually cost more but the costs may be offset if applied finishes are not then required. Where a raised access floor is to be used the manufacturer should be consulted about the finish that should be specified. A Basic finish may be fine for deep floors supported on individual legs that are shimmed into place but for shallow floors an Ordinary finish, or better may be needed. Consideration of the finish specified should take account of the type of use as services such as pipes or cables laid on slabs could be damaged if they are pulled over a rough surface.

Where finishes to precast beams and slabs are required to allow in-situ concrete to act compositely, these areas should be clearly identified and described.

Where surface finishes to concrete are required to be smooth and level to provide bearings for precast slabs or beams, these areas should also be clearly identified and described.

8.6.2.1 Basic

This is normally applicable for areas to receive a levelling or wearing screed. A closed finish is produced by levelling, and use of a skip float or similar process. Float marks and ridges will occur. No further work is required.

8.6.2.2 Ordinary

This is for use in areas to receive flooring materials, types of false floor or other raised finish. It may not be suitable for thin vinyl flooring without grinding or a underlayment. If thin vinyl with minimum additional work is required, a Plain finish should be specified. This is a level uniform surface produced typically by hand or power floating but not by skip float or similar process. The finish is to be free from ridges but fine float marks are to be expected. This may be acceptable for the application of finishes such as tiles or carpet.

8.6.2.3 Plain

This is for use in areas without any other finish other than paint or surface coatings, and provides a dense smooth surface typically produced by hand or power trowelling. This may be suitable for directly trafficked surfaces – see BS 8204: *Screeds, bases and in-situ flooring*.

8.6.2.4 Special

This is for industrial floors, areas of special trafficking or areas requiring a specific texture (e.g. tamped or brushed), and can be produced by further working other finishes. This is a finish where special requirements have to be given in NSCS Project Specification.

Where power finishing is not practically possible or not permitted due to working time restrictions, there is a risk of reinforcement ripple occurring if using a skip float. A thin bonded smoothing compound may be necessary in the situation where a smooth wearing surface is required, or an underlayment can be used where a thin flooring material is to be laid.

Where the element is to provide a smooth wearing surface or to receive directly applied flooring without the need for a levelling screed, the regularity should comply with the requirements of BS 8204–2 or Concrete Society publication TR34 *Concrete Industrial ground floors – A guide to their design and construction* (3rd edition).

Section 9 Precast concrete

9.1 General

This section includes requirements for all precast construction including prestressed.

All clauses in the NSCS Standard Specification apply to in-situ and precast concrete where appropriate. It should be remembered that this standard specification does not apply to manufactured units which are made to designated standards and product standards, and are treated as items imported for the execution of the project.

Precast concrete may be incorporated in hybrid concrete structures, where reinforced precast or precast prestressed units act compositely with added in-situ concrete. The requirements for the manufacture and erection of the units (but not for proprietary precast prestressed floor units) are covered in this section of NSCS.

Care should be taken with regard to geometrical tolerances of precast elements in hybrid construction to ensure that any tolerance in the elements is compatible with the tolerances allowed in the in-situ work given in section 10 of NSCS Standard Specification. *The Concrete element book – volume F, Tolerances*, by the Norwegian Precast Concrete Federation, obtainable in English from British Precast, gives general tolerances for precast elements.

It is recognised that precast concrete presents its own particular considerations such as size of elements, handling, storage, stability, installation, connections, etc. These need to be the subject of consideration by the Constructor in advance of the start of construction as part of the detailed construction planning.

Precast concrete may be procured in different ways depending on the requirements of the project:

- Proprietary precast products such as floor units or staircases which are generally designed by the manufacturer and which are selected by the Engineer to meet limited performance criteria (load/span capacity, durability, fire resistance).
- Special precast units designed by the Engineer.
- Units designed by the Manufacturer to meet given performance requirements. These requirements will be more extensive than the first category described above.

For each of the above, details of lifting inserts, the demoulding process and the on-site erection need to be addressed.

Clear responsibility for erection, making good and protection for precast units also needs to be made clear to the supplier or manufacturer, i.e. is the contract supply only, supply and fix, or more demanding.

Further information on these can be found in relevant codes of practice available from British Precast. These are *Safe erection of precast concrete frameworks* (Structural Precast Association, 1999), *Safe erection of precast concrete cladding* (Architectural Cladding Association, 1998) and *Safe erection of precast concrete flooring* (Precast Flooring Federation, 2007).

Sustainable construction

Information regarding the status of the precast sustainability scheme can be found through the British Precast website.

The project specific nature of sustainability requirements for precast elements needs to be properly researched and requirements included in NSCS Project Specification.

9.1.1 to 9.1.4

9.2 Precast concrete products

| Published BS EN standards for precast concrete products | |
|---|---|
| Standard | Title |
| BS EN 1168: 2005 | Hollow core slabs |
| BS EN 12794: 2005 | Foundation piles |
| BS EN 12843: 2004 | Masts and poles |
| BS EN 13224: 2004 | Ribbed floor elements |
| BS EN 13225: 2004 | Linear structural elements |
| BS EN 13369: 2004 | Common rules for precast concrete products |
| BS EN 13693: 2004 | Special roof elements |
| BS EN 13747: 2005 | Floor plates for floor elements |
| BS EN 13978-1: 2005 | Precast concrete garages |
| BS EN 14650: 2005 | General rules for factory production control of metallic fibered concrete |
| BS EN 14843: 2007 | Stairs |
| BS EN 14844: 2006 | Box culverts |
| BS EN 14991: 2007 | Foundation elements |
| BS EN 14992: 2007 | Wall elements |
| BS EN 15050: 2007 | Bridge elements |

These show the information that should be provided on the documents sent to site with each precast product.

9.3 to 9.5

9.6 Jointing

9.6.1 General

As jointing of precast elements can vary in size and material as well as stability during erection, it is recommended that the design requirements are shown on the erection drawings. Where no

details are given, the Constructor should agree the jointing system to be used with the CA. Details of non-proprietary methods are given below. The Engineer who has overall responsibility for the stability of the structure should check that the jointing of precast elements is compatible with the requirements for overall stability. Special care is required at details where dimensions are likely to be critical for the satisfactory performance of the design such as at movement joints or to allow for the additional deviations arising from the selected construction techniques.

Mortar bedding Where required, mortar for bedding precast components should be made of cement, sand and water in the proportions, by volume, of:

- 1 part of Portland cement to BS EN 197-1
- 2 parts of grade 0/4 CP sand to BS EN 12620.

The quantity of water required to achieve a mix suitable for the jointing details shown on the drawings shall be determined by the Contractor. No other ingredients should be added without approval.

Dry pack Mortar designated as dry-packed shall be of such a consistency that it can be properly compacted by ramming.

Concrete/grout infill Thoroughly clean and wet surfaces of precast components, place concrete or grout, avoiding segregation, and compact thoroughly to eliminate voids. Ensure that precast components do not move until concrete or grout has gained sufficient strength.

Composite construction Thoroughly clean and wet surfaces of precast components. Place, compact and cure in-situ concrete. Ensure that precast components do not move until concrete has gained sufficient strength.

Section 10 Geometric tolerances

10.1 General

To arrive at optimum cost and buildability, a common understanding of the tolerances to be achieved on a project for the structure, cladding, finishes and their fit together should be shared by all parties. Existing guidance on tolerances is available from a number of sources including BS 5606: *Guide to accuracy in building*. However, many Specifiers who have previously referred to this document in their specifications have found it difficult to follow and not always appropriate. The necessary calculations required to assess the combined deviation limits is complex, especially in situations where dimensions are likely to be critical and/or the construction takes place in phases across several reference grids, each introducing additional deviation to the closing dimensions.

The tolerances given in NSCS encompass those given in the body of BS EN 13670: 2009, Section 10 and Annex G. They give practical values, without premium costs for fit, for a basic concrete frame building, that are tighter than the requirements for structural safety assumed within design to Eurocode 2. The scope of tolerances in BS EN 13670 is repeated in this specification, whether revised numerical deviations have been specified or not, so as to make a readable specification without referral to BS EN 13670.

As in BS EN 13670, the tolerances given in Section 10 of the NSCS are generally twice the deviation given, as the deviation is given as both plus and minus numbers, except where separate plus or minus numbers are given.

10.1.1 Precedence

The hierarchy of the tolerances is such that each level 'fits' inside the higher level. The first level covers the overall position of the building and its tolerance. The second level, covering the overall tolerance of each element, must fit within the tolerances of the first level. Similarly level 3, section of elements, fits within tolerances for elements in the second level; and level 4 tolerances fit within the level 3 element section tolerance.

Consideration must be given to the type of cladding/finishes and their required tolerance compared with those specified in NSCS Standard Specification Section 10. It may well be that deviations in Section 10 will need to be smaller to cater for the cladding and finishes; see Cl. 10.5.1 of this Guidance. However, to have tighter tolerances on the cladding and finishes and/or provision of greater adjustment in their fixings may be more sensible. The best philosophy is one of loose fit.

Discussion is needed at the design stage on any tighter tolerances envisaged, since they are likely to result in higher execution costs and may not, in any event, be realistic. Common sense must prevail should any item fail to meet the tolerance specified. It is important to consider whether the work is still acceptable, having regard to the operations that follow and the intended use of the structure. BS EN 13670: 2009, Cl. 4.4 'Action in the event of a non-conformity' is designed to aid suitable action.

Individual tolerances are not cumulative, and the plan position of any element must lie within the overall tolerance for the structure given in Cl.10.2; this is sometimes referred to as the 'box' principle. The problem with tolerances is that it is not always possible to satisfy all of the tolerances given at the same time. Figure 10.2.1 in Cl. 10.2 of this Guidance indicates in more detail how the tolerances given allow corrective action to deal with potential out of 'box' tolerance. The figure also shows some situations where information will be needed in NSCS Project Specification to make clear which tolerance will govern in a particular situation.

Checking of position and dimensions of the structure must be carried out as construction proceeds and reported to the CA as a non-conformity. This enables corrective action to maintain the overall tolerances can be planned and any remedial work required for any out-of-tolerance elements can be sensibly planned and executed.

10.1.2 & 10.1.3 Tolerance and Execution classes

This specification gives tolerance class 1 as achieving the design assumption of BS EN 1992 as given in the Note to BS EN 13670: 2009, Cl. 10.1(2). If smaller deviations are required they are considered Class 2. If Class 2 is specified, with permitted deviations given in NSCS Project Specification for any element or structure in the particular project, the inspection for those elements or structures is specified to be execution Class 3 (see BS EN 13670: 2009, Cl. 4.3.1).

Class 2 tolerance should be agreed for specialist execution such as slip-formed cores.

The fit of abutting elements with different permitted tolerances requires careful consideration.

10.1.4 Measurement

All tolerances given are for the period that is after pouring and before striking. The Constructor cannot be responsible for deflection which is an integral result of the design and agreed striking times.

Tolerance for pre-camber is not given in the specification as it is dependent on formwork system, concrete used and the striking time of the falsework and formwork. Where pre-camber is required it should be agreed before construction starts and considered together with the age/strength of

concrete before striking. The specification for pre-camber must allow for the fact that the pre-camber may not all drop out.

10.1.5 Reference grids

The setting out of the structure from the primary lines and levels by means of secondary lines is usually the responsibility of the Constructor. The accuracy of secondary lines may have to be taken into account in large structures, but this is a project decision.

10.1.6 Box principle

The detailed guidance to Cl. 10.2.1 & 10.2.2 illustrates how the 'box principle' is to be applied in coordinating the overall building tolerances and individual column location, floor level offset and plumb tolerances. The detailed guidance to Cl. 10.5.1 shows how applying the 'box principle' to the tolerances for position on plan, squareness and cross-section of an element, limits the twist of an element.

The box principle is another way of describing the hierarchy system explained in Cl. 10.1.1 of this Guidance. The name comes about as each level of hierarchy fits with the 'box' of the higher level i.e. overall elements of the second level fit within the 'box' of the first level.

10.2 Overall structure

The given tolerances are intended for normal structures. Tolerances for taller buildings, say over 30 m or 8 floors, should be agreed before construction commences.

It may be convenient to restart the tolerance base after transfer slabs in very tall buildings or above deep basements.

10.2.1 & 10.2.2 Inclination and Level

The given tolerances set out the overall building tolerance. These are the first order of tolerance for the structure and all elements must fit within their prescribed envelope or 'box'. Individual elements of the structure are allowed individual tolerance (location see Cl. 10.4 and 10.5 of NSCS Standard Specification; and size see Cl. 10.6, 10.7 and 10.8 of NSCS Standard Specification) but individual element tolerance may be limited to ensure the element is not taken outside the 'box'. As the tolerances are dependent on storey height and element size the acceptable values for tolerance are specific to the dimensions of the project. The example shown in Figure 10.2.1 illustrates the standard acceptable deviation and application of the 'box' principle for a project. The deviation for inclination applies to the plane on both the x and y axis of the intended position. It should be noted that the maximum deviation diagonally of the centre and corner of an element can be $\sqrt{2} \Delta$, although there is a low probability of both x and y axis deviations being at maximum at the same place. This diagonal deviation is usually limited by hierarchy considerations (see NSCS Standard Specification, Cl. 10.1.1).

Figure 10.2.1 illustrates the 'box' principle applicable to column centrelines from foundation to upper floors.

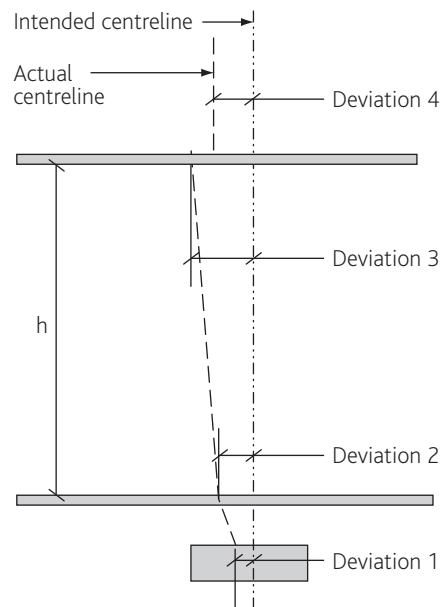

Typical storey

Deviations 2, 3 & 4 are governed by the 'box' principle and are less than 50 mm as BS EN 13670: 2009, Cl. 10.1.(5)

Deviation 3 less deviation 2 must be less than 15 mm or $h/400$ (Cl.10.5.2 of NSCS Standard Specification)

Deviation 4 less deviation 3 must be less than 10 mm or $t/30$ (Cl. 10.5.3. of NSCS Standard Specification) This is a 'corrective tolerance' to ensure that:

Deviation 4 less deviation 2 is less than 10 mm (Cl.10.5.1 of NSCS Standard Specification)

Bottom storey – special case

Deviation 2 must be less than 10 mm from the intended Design position (Cl. 10.5.1 of NSCS Standard Specification)

Deviation 1 for the base (substructure), not the superstructure, must be less than 25 mm from the intended design position (Cl. 10.3.1 of NSCS Standard Specification)

In a multi-storey structure the columns can therefore only deviate over 10 mm/storey in complying with Cl.10.5.1 of NSCS Standard Specification, although there is greater verticality tolerance. Any 'drift' in one direction will be limited by the need to satisfy the requirements of Cl.10.2.1 of NSCS Standard Specification.

Note

There are two situations where mutually compliant tolerances may cause a problem and they must be defined in NSCS Project Specification.

- 1** Where a combination of column height and thickness allows the tolerance for verticality from Cl. 10.5.2 of NSCS Standard Specification and offset from Cl. 10.5.3 prevents the tolerance for position in Cl. 10.5.1 being achieved.
- 2** Where a combination of column height and thickness and verticality of adjacent columns have divergent tolerances from Cl. 10.5.2 of NSCS Standard Specification would prevent the distance between columns at the top in Cl. 10.5.6 being achieved.

Figure 10.2.1
Column compliant with
mutually satisfied tolerances

10.2.1 Inclination

Lift shaft tolerances require careful consideration and agreement between Designer, Contractor and lift supplier. This applies to all buildings, particularly tall buildings where alterations to the lift are more difficult.

In NSCS lift shafts inclination tolerance is considered to be covered by Order 1 tolerance (Cl.10.2.1 in NSCS Standard Specification) not exceeding 50 mm. The element tolerance would depend on the construction method adopted – jump form, slip form or floor height wall stages. However, guidance on lift shaft construction and tolerances is given in BS 5655–6: 2002: *Lifts and service lifts – Code of practice for the selection and installation of new lifts*; lift shafts require a minimum plumb dimension and a positive only tolerance. The first issue is therefore to set the nominal dimension for the shaft greater than the required minimum plumb. The tolerance on the lift shaft can then only be ± 25 mm to comply with BS 5655, so if there has been no other agreement, tighter tolerances than those in the NSCS will be needed for lift shafts.

10.3 Base support (foundations)

10.3.1 Plan section

The foundations tolerances given are for individual bases and ground beams for concrete and steel framed structures.

Care should be taken with trench fill foundations where the centre line is used for determining deviation. When considering section of elements, larger permissible deviations are advisable than those in NSCS Standard Specification Cl. 10.7.

10.3.2 Vertical section

Two values are given for this tolerance as one is fixed to coordinate with BS 1090. Particular attention is drawn to the need to specify adequate thickness of any grout bed beneath follow-on items such as steel base plates, and also projection lengths of cast-in anchor bolts. This is required as the tolerances in the top level of foundations and bolt projections affect the achieved thickness of grout bed.

10.4

10.5 Elements – columns and walls

10.5.1 Position on plan

The location of the 'kickers' is, in practice, the commencement of the execution of a floor and the control of deviation at this level is essential. It is recommended that the centre lines are used for control as this will prevent cumulative errors leading to unacceptable deviation. Care should be taken when cladding or other components have to fit between columns or walls, although tolerances are not cumulative (see NSCS Standard Specification Cl. 10.1), therefore the maximum deviation in the 'fit' dimension is +20 mm, whether caused by position or cross-section deviations.

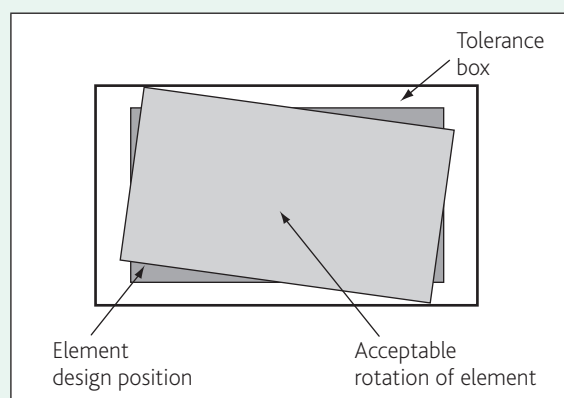

Figure 10.5.1
Rotational tolerance

The tolerance for rotation or twist of an element has not been given as an individual tolerance as it will be limited by the tolerances given for position on plan, squareness, and cross-section of an element. The relevant tolerances depend on the element considered and are given in NSCS Standard Specification Cl. 10.5.1, 10.7.1 and 10.7.2. They provide an envelope or 'box' within which the rotation of an element is acceptable. The effect of this is illustrated in Figure 10.5.1. This rotation tolerance of elements is sometimes referred to as square tolerance to design and is of importance when, for instance, partitions align with a row of columns or walls.

10.5.2 & 10.5.3 Verticality by storey of the structure and offset between floors

These deviations are a limit for safety of the structure and are likely to be limited by other overall tolerance limitations, even for large columns. It allows positional correction when elements have not been cast vertically. It is recommended that the deviation of the verticality of an element be corrected over several floors rather than by an abrupt offset between floors – this will limit difficulties with cladding or other components.

10.5.4 to 10.5.6

10.6 Elements – beams and slabs**10.6.1 Location of beam to column connection**

Care should be taken when beams are supporting precast units that have been manufactured to different tolerances than those required for members cast to NSCS Standard Specification Cl. 10.5.6 in this specification. The required bearing of precast units must also be considered relative to the width of a beam (see NSCS Standard Specification Cl. 10.6.2) and the deviation of the distance between beams i.e. distance between bearings. This may require smaller deviation of the distance between beams.

10.6.2 to 10.6.6

10.6.7 Position of slab edge

While this is listed as a deviation of the floor slab element, i.e. a third order deviation, it can become a second order deviation where the floor edge and/or attached beam form the position of the structure's edge.

10.7 Section of elements**10.7.1 Cross-section dimension of elements**

This clause covers cross-section, length and height of elements. It is particularly important to control the thickness of thin slabs since this is likely to be critical for strength, fire resistance and deflection. It is recommended that special tolerances, Class 2 to be given in NSCS Project Specification, be considered for slabs up to 200 mm thick.

The tolerances for precast elements may be produced to the relevant precast product standard such as BS EN 14843: *Precast concrete products – Stairs* for stairs and these should be checked to prevent conflict.

Particular consideration should be given to slab thickness in the construction of composite concrete/ steel decking suspended slabs when not using constant thickness construction as the specified deviations are very unlikely to be met. See ACIFC and Concrete Society publication, *Composite concrete slabs on steel decking – Guidance on construction and associated design considerations* (2007).

For ground-bearing slabs, particularly for industrial or warehouse use, it may be more appropriate to refer to Concrete Society publication TR34, *Concrete industrial ground floors – A guide to their design and construction* (Concrete Society, 2003) and to *Concrete ground floor slabs: thickness tolerances* (Simpson, D, in *Concrete*, Vol. 34, February 2000, pp 22–23).

10.7.2 Squareness of element

This clause should be used for squareness and skew. It covers orthogonality of elements i.e. when a corner is not cast to the specified shape such as 90°. This squareness of an element can have a

similar effect as rotation or twist of an element, see NSCS Standard Specification, Cl. 10.5.1 above and can cause misalignment of adjacent elements.

10.8 Position of reinforcement within elements

10.8.1 Location of reinforcement

It can be seen from the deviations that the plus deviation varies with the size of the element as the effective depth varies. The minus deviation is given as constant as this affects durability and fire resistance of the element whatever its size. Minus deviation is given at 10 mm which matches c_{dev} as given in the National Annex to BS EN 1992-1-1: 2004, Cl. 4.4.3 (1) P. Provided the specified tolerance is achieved, the actual cover achieved, which is the nominal cover given on the drawings, will therefore be greater than or equal to the required design minimum cover.

The cover that is shown on the drawings is the nominal cover c_{nom} . It has therefore to be remembered that the minimum cover c_{min} may be 10 mm less than that shown on the drawings. This is particularly important in severe exposure conditions and with thin slabs.

Where a lesser c_{dev} has been used by the Designer it is essential that the equivalent minus deviation Δ_{minus} is specified to the Constructor in Part 2 as a given nominal cover c_{nom} on the drawings will not indicate any change in the tolerance.

If the minus deviation Δ_{minus} is required to be smaller than 10 mm this will constitute a Class 2 tolerance and must be detailed in NSCS Project Specification. It will require special inspection and will increase the cost of construction. If a statistical approach allowing a certain percentage of values with cover less than c_{min} is allowed it should be stated in NSCS Project Specification.

The NSCS standard tolerance for the location of reinforcement Δc_{dev} is 10 mm. The Institution of Structural Engineers publication *Standard method of detailing structural concrete – A manual for best practice* suggests that when use of a SpeCC Registered Contractor is specified that Δc_{dev} could be reduced to 5 mm. It is recommended that this reduction in tolerance should only be permitted if records from the Contractor's quality system show that this level of accuracy in fixing the reinforcement is being achieved on site.

10.8.2

10.8.3 Location of reinforcement and ducts in prestressed elements

Tendons should not be allowed to snake many times from one side of the tolerance envelope to the other side along their length.

In narrow ribs, a tighter horizontal deviation than ± 30 mm may be applicable. In beams and ribs, tendons should not be allowed to wander as a group from one side of the tolerance envelope to the other, as this may generate unwelcome lateral effects.

If it is necessary to position a tendon outside the tolerance envelope this should be agreed with the CA and recorded on the as-built drawings. Such unexpected deviation is sometimes necessary around service openings and where column reinforcement is particularly congested.

It is important for the provision for future fixings, openings, etc. that the position of the tendon is known and these should be marked on the soffit. This information will also be important for the Health and Safety file.

10.9 Surface straightness

10.9.1 Flatness

The question of flatness is required for consideration of finishes to structures, as level, slope etc. for structural safety is covered by element tolerances.

It should be noted that the tolerances given apply to vertical as well as horizontal surfaces.

The 'local use' straight edge should be used in determining what, in previous editions of NSCS, was called 'abrupt changes of surface'. Local or abrupt deviations will depend on the finish specified for the element.

The specifier should consider the requirement of any following finish when deciding on the flatness tolerance for slabs. BS 8204 Parts 1 to 6: *Screeds, bases and in situ flooring* provides a useful guide.

When measuring deviations, it is recommended that the influence of local roughness (e.g. due to tamped finish) should be averaged out to give a representation of the overall deviation. If smaller tolerances are required for worked finishes these must be stated in NSCS Project Specification and should align with the surface regularity classes given in BS 8204 Part 1 *Screeds, bases and in situ floorings. Concrete bases and cementitious levelling screeds to receive floorings – Code of practice*.

When constructing composite concrete/steel decking suspended slabs, particular consideration should be given to specifying slab flatness. The specified deviations are very unlikely to be met without excessive deviation in floor thickness. See ACIFC and Concrete Society publication *Composite concrete slabs on steel decking – Guidance on construction and associated design considerations*. Good Concrete Guide 5, 2008.

The tolerances specified for formed finishes of an abrupt change in level of 5 mm for Ordinary and 3 mm for Plain finishes are consistent with the reference panels described in NSCS Standard Specification Cl. 8.6 and Guidance Section 8. These step values reflect deviations allowed in the NBS specification. Surfaces that for aesthetic or other reasons require a much tighter tolerance must be specified in NSCS Project Specification.

10.9.2 Edge straightness

The tolerance in straightness is to allow for the fit of cladding or finish to the structure, as curvature and bow for structural safety is covered by element tolerances.

The tolerances can be applied to any edge of the structure, whether floor, beam or wall. In order to limit difficulties with cladding or other components, it is recommended that any deviation of edge straightness be corrected smoothly and not abruptly. The tolerance for straightness should be considered when proposing Class 2 tolerances.

10.10 Holes and fixings

10.10.1 Holes

In many ways holes can be considered as elements and the deviations given are the same as for the section of elements (see NSCS Standard Specification Cl. 10.7.1). It is also reasonable to expect the squareness of holes to be the same as for elements, NSCS Standard Specification Cl. 10.7.2. Also the verticality of holes between floors are to be as NSCS Standard Specification Cl. 10.5.2 and 10.5.3 for columns and walls.

10.10.2 & 10.10.3

10.11 Staircases

Traditionally, tolerances on stairs are different from, and conflict with, those specified for other parts of structures. The NSCS method of specifying deviations has the benefit of removing this conflict as the stair flight is considered to be one element. The sole particular requirement is that risers and goings should each be even throughout each section of the stair. The overall tolerance between floor levels will fix the total rise of a stair.

10.12 Precast concrete elements

Care should be taken to ensure that the tolerance in individual standards and product standards used in the manufacture and placing of precast elements are compatible with the tolerances specified for the structure.

Where individual elements are assembled off site to form a sub-assembly for the structure, the individual elements will need to be constructed to smaller tolerances to enable the completed sub-assembly to meet the tolerance of the basic structure.

10.12.1 & 10.12.2

NSCS Project specification

General

The specific project specification must ensure that the Constructor is given all the execution information required by BS EN 13670. Some of this information is given as standard in NSCS Standard Specification; the remainder is project specific and NSCS Project Specification prompts the specifier to make clear the project requirements. If all the NSCS Project Specification clauses are completed all the information required by BS EN 13670 will have been provided. The list of information required by BS EN 13670 and where it fits in the NSCS Standard Specification is given in NSCS Guidance Section 4.

NSCS Project Specification is in two sections: Section P1 contains information that is to be supplied to the Constructor; while Section P2 contains information that is to be supplied by the Constructor. It is realised that this information may be supplied at different times, depending on the stage of the project (e.g. at tender, during the contract, or following completion) and thus the information is presented as a list rather than in chronological format; although the timing required for the release of some of the information is defined in NSCS Project Specification Cl. P1.3, P1.4.2, P1.4.3, P1.10 & P2.4.

The Constructor is encouraged to make suggestions that may enhance the project.

Section P1 Information to be supplied TO the Constructor

This section highlights items of which the Constructor should be aware when tendering. Knowledge of this information by the Constructor can help to avoid financial difficulties developing and claims arising.

The layout has been adopted for simplicity and ease of use. Further requirements should be added and appended in NSCS Project Specification as required for the project. If certain clauses in NSCS Standard Specification are not applicable they should be listed as 'not applicable' in NSCS Project Specification to clearly indicate they have not been overlooked. If there seems to be no obvious place to record this information, Cl. P1.13 or P2.9 from NSCS Project Specification may be used. If information for the Constructor is to follow later, the date when it will be available should be given.

It is important not to make changes to the specification unless they are necessary for the project.

P1.1 General information

P1.1.1 Project contacts

The list identifies individuals or companies who will be involved during the construction of the structure.

Owing to the variable nature of contracts, the CA may be from one of various organisations associated with the works. Whoever the CA is, the individual or organisation must obtain agreement from the Engineer on certain matters so as to ensure compliance with the Engineer's design.

P1.1.2 Description of the project works

A general description of the building (e.g. office, warehouse, industrial, residential, retail) should be stated so as to give basic information only of the type and extent of the works. This information

is expected to be read with NSCS Standard Specification Cl. P1.2. It will include the framing system, the means of achieving stability in the permanent condition and any special temporary requirements for stability during construction. If any precast elements are expected to act as diaphragms or act compositely in the structure, then this must be clearly stated.

If more description is required, such as information related to extending existing buildings or detailed construction sequence information, then appended information should be referred to.

Details are intended to give information on the location and type of site, e.g. green field, inner city, sloping, confined.

P1.1.3 Construction planning requirements

Some of information given in Cl. P1.1.3 of NSCS Project Specification may duplicate contractual requirements and it is important that the specification is coordinated with the contract. It may therefore be best that some of this section is completed by the statement 'refer to contract clause...'. The intention of the duplication is to ensure that all the information needed for planning the work is available in one place.

P1.2 Design

All loading that the structure will be required to support in addition to its self-weight must be stated. This will include such items as finishes, mechanical and electrical services, lifts and their dynamic effects, and cladding. Abnormal fatigue, thermal and impact effects and other effects from supplied items, which may induce stresses or strains in the structure, should also be stated. Any effects in connection with precast items (e.g. shrinkage and creep) should also be considered.

The list may need to be expanded to cater for all types of loading that may occur on any project; alternatively the Engineer can append any extra information, clearly and concisely in NSCS Standard Specification Cl. P1.13.

Irrespective of the type of contract or whether the Employer's Engineer or the Constructor's Engineer is responsible for the structural design of the structure, the information in this section remains equally important to the Constructor.

If the Employer's Engineer is responsible for the structural design, the Constructor still needs to know this information for his backpropping, construction loads, temporary stability systems, etc.

If precast elements rely on structural toppings this must be clearly stated. The importance of the effects of prestressed elements on the structure should be identified (e.g. short-term and long-term shortening, cambers and deflections of members).

P1.2.1 General

This space allows for the Engineer or CA completing the Specification to insert any specific design information not covered in the other sub-clauses; if there is no additional information, insert 'none'.

P1.2.2 to P1.2.4

P1.3 Drawings and calculations

It is important to make clear to all parties the responsibilities for the design of each element and this is the intention of the table in Cl. P1.3 of NSCS Project Specification. This is particularly critical

at the interface of elements designed by the Engineer and the Constructor. Ideally all parties should meet and clarify in writing their respective responsibilities. In any event the Engineer remains responsible for the overall stability of the structure.

For guidance on the expected content of information in this table see NSCS Standard Specification Cl. 3.4.

The table in Cl. P1.3 of NSCS Project Specification is intended to be used to indicate the flow of information on a project for a variety of procurement routes. These include, but are not limited, to:

- Full design by the CA with no design input from the Constructor.
- Design by the CA including detailing of in-situ work but with specialist design by the Constructor for precast or prestressed components.
- Design by the CA with the Constructor detailing the in-situ work and designing the precast or prestressed components.
- Full design by the Constructor.

For any project it is expected that the number of drawings and timings would be reviewed; however, the defaults will apply if no values are entered.

Builders' work information should provide coordinated information related to all holes for services, recesses, cast-in inserts, etc. It is common for the Engineers drawings to indicate holes and openings larger than 150 mm square. Holes smaller than 150 mm are then coordinated between the Constructor and the CA. These are essential to ensure follow-on trades need to provide only a minimum of holes and fixing drilled into the concrete.

Builders' work drawings, or the information needed to produce them, must be provided to the Constructor as early as practicable if construction on site is to be right first time. The holes and fixing inserts needed may be shown on a wide range of drawings including the GA, mechanical and electrical sub-contractor's drawings, and specialists' drawings for windows, cladding, fixings, etc.

Early in the project, the CA and Constructor need to agree who will produce and coordinate these drawings. Cl. P1.3 of NSCS Project Specification can identify who produces these coordinated drawings. It is important that enough time is allocated to the production and review of these drawings so that any potential clashes can be designed or detailed out. It can cause huge frustration on site if a pour has to be delayed because there is a clash between the requirements for different cast-in items.

Coordinated builders' work drawings The table should be used at tender stage to make clear who is producing these drawings.

As-built drawings The table should be used at tender stage to make clear who is producing these drawings. It is expected that these will form part of the Health and Safety File under the CDM Regulations.

Reinforcement detailing

The NSCS has been produced in a format to allow flexibility for the Engineer, if desired, to recommend to the client that the Constructor, when appropriate, prepares detailed design and/or reinforcement detail drawings and schedules; this complements the provisions of the Association of Consulting Engineers Conditions of Engagement.

A report by the Production Engineering Group of the University of Reading recommended in 1995 that reinforcement detailing should be undertaken by the trade contractor to maximise construction efficiency, and this way of working has been common practice in North America, the Far East and many other countries. Many UK consultants working on overseas projects are already familiar with this method.

The CONSTRUCT publication *A guide to contractor detailing of reinforcement in concrete* (1997), contains advice to Engineers on providing information to the trade contractor to enable clear understanding of the Engineer's requirements for Contractor detailing. This document is out of date and its suggested project specification requirements are generally included within the NSCS.

Where Contractor detailing is used the Design Information Drawings should provide, sometimes in electronic format, the following information: comprehensive typical details, simplified detailing instructions, in some cases non-standard project-specific details, requirements for reinforcement ductility grade, requirements for minimum reinforcement design lap lengths, the minimum design cover for each concrete element, requirements for detailing around holes, and any key design requirements for dealing with clashes should these occur.

A programme for the issue and review of information between the Constructor and the CA, in practice generally the Engineer, must be agreed – using table P1.3 in the NSCS Project Specification.

Where the Constructor prepares the reinforcement detail drawings there is opportunity for them to choose between precast or in-situ concrete for certain elements such as ground beams, and to explore the economics of rationalising reinforcement bar sizes and length, etc. The cost of increasing the amount of reinforcement in order to simplify construction may be small compared with the gain in speed of repetition, fabrication and installation.

When the Engineer prepares the reinforcement details and schedules early liaison and collaboration with the Constructor is essential to ensure that the details, whenever possible, suit the Contractors' requirements for items such as punching shear reinforcement systems and any preferred bar lengths.

The standard of detailing and level of checking required by the CA must be agreed; the Constructor's own QA procedures should provide all that is required for the schedules, apart from possible spot checks. To ensure compliance with the structural design, the Engineer should review and be satisfied with the reinforcement detail drawings before construction starts. Changes are to be dealt with as specified in Cl. 4.2.4.1 of the NSCS Standard Specification.

Drawings supplied to the Constructor may include the architect's and other design-team members and specialist's drawings, where needed to provide the Constructor with sufficient information to produce dimensioned outline drawings and the necessary reinforcement detail drawings illustrating reinforcement positioning.

P1.4 Execution management

This section clarifies the specific extent of management, records or supervision required for the project. It is important that each section is completed, even if the requirement is 'none' as may be the case for a typical frame where making any special additions is likely to increase the cost but with little benefit.

P1.4.1 to P1.4.4

P1.4.5 Documents

The requirements for responsible sourcing of products and materials will require the provision of documentation from the material supply chain.

Recommended responsible sourcing clause/information required:

Either

Provide an undertaking and evidence from the concrete supplier that the supplier has, or can provide evidence that they are working towards, accreditation to a UKAS certified EMS such as BS EN ISO 14001, EMAS and for SMEs, BS 8555 or equivalent.

Or

Concrete supply shall be certified against BRE BES 6001 *Responsible sourcing of construction products – Framework standard for the responsible sourcing of construction products* (Young, 2009) or other scheme to BS 8902.

The first option is a lower level of specification as it will cover environmental management only; it should be achievable in most of the UK. Organisations who cannot meet the requirement for EMS should be asked to demonstrate their progress towards achieving EMS in the future.

Information regarding BES 6001 certified suppliers can be found at <http://www.greenbooklive.com/page.jsp?id=169>

P1.4.6 to P1.4.8

P1.5 Materials**P1.5.1 Reinforcement**

This information is included here so that it is clear what is to be allowed for at tender stage when reinforcement drawings may not be available. At construction stage all relation information should be clear in the schedules.

The bending schedules are the only information sent to the reinforcement supplier and they must therefore make clear any special requirements for reinforcement grade. The schedule is therefore where bars other than 'H' must be specified, although this information can also be included in NSCS Project Specification. Scheduling Grade A, B or C will ensure that the correct grade will be used, (albeit Grade B allows B or C to be supplied).

For responsible sourcing the following clauses might be used:

Either

The mill supplying the reinforcement shall operate a certified environmental management system operated by an accredited certification body to BS EN ISO 14001.

The fabricator shall confirm the steel is supplied from a certified mill and operate an environmental management system, which follows the principles of BS EN ISO 14001, EMAS or, for SMEs, BS 8555 or equivalent.

Or

The fabricator, and mill supplying the reinforcement, shall be certified through either the Eco-Reinforcement scheme operated by BRE Global, or the 'Sustainable Reinforcing Steel Scheme' operated by CARES, or other third-party accredited scheme that follows the principles of BS 8902.

The second option is more demanding, and includes the requirements of the first option.

Further information about the schemes can be obtained from the UK Cares or Eco-Reinforcement websites allowing specifiers to identify any key project issues that may require additional project clauses or selection of a particular scheme.

Note: In October 2009 it was confirmed that most of the UK fabricators and mills (both UK and overseas) supplying rebar to the UK market have, or are working towards, certification to BS EN ISO 14001. By the middle to end of 2010 mills and fabricators, except for small fabricators, should in addition be covered by a UKAS accredited certification to this effect.

P1.5.2 Timber

For responsible sourcing the following clauses might be used:

Either

80% of timber to be certified sustainably sourced by CPET recognised schemes.

Or

100% of timber to be certified sustainably sourced by CPET recognised schemes.

The first is a reasonable minimum; the second may be required by the client or to help, for example, in gaining BREEAM credits for the project.

P1.5.3 Other materials

There may be materials that comply with current British or European Standards but which, for a particular reason, will not be permitted in the structure. This may be due to the Engineer's requirements for the particular design or due to a particular requirement by the Employer. Best practice guidelines, for example, those in *Good practice in the selection of construction materials* (Sheehan, 1997), should be followed where possible in relation to what have previously been classified as 'excluded' materials.

Special consideration of materials has been noted to highlight such requirements. This information is also expected to be stated on the drawings and might apply to particular requirements for formwork materials, grouts and prestressing materials. Special requirements for concrete are covered by Cl. P1.8 in NSCS Project Specification.

Items supplied by the Employer are highlighted since this has been an area of some misunderstanding or inadvertent exclusion at tender stage.

Sustainable construction Project requirements regarding bio-degradable release agents and the global warming potential of insulants can be added here.

P1.6 Project requirements

This section provides the opportunity for the Employer or Engineer to record, by exception, any amendments to NSCS Standard Specification considered necessary for the satisfactory construction of the structure.

P1.7 Water-resisting construction

If water-resisting construction is specified on a performance specification, this may be stated in this section. If more space is required, reference can be made to NSCS Standard Specification Cl. P1.13, where the performance specification can be appended. Water-resisting systems can be applied sheet, liquid, render, special concrete mixes or any combination of these.

P1.8 Concrete

For detailed guidance on the different types of concrete see the notes in Section 8. The different types are listed in the order in which they are listed in BS 8500–1.

Any requirements for testing including strength testing if required and any site testing for consistence must be made clear in the relevant section.

Concrete that is to be finally exposed to view should be indicated in NSCS Project Specification Cl. P1.9.2 and referenced in Cl. P1.8.1 item 13, even if it is in an internal environment, as this may have a bearing on the materials and type of mix proportions selected.

Sustainable construction The most important sustainability issue to be considered in the specification and supply of concrete is the minimisation of the Portland (CEM I) cement content and hence maximisation of secondary cementitious material content; this should not be compromised by the less important issue, which is that of maximisation of the recycled or secondary aggregate content.

P1.9 Surface finishes

See guidance on concrete finishes given in NSCS Guidance Cl. 8.6.

Considerations in producing Special finishes include the need for particular care in the choice of materials, for both formwork and concrete, good site practice and satisfactory supervision of the work.

Early discussion between Architect, Engineer and the Constructor is essential to ensure understanding of the project finish required. This may include using existing examples as a basis for discussion about what is required. These may be examples of Contractor's previous execution as well as the Specifier's requirement, and are useful at tender stage. Some kind of reference panel is essential to avoid disputes.

P1.10 Precast concrete

The table in Cl. P1.10 of NSCS Project Specification should be used to make clear the detailed information that the CA needs from the Constructor at different stages. Issues that may need to be addressed to minimise the effect of site execution on the strength of joints or the structural performance of the precast concrete include:

- A detailed sequence of work; including the timing of temporary works removal.
- The time at which loads can be placed on the precast elements.
- The minimum bearing dimensions required.
- How any lack of fit at joints will be overcome.

This table should be coordinated with the design requirements for the precast concrete in table in Cl. P1.3 of NSCS Project Specification.

For responsible sourcing the following clauses are suggested to achieve current best practice levels in precast supply.

Either

The precast concrete supplier shall: be a signatory to the British Precast Sustainability Charter; provide evidence that they have, or are working towards, BS EN ISO 14001 certification; and be participating in the British Precast 'Concrete Targets' health and safety improvement scheme. Information regarding the content and uptake of the British Precast sustainability charter can be found on the British Precast website, www.britishprecast.org

Or, when available

Precast concrete supply shall be certified against a responsible sourcing scheme to BS 8902.

P1.11 Prestressed concrete construction

This section is used to define in detail the design and detailing information to be exchanged between the Manufacturer and the Designers to ensure the prestressed work is carried out satisfactorily. A Quality Audit is to be encouraged – ideally this 'will be required' – and should be specified in NSCS Project Specification.

For responsible sourcing the following clauses are suggested to achieve current best practice levels in precast supply.

Either

The precast concrete supplier shall: be a signatory to the British Precast Sustainability Charter; provide evidence that they have, or are working towards, BS EN ISO 14001 certification; and be participating in the British Precast 'Concrete Targets' health and safety improvement scheme. Information regarding the content and uptake of the British Precast sustainability charter can be found on the British Precast website, www.britishprecast.org

Or, when available

Precast concrete supply shall be certified against a responsible sourcing scheme to BS 8902.

P1.11.1 Quality audit

It is recommended that a quality audit should be required by CARES, or equivalent, on most projects.

P1.12 Deflection allowances

P1.12.1

P1.12.2 Design pre-camber required for precast elements

Variation in pre-camber of precast concrete, particularly prestressed concrete elements, is often unavoidable. This can lead to screed finishes being either too thick or too thin and of variable thickness along the length of the elements. A reasonable variation between maximum and minimum pre-camber needs to be identified at the design stage by discussion with precast concrete specialists. This is also important so that the datum level of each floor in relation to the slab surface is clearly understood and identified on the drawings.

P1.13 Further information

The clauses to which any additional information relates to should be clearly stated.

Section P2 Information to be supplied BY the Constructor

The CA needs to review this section to ensure that only information relevant to the project is requested. Information required from the Constructor is necessary to enable the Employer to complete the detailed programme and for quality control of the entire project. The programme for the issuing of any drawings by the Constructor is required early in the project since the Engineer may need to comment and will require adequate review time. The Constructor should always complete this section as fully as possible at tender stage to identify any issues that in discussion with the CA and Engineer may produce improvements to the tender scheme.

P2.1 to P2.4

P2.5 Materials

This is where the Contractor can specify any materials they want to use in place of, or in addition to, those specified – such as the addition of fibres to concrete.

P2.6 to P2.9

Bibliography

Standards

| | |
|-----------------|---|
| BS 4449: 2005 | <i>Steel for the reinforcement of concrete – Weldable reinforcing steel – Bar, coil and decoiled product – Specification.</i> |
| BS 5606: 1990 | <i>Guide to accuracy in building.</i> |
| BS 5655-6: 2002 | <i>Lifts and service lifts – Code of practice for the selection and installation of new lifts.</i> |
| BS 6744: 2001 | <i>Stainless steel bars for the reinforcement of and use in concrete – Requirements and test methods.</i> |
| BS 7542: 1992 | <i>Method of test for curing compounds for concrete.</i> |
| BS 7973-1: 2001 | <i>Spacers and chairs for steel reinforcement and their specification – Product performance requirements.</i> |
| BS 8102: 2009 | <i>Code of practice for protection of structures against water from the ground.</i> |
| BS 8204 | <i>Screeds, bases and in situ floorings (7 parts). BSI, 2003–2008.</i> |
| BS 8500: 2006 | <i>Concrete – Complementary British Standard to BS EN 206-1 (2 parts).</i> |
| BS 8555: 2003 | <i>Environmental management systems – Guide to the phased implementation of an environmental management system including the use of environmental performance evaluation.</i> |
| BS 8666: 2005 | <i>Scheduling, dimensioning, bending and cutting of steel reinforcement for concrete – Specification.</i> |

| | |
|-----------------------|---|
| BS 8902: 2009 | <i>Responsible sourcing sector certification schemes for construction products – Specification.</i> |
| BS EN 197-1: 2000 | <i>Cement – Compositions, specifications and conformity criteria for common cements.</i> |
| BS EN 206-1: 2000 | <i>Concrete – Specification, performance, production and conformity.</i> |
| BS EN 450-1: 2005 | <i>Fly ash for concrete – Definition, specifications and conformity criteria.</i> |
| BS EN 1090 | <i>Execution of steel structures and aluminium structures (2 parts). BSI, 2008–2009.</i> |
| BS EN 1168: 2005 | <i>Precast concrete products – Hollow core slabs.</i> |
| BS EN 1992-1-1: 2004 | <i>Eurocode 2 – Design of concrete structures – General rules and rules for buildings and National Annex to BS EN 1992-1-1: 2005.</i> |
| BS EN 12350: 2009 | <i>Testing fresh concrete (7 parts).</i> |
| BS EN 12620: 2002 | <i>Aggregates for concrete.</i> |
| BS EN 12794: 2005 | <i>Precast concrete products – Foundation piles.</i> |
| BS EN 12843: 2004 | <i>Precast concrete products – Masts and poles.</i> |
| BS EN 13224: 2004 | <i>Precast concrete products – Ribbed floor elements.</i> |
| BS EN 13225: 2004 | <i>Precast concrete products – Linear structural elements.</i> |
| BS EN 13369: 2004 | <i>Common rules for precast concrete products.</i> |
| BS EN 13670: 2009 | <i>Execution of concrete structures.</i> |
| BS EN 13693: 2004 | <i>Precast concrete products – Special roof elements.</i> |
| BS EN 13747: 2005 | <i>Precast concrete products – Floor plates for floor systems.</i> |
| BS EN 13978-1: 2005 | <i>Precast concrete products – Precast concrete garages – Requirements for reinforced garages monolithic or consisting of single sections with room dimensions.</i> |
| BS EN 14487-2: 2006 | <i>Sprayed concrete – Execution.</i> |
| BS EN 14650: 2005 | <i>Precast concrete products – General rules for factory production control of metallic fibered concrete.</i> |
| BS EN 14843: 2007 | <i>Precast concrete products – Stairs.</i> |
| BS EN 14844: 2006 | <i>Precast concrete products – Box culverts.</i> |
| BS EN 14991: 2007 | <i>Precast concrete products – Foundation elements.</i> |
| BS EN 14992: 2007 | <i>Precast concrete products – Wall elements.</i> |
| BS EN 15050: 2007 | <i>Precast concrete products – Bridge elements.</i> |
| BS EN 15167-1: 2006 | <i>Ground granulated blast furnace slag for use in concretes, mortar and grout – Definitions, specifications and conformity criteria.</i> |
| BS EN ISO 9000: 2005 | <i>Quality management systems – Fundamentals and vocabulary.</i> |
| BS EN ISO 14001: 2004 | <i>Environmental management systems – Requirements with guidance for use.</i> |

- BS EN ISO IEC 17025: 2005 *General requirements for the competence of testing and calibration laboratories.*
- BS ISO 14654: 1999 *Epoxy-coated steel for the reinforcement of concrete.*

General

- ACIFC and THE CONCRETE SOCIETY. *Composite concrete slabs on steel decking – Guidance on construction and associated design considerations*, Good Concrete Guide 5, CS161. The Concrete Society, 2008.
- AINSWORTH, P. R. & HOPKINS, C. J. *Action in the case of non-conformity of concrete structures*, C519. CIRIA, 1999.
- AMERICAN CONCRETE INSTITUTE. Committee 440, *Guide for the design and construction of structural concrete reinforced with FRP bars*, 440.1R-06. Detroit, ACI, 2006.
- ARCHITECTURAL CLADDING ASSOCIATION. *Safe erection of precast concrete cladding*. British Precast, 1998.
- BAMFORTH, P. B. *Early-age thermal crack control in concrete*, C660. CIRIA, 2007.
- BAMFORTH, P. B. & PRICE, W. F. *Concreting deep lifts and large volume pours*, R135. CIRIA, 1995.
- BRITISH CEMENT ASSOCIATION. *Visual concrete: design and production*. Appearance Matters 1, 47.101. Wexham Springs, BCA, 1988.
- BRITISH CEMENT ASSOCIATION. *External rendering*, Appearance Matters 2, 47.102. Wexham Springs, BCA, 1992.
- BRITISH CEMENT ASSOCIATION. *The control of blemishes in concrete*, Appearance Matters 3, 47.103. Wexham Springs, BCA, 1981.
- BRITISH CEMENT ASSOCIATION. *Efflorescence on concrete surfaces*, Appearance Matters 4, 47.104. Wexham Springs, BCA, 1982.
- BRITISH CEMENT ASSOCIATION. *Removal of stains and growths from concrete*, Appearance Matters 5, 47.105. Wexham Springs, BCA, 1982.
- BRITISH CEMENT ASSOCIATION. *The weathering of concrete buildings*, Appearance Matters 6, 47.106. Wexham Springs, BCA, 1986.
- BRITISH CEMENT ASSOCIATION. *Textured and profiled concrete finishes*, Appearance Matters 7, 47.107. Wexham Springs, BCA, 1986.
- BRITISH CEMENT ASSOCIATION. *Exposed aggregate concrete finishes*, Appearance Matters 8, 47.108. Wexham Springs, BCA, 1985.
- BRITISH CEMENT ASSOCIATION. *Tooled concrete finishes*, Appearance Matters 9, 47.109. Wexham Springs, BCA, 1985.
- BRITISH CEMENT ASSOCIATION. *Early age strength assessment of concrete on site*, European Concrete Building Project (ECBP), Best practice guides for in-situ concrete frame buildings, 97.503. BCA, 2000.
- BRITISH READY-MIXED CONCRETE ASSOCIATION. *Guidance document on sustainable concrete design and rating systems*. BRMCA/01/09, 2008.
- BUILDING RESEARCH ESTABLISHMENT. *Alkali-silica reaction in concrete*, Digest 330. BRE, 2004.

- BUILDING RESEARCH ESTABLISHMENT. *Concrete in aggressive ground*, Special Digest 1. BRE, 2005.
- BUSSELL, M. N. & CATHER, R. *Care and treatment of steel reinforcement and the protection of starter bars*, R147. CIRIA, 1995.
- CEB (Comité Euro-International du Béton). *Coating protection for reinforcement. State of the art report*. Thomas Telford, 1995.
- CLARK, L. A. et al. How can we get the cover we need? *Structural Engineer*, Vol. 75, Sept., No 17, 1997.
- CONCRETE INDUSTRY SUSTAINABLE CONSTRUCTION FORUM. *The Concrete Industry Guidance Document to support BRE Environmental & Sustainability Standard BES 6001 – Framework standard for the responsible sourcing of construction products*. CISCf, 2008. Download available from Sustainableconcrete.org.uk
- CONSTRUCT. *The guide to contractor detailing of reinforcement in concrete*. CONSTRUCT, 1997.
- DAWSON, S. *Cast in concrete – A guide to the design of precast concrete and reconstructed stone*. Leicester, Architectural Cladding Association, 2003.
- HALLIWELL, S. M. & REYNOLDS, T. *Effective use of fibre reinforced polymer materials in construction*, FBE Report 8. BRE, 2004.
- HARRISON, T. A. *Formwork striking times – criteria, prediction and method of assessment*, R136. CIRIA, 1995.
- INSTITUTION OF STRUCTURAL ENGINEERS. *Interim guidance on the design of reinforced concrete structures using fibre composite reinforcement*. IStructE, 1999.
- INSTITUTION OF STRUCTURAL ENGINEERS. *Standard method of detailing structural concrete. A manual for best practice*, 3rd edition. IStructE, 2006.
- KING, E.S. & DAKIN, J.M. *Specifying detailing and achieving cover to reinforcement*, Report C568. CIRIA, 2001.
- NORWEGIAN PRECAST CONCRETE FEDERATION. *The concrete element book – Volume F – Tolerances*. 2005. (Available from British Precast, Leicester)
- PALLET, P F. *Guide to flat slab falsework and formwork*, CS140. The Concrete Society on behalf of CONSTRUCT, 2003.
- PRECAST FLOORING FEDERATION. *Safe erection of precast concrete flooring and associated components*. British Precast, 2007.
- REINFORCED CONCRETE COUNCIL. Large area pours for suspended slabs. *Reinforcing LINKS* Issue 3. BCA, 1993.
- SHEEHAN, T. *Good practice in the selection of construction materials*. Ove Arup & Partners, British Property Federation & British Council for Offices, 1997.
- SIMPSON, D. *Concrete ground floor slabs: thickness tolerances*. *Concrete*, Vol. 34, pp 22-23, February 2000.
- STRUCTURAL PRECAST ASSOCIATION. *Safe erection of precast concrete frameworks (COP)*. British Precast, 1999.
- THE CONCRETE SOCIETY. *Formwork – A guide to good practice*, CS030, 2nd edition. The Concrete Society, 1995.
- THE CONCRETE SOCIETY. *Design guidance for high strength concrete*, TR49. The Concrete Society, 1998.

- THE CONCRETE SOCIETY. *Guidance on the use of stainless steel reinforcement*, TR51. The Concrete Society, 1998.
- THE CONCRETE SOCIETY. *Alkali-silica reaction – Minimising the risk of damage to concrete*, TR30, 3rd edition. The Concrete Society, 1999.
- THE CONCRETE SOCIETY. *Plain formed concrete finishes*, TR52. The Concrete Society, 1999.
- THE CONCRETE SOCIETY. *Checklist for erecting and dismantling falsework*, CS123. The Concrete Society, 1999.
- THE CONCRETE SOCIETY. *Durable post-tensioned concrete bridges*, TR47, 2nd edition. The Concrete Society, 2002.
- THE CONCRETE SOCIETY. *Concrete industrial ground floors – A guide to their design and construction*, TR34, 3rd edition. The Concrete Society, 2003. New edition due 2010.
- THE CONCRETE SOCIETY. *Enhancing reinforced concrete durability*, TR61. The Concrete Society, 2004.
- THE CONCRETE SOCIETY. *External in-situ concrete paving*, TR66. The Concrete Society, 2007.
- THE CONCRETE SOCIETY. *Guidance for the design of steel-fibre-reinforced concrete*, TR63. The Concrete Society, 2007.
- THE CONCRETE SOCIETY. *Guidance on the use of macro-synthetic fibre reinforced concrete*, TR65. The Concrete Society, 2007.
- THE CONCRETE SOCIETY. *Concrete practice – Guidance on the practical aspects of concreting*. Good Concrete Guide 8. The Concrete Society, 2008.
- THE CONCRETE SOCIETY. *Non-structural cracks in concrete*, TR22, 4th edition. The Concrete Society, due 2010.
- THE CONCRETE SOCIETY and CONSTRUCT. *Plain formed concrete finishes*, TR52. The Concrete Society, 1999.
- THE STATIONERY OFFICE. *Approved Document A – Structure*, 2004 edition. TSO, 2006.
- YOUNG, S. BES 6001: *Responsible sourcing of construction products – Framework standard for the responsible sourcing of construction products*. BRE, 2009.

