

ANALYSING SENTENCES

An Introduction
to English Syntax

Third Edition

Noel Burton-Roberts

LEARNING ABOUT LANGUAGE

Analysing Sentences

LEARNING ABOUT LANGUAGE

General Editors:

Geoffrey Leech & Mick Short, Lancaster University

Also in this series:

Words and Their Meaning Howard Jackson

An Introduction to Phonology Francis Katamba

Grammar and Meaning Howard Jackson

An Introduction to Sociolinguistics (Third edition) Janet Holmes

Realms of Meaning: An Introduction to Semantics Th. R. Hofmann

An Introduction to Psycholinguistics (Second edition) Danny D. Steinberg

An Introduction to Spoken Interaction Anna-Brita Stenström

Watching English Change Laurie Bauer

Meaning in Interaction: An Introduction to Pragmatics Jenny Thomas

An Introduction to Cognitive Linguistics (Second edition) Friedrich Ungerer and
Hans-Jörg Schmid

Exploring the Language of Poems, Plays and Prose Mick Short

Contemporary Linguistics: An Introduction William O'Grady, Michael Dobrovolsky
and Francis Katamba

An Introduction to Natural Language Processing Through Prolog Clive Matthews

An Introduction to Child Language Development Susan Foster-Cohen

The Sounds of Language: An Introduction to Phonetics Henry Rogers

Varieties of Modern English Diana Davies

An Introduction to Language Acquisition Susan Foster-Cohen

Patterns of Spoken English Gerald Knowles

The Earliest English: An Introduction to Old English Language Chris McCully

An Introduction to Foreign Language Learning and Teaching (Second edition)
Keith Johnson

Analysing Sentences

An Introduction to English Syntax

Third Edition

NOEL BURTON-ROBERTS



Longman
is an imprint of

PEARSON

Harlow, England • London • New York • Boston • San Francisco • Toronto
Sydney • Tokyo • Singapore • Hong Kong • Seoul • Taipei • New Delhi
Cape Town • Madrid • Mexico City • Amsterdam • Munich • Paris • Milan

PEARSON EDUCATION LIMITED

Edinburgh Gate
Harlow CM20 2JE
Tel: +44 (0)1279 623623
Fax: +44 (0)1279 431059
Website: www.pearsoned.co.uk

First published in Great Britain in 1986

Second edition published 1997

Third edition published 2011

© Pearson Education Limited 1986, 1997, 2011

The right of Noel Burton-Roberts to be identified as author of this work has been asserted by him in accordance with the Copyright, Designs and Patents Act 1988.

Pearson Education is not responsible for the content of third party internet sites.

ISBN: 978-1-4082-3374-0

British Library Cataloguing-in-Publication Data

A catalogue record for this book is available from the British Library

Library of Congress Cataloging-in-Publication Data

Burton-Roberts, Noel, 1948–

Analysing sentences : an introduction to English syntax / Noel Burton-Roberts. – 3rd ed.
p. cm. – (Learning about language)

Includes index.

ISBN 978-1-4082-3374-0 (pbk.)

1. English language–Sentences. 2. English language–Syntax. I. Title.

PE1375.B87 2010

428.2–dc22

2010015457

All rights reserved. No part of this publication may be reproduced, stored in a retrieval system, or transmitted in any form or by any means, electronic, mechanical, photocopying, recording or otherwise, without either the prior written permission of the publisher or a licence permitting restricted copying in the United Kingdom issued by the Copyright Licensing Agency Ltd, Saffron House, 6–10 Kirby Street, London EC1N 8TS. This book may not be lent, resold, hired out or otherwise disposed of by way of trade in any form of binding or cover other than that in which it is published, without the prior consent of the Publishers.

10 9 8 7 6 5 4 3 2 1
14 13 12 11 10

Typeset in 10.5/13pt Minion by 35

Printed and bound in Malaysia, (CTP-KHL)

Contents

<i>Preface to the third edition</i>	ix
<i>Preface to the second edition</i>	xi
<i>Preface to the first edition</i>	xiv
Introduction	1
The organisation of the chapters	4
A note on how to read this book	4
1 Sentence structure: constituents	6
Structure	6
Establishing constituents	10
'Phrase' and 'constituent'	15
Exercises	19
Discussion of exercises	20
Further exercises	23
2 Sentence structure: functions	24
Subject and predicate	24
Noun Phrase and Verb Phrase	29
Dependency and function	31
Head	32
The modifier~head relation	32
The head~complement relation	35
Summary	38
Exercises	38
Discussion of exercises	40
Further exercises	43
3 Sentence structure: categories	46
Nouns	47
Lexical and phrasal categories (noun and Noun Phrase)	50
Adjectives and adverbs	54
Adjective Phrases and Adverb Phrases	55
Prepositions and Prepositional Phrases	56
Co-ordinate Phrases	57
Diagrams for in-text exercises	62
Exercises	62
Discussion of exercises	63
Further exercises	65

4	The basic Verb Phrase	67
	A first look at verbs	67
	The complements of lexical verbs	68
	Transitive verbs	70
	Intransitive verbs	71
	Ditransitive verbs	72
	Intensive verbs	74
	Complex transitive verbs	76
	Prepositional verbs	78
	Summary	79
	Discussion of in-text exercises	80
	Exercises	80
	Discussion of exercises	82
	Further exercises	85
5	Adverbials and other matters	87
	Adjunct adverbials (VP adverbials)	87
	Levels of Verb Phrase	88
	The mobility of adverbials	92
	Phrasal verbs	93
	Ellipsis	96
	Sentence adverbials (S adverbials)	98
	Discussion of in-text exercises	101
	Exercises	103
	Discussion of exercises	104
	Further exercises	109
6	More on verbs: auxiliary VPs	111
	Part I: Lexical and auxiliary verbs	111
	Tense and time	112
	The contrast between lexical and auxiliary verbs	114
	Modal auxiliaries (MOD)	115
	The perfect auxiliary – <i>have</i> (PERF)	116
	The progressive auxiliary – <i>be</i> (PROG)	118
	The passive auxiliary – <i>be</i> (PASS)	119
	Where auxiliaries fit in the structure of VP	121
	Auxiliary VPs and adverbials	123
	Part II: Constructions that depend on auxiliaries	125
	Passive sentences	125
	Negative sentences and auxiliary <i>do</i>	128
	Questions – fronting the tensed auxiliary	130
	More on <i>have</i> and <i>be</i>	132
	Discussion of in-text exercises	133
	Exercises for Part I	135

Exercises for Part II	135
Discussion of exercises	135
Further exercises (Part I)	138
Further exercises (Part II)	139
7 The structure of Noun Phrases	141
Determiners	142
Pre-determiners	145
Pre-modifiers in NOM	146
Quantifying adjectives	146
Participle phrases (PartP)	147
Nouns	148
More on the structure of NOM	149
Post-modifiers	150
Prepositional Phrases	150
More on Adjective Phrases	154
Modification of pronouns	155
Discussion of in-text exercises	157
Exercises	160
Discussion of exercises	161
Further exercises	163
Appendix: NOM and the pro-form <i>one</i>	165
Answers to exercise	169
Further exercise	170
8 Sentences within sentences	171
Complementisers: <i>that</i> and <i>whether</i>	174
The functions of <i>that</i> - and <i>whether</i> -clauses	176
Subject – and extraposed subject	176
Complement of V within VP	179
Complement of A within AP	181
Complement of N within NP	182
Complement of P within PP	184
Adverbial clauses	186
Discussion of in-text exercises	188
Exercises	191
Discussion of exercises	192
Further exercises	194
9 Wh-clauses	196
Wh-questions	196
Subordinate wh-clauses	202
Subordinate wh-interrogative clauses	202
Relative clauses	204

CONTENTS

Omission of the <i>wh</i> -phrase	207
<i>That</i> again	207
Restrictive vs. non-restrictive	208
Discussion of in-text exercises	211
Exercises	216
Discussion of exercises	218
Further exercises	220
Questions and interrogatives	220
Relative clauses and other matters	221
10 Non-finite clauses	224
Part I: The form of non-finite clauses	224
The form of non-finite verbs	225
Ia. Bare infinitive verbs	226
Ib. <i>To</i> -infinitive verbs	226
IIa. Passive participle verbs	227
IIb. <i>-ing</i> participle verbs	228
Complementisers and non-finite clauses	229
C1: <i>for</i> and <i>whether</i>	230
C2: fronted <i>wh</i> -phrases	230
Part II: The functions of non-finite clauses	232
Subject and extraposed subject	232
Complement of A in AP	233
Complement of P in PP	234
Adverbial	234
Complement of N in NP	235
Modifier in NP	235
Complement of V	236
Discussion of in-text exercises	244
Exercises	247
Discussion of exercises	249
Further exercises	251
11 Languages, sentences and grammars	254
Languages	254
Describing languages	257
Describing infinite languages	259
Grammars	262
Grammars and sentence analysis	265
<i>Further reading</i>	269
<i>Index</i>	271

Preface to the third edition

The major substantive change in this edition concerns VERBS. I have abandoned the ‘Verb Group’. The ‘Vgrp’ was pedagogically convenient but it did not do justice to the facts of how auxiliary verbs figure the structure of VP.

The treatment of auxiliaries is now more standard. Each auxiliary is treated as taking a VP complement. This allows me to maintain the idea that complements of lexical verbs are their sisters, combining with them to form a (‘basic’) VP. This also makes the use of the *do so* test for VP more consistent than in previous editions (it actually works now). And it allows me to acknowledge that adverbials can, and very naturally do, occur between auxiliaries and between auxiliary and lexical verbs.

Contrary to what I expected, this change has barely increased the complexity of the presentation. I have simplified some examples. I have kept the terminology of the previous editions (including MOD, PERF, PROG, PASS) insofar as it is consistent with the new analysis. In fact, Chapter 4 – now called ‘The basic Verb Phrase’ – is now simpler and more focused. The reader can concentrate on what really matters here – complementation of lexical verbs. True, this means there is more to discuss in Chapter 6 – now called ‘More on Verbs: auxiliary VPs’ – but I’ve divided that chapter into two parts in what seems a fairly natural way. This gives teachers the option of spending two weeks on that material.

There are other, smaller, analytical changes:

- (i) In Chapter 3, *now, then, when* and *here, there, where* are now categorised as prepositions, abandoning the previous traditional categorisation of them as adverbs. This means that PP can consist just of P, as well as P + NP.
- (ii) The section ‘Modification of pronouns’ in Chapter 7 now maintains a more consistent distinction between pronouns and (pre-)determiners. The latter remain (pre-)determiners – i.e. they don’t suddenly become pronouns – in NPs like *those at the back*. These are now analysed as having an elliptical head (*those* [E]_N *at the back*).
- (iii) The section ‘More on Adjective Phrases’ in Chapter 7 takes greater care than before in explaining complementation of adjectives – and why APs with complements must post-modify the head within NP.
- (iv) In Chapter 8 of the last edition, I categorised *after, before, until, and since* as subordinating conjunctions but I had a Further Exercise inviting the reader to wonder if they weren’t in fact prepositions. I now analyse them as

prepositions. *Since* is special: it is both a preposition (*since he became my friend*) and a subordinating conjunction (*since he is my friend*).

Other changes are mainly presentational. The presentation has been tightened up and it is, I hope, clearer and more user-friendly. There are a few more summaries. Chapter 10 is now divided into two more manageable parts. And there are some minor typographical changes:

- (i) For NPs consisting of names, I've introduced 'name' as a node. Idiosyncratic perhaps but (together with 'pronoun' – which replaces 'PRO') I think it will help students to remember to distinguish these single-word NPs from NPs with empty determiner.
- (ii) Where I have numbered VPs, the lowest (i.e. 'basic') VP is always 'VP1'.
- (iii) 'Comp' has given way to 'C' – with lower C as 'C1' and the higher as 'C2'.
- (iv) I now represent S-bar as *S'* and S-double-bar as *S''*. (For convenience, only S (not *S'* or *S''*) is required in abbreviated clausal analyses.)
- (v) I use '•' for gaps.
- (vi) I now often indicate movements graphically in examples and in phrase markers.

When a third edition of *Analysing Sentences* was planned, the publishers solicited anonymous reviews of the second edition. A surprising number came in, all of them detailed. I am extremely grateful to those who responded so constructively. Those responses presented me with a bewildering variety of views about what was good or bad about the previous edition. (For example, some thought the Verb Group the best thing about the book, but the majority loathed it and regarded it as a blot on the landscape.) So I have been selective in following their suggestions. A few suggested I present a thorough-going X-bar analysis. I've not done that, since it would have completely changed the character of the book. If X-bar is what's needed, there are plenty of other texts to supply that need. And I have kept Chapter 11 unchanged. It may have a rather dated feel to it but I think it still does the job it was designed to do. Nor have I changed its position in the book. It is a *post-script* to what is intended as a practical, descriptive, introductory account of English.

For pointing out mistakes and making suggestions for improvement, I am grateful to strangers who have e-mailed me, to friends, colleagues, postgraduate tutorial assistants who have helped me teach first-year syntax at Newcastle and, last but not least, the students. One of those tutorial assistants, Laura Bailey, cast her eagle eye over the pre-final draft to great effect and she has my thanks for that.

I have prepared an Answer Book for the Further Exercises. Teaching Staff can ask for this by emailing n.burton-roberts@ncl.ac.uk.

Preface to the second edition

When I first wrote *Analysing Sentences*, I had in mind the kind of mixed audience that I taught (and still teach) in an introductory course at Newcastle. This included first-year undergraduates in linguistics and English language who would be going on to find out more about English syntax, syntactic theory, and argumentation in syntactic theory in later years. It also included many others who probably would not continue and whose purposes were different and quite varied. For these, the book had to provide a self-contained, systematic, and coherent introductory picture of English in its own right. They were less interested, perhaps, in syntactic theory than in forming a reasonably informed impression of the structural range of the language and a grasp of the vocabulary and concepts needed to describe it. So the aim was to strike a balance between providing both descriptive range and descriptive convenience on the one hand while, on the other, offering something of genuine use to someone about to embark more seriously on syntactic theory and argumentation.

Many of the changes in this second edition have been made with this balance in mind. Occasionally, in the first edition, I made decisions which, while pedagogically convenient, have come over the years to seem less and less defensible or useful in an introduction to syntax. So I have done something about them. For teachers familiar with the first edition who want an overview of more important changes, I have listed them below.

A more general change concerns the exercises. There are more of them and there are now 'Further Exercises'. These come without answers and can be used for seminar work. Some are designed (as before) to test comprehension, others to give practice in handling new data and to encourage thought. More than in the first edition, rather than give a phrase-marker in the text, I set the drawing of the phrase-marker as an exercise. It is always given in a 'Discussion' at the end of the chapter. This, I think, makes for more worthwhile and enjoyable reading, and it builds confidence. It seems essential the reader be encouraged to do these before consulting the Discussion.

One thing that has not changed is the 'Verb Group'. Much though I feel inclined to, I won't apologise for retaining this! I grant the evidence which suggests there is no such thing (and its incompatibility with X-bar). But there is less agreement on how verbs in English *are* to be treated. Some textbooks simply avoid the issues, by restricting their coverage of the possibilities I have gathered up under 'Vgrp'. I have kept it because it is convenient: it provides a way

of covering those possibilities (and introducing needed vocabulary, in a way beginners find intuitive) without immediately embroiling them in problems, lengthy explanations, and excuses. Besides, I have found it useful as an illustrative starting point in later courses on argumentation.

The following major changes of detail have been made, not only in aid of bringing the analysis a little more into line with common current practice, but also in the light of my own experience of teaching the first edition. This has made me think that I was sometimes a little over-cautious as regards what is teachable at this stage. Even so, many of the changes have actually had a simplifying effect.

- (i) Chapter 2. Governors (first edition) are now explicitly referred to as ‘heads’ (not as ‘governors’).
- (ii) Chapter 5. Adjunct adverbials are now, in addition, explicitly referred to as ‘VP-adverbials’. This is more helpful, in my view. And, while the distinction between the ‘conjunct adverbials’ and ‘disjunct adverbials’ of the first edition is alluded to, this detail has been played down. Both are now explicitly referred to as ‘Sentence-adverbials’ (‘S-adverbials’).
- (iii) Chapter 6. What in the first edition was called ‘Subject-Auxiliary Inversion’ is now more accurately ‘Auxiliary fronting’. More importantly, the auxiliary is now fronted to the complementiser position (daughter of S-bar, sister of S). This is a major change and involves changes elsewhere – see below. It means that ‘S-bar’ is now introduced in Chapter 6 rather than Chapter 8. Auxiliary-fronting leaves a gap under AUX.
- (iv) Chapter 6. It is more helpful to the student (to remember that passive verbs are not intransitive) to have a gap in the object position following a passive verb. Some students do this spontaneously, anyway. And it provides a better preparation for what is to follow, both in the book and elsewhere. So I now insist on a gap in object position.
- (v) Chapter 7. The term ‘zero article’ has been abandoned in favour of ‘unfilled DET’.
- (vi) Chapter 7. The discussion of *one* in the first edition was unsatisfactory. It was not used to motivate any distinction, within NP, between complements and adjuncts and so never really worked. I have simplified here by postponing all mention of *one* to an Appendix in Chapter 7, where it *is* associated with the distinction between adjuncts (‘NOM-modifiers’) and complements (‘N-modifiers’). The chapter can be read quite independently of that appendix, however (in my experience, beginners find the distinction between adjunct and complement difficult in the context of NP). Tutors can decide for themselves whether to insist that the distinction be respected in Chapter 7. Other changes (in Chapters 8 and 9) anyway mean that it does now eventually emerge, clearly and naturally, when really necessary.

- (vii) Chapter 8. I now introduce the complementiser *whether* (and hence subordinate *yes/no* interrogative clauses) here, along with *that*.
- (viii) Chapter 8. The representation of noun-complement clauses in the first edition was unsatisfactory. As complements, these are now more simply and accurately represented as sisters of N within NOM. See below for a consequent change to the structural position of restrictive relative clauses.
- (ix) Chapter 9. The order of presentation has changed: the chapter now moves from *wh*-interrogative clauses (main and subordinate) to relative clauses. This is convenient if, as I do, one spends two separate weeks on this chapter (one on interrogatives, one on relatives). A further minor change from the first edition is that subject constituent questions are now presented as having a fronted auxiliary. (There is a 'Further Exercise' on this.)
- (x) Chapter 9. Since auxiliaries are now fronted to the (S-bar) complementiser position (Ch. 6), which cannot be filled twice over, *Wh*-expressions are now fronted to a higher Comp position (Comp-2). Comp-2 is here defined as daughter of S-double bar, sister of S-bar.
- (xi) Chapter 9. Since noun complement clauses are now sisters of N (Ch. 8), relative clauses are now represented as sisters of NOM. As explained there, this distinction between N-modifier (complement clause) and NOM-modifier (relative clause) parallels that between complement and adjunct in the VP. If interested (or required!), the student is now in a position to generalise this to all modifiers in NP, by turning back to the Appendix in Chapter 7.
- (xii) Chapter 10 remains largely unchanged (apart from changes consequent on those in earlier chapters) though there is slightly more detail and discussion.

In preparing this second edition, I have benefited from the comments and advice of many people. They are too numerous to mention and thank individually here, but I must mention the help of Phil Carr and Siobhan Chapman. The students at Newcastle (whose responses have invariably been interesting and instructive) have taught me more than they know. I am especially grateful to Georgette Ioup, who I met in Morocco in 1983 when I had just started writing the first edition. Her detailed and insightful comments on it over the last ten years have been of great help, not to say indispensable. My wife Tessa has borne with grace my probings of her linguistic competence, and Julia, my daughter, has made the rewriting much more enjoyable by joining me in vandalising copies of the first edition, pasting, and stapling.

I would like to dedicate this second edition to my mother and the memory of my father.

Preface to the first edition

This book grew out of a longish pamphlet used with first-year undergraduates in the University of Newcastle upon Tyne, which I wrote in 1979. I'd like to acknowledge the late Barbara Strang's encouragement when I wrote that pamphlet. Thanks, too, to Geoff Leech and Mick Short (the series editors) for their help and encouragement in producing the book as it now stands. Valerie Adams, painstakingly and to good effect, went through each chapter as it was completed and for this I am very grateful. This book has also benefited from comments made by Ewan Klein, Maggie Cooper, Rodney Huddleston, Michael Anthony, Phil Carr, Liz Smith, and Lesley Milroy. Herman Moisl's arbitrations between myself and the word processor are gratefully acknowledged. I owe a general debt of gratitude to Sir Randolph Quirk, who introduced me to the study of the English language in the first place. Finally, my thanks to Tessa for her support and patience.

Introduction

Attempting to describe the language you speak is about as difficult as attempting to describe yourself as a person. Your language is very much part of you and your thinking. You use your language so instinctively that it is difficult to stand outside yourself and think of it as something that is independent of you, something which you know and which can be described. You may even feel inclined to say that your language is not something you know, you just speak it, and that's all there is to it. But as the native speaker of a language, there is an important sense in which you do know all that there is to know about that language. This is not to deny that there are almost certainly words with which you are not familiar. Perhaps you don't know the meaning of the word *lagophthalmic*. If so, your (understandable) ignorance of this is more medical ignorance than ignorance about the English language, and is anyway quickly remedied with the help of a dictionary. But there is much more to a language than its words. There is much more that you do know about your language which cannot so conveniently be looked up, and which you were never explicitly taught. And this is knowledge of a more fundamental and systematic kind than knowledge of the meanings of individual words. The more fundamental such knowledge is, the more difficult it is to become consciously aware of it.

We are brought up sharply against our own knowledge of the language when, for example, we hear a foreigner make a mistake. You may have had the frustrating experience of knowing that something is wrong but not being able to say precisely what it is, beyond saying 'We just don't say it like that.' The very deep-seated character of speakers' knowledge of their language makes it extremely difficult for them to explain what it is they know.

Here are some examples to illustrate the point. As a speaker of English, you will agree that [1] and [2] are good English sentences:

- [1] Dick believes himself to be a genius.
- [2] Dick believes he is a genius.

but that there is something wrong with [3] and [4]:

- [3] Dick believes he to be a genius.
- [4] Dick believes himself is a genius.

It's interesting that, simply on the basis of assuming you speak English, and knowing nothing else about you, I can predict that you will judge [1] and [2] to be good and [3] and [4] to be odd, even though these sentences are something you may never have considered before.

In attempting to answer the question 'Is this an example of a good English sentence or not?' we are obliged to go to speakers of the language and ask them whether they would accept it as such. (If we ourselves speak the language, then we may ask ourselves.) It's difficult to see how else we could decide what is and what is not a sentence of English. Yet, if this is so, our agreement about [1]–[4] constitutes a fact about the English language. In a real sense, then, all the facts about the language lie inside the heads of its speakers, be they native speakers or not.

But can you give an explanation for the oddity of [3] and [4] – beyond saying that we just don't say it like that?

Here is another example. If the negative of [5] is [6],

[5] They were jumping on it.

[6] They weren't jumping on it.

why isn't [8] the negative of [7]?

[7] They tried jumping on it.

[8] They triedn't jumping on it.

And another example: Since [9] is a good English sentence, why aren't [10] and [11]?

[9] Bevis mended his car in the garage and Max did so in the garden.

[10] Bevis put his car in the garage and Max did so in the garden.

[11] Bevis went to the circus and Max did so to the zoo.

Finally, compare [12] and [13]:

[12] The fact that I communicated to Mona is irrelevant.

[13] The fact that I communicated with Mona is irrelevant.

Superficially, the only difference might seem to be the different prepositions, *with* and *to*. So we might expect the difference to be exactly the same as that between *I went with Max* and *I went to Max*. In fact, though, your understanding of the difference between [12] and [13] goes way beyond your understanding of the difference between *with* and *to*. You can demonstrate this for yourself: try replacing the *that* in each sentence by *which*. How do you react? Do you agree that you can do it with [12] but not [13]? What is going on here? Why should the choice of preposition in one part of a sentence affect the choice of *that* or *which* in another part? You know it does, but what exactly is it that you know?

What exactly is wrong with *The fact which I communicated with Mona is irrelevant*? In a quite literal sense, there is more going on here than meets the eye.

These are just a tiny sample of a large body of facts, mysteries, and puzzles offered by the English language. Some of the puzzles have been solved (to our present satisfaction, at least). Others remain puzzles, or there is disagreement as to what the most appropriate explanation might be. And, as we find out more about the language, we should expect to discover further puzzles, and perhaps even find things puzzling which we thought we had understood.

The aim of this book is to encourage you to stand outside yourself and confront just one aspect of your largely unconscious knowledge of English. It doesn't discuss, let alone offer solutions to, all the puzzles known to exist, nor even to give very detailed accounts of intricacies like those above. But it will introduce you to a method of describing the language, and provide you with a vocabulary with which to start thinking about the language in terms of which the puzzles can at least be identified and solutions sought.

The chapters that follow are concerned with English SYNTAX. *Syntax* is traditionally the name given to the study of the form, positioning, and grouping, of the elements that go to make up sentences. In a word, it is about the STRUCTURE of sentences. In studying a language, there is of course a lot else to talk about besides its syntax. For example, we can investigate the form and grouping of the elements within words themselves (for example: *un-de-cod(e)-able*). The systematic study of word-structure is called MORPHOLOGY (the relevant elements are 'morphemes'). Or we can concentrate on the meaning of sentences and how their meaning relates to the meanings of the words they contain. This is called SEMANTICS. Or we can concentrate on how linguistic expressions are connected with the sounds of speech. This is called PHONOLOGY.

I'll say nothing about the phonology of English, and very little about morphology or semantics. It should become clear, though, just how closely the structure (syntax) and the meaning (semantics) of English sentences are related.

The book is an introduction to the practical analysis of English sentences rather than an introduction to linguistic theory. But since we will be concerned with a language and its syntax, some of the concepts, aims, and methods of linguistics are relevant. If you are interested in discovering more about linguistic theory, finding out something of the syntax of a language you know well seems an appropriate (indeed indispensable) way to start. Chapter 11 is included with such readers in mind. It aims to place the description of English offered in the previous chapters in a wider context and raise a few questions about the general aims and principles of syntactic analysis.

Finally, a word or two about the description offered here. In a book of this length, it hardly needs pointing out that the description is not exhaustive. Nevertheless, the range of structures covered is intended to be comprehensive

enough for the book to serve not only as the basis for more exhaustive and specialised study but as a self-contained description for non-specialists who need a practical, and applicable, system of analysis for the major structures.

Since this last aim is important, I've concentrated on presenting a single, more or less traditional, analysis of each structure considered, without overburdening the reader with too much discussion of how that analysis might or might not be justified in the light of further evidence. This might give the misleading impression that there is just one possible analysis and that there is universal agreement that it is the one in this book! This is far from being the case. But sometimes the evidence that might support an alternative analysis is complex and indirect and its discussion would be inappropriate in such an introduction. The reader should bear in mind, then, that we are never irrevocably committed to a particular analysis but are free to amend it in the light of further evidence. Finding that evidence, and deciding between competing analyses on the basis of such evidence is, in the end, what 'doing syntax' is all about.

■ The organisation of the chapters

Chapters 1, 2, and 3 have a dual purpose: they introduce general ideas relevant to the analysis of sentences while simultaneously beginning the analysis itself.

Chapters 4 and 5 complete the general overview of the simple sentence.

Chapters 6 and 7 each go into more detail on certain aspects of the structure of simple sentences.

Chapters 8, 9, and 10 deal with different kinds of subordinate clause in the complex sentence.

Chapter 11 is a more general discussion of the background to and purpose of the kind of analysis presented in Chapters 1 to 10.

■ A note on how to read this book

There are several kinds of exercises. The end-of-chapter 'Exercises' are followed immediately by answer/discussion sections. These should form an important part of your reading of each chapter. Most of these are designed to give you practice in applying the analyses discussed in the chapter, but some develop the discussion further.

In addition, there are end-of-chapter 'Further Exercises'. These come without answers or discussion. If you are using the book as part of a taught course, you may be asked to write these up for marking and discussion by your tutor.

Almost certainly, you're using this book because you know next to nothing about English syntax. If you've thought about it at all, you're probably wondering whether you can get your head around it. *Courage!* The book is designed with you in mind. If you read it in the right spirit, you'll be amazed by

much how you have achieved by the end. That's been the experience of the many students I've taught. To foster 'the right spirit', there are lots of small exercises *within* the text of each chapter. These form an integral part of the discussion. Try doing them as and when they occur, before reading further. As often as not, the discussion that follows depends on your having done the exercise. A line has been ruled at the point where it is suggested you stop and do it. You'll need to have pencil and paper to hand. Doing these exercises should make your reading of the book more productive and interesting – perhaps even enjoyable – than trying (in the wrong spirit) to absorb the material passively.

1

Sentence structure: constituents

Structure

The concept of **STRUCTURE** is fundamental to the study of syntax. But it is a very general concept that can be applied to any complex thing, whether it's a bicycle, a commercial company, or a carbon molecule. When we say of a thing that it is **COMPLEX** we mean, not that it is complicated (though of course it may be), but that

- (a) it is divisible into parts (called **CONSTITUENTS**),
- (b) there are different kinds of parts (different **CATEGORIES** of constituents),
- (c) the constituents are **ARRANGED** in a specifiable way,
- (d) that each constituent has a certain specifiable **FUNCTION** in the structure of the thing as a whole.

When anything can be analysed in this way, we say that it has **STRUCTURE**. In considering structure it is important to note that, more often than not, the constituents of a complex thing are themselves complex. In other words, the parts themselves consist of parts, which may in turn consist of further parts. When this is so we may speak of a **HIERARCHY** of parts and of **HIERARCHICAL STRUCTURE**.

It is obvious, for example, that a complex thing like a bicycle is not just a collection of randomly assembled bits and pieces. Suppose you gathered together all the components of a bicycle: metal tubes, hubs, spokes, chain, cable, and so on. Now try to imagine all the possible objects you could construct by fixing these components together. Some of these objects might be excellent bicycles, while others wouldn't remotely resemble a bicycle (though they might make interesting sculptures). And, of course, there would be intermediate cases, things which we would probably want to say were bicycles, if only because they resembled bicycles more than anything else.

So, only some of the possible ways of fitting bicycle components together produce a bicycle. A bicycle consists not just of its components but, much more importantly, in the **STRUCTURE** that results from fitting them together in a particular way.

When we turn to linguistic expressions, we find a similar state of affairs. Suppose you have a collection of words, say all the words in a dictionary. Can you imagine all the possible word-sequences you could construct by putting these words together? The possibilities are endless. Clearly not all the sequences would be acceptable expressions of English. And again, some would be odder than others. When a sequence of words fails to constitute a good expression in the language, I shall describe it as being *UNGRAMMATICAL* (OR *ILL-FORMED*) and mark it with an asterisk (*). Here are some examples:

[1a] *the nevertheless procrastinate in foxtrot

[1b] *disappears none girls of the students

[1c] *Max will bought a frying pans.

More subtle examples of ungrammatical sentences were given in the Introduction.

Ultimately, a full syntactic description of any language consists in explaining why some strings of words of the language are well-formed expressions and why others are not. Just how this ultimate (and very ambitious) goal might be attempted is discussed in Chapter 11. It is enough to say here that it could not be achieved without recognising structure. Just as the concept of structure was required in distinguishing between the bicycles and the would-be bicycles, so the concept of structure is essential in distinguishing between the strings of words that are well-formed expressions and those that are not.

We can use diagrams to show how things are analysed into their constituent parts. For instance, [2] says that a bicycle can be analysed into two wheels, a frame, a chain, handlebars, among other things (the dots mean ‘and other things’):

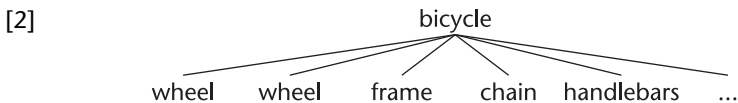

Such diagrams are called *TREE DIAGRAMS* (though the trees are upside-down).

I've mentioned that the constituents of a complex thing can themselves be complex. An example of this is a bicycle wheel. It is itself a constituent of the bicycle, but in turn consists of hub, spokes, rim, tyre, etc. Although it's true that spokes are constituents of bicycles, it's more important to note that they are constituents of bicycles only because they are constituents of the wheel which, in turn, is a constituent of the bicycle. The relation between spoke and bicycle is indirect, mediated by wheel. We might express this by saying that, although the spoke is a constituent of the bicycle, it is not an *IMMEDIATE CONSTITUENT* of it. It is important to recognise the indirectness of the relationship between bicycle and spoke because, in giving a description of the structure of bicycles, we need to be able to say that wheels are parts of bicycles. But if we allowed that spokes were immediate constituents of bicycles rather than of wheels, this would

leave wheels out of the picture. It would imply that bicycles could have spokes independently of the fact that they have wheels, and that spokes were not a necessary part of the structure of wheels.

As mentioned, specifying the FUNCTION of constituents is an important part of structural analysis. Notice that if we were to represent spokes as immediate constituents of bicycles, it would be impossible to specify correctly what the function of the spokes is. The spokes don't have a function in respect of the bicycle directly, but only in respect of the wheels. In talking of the function of the spokes, then, we're going to have to mention the wheels anyway.

Which of the following tree diagrams best represents the structural relationship between bicycle and spoke just discussed?

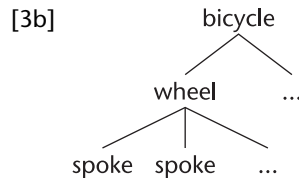
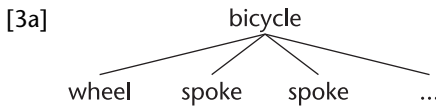

Although each tree diagram is incomplete, the one that more accurately reflects the structural relationship between bicycle and spoke is [3b], since it says that spokes are constituents of wheels, which are, in turn, constituents of bicycle. It correctly describes the relation between bicycle, wheel, and spoke as being a HIERARCHICAL relation. [3a], on the other hand, says that spokes are immediate constituents of bicycles, independently of the fact that wheels are constituents of bicycles.

This book is concerned with SYNTACTIC STRUCTURE – that is, with (a) analysing linguistic expressions into their CONSTITUENTS, (b) identifying the CATEGORIES of those constituents, and (c) determining their FUNCTIONS. But what kind of expressions should we begin with? I'll take the SENTENCE as the starting point for analysis. I'll assume (and in fact already have assumed) that you have an intuitive idea of what counts as a sentence of English.

The first question to be asked is, 'What do sentences consist of?' The answer might seem blindingly obvious: 'Sentences consist of words.' In the rest of this chapter (and, for that matter, the rest of the book), I'll try to convince you that this apparently natural answer is not the most appropriate one. In fact, the discussion of hierarchical structure and the importance of recognising that sentences have such structure forces us very quickly to abandon the idea that sentences consist, in any simple way, of words.

This can be shown by asking whether the relationship between a sentence and its words is direct or whether it is indirect, mediated by parts of intermediate complexity. This amounts to asking: 'Are words the IMMEDIATE CONSTITUENTS of the sentences that contain them?' It is only if the words

contained in a sentence are its immediate constituents that we can allow that sentences actually consist of words. As an aid to thinking about this question – and to gain practice in getting such diagrams to say what you want them to say – draw a tree diagram, starting with ‘Sentence’ at the top, which says of sentence [4] that its words are its immediate constituents, that it consists *directly* just of the words it contains. Having done that, ask yourself whether the diagram you have drawn gives an accurate representation of the structure of the sentence as you feel it to be.

[4] Old Sam sunbathed beside a stream.

The diagram that says of sentence [4] that its words are its immediate constituents looks like this:

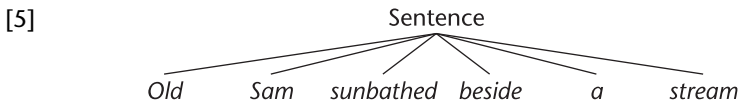

Do you feel that the diagram is wrong and/or unhelpful as a description of sentence [4]? How much does it tell us? Well, it tells us what words appear in the sentence. And in what order they appear. But nothing more. As well as being uninformative, the diagram is actually wrong as a description of the structure of the sentence. In essence, it says of sentence [4] **that it *has no structure – or no more structure than a sequence of numbers (1–2–3–4–5) or an ordered string of beads. This is surely wrong.***

In not allowing that the sentence has constituents that mediate between it and its words, the diagram doesn't allow that certain of the words seem to belong with others, that the words seem to work in groups. **It says that the words have no relationship to each other except the relationship of being in a certain order in the same sentence.** And, although the diagram tells us in what order the words occur, in failing to assign any but the simplest possible structure to the sentence, it fails to give any explanation of *why* they occur in that order to form a sentence, and why the orders in [6] and [7], for example, don't form sentences of English.

[6] *Stream old Sam sunbathed beside a

[7] *Sunbathed old beside stream a Sam

We need to say that sentence [4] is more highly structured than [5] says it is. As we saw in the discussion of bicycles, the position of a spoke in the structure of a bicycle is determined by its being a constituent of the wheel, which itself has a certain position within the bicycle. If you reposition the spokes from out of their structural position in the wheel, you land up with an unworkable bicycle. A very similar thing has happened in [6] and [7]. The position of words in a sentence is determined by the fact that the words are not immediate constituents of the sentence, but belong with other words to form groups – **PHRASES** – which

have their own position in the structure of the sentence. It is these phrases (and further phrases made up of these phrases) that function as immediate constituents of the sentence. **In short, while sentences certainly CONTAIN words, they don't CONSIST of words. They consist of phrases.**

In addition, we need to be able to say what kinds (or CATEGORIES) of words can combine to form structural groups. What's wrong with [6] and [7] is that words have been displaced from positions in which they are capable of forming phrases with the words next to them to positions where they are not, given the kinds of words they are. But the diagram gives no information of this sort. Such information is needed to account for the ungrammaticality of [6] and [7], but it is also needed if we want to explain why replacing *stream* with *road* yields another good sentence of English:

[8] Old Sam sunbathed beside a road.

but replacing *stream* with *laughing* or *surreptitiously* does not.

[9a] *Old Sam sunbathed beside a laughing.

[9b] *Old Sam sunbathed beside a surreptitiously.

Road can replace *stream* in [4] because *road* and *stream* belong to the same category: they are both nouns. *Laughing* and *surreptitiously* cannot replace *stream* because they aren't nouns; they belong to other categories (verb and adverb).

So we need to include information about GRAMMATICAL CATEGORIES in our diagrams and this is something we'll look at in later chapters, especially Chapter 3. Together with information on how the words group into phrases, this will help to explain not only the facts about [6]–[9], but also facts about the functions of words (and phrases) in sentences.

The discussion so far suggests that diagram [5] is actually wrong as a structural description of sentence [4]. As soon as we want to explain even the simplest things about sentences, it's necessary to go beyond the idea that sentences simply consist of words strung together in a line. We need to acknowledge that sentences have hierarchical structure.

Establishing constituents

I've been complaining in a rather general way about diagram [5]. What's needed now is a more specific demonstration of just how it is wrong. I won't give a complete analysis of sentence [4] here, but just a general introduction to the identification of constituents larger than the word.

Here's one way of clearly establishing that [5] is wrong. If the sentence had the same (lack of) structure as an ordered sequence of numbers, we should be able to lop words off the end of the sentence and still be left with a good sentence

every time we did so. We can lop numbers off the end of a number sequence and still be left with a good (though shorter) number sequence: 1–2–3–4–5, 1–2–3–4, 1–2–3, 1–2, 1. Begin by removing first one word and then another from the end of sentence [4] until you're left with just one word. Each time, write down the string that remains. In front of every string of words that seems to you *not* to constitute a COMPLETE AND GRAMMATICAL SENTENCE, put an asterisk.

Assuming we all speak the same language, you should have a list of five strings marked in the following way:

- [10] *Old Sam sunbathed beside a
- [11] *Old Sam sunbathed beside
- [12] Old Sam sunbathed
- [13] *Old Sam
- [14] *Old

Of the strings, only [12] could stand as a complete and well-formed sentence. [13] may not seem as odd as [10], [11], and [14] do, for reasons which will become apparent shortly. It should still be asterisked since it is not a complete sentence. What needs explaining is why string [12] is a good sentence while none of the others are.

In the first place, you should note that not all parts of a sentence are necessary in order for that sentence to be complete and well-formed. Consider [15].

- [15] Martha smiled.

[15] is a good sentence as it stands. But notice that we could add to it. For example, we could add the word *invitingly*, to produce another good sentence [16]:

- [16] Martha smiled invitingly.

In [16], then, we can say that *invitingly* is an OPTIONAL part of the sentence: leaving it out gives us another (though shorter) complete and perfectly grammatical sentence, namely [15]. By contrast, *Martha* and *smiled* are OBLIGATORY.

The importance of this here is that I've referred to *invitingly* as a part, as a constituent, of sentence [16]: I have said that it is an optional constituent. Of course, it's obvious that *invitingly* must be a constituent in sentence [16], since it is a word. But, to go back to sentence [4], we saw in [10]–[14] that we could omit the SEQUENCE OF WORDS *beside* plus *a* plus *stream*, leaving a perfectly good sentence. In other words, that SEQUENCE of words is optional. Notice, though, it's only the sequence as a whole, as a single unit, that's optional. None of the words in that sequence can be omitted individually – that's what *[10] and *[11] show. So, just as I needed to refer to the single word *invitingly* and say it was an optional constituent in the structure of sentence [16], so I need to be able to refer to the sequence of words [*beside* + *a* + *stream*] and say of it that – as a

unit – it is optional in the structure of sentence [4]. In doing so, I acknowledge that word-sequence as an identifiable part, as a constituent, of that sentence.

Sequences of words that can function as constituents in the structure of sentences are called PHRASES. Tree diagrams represent structure by marking which sequences of words in a sentence are its constituent phrases. So syntactic tree diagrams are, more specifically, called **PHRASE MARKERS**.

I have shown that the sequence of words *beside a stream* is a constituent of sentence [4]. So [*beside a stream*] is a phrase. Having recognised it as a phrase, we must treat its words as parts, not directly of the sentence, but of the phrase itself. This phrase is intermediate between the sentence and its words, just as wheels are intermediate between the bicycle and its spokes. Since we can't omit any of those three words individually, it appears that, while the PHRASE as a whole is optional in the structure of the sentence, the WORDS themselves are not optional in the structure of the phrase.

In sentence [17] below, there are two separate sequences of words which can be omitted without affecting the grammaticality of the sentence. Can you identify them?

[17] The very muscular gentleman next to me lit a cigar.

[18], [19], and [20] are all perfectly good, complete sentences.

[18] The (. . .) gentleman next to me lit a cigar.

[19] The very muscular gentleman (. . .) lit a cigar.

[20] The (. . .) gentleman (. . .) lit a cigar.

So we need to be able to say that *very muscular* (omitted in [18] and [20]) and *next to me* (omitted in [19] and [20]) are optional constituents in the structure of sentence [17]. But they are not sentences and they are not words. They are PHRASES – elements of structure intermediate between sentence and word. Furthermore, we will see in due course that these phrases are immediate constituents, not of the sentence, but of yet further phrases within the sentence. They are phrases within phrases.

If a sequence of words can be omitted from a sentence leaving another good sentence, that's a good indication that the sequence is a phrase functioning as a constituent in the structure of the sentence. However, not all phrases are omissible. So we need to find a more general, systematic way of demonstrating that a given sequence of words is a phrase.

There are several different ways of doing this. Recall that we were never in doubt that *invitingly* was a constituent in [16]. It is a single word, after all. And we wanted to say of the sequence of words *beside a stream* that it had the same unitary character as a single word. This suggests that **if you can replace a SEQUENCE OF WORDS in a sentence with a SINGLE WORD without changing the**

overall structure of the sentence, then that sequence functions as a constituent of the sentence and is therefore a phrase. This test will confirm that *beside a stream* is functioning as a constituent in sentence [4]. For example, if the speaker of sentence [4] were in a position to point to the spot where Sam sunbathed, she could replace *beside a stream* by *here* or *there*:

[21] Old Sam sunbathed here/there.

Or she could be less specific, by replacing *beside a stream* with *somewhere*.

[22] Old Sam sunbathed somewhere.

Questions offer a clear example of this. We can form a question from [4] by replacing *beside a stream* with the question word *where* as in [23] and [24]:

[23] Old Sam sunbathed where? [24] Where did old Sam sunbathe?

Since we have used *where* to replace *beside a stream*, it's natural that *beside a stream* should be a possible answer to the question. Answering such questions is a matter of replacing the question word with an informative phrase. So, answers to 'WH' questions (that is, questions that contain one of the question words *who*, *which*, *what*, *why*, *where*, *when*, *whose*, and *how*) are phrases.

All this justifies analysing *beside a stream* as a phrase. The question now is: How should we represent this phrase in terms of a phrase marker? As with the whole sentence, we need to know whether the words of the phrase are its immediate constituents, or whether it contains further phrases. There are just three phrase markers that could possibly represent the structure of *beside a stream*:

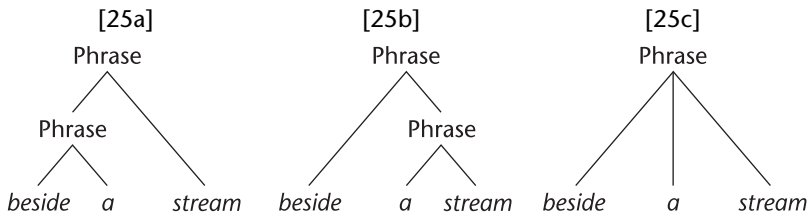

Each gives a different analysis. Which do you think is the best representation of the structure of the phrase? In coming to a decision, ask yourself whether *a* belongs more with *beside* than with *stream* ([25a]), more with *stream* than with *beside* ([25b]), or whether it doesn't seem to belong more with one than the other ([25c]). The question is: **Does the phrase *beside a stream* include a further phrase?** If it doesn't, then [c] is right. But if it does, then either [a] or [b] is right – and the question is: which?

Now check that the tests mentioned above, replacement by a single word and the question test, confirm the analysis you have chosen.

Phrase marker [25c] says that the phrase does not contain any further phrase, that the words themselves are the immediate constituents of the phrase. According to [c], *a* does not belong more with either of the other words. Now, if [25c] is correct, [a] and [b] should seem equally bad. Well, I hope you agree that [a] is REALLY bad. [a] suggests that we could find a single word to replace the supposed phrase *beside a*. It is difficult to imagine what word could replace that sequence. It seems incomplete and it's impossible to say what it means. On the other hand, *a stream* does seem complete, it is fairly clear what it means, and we don't have to rack our brains to find single words that could replace it – for example, *it*, *something*, or *one*. These yield good phrases: *beside it*, *beside something*, and *beside one*.

Notice, too, that if we were to change singular *stream* to plural *streams*, we would get the ungrammatical word-sequence **beside a streams* – unless we also omit *a* (to give *beside streams*). This strongly suggests that *a* belongs definitely with *stream* rather than with *beside*, that *a* is DEPENDENT ON *stream*. Here, again, we are using the single word *streams* to replace the sequence *a stream*.

The question test, too, confirms that *a stream* is a phrase:

[26] Question: [a] Old Sam sunbathed beside what?

[b] What did old Sam sunbathe beside?

Answer: A stream.

Notice that there is no question to which **beside a* would be a suitable answer.

[27] provides further evidence that *a stream* forms a phrase, since it has been moved as a unit in forming a new construction.

[27] *A stream* is what old Sam sunbathed *beside*.

It is worth noting, then, that **the MOVEMENT of a sequence of words in forming a construction indicates that the sequence is a phrase**. As a further example, note the acceptability of moving *beside a stream* to the beginning of sentence [4]:

[28] *Beside a stream*, old Sam sunbathed.

In short, the various kinds of evidence discussed confirm that [25b] is the correct representation of the structure of our phrase. It shows a phrase within a phrase.

As an exercise, think of some other possible answers to the *what* question in [26]. They can be as different as you like from the answer already given, and they can be as long as you like. Provided they do not sound ungrammatical, every sequence of words you choose will be a phrase.

Here are some suggestions:

[29a] a large pile of Bokhara rugs

[29b] the magnolia bush at the bottom of his garden

[29c] an unreliable puppy that was taking the occasional nip at his toes.

All these are phrases. They could all serve as answers to the *what* question, and they are all replaceable by a single word. Furthermore, they all contain further phrases.

Earlier, when we were considering whether there was a single word that could be used to replace the sequence *beside a*, I mentioned meaning and implied that **phrases form not only SYNTACTIC UNITS (constituents in the structural form of sentences) but also SEMANTIC UNITS. In other words, they form identifiable parts of the MEANING of sentences; they form coherent units of sense.** It is reasonable to ask what *beside a stream* and *a stream* mean, but it is not reasonable to ask what *beside a* means; it has no meaning.

Does the discussion so far suggest an explanation why [13] on page 11 seems more acceptable than those in [10], [11], and [14]? How, exactly?

I put an asterisk in front of [13] because it was not a complete SENTENCE. However, it is a complete PHRASE, and in this it contrasts with the other strings. *Old Sam* could be replaced by a single word – *he*, *someone*, or even just *Sam* – making no difference to the overall structure of the sentence. Furthermore, *old Sam* could be used as an answer to the question *Who sunbathed beside a stream?*, where I have replaced the sequence *old Sam* with the single 'WH' word *who*.

'Phrase' and 'constituent'

I have said that a PHRASE is a sequence of words that can function as a CONSTITUENT in the structure of sentences. The important word here is 'can'.

We have seen that *beside a stream*, *a stream*, and *old Sam* can function as constituents in sentence structure – and they do function as constituents in sentence [4] and many other sentences. They are therefore phrases. The fact that those word-sequences are constituents in sentence [4], however, doesn't mean they function as constituents of every sentence in which they appear. Here, as an obvious example, is a sentence in which the word-sequence *old + Sam* is definitely not a constituent:

[30] Though he was old Sam did regular press-ups.

This is clear when we try to replace that sequence with a single word:

[31] *Though he was *someone* did regular press-ups.

[32] *Though he was *who* did regular press-ups?

Out of the context of any particular sentence, *old Sam* is a phrase. It is a phrase of English because it *can* be a constituent of an English sentence. But that word-sequence is not a constituent of *every* sentence in which it appears. It is not a constituent of sentence [30], for example.

So: although *old Sam* is indeed a phrase, it's not a phrase that actually figures in the structure of [30]! As I mentioned in the Introduction, in a quite literal sense there's more to syntax, and to your own understanding of sentences, than meets the eye. Hierarchical sentence structure is really quite abstract. It is not there visibly on the page. It's in your head. **Your understanding of particular word-sequences is matter of how you structure them in your mind.** That is why syntax is interesting. And it is why we need to construct concrete phrase markers to represent this abstract mental structure.

Consider now sentence [33] and decide whether the sequence *a + stream + that + had + dried + up* is a constituent or not.

[33] Sam sunbathed beside a stream that had dried up.

That sequence of words would be a perfectly good answer to the question *What did old Sam sunbathe beside?* Furthermore, it's replaceable by a single word while preserving the overall structure of the sentence. So it is a constituent of [33]. And, just as with *a stream* in sentence [4], it forms a further phrase with *beside*. This further phrase can be represented as in [34]:

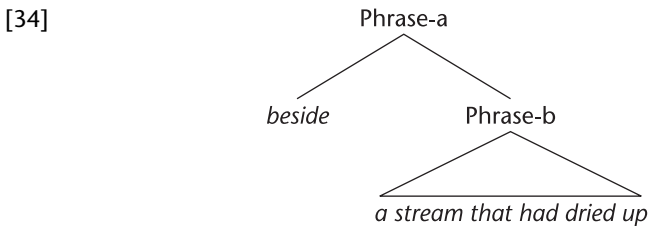

In [34] I have adopted the useful convention of using a TRIANGLE to represent a constituent when I am not concerned with its internal structure. For ease of reference, I have distinguished the phrases by letter.

The question I want you to consider now is this: Does the sequence *beside + a + stream* – which formed a constituent in sentence [4] – form a constituent in sentence [33]? And if not, why not? The phrase marker [34] should help you to answer this.

You have probably guessed that the answer is ‘No’: *beside + a + stream* is not a constituent in [33]. Why not? Well, we agreed that in [33]/[34] *a + stream* is part of a larger phrase, but that larger phrase is not *beside a stream* – it's *a stream that had dried up*. *Beside* forms a phrase, not with *a + stream*, but with the sequence *a stream that had dried up*. The words *a* and *stream* are part of PHRASE-b. If an element (word or phrase) is part of a phrase, it can only relate to other elements within that same phrase. If we wanted to say that *beside a stream* formed a phrase in [33], we would be forced to represent the complete phrase *beside a stream that had dried up* as in [35]:

[35]

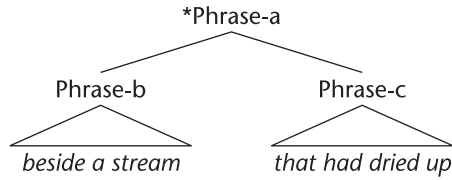

But [35] is wrong: it fails to represent *a stream that had dried up* as a phrase. The moral is that an element can belong directly only to one phrase at a time. I say ‘directly’ since in [34], for example, *a stream* belongs both to PHRASE-b (directly) and to PHRASE-a (indirectly). It is, in fact, impossible to draw a phrase marker that says of *a stream* that it simultaneously forms a phrase directly with *beside* AND with *that had dried up*.

You may be uncertain whether or not a given sequence of elements is represented as a phrase by a phrase marker. Before explaining this, I need to introduce some terminology that helps in finding our way around phrase markers. Here goes.

Any point in a phrase marker that could branch and bear a label is called a ‘**NODE**’. In phrase marker [34] there are two nodes, labelled ‘PHRASE-a’ and ‘PHRASE-b’. A node is said to **DOMINATE** everything that appears below it and joined to it by a line. Thus the node labelled ‘PHRASE-a’ dominates all the following elements: *beside*, PHRASE-b, *a*, *stream*, *that*, *had*, *dried*, and *up*. A node is said to **IMMEDIATELY DOMINATE** another element when there are no intervening elements. Thus PHRASE-a in [34] immediately dominates just *beside* and PHRASE-b. PHRASE-a dominates *stream* but it does not immediately dominate it, because the node labelled ‘PHRASE-b’ intervenes.

Using this terminology, I can now show how to decide whether a sequence of elements is represented as a constituent in a phrase marker. **In a phrase marker, a sequence of elements is represented as a CONSTITUENT if there is a node that dominates all those elements and no others.** In other words, if you can trace just the elements under consideration (i.e. ALL those elements and ONLY those elements) up to a single node, then those elements are represented as a constituent (a phrase).

Look at [34]. The sequence *a + stream + that + had + dried + up* is represented as a constituent because the elements (words, in this case) can all be traced back to a single node that does not dominate any other element, namely, PHRASE-b. The sequence *beside + a*, on the other hand, is *not* represented as a constituent because the only node that dominates both of those words (namely, PHRASE-a) dominates other elements as well (namely, *stream*, *that*, *had*, *dried*, and *up*). Similarly, in the incorrect phrase marker [35], *a stream that had dried up* is not represented as a constituent because there is no node that dominates all and only those words. The only node that dominates all of them is PHRASE-a, but PHRASE-a doesn’t dominate *only* those words, it also dominates *beside*.

I've given two examples in which a sequence of words functioning as a constituent in one sentence does not function as a constituent in another. Here, as a final example, is what is known as a STRUCTURALLY AMBIGUOUS sentence. On one interpretation, the sequence *old + Sam* does function as a constituent but on the other interpretation it doesn't:

[36] Heseltine asked how old Sam was.

Try to identify the two meanings of [36]. A good way of doing this is to decide on the exact question which Heseltine is reported in [36] to have asked. You may find it helpful to make a written note of the two questions.

Having identified the two meanings in the way suggested, you should not have much difficulty in deciding which interpretation demands that the sequence does form a constituent and which demands that it does not.

The two quite different questions that could have been asked by Heseltine are [a] *How old is Sam?* and [b] *How is old Sam?* As these different questions show, on the first interpretation, [a], *old* belongs with *how* to form the phrase *how old*. In this question, the phrase as a unit has been moved from its position at the end of the sentence (*Sam is how old?*). On this interpretation, since *old* forms a constituent with *how*, it simply cannot also form a constituent with *Sam*. It is on the second interpretation, [b], that *old* and *Sam* go together, forming a phrase. This example illustrates how deciding what phrases there are in the sentence is a crucial part of deciding what the sentence actually means.

Most people, when presented with a sequence of words out of the context of any sentence, have feelings as to whether that sequence could function as a constituent in a sentence (i.e. whether it is a phrase) – at least once they start thinking about it (as you are being encouraged to do here). It is usually simply a matter of deciding whether it seems to you to form a unit of sense. In the main, this is a reliable guide as to whether that sequence actually is a constituent in a sentence to be analysed, though, as we have seen from the last three examples, not one hundred per cent reliable. And, even in the context of a sentence, you will find that you do have an intuitive feeling as to which sequences are functioning as its constituents. In this chapter I have considered various kinds of evidence for constituents – omission, replacement by a single word, the question test, movement, the sense test. These are useful in confirming your intuitions, and in checking on cases where you are in doubt – one's first intuitions are not always strong and not always reliable.

Exercises

1. Look again at the discussion on page 17 above and then, on the basis of the tree diagram below, say which of the following sequences are constituents of A.

- (1) c + d. (2) a + b + c. (3) c + d + e + f. (4) e + f. (5) e + f + g + h.
 (6) g + h. (7) E + C. (8) D + E. (9) F + g + h.

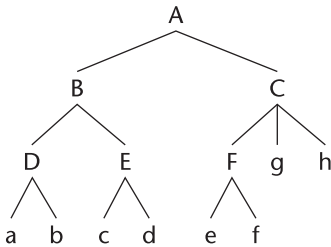

2. In tree diagram (a) above, what are the *immediate* constituents of:

- (1) A? (2) B? (3) C?

3. (a) Draw a phrase marker for the phrase *their rather dubious jokes* which shows that it contains the further phrase *rather dubious jokes*, which in turn contains *rather dubious* as a phrase.

(b) *Men from the Ministry* is a phrase which contains *from the Ministry* and *the Ministry* as phrases. Draw a phrase marker for the whole phrase.

4. Decide whether the italicised strings in the following sentences are constituents of those sentences or not. Note that (g) is ambiguous; as with the ambiguous example discussed in this chapter, you should identify the two interpretations and say on which interpretation the italicised sequence forms a constituent.

- (a) John considered *visiting his great aunt*.
 (b) Maria simply gazed *at the bollard she had just demolished*.
 (c) Maria simply gazed *at the bollard* she had just demolished.
 (d) *In the machine* the gremlin could be heard juggling with ball-bearings.
 (e) *In the machine the gremlin* could be heard juggling with ball-bearings.
 (f) Rory put *a silencer on the gun*.
 (g) Sam managed to touch *the man with the umbrella*.

5. In the light of the discussion of this chapter, how many constituents can you identify in sentence (a) given that the much shorter (b) is a grammatical sentence? (Don't attempt a complete analysis of sentence (a) – the fact that sentence (b) is well-formed doesn't provide enough information for that.)

- (a) Being of a cautious disposition, Timothy very wisely avoided the heavily built man whenever he drank at the Wrestler’s Arms.
 - (b) Timothy avoided the man.
6. I’ve not yet provided a complete analysis of sentence [4]. We have agreed that *old Sam*, *beside a stream*, and *a stream* are among its constituent phrases. So we can at least draw an incomplete phrase marker for it, as in (a):

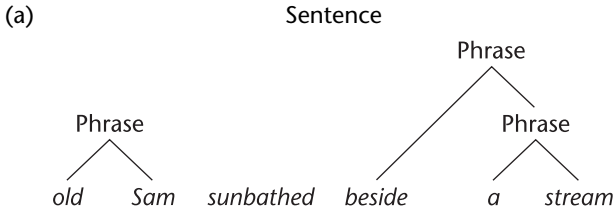

We know that the complete string constitutes a sentence. In a complete phrase marker, then, all the elements must be joined up to the Sentence node in some way. The question is: How? There are *three* ways in which this could be done. Each way offers a different analysis of the sentence – a different analysis of how *sunbathed* fits into the structure and a different account of the immediate constituents of the sentence. Draw the three different phrase markers and explain in words (using ‘constituent’ and ‘immediate constituent of the sentence’) what different claims are made about the structure of the sentence by each phrase marker. (Make sure the phrases we have already acknowledged remain represented as phrases in your complete phrase markers!) I’m not here asking you to choose which analysis you think is best – though I hope you have views on the matter. In fact, all three analyses have been proposed at one time or another, though one of them is most generally accepted these days and it is this that I shall adopt in the next chapter.

Discussion of exercises

1. (1) Yes. Both *c* and *d* – and only *c* and *d* – can be traced back to node *E*.
 (2) No. *D* dominates *a* and *b* but not *c*. Node *B* does dominate *a*, *b* and *c*, but it also dominates *d*; so there is no node that dominates all and only *a*, *b*, and *c*.
 (3) No. No single node that dominates all and only *c*, *d*, *e*, and *f*. Only *A* dominates them all, but *A* dominates *a*, *b*, *g*, and *h* too.
 (4) Yes. *e* and *f* (and only *e* and *f*) can be traced back to the single node *F*.
 (5) Yes. They alone can all be traced back to *C*.
 (6) No. (7) No. (8) Yes. (9) Yes.
2. (1) *B* and *C*. (2) *D* and *E*. (3) *F*, *g*, and *h*.

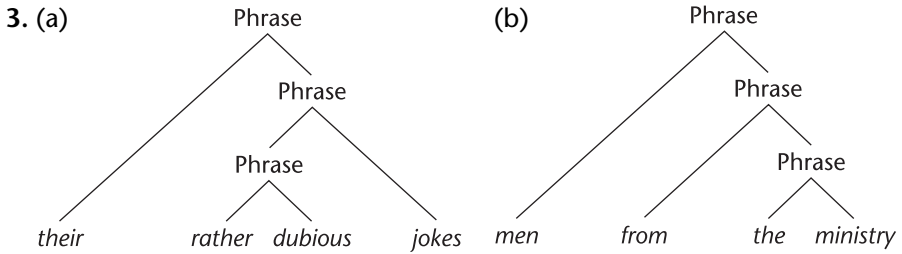

4. (a) Yes. It could be replaced by *it* and by *what* in forming the question *What did he consider?*, to which *visiting his great aunt* is a possible answer. (Note also that the sequence moves as a unit in forming the construction *Visiting his great aunt is what he considered.*)
- (b) Yes. (cf. *she simply gazed at it. What did she gaze at?* Answer: *the bollard she had just demolished.*)
- (c) No. In (b) above, the sequence *the + bollard* was shown to be part of the phrase *the bollard she had just demolished*; it cannot then form a constituent with *from*. (See the discussion of *beside a stream that had dried up* [33] in the chapter, pp. 16–17.)
- (d) Yes. It could be replaced by *there* or *somewhere*. Furthermore, *in the machine* is a good answer to the question **Where** could the gremlin be heard juggling with ball-bearings? Finally, the sequence could be omitted leaving a well-formed sentence.
- (e) No. There is no question that *In the machine the gremlin* could possibly be an answer to. *Who/What could be heard . . . ?* could receive *the gremlin* as a possible answer; *Where could the gremlin be heard . . .* could receive *In the machine*. Each of these, then, are phrases. But there is no single question word that covers both *where* and *what*. So here we have a sequence of phrases here but those two phrases don't make up a further phrase.
- (f) No. Consider the oddity of **Rory put it* and **Rory put something*. And the oddity of **What did Rory put?* (Answer: **A silencer on the gun.*)
- (g) On one interpretation the sequence is a constituent, cf. *Sam managed to touch him* and **Who** did Sam manage to touch? (Answer: *The man with the umbrella.*) On the other interpretation, it is not a single phrase but a sequence of two phrases. Cf. *Sam managed to touch him with an umbrella*, **Who** did Sam manage to touch with an umbrella? (Answer: *the man.*)
5. The fact that (b) is a well-formed sentence allows us to infer that every sequence of words omitted from (a) in order to form (b) can be counted as a constituent of (a). These are:

Being of a cautious disposition
very wisely
heavily built
whenever he drank at the Wrestler's Arms.

There are other constituents in the (a) sentence, of course, and the constituents listed here themselves contain further phrases as constituents.

6. Here are the three complete phrase markers. New bits are in bold.

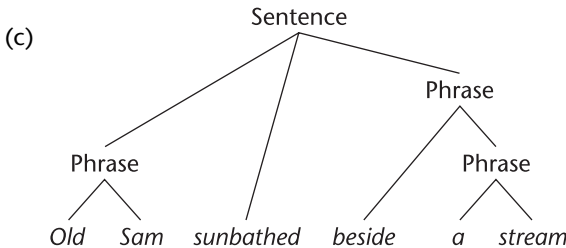
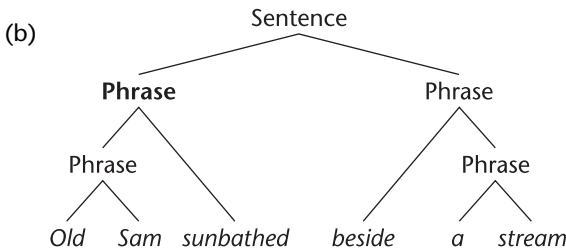
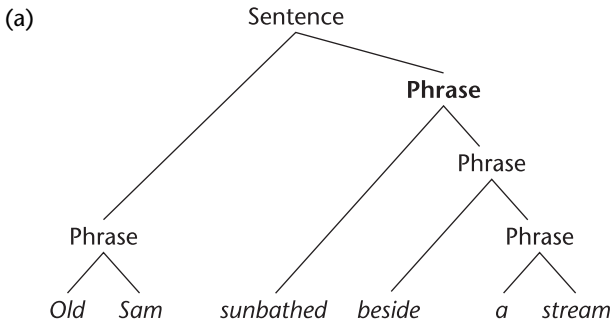

(a) represents *sunbathed* as forming a constituent with *beside a stream*, and divides the sentence into just two immediate constituents: *old Sam* and *sunbathed beside a stream*. (b) also divides the sentence into two, but this time the two parts are *old Sam sunbathed* and *beside a stream*. Phrase marker (c) represents the sentence as having three immediate constituents, *old Sam* and *sunbathed* and *beside a stream*; it says that *sunbathed* forms a constituent neither with *old Sam* nor with *beside a stream*.

In attempting to represent what phrase marker (a) represents, you may have been tempted simply to draw an extra line out from the phrase node dominating *beside a stream* as (d):

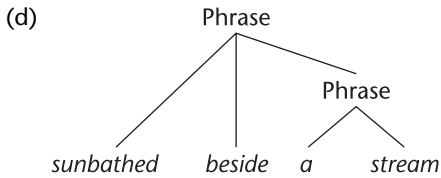

But (d) is incorrect. Can you see why? (Check the discussion on page 17.) Although it associates *sunbathed* with *beside a stream*, it fails to represent *beside a stream* as a phrase in its own right, independently of *sunbathed*. It fails to do this because there is no node that dominates all and only *beside + a + stream*. (The only node that dominates them all dominates *sunbathed* as well.) Check that you have not succumbed to a similar temptation in connection with (b).

Further exercises

- The structural ambiguity of [36] in the text is a matter of whether *old Sam* or *how old* is a constituent. All the following are structurally ambiguous. In each case, identify the source of the ambiguity in terms of two different constituent analyses, as I have just done with [36].
 - This story shows what evil men can do.
 - They only sell rotten fruit and vegetables.
 - More interesting meals would have been appreciated.
 - We need an agreement between workers on overtime.
 - Bill asked the man who he had seen.
- Draw a phrase marker for the phrase *no previous experience of syntax*, showing that it contains the phrase *previous experience of syntax* as a constituent, which in turn has the phrase *experience of syntax* as a constituent, which in turn has the phrase *of syntax* as a constituent (which, of course, is made up by *of* and *syntax*).
- The new students are very worried* is a sentence. Assume that it has two phrases as immediate constituents: *the new students* and *are very worried*. Furthermore, assume that *the new students* consists of the word *the* and the phrase *new students*. And that *are very worried* consists of the word *are* and the phrase *very worried*. Try drawing the phrase marker for the sentence in the light of all that.

2

Sentence structure: functions

As I pointed out at the beginning of Chapter 1, understanding the structure of a sentence involves more than knowing what its CONSTITUENTS are. It involves knowing the CATEGORY and the FUNCTION of those constituents. As you will see in this and the next chapter, these three aspects of syntactic analysis are closely bound up with one another. This chapter is mainly about syntactic functions, and about how function relates to category and constituency.

A systematic analysis is best begun, not by immediately considering the words contained in the sentence, but by first identifying the very largest phrases – those phrases which are immediate constituents, not of any other phrase, but of the sentence itself. So my first illustration of the relationship between constituents, their categories and their functions, will concern **the functions and categories of the immediate constituents of the sentence itself.**

Subject and predicate

To be sure of identifying only the very largest (immediate) constituents of the sentence I shall, wherever possible, divide the sentence into the fewest possible parts, i.e. into just two. An example of the simplest possible complete sentence structure is [1]:

[1] Ducks paddle.

Other such examples are: *Max coughed*, *Pigs fly*, *Empires decline*, and *Martha retaliated*. In all such cases, we have no option but to analyse the sentence as consisting of two parts, as in [2]:

[2]

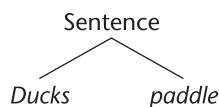

But what about more complicated sentences? A speaker's ability to recognise the structure of the sentences of his language is largely a matter of being able to

perceive a similar pattern across a wide range of apparently different sentences. Take [3], for example:

[3] The ducks are paddling away.

We want to say that [3] has the same general structure as [1]. By this I mean that it is divisible into two CONSTITUENTS in exactly the same way, that the two constituents are of the same general kind (or CATEGORY) as the corresponding constituents of [1]. Furthermore, they have exactly the same syntactic FUNCTIONS as those in [1] – in other words, the RELATION between them is the same.

Notice that, in asking which sequence of words in [3] corresponds to *ducks* in [1], we're asking which sequence of words in [3] could be replaced by the single word *ducks* while leaving a grammatical sentence. The answer can only be *the ducks*. Replacing that sequence by *ducks* yields the well-formed sentence *Ducks are paddling away*. In each of these sentences, both *ducks* and *the ducks* could be replaced by the same single word *they*. And the rest of [3] – *are paddling away* – can be replaced by the single word *paddle* (from [1]), giving the well-formed sentence *The ducks paddle*.

This exhaustively divides [3] into two parts, as in [4]:

[4] [The ducks] + [are paddling away].

The same division is shown in [5] and [6]:

[5] [Those gigantic ducks] + [were paddling away furiously].

[6] [The mouth-watering duck on the table] + [won't be paddling away again].

All these sentences ([1] – [6]) have the same general structure. They only differ at a lower (more detailed) level in their hierarchical structure. At the general level that concerns us here, they illustrate the same relation and the same functions. In making this first division, we have divided these sentences into two constituents, the first of which is traditionally said to function as SUBJECT, and the second as PREDICATE.

One way of thinking of these functions is to think of the subject as being used to mention something (e.g. the ducks) and the predicate as used to say something about the subject (e.g. that they were paddling away). The subject generally identifies what the sentence is about; the predicate identifies what's being said about it. This is usually a good way of identifying subject and predicate but, as we shall see below, there are sentences in which it doesn't work.

In Exercise 6 of Chapter 1, I raised the question of how *sunbathed* fitted into the structure of *Old Sam sunbathed beside a stream*, and offered three alternative analyses. Each analysis makes a different claim as to what the immediate constituents of that sentence are. On the basis of the discussion so far, can you

see which of those analyses is being adopted here? The answer is given in the footnote to this page.¹

Sentences can be a good deal more complicated than the ones we have looked at here. In fact, theoretically, there is no limit. If you're presented with a more complicated sentence and you're in doubt as to the correct subject~predicate division, a simple test can be applied:

Question test for subject:

Turn the sentence into a question that can be answered by 'yes' or 'no' (a *yes/no* question). The phrase functioning as subject is the one that changes its position when the sentence is so changed.

You may remember from Chapter 1 that the movement of a sequence of words in forming a construction shows that it is a constituent. This particular movement test confirms not only that *the ducks*, *those gigantic ducks*, and *that mouth-watering duck on the table* are constituents, but that they are functioning as the subjects of the sentences in which they appear:

┌──────────┐
└──────────┘
[7] • Are [the ducks] paddling away?

Now form the *yes/no* questions that correspond to [5] and [6].

You may find you intuitively know what the correct SUBJECT~PREDICATE division is without applying the question movement test. Even so, the test is important because it's actually part of the definition of what a 'subject' is. **It is the subject that changes position in 'yes/no' questions.** Here are the questions that correspond to [5] and [6].

[8] Were [those gigantic ducks] paddling away furiously?

[9] Won't [the mouth-watering duck on the table] be paddling away again?

The question test is essential in cases like the following:

[10a] It is snowing again. [10b] There is nothing to eat

In [10a] it is in fact impossible to think of the predicate (*is snowing again*) as being used to say something about what *it* mentions because it doesn't mention anything – it's an 'empty subject' (in technical terms, an 'expletive'). Notice that [10a] is not an answer to the question 'What is snowing again?', which is an odd question anyway. The same goes for *there* in [10b]: *there* doesn't mention

¹ It is analysis (a): Subject: [*Old Sam*] Predicate: [*sunbathed beside a stream*]. See also Further Exercise 3 in Chapter 1.

anything (it's an expletive). Nevertheless, *it* is the subject of [10a] and *there* the subject of [10b] precisely because those expressions change position in the corresponding *yes/no* questions:

[11a] • Is [it] snowing again? [11b] • Is [there] nothing to eat?

Using this test, identify the subjects of the following sentences:

- [12] Some nasty accident could have occurred.
 [13] The clown in the make-up room doesn't want to perform.
 [14] Elizabeth and Leicester are rowing on the river.
 [15] None of her attempts to give up chocolate were really serious.
 [16] As a matter of fact, the man you paid to do it has been arrested.

Examples [12]–[15] have the following subject~predicate structures:

- [12] [Some nasty accident] [could have occurred].
 (Could some nasty accident have occurred?)
 [13] [The clown in the make-up room] [doesn't want to perform].
 (Doesn't the clown in the make-up room want to perform?)
 [14] [Elizabeth and Leicester] [are rowing on the river].
 (Are Elizabeth and Leicester rowing on the river?)
 [15] [None of her attempts to give up chocolate] [were really serious].
 (Were none of her attempts to give up chocolate really serious?)

I included example [16] to show that the subject doesn't always begin the sentence. I hope you discovered this for yourself in applying the question test. The question that corresponds to this example is:

[16] As a matter of fact, has the man you paid to do it been arrested?

This identifies *the man you paid to do it* as the subject. The phrase *as a matter of fact* has not moved in forming the question, so it is not part of the subject. Since *as a matter of fact* belongs neither within subject nor within predicate, [16] is one sentence that cannot be exhaustively analysed into a two-part, subject~predicate structure. For the moment, I shall concentrate on sentences that can.

A temptation the question movement test will help you avoid is that of taking the first string of words that *could* be a subject as actually *being* the subject of the sentence you are considering. Look again at [13], [14], and [15]. [13] begins with the sequence *the clown*, [14] with *Elizabeth*, and [15] with *none of her attempts*. All these expressions *could* be subjects (see [17]–[19] below); however they are *not* the subjects of [13]–[15].

- [17] The clown refuses to perform.
 [18] Elizabeth excels at Real Tennis.
 [19] None of her attempts were really serious.

The temptation to identify less than the whole of the relevant phrase crops up in all constituent analysis. In the case of subjects, the question test helps. For example, if you take the subjects of [17]–[19] to be the subjects of [13]–[15], it is not clear how to form the appropriate questions, and all attempts to do so will result in ungrammatical sentences – gobbledegook, in fact. In [14], for example, it results in **And Leicester are Elizabeth rowing on the river?*

In general, taking less than the whole of the phrase will leave you with a residue that is not easily accounted for in structural terms. For example, in the above cases, if *the clown*, *Elizabeth*, and *none of her attempts* are taken to be the subjects of [13]–[15] respectively, the following strings are left as residues:

[20] in the make-up room doesn't want to perform

[21] and Leicester are rowing on the river

[22] to give up chocolate were really serious.

But, I hope you agree, these don't hang together as phrases, they don't form units of sense, and it is difficult to see what their function could be. They can't be predicates; we couldn't say, for example, that *to give up chocolate were really serious* is predicated as being true of *none of her attempts*.

In applying the question movement test to the following examples, you'll find that you have to modify it slightly. Form the yes/no questions that correspond to these examples.

[23] My new duck lays lightly boiled eggs.

[24] Elizabeth and Leicester excel at Real Tennis.

[25] The chiropodist fell in love with most of his patients.

As you will have discovered, the appropriate questions are formed by introducing a form of the verb *do*. For the purposes of this test, it is convenient to assume that *do* is introduced as in [26]–[28],

[26] My new duck *does* lay lightly boiled eggs.

[27] Elizabeth and Leicester *do* excel at Real Tennis.

[28] The chiropodist *did* fall in love with most of his patients.

and that the questions are formed from [26]–[28] by the now familiar movement of the subject (shown just in [29]), giving

[29] • Does [my new duck] lay lightly boiled eggs?

[30] Do [Elizabeth and Leicester] excel at Real Tennis?

[31] Did [the chiropodist] fall in love with most of his patients?

This difference between [12]–[16] and [23]–[25] is explained in Chapter 6.

Noun Phrase and Verb Phrase

So much, then, for the functions – subject and predicate – of the immediate constituents of the sentence. I'll return to the functions of constituents, in a more general way, later in the chapter. The question that now arises is: **What kinds – or CATEGORIES – of phrases function as subjects and as predicates?** We have seen that such phrases can vary widely in their form and complexity. Nevertheless, all the SUBJECTS we have looked at have one thing in common: they all contain, and are centred on, the same CATEGORY of word: NOUN. They are all NOUN PHRASES (NP). The single words that can replace them are all NOUNS or PRONOUNS. The phrases functioning as PREDICATES, on the other hand, all contain, and are centred on, a VERB. They are all VERB PHRASES (VP). Predictably, they are all replaceable by single-word VERBS. For example, *the ducks* and *those gigantic ducks* are Noun Phrases centred on the Noun *ducks*. *The clown in the make up room* is a Noun Phrase, centred on the Noun *clown*. Don't worry if you're unsure which words are nouns or verbs at this stage. You'll get a rough idea indirectly during the course of this chapter and we'll look properly at categories in the next chapter. You can assume that **any phrase that can function as a subject is a Noun Phrase**.

You might ask: **Why do we need to distinguish between the CATEGORY and the FUNCTION of a constituent?** We need to do this because most categories of phrase have a variety of different functions. Although we're assuming subjects are always Noun Phrases, this doesn't mean that all Noun Phrases function as subject. For example, the Noun Phrase *the chiropodist* was functioning as subject in [25], but in [32] it is not:

[32] The pianist has rejected the chiropodist.

Notice that it does not change position in the yes/no question *Has the pianist rejected the chiropodist?* Here it's *the pianist* that has moved. *The chiropodist* is here part of the predicate *rejected the chiropodist*. It's a constituent of the Verb Phrase and has a function other than subject within that VP – a function we'll look at in Chapter 4.

Below is a list of phrases. Some are Noun Phrases, some are Verb Phrases and some are phrases belonging to categories not yet introduced. Identify the phrases – as Noun Phrase, Verb Phrase, or 'other' – by combining them (just two at a time) and seeing which combinations make well-formed sentences of subject (NP) + predicate (VP).

- (a) remind me of you
- (b) as quickly as he could
- (c) soggy chips

- (d) pamphlets advertising new syntactic theories
 (e) by the end of this week
 (f) suddenly rained from the sky
 (g) are in demand.

The only well-formed subject~predicate combinations are:

(c) + (a), (c) + (f), (c) + (g), (d) + (a), (d) + (f), and (d) + (g).

Since (c) and (d) can function as subjects they are NPs. (a), (f), and (g), which can function as predicates, are all VPs. (a) is centred on the verb *remind*, (f) is centred on the verb *rained*, and (g) is centred on the verb *are*. As for (b) and (e), they don't combine, in any order, with any of the other phrases nor with each other, so they belong to categories other than NP and VP.

We can now include information about the categories of the immediate constituents of the sentence in a phrase marker, by labelling the appropriate nodes, as in [33]:

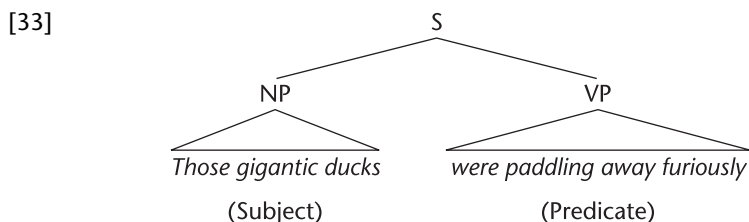

The diagram has the obvious interpretation: the sequence *those gigantic ducks* forms a constituent belonging to the category Noun Phrase; the sequence *were paddling away furiously* forms a constituent belonging to the category Verb Phrase; the NP and the VP together form a sentence (S).

Since I have been concerned only with the general structure of the sentence (that is, just with the immediate constituents of the sentence itself) I've used triangles for NP and VP to avoid giving further details about their internal structure. And because I have not entered into any detail beyond identifying the subject and the predicate, the phrase marker in [33] serves as a partial analysis of all the sentences considered in this chapter – with the exception of [16], which, for reasons already given, is a special case.

A point to note about [33] – and phrase markers in general – is that a **specification of the FUNCTIONS of the constituents (given in brackets in [33]) is not strictly part of the phrase marker, and is not normally included.** This is because the functions of constituents follows directly from other information already contained in the phrase marker – information about category and position. Thus:

The **SUBJECT** of a sentence is the NP that is immediately dominated by S.

The **PREDICATE** of a sentence is the VP that is immediately dominated by S.

This definition of subject in terms of the phrase marker will confirm that *the chiropodist* is not the subject of [32]. Here's the phrase marker.

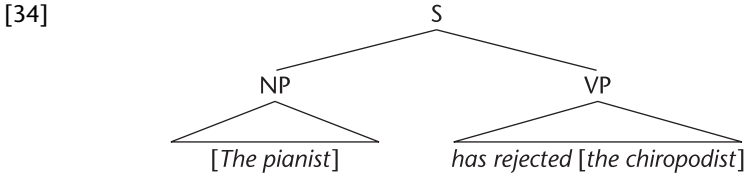

In [34] there are two NPs, *the pianist* and *the chiropodist*, but only the first of those is immediately dominated by S. So the NP *the pianist* is the subject. The NP *the chiropodist* is not immediately dominated by S because the VP node intervenes between it and S. Hence, by the above definition of subject, it is not the subject.

As mentioned, categories are discussed in more detail in the next chapter. What's important here is for you to see how the parts of a sentence can be expected to function in relation to each other. Without the idea of subject function and predicate function, it would be difficult to know where to begin the analysis of a sentence. In giving an analysis of a sentence, you should always satisfy yourself that any constituent you wish to say is contained in the sentence has a well-defined function and meaning. This goes not only for the immediate constituents of S but for all constituents. So I will generalise the discussion a little.

Dependency and function

In discussing the functions of constituents, we need some terminology to describe relationships between them. When two constituent nodes are immediately dominated by the same single node, as is the case with B and C in [35],



they are said to be **SISTERS**. As you might guess, since B and C are sisters in [35], they are the **DAUGHTERS** of A, the node that immediately dominates them. And A is the **MOTHER** of B and C. Fanciful perhaps – but easily remembered!

It is the relationship of sister that concerns us here. **SISTER** constituents are represented at the same level of structure in phrase markers. **Constituents have their FUNCTIONS in respect of their SISTER constituents.** Thus, in each of the sentences considered so far, the subject NP and the predicate VP are sisters and

as such are represented at the same level of structure. The NP (e.g. *the ducks*) has its subject function in respect of its sister, the VP (e.g. *are paddling away*). And the VP has its predicate function in respect of the subject NP. Notice that **subject and predicate are dependent on each other**. An NP only functions as a subject in the presence of a sister VP, and a VP only functions as predicate in the presence of a sister NP. The two of them together are required to form a complete sentence; neither can be omitted in a complete and well-formed sentence. **They are both OBLIGATORY in the structure of sentences.**

Anticipating later chapters, let's take a first look at the other main functions. There are three general concepts here. These are **HEAD**, and the two functions that other elements have in relation to heads, **MODIFIER** and **COMPLEMENT**.

■ Head

The **HEAD** of a phrase is the element that the phrase is **CENTRED ON**. It is the one essential – or **OBLIGATORY** – element in that phrase. **If you think of the phrase as a solar system, then the head is the sun. Everything else in the phrase revolves around and depends on the head.** Just as a system is a *solar* system because it's centred on a *sun*, so a phrase is *Noun* Phrase because it's centred on a *Noun*. Similarly for *Verb* Phrase. So: **it is the category of the head of a phrase that determines the category of the phrase.**

■ The modifier~head relation

Consider the structure I assigned to *their rather dubious jokes* in Exercise 3 of Chapter 1. (Since I am concentrating on the relationship between constituency and function, I've omitted the category labels which would be required for a complete analysis of the phrase.)

[36]

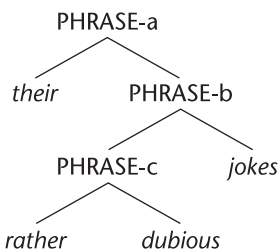

Make a list of all the sister relationships in that phrase.

There are three sister relationships in [36]: (1) between *their* and PHRASE-b (*rather dubious jokes*), (2) between PHRASE-c (*rather dubious*) and *jokes*, and (3) between *rather* and *dubious*. The relation that holds between these sister constituents is of the same general kind, that of **MODIFICATION**.

To begin at the lowest level of structure, *rather* has its function in respect of its sister *dubious*. It specifies the degree of the dubiousness, telling us how dubious the jokes are. *Rather* is DEPENDENT on *dubious*, in the sense that it is only present because *dubious* is. Were we to omit *dubious*, *rather* would be left without any function, and the omission would result in an ill-formed string (**their rather jokes*). Notice, however, that *dubious* is in no way dependent on *rather*. We can omit *rather* and still be left with a perfectly good phrase (*their dubious jokes*). This, then, is a ONE-WAY FUNCTION/DEPENDENCY. *Rather* depends on *dubious* but not vice-versa. This function is called MODIFICATION. The function of *rather* is to modify *dubious*.

What about the function of *dubious* itself? You may have guessed – from the above discussion of heads – that *dubious* is the head of *rather dubious*. I hope this seems right to you in the light of what you now know about heads. Whatever the category of *dubious*, that's going to be the category of the phrase *rather dubious*. (For information – but don't worry about it now if you didn't already know – *dubious* is an adjective.)

The big difference between modifiers and heads, then, is this: in the structure of a phrase, modifiers are OPTIONAL; the head is the OBLIGATORY element.

A MODIFIER~HEAD relation also holds, at the next (higher) level of structure, between the whole phrase *rather dubious* and the word *jokes*. *Rather dubious* specifies the character of the jokes. Again, *rather dubious* as a whole is a DEPENDENT MODIFIER of *jokes* but not vice-versa. *Rather dubious* is optional since it could be omitted (giving *their jokes*), but *jokes* – the head of the phrase – could not be omitted (**their rather dubious*).

Rather dubious jokes, then, forms a phrase but it does not tell us which *rather dubious jokes* are being referred to. It is the function of *their* to specify this. At this highest level of structure in the phrase, *their* is dependent on *rather dubious jokes*. Since *their* is dependent on *rather dubious jokes* but not vice versa, I shall treat the relation between them as yet another example of the modifier~head relation.

A useful way of picturing the functional relations in [33] is given in [37], where the direction of the dependencies is indicated by an arrow, and the functions by M (Modifier) and H (Head):

[37]

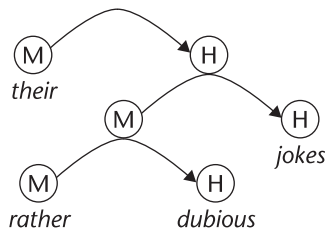

As [37] shows, not just words but also phrases can function as heads and as modifiers.

Now that the functions of these constituents have been specified, [36] should appear as a natural analysis. Compare it with the incorrect (*) analyses in [38] and [39]:

[38]

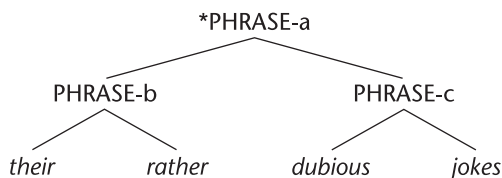

[39]

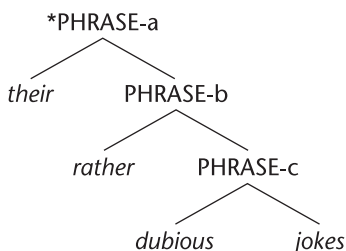

Both these analyses should now strike you as odd. *Their* and *rather* both belong to categories that have modifying functions. They cannot themselves function as the head of a phrase. So they can't have their functions in respect of each other – they can't both be heads and can't modify each other. **In a phrase, there can only be ONE head.** But in [38], *their* and *rather* are represented as sisters, forming a phrase. The fact that this supposed phrase (**their rather*) doesn't have a well-defined meaning – and couldn't be the answer to any question – is thus quite predictable. Notice that, since constituents function in respect of their sister constituents, *rather* in [38] is completely cut off from the element (*dubious*) that it wants to modify.

[39] is marginally better, but still wrong. Before reading further, decide for yourself in the light of the preceding discussion exactly in what respect it is better than [38], and exactly in what respect it is still not as good as [36].

[39] is better than [38] in that *their* is correctly represented as a (modifying) sister of PHRASE-b (*rather dubious jokes*). [39] is still wrong, though, because it represents *rather* and *dubious jokes* as sisters, so that *rather* is now modifying, not just *dubious*, but the phrase *dubious jokes*. But we saw earlier that *rather* is dependent on (and belongs with) just *dubious*. *Rather* has to do with the dubiousness of the jokes, not the jokes themselves. The original analysis of PHRASE-b (given in [36]) correctly predicts that the string *rather dubious jokes* corresponds in meaning with the phrase given as [40]:

[40] *jokes which are rather dubious.*

By contrast, the oddity of PHRASE-b in [39] is due to its predicting that *rather dubious jokes* corresponds in meaning with the ungrammatical [41]:

[41] **dubious jokes* which are *rather*.

By the way, *dubious jokes* is another example of a word-sequence that forms a phrasal constituent in some contexts but not in others. We have seen that, in the context of *rather*, we need to relate *rather* and *dubious* to each other before relating the whole phrase *rather dubious* to *jokes*. So *dubious* and *jokes* don't form a constituent in the context of *rather*. In the absence of *rather* (or any other modifier of *dubious*), on the other hand, there is no reason why *dubious* and *jokes* should not form a constituent, as they do in the phrase *their dubious jokes*.

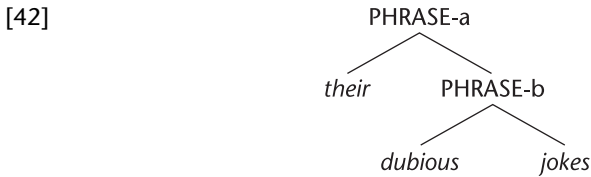

■ The head~complement relation

We have now looked at the **two-way function/dependency of subject and predicate** and several examples of the **one-way function/dependency of modifier and head**. Now look again at the phrase *beside a stream* (from the sentence *Old Sam sunbathed beside a stream*) in the light of the discussion in this chapter. Do you recall the structure of the phrase? Draw the phrase marker. How many sister relations are there in the phrase?

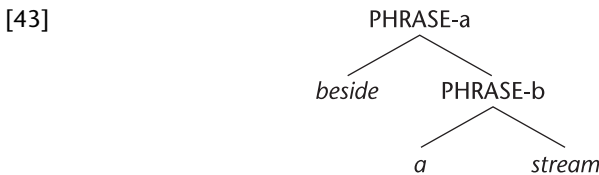

There are two sister relations: (1) at the lowest level of structure, between *a* and *stream*, and (2), at the next level up, between *beside* and PHRASE-b (*a stream*). In the last chapter I showed that *a* is dependent on *stream* and has its function only in respect of *stream*. So, *beside* and *a* don't relate to each other either syntactically (that is to say, in terms of constituency or function) or semantically (they don't form a unit of sense). But what kind of relationship holds between *beside* and PHRASE-b (*a stream*)? Try to determine whether the relationship is a TWO-WAY DEPENDENCY (both elements obligatory) or whether it is an example

of the ONE-WAY DEPENDENCY OF (OPTIONAL) MODIFIER AND (OBLIGATORY) HEAD. You will need to consider the phrase in the context of its sentence.

The way to do this is to see if either of the constituents of the phrase can be omitted individually in the context of the sentence. In fact, neither can be omitted. Both [44] (with *beside* omitted) and [45] (with *a stream* omitted) are ungrammatical:

[44] *Old Sam sunbathed a stream

[45] *Old Sam sunbathed beside

Although the whole phrase could be omitted from the sentence *Old Sam sunbathed beside a stream*, giving *Old Sam sunbathed*, neither of the constituents of *beside a stream* can be omitted individually. It seems that *beside* calls for – requires – the presence of a phrase like *a stream* and that *a stream* depends on the presence of *beside*. It is therefore a two-way dependency; both elements are obligatory in the structure of the phrase *beside a stream*.

That phrase tells us WHERE the sunbathing took place. It specifies a LOCATION. The location of a thing or an activity is usually expressed by orientating it in space (or time: *after the storm*, *before seven o'clock*) in relation to some other thing, activity, event, or time. We can't express a location just by means of *beside*; we have to specify beside WHAT. Although *beside* and *a stream* are both needed to express the spatial orientation in this case, it is clearly the word *beside* that is giving the phrase as a whole its LOCATIONAL character. So *beside* is the head of the phrase. Now, just as Noun Phrases are named after – have the same category as – their heads (Nouns), we will be naming the whole phrase *beside a stream* after the category of the word *beside*. This is dealt with in the next chapter.

We have seen that, unlike the modifier~head relations considered earlier, the relation between *beside* and *a stream* is a two-way dependency, with both obligatory. So we need to distinguish between the function of elements that relate to a head in a one-way dependency (i.e. as modifiers) from the function of elements that relate to a head in a two-way dependency. **When a head DEMANDS a further expression, that further (OBLIGATORY) expression is said to COMPLEMENT the head.** *A stream* functions as the complement of *beside*. Notice that *a stream* doesn't tell us something about the head (*beside*) as modifiers do. What we have here, then, is not the functional relation of MODIFICATION, but the functional relation of COMPLEMENTATION.

Complements typically follow their heads in English. Modifiers can precede or follow their heads, though so far I've only given examples of modifiers preceding their heads.

Beside a stream illustrates both these general kinds of dependency. If we were to give a graphic representation of the functional dependencies in that phrase, the mutual dependency of head (H) and complement (C) could be represented by a double arrow as in [46]:

[46]

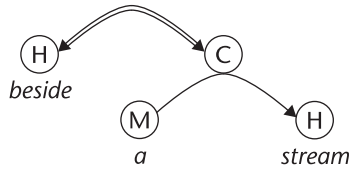

Now look at [47].

[47] Phil dreads affectionate cats.

It's a sentence – so, overall, it's an example of the subject~predicate relation. But its predicate includes both a relation of modification and a relation of complementation. Before reading further, first identify the subject and predicate and then try to identify the modifier~head relation and the head~complement relation within the predicate.

Phil is the subject and [*dreads affectionate cats*] is the predicate. Within the predicate, *affectionate* can be omitted (*Phil dreads cats*), so it must be a modifier. It's clearly telling us about the cats. So it's modifying *cats*. *Cats*, then, is the head of the phrase [*affectionate cats*]. Now for the relation between *dreads* and [*affectionate cats*]. I hope you agree that neither can be omitted. Neither **Phil affectionate cats* nor **Phil dreads* is a well-formed sentence. This suggests that the relation between *dreads* and [*affectionate cats*] is a (two-way) head~complement dependency. Since heads precede their complements in English, *dreads* must be the head and [*affectionate cats*] the complement. There is a more important reason for thinking that *dreads* is the head. You now know that, as the predicate of the sentence, [*dreads affectionate cats*] is a Verb Phrase and must therefore have a Verb as its head. If you didn't already know, *dreads* is a verb (this is discussed properly in Chapter 4). These functional dependencies can be represented as in [48]:

[48]

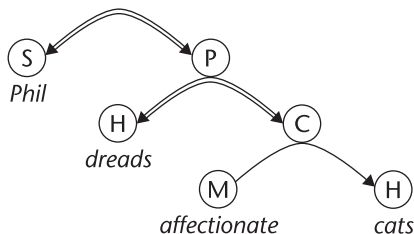

With this example, and throughout the chapter, I have aimed to show how constituency, function, and meaning are interrelated. Giving appropriate analyses of sentences in terms of their constituents depends on how you actually understand those sentences. Constructing the phrase marker of a sentence involves giving an explicit graphic representation of what you intuitively know about that sentence. The meaning of a sentence depends not just on the meaning

of its words, but on how those words are structured into phrases, and on the functions of those words and phrases. If you insist that each sequence of words that you want to say forms a constituent has a well-defined meaning and function (is a phrase), that's a good starting point for analysis.

Summary

Constituents have their functions in respect of their sisters.

There are three kinds of functional relation between sisters:

Subject~Predicate. The functional relation between the immediate constituents of sentences, Noun Phrase (NP) and Verb Phrase (VP).

It is a mutual (two-way) dependency – S and P are both obligatory.

S precedes P.

Modifier~Head. This is a one-way dependency: modifiers depend on heads.

Modifiers are optional (omissible).

Some modifiers precede and some follow the heads they modify.

Head~Complement. A two-way dependency.

Complements are obligatory, needed to complete the meaning of the phrase.

The head generally precedes its complement.

Heads. The head is the obligatory centre of its phrase.

Every phrase has a head and no more than one head.

The category of the head determines the category of the phrase.

Exercises

- Identify the subjects and predicates of the following sentences. Remember to apply the question movement test in cases of uncertainty.
 - No one has ordered my lovely prune-and-spinach fritters.
 - Her memory for names was a constant source of amazement to him.
 - There are too many uninvited guests here.
 - Only six of the domino-toppling contestants came properly equipped.
 - It was Lydia who finally trapped the pig.
 - The fact that you received no birthday greetings from Mars doesn't mean it is uninhabited.
 - That evening, Laura learned the Health and Safety Regulations by heart.
- Identify the category of the following phrases (as Noun Phrase, Verb Phrase, or 'other').

- (a) installed for only £199.95
- (b) were being given away
- (c) too far to drive in a day
- (d) obsolescent washing machines
- (e) ten long holidays at the Hotel Mortification
- (f) which I had bought only the day before
- (g) have made me realise that 'cheap' does indeed mean 'nasty'.

3. The phrase *more exciting ideas* is ambiguous and needs a different structural analysis for each of its two interpretations. Draw the phrase markers, giving an indication of which interpretation goes with which analysis.

4. Draw phrase markers for the following phrases:

- (a) young car salesmen; (b) second-hand car salesmen.

5. The phrase *the old Romanian history teacher* has several different interpretations. Here are three structural analyses.

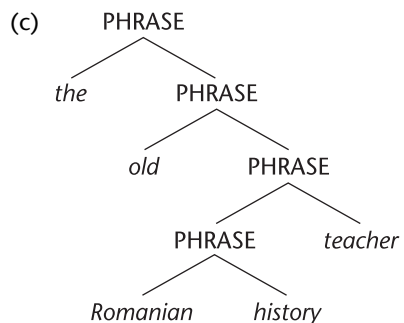
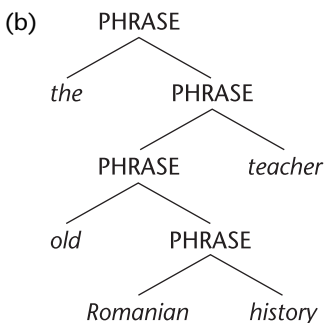
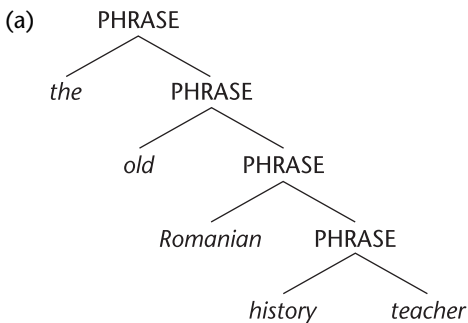

- (1) Which analysis corresponds with the interpretation 'the old teacher of Romanian history'?
- (2) Give the interpretations that correspond with the other analyses.

- (3) 'The history teacher from Old Romania' is an unlikely interpretation. Nevertheless, it is possible to construct a phrase marker that would impose that interpretation on the phrase. Draw the phrase marker.

6. Decide on the functions of the bracketed constituents in the following sentences.

- (a) Old Sam sunbathed [beside a stream].
 (b) The [well-built] gentleman offered me a cigar.
 (c) People [in running kit] are coming in all directions.
 (d) People in [running kit] are coming from all directions.

To answer this properly, you should not only state the function of the constituent but also indicate in respect of what other constituent it has that function. As mentioned in this chapter, you'll find this much easier if you first make sure you know the general structure of each sentence (i.e. that you can identify the subject NP and the predicate VP). First decide whether the bracketed constituent belongs within the subject or the predicate. Since constituents have their functions in respect of *SISTER* constituents, a constituent within the subject can only relate to other constituents within the subject, and a constituent within the predicate to other constituents within that predicate.

7. We have now looked at several of the dependencies in the sentence *Old Sam sunbathed beside a stream*. From Exercise 6(a) above you should have discovered the function of *beside a stream*. All that remains is to decide on the function of *old*. Do that, and then give a complete representation of all the dependencies in that sentence. Use single and double arrows and M for modifier, H for head, C for complement, S for subject, and P for predicate (as in [48] in the text).

Discussion of exercises

1. (a) [No one] [has ordered my lovely prune-and-spinach fritters].
 (b) [Her memory for names] [was a constant source of amazement to him].
 (c) [There] [are too many uninvited guests here]. As mentioned in the chapter, *there* doesn't mention anything. Nevertheless, the question movement test gives a clear result: cf. *Are there too many uninvited guests here?*
 (d) [Only six of the domino-toppling contestants] [came properly equipped]. If you applied the question movement test with this one, you would have had to supply a form of the verb *do*: *Did only six of the domino-toppling contestants come properly equipped?*
 (e) [It] [was Lydia who finally trapped the pig]. As in (c) above, *it* is an empty subject, but it undergoes movement in the question (cf. *Was it Lydia who finally trapped the pig?*).

- (f) [The fact that you received no greetings from Mars] [doesn't mean that it is uninhabited].
- (g) This is an example where the subject does not begin the sentence. *That evening* is not part of the subject. So:
[Laura] [learned the Health and Safety Regulations by heart].

2. The following are the only well-formed subject-predicate combinations: (d) + (b); (d) + (g); (e) + (b); (e) + (g). Since they can function as subjects, (d) and (e) are the NPs; (b) and (g), functioning as predicates, are the VPs. (a), (c), and (f) belong to other categories.

3. One interpretation (a) is equivalent to that of 'more ideas that are exciting'. The other (b) corresponds with 'ideas that are more exciting'. On both interpretations, the syntactic function of *more* is that of a modifier (notice that it can be omitted). The difference in interpretation is a matter of whether *more* modifies just *exciting*, as in (b) or *exciting ideas* (that is, *ideas*, which happens to be modified by *exciting*), as in (a). The two phrase markers are:

for (a)

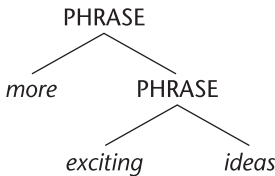

for (b)

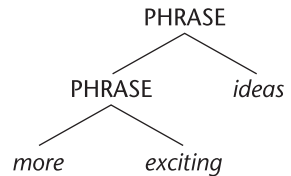

4. (a) Since people (salesmen, for example) but not things (cars, for example) can be described as 'young', *young* must modify a constituent that has *salesmen* as head. It cannot modify *car* and hence cannot form a constituent with *car*. The natural phrase marker, then, is:

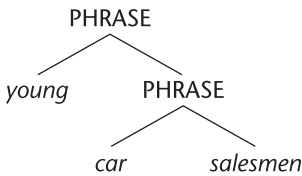

(i.e. 'young salesmen of cars',
not 'salesmen of young cars')

(b) Things, but not people can be second-hand, so *second-hand* must modify (and hence form a constituent with) *car*, rather than any constituent having *salesmen* as its head.

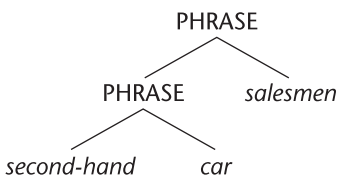

(i.e. 'salesmen of second-hand cars',
not 'second-hand salesmen of cars')

5. (1) Phrase marker (c). This should be clearer after the following discussion.
- (2) In diagram (a) *Romanian* modifies a phrase (*history teacher*) which has *teacher* (modified by *history*) as its head, so it is the (history) teacher that is Romanian, not the history. The same goes for *old*: it modifies a phrase (*Romanian history teacher*) which has *teacher* as its head. So, again, it is the teacher who is old. The interpretation can be expressed as ‘the old teacher of history who comes from Romania’. In diagram (b), *Romanian* is the sister, and hence the modifier, of *history*. Here it is the history that is Romanian, not the teacher. And *old* modifies a phrase that has *history* as head, so again it is the (Romanian) history that is old, not the teacher. So the interpretation is ‘the teacher of old Romanian history’.

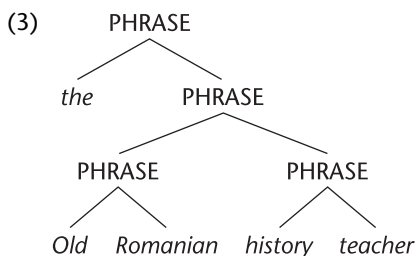

6. (a) You know that the sentence is divided into subject and predicate as follows: [Old Sam] [sunbathed beside a stream], so *beside a stream* must have its function in respect of its sister within the predicate VP, *sunbathed*. We have already noted that it's optional and that it specifies something about the sunbathing, namely its location. So the function of *beside a stream* is that of modifier of *sunbathed*. This is our first example in which the modifier follows the head.
- (b) *Well-built* is a constituent in the structure of the subject NP *the well-built gentleman*, so it must have its function in respect of either *the* or *gentleman*. *Well-built gentleman* seems to form a unit of sense, unlike *the well-built*. In fact, the structure of this phrase is almost identical to that of *their rather dubious jokes* (which, incidentally, is also a Noun Phrase – as you may have already noticed). *Well-built* corresponds structurally with *rather dubious*. So the function of *well-built* is that of modifier of *gentleman*.
- (c) It should be clear that *people in running kit* is the subject NP. *In running kit* must therefore have its function in respect of *people*. It is also optional in that NP (*people are coming from all directions* is a well-formed sentence). By contrast, *people* is obligatory. So *people* must be the head of that NP (indeed, *people* is a Noun); *in running kit* is the modifier of that head. This is another example of the modifier following the head of the phrase.
- (d) Notice that neither *in* nor *running kit* can be omitted individually: **people running kit are coming from all directions*; **people in are coming from all directions*. This indicates that *running kit* is required to complete the meaning of *in* and that *running kit* is only present because *in* is. We have here the mutual

dependency of complementation, and – as usual in complementation – the second constituent (*running kit*) is said to complement the first (*in*), which is the head. This is the same category of phrase as *beside a stream*. See the next chapter.

7. It has already been shown that *old Sam* is the subject NP in this sentence and that *old* is omissible. Furthermore, *old* gives us further information about Sam. So *old* is functioning as a modifier of *Sam*, the head of the NP. In addition, as you discovered in Exercise 5, the function of *beside a stream* is to modify *sunbathed*. Integrating these and the other dependencies into a single representation yields:

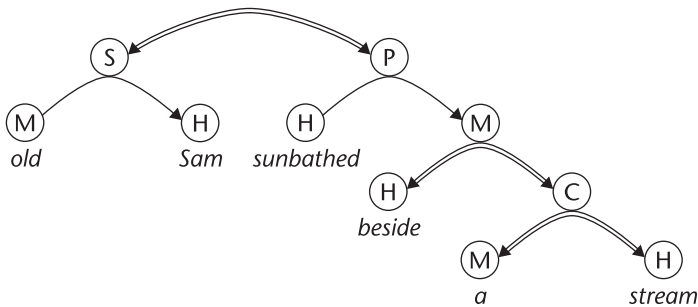

This little sentence illustrates all the ideas discussed in this chapter. (Old Sam and his sunbathing can be laid to rest at this point.)

Further exercises

- For each of the following sentences, identify the subject NP and the predicate VP by drawing phrase markers like that in [33] on page 30. In cases where the sentence is *not* exhaustively divisible into NP followed by VP, list the extra constituents separately.
 - I am accepting your invitation.
 - The income received from fines can't be taken into account.
 - Grishkin and the man in brown are in league.
 - One day, my boy, all this will be yours.
 - One day will be enough for this job.
 - A gorilla swinging about in the trees above our heads interrupted this already lengthy story.
 - Next Sunday or the Sunday after that would be convenient dates.
 - Regrettably, your dancing and colourful language are frightening the guests.
 - The existence of stars of such extreme density that not even light can escape them has not been doubted recently.

- (j) The temptation to identify less than the whole of the relevant phrase crops up in all constituent analysis.
- (k) No one who accepted that invitation to visit the slaughterhouse found it quite as edifying as you.
- (l) A lengthy discussion about the unreliability and irrelevance of parental advice followed.
- (m) The many meetings in Downing Street between the Prime Minister and other leaders involved in the crisis have failed to yield any solution acceptable to them or to the United Nations.

2. Below are five phrases and four phrase markers. On the basis of your understanding of them, assign each phrase to the appropriate phrase marker. One of the phrase markers is appropriate for two of the phrases. If you have problems, re-read the discussion of the 'sister' relation in the chapter.

- (1) Refurbished citrus fruit markets
- (2) New central fruit markets
- (3) Animals from the zoo
- (4) Gas appliances from Italy
- (5) Free-range egg packagers

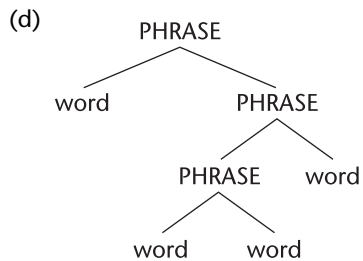
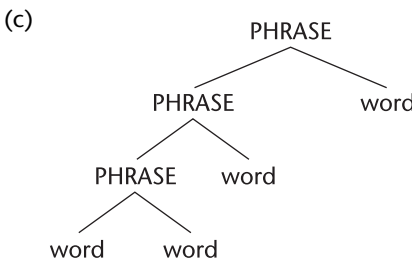
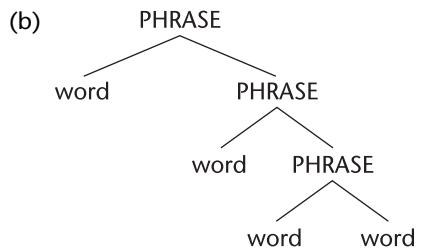
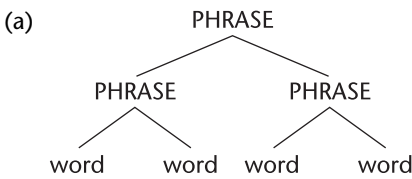

3. Using just 'phrase' and 'word' (as in Exercise 2 above), draw phrase markers for the following phrases:

- (a) Students doing chemistry.
- (b) Students doing chemistry in September.
- (c) Students with long hair doing chemistry.

- (d) Several very noisy newspaper vendors.
 - (e) Ten fully automatic deluxe hair driers.
4. For each sister relation in the phrase marker you have drawn for (c) in Exercise 3, decide whether it is a head~complement relation or a modifier~head relation. In each case, which element is the head?

3

Sentence structure: categories

I have explained the oddity of **their rather jokes* as being due to the fact that *rather* has a function only in respect of *dubious* and that, if you omit *dubious*, *rather* is left without a function. But why is *rather* left without a function? In the absence of *dubious*, why can't *rather* modify *jokes* instead? Or couldn't we say that *rather* modifies (or is modified by) *their*?

In a sense, you already know the answers to these questions. You already know that *rather* just isn't the *kind* – or *CATEGORY* – of word that can modify (and thereby form a constituent with) *jokes* – nor is *jokes* the kind of word that can be modified by *rather*. You already know that *dubious* differs from *rather* in being the kind of word that can modify *jokes*, and that *dubious* differs from *jokes* in being the kind of word that can be modified by *rather*.

It's a brute fact about the way speakers understand their language that they recognise several different *CATEGORIES* of word. In doing so, they recognise that each word has a restricted range of possible functions and that there are restrictions on how words can combine to form phrases. In illustration of the fact that you yourself do this, try the following exercise. Decide which of the following words belongs to the same category as *rather*, which to the same category as *dubious*, and which to the same category as *joke*. One of the words is of a category distinct from all three.

tactics, extremely, could, subtle

Consider the following strings:

- | | |
|-----------------------------------|------------------------------------|
| [1a] their tactics | [2a] *their extremely |
| [1b] their dubious tactics | [2b] *their dubious extremely |
| [1c] *their rather tactics | [2c] *their extremely jokes |
| [1d] *their tactics dubious jokes | [2d] their extremely dubious jokes |
| [1e] *their rather tactics jokes | [2e] *their rather extremely jokes |

The strings in [1] show that *tactics* has the same *DISTRIBUTION* as *jokes*. In other words, *tactics* has the same range of functions, can combine with the same other elements, and can occupy the same positions as *jokes*. Like *jokes*, it can be

modified by *their* [1a] and by *dubious* [1b]. Like *jokes*, *tactics* can't be modified by *rather* [1c]. [1d] and [1e] show that *tactics* can't occupy the positions or assume the same functions as either *rather* [1d] or *dubious* [1c]. In short, *tactics* and *jokes* belong to the same category, which is probably the decision you came to by intuition.

Now check list [2], making a note of what each string tells you about *extremely*.

In contrast to *jokes* and *tactics*, *extremely* can't be modified by either *their* [2a] or *dubious* [2b]. And, in contrast to *dubious*, it can neither modify *jokes* [2c], nor be modified by *rather* [2e]. *Extremely* has all this in common with *rather*. More positively, in common with *rather*, when it appears in a position in which it can be interpreted as modifying *dubious* [2d], it's acceptable. **So *extremely* and *rather* have the same DISTRIBUTION and so belong to the same CATEGORY.** They both specify the degree of the dubiousness of the jokes.

The same considerations would lead you to assign *subtle* to the same category as *dubious*. They both specify some characteristic of the jokes. The odd one out is *could*. Every attempt to incorporate *could* into the structure of the phrase results in an ill-formed string, so it must belong to yet another category.

I have mentioned only categories of SINGLE WORDS. These are called **LEXICAL CATEGORIES**. 'Noun' is one lexical category. But you know from Chapter 2 that PHRASES have categories too. These are **PHRASAL CATEGORIES** (e.g. 'Noun Phrase'). Notice that, since *their rather dubious jokes* is a well-formed phrase, and since *rather* and *extremely*, *dubious* and *subtle*, and *jokes* and *tactics* belong to the same categories, it is predictable that *their extremely subtle tactics* is a well-formed phrase as well. It is also predictable that the two phrases belong to the same phrasal category, and have the same internal structure. As at the word level, this allows us to predict that, as whole phrases, they have the same DISTRIBUTION – they will be able to occupy the same positions in sentence structure and have the same range of functions.

Instead of talking about individual words and phrases, then, we need to make more general statements about what does and what does not constitute a well-formed expression in terms of the CATEGORIES involved. But first of all, we need to name these categories. In the rest of this chapter, then, I shall introduce some lexical categories by name and give hints on how to identify their members.

Nouns

For the purposes of identification, it is best to start with a very traditional definition of what a noun is: **a noun is the name of a person, place, or thing.** There are problems with this traditional definition. For example, 'thing' has to

be interpreted very broadly, to include substances like butter and foam (since *butter* and *foam* are nouns), abstract concepts like honesty and multiplication (since *honesty* and *multiplication* are nouns), collections of things like federations, crowds, and cutlery, and phenomena like gravity and time (for the same reason). Suspicions, accidents, refusals, and facts aren't obviously things, yet *suspicion*, *accident*, *refusal*, and *fact* are all nouns. On the other hand, while *behind* and *ahead* might be said to stand for places, they are not normally taken to be nouns. Nevertheless the definition is useful as a starting point. Here are some further examples of nouns:

January, Frankenstein, Buggy, Jessica, Java, Portsmouth, gorilla, university, jam, theory, inspector, nationalisation, gremlin, joke, tactic, gallon, furniture, year, couple.

You might ask why I so confidently insist that *suspicion*, *honesty*, and *January* are nouns when suspicions, honesty, and January are not strictly either people, places, or things. In answer to this, you need to recall what the point of categorising words was in the first place. By assigning a word to a particular category, we make a general statement about its distribution – i.e. about its possible syntactic positions and functions. ***Honesty*, *suspicious*, and *January* are nouns because they occupy the same range of positions and have the same range of functions – i.e. have the same distribution – as other words that obviously are nouns by the traditional definition.** In the final analysis, then, it is distribution that decides the matter. So I'll supplement the traditional account of nouns with some distributional clues to their identification.

In addition, every category of words has its own range of possible WORD FORMS (its MORPHOLOGICAL possibilities). Nouns are no exception. This too can be useful in identifying nouns.

One morphological identifying feature of all nouns is that they have a **GENITIVE (OR POSSESSIVE) form**. For example, *Bill's* (as in *Bill's pancakes* or *those are Bill's*), *mud's* (as in *the mud's consistency*), and *joke's* (as in *the joke's punch line*).

Other features are shared by some nouns and not by others. In other words, there are several **SUB-CATEGORIES** of the noun category. I'll mention four sub-categories of **noun: PROPER VS. COMMON and COUNT VS. MASS**.

PROPER NOUNS are NAMES, spelt with an initial capital. Examples from the above list are: *January, Frankenstein, Buggy, Jessica, Java, Portsmouth*. These generally constitute Noun Phrases in their own right.

All other nouns are **COMMON NOUNS**. What follows normally applies only to common nouns.

All common nouns can combine with *the* (THE DEFINITE ARTICLE) to form a Noun Phrase (e.g. *the accident, the mud, the cutlery*). In any two-word phrase (w1 + w2) of the form [*the* + w2], w2 will always be a Noun (N).

In addition, common nouns that refer to things that can be counted – **COUNT NOUNS** –

- (a) can combine with *a/an* (**THE INDEFINITE ARTICLE**) to form a Noun Phrase (e.g. *a stream, an accident*). In phrases of the form [*a/an* + w], w will always be a Noun.
- (b) can combine with **NUMERALS** (*one, two, three . . .*) to form a Noun Phrase, and with expressions like *several, many*, etc..
- (c) can be marked for **PLURAL**. The regular marking for plural is the suffix *-s* (**SINGULAR** nouns lack this suffix). But there are several irregular plural markers:

SINGULAR	PLURAL
<i>accident,</i>	<i>accidents,</i>
<i>man, foot, analysis, sheep.</i>	<i>men, feet, analyses, sheep.</i>

MASS NOUNS refer to ‘things’ that cannot be counted (so they are sometimes called non-count nouns). Examples are *butter, foam, cutlery, furniture, honesty, grace*. Mass nouns don’t normally display any of the above possibilities. They cannot normally appear in a **PLURAL** form (**foams, *butters, *honesties*). Nor can they normally follow *a/an* (**a foam, *a butter, *a furniture*), numerals or similar expressions (**one foam, *nine furnitures*). But they follow *some* (*some foam, some furniture*). In a two-word phrase of the form [*some* + w], w will be a noun. Also, they combine with *the*.

The above remarks have been qualified by ‘normally’ because **it is often possible to turn a mass noun into a count noun** precisely by modifying it with *a/an*, or a numeral, and/or giving it a plural form. This usually involves a change of meaning: *a mud, two butters* (a kind of mud, two kinds of butter); *a beer, three beers* (a kind of beer, or a drink of beer). (See also *with an honesty that surprised me.*)

Many nouns are both mass and count. For example, *theory* can stand alone or with *some* (cf. *we need to do some theory*) as a mass noun, but it can also be preceded by *a* and by numerals and be plural as a count noun (*a theory, theories, three theories*). Other examples are *suspicion, egg, cake, and charity*.

Proper nouns, because they anyway stand for single, identifiable individuals, do not normally have any modifiers at all or appear in a plural form. However, in special circumstances, even they can be modified by *the* or *a* and appear in a plural form: *the Ewings* (= the Ewing family), *the Henman of Wimbledon fame, the Einsteins of this world, a pensive Holmes*. Here they are treated as if they were common nouns.

Now identify all the nouns in the following passage. The list is given in the footnote to the passage.

As Max and Adrian were talking, the daylight was fading from the West. Clouds were gathering and there was a chill in the air. They decided to end their conversation. Lights were shining from a passing steamer. Pessimistic thoughts filled the minds of both men, but Adrian pushed them aside as being merely the result of his tiredness. Besides, he had sand in his shoes.¹

If you included *they*, *them*, and *he* on the grounds that they stood for persons and things, that's reasonable. They are pronouns. **PRONOUNS are used to stand in place of complete Noun Phrases (NPs)**. In the above passage, *they* stands for *Max and Adrian*, *them* stands for *pessimistic thoughts*, and *he* for *Adrian*. As you saw in Chapter 1, substituting single words like these is an important test for whether a sequence of words constitutes a phrase or not. In substituting a pronoun, we test more specifically whether the phrase is an NP.

Here are some further examples of pronouns:

DEFINITE PRONOUNS: *she/her, it, I/me, we/us, you, they/them*

REFLEXIVE (DEFINITE) PRONOUNS: *myself, itself, ourselves, etc.*

INDEFINITE PRONOUNS: *something, someone, anything, anyone*

DEMONSTRATIVE PRONOUNS: *this, that, these, those*

INTERROGATIVE (QUESTION) PRONOUNS: *who, which, what*

POSSESSIVE PRONOUNS: *mine, yours, his, hers, ours, theirs.*

Lexical and phrasal categories (noun and Noun Phrase)

Before introducing further lexical categories, I will look at the relation between lexical and phrasal categories, using nouns and Noun Phrases as an example. In Chapter 2 we saw that an NP is a phrase that contains, and is centred on, a noun. *Their rather dubious jokes* is an NP and it contains the noun *jokes*. But it contains words of other categories as well. Why does the phrase as a whole have to be of the same category as *jokes*? Why can't it be of the same category as *their* or *rather* or *dubious*? The answer crucially involves the notion of **HEAD** introduced in Chapter 2. Let's revise this briefly.

In Chapter 2 I showed how *rather* modified *dubious*, *rather dubious* modified *jokes*, and *their* modified *rather dubious jokes*. At every level of structure in the phrase, it is *jokes* that functions as head. **It is the category of the HEAD word that determines the category of the phrase a whole.** The other words are present only because of the function they (directly or indirectly) have in respect of the head

¹ The nouns are: *Max, Adrian, daylight, West, clouds, chill, air, conversation, lights, steamer, thoughts, minds, men, Adrian, result, tiredness, sand, shoes.*

noun. So, you can think of *their rather dubious jokes* and *their extremely subtle tactics* as expansions of *jokes* and *tactics* respectively.

It is the head noun that determines the NUMBER (singular or plural) and the GENDER (masculine, feminine, or neutral) of the Noun Phrase as a whole. This can be seen by considering what pronoun could be used to replace the NP in a sentence:

- [3] their extremely subtle tactics – they, them
- [4] their extremely subtle tactic – it
- [5] an extremely subtle actress – she, her
- [6] an extremely subtle actor – he, him.

Tactics, to take just the first example, is the plural head noun. So the NP as a whole is plural, as indicated by the fact that it could only be replaced by the plural pronouns *they* or *them*.

Before I comment further on the relation between NP and N, here is a phrase marker of *their extremely subtle tactics*, in which I have filled in all the information about categories introduced so far:

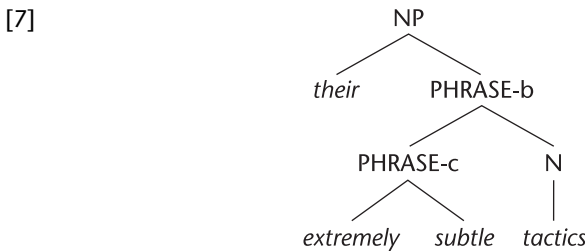

For the topmost node, I have categorised PHRASE-a as a Noun Phrase (NP). In order to say that *tactics* is a noun, I have introduced an extra node, immediately dominating *tactics*, which I have labelled N.

Noun Phrases, of course, may contain more than one noun. But (with one exception to be discussed in a moment) **only one noun in a Noun Phrase can function as its head**. In each of the following sentences, first identify the subject NP and then all the nouns contained in those subject NPs, indicating which is the head noun.

- [8] The man devouring the plums is grinning broadly.
- [9] The comedy actress John met in the foyer seemed excited.

In [8] the subject NP is *the man devouring the plums*. It contains two nouns, *man* and *plums*, and it is clear that *man* is the head noun. The appropriate pronoun to replace the whole Noun Phrase would be *he* – a singular masculine pronoun – which is consistent with the number and gender of *man* but not with the number and gender of *plums*. In [9] the subject NP is *the comedy actress John*

met in the foyer. It contains the nouns *comedy*, *actress*, *John*, *foyer*. The appropriate pronoun is *she*, a feminine pronoun that is consistent only with the gender of *actress*. *Actress* is therefore the head noun.

As the discussion of these examples implies, it is the **HEAD NOUN** that determines what sort of thing or person the whole NP refers to. The subject NP of [8] refers to a man – it is a man (not plums!) that is doing the grinning. In [9] the NP refers to an actress – it is an actress who seemed excited (not John, or comedy, or the foyer).

I have mentioned that, in an NP, constituents that modify the head noun are typically optional – they can be omitted without affecting the well-formedness of either the NP itself or the sentence in which it appears:

[10] *Their extremely subtle tactics* confuse me.

[11] *Their tactics* confuse me.

[12] *Tactics* confuse me.

The question that I want to raise here concerns sentence [12]. On the one hand, I have said that *tactics* is a noun. On the other hand I've said that, wherever possible, sentences should be analysed into a two-part, NP + VP, structure. Clearly, the VP is *confuse me*. But this seems to suggest that *tactics* is the NP – i.e. a full Noun Phrase. In [12] then, is *tactics* just a noun, or is it a full Noun Phrase? There might seem to be a conflict here. The same apparent conflict crops up with proper nouns, which generally don't appear with modifiers, as in [13]:

[13] *Max* confuses me.

In [13], is *Max* just a noun or is it a full NP? Think about this question before reading further. Can you think of any way of resolving the conflict?

As suggested, the conflict is only apparent. We don't have to choose between these alternatives. *Max* in [13] – and *tactics* in [12] – is BOTH a Noun AND a full NP. In saying this, I am allowing that a **Noun Phrase can consist simply of a head noun**. If we say that an NP consists of a (head) noun plus its modifiers, and if modifiers are typically optional, it follows automatically that NPs can consist just of a head Noun.

As regards proper nouns – i.e. **NAMES** (e.g. *Max*) – these do not, as names, admit of any modification. They are full NPs in their right. So I shall represent names as in [14]

[14]	NP name Max
------	-----------------------------

Some further remarks may help to clarify this point. I have mentioned that pronouns stand in place of full NPs. Just as we can replace the subject NPs of [10] and [11] by *they*, so we can replace the subject NPs of [12] and [13] by pronouns (*they* and *he* respectively). On the other hand, if you try replacing a simple noun (as opposed to a full NP) with a pronoun, you will get very odd results. Consider again

[15] [The ducks] are paddling away.

The ducks is an NP and it contains the noun *ducks*. Only the whole NP can be replaced by a pronoun (as in [16]), not the simple noun *ducks* (see [17]):

[16] They are paddling away.

[17] *The they are paddling away.

This clearly shows that simple nouns as such cannot be replaced by a pronoun. Since *tactics* in [12] and *Max* in [13] can be replaced by pronouns, they must be analysed as being full NPs as well as simple nouns.

In [16] we see that the pronoun *they* has assumed the position and function of a full NP. So *they* is itself an example of a one-word NP. It is a **PRONOUN** and pronouns are in themselves complete NPs. In terms of a phrase marker it would be represented as in [18].



(The subject NP of [12] – *tactics* – is neither a name nor a pronoun, so it will receive a different treatment, for reasons explained in Chapter 7.)

Now decide whether *tactics* in [10] – *Their extremely subtle tactics confuse me* – is a full NP or not.

By the pronoun test, it is NOT a full NP: **Their extremely subtle they confused me* is ungrammatical. An NP consists of a simple noun and its modifiers. *Their* and *extremely subtle* are the modifiers and *tactics* is the (simple) noun within the NP.

The discussion illustrates the close relation between the function of subject and the phrasal category of NP. In [12] and [13] *tactics* and *Max* are functioning as subjects. They therefore count as full NPs in those sentences. But in *Their tactics confuse me*, it is the whole phrase (*their tactics*) that's functioning as the subject, not the simple noun *tactics* itself; *tactics* there is just a constituent (albeit the central constituent) of the phrase functioning as subject.

So, more generally, when single words have the functions that full phrases have, we need to treat them as full phrases of the appropriate category. In fact,

I opened Chapter 2 by discussing a sentence that consisted of two one-word phrases, namely *Ducks paddle*, where *ducks* is a simple noun that counts also as the subject NP, and *paddle* is a verb that counts as a VP. **The simple verb *paddle* counts as a full VP in that sentence because it functions, by itself, as a complete predicate.**

The idea of one-word phrases sometimes causes difficulty because WORDS are traditionally contrasted with PHRASES. After all, words are just words, but phrases are sequences, or strings, of words. However, in this context at least, it is necessary to understand ‘word-sequence/string’ as meaning ‘a sequence/string of ONE OR MORE words’.

Adjectives and adverbs

Dubious and *subtle* are adjectives. Any word that has the same distribution as those words is an adjective. Many adjectives have characteristic endings, such as *-able*, *-al*, *-ate*, *-ful*, *-ic*, *-ing*, *-ish*, *-ive*, *-less*, *-ous*, *-y*. Examples are:

capable, economical, Italianate, beautiful, microscopic, surprising, priggish, inventive, hopeless, eponymous, fluffy.

There are other adjectival endings, and the endings given are only typical of adjectives, not an infallible guide. The more common adjectives tend not to have characteristic endings (e.g. *nice, old, hot, short, tight, full, long, quick*) and this goes for the colour adjectives (*blue, yellow, etc.*).

Many adjectives have the morphological possibility of taking a COMPARATIVE (*-er*) and a SUPERLATIVE (*-est*) suffix, as in *newer* and *newest*, *subtler* and *subtlest*. Others do not (cf. **beautifuler/*beautifullest*, **dubiouser/*dubiosest*) but instead may be modified by the comparative and superlative DEGREE ADVERBS *more* and *most*, *less* and *least*. Yet others have irregular comparative and superlative forms (*good, better, best*).

I have just mentioned the comparative and superlative degree adverbs *more* and *most*, *less* and *least*. Since the main function of degree adverbs is to modify adjectives (specifying the degree of the attribute expressed by the adjective), this seems the appropriate place to mention DEGREE ADVERBS as a category. They are words having the same distribution as *rather* and *extremely*, for example:

very, quite, so, too, slightly, hardly, highly, moderately, completely, increasingly, incredibly, somewhat, etc.

Adjectives that accept the *-er/-est* inflection or modification by degree adverbs are called GRADABLE ADJECTIVES. Unfortunately for the purposes of identifying adjectives, not all adjectives are gradable. NON-GRADABLE ADJECTIVES do not accept the *-er/-est* inflection, or modification by degree adverb. Here are some examples of non-gradable adjectives:

atomic, dead, potential, right, main, consummate, medical, fatal, final, second, third, supreme, unique.

Note the oddity of the following: **dead*, **deadeat*, **more dead*, **very dead*, **rather dead*, **too dead*, **somewhat dead*.

All those are impossible when *dead* is used literally. However, used metaphorically (e.g. to describe a sad and deserted night club), *dead* is gradable.

As I introduce further categories in later chapters, we will encounter words which are adjectives but less obviously so. With these introductory remarks I have restricted myself to the clear cases.

Now, bearing in mind that adjectives have a variety of functions (not only the illustrated function of modifying nouns), identify the adjectives in the following passage. There are a few degree adverbs too. Make a note of them. And, if you want more practice, identify the nouns, too. The lists are given in the footnote.

The great architectural interest of the royal palace didn't strike William at that precise moment, grotesque and flamboyant though it was. He had eyes only for Millie's gorgeous purple hair. Could it be artificial? It was difficult to believe she was so edgy as to have dyed it such a fantastic hue. She seemed too modest and shy for that. In silent admiration, he decided it was entirely natural.²

Adjective Phrases and Adverb Phrases

Rather dubious, extremely subtle, and too modest are Adjective Phrases. As with the NP, the phrase is of the same category as its head word, i.e. Adjective Phrases (AP) are centred on adjectives (A). And, like NPs, an AP can consist of an unmodified head, a simple adjective.

For example, in *Aldo's quite delicious pizzas* the AP, *quite delicious*, functions as the modifier of *pizzas* and *delicious* is the adjective functioning as the head of the AP. On the other hand, in *Luigi's inedible pizzas*, the simple adjective functions both as the head and – in itself – as the complete modifier of *pizzas*, so it counts as a full AP as well as an A. In phrase markers I shall simply employ the label 'DEGREE' (shortened to 'DEG') for the degree adverb.

You should now be able to draw the phrase marker for *very energetic*, using all the appropriate category labels. It is given as phrase marker (a) at the end of this chapter.

² Adjectives: *great, architectural, royal, precise, grotesque, flamboyant, gorgeous, purple, artificial, difficult, edgy, fantastic, modest, shy, silent, natural.*

Degree adverbs: *so, too, entirely.*

Nouns: *interest, palace, William, moment, eyes, Millie, hair, hue, admiration.*

Other constituents can appear in adjective phrases. I shall mention here only the **GENERAL ADVERBS**. Examples are:

frankly, potentially, oddly, enthusiastically, immediately, suspiciously, awkwardly, theoretically.

As these examples illustrate, **the vast majority of general adverbs (and, you will have noted, some of the degree adverbs) are formed from adjectives by the addition of -ly**, and so are easily identified.

Like degree adverbs, general adverbs can modify adjectives within Adjective Phrases (though general adverbs do have other functions as well): *theoretically untenable, oddly inconclusive, diabolically tinted, immediately recognisable.*

General adverbs differ from degree adverbs in specifying a much wider range of concepts than just degree. Furthermore, general adverbs can themselves be modified by degree adverbs, to form **ADVERB PHRASES (AdvPs)** – for example, *very oddly, quite frankly*. Since modification of a general adverb by a degree adverb is optional, an AdvP (like an NP and an AP) can consist of just a simple (general) adverb.

By way of a summary, I will give an analysis of *more obviously artificial*. As you read this paragraph, construct a labelled phrase marker of the phrase, starting at the top. First, it is an **ADJECTIVE PHRASE (AP)**. Its immediate constituents are the (head) **ADJECTIVE (A)** *artificial* and the (pre-modifying) **ADVERB PHRASE (AdvP)** *more obviously*. The AdvP in turn consists of the (head) **ADVERB (Adv)** *obviously* and the (pre-modifying) **DEGREE ADVERB (DEG)** *more*. The phrase marker is given as (b) at the end of the chapter.

Prepositions and Prepositional Phrases

Recall the discussion of *beside a stream*. *Beside* is a **preposition (P)** and it is the head of the whole phrase. So the whole phrase is a **PREPOSITIONAL PHRASE (PP)**. *A stream*, we decided in the last chapter, is functioning as complement to that head. **Within a PP, the relation between a preposition and the following Noun Phrase is a head~complement relation.**

Prepositions are generally short words that express relations, often locational relations in space or time. Other examples are: *to, at, from, with, towards, within, off, by, up, down, since, before, after, during, until, like*. Prepositions don't always express locational concepts, though: *IN an accident, IN a blue coat, OFF work, UNDER pressure, AT great speed, ON the make, LIKE a maniac*. The most commonly used preposition in the English language – *of* – does not express a location (in fact, if you think about it, it's remarkably difficult to say what *of* does express).

I will consider just two basic forms of PP: (a) PPs in which the preposition (P) is complemented by an NP (e.g. *beside a stream* and *to Max*) and (b) PPs

consisting of just a P. Notice that we can replace the PP *beside a stream* with the single words *there*, or *here* (or *where*). Since these words replace PPs, they must be prepositions. They are prepositions that count as Prepositional Phrases in their own right – they don't need a complement NP to express a location. The same goes for *upstairs* and *downstairs*. Since these two prepositions can be seen as including a complement, they don't need a separate complement to express the location.

Those single-word PPs express a spatial location. There are single-word PPs that express temporal locations. For example the temporal PPs *in those days* and *at the moment* can be replaced by the single words *then*, *now* (or *when*). So, again, these must be prepositions that count as PPs in their own right.³

The two forms of PP considered here, then, are:

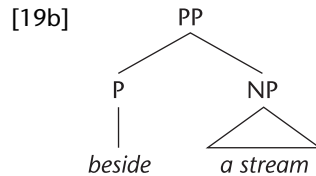
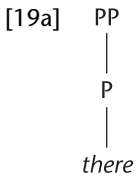

Co-ordinate Phrases

I have now introduced four main lexical categories, NOUNS, ADJECTIVES, ADVERBS (general and degree), and PREPOSITIONS, and taken a brief look at the phrasal categories associated with them. I will end this chapter with one very general point about categories and constituency.

Discussing nouns and Noun Phrases, I mentioned that, in an NP, only one noun can be head of the phrase. There is an important exception to this, illustrated in the following examples.

[20a] [*Max and Adrian*] are being melodramatic.

[20b] [*The clowns and the acrobats*] declined to co-operate.

I've bracketed the subject NPs of these sentences. Each subject NP contains two nouns (in italics). Do you agree that, in each of these cases, it's difficult to pick *just one* of those nouns as the head of the subject NP, excluding the other? In [20a] neither *Max* nor *Adrian* seems more central than the other. It is not just *Max*, nor just *Adrian*, who is being melodramatic, both are. The same goes for the clowns and the acrobats in [20b].

In such cases, if any noun is head of the NP, then both nouns must be. In phrases such as these, we must allow that NPs can have more than one head.

³ It is only fair to warn you that more traditional grammars often categorise such single-word PPs as adverbs.

Both *Max* and *Adrian* are the noun heads of the NP *Max and Adrian*. Such phrases are called CO-ORDINATE PHRASES. *Max and Adrian* is a CO-ORDINATE NOUN PHRASE, with *Max* and *Adrian* co-ordinated by *and*. Co-ordinate NPs have as many heads as there are nouns co-ordinated in them. Other CO-ORDINATORS are *but* and *or*.

In view of what's been said so far, you might feel inclined to say that *Max and Adrian* isn't a single subject but is a sequence of two separate subjects. The weight of evidence is against this view. Can you think of any arguments against it?

In the first place, we have already identified *Max and Adrian* as a single constituent in saying that the sequence functions as the subject of its sentence. You can check for yourself that it is that complete phrase (rather than any sub-part of it) that changes position in the question (remember the Chapter 1 example with *Elizabeth and Leicester*). Also, we can use *who* to replace the whole co-ordinate phrase, and answer the resulting question with it:

[21] Q: Who is being melodramatic? A: Max and Adrian.

[22] Q: Who declined to co-operate? A: The clowns and the acrobats.

Furthermore, those co-ordinate NPs can be replaced by *they*:

[23] They are being melodramatic.

[24] They declined to co-operate.

As you may have noted, with co-ordinate NPs it is usual to find that the NP as a whole is PLURAL regardless of whether the heads are singular or plural. Hence, although *Max* and *Adrian* are individually singular, the NP as a whole needs to be replaced by the plural pronoun *they*.

What, then, is the structure of these phrases? Ask yourself first whether the subject NP of [20b] consists directly of the nouns it contains (plus *and*), or whether you can identify any intermediate constituents. If you can, what are their categories?

It should have been a simple matter to identify both *the clowns* and *the acrobats* as constituent phrases in [20b]. They are NPs themselves. This can be demonstrated by showing that, even within the co-ordinate NP, they can themselves be replaced by pronouns (though generally only in context) as in [25] and [26]:

[25] They and the acrobats declined to co-operate.

[26] The clowns and they declined to co-operate.

The same goes for *Max* and *Adrian* in [*Max and Adrian*]. As names, they are each full NPs in their own right. Each is replaceable by a pronoun that can only replace a full NP. [27] and [28] are both well-formed:

[27] He and Adrian are being melodramatic.

[28] Max and he are being melodramatic.

In short, the subject NPs of [20a] and [20b] are co-ordinations of NPs. The whole co-ordinate phrase and the elements that are co-ordinated in them have the same distribution and so are of the same category. They can be represented as in [29] and [30]:

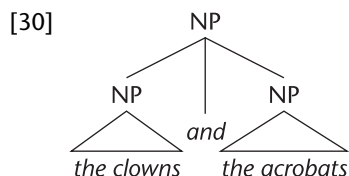
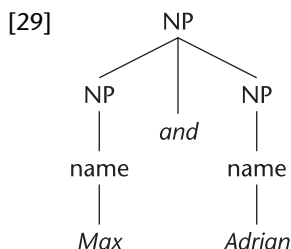

There is a general point here, which I will approach by first asking you to judge which of the following strings are well-formed phrases and which not.

[31] Max and quickly

[32] the acrobats and quite incomprehensible

[33] the actress that John met in the foyer and the acrobats

[34] in the foundations and under the rafters

[35] obviously intelligent and to Newcastle

[36] moderately cheap and extremely nasty

[37] rather and inconsistent

For the purposes of this exercise, let's assume that we agree in our judgements: [33], [34], and [36] are well-formed phrases; [31], [32], [35], and [37] are ill-formed. Can you suggest a general explanation for the ungrammaticality of the latter set of examples?

Let's approach this by first considering the well-formed phrases. Consider [33]. What category of phrase is it, and how do you know?

[33] passes all the tests for NP. In the light of the above discussion, one could reliably guess that it is an NP since it is a co-ordination of phrases that have already been identified as NPs. Now identify the category of phrases that are co-ordinated in [34] and [36] and make a (reliable!) guess as to the category of the phrases as a whole.

In the foundations and *under the rafters* are both PPs. You won't (I hope) be surprised to hear that [34] is itself a PP. *In the foundations* has the same distribution as *in the foundations and under the rafters* – wherever one could appear so could

the other – so they must belong to the same category. In [36] *moderately cheap* and *extremely nasty* are both APs. Not surprisingly, [36] is an AP.

Now identify the phrases that have been co-ordinated in the ill-formed examples. On the basis of that, try to decide the category of the whole expression. The difficulty you'll experience in attempting to do this provides the explanation for their oddity. Try to formulate in your mind what the problem is.

[31] is a co-ordination of a Noun Phrase and an Adverb Phrase. How do we decide what category the whole co-ordination should belong to? Answer: we can't. Both phrases are heads of the co-ordinate phrase, but their categories conflict. In [32] a Noun Phrase and an Adjective Phrase have been co-ordinated and we have the same problem. In [35] it is an Adjective Phrase and a Prepositional Phrase, in [37] a Degree Adverb and an Adjective Phrase. And again, there is no way of deciding what the category of the whole string is.

To sum up, **any constituent, of any category, can consist of a co-ordination of constituents of the SAME category.** It follows from this that only constituents of the same category can be co-ordinated.

This very general principle has provided an often-used test in language study. It has been used as a test of two things, (a) constituency and (b) category. As regards (a), notice that the general principle allows only *constituents* to be co-ordinated. So if you can co-ordinate a string of words with another string of words, this indicates that each of those strings is a phrase. As regards (b), if you know the *category* of one of those strings of words, you know that the other string of words must be of the same category, since only identical categories can be co-ordinated.

I have illustrated this general principle only with co-ordinations of phrasal categories. But the principle holds for all categories, including lexical categories and sentences themselves. Compare [38] and [39]:

[38] Stuffy and too hot.

[39] Too hot and stuffy.

Both are APs. [38] is a co-ordination of two APs, the first of which is a simple A. The most likely interpretation of [39], on the other hand, is that it means the same as *too hot and too stuffy*. In this case, the modifier of *hot* is shared by *stuffy*, so that *too* modifies not just *hot* but the whole phrase *hot and stuffy*. *Hot* and *stuffy*, therefore, are each simple adjectives, and *too* must be analysed as modifying a CO-ORDINATE ADJECTIVE. So, as with many other APs discussed, this AP consists of a degree adverb and a (co-ordinate) adjective, as shown in [40b]:

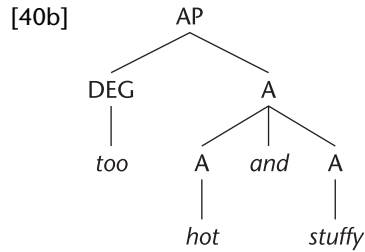
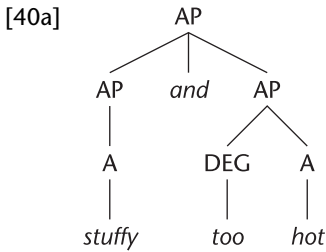

Up and down the staircase is a Prepositional Phrase (PP). It contains a co-ordination of prepositions (Ps). Draw the phrase marker for the whole PP (using a triangle for the NP).

Now draw the phrase marker for the PP *in the foundations and under the rafters*.

As noted, those phrases are both PPs, but the first contains a LEXICAL CO-ORDINATION (with *the staircase* complementing a co-ordination of Ps) while the second is a PHRASAL CO-ORDINATION (of PPs):

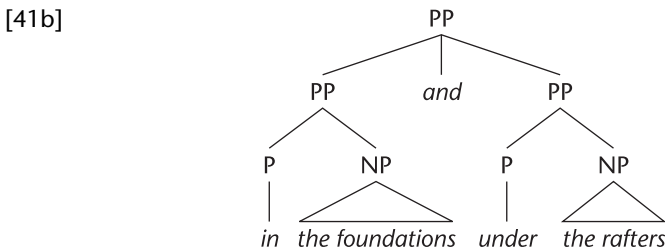
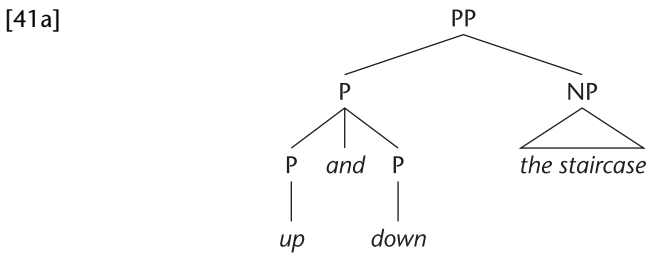

The important point to notice about all these co-ordinations is that the mother and the sisters of the co-ordinator (*and* in this case) all have the same category label.

In these first three chapters, I have discussed constituency, function and category, and how these concepts relate to each other. I'll end the chapter by showing how the points made about constituency and category in connection with co-ordination can be looked at in terms of FUNCTION.

Co-ordinations of different categories are ill-formed because they could have no coherent function. Consider again [31] – *Max and quickly* – the co-ordination

of an NP and an AdvP. Both the NP and the AdvP, remember, are heads. Attempting to make the whole co-ordinate phrase function in the way that an NP does, while all right as far as *Max* is concerned, involves making the AdvP function like an NP. But if the AdvP could function like an NP, it would be an NP, not an AdvP. And if we attempt to make the whole phrase function like an AdvP, the same problem arises in respect of the NP. So the phrase as a whole is without any possible function.

In fact, it may well be that this LACK OF ANY POSSIBLE FUNCTION will turn out to be more important than the MIXING OF CATEGORIES: for when the different categories can function in the same way it is sometimes possible to co-ordinate them. An example of this is *in a pickle and very worried*, which is a co-ordination of PP and AP. Such examples are awkward for linguistic analysis and are the subject of some debate: it is not immediately clear how we should label the phrase as a whole. For that reason, in this book I will not be troubling you further with examples like it.

Diagrams for in-text exercises

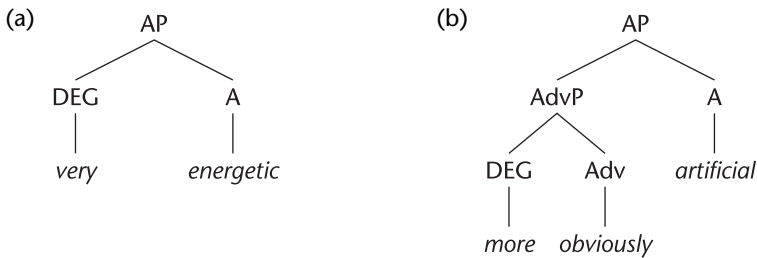

Exercises

1. Identify the following lexical categories in the passage below: (a) nouns, (b) adjectives, (c) degree adverbs, (d) general adverbs, and (e) prepositions.

On the court, she openly displayed a perfectly outrageous cheek towards officials recently appointed by the club. At home, she was an incredibly warm and loving human being, full of sensitivity for people's feelings.

2. We have now identified two functions of Noun Phrases: subject, and complement to a preposition. There are other functions. Bearing this in mind, identify the NPs in the first sentence of the above passage. Remember to identify first the largest NPs and only then any NPs that may be contained within them. Then identify the head noun of each NP. Which NP is functioning as subject of that first sentence? Which NPs are functioning as the complement to a preposition? Is there an NP functioning in some other way?

3. Draw the phrase markers for the following expressions. In some cases, you will find that you do not have all the information necessary to give a complete analysis. Where this is so (and only where this is so!), follow the example of the preceding chapters – use triangles.
- (a) for you and Pete
 - (b) rather nervous but very excited
 - (c) slowly and very carefully
 - (d) Fernandez drank brandy and smoked cheroots.
 - (e) Herbert struck the board and I had to mend it.
4. In this chapter, we have seen that adjectives can be modified by degree adverbs (forming an AP). Now, it is possible for an AP to contain sequences of degree adverbs.
- (a) so very touchy
 - (b) so completely stupid
 - (c) very very odd

Suggest an analysis for these APs. If you need a hint here, it comes in two parts: (1) all of (a), (b) and (c) are APs and (2) notice that *very touchy*, *completely stupid* and *very odd* are also APs.

Discussion of exercises

1. NOUNS: *court, cheek, officials, club, home, being, sensitivity, people, feelings*
 ADJECTIVES: *outrageous, warm, loving, human, full*
 DEGREE ADVERBS: *perfectly, incredibly*
 GENERAL ADVERBS: *openly, recently*
 PREPOSITIONS: *on, towards, by, at, of, for*
2. NPs: (a) *the court* (b) *she* (c) *a perfectly outrageous cheek* (d) *officials recently appointed by the club* (e) *the club*. You may have missed *she*: it is a pronoun having one of the functions of full NPs.
- HEADS: (a) *court* (b) *she* (c) *cheek* (d) *officials* (e) *club*.
- FUNCTIONS: *the court* is functioning as the complement of the preposition *on*. *She* is functioning as the subject. *A perfectly outrageous cheek* has a function other than subject or complement to a preposition. *Officials appointed by the club* is complement to the preposition *towards*. *The club* is complement to the preposition *by*.

3. (a)

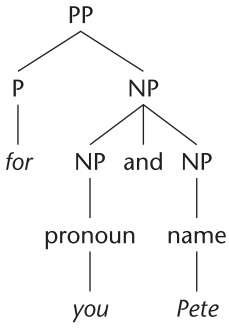

(b)

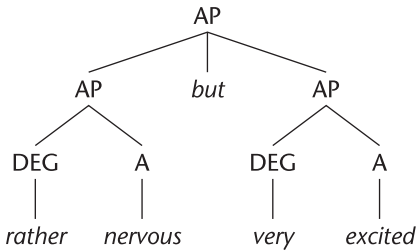

(c)

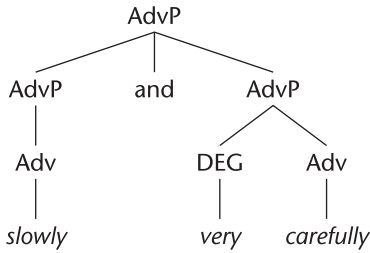

(d)

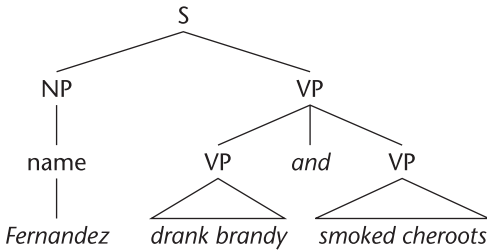

(e)

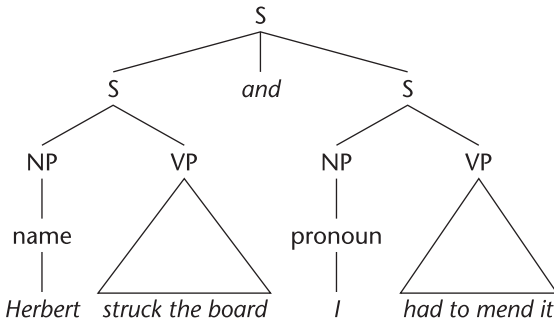

4. Those APs must be analysed as containing a further AP modified by DEG:

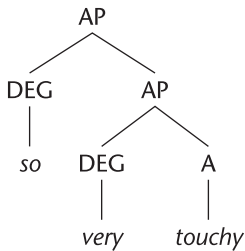

Further exercises

1. *Between the black pages of the album, ancient photographs dimly revealed the grim faces of ancestors nervelessly paralysed in different attitudes of thought and apparent concentration.*

- In the above sentence, identify all the (i) nouns, (ii) adjectives, (iii) adverbs, (iv) prepositions
- Identify its subject.

If the NP in a PP is long and complicated, the PP will appear complicated, though the overall structure is in fact simply [P + NP]. In fact there's no limit to how long a PP can be. One reason for this is that the NP within a PP can itself contain a PP (which will contain another NP (which can contain another PP (and so on (and so on))). Bearing this in mind,

- first, for each preposition in the above sentence, identify the PP of which it is head,
- then, for each N, identify the NP of which it is the head.

Example: The first P is *between*, which is complemented by the NP *the black pages of the album*. So, *between* is the head of the PP *between the black pages of the album*. Notice that the PP isn't just *between the black pages*. This is because *of the album* modifies *pages* and so must be included within the NP complementing *between*. The next P is *of* . . .

2. In the following sentences, a co-ordinator has been italicised. In each case, identify the constituents it co-ordinates and their category, attending carefully to the meaning. For example, in (a) *and* clearly does not co-ordinate just the single words on either side of it (*icy* and *her*). So, how much of the preceding and following material must be included in the co-ordination? (e) is ambiguous.

- It was *icy* *and* *her* wimpish friends simply refused to go swimming.
- He kept a towel *and* his old razor hidden in one of the lifeboats.
- Her brothers *and* sisters came to the graduation ceremony.
- The driver stopped the car *and* offered them a lift to the castle.

- (e) She wouldn't take John's dog *or* any of the pets from the cage.
- (f) They were slowly *but* surely getting to grips with syntax.
- (g) All the applause during the performance *and* at the following party made him feel quite elated.

3. Draw phrase markers for the co-ordinate elements in the above sentences. Use triangles for the co-ordinated constituents. This means that for each, you will only need *one* category label (used three times in each case). See phrase marker [30] in the chapter for an example.

4. I have claimed that every sentence in English has a subject (NP) and a predicate (VP). But consider now the following IMPERATIVE sentences:

- (a) Release the clutch gently!
- (b) Hold your breath for a minute!
- (c) Leave some money to charity in your will!
- (d) Help yourselves to champagne!

These imperative sentences seem to consist of just a VP. Are they then counter-examples to the claim that every English sentence must have a subject NP? It is relevant, in connection with (d), to consider the circumstances under which REFLEXIVE PRONOUNS (e.g. *yourself, himself, themselves*) can be used and to note the oddity of *Help themselves to champagne!* In connection with (b), note the oddity of *Hold my/his breath for a minute!* and, in connection with (c), the oddity of *Leave some money to charity in his/John's will!*

4

The basic Verb Phrase

You now know that the basic sentence consists of a Noun Phrase (functioning as subject) followed by a Verb Phrase (functioning as predicate). You have encountered several examples of VPs, though very little has been said about them. This chapter deals with the general structure (the immediate constituents) of the VP half of the basic sentence. *Paddle, sunbathed beside a stream, loves fish, hated the chips, dreads affectionate cats, and seemed happy* are all VPs. As these VPs illustrate, categories introduced in previous chapters may appear in the VP, including Noun Phrases. Within the VP, however, NPs have different functions. It is with these different functions of NP and other categories of phrase that I am primarily concerned here.

A first look at verbs

The one constituent that a Verb Phrase (VP) must contain is a verb (V). VPs are centred on V.

There are two kinds of verb in English: LEXICAL and AUXILIARY. Lexical verbs are the ones that belong to the indefinitely large general vocabulary of the language (e.g. *run, eat, seem, explain, recycle, shatter, prepare, depend*). Auxiliary verbs, by contrast, are a special and very restricted set of verbs. The clear ones are: *be, have, and do* (which can also be lexical) and *can/could, will/would, shall/should, may/might, must, and need*.

A full VP *must* contain a LEXICAL verb and it *may* contain AUXILIARY verbs. In the following, the lexical verbs are in bold and the auxiliary verbs are in italics.

- [1a] Diana **plays** the piano. [1b] Diana **played** the piano.
- [2] Anders *is* **explaining** his generalisation.
- [3] Maggie *should have* **recycled** those bottles.
- [4] Wim *may have been* **preparing** his lecture.

I shall say no more about auxiliary verbs here; they are discussed in Chapter 6. So, in calling this chapter ‘The Basic Verb Phrase’, I mean that it concerns VPs that contain just lexical verbs.

Lexical verbs are easily identified by their morphological (i.e. their word-form) possibilities. They are words that take some if not all of the **VERBAL INFLECTIONS** *-s*, *-ing*, *-ed*, *-en*. For example: *plays*, *playing*, *played* and *writes*, *writing*, *written*.

In VPs containing only a lexical verb, that verb will always carry a **PRESENT** or **PAST** meaning. In fact, present and past are explicitly marked in [1] above: in [1a] *play* carries the **PRESENT TENSE INFLECTION** *-s* and in [1b] it carries the **PAST TENSE INFLECTION**, *-ED*. More often than not, though, present tense is not explicitly marked (though it is understood). Since tense is not relevant here, I won't bother you with it in this chapter. Chapter 6 deals with that.

A general point to note in identifying categories – one that applies particularly to verbs – is that **words can belong to more than one category**. For example, *interest* is certainly a verb: cf. *interests*, *interesting*, *interested*. It is a verb in [5].

[5] Millie's hair interested him.

But both *interest* and *interests* can also be nouns (singular and plural respectively) – as in [6a–b] – and *interesting* and *interested* can be adjectives – as in [7a–b]

[6a] Its great architectural interest did not strike him immediately.

[6b] John's interests are rather eccentric.

[7a] A very interesting plan was proposed.

[7b] He wasn't very interested in the bean production.

Notice in passing that the adjectives *interesting* and *interested* are gradable and so can be modified by *very*. By contrast, no verb can be modified by *very*:

[8a] *Millie's hair very interested him.

[8b] *Her hair was very interesting him.

Now decide on the category – or categories – of each of the following words. Most of them belong to more than one category. You'll find it helpful to construct sentences in which they can function. This exercise is discussed at the end of the chapter: **Discussion 1**, page 80.

open, *impossible*, *appeal*, *up*, *content*, *between*, *export*, *edit*.

The complements of lexical verbs

This chapter is concerned with the functional relations between lexical verbs and other constituents that appear in the basic Verb Phrase. In Chapter 2, we looked at the function of *affectionate cats* in the sentence

[9] Phil dreads affectionate cats.

The VP is *dreads affectionate cats*, and *dreads* is the verb. We decided that the relation between the V (*dreads*) and the NP (*affectionate cats*) is a head–complement relation. It is a two-way dependency between the verb (as head) and the NP (as complement). The use of *dreads* without a following NP is ungrammatical, and so is the use of the NP without *dreads*:

[10] *Phil dreads. [11] *Phil affectionate cats.

But not all lexical verbs do require a following NP. If we change the verb from *dread* to *sunbathed*, for example, we get a different pattern of grammaticality:

[12] *Phil sunbathed affectionate cats. [13] Phil sunbathed.

While *dread* must take an NP, *sunbathe* cannot take an NP. So the presence of the NP depends not just on there being a verb present but, more importantly, on what sort of verb it is. *Dread* and *sunbathe* are examples of two general sorts – OR SUB-CATEGORIES – of lexical verb. **Lexical verbs are sub-categorised according to what other elements *must* appear with them in the VP. In other words, they are sub-categorised in terms of what complements they demand.**

Just because an NP cannot follow the V *sunbathe* doesn't mean that nothing can follow the V in the VP. We have seen, for example, that the PP *beside a stream* can. But this PP cannot be the complement of *sunbathe* because it is not required to complete the meaning of the VP. What [13] shows is that the verb *sunbathed* functions as a complete VP in its own right. *Beside a stream* just gives extra – OPTIONAL – information. If we omit it, we're still left with a complete VP. So, in the VP *sunbathed beside a stream*, the PP is a modifier, not a complement. The fact that a PP can follow *sunbathe* cannot therefore be used to sub-categorise the verb. **ALL VPs can include (optional) modification by a PP.** Notice, for example, that a PP can be added after *dreads affectionate cats*:

[14] Phil dreads affectionate cats *in the hay-fever season*.

So, *dread* and *sunbathe* can be distinguished by the obligatory presence or absence of a following NP but not by the (optional) presence or absence of a following PP.

In this chapter I concentrate just on the complements of the verb. This is another sense in which the VPs discussed here are 'basic VPs'. Chapter 5 deals with how optional modifiers fit into the structure of VP.

To see how general these verb sub-categories are, decide which of the following verbs belong to the same sub-category as *dread* (requiring an NP) and which to the same sub-category as *sunbathe* (requiring no NP). One of them belongs to both sub-categories.

die, make, disappear, inspect, laugh, play, spot, throw.

Taking just the first two examples, note the following pattern of grammaticality:

- [15a] Max died. [16a] *Max made.
 [15b] *Max died Bill. [16b] Max made a noise.

Die clearly belongs to the same sub-category as *sunbathe*, as do *disappear* and *laugh*: none of these verbs allows a following NP. But *make* clearly belongs with *dread*, as do *inspect*, *spot*, and *throw*: these demand a following NP. *Play*, on the other hand, belongs to both sub-categories, with different meanings:

- [17] The children played.
 [18] Max played the tuba.

Paddle, *reflect*, *break*, and *relax* are further verbs that belong to both sub-categories. You can check this for yourself (for example, *Superman relaxed* and *Superman relaxed his grip*). Sentences containing them in their different uses are given at the end of the chapter: **Discussion 2**, page 80.

The two sub-categories discussed above are not the only ones. This chapter deals with **six sub-categories of lexical verbs**:

- (1) TRANSITIVE,
- (2) INTRANSITIVE,
- (3) DITRANSITIVE,
- (4) INTENSIVE,
- (5) COMPLEX TRANSITIVE,
- (6) PREPOSITIONAL.

■ Transitive verbs

A **transitive verb** is one which requires a **single Noun Phrase** to complement it. Of the verbs considered above, then, *dread*, *make*, *spot*, *throw*, and *inspect* are transitive verbs.

The NP that complements a transitive verb is said to function (more specifically) as its **DIRECT OBJECT**. So, in *Phil dreads affectionate cats*, the NP within the VP (*affectionate cats*) is complementing the transitive verb *dread* as its direct object.

Notice that, where an NP functioning as the direct object of a verb is a pronoun, it has a special form. This form is called the **OBJECTIVE CASE** (more traditionally, ‘accusative case’). Thus the direct object pronouns in the objective case are grammatical in [19], but the corresponding pronouns in the **SUBJECTIVE** (traditionally, ‘nominative’) CASE are ungrammatical, [20]:

- [19] Phil dreads { me
her
him
us
them
- [20] *Phil dreads { I
she
he
we
they

When the form of an NP is determined by its complement relation with another constituent, it is said to be GOVERNED by that other constituent (in this case, the verb). Notice that this goes for NPs complementing prepositions in PPs as well. The preposition governs the NP, demanding that it appear in the objective case: *for him* vs. **for he*, *against them* vs. **against they*. *You* and *it* are the only pronouns that do not have a special distinct form in the objective case.

Since the V and the NP are in a functional relationship, the NP needs to be represented as a sister of the V (and therefore as a daughter of the VP) as in [21]:

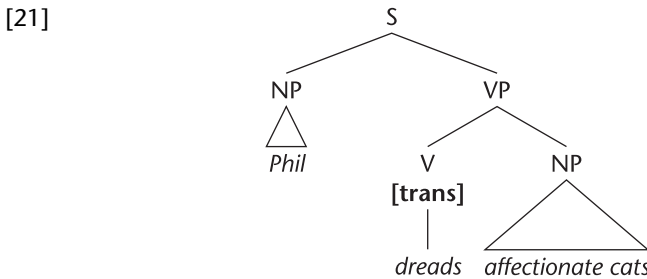

In [21] I have added to the V node the extra label ‘[trans]’, short for ‘transitive’. This extra label is called a FEATURE, and it simply sub-categorises the verb as being transitive. This sub-categorisation feature is needed in order to specify the function of the following NP in terms of the phrase marker itself. Thus, when an NP is the sister of a V bearing the [trans] feature, we know that the NP is functioning as DIRECT OBJECT. The point of this feature will become clearer when I deal with other sub-categories of verb and the other functions associated with them.

■ Intransitive verbs

An intransitive verb is one that does not require any further constituent as a sister in the VP. ‘INtransitive’ means ‘has (and needs) no complement’. *Disappear*, *die*, *laugh*, *vegetate* (and *play* on one interpretation) are intransitive verbs. Since an intransitive verb requires no further element to form a complete predicate, an intransitive verb counts as a complete VP in its own right. (Remember the discussion of *Ducks paddle* in Chapter 3.) So a very simple sentence like *Omar sighed* is represented as in [22] – with the [intrans] feature on the V node.

[22]

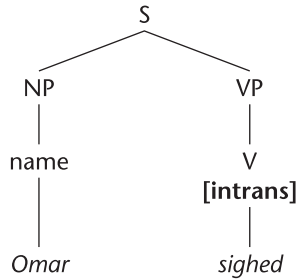

Ditransitive verbs

Ditransitive verbs require TWO NPs as complements. The classic example of a ditransitive verb is *give*. Others are *send* and *buy*:

[23a] William gave **Millie** *some bleach*.

[24a] The staff sent **the general** *a message*.

[25a] Max buys **his butler** *all necessary work-clothes*.

In [23a]–[25a] the first complement (the NP in bold) functions, more specifically, as the INDIRECT OBJECT of the ditransitive verb. Indirect objects are usually the recipients or beneficiaries of the action. The second complement NP (in italics) functions as the DIRECT OBJECT – it has the same function as the NP that complements a transitive verb. Here is a phrase marker of [23a] – with the [ditrans] feature on V.

[26]

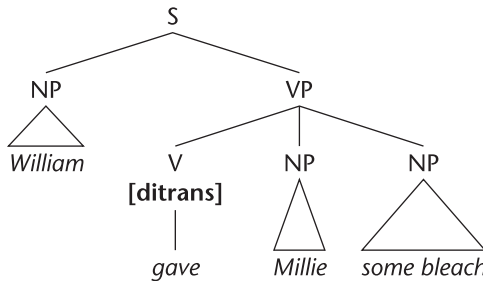

Both the NPs are governed by the V *gave* and would appear in the objective case if they were pronouns.

Now decide which of the following verbs are ditransitive.

- (a) *show* (b) *offer* (c) *see* (d) *tell* (e) *announce*

Consider the following sentences:

[27] Max showed **Matilda** *his collection of razors*.

[28] Tarzan offered **Jane** *his hairy arm*.

[29] Heseltine told **his boss** *the news*.

(a), (b), and (d), since they accept two consecutive NPs, are ditransitive verbs. But (c) and (e) don't accept two NPs so they are not ditransitive (in fact they are transitive):

[30] *Max saw Matilda his collection of razors.

[31] *Heseltine announced his boss the news.

An important characteristic of VPs consisting of a ditransitive verb complemented by two NPs is that they are systematically related to VPs in which the indirect object NP (bold in [23a]–[29]) corresponds to a Prepositional Phrase (PP) in a position following the direct object. Thus [23a] corresponds with [23b]:

[23b] William gave *some bleach* to Millie.

The PPs that correspond in this way with indirect objects are always introduced by either *to* or *for*.

What are the appropriate [b] forms for [24a] and [25a]?

[24b] The staff sent *a message* to the general.

[25b] Max buys *all necessary work-clothes* for his butler.

These [b] sentences can be represented as in [32]:

[32]

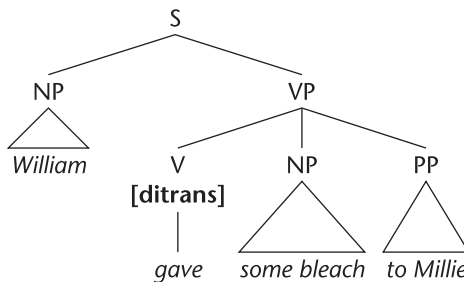

The PP corresponding to an indirect object NP has a special status. With transitive verbs, when a PP follows the direct object NP, it is not part of the complementation of the verb but is an optional modifier. However, in using a **ditransitive** verb such as *send*, we need to specify not only (a) a sender (usually subject), and (b) what is sent (usually the direct object), but also (c) to whom it is sent (usually indirect object). As mentioned, **INDIRECT OBJECTS can take the form of either an NP or a PP containing *to* or *for***. So PPs that correspond to indirect objects *are* part of the complementation of ditransitive verbs.

The **INDIRECT OBJECT**, then, is either (a) the *first* of two NP sisters of a V bearing a [ditrans] feature (as in [26]) or (b) the PP which is a sister of a V bearing a [ditrans] feature (as in [32]). As for the **DIRECT OBJECT** of a [ditrans] verb, it is either (a) the *second* NP sister of V or (b) the NP sister of V which has a following PP sister.

■ Intensive verbs

Intensive verbs require a single complement, which can take the form of an Adjective Phrase, a Noun Phrase or a Prepositional Phrase. The most obvious and commonly used intensive verb is *be*. As the central example of the intensive sub-category of verb, *be* is called ‘the copula’.

[33] Ed is *rather extravagant*. (AP)

[34] Sigmund was *an auctioneer*. (NP)

[35] Oscar and the First Mate were *in the engine room*. (PP)

The complement of an intensive verb functions (more specifically) as a PREDICATIVE. Other intensive verbs – i.e. other verbs taking a predicative as complement – are: *become, seem, appear, turn, remain, look, taste, feel, smell, sound*.

When a verb is complemented just by an AP, you can be sure you are dealing with an INTENSIVE verb. This is because [intensive] is the *only* sub-category of verb that can take just an AP complement. The point is worth noting because, as mentioned, intensive verbs can be complemented by an NP or a PP and, when a verb is complemented by an NP, you will have to decide whether [V + NP] is an example of [transitive V + direct object] or an example of [intensive V + predicative]. Understanding the concept of ‘predicative’ involves understanding the difference between predicative and direct object. I explain this now.

Compare [34] above (repeated as [36]) with [37]:

[36] Sigmund *was* an auctioneer.

[37] Sigmund *spotted* an auctioneer.

In both, we have a verb complemented by an NP. In [37] the verb is transitive, so the NP complement functions more specifically as direct object. As a direct object, the NP identifies an individual distinct from Sigmund (referred to by the subject NP *Sigmund*). In saying that Sigmund *spotted* an auctioneer, we mention *two* distinct individuals – Sigmund and the auctioneer – and say that the former spotted the latter. It is in the nature of spotting that it’s a relation between two individuals: a spotter (subject) and a spottee (direct object). That’s what makes *spot* a transitive verb.

A moment’s thought will show something quite different going on in [36]. [36] does *not* express a relation between two individuals. In [36], with the intensive verb, only *one* individual is mentioned (by means of the subject *Sigmund*). The rest of the sentence (the VP) is used to characterise the subject. If [36] can be said to express a relation at all, it is a relation between an individual and a *property*: the sentence expresses the idea that Sigmund has the property of being an auctioneer. PREDICATIVES are used to attribute PROPERTIES to the things referred to by other expressions. Unlike direct/indirect objects, they do not themselves refer to things or people.

It is because intensive verbs only take predicatives that they can be complemented by Adjective Phrases: APs only ever identify properties. Thus, [33] mentions Ed and simply attributes the property of extravagance to him. NPs, by contrast, can be used both to identify properties and to refer to individuals. This is why an NP can function either as predicative (complementing an intensive verb) or as direct object (complementing a transitive verb).

Many of the intensive verbs listed above also belong to the transitive sub-category – but with a different meaning. This difference between transitive (+ direct object) and intensive (+ predicative) can be made quite vivid by contrasting the two meanings of such verbs. For each of the following decide whether the (italicised) complement NP is complementing a transitive verb as direct object or complementing an intensive verb as predicative:

- [38] Max turned *a subtle shade of green*.
- [39] Max turned *another card*.
- [40] Tarzan felt *a tap on his shoulder*.
- [41] Tarzan felt *a real idiot*.
- [42] The leopard-skin pillbox hat didn't become *her*.
- [43] The hat became *a very useful wastepaper basket*.
- [44] The captain sounds *an absolute tyrant*.
- [45] The captain sounded *the ship's horn*.

The NPs are functioning as direct objects (complementing the verbs in their transitive senses) in [39], [40], [42], and [45]. They are functioning as predicatives (complementing the verbs in their intensive senses) in [38], [41], [43], and [44]. Notice that, in the latter cases, those NPs could be replaced by APs without changing the sense of the verb (*green* in [38], *idiotic* in [41], *ever more useful* in [43], and *absolutely tyrannical* in [44]).

I have said that predicatives are used to attribute properties to the things referred to by *other* expressions. We have seen that, in the case of intensive verbs, that other expression is always the subject. So, **to be more specific about the function of the italicised complement expressions in [33]–[35]: they are predicatives; and more specifically yet, they are SUBJECT-PREDICATIVES.** In the next section, I will need to refer to object-predicatives.

I can now show more clearly what the point is of attaching a sub-categorisation feature to the V node. Without such a feature, [36] and [37] – and all the examples [38]–[45] – would receive exactly the same analysis. It is the distinction between the features, [intens] and [trans] that distinguishes them – as in [46a–b].

[46a]

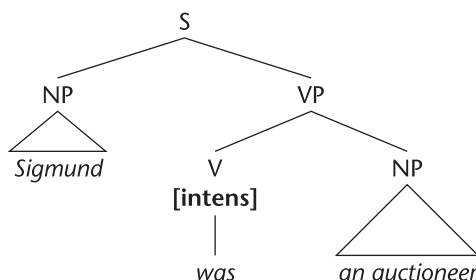

[46b]

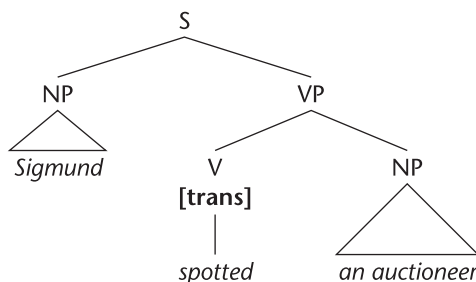

An [INTENS] verb, by definition, takes a subject-predicative. A [TRANS] verb, by definition, takes a direct object. So, by using those features, you are effectively assigning a (more specific) function to the complement of the verb.

A word now about PPs functioning as subject-predicatives. I've already mentioned that all VPs can include optional modification by PPs. PPs should only be treated as part of the necessary complementation of an intensive verb (i.e. as subject-predicatives) if they cannot be omitted. So, *in the engine room* in [35] is a predicative since [47] is not a complete sentence (though the missing element might be understood in context – see Chapter 5):

[47] *Oscar and the First Mate were.

I look again at PP complements below.

Complex transitive verbs

Complex transitive verbs take TWO COMPLEMENTS: a DIRECT OBJECT (NP) and an OBJECT-PREDICATIVE. Again, the predicative can take the form of an AP, an NP or a PP. Here are some examples, with the direct object in italics and the predicative in bold.

[48] Jack finds *his own jokes* **extremely funny**. (AP)

[49] They made *Stella* **their spokesperson**. (NP)

[50] Liza put *the liquor* **under her bed**. (PP)

Everything I said about predicatives above goes for the predicative in a complex VP, but with one big difference. The difference is that **the predicative in a**

complex transitive VP characterises (attributes a property to) the direct object, not the subject, hence the name ‘object-predicative’. The semantic relation between direct object and object-predicative in a complex transitive VP, then, parallels that between the subject and the subject-predicative in an intensive sentence. It’s an **intensive** relation. For example, if [48] is true, then, as far as Jack is concerned, his own jokes **ARE** extremely funny; if [49] is true, then Stella **BECAME** their spokesperson; and if [50] is true, then the liquor **WAS** under Liza’s bed.

Here is a phrase marker representation of [48]:

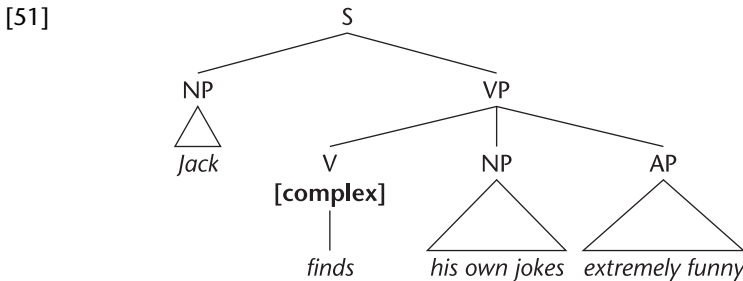

In assigning the feature [complex] to the V node, we are making the whole phrase marker represent the function of *his own jokes* as direct object and the function of *extremely funny* as object-predicative (those are the functions associated with complex transitive verbs). This is particularly needed in a case like [52a].

[52a] Max found [Bill] [an amusing companion].

This example is ambiguous. First identify the two interpretations in your mind and then explain the ambiguity by assigning different functions to the two complements of the verb. On the basis of that, you should be able to assign two different sub-categorisation features to the V *found*.

On one interpretation, [52a] corresponds in meaning with (a) *Max found an amusing companion FOR Bill*. On this interpretation, the verb *find* is ditransitive: *Bill* refers to the beneficiary and is functioning as indirect object, and *an amusing companion* is the direct object. Notice that *three* participants are involved on this (ditransitive) interpretation. On the other interpretation, [52a] corresponds with (b) *Max found Bill TO BE an amusing companion*. On this interpretation, *Bill* and *an amusing companion* have the functions associated with the complementation of complex transitive verbs: direct object (*Bill*) and object-predicative (*an amusing companion*). On this complex transitive interpretation, there are only *two* participants, Max and Bill; *an amusing companion* merely attributes a property to Bill. The distinction in meaning between (a) and (b) – and hence the ambiguity – and the different functions of *Bill* and *an amusing companion* is all accounted for simply by the difference in sub-categorisation feature attached to the V.

[52b]

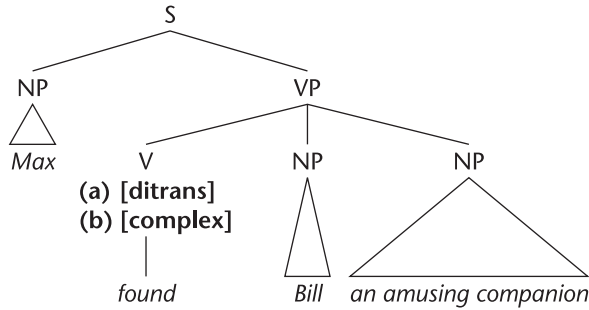

Prepositional verbs

Glance (at NP), reply (to NP), refer (to NP), and worry (about NP) are examples of prepositional verbs – complemented by a Prepositional Phrase. Take *glance*, for example:

[53] *Max glanced. (*glance* is not intransitive)

[54] *Max glanced the falling acrobat. (*glance* is not transitive)

[55] Max glanced *at* the falling acrobat. (*glance* demands a PP complement)

[56]

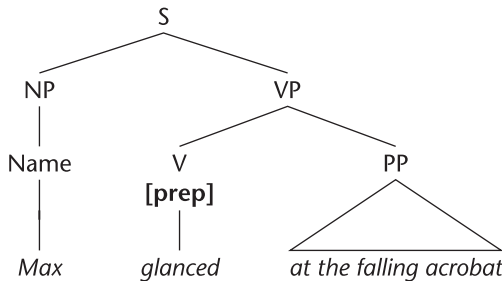

I shall call the PP that complements a [prepositional] verb, a **PREPOSITIONAL COMPLEMENT**.

There are, then, three kinds of VP consisting of [V + PP]:

- (a) V[**intens**] + PP. The PP is a complement (subject predicative);
- (b) V[**prep**] + PP. The PP is a complement (prepositional complement);
- (c) V[**intrans**] + PP. The PP is an optional modifier.

As the complement of V, the PP in (a) and (b) is represented as sister-of-V. As we shall see in the next chapter, the modifier PP in (c) is represented in another position.

Prepositional verbs are called ‘prepositional’ because they can only be complemented by a PP. In this, they contrast with [intens] verbs, which can be complemented by NP, AP or PP. Furthermore, each [prep] verb generally demands

that the head of that PP be one particular preposition – for example, we have *glance* [*at NP*], not **glance* [*to NP*], and *refer* [*to NP*], not **refer* [*at NP*].

We have now looked at a six-way distinction among verbs and their associated sentence patterns. Not all verbs – and not all uses of all verbs – fit neatly into this classification or do so only with a certain amount of ingenuity on the part of the analyst. The distinctions given nevertheless provide an introduction to the topic of sub-categorisation and, in discussing them, I have dealt with all the major constituent functions and with the sister of V within VP.

Summary

TRANSITIVE – ‘[trans]’:	subject – V – direct object (S) (dO)
INTRANSITIVE – ‘[intrans]’:	subject – V (S)
DITRANSITIVE – ‘[ditrans]’: or:	subject – V – indirect object – direct object (S) (iO) (dO) subject – V – direct object – indirect object (S) (dO) (iO)
INTENSIVE – ‘[intens]’:	subject – V – subject-predicative (S) (sP)
COMPLEX – ‘[complex]’:	subject – V – direct object – object-predicative (S) (dO) (oP)
PREPOSITIONAL – ‘[prep]’:	subject – V – prepositional complement (S) (PC)

The following may help in identifying the sub-categories of verb in sentences:

	<i>Categories</i>	<i>Functions</i>
NO complements? → [intrans]		
ONE complement? → [trans] → [prep] → [intens]	NP only PP only AP <i>or</i> NP <i>or</i> PP	dO PC sP
TWO complements? → [ditrans] → [complex]	NP + NP <i>or</i> NP + PP NP + AP <i>or</i> NP <i>or</i> PP	iO + dO dO + oP

Discussion of in-text exercises

1. The following sentences illustrate the different uses of the words given. The category of the word in each sentence is given below. As a further exercise, identify the category of the italicised word in each sentence.

1. Morgan *opened* his mouth.
2. Morgan's *open* mouth admitted the fly.
3. That was clearly *impossible*.
4. Mary *appealed* to John to take the rubbish out.
5. Her repeated *appeals* were unsuccessful.
6. He booted his drunken colleague *up* the gangway.
7. They *up* the rent every other month.
8. Georgette is perfectly *content*.
9. Jenny criticised the *content* of the paragraph.
10. He *contented* himself with a second-hand copy.
11. The recalcitrant mango slipped *between* Grace's fingers.
12. Toffee-wrappers are the main *export*.
13. Boggis and Stone *export* toffee-wrappers to Mesopotamia.
14. Max has *edited* a grand total of 253 books.

1: Verb. 2: Adjective. 3: Adjective. 4: Verb. 5: Noun. 6: Preposition. 7: Verb.
8: Adjective. 9: Noun. 10: Verb. 11: Preposition. 12: Noun. 13: Verb. 14: Verb.

2. 1. The ducks paddled (across the lake) – [intransitive]
2. He paddled the raft (across the lake) – [transitive]
3. Morgan is reflecting (quietly) – [intransitive]
4. The glass reflected Max's ugly mug – [transitive]
5. The samovar broke – [intransitive]
6. Anna broke the samovar – [transitive].

Exercises

1. Identify the major functions in the following sentences (subject, direct object, indirect object, subject-predicative, object-predicative, and prepositional complement). Identify the verbs and sub-categorise them. Example:

<i>Otto</i>	<i>devoured</i>	<i>the couscous</i>
subject	V	direct object
	[trans]	

- (a) The girl in the palace dyed her hair deep purple.
 (b) Hot air rises.
 (c) Richard promised me his spaghetti machine.
 (d) The sedan-chair proved very useful.
 (e) Someone stole my contact-lenses.
 (f) It sounds like a really good film.
 (g) The candidate's antics amused the board of examiners.
 (h) The committee nominated her Acrobat of the Year.
 (i) Oscar feeds his cat smoked salmon.
 (j) I like my curries as hot as you can make them.
 (k) This calls for a celebration.
 (l) The main witness for the prosecution disappeared.
 (m) He applied for a gun licence.
2. Decide whether the PP in the following sentences is part of the complementation of a DITRANSITIVE verb or not.
- (a) Holden wrote ten letters to Africa.
 (b) Holden wrote ten letters to the White House.
 (c) Max took the hyena to the station.
 (d) Max lent his hyena to the Dramatics Society.
 (e) William baked a cake for everyone.
 (f) William baked a cake for Christmas.
 (g) Laura saved the money for a piano.
 (h) Laura saved a place for Martha.
3. Using any of the following phrases, construct (1) a sentence in which *smelt* is used as an intransitive verb; (2) a sentence in which it is used as a transitive verb; (3) a sentence in which it is used as an intensive verb.
- (a) *smelt* (b) *the apprehensive butler* (c) *Jim's attempt at a stew*
 (d) *rather strange*.
4. Using triangles for all major constituents (as used in this chapter) draw phrase markers for the following sentences.
- (a) Nicholas felt strangely euphoric.
 (b) The local gallery lends us the materials.
 (c) The condition of the cakes left out overnight deteriorated.
 (d) They voted the Grand Master out of office.
 (e) A bucket of cold water revived that particular patient.
 (f) The Venetians submitted to Napoleon's demands.

Discussion of exercises

1. (a) [The girl in the palace] [dyed] [her hair] [deep purple].
 S V dO oP
 [complex]
- (b) [Hot air] [rises].
 S V
 [intrans]
- (c) [Richard] [promised] [me] [his spaghetti machine].
 S V iO dO
 [ditrans]
- (d) [The sedan-chair] [proved] [very useful].
 S V sP
 [intens]
- (e) [Someone] [stole] [my contact lenses].
 S V dO
 [trans]
- (f) [It] [sounds] [like a really good film].
 S V sP
 [intens]
- (g) [The candidate's antics] [amused] [the board of examiners].
 S V dO
 [trans]
- (h) [The committee] [nominated] [her] [Acrobat of the Year].
 S V dO oP
 [complex]
- (i) [Oscar] [feeds] [his cat] [smoked salmon].
 S V iO dO
 [ditrans]
- (j) [I] [like] [my curries] [as hot as you can make them].
 S V dO oP
 [complex]
- (k) [This] [calls] [for a celebration].
 S V PC
 [prep]
- (l) [The main witness for the prosecution] [disappeared].
 S V
 [intrans]
- (m) [He] [applied] [for a gun licence].
 S V PC
 [prep]

2. As mentioned in this chapter, a PP is counted as part of the complementation of a ditransitive verb only if it corresponds to an NP functioning as an indirect object.

Take examples (a) and (b). (1) is *not* a reasonable paraphrase of (a), but (2) is a reasonable paraphrase of (b):

- (1) ?Holden wrote Africa ten letters.
 (2) Holden wrote the White House ten letters.

So the PP in (b) is part of the complementation of the verb, and *write* in that sentence must be sub-categorised as [ditrans]. In (a), on the other hand, *write* is a [trans] verb, complemented by the direct object *letters* or perhaps *letters to Africa*. Note that, if *to Africa* is not part of the direct object NP in (1), then it must be analysed as an optional modifier within the VP. I discuss why there should be this difference between (a) and (b) after dealing with the remaining examples.

- (c) No. cf. **Max took the station his hyena*. *Take* here is [complex] and the PP is functioning as object predicative.
 (d) Yes. cf. *Max lent the Dramatics Society his hyena*. *Lend* is a [ditrans] verb.
 (e) Yes. cf. *William baked everyone a cake*. This is a [ditrans] sense of *bake*.
 (f) No. cf. **William baked Christmas a cake*. (See below)
 (g) No. cf. **She saved a piano the money*. The PP is a modifier.
 (h) Yes. cf. *She saved Martha a place*. A [ditrans] sense of *save*.

Notice it is only NPs denoting ANIMATE things (or things that could be interpreted as being animate) that can be indirect objects. For example, if interpret *Christmas* as a person rather than a festival, *William baked Christmas a cake* sounds OK. In (2) above, *the White House* can be an indirect object because, as well as being a building, it is an organisation of human beings, as is the Dramatics Society. By contrast, there is no single human institution that represents Africa as a whole, so *Africa* is an inanimate location and cannot function as indirect object.

3. INTRANSITIVE: 1. The apprehensive butler smelt.
 2. Jim's attempt at a stew smelt.
 TRANSITIVE: 1. The apprehensive butler smelt Jim's attempt at a stew.
 INTENSIVE: 1. The apprehensive butler smelt rather strange.
 2. Jim's attempt at a stew smelt rather strange.

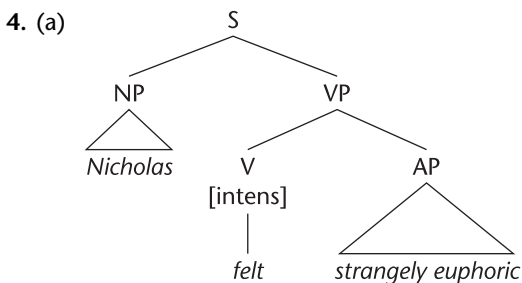

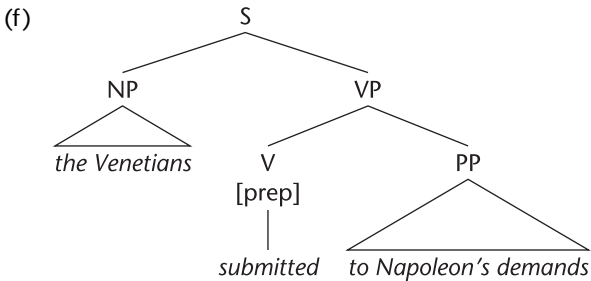
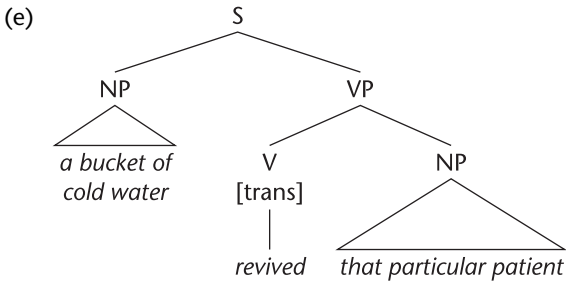
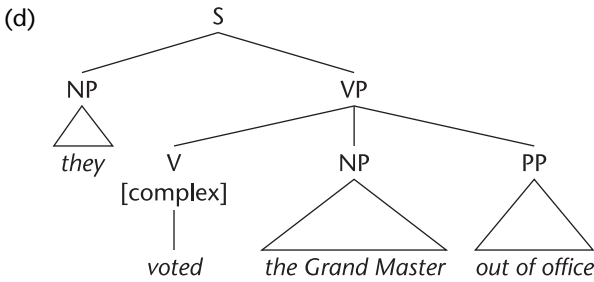
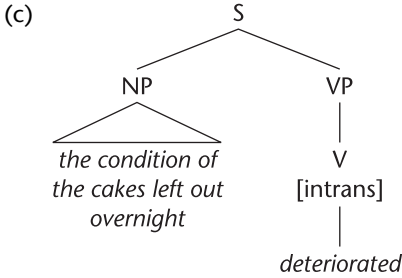
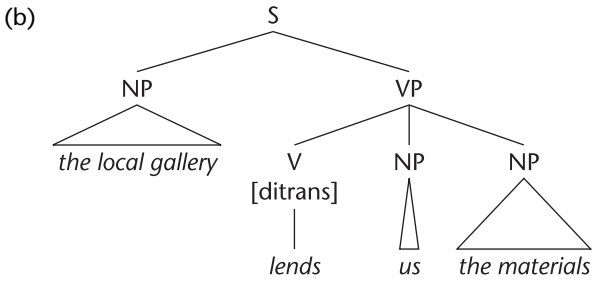

In these six phrase markers, all six complementation types are represented, and hence all six types of basic sentence considered in this chapter.

Further exercises

1. For each of the following sentences

- (a) identify the verb and give its sub-category.
- (b) Identify all the major functions: subject (**S**), direct object (**dO**), indirect object (**iO**), subject-predicative (**sP**), object-predicative (**oP**), prepositional complement (**PC**). Make sure the sub-category of the verb is consistent with the functions you assign.
- (c) Give the category of each constituent you have identified under (b) above.

Example:

	<i>[Phil]</i>	<i>[dreads]</i>	<i>[affectionate cats]</i>
Function:	S	V [trans]	dO
Category:	NP		NP

- (1) Petrol got more expensive.
- (2) Alexander's father left him.
- (3) Alexander's father left him the theatre.
- (4) Alexander's father left him in the care of the bishop.
- (5) Several of the men complained.
- (6) He referred to the fact that you had no clothes on.
- (7) All the customers sit their children on the counter.
- (8) Her mother and father approve of Matilda's behaviour.
- (9) Most of the students do the work you set.
- (10) Col. Mustard locked Miss Scarlett in the library.
- (11) Children in ragged clothes scampered along the street.
- (12) His fish and chips went cold and greasy.
- (13) The obliging manager poured everyone a glass of wine.
- (14) Joan placed her latest trophy in a prominent position.
- (15) Karen peered into the gaping hole.
- (16) The new chef liquidised last week's uneaten fritters.
- (17) That spot made a perfect picnic place.
- (18) Bill made a brilliant picnic table. (The most likely interpretation, please!)
- (19) This so-called music makes me mad.

- (20) He made the men a decent meal.
 (21) The exhausted team members made for the nearest pub.

2. Draw phrase markers for at least some of the above sentences, using triangles for all the constituents you identified under 1(a)–(b) above. For examples, see the Discussion of Exercise 4 above.

3. As we have seen, Prepositional Phrases have a variety of functions. We have looked at four so far. As (obligatory) **complements** of verbs, they may function as

- [A] subject-predicative in [intens] VPs,
 [B] object-predicative in [complex] VPs,
 [C] indirect-object in [ditrans] VPs (but only with *to* or *for*),
 [D] prepositional complement in [prep] VPs.

As we shall see, they can also function as (optional) **modifiers**:

- [E] modifiers within the structure of NP (e.g. *the book in your pocket*),
 [F] modifiers within the structure of VP (e.g. *sunbathed beside a stream*).

Decide which one of these functions the bracketed PPs have in the following sentences (this can be done just by giving one of the above letters). NB. Some allow more than one reasonable answer. This is particularly true of (14). Note that (3) is crucially ambiguous.

- (1) Bertram is the man [for the job].
 (2) She was very happy [in the Spring].
 (3) I touched the man [with the umbrella].
 (4) This award is [for outstanding culinary achievement].
 (5) I'm doing this course [for my own satisfaction].
 (6) Eliot left most of his manuscripts [to the museum].
 (7) Eliot left most of his manuscripts [at the museum].
 (8) He passed the wine [to Tessa].
 (9) He passed the house [on the way].
 (10) We stayed [for ten minutes].
 (11) We stayed [at the Hotel Mortification].
 (12) He knocked a glass [of wine] [onto the floor].
 (13) He remained [in a state of shock] [for ten days].
 (14) Dionysus remained [in the bar].

5

Adverbials and other matters

Adjunct adverbials (VP adverbials)

In this chapter I look more closely at the distinction between complements and modifiers in the Verb Phrase.

We have already encountered PPs **functioning as modifiers in VP**. Examples are:

[1] Old Sam sunbathed $\left\{ \begin{array}{l} \textit{beside a stream.} \\ \textit{like a maniac.} \end{array} \right.$

[2] Max spotted those wildcats $\left\{ \begin{array}{l} \textit{in the spring.} \\ \textit{with his binoculars.} \end{array} \right.$

As mentioned, since these PPs are optional and can occur with almost any verb, they cannot be used to sub-categorise the verb. In other words, they are not functioning as complements. They give additional, though not essential, information. When a constituent functions within a VP as the PPs in [1] and [2] are functioning, it is said to function as an **ADJUNCT ADVERBIAL** (or simply, **ADJUNCT**).

[1] and [2], then, are examples of intransitive and transitive sentences with adjunct adverbials. Here are further examples of PPs functioning as adjuncts in intensive [3], [4] and [5], ditransitive [6], and complex transitive [7] structures:

[3] Ed was rather extravagant *in the bazaar*.

[4] Sigmund was an auctioneer *for three years*.

[5] Oscar was in the engine-room *in a flash*.

[6] William gave Millie some bleach *on her birthday*.

[7] Liza put the liquor under the bed *for safekeeping*.

As the adjunct PPs in these examples illustrate, **adjuncts express a wide range of ideas, including manner, means, purpose, reason, place, and time (including duration and frequency)**. They tend to answer questions like *Where? Why? When? How? What for? How long? How often? How many times?*

Since adjunct is one type of **ADVERBIAL** function, you won't be surprised to learn that, **in addition to PPs, ADVERB PHRASES (AdvP) can also function as**

adjunct adverbials. Nevertheless, take care not to confuse the term ADVERBIAL – this denotes a FUNCTION, not included in phrase markers – and the labels ADVERB and ADVERB PHRASE, which are CATEGORY labels and do figure in phrase markers. We have seen that AdvPs can have functions other than that of adverbial: they can modify adjectives, within APs. Conversely, you know that not all constituents functioning as adverbials are AdvPs: we have just seen that PPs can function as adverbials. Here are examples of AdvPs functioning, like the PPs above, as adverbials:

[8] Sam sunbathed *frequently*.

[9] He spotted the wildcats *quite accidentally*.

[10] She put it under the bed *surreptitiously*.

Many adverbs are not as easily identified as such by *-ly* morphology, particularly adverbs relating to time: *again, yet, still, already, seldom, often, always, ever, never*.

In addition to AdvPs and PPs, **certain NPs can function as adverbials**: *last year, yesterday, tonight, tomorrow, the day before yesterday, the day after tomorrow, this afternoon . . .*

Levels of Verb Phrase

How do adjunct adverbials fit into the structure of VPs? I've described adjuncts as modifiers within the VP but so far I have avoided saying exactly what they modify. Two possibilities seem to offer themselves. In [2], for example, does *in the spring* modify just the verb *spotted*, or does it modify *spotted those wildcats* – that is, the verb plus its direct object? What do you think?

Answering this question involves making a decision about the constituent analysis of *spotted those wildcats in the spring*. If the PP modifies just the verb *spotted*, then it should be a sister of the verb, along with *those wildcats*, as in [11]:

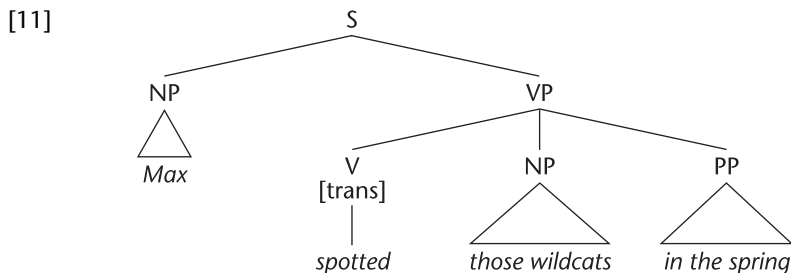

If, on the other hand, we want to say that *in the spring* modifies *spotted those wildcats*, then it must be the sister of a constituent consisting of [verb + direct object NP]. In other words, V + NP must form a constituent. They don't form a

constituent in [11], do they? So, if we choose this second option, [11] **cannot be the right analysis.**

I'll go for this second option. Intuitively, the adjunct PP does seem to modify a constituent consisting of [V + NP] rather than just the V by itself. I have already noted that *those wildcats* – as a complement of the verb – completes the sense of the verb and, together with that verb, forms a unit of sense. It does so quite independently of the adjunct *in the spring*.

We have seen that *Max spotted those wildcats in the spring* is a good subject~predicate sentence. *Max* is the subject NP. So *spotted those wildcats in the spring* is clearly a VP. Now, on the analysis we are adopting, we are saying that *in the spring* modifies a constituent of the form V + NP (*spotted those wildcats*). Bearing in mind that *Max spotted those wildcats* is itself a good subject~predicate sentence (without *in the spring*), what category label should we attach to *spotted those wildcats*? In other words, what kind of constituent is it?

Having decided that, draw a phrase marker for the whole sentence *Max spotted those wildcats in the spring*. Use triangles for *those wildcats* and *in the spring*.

Spotted those wildcats must be a VP in its own right. It consists of a transitive verb plus its direct object NP. Now, that VP is a constituent of another, larger, VP – namely, *spotted those wildcats in the spring*. So the whole phrase marker must look like [12], in which, for ease of reference, I have numbered the two VPs. VP1 is the ‘basic VP’ introduced in the last chapter.

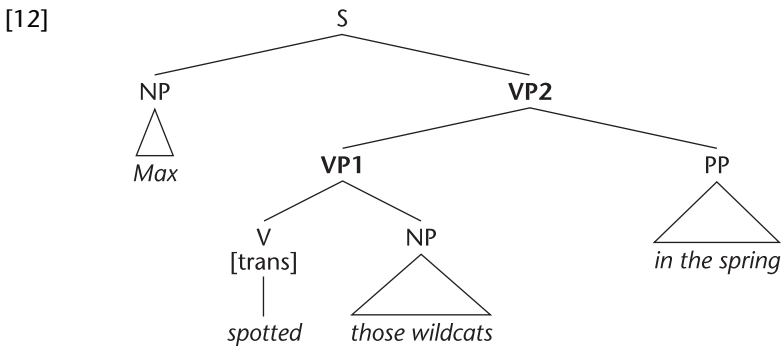

This analysis has the effect of creating **two levels of VP** in [12] and thus allowing us to represent, within the phrase marker configuration, the difference in function between the NP *those wildcats* (functioning as a **COMPLEMENT**, more specifically as direct object) and the PP *in the Spring* (a **MODIFIER**, more specifically, an adjunct adverbial). Thus, **adjunct adverbials are MODIFIERS OF VPs**. As such, they must be represented, in phrase markers, as **sisters of VP**.

If there is just one big idea in this chapter, it is this: the difference in function between (obligatory) complements of the verb and (optional, modifying) adjunct adverbials is to be represented in phrase markers as follows:

- **COMPLEMENTS of the verb are sisters of Verb (V)**
- **ADJUNCT ADVERBIALS are sisters of Verb Phrase (VP).**

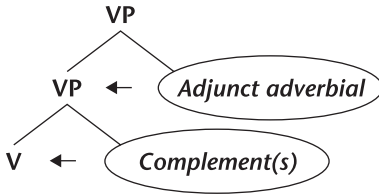

A piece of evidence that supports this analysis was touched on in the Introduction. But first, draw the phrase markers for [13] and [14] in the light of the discussion so far, bearing in mind that *mend* is a [transitive] verb and *put* is a [complex transitive] verb.

[13] Bevis mended his car in the garage.

[14] Bevis put his car in the garage.

Since *put* is [complex transitive], the PP *in the garage* in [14] is part of the complementation of the verb. By contrast, in [13] it is an (optional) adjunct adverbial. So, on the analysis adopted here, [15] and [16] are the two different phrase markers.

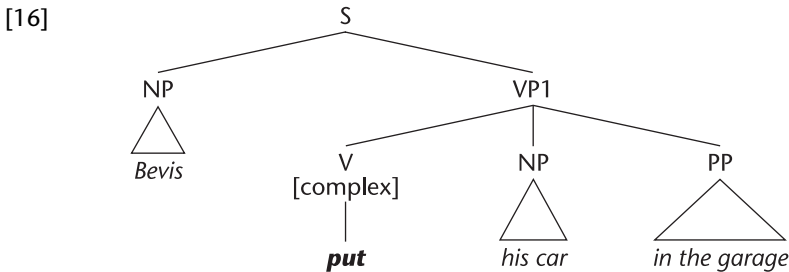
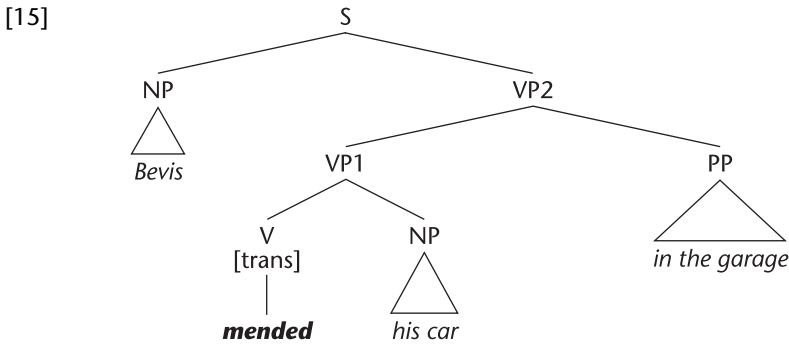

In the Introduction, I noted that [17] was grammatical, but [18] ungrammatical.

[17] Bevis mended his car in the garage and Max *did so* in the garden.

[18] *Bevis put his car in the garage and Max *did so* in the garden.

What's the explanation for this? The expression *do so* is used to avoid repeating material that has already appeared in the sentence. It stands for, or replaces, that material. Expressions that perform this function are called PRO-FORMS. Pronouns are pro-forms. They replace NPs (so they should really be called 'pro-NP's). *Do so* (*did so*, etc.) *always and only* replaces a VP. It is a pro-VP. So, if a constituent is a VP, it can be replaced by a form of the expression *do so*, otherwise it can't.

In [17] we understand that *did so* is replacing *mended his car*. This is fine because, as [15] shows, *mended his car* is a VP (namely, VP1). If, as is natural, we take [18] to mean that Max put his car in the garden, we must conclude that *did so* is replacing *put his car*. But a careful look at [16] shows that *put his car* is NOT a VP. In fact, it's not even a constituent (check that you agree!). Since *did so* only ever replaces VPs, it is predictable that [18] should be ungrammatical.

We have seen that *did so* in [17] replaces VP1 (*mended his car*) in [15]. Let's now check whether it can replace VP2 (*mended his car in the garage*) in [15]:

[19] Bevis mended his car in the garage and Max *did so* (too).

We understand this to mean that Max 'mended his car in the garage'. Since it is replacing a VP, it is grammatical (though perhaps more natural as *and so did Max*). You can check for yourself that *did so* can replace the single VP of [14]/[16].

The fact that *did so*, which replaces only VPs, can grammatically replace two strings of words (one contained within the other) in [13] provides vivid evidence that [13] does contain two VPs, as represented in [15].

It is also good evidence for the distinction between complements and modifiers (i.e. adjuncts) in the VP – and for representing that distinction in terms of the distinction between **sister-of-V (complement)** and **sister-of-VP (adjunct)**. Remember, complements are required by certain verbs to complete their meaning and make up a complete and grammatical VP. A verb that requires a complement – that is, all verbs except intransitives – doesn't form a full VP on its own. That's why the complement is obligatory. For example, *mend* is a transitive verb: it doesn't form a VP without a direct object NP. So, were we to replace just *mended* in [13] by *did so*, we would be replacing, not a Verb Phrase (VP), but just a verb (V) – and the result is ungrammatical:

[20] *Bevis mended his car in the garage and Max *did so* his bike in the garden.

In the light of this discussion, suggest a phrase marker analysis for *Sam sunbathed beside a stream*. Bear in mind that *sunbathe* is an intransitive verb and therefore forms a full VP in its own right. The phrase marker is given as **Discussion 1**, page 101.

Notice that, since the occurrence of adjuncts is not determined by the verb and its sub-category, there is no reason why we can't reiterate adjunct adverbials (aA) to our hearts' delight, as in [21]:

[21] [He] [guzzled] [cream cakes] [noisily] [under the blankets] [every night]
 S V dO aA aA aA

Now draw a phrase marker for [22], bearing in mind that [23], [24], and [25] are all grammatical:

- [22] Humphrey drove his car on the left in France.
- [23] He drove his car on the left in France and Claude did so (too).
- [24] He drove his car on the left in France and he did so in Germany (too).
- [25] He drove his car on the left in France but did so on the right in the States.

The phrase marker is given at the end of the chapter – **Discussion 2**, page 101.

The mobility of adverbials

Well, this division of complements into a lower VP and adjunct adverbials into a higher VP looks nice and neat. Unfortunately, a very prominent characteristic of adverbials is that they can appear in all sorts of positions in the sentence, not just following the V and its complements. Indeed, the very fact that you can move a PP around in a sentence is a sure sign that it is functioning as an adverbial and not as the complement of the V, see [26].

[26] Beside a stream, old Sam sunbathed.

Which positions can *very surreptitiously* occupy in [27]?

[27] She put it under the bed.

- [28] Very surreptitiously, she put it under the bed.
- [29] She very surreptitiously put it under the bed.
- [30] She put it very surreptitiously under the bed.
- [31] She put it under the bed very surreptitiously.

Notice in passing that it cannot come between the V and its direct object.

The position of the adjunct in [31] poses no problem for the analysis of adjuncts as modifiers of VP within a higher VP. And neither does its position in [29]. What would you suggest as the most appropriate phrase marker for [29]?

We can simply represent *very surreptitiously* as a PRECEDING sister of the VP within another VP as in [32]:

[32]

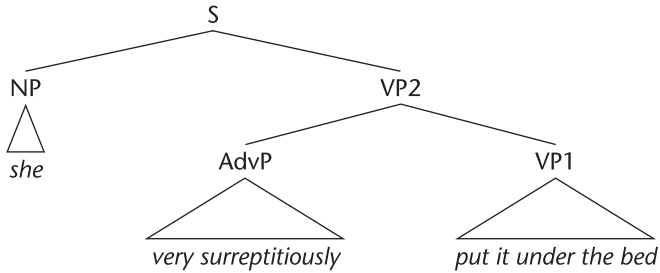

In [30], however, *very surreptitiously* is going to have to appear *within* VP1 since it appears between the complements of the V, between the direct object and the object-predicative. This is awkward for our analysis. If we want to say that the adjunct modifies the VP, it is odd to find it actually *inside* that VP. And [28] also poses a problem, because there the adjunct is completely removed from the VP.

It is beyond the scope of this book to discuss this aspect of adverbials and its implications, important though it is. I won't attempt to represent these 'displaced' adverbials in phrase markers. I will only present you with examples in which adjunct adverbials *can* be represented as sisters of a VP within a higher VP. You should bear in mind, though, that this is a simplification of the facts. Of course, if we are simply enumerating the major functions in a sentence, ignoring constituency, no problems arise: [28] can be enumerated as aA–S–V–dO–oP, [29] as S–aA–V–dO–oP and [30] as S–V–dO–aA–oP ('aA' for 'adjunct adverbial').

We have seen that adjuncts can precede or follow the VP they modify. Now, in *She hardly slept last night*, there is a preceding adjunct (the AdvP *hardly*) and a following adjunct (the NP *last night*). In representing this sentence you are going to have to decide whether the AdvP modifies a VP of the form *slept last night* or the NP modifies a VP of the form *hardly slept*. In other words, which of the two adjunct adverbials is higher in the structure? Try and decide this and then draw a phrase marker for the sentence. See **Discussion 3**, page 102.

Notice in passing that the position of the adverbial can make a difference to the meaning. Compare (a) *They slowly answered all the questions* and (b) *They answered all the questions slowly*. (b) suggests they answered each individual question slowly, whereas (a) suggests they were slow in answering the whole batch of questions.

Phrasal verbs

PBs functioning as adjuncts or complements within VP must be distinguished from another apparently similar structure. Consider the difference between [33] and [34]:

[33] He called up the street.

[34] He called up the boss.

In [33] *up the street* is a PP functioning as an adjunct. It modifies a VP that consists of the intransitive V *called*. By contrast, you will have noticed that the string *up the boss* does not form a unit of sense in [34] – and in fact is not a constituent, and hence not a PP. Instead, *up* belongs more with *call*, to form the PHRASAL VERB *call up*. Now, if *called up* is the V of [34], what do you suggest is the function of the NP *the boss*?

It is the single NP complement of the verb (*call up*), so it must be either subject-predicative or direct object. In fact, it's the direct object (if this is not clear, check in Chapter 4 on the difference between dO and sP). So, *call up* is a transitive phrasal verb. [34] can be represented as in [35]:

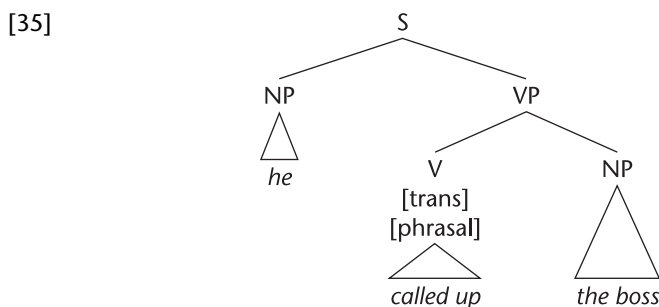

There are many such phrasal verbs in English, some more idiomatic than others:

TRANS: *call off, look up, put down, hand down, hand over, sound out.*

TRANS and INTRANS: *give up, give in, drink up.*

PREP: *put up (with NP), go along (with NP), run out (of NP), sign up (for NP).*

INTENS: *turn out, end up, wind up.*

Although *up, off, down, over,* and *along* look suspiciously like prepositions, they are traditionally distinguished from prepositions in this position and categorised as PARTICLES. I'll follow the tradition here: a **phrasal verb consists of a verb + a particle**.

Notice that [36] is ambiguous.

[36] He looked up the street.

On one interpretation, the VP consists of V + PP. This is the interpretation on which he would be looking up the street to see who was coming, for example. *Up the street* indicates where he looked. *Look* is a [prep] verb here. On the other interpretation, *look up* is a [trans] phrasal verb with the NP functioning as direct

object (as in [34]). On this interpretation he would be trying to locate the street in a street atlas.

A characteristic of particles is that they can appear in a position AFTER the direct object. Thus, [34] is acceptably paraphrased by [37].

[37] He called the boss up.

But [33] is not paraphrased by [38].

[38] *He called the street up.

The VP of [37] can be represented as in [39], with ‘particle’ abbreviated to ‘Prt’.

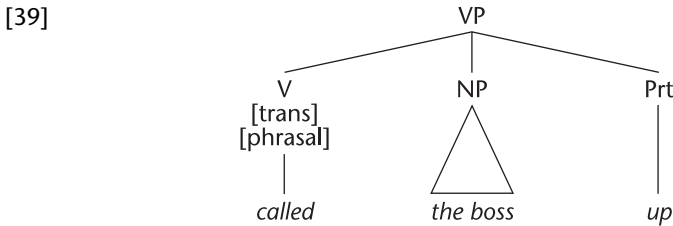

Indeed, when the direct object is a pronoun, the particle *must* appear after it:

[40a] He called him up.

[40b] *He called up him.

Only the particle of a phrasal verb can move over the direct object in this way. The preposition in a PP can never move to a position following its NP complement. So, **particle movement provides a very reliable test for distinguishing between [phrasal verb + (direct object) NP] and [verb + PP]**. Notice that, while *He looked up the street* is ambiguous, *He looked the street up* is not ambiguous. Since *up* has moved, it cannot be the P of the PP *up the street*; it must be the particle of the phrasal verb *look up*.

Incidentally, the particle can only move over a direct object NP. It cannot move over a PP (*he put up with John*, **he put up John with*), nor can it move over a subject-predicative NP (*he turned out a brilliant lawyer*, **He turned a brilliant lawyer out*).

Now decide, for each of the following VPs, whether it includes a transitive phrasal verb + NP or a prepositional verb + PP.

- | | |
|------------------------------|------------------------------|
| (a) shouted out the answers | (b) looked out the window |
| (c) hangs about the office | (d) handed over the money |
| (e) viciously turned on John | (f) saw through the term |
| (g) gave in my essay | (h) saw through her disguise |

See **Discussion 4**, page 102, which makes a further important point about the distinction between phrasal and prepositional verbs.

Ellipsis

Now that I have introduced adjunct adverbials and distinguished them from the complements of the verb, we must look at a general issue that has a bearing on that distinction and thus on verb-subcategorisation.

I have said that verb complements are a necessary part of sentence structure: they cannot be omitted without ungrammaticality. In this they contrast with adjunct adverbials. But look now at the following sentences:

[41] William gave some bleach to Millie.

[42] William gave Millie some bleach.

[43] William gave some bleach.

In Chapter 4, *give* was sub-categorised as a ditransitive verb. This is as good as saying that both the direct and the indirect object are necessary, non-omissible. But [43] does appear to be acceptable, even though it contains nothing that corresponds to an indirect object. Should we say, then, that the indirect object NP in [42] or the PP in [41] are optional? What effect would this have on the sub-category of the verb?

It would make *give* a transitive verb. If it is transitive, then the PP in [41] would be an adjunct rather than part of the complementation of the verb. Alternatively, we might want to assign *give* to both sub-categories, [ditrans] in [41] and [42], but [trans] in [43].

For various reasons, neither of these solutions is desirable. The most important reason is that neither solution does justice to the fact that, although [43] is acceptable, it nevertheless seems incomplete. Or, more to the point, it seems incomplete when considered OUT OF CONTEXT. Out of context, we would be prompted to ask who William gave the bleach to. However, in any context in which it could be understood who had been given the bleach, [43] is perfectly acceptable – for example, in the context of a conversation about Millie's birthday presents. On the other hand, in the context of a discussion of what had happened to the bleach or of what William had done, its incompleteness would be unacceptable. Note the oddity of [44b] as an answer to [44a]:

[44a] What the hell happened to the bleach?

[44b] *William gave it.

When a sentence is actually used by a speaker (i.e. when a speaker actually utters it), almost anything can be omitted, provided the omitted elements can be understood from the context in which it is used. **The omission from sentences of OBLIGATORY elements capable of being understood in the context of use is called ELLIPSIS.** Ellipsis creates acceptable, but nonetheless grammatically incomplete, sentences. Even subjects can be ellipted, as in

[45] Visited Madame Sosostriis this morning.

Almost certainly the ellipted subject is *I* (as in diary writing). But we would not want to say, simply because the utterance of [45] is acceptable in certain contexts, that subject NPs are grammatically optional.

In saying that certain constituents are necessary (obligatory), I have been relying implicitly on a distinction that is important in language description:

The grammaticality of sentences vs. the acceptability of utterances
i.e. the acceptability of uttering a particular sentence in a context.

The study of syntax, in its purest form, is more concerned with the concept of grammatical sentence than with the concept of acceptable utterance. In other words, **syntax is concerned with the form of SENTENCES, without taking into account the effects of uttering sentences in a context.** Knowing what counts as a grammatical sentence plays an important part in a speaker's ability to interpret the utterances she actually hears (or reads), but it is only a part.

You may wish to apply the SENTENCE ANALYSIS offered in this book to UTTERANCES – that is, to actual uses of sentences by a speaker, whether in speech or in writing. If so, it will be useful to have a way of representing ellipsis. This is easily done. For example, we can capture the fact that, even though [43] has no indirect object, it still counts as a ditransitive sentence (albeit an elliptical one), as in [46]:

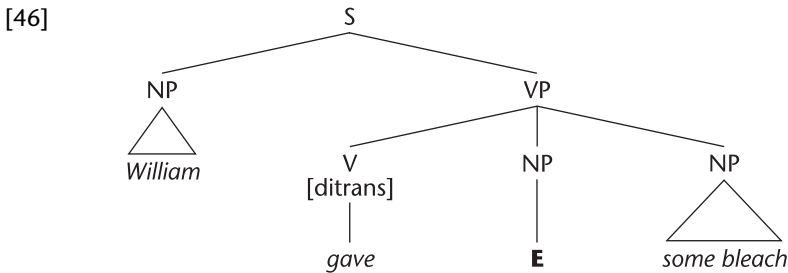

where 'E' indicates an ellipted element, in this case an NP functioning as indirect object.

Before leaving ellipsis, it is worth spending a little time considering how ellipsis interacts with decisions about sub-categorisation.

Compare [47] and [48]:

[47] Max played the tuba in the street.

[48] Max played in the street.

[47] is transitive with an adjunct PP (*in the street*). What about [48]? Well, in context, it could be an elliptical version of [47]. For example, if, as an utterance, it occurred in the context of a conversation about the players of the Chatanooga Stompers, and Max is known to be their tuba player, then [48] would reasonably be understood to mean exactly what [47] means. In such a context, it should be treated as an elliptical transitive sentence, with the dO ellipted. Out of context

(that is, as a sentence rather than an actual utterance), or in another context, [48] is interpreted differently. Here, *play* means the same as ‘play about’ or ‘amuse oneself’. This is an intransitive sense of *play*. As sentences out of context, then, [47] and [48] indicate that *play* belongs to two sub-categories [trans] and [intrans]. It has a distinct sense in each.

Compare now [49] and [50].

[49] Jean-Pierre ate the couscous rapidly.

[50] Jean-Pierre ate rapidly.

Should we assign *eat* to two sub-categories, [trans] in [49] and [intrans] in [50]? Or should we treat [50] as an elliptical [trans] with the direct object omitted?

Eat is different from *play* in that one always has to eat something. As we saw, one doesn’t always have to play something; it depends on the sense of *play*. This suggests that [50] should be treated as [transitive] with an ellipted direct object.

Sentence adverbials (S adverbials)

All the adverbials looked at so far are adjunct adverbials. They are modifiers of a VP within a higher VP. **Adjunct adverbials, then, could just as well be called ‘VP-adverbials’.** In this section I contrast them with two other kinds of adverbial – DISJUNCT AND CONJUNCT ADVERBIALS – which I shall group together as **sentence adverbials (S-adverbials).**

Compare the [a] and [b] examples in the following pairs:

[51a] Buster admitted everything *frankly*.

[51b] Buster admitted everything, *frankly*.

[52a] Max can only do the tango *rather awkwardly*.

[52b] Max can only do the tango, *rather awkwardly*.

[53a] Helmut interfered *between you and me*.

[53b] Helmut interfered, *between you and me*.

In the [a] examples the italicised constituent functions as an adjunct adverbial, a VP modifier. In [51a], *frankly* tells us the manner of Buster’s admission (Buster was frank). But this is not how you understand [51b], with the comma. Here, *frankly* describes how the speaker/writer of [51b] feels she herself is expressing what she has to say. Here it is the speaker/writer who is being frank in saying that Buster admitted everything. [52a], with the VP-adverbial, expresses the idea that the manner of Max’s tango-dancing is awkward. It does not imply that the tango is Max’s only dance. By contrast, in [52b], nothing is said about *how* Max dances the tango, but it does say that the tango is Max’s only dance. [52b] expresses the idea that, however gracefully Max might dance the

tango, the speaker/writer feels that its being Max's only dance is a rather awkward fact. The same sort of distinction goes for [53a/b]. In [53b] *between you and me* is being used to mean the same as *confidentially* (the speaker/writer of [53b] is being confidential is saying that Helmut interfered), but not in [53a].

All the [b] examples are sentence adverbials – more specifically, disjunct adverbials. **Disjunct adverbials provide some comment by the speaker/writer about what she is reporting or about how she feels she herself is expressing what she has to say.** They are called ‘S-adverbials’ because, in contrast to the VP-adverbials of the last section and in the [a] examples above, the adverbial does not modify anything *within* the sentence. They are, in fact, only very loosely associated with the sentence. This feeling is borne out by the use of the comma in writing and by a distinct intonation in speech. Notice that the S-adverbial interpretation is much the more natural interpretation when the adverbial occurs at the beginning of the sentence (and in [52c] it's the only possible interpretation):

[51c] Frankly, Buster admitted everything.

[52c] Rather awkwardly, Max can only do the tango.

[53c] Between you and me, Helmut interfered.

Angry letters are sometimes written to newspapers about the use of *hopefully* in [54b] as against its use in [54a]:

[54a] He will look up hopefully.

[54b] He will look up, hopefully. (Hopefully, he will look up.)

Why this should be is not clear. *Hopefully*, just like *frankly*, *between you and me*, *confidentially*, and *rather awkwardly* – and innumerable other adverbials – can (and does) function both as a VP-adverbial (as in [54a]) and as an S-adverbial (as in [54b]). *Stupidly* is another example: compare [a] *He answered the question stupidly* with [b] *Stupidly, he answered the question*.

As mentioned, **instead of modifying some element *within* the sentence, the S-adverbial relates to the sentence as a whole, considered as a unit.** So, as suggested by the terms ‘VP-adverbial’ and ‘S-adverbial’, the distinction between [51a] and [51b] is the distinction between *frankly* functioning as a modifier of VP within a higher VP vs. functioning as a modifier of S within a higher S, as in [55].

[55a]

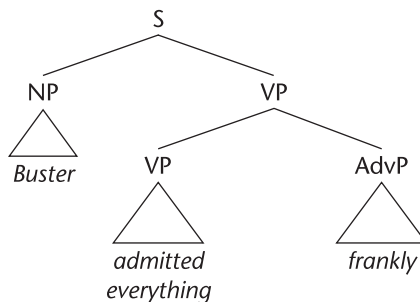

[55b]

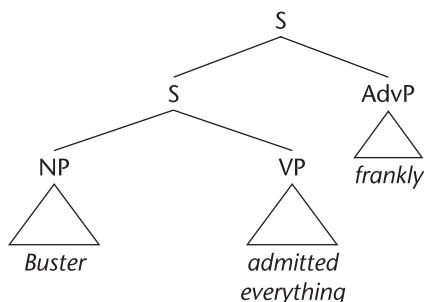

If the S-adverbial appears at the beginning, it should be represented as a preceding sister of the S it modifies – just as, if the VP-adverbial appears between the subject NP and the VP, it should be represented as a preceding sister of the VP.

All the adverbials looked so far can function both as VP (adjunct) adverbials and as S-adverbials. Some AdvPs and PPs can *only* be interpreted as VP-(adjunct) adverbials. Examples (if you think about it) are: *sideways, daintily, noisily, with grace and speed*. On the other hand, there are AdvPs and PPs that can only function as S-adverbials. Examples are: *admittedly, certainly, of course, perhaps, possibly*.

In particular, there is a group of AdvPs and PPs that have a quite specific interpretation and can only have an S-adverbial function. Examples are: (AdvPs) *nevertheless, therefore, furthermore, thus, however, incidentally*, and (PPs) *on the contrary, by contrast, in other words, for a start, in short, in conclusion, on the other hand*. Such S-adverbials are sometimes more specifically referred to as ‘**CONJUNCT ADVERBIALS**’. They indicate what kind of relation holds between the sentences they modify and the preceding or following discourse. As S-adverbials, they have no function within the sentence they modify. They serve to link distinct and grammatically unconnected sentences into a coherent and structured discourse. As a result, notice that when a conjunct S-adverbial is present, the sentence sounds odd in isolation, as if it has been ripped out of a context:

[56] In short, you’re fired.

[57] You’ve got no clothes on, for a start.

[58]

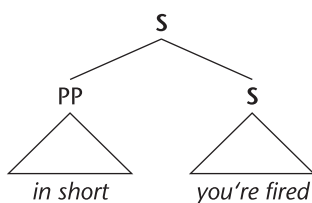

The representation of S-adverbials as sisters of S (within another S) is again a simplification, however. Like VP-(adjunct) adverbials, S-adverbials can appear

in a variety of positions, not only at the beginning and the end of sentences, but actually inside the sentences they modify:

[59] Rashid, *on the other hand*, came dressed as a washing machine.

In these first five chapters, the general structure of simple sentences has been outlined. In the next two chapters, I go into more detail on the structure of simple sentences.

Discussion of in-text exercises

1.

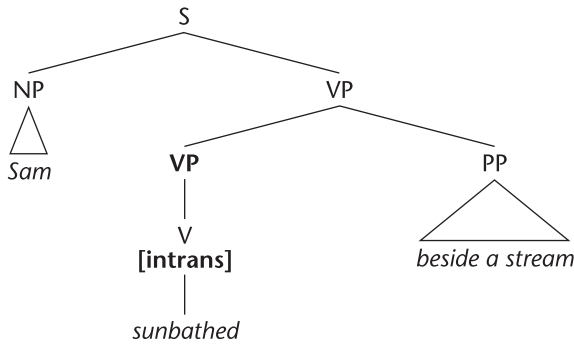

Beside a stream is a VP-adverbial. As an [intrans] V, *sunbathed* forms a VP in its own right. Notice that we could continue with . . . *and Ferdinand did so on the verandah*, meaning ‘Ferdinand sunbathed on the verandah’. Here *did so* replaces the [intrans] VP, *sunbathed*.

2.

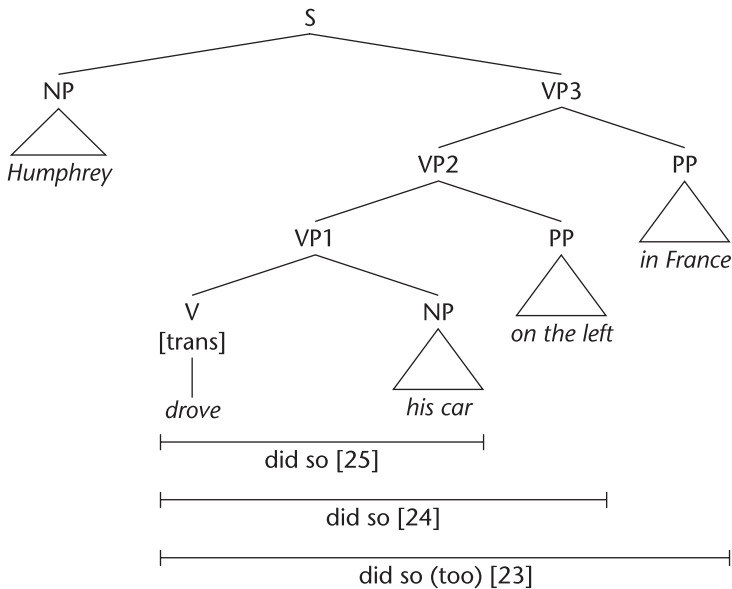

3. Intuitively, *last night* modifies [*hardly slept*] and is thus the higher of the two adjuncts. A hint that this analysis is correct: *last night* can move to the front of the sentence without change of meaning and this leaves *hardly slept* as a clear VP. But *hardly* cannot move:

- (a) Last night, she hardly slept (b) *Hardly, she slept last night.

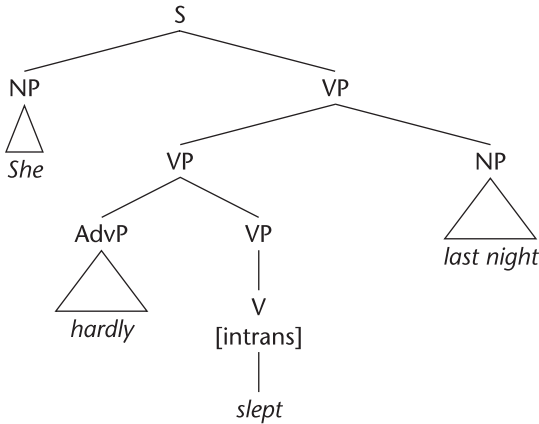

4. (a) Transitive phrasal verb + NP (*shouted the answers out*).
 (b) Prepositional verb + PP (**looked the window out*).
 (c) Prepositional verb + PP (**hangs the office about*).
 (d) Transitive phrasal verb + NP (*handed the money over*).
 (e) Prepositional verb + PP (cf. **viciously turned John on*).

Viciously was included in order to rule out the interpretation in which John is excited. On this latter interpretation, *turned on John* clearly is a [phrasal verb + NP] and in fact sounds much better with the particle moved (cf. *turned John on*).

- (f) Transitive phrasal verb + NP, meaning 'completed the term' (*saw the term through*).
 (g) Transitive phrasal verb + NP (*handed my essay in*).
 (h) Prepositional verb + PP (**saw the disguise through*).

What these examples show is that **the distinction between [phrasal verb + NP] and [prepositional verb + PP] is NOT a distinction between an idiomatic construction and a non-idiomatic construction.** As (c), (e), and (h) illustrate, the combination of prepositional verb and PP (e.g. *saw through the disguise*) can be quite as idiomatic as a phrasal verb + NP (*saw through the term*). Idiomaticity is independent of, and cuts across, the phrasal/prepositional distinction.

Exercises

- Identify the sub-category of the V and the functions of the major elements in the following sentences in terms of **S**, **V**, **dO**, **iO**, **sP**, **oP**, **PC**, **aA** (for adjunct adverbial), and **sA** (for sentence adverbial).
 - That so-called music very quickly drove him mad.
 - Margaret and Michael celebrated their success with a bottle of champagne.
 - They were in the office for twelve hours every single day.
 - Incidentally, I sold your vests to the museum for a small fortune.
 - The acrobats often slept until ten o'clock.
 - Luckily enough, they gave in in seconds.
 - Murdstone brought the child up too strictly, in my opinion.
 - Few students worry about exams until the end of term.

- Having checked the answers to exercise 1, draw phrase markers for sentences (a) – (f), using triangles where appropriate. As regards (e): it contains a preceding adjunct and a following adjunct and, as in in-text Exercise 3, you will have to decide which of these adjuncts is the highest.

- The following verbs are all transitive. Try and decide for each verb whether the absence of a direct object should be treated (**a**) as an instance of ellipsis or (**b**) as indicating that the verb also belongs to the intransitive sub-category (cf. the discussion of *play* in this chapter).

read, launch, kick, jump, recall, pay.

- Look carefully at the following sentences and decide on the sub-category of the V and the functions of the italicised constituents. Some questions to ask yourself: Does *appear* belong to one sub-category or to more than one? Is (e) elliptical? Does *appear* have the same sense in all cases? Are any of the sentences ambiguous?

- Hieronimo appeared *rather jumpy*.
- Hieronimo appeared *a veritable tyrant*.
- Hieronimo appeared *in a flurry of snow*.
- Hieronimo appeared *in a dangerous mood*.
- Hieronimo appeared.

- Let's agree that the following sentence is ungrammatical:

- *Tim went to the circus and Max did so to the zoo.

And let's assume that it is supposed to mean (or is an ungrammatical way of saying)

- Tim went to the circus and Max went to the zoo.

Now tackle the following questions in order:

- (1) What string of words does *did so* replace in (a)?
- (2) What does the ungrammaticality of (a) tell you about the CATEGORY of the string it replaces?
- (3) On the basis of your answers to (1) and (2), decide whether the PP *to the circus* is an adjunct or a complement of the verb.
- (4) On the basis of your answer to (3), how should we sub-categorise *go* in (a)?
- (5) Look at the following conversations:
 - (c) A: Where's Maria? B: She went.
 - (d) A: Great party, wasn't it! B: Even Maria went!

How do you suggest we handle the sub-categorisation of *go* in each of these uses?

6. The senses of *discover* in the following two sentences are quite different.

- (a) Kelvin discovered the 2nd Law of Thermodynamics in his study.
- (b) Max discovered rats in his study.

The two senses correspond to two different verb subcategories. Draw phrase markers for (a) and (b) that reflect this difference. (Abbreviate 'the 2nd law of Thermodynamics' to 'the law'.)

Discussion of exercises

1. (a) [This so-called music] [very quickly] [drove] [him] [mad]
 S aA V dO oP
 [complex]
- (b) [Margaret & Michael] [celebrated] [their success] [with a bottle of champagne]
 S V dO aA
 [trans]
- (c) [They] [were] [in the office] [for twelve hours] [every single day]
 S V sP aA aA
 [intens]
- (d) [Incidentally] [I] [sold] [your vests] [to the museum] [for a small fortune]
 sA S V dO iO aA
 [ditrans]
- (e) [The acrobats] [often] [sleep] [until ten o'clock]
 S aA V aA
 [intrans]
- (f) [Luckily enough] [they] [gave in] [in seconds]
 sA S V aA
 [phrasal]
 [intrans]

- (g) [Murdstone] [brought] [the child] [up] [too strictly] [in my opinion]
 S V dO Prt aA sA

[phrasal]
 [trans]

- (h) [Few students] [worry] [about exams] [until the end of term]
 S V PC aA

[prep]

2. (a)

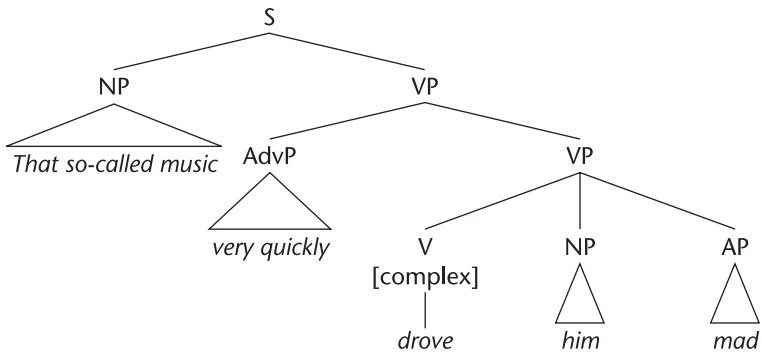

(b)

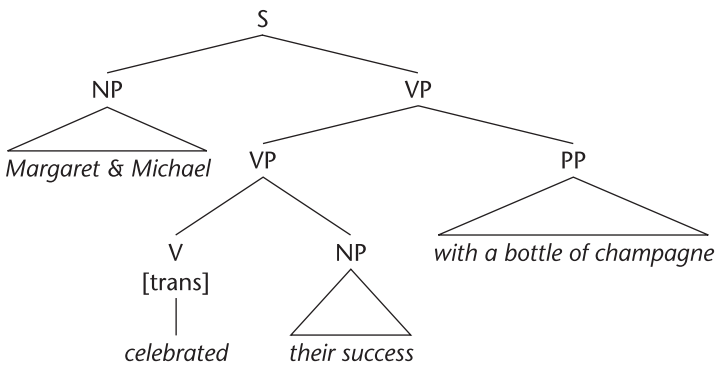

(c)

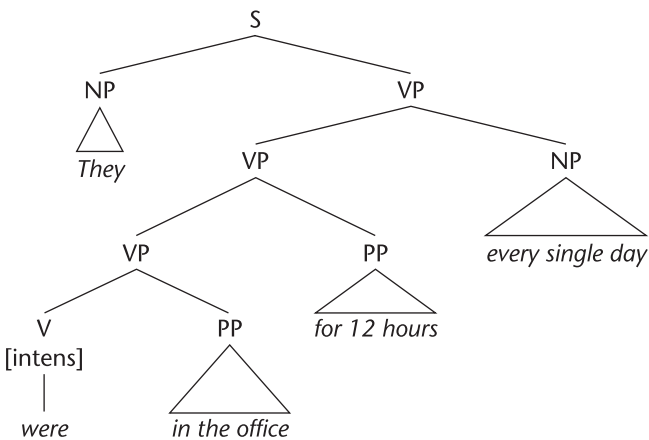

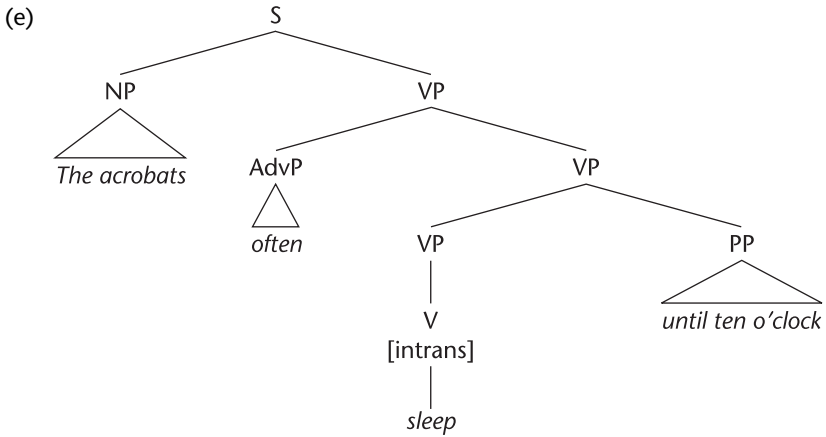
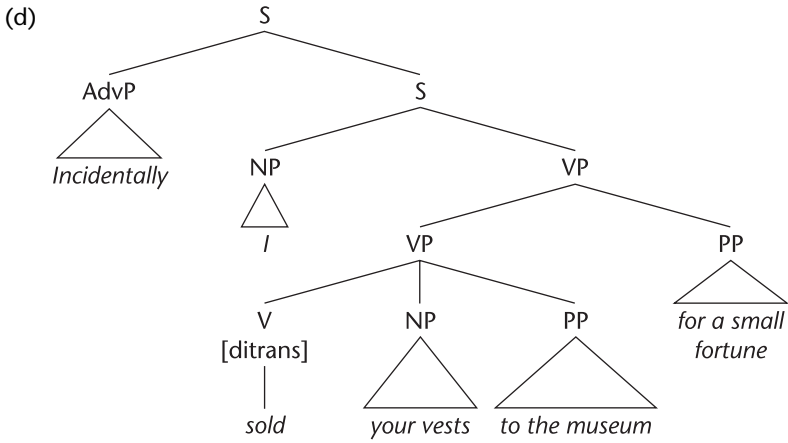

Note: *Often the acrobats sleep until ten* vs. **Until ten the acrobats often sleep*.

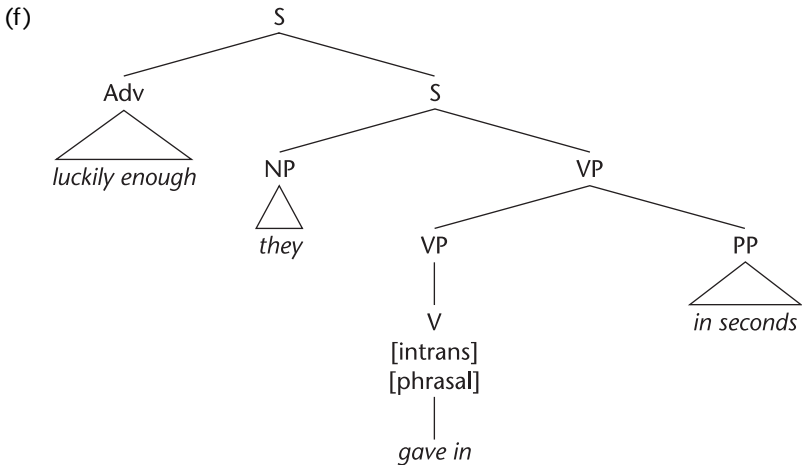

3. This exercise is a matter of judgement rather than getting the answer right or wrong. My judgements are as follows. The verbs seem to fall into three groups:

(a) *jump* and *kick* (b) *read* and *pay* (c) *recall* and *launch*

(a) *Jump* and *kick* are similar; you can jump a stack of books and kick an obstinate car but, in another sense of the verb, you can jump without jumping anything (jumping up and down) and you can just kick (babies do it all the time). So *jump* and *kick* belong to both sub-categories [transitive] and [intransitive].

(b) *Read* and *pay* are similar to *eat*. You do always have to read SOMETHING. And when after a meal you inform your partner that he/she is 'paying', they will understand that it is the bill that is to be paid. So both *read* and *pay* are [transitive] and the absence of a direct object is a matter of ellipsis. Notice that both *pay* and *read* can also be [ditransitive]: *They paid me the money* and *I read her a story*. *Pay* is also [prep]: *she paid for the meal*.

(c) I have grouped *launch* and *recall* separately from *pay* since, while they are clearly [transitive] and require a direct object, they require it so strongly that it is almost unacceptable to omit the object by ellipsis. These are [transitive] only.

4. In (a) *appear* is complemented by an AP. This indicates that the verb is [intensive], with the AP functioning as subject-predicative. The complement NP in (b) has the same relation to the verb and the subject as the AP in (a), so again there is no reason not to take the verb in (b) as [intensive], complemented by a subject-predicative. We usually find that [intensive] verbs can be complemented either by an AP, NP, or PP. So we might expect the verb in (c) to be [intensive] again, with the PP functioning as subject-predicative. But notice that the sense of *appear* in (c) is quite distinct from that in (a) and (b). (a) and (b) can be paraphrased by (f) and (g):

(f) Hieronimo appeared *to be* $\left\{ \begin{array}{l} \text{rather jumpy.} \\ \text{a veritable tyrant.} \end{array} \right.$

(g) *It appeared that Hieronimo was* $\left\{ \begin{array}{l} \text{rather jumpy.} \\ \text{a veritable tyrant.} \end{array} \right.$

Here the verb has a sense similar to *seem*. (c), by contrast, can't be paraphrased in these ways:

(h) Hieronimo appeared to be in a flurry of snow.

(i) It appeared that Hieronimo was in a flurry of snow.

Here the verb has the sense of 'come into view' or 'turn up'. It can be paraphrased by (j).

(j) Hieronimo appeared, and *did so* in a flurry of snow.

Compare this with (a) and (b). In the sense of the verb in (c)/(j), *appear* is [intransitive] with the PP functioning as an (optional) adverbial.

Coming to (d) now, notice it's ambiguous: it can have either the sense it has in (a) and (b) (*Hieronimo appeared to be in a dangerous mood*) or the sense it has in (c) (*Hieronimo appeared and did so in a dangerous mood*). On the first interpretation, we have an [intensive] V complemented by a PP as subject-predicative; on the second, an [intransitive] V modified by an optional PP as adverbial.

As for (e), this is a non-elliptical [intransitive] sentence, not an elliptical [intensive] sentence. Since *appear* also belongs to the [intransitive] sub-category, the subject-predicative cannot, in fact, be ellipted with the [intensive] sense of the verb. In ellipting the subject-predicative, the speaker would risk having *appear* misunderstood and analysed by her hearers as [intransitive].

5. (1) *Did so* replaces *went*.
- (2) Since *do so* only replaces VPs and since (a) is ungrammatical, we may conclude that *went* does not constitute, in itself, a VP (though it is, of course, a V).
- (3) If *to the circus* was an adjunct, it would be the sister of a VP (within a higher VP). In that case, *went* would have to be analysed as a VP. But *went* isn't a VP (as shown in (2)). So the PP can't be an adjunct. If, on the other hand, the PP is a complement, then it must be a sister of the V and form a VP with that V. And notice that *do so* can indeed replace the string *went to the circus* as in:
Max went to the circus and Hogarth did so (too).
 So it appears that we must analyse the PP as a complement. It is only by doing this that we can avoid analysing *went* as a full VP in its own right.
- (4) We must analyse *go* as a prepositional verb.
- (5) Two quite different senses of *go* are involved here. In (c), the verb is used in the sense of 'leave' or 'depart' and is [intransitive]. *Go*, therefore, is both an [intransitive] and a [prepositional] verb. In (d), on the other hand, the verb is interpreted, in the given context, as *went to the party*. The prepositional complement is understood. This is an elliptical use of the [prepositional] verb.

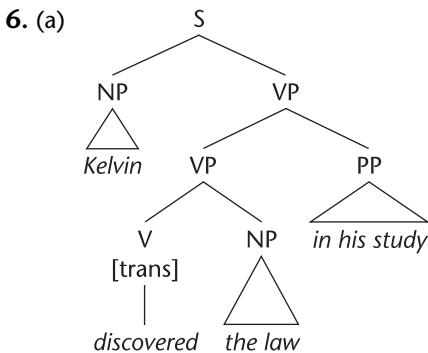

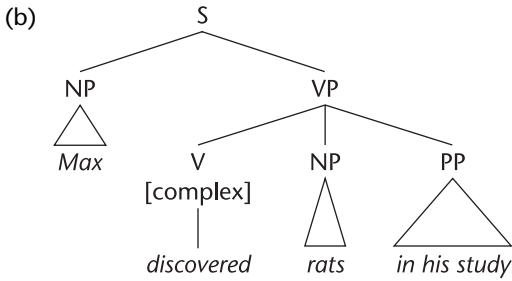

In (b) there is an intensive (predicative) relation between *rats* and *in his study* – Max discovered that rats were in his study. Kelvin of course did *not* discover that the law was in his study. He just happened to be in his study when he discovered the law.

Further exercises

Here are three sets of sentences, illustrating all the points made in the last two chapters. Draw phrase markers for them. Allow yourself plenty of room. Ambiguous examples will need two phrase markers. The examples become more intricate, and may admit of more discussion, as the sets progress. Those in Set I don't include sentence-adverbials; this will allow you to concentrate more on the distinction between verb complements (sisters of V) and VP-(adjunct) adverbials (sisters of VP).

Example: *Their spokesman's pronouncements quickly landed him in gaol.*

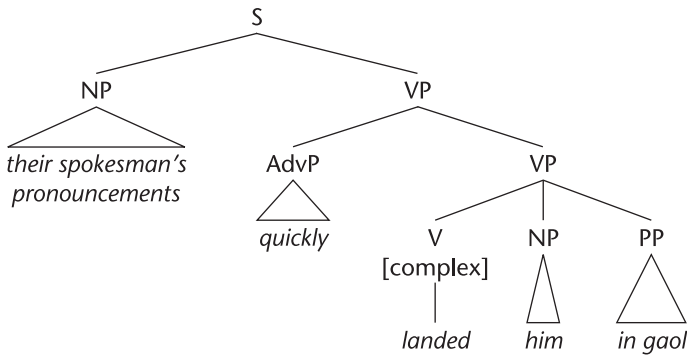

Set I

1. The trainees got much quicker over those three months.
2. All our planes landed within twenty minutes.
3. Millie silently bottled up her feelings.
4. The speaker made this the main point of his argument.

5. The boss wished all his staff a Merry Christmas.
6. My housekeeper never believed in ghosts.
7. Matilda and her friends polished off the toast by eight thirty.
8. He opened his mail very reluctantly that morning.
9. It rained for three hours on the Continent last night.
10. Martha left the bathroom in an awful mess. (ambiguous)

Set II

1. They often seem really nervous at first.
2. They lived in Paris quite happily for a good ten years.
3. The old man grew increasingly intolerant, in my opinion.
4. They decided on the train. (ambiguous; elliptical on one interpretation)
5. You turned the high-wire into a death-trap, for your information!
6. The trapeze artistes asked for a meeting with the circus management.
7. Floyd's surprise puddings always blow up in your face.
8. He cooked us a delicious meal with just pasta and soy for the price of a Coke.
9. The architects positioned the windows too close to each other in the earlier building.
10. Amazingly, they allowed him total freedom without a thought for the consequences.

Set III

1. The drunken recruits repeatedly tripped over the guy ropes until the early hours.
2. He never looked back on his years at sea with much nostalgia, however.
3. Unfortunately, his new rotting compound quickly leaked into the foundations.
4. Several figures gingerly edged towards the precipice in full view of the police.
5. She ignored all those people in the studio. (ambiguous)
6. She kept all those people in the studio. (ambiguous)
7. Interestingly, Matilda barely gets on with her new colleagues.
8. They soon ran out of energy and for ten hours slept like babies.
9. The butler usually mopped up the crumbs after each course in the old days.
(This will need careful attention to the meaning in deciding what constituents each of the (three) adverbials is modifying.)
10. Time flies like an arrow but fruit flies like a banana. (Groucho Marx)

6

More on verbs: auxiliary VPs

This chapter comes in two parts.

Part I: Lexical and auxiliary verbs. Here I first explain the various forms and the ordering of lexical and auxiliary verbs. Then I explain how auxiliary verbs figure in the structure of VP.

Part II: Constructions that depend on auxiliary verbs. Here I explain three sentence constructions that crucially involve auxiliary verbs: passive sentences, negative sentences, and questions.

Part I: Lexical and auxiliary verbs

As explained, every full (non-elliptical) VP includes a **LEXICAL verb** and it *may* contain one or more **AUXILIARY verbs**. So far we have only looked at sentences containing a lexical verb. My main purpose here is to introduce auxiliary verbs.

I listed the auxiliaries in Chapter 4. Here's the list again: *be*, *have*, and *do* (these three can also be lexical, though with different senses) and *can/could*, *will/would*, *shall/should*, *may/might*, *must*, and *need*. *Be*, *have* and *do* are sometimes called **PRIMARY AUXILIARIES**. This serves to contrast them with the rest, which are all **MODAL AUXILIARIES**.

I'll use *fill* as my example of a regular lexical verb and *write* as my example of irregular lexical verb. These are in italics in [2]–[5]. The auxiliary verbs are in bold.

- | | |
|--|---|
| [1a] Daisy <i>fills/filled</i> the pool. | [1b] Max <i>writes/wrote</i> nothing. |
| [2a] Daisy will/would <i>fill</i> the pool. | [2b] Max can/could <i>write</i> nothing. |
| [3a] Daisy has/had <i>filled</i> the pool. | [3b] Max has/had <i>written</i> nothing. |
| [4a] Daisy is/was <i>filling</i> the pool. | [4b] Max is/was <i>writing</i> nothing. |
| [5a] The pool is/was <i>filled</i> . | [5b] Nothing is/was <i>written</i> . |

These examples show that, in a sequence of verbs,

- A) it is always **JUST THE FIRST verb** – whether lexical or auxiliary – that displays the **TENSE** distinction between **PRESENT** and **PAST**;

- B) auxiliary verbs (if present) always PRECEDE the lexical verb;
 C) the form of a verb is determined by the verb that precedes it.

In [2]–[5], I’ve given examples containing just one auxiliary each. In fact, there can be **up to four auxiliaries**. For the moment, though, let’s keep things simple.

Tense and time

Verb forms that are tensed are traditionally called **FINITE verb forms**. All other verb forms are **NON-FINITE (not tensed)**. Every sentence must contain a finite verb. **In the absence of any auxiliary, it is the lexical verb that is tensed (finite)**. So I’ll start by looking at tense in lexical verbs, as in [1a–b] above.

Fill is a **REGULAR** lexical verb. That’s to say, its present tense form consists of the basic **STEM, V** itself, plus the **PRESENT TENSE INFLECTION -s**, and its past tense form consists of the stem plus **THE PAST TENSE INFLECTION -ED**.

There are many irregular lexical verbs. As indicated, *write* has the irregular past tense *wrote*. Other lexical verbs with an irregular past tense are *give* (*gave*), *forbid* (*forbade*), *see* (*saw*), *go* (*went*), *leave* (*left*), and *meet* (*met*). And there are lexical verbs which are irregular in that, even when interpreted as being in the past tense – and thus as finite – they don’t have a past tense form distinct from their bare stem form (V). Examples are *put*, *bet*, *read*, and *hit*. Compare [6a] and [6b].

[6a] He puts it in his ear. (pres) [6b] He put it in his ear. (past)

Put in [6b] is shown to be in the past tense – and thus a finite form of the verb – by the fact that, if we replace it with, say, *leave* and don’t change the meaning of the sentence in any other way, we would replace it with *left*, which is an overtly past tense form (*He left it in his ear*).

Although it is irregular for a lexical verb not to change its form in the past tense, it is perfectly regular for verbs not to change from their stem form in the present tense. In fact, a lexical verb only changes its form in the present tense when (as in [1a]) the subject NP is *he*, *she*, *it*, or any Noun Phrase that could be replaced by one of those pronouns (e.g. *Daisy*). Such NPs and pronouns are **THIRD PERSON SINGULAR NPs**. In all other cases, the present tense form of the verb is identical to the bare stem form. The only exception to this general rule is the verb *be*:

[7]			FILL	BE	
	Number	Person	Pres	Pres	Past
	singular	{ 1st (<i>I</i>)	<i>fill</i>	<i>am</i>	<i>was</i>
		{ 2nd (<i>you</i>)	<i>fill</i>	<i>are</i>	<i>were</i>
		{ 3rd (<i>he, she, it</i>)	<i>fill-s</i>	<i>is</i>	<i>was</i>
	plural	{ 1st (<i>we</i>)	<i>fill</i>	<i>are</i>	<i>were</i>
		{ 2nd (<i>you</i>)	<i>fill</i>	<i>are</i>	<i>were</i>
		{ 3rd (<i>they</i>)	<i>fill</i>	<i>are</i>	<i>were</i>

This change of form in the finite verb according to the number and person of the subject NP is called **SUBJECT-VERB AGREEMENT**. So, English verbs display overt subject-verb agreement only in the present tense and then only with a third-person singular subject.

How are you supposed to know, when a verb appears in the bare stem form, whether it is finite (in the present tense – as in *they fill the pool*) or non-finite (not tensed)? Well, change the subject (e.g. *they*) to a third-person singular NP (e.g. *she, Daisy*): if it is finite – tensed for present – the verb will change to the -s form, *fills*.

How should we represent tense in phrase markers? In this book I am primarily concerned with whether a verb is finite – tensed for present or past. These are matters of syntax. I am less concerned with the actual FORM a verb takes when tensed for present or past. This is more a matter of morphology, phonology, and spelling. So, in phrase markers, I won't attempt to segment a tensed verb into a verb stem and a tense inflection. Instead, from now on I'll decorate the V node with a TENSE FEATURE, as in [8] and [9].

[8]	V	[9]	V
	[trans]		[trans]
	[pres]		[past]
	{ <i>fill(s)</i> }		{ <i>filled</i> }
	{ <i>write(s)</i> }		{ <i>wrote</i> }

I mentioned that it is always *just the first verb* – whether lexical or auxiliary – that is finite. So it is only in [1] above that the lexical verb is finite (present or past). In [2]–[5], the lexical verb follows an auxiliary verb, so it is the auxiliary that is finite. The various forms of *fill* and *write* in [2]–[5] are all un-tensed (non-finite) forms. These forms are determined by the auxiliary verb that precedes them. More on this in a moment.

With the irregular verb *write*, the difference between the finite (past tense) form, *wrote* in [1b], and the non-finite form in [3b] and [5b], *written*, is clear for all to see. Not so with *fill*! The non-finite form of *fill* in [3a] and [5a] is identical to the past tense (and thus finite) form: *filled*. Confusing, perhaps – but not if you remember that only the FIRST verb in a sequence of verbs can be finite

(present or past). All verbs following an auxiliary verb are non-finite (neither present nor past).

English has just two TENSES: Present and Past. You may be wondering about the future. Future TIME is expressible in a variety of ways – for example, by means of the auxiliary (modal) verb *will*, as in *He will go* – but there is no future TENSE as such.

It is important to recognise that there is no simple correlation between the grammatical category TENSE and the notion of TIME. For example, in the right circumstances, both present tense and past tense are compatible with the expression of future time, as shown by [10] and [11]:

[10] The boat *leaves* at ten tonight. (Present tense – future time)

[11] If he *gave* me the bleach tomorrow, I'd use it. (Past tense – future time)

Furthermore, *will* is capable of expressing ideas other than future time, as in [12], which is an exasperated way of saying he *is* always doing it:

[12] He *will* keep pestering me!

In addition – as we shall see with the auxiliary verb *have* – there are more ways of expressing PAST TIME than using PAST TENSE.

The contrast between lexical and auxiliary verbs

The two most important differences between lexical and auxiliary verbs are these:

1. In QUESTIONS, auxiliary verbs can move in front of the subject NP. A lexical verb cannot.
2. The NEGATIVE PARTICLE (*not* or *n't*) can attach to an auxiliary verb but never to a lexical verb.

Compare the auxiliary verbs in [13] and [14] with the lexical verbs in [15] and [16]:

[13] [a] He can go. [b] Can he go? [c] He cannot/can't go.

[14] [a] He is going. [b] Is he going? [c] He is not/isn't going.

[15] [a] He spoke. [b] *Spoke he? [c] *He spoke not (*spoken't).

[16] [a] He drinks. [b] *Drinks he? [c] *He drinks not (*drinksn't).

The correct forms for [15b–c] and [16b–c], of course, are

[17] [b] Did he speak? [c] He didn't speak.

[18] [b] Does he drink? [c] He doesn't drink.

which involve the auxiliary verb *do*. This is dealt with in Part II of this chapter.

I have listed *need* among the modal auxiliary verbs. In fact, there are two verbs *need*, one an auxiliary, the other lexical – with a subtle difference in meaning:

LEXICAL	AUXILIARY
[19a] He doesn't need $\left\{ \begin{array}{l} \text{to go.} \\ \text{a drink.} \end{array} \right.$	[19b] He needn't go.
[20a] Does he need $\left\{ \begin{array}{l} \text{to go} \\ \text{a drink?} \end{array} \right.$	[20b] Need he go?

As indicated, the lexical verb can take a direct object NP – *a drink* – so it's transitive. By contrast, **auxiliary verbs never take an NP complement**. So when *need* behaves like an auxiliary – in accepting negation and moving in the question – it cannot take an NP complement:

[21a] *He needn't a drink. [21b] *Needs he a drink?

Notice that, following the lexical verb *need* – but not auxiliary *need* – the following verb is introduced by *to*. This is THE INFINITIVE PARTICLE (discussed in Chapter 10). This then illustrates a **third distinction between auxiliary and lexical verbs: when a verb follows a lexical verb, it can be introduced by THE INFINITIVE PARTICLE *to* but not when it follows an auxiliary verb**. For example, *hope* and *forget* are lexical verbs and, when they are followed by another verb, that other verb is lexical and is introduced by *to*: *He hopes to pass but he forgot to study*. I explain this in Chapter 10.

In what follows, I say more about the four kinds of auxiliary verb and their (very strict) ordering.

Modal auxiliaries (MOD)

Modal auxiliary verbs ('modals', for short) are special – quite different from other verbs, both lexical and auxiliary.

For a start, **modals are always tensed (finite)**. They do not have untensed (**non-finite**) forms. This distinguishes them from the primary auxiliaries (*do*, *have* and *be*) and from lexical verbs.

PRESENT: can will shall may
 PAST: could would should might

You may be surprised to hear that *will* is present tense, since it usually has a future-time meaning. *Will* in the present tense provides one way of referring to what *is* (at the present) a future point in time. In the past tense (*would*), it provides a way of referring what *was* (in the past) a future point in time. Compare [22] and [23]:

[22] (Present): He *says* he *will* come.

[23] (Past): He *said* he *would* come.

The modal verbs *must* and *need* don't even have a past tense form but just the one (present tense) form already given. Compare this situation with that which holds with a lexical verb like *give*. Besides its finite (present and past tense) forms, *give(s)* and *gave*, it has three non-finite forms: (i) *give* (the stem form, as in *to give*), (ii) *giving*, and (iii) *given*. Notice that, in contrast to auxiliary *need*, lexical *need* does have a past tense form. *He needed to go* (preceding the infinitive particle *to*) and *He needed a drink* (taking an NP complement) are fine.

A further peculiarity of modals is that they never show subject-verb agreement. They don't change their form in the present tense even with a third-person singular subject NP (so we have *She can go*, not **She cans go*).

Recall that it is always just the first verb in a sequence of verbs that is finite (tensed). It follows from this that, since modals are always tensed, they always come first in any sequence of verbs. It also follows that, in a sequence of verbs, there can be only ONE modal verb (**He could would go*, **He will must go*).

I'll represent the modal as 'MOD' and decorate it with a tense feature, as in [24] and [25]:

[24] MOD
[pres]
|
can

[25] MOD
[past]
|
could

I have mentioned that every auxiliary verb determines the form of the following verb. The verb that follows a MODAL auxiliary always appears in its (non-finite) STEM form. This applies whether the following verb is lexical – as in [2a–b] above, (*would*) *fill* and (*can*) *write* – or another auxiliary.

The perfect auxiliary – *have* (PERF)

There are two verbs *have*, lexical and auxiliary. The lexical verb is transitive, taking an NP complement, as in *I have a lovely bunch of coconuts*. Auxiliary *have* is described as the 'PERFECT' auxiliary. Perfect *have* is always followed by another verb (ellipsis aside). This was illustrated in [3] above:

[3a] Daisy has/had *filled* the pool. [3b] Max has/had *written* nothing.

Since it is the first verb in the VP in these examples, *have* appears in a finite form: present tense (*has*) or past tense (*had*). Remember, though, that the form of a tensed verb does not always differ from the basic stem. If the subject were not third-person singular, the present tense form would be *have* – e.g. *We HAVE written nothing*.

You will have noticed in [3a–b] that, even though *have* is in the present tense, those sentences refer to past time. This is a prime example of the lack of correlation between time and tense, mentioned earlier. There are more ways of referring to the past than using the past tense. The perfect auxiliary *have* provides a way of referring to past TIME independently of past TENSE. Perfect *have* in the present tense allows for reference to a present state of affairs resulting from a past event, as in *He has gone*. Contrast this with *He went* – simple past tense – which refers just to a past event. With perfect *have* in the past tense (as in *had written*), we have a reference to a period of time that was past at a past point in time – the ‘past in the past’.

The verb that follows perfect *have* always appears in its (non-finite) PERFECT PARTICIPLE FORM. This applies whether the following verb is a lexical or another auxiliary. *Written* in [3b] is the perfect participle form of *write*. Participle forms are non-finite. I’ve called it the ‘PERFECT PARTICIPLE’ to highlight the fact that this form is determined by the preceding PERFECT *have*.

As noted, *write* belongs to a group of verbs that are irregular in that their perfect participle form clearly differs from their past tense form (*written* vs. *wrote*). Other verbs that pattern like *write* in this respect are *forbid*, *give* and *go*. And the verb *be* – the most irregular verb in the language – is no different in this respect. By contrast, with many verbs – in fact, with all regular verbs (e.g. *fill*) and some irregular verbs (e.g. *put*) – the perfect participle form is identical to the past tense form:

[26] V	past tense	perfect participle	
<i>forbid</i>	<i>forbade</i>	(have) <i>forbidden</i>	} irregular
<i>give</i>	<i>gave</i>	(have) <i>given</i>	
<i>go</i>	<i>went</i>	(have) <i>gone</i>	
<i>be</i>	<i>was/were</i>	(have) <i>been</i>	
<i>put</i>	<i>put</i>	(have) <i>put</i>	
<i>fill</i>	<i>filled</i>	(have) <i>filled</i>	regular

How can you tell whether you are dealing with a (finite) past tense form or a (non-finite) perfect participle form when – as in the last two in [26] – the two are identical? Easy. It is finite (past tense) only if the verb is the first verb in the sequence. If the verb is preceded by perfect *have*, then it must be the non-finite, perfect participle of the verb.

I mentioned earlier that there are two verbs *have*, the transitive lexical verb and the perfect auxiliary. Here are examples that include both:

[27] Aldo *has had* a little chat with the doorman.

[28] By two a.m., I *had had* enough.

In [27] *has* is the perfect auxiliary (present tense) and it is followed by the lexical verb in the perfect participle form (*had*), which happens to be identical to the past tense form of *have*, as illustrated in [28].

I'll represent perfect as 'PERF' and decorate it with the tense feature, as in [29] and [30]:

[29] PERF
[pres]
|
has

[30] PERF
[past]
|
had

Remember, though, that PERF will only have the tense feature if it is the first verb in the sequence. Now that I have introduced MOD and PERF, I can give examples in which they both occur and in which PERF is NOT the first verb in the sequence:

[31] Millie *will have* filled the pool.

[32] Max *could have* written something.

As explained, the lexical verb comes last. And, again as explained, the modal auxiliary (MOD) comes first. It must come first because modals are always tensed. Hence, when perfect *have* co-occurs with a modal, it follows the modal. It is an unbreakable rule of English that perfect *have* precedes the lexical verb and modals precede perfect *have*:

MOD *before* PERF *before* Lexical V.

As already noted, MOD demands that the following verb appears in the (non finite) STEM form, which is the form of perfect *have* in [31] and [32].

The progressive auxiliary – *be* (PROG)

Progressive *be* is easily identified. Look again at [4a–b]:

[4a] Daisy *is/was filling* the pool. [4b] Max *is/was writing* nothing.

In these, the tensed verbs are forms of the progressive auxiliary *be*. As you can see, just as perfect *have* demands that the following verb has the perfect participle form, progressive *be* demands that the following verb has the (non finite) -ING form. Call this the PROGRESSIVE PARTICIPLE, to reflect its dependence on preceding progressive *be*. You'll be pleased to hear (but you already knew!) that the progressive participle (-ing) form is completely regular – invariant for all verbs in the language.

Like *have*, *be* can function either as an auxiliary or as a lexical verb. LEXICAL *be* is the INTENSIVE verb, the COPULA of Chapter 4 – as in [33].

[33] Kubla Khan *was* very extravagant.

In [34], *be* figures twice:

[34] Nanny *is being* a nuisance again.

In [34] *is* is the present tense form of the progressive *be*, and *being* is the progressive participle of the copula.

Now look at [35]:

[35] This turn of events is worrying.

It might seem that [35] includes progressive *be* followed by a lexical verb (*worry*) in the progressive participle form. Not so! The verb *worry* is TRANSITIVE – it requires a direct object. But there is no dO in [35]. So, *worrying* here is not the verb. It's the adjective. Notice that in [35] it can be modified by *very*. This means that *is* in [35] is not the progressive auxiliary. Progressive *be* is always followed by further VERB – but here *be* is followed by an adjective (more strictly, an AP) complementing *be*. So, *is* in [35] is the INTENSIVE lexical verb (the copula).

I'll represent progressive as 'PROG' and decorate it with the tense feature:

[36] PROG
[pres]
|
is

[37] PROG
[past]
|
was

Just as with perfect *have*, PROG will only have the tense feature if it is the first verb in the sequence. Having introduced MOD and PERF, I can give examples in which PROG co-occurs with MOD, with PERF and with both MOD and PERF:

[38] You *may be* wondering about the future. (MOD + PROG)

[39] Millie *has been* using the bleach. (PERF + PROG)

[40] Bill *might have been* teasing you. (MOD + PERF + PROG)

Following the modal in [38], progressive *be* appears in its (non-finite) bare stem form. Following perfect *have* in [39] and [40], it appears in the (non-finite) perfect participle form (*been*).

Again, the ordering of the verbs is absolutely fixed.

MOD *before* PERF *before* PROG *before* Lexical V.

The passive auxiliary – *be* (PASS)

All the examples discussed so far are said to be in the ACTIVE VOICE. They don't contain the passive auxiliary. Sentences that include the passive auxiliary verb *be* are said to be in the PASSIVE VOICE.

Passive *be* was illustrated in [5a–b], repeated here:

[5a] The pool *is/was filled*. [5b] Nothing *is/was written*.

If you compare these with the (active) examples in [1]–[4], you'll see that the choice of passive *be* affects the form of the sentence as a whole. This difference

in the form of sentences with passive *be* – PASSIVE SENTENCES – is discussed in Part II. Here I focus just on passive *be* itself and how it interacts with other verbs.

The obvious point to make is that *be* is also the progressive auxiliary. **How to distinguish between progressive *be* and passive *be*?** The answer lies in the form of the following verb. Following progressive *be*, a verb adopts the progressive participle form (V-ing – e.g. *stealing*). **Following passive *be*, a verb adopts the PASSIVE PARTICIPLE form (e.g. *stolen*).**

Notice that the passive participle form and the perfect participle form are always the same. Since the two participles are the same with every verb in the language, it is traditional not to distinguish them and call them both ‘THE PAST PARTICIPLE’. I have not adopted that term here because it suggests that the form has something to do with past TENSE. It doesn’t. But notice, in passing, that the passive option introduces no new form into the language. Economically, it just recombines forms anyway required for the formation of the perfect and the progressive:

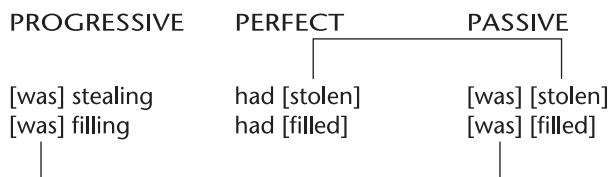

I’ll represent passive as ‘PASS’ and decorate it with the tense feature:

[41] PASS
[pres]
|
is

[42] PASS
[past]
|
was

I hope you can guess what’s coming. Just as with perfect *have* and progressive *be*, PASS will only have the tense feature if it is the first verb in the sequence. PASS can co-occur with any combination of other auxiliaries.

- | | |
|--|----------------------------|
| [43] Your water pistol <i>will be</i> confiscated. | (MOD + PASS) |
| [44] The pool <i>has been</i> filled by Daisy. | (PERF + PASS) |
| [45] Otto <i>is being</i> driven mad by all the noise. | (PROG + PASS) |
| [46] It <i>should have been</i> written by now. | (MOD + PERF + PASS) |
| [47] It <i>may be being</i> written right now. | (MOD + PROG + PASS) |
| [48] It <i>could have been being</i> written. | (MOD + PERF + PROG + PASS) |

As always, it is just the first verb that is tensed and the form of each further verb is determined (in ways outlined above) by the verb that precedes it. It is all very systematic – as is the order of the verbs:

MOD before PERF before PROG before PASS before Lexical V.

So much for the forms – and the order – of auxiliary and lexical verbs. The ordering is clear for all to see. What may not be so obvious is the **HIERARCHICAL STRUCTURE** of VPs in which auxiliaries occur. The next section deals with this.

Where auxiliaries fit in the structure of VP

In discussing subcategories of lexical verbs in Chapter 4, we saw that **complements are sisters to the LEXICAL verb (V) and form a VP constituent with that lexical V**. This is the case **whether or not there happen to be auxiliaries in the sentence**. In the following examples, I have bracketed the VP formed by the transitive verb *study* and its direct object NP *the menu*:

[49a] Monsieur Blanc *will* _{VP}[study the menu]

[50a] Monsieur Blanc *has* _{VP}[studied the menu].

[51a] Monsieur Blanc *is* _{VP}[studying the menu].

What [49a]–[51a] show is that **auxiliary verbs (italicised in [49a]–[51a]) are necessarily followed by VPs**. In fact – and here’s the point – **auxiliaries are verbs that take VP complements**. Notice that, if you omit the bracketed VP in [49a]–[51a], you get a definite feeling of **ELLIPSIS**. Ellipsis, remember, is the omission of an obligatory element that can be understood in the context of utterance.

The bracketed sequences in [49a]–[51a] are shown to be VPs by the fact, continuing as in [49b]–[51b], you can replace them with a form of *do so*:

[49b] . . . and I will do so, too. (*do so* = ‘study the menu’)

[50b] . . . and I have done so, too. (*done so* = ‘studied the menu’)

[51b] . . . and I am doing so, too. (*doing so* = ‘studying the menu’).

And, on the subject of ellipsis, notice you don’t even need *do so*. The lexical VP can simply be ellipped without change of meaning. For [49a/b], for example, this would give . . . *and I will, too*. On the assumption that **only CONSTITUENTS can be ellipped**, this confirms that the lexical verb plus its complement remains a constituent even in the presence of auxiliaries – and it can only be a VP constituent.

Now, in [49a]–[51a], *Monsieur Blanc* is the subject NP. So the rest of the sentence in each case is the VP. For example, in [51a] above, **the VP consists of the progressive auxiliary verb (in the present tense) – *is* – PLUS its VP complement, *studying the menu***. Progressive *be*, in other words, is the **HEAD** of [51a]’s VP.

Given all this, there can only be one phrase marker for [51a]:

[52]

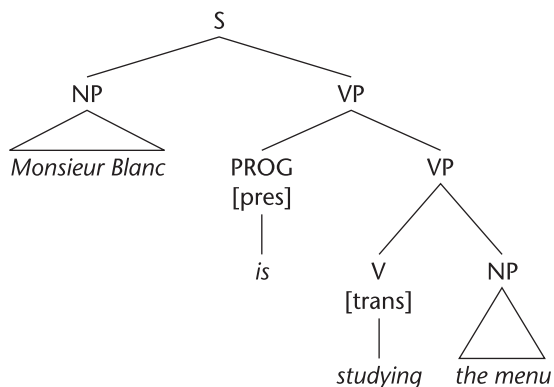

I hope it's obvious what the phrase marker for [50a] must be, so I won't set it as an in-text exercise. (Even so, it's given as **Discussion 1** on page 133.)

By now you are probably thinking, 'More VPs within VPs! I thought sister-of-VP-and-daughter-of-VP was for adverbials.' Well, [sister-of-VP-and-daughter-of-VP] is indeed the sign of a constituent functioning as an **ADVERBIAL** – but **NOT** if that constituent is an **AUXILIARY VERB** – i.e. MOD, PERF, PROG or PASS. Verbs – whether lexical or auxiliary – never function as adverbials.

So, each auxiliary verb is the **HEAD** of its VP and takes a VP **COMPLEMENT**. This applies when we have more than one auxiliary. Thus:

[53a] You should have written an essay.

[53b]

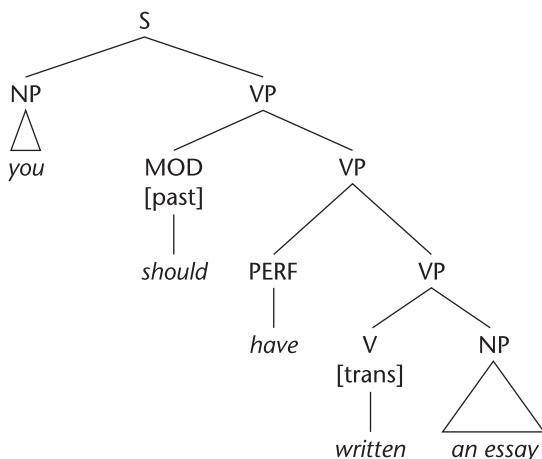

Again, we can ellipsis either the lexical VP, as in [54], or the PERF VP, as in [55]:

[54] . . . and Rory should have, too. (i.e. 'written an essay')

[55] . . . and Rory should, too. (i.e. 'have written an essay')

For reasons explained above, I delay illustrating passive sentences until Part II, but everything I've said about MOD, PERF, and PROG applies to PASS as well.

Example [56] includes all the auxiliary options except PASS. Try drawing a phrase marker for it. **Discussion 2** (page 133).

[56] You should have been writing that essay.

Auxiliary VPs and adverbials

As noted, in introducing auxiliaries, we have introduced further VPs. How do adverbials interact with these further VPs?

As you can see from the following, adverbials can occur *between* verbs.

[57] That hippo could *easily* have killed me!

[58] You are *deliberately* missing the point!

[59] Bill might *just* have been teasing you.

[60] Matilda had been *quietly* reading Simon a story.

[61] She may have *never* been there.

A favoured position for adverbials is the position following the first auxiliary, as in [57]–[59]. (In fact – and this is awkward for our analysis of S-adverbials – this position is particularly favoured for S-adverbials.) In [60] and [61], the adverbial precedes the lexical verb, following two auxiliaries.

The interaction between auxiliary VPs and adverbials is an intricate topic, well beyond the scope of this book. So I am going to simplify things:

Assumption 1. If an adverbial precedes a verb, assume it modifies the FOLLOWING VP.

On that assumption – and bearing in mind that adverbials combine with a VP to form a higher VP – the phrase marker for [57], for example, is going to look like [62].

[62]

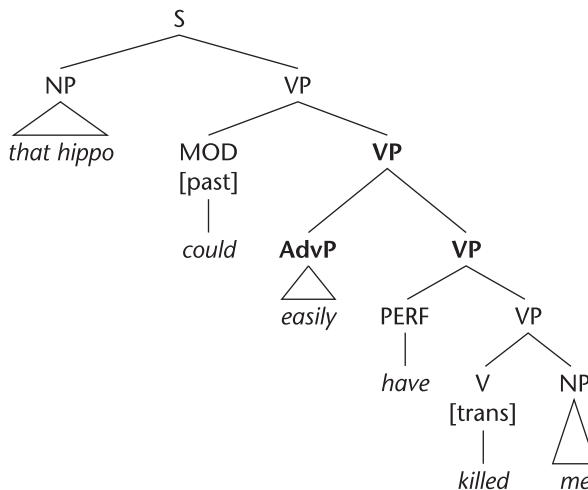

I'll leave the phrase marker for [60] as an exercise (**Discussion 3**).

Compare the interpretations of [63] and [64]:

[63] He just might pass. [64] He might just pass.

In [63], *just* precedes *might* and thus modifies the MOD VP, *might pass*. It means 'it's just possible he will pass'. By contrast, in [64], *just* precedes *pass* and thus modifies the lexical VP. It means 'it's possible he will just pass (scrape through)'.

What about when adverbials appear at the END of a sentence containing auxiliary VPs? Take [65] for example:

[65] They have been complaining *for the fun of it*.

There are three VPs that the adverbial PP *for the fun of it* could be modifying:

- i) the PERF VP *have been complaining*,
- ii) the PROG VP *been complaining*,
- iii) the LEXICAL [intrans] VP *complaining*.

In this example at least, it doesn't seem to make much difference which we choose, as far as meaning is concerned. So, to simplify things:

Assumption 2. Assume that SENTENCE-FINAL adverbials modify (and form a VP constituent with) the LEXICAL VP.

On that assumption, the phrase marker for [65] will look like this:

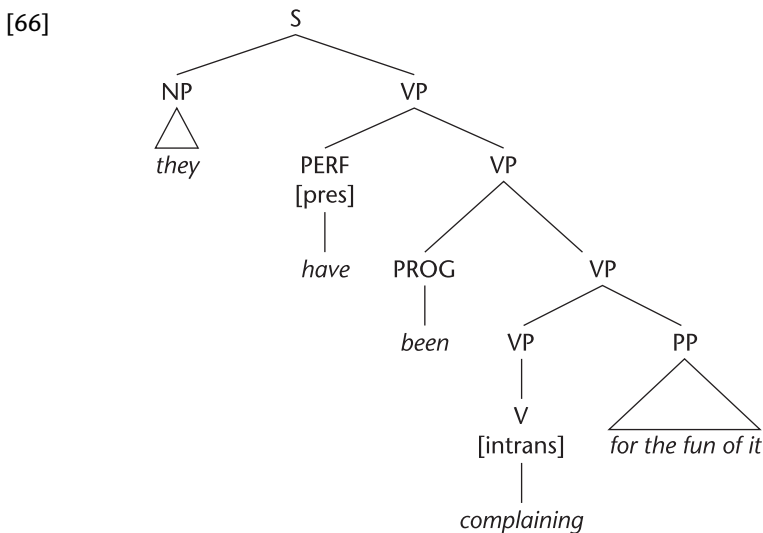

I am going to make **one exception to Assumption 2**, however. It has to do with certain **TIME ADVERBIALS**. Consider [67]:

[67] Kim and Peter are going to India next week now.

Next week modifies *going to India*. So what is *now* doing in there? Well, it has to do, not directly with their going-to-India, but with their PRESENT INTENTIONS (to go to India next week). Now, it is PROG *be* that expresses their intentions and PROG *be* is in the present tense form *are* in [67]. So, it is appropriate to say that *now* modifies the (higher) PROG VP. In this connection consider [68]:

[68] They were going to India next week last week.

For [68] – with its two time adverbials – to make temporal sense, we must analyse *next week* as modifying the lexical VP (*going to India*) and *last week* as modifying the past tense PROG VP (*WERE going to India next week*) – it concerns their past intentions. Here’s the phrase marker for [68].

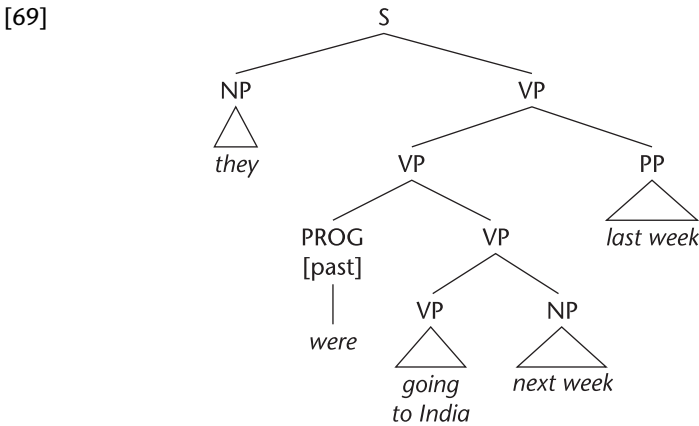

Notice that this predicts the ordering of *next week* and *last week* in [68]. Reversing that order sounds very odd:

[70] *They were going to India last week next week.

Part II: Constructions that depend on auxiliaries

In this part, I explain three sentence constructions that crucially involve auxiliary verbs: PASSIVE SENTENCES, NEGATIVE SENTENCES and QUESTIONS.

Passive sentences

In Part I, I noted that the choice of passive *be* affects the form of the sentence as a whole. Here I explain the form of passive sentences.

Compare the ACTIVE sentence in [71a] with the PASSIVE sentence in [71b].

[71a] The boss fired Max. [71b] Max **was fired** (by the boss).

The verb *fire* is TRANSITIVE and – in the active sentence [71a] – we have *Max* in direct object position. But in the corresponding passive sentence [71b], *Max* has migrated to subject position. So, here's the big idea of this section: **the OBJECT in an ACTIVE sentence becomes the SUBJECT of the corresponding PASSIVE sentence.**

[71a] and [71b] describe the same state of affairs – but differently. It is the subject that canonically identifies what the sentence is ABOUT. So the active is understood as being more about the boss than about Max and the passive, by contrast, is more about the unfortunate Max.

What about **the subject of an active sentence when the sentence is passivised** (*the boss* in [71a])? Well, if we still want to mention who did the firing, we can do so by means of a prepositional phrase – a PP with *by* as its head. But, since the passive sentence is more about Max, we don't have to mention who did it. That's the virtue of passive sentences. As indicated by my brackets in [71b], **the by-phrase is optional. It functions as adverbial.** It modifies – and is the sister of – a VP. Which VP? Since it is sentence-final, it modifies the lexical VP. Evidence for this comes from the co-ordination of lexical VPs in *The fish were [caught by Emily] and [cooked by Raymond]*.

Now construct the passive counterparts of the following sentences.

[72] Mrs Golightly forgave the lodger.

[73] The bouncer is ejecting the intruder.

If it is not intuitively obvious how to do this, make the change in stages. First introduce passive *be* (in the appropriate tensed form) and put the lexical V in the passive participle form (e.g. **Mrs Golightly was forgiven the lodger*). Then kick the subject out into a sentence-final *by*-phrase (**was forgiven the lodger by Mrs Golightly*). Finally, shift the object into subject position. This gives:

[74] The lodger **was forgiven** (by Mrs Golightly).

[75] The intruder is **being ejected** (by the bouncer).

Now, since converting an active sentence into its passive counterpart involves shifting the OBJECT into subject position, it follows that only lexical verbs that TAKE OBJECTS (direct or indirect) can figure in passive sentences.

INTRANSITIVE verbs don't take objects, so sentences containing them don't have passive counterparts. In Chapter 4, TRANSITIVE and INTENSIVE verbs were distinguished. Both can be complemented by an NP, as in [76a] and [77a],

[76a] Everyone present saw a doctor. (transitive)

[77a] Everyone present was a doctor. (intensive)

but the complement NP functions as OBJECT only in the transitive [76a]. In the intensive [77a] the complement NP functions, not as object, but as SUBJECT-

PREDICATIVE. Only OBJECTS shift to subject position in passive sentences. So, while [76a] has a passive counterpart, [77a] does not:

- [76b] A doctor was seen by everyone present.
- [77b] *A doctor was been by everyone present.

Since the direct object in the active becomes the subject in the passive, the direct object position required by a transitive verb won't be filled in the passive. Now, '[TRANS]' means 'taking a direct object'. Can we still call such verbs 'transitive' in the passive, when they NECESSARILY appear WITHOUT an NP in direct object position? Certainly we can (we must!). Even though *Max* appears as subject in the passive [71b], we still understand *Max* as undergoing the firing – i.e. as being the ex-direct object of the transitive verb *fire*. Simply, it has moved, leaving a gap in the direct object position. In passive sentences, a GAP is created in the object position left by the movement of the object to subject position. I'll represent this gap with a conspicuous blob: ●.

The phrase marker for [71b] above must therefore look this:

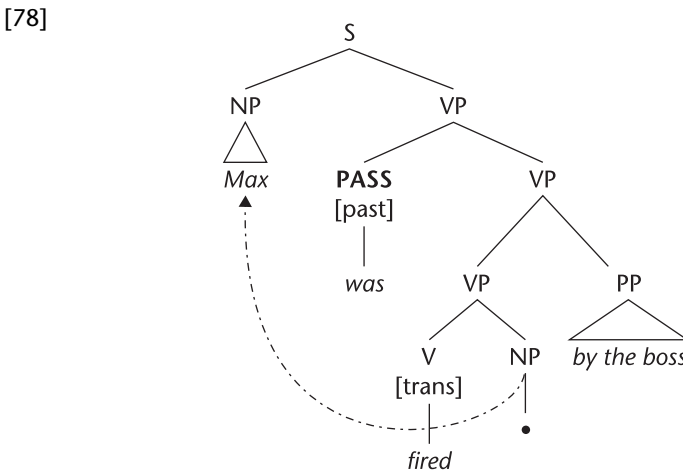

The arrow is not part of the phrase marker. You don't need to draw it (but feel free to do so if it helps). I have done so in [78] simply to make the point explicit.

Exactly the same goes for COMPLEX TRANSITIVE verbs. '[complex]', remember, means 'taking a direct object (dO) and an object-predicative (oP) as complements'. In the passive, though, the dO becomes subject, leaving a gap in the dO position.

- [79] The noise drove Otto mad.
- dO oP



Paradoxically, then, the object-predicative of the active isn't in fact describing the object in the passive – it's now describing the subject. Should we then call it a 'subject-predicative (sP)'? Definitely not. That would be good as saying that *drive* was [intensive] – which it isn't. The paradox is resolved by reference to the gap:

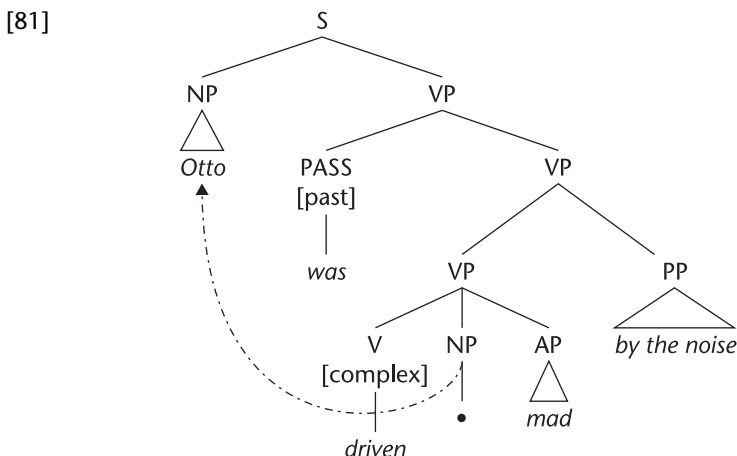

Since the V is [complex], the AP *mad* must be functioning as object-predicative – even in this passive sentence. But on inspecting the dO position, we find only ‘•’. This tells us to look elsewhere for the dO NP that *mad* is characterising. It is PASS *be* (+ passive participle) that tells us look for that NP in the subject position.

Consider also the effect of PASS on DITRANSITIVE verbs. Ditransitives, remember, take two objects in the active (direct and indirect). **With ditransitive verbs, it is always the FIRST object that becomes subject in the passive** (leaving the other object in position). So the passive of [82a] is [82b] and the passive of [83a] is [83b]:

[82a] Max sent *the boss* an anonymous letter. (NP + NP: iO + dO)

[82b] *The boss* was sent (•) an anonymous letter.

[83a] Max sent *an anonymous letter* to the boss. (NP + PP: dO + iO)

[83b] *An anonymous letter* was sent (•) to the boss.

Give the phrase marker for [82b], using triangles for the NPs. **Discussion 4**, page 134.

Negative sentences and auxiliary *do*

The rule for forming negative sentences with the NEGATIVE PARTICLE *NOT* is this:

The negative particle *not* is placed immediately after the TENSED AUXILIARY.

In fact, the negative particle can actually CONTRACT onto that auxiliary.

[84] Byron would not dance. (contracted form: *wouldn't*)

[85] Byron has not been dancing. (contracted form: *hasn't*)

In representing these, I will simply attach *not* to that auxiliary. So [84], for example, will have [86] as its phrase marker.

[86]

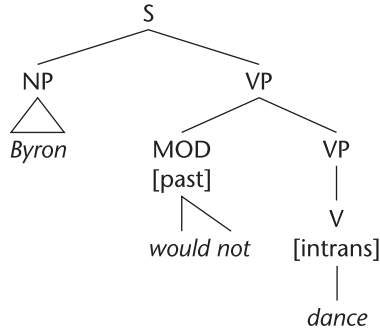

Now, the above rule for placing *not* makes crucial reference to the TENSED AUXILIARY. What if there is no auxiliary but only a lexical verb, as in [87a]?

[87a] Byron danced.

Here it is the lexical verb itself that carries the tense. I mentioned in Part I that lexical verbs never accept a following negative particle: **Byron danced not*. In such cases – to maintain the above rule – an auxiliary verb has to be supplied to carry the tense and the negation. **In negative sentences with *not*, auxiliary *do* is required to carry the tense in the absence of any other auxiliary.**

[87b] Byron did not dance. (*didn't*)

Since auxiliary *do* is now carrying the (past) tense, *dance* must appear in its (non-finite, untensed) STEM form. Compare **Byron did not danced*.

Auxiliary *do* is quite empty of meaning here. Its sole function here is to carry tense and negation instead of the lexical verb. So I shall represent *did* as immediately dominated by TENSE – and I'll simply attach *not* to it, as in [88].

[88]

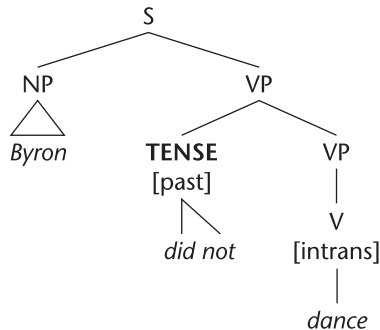

Notice, by the way, that auxiliary *do* can also be used for EMPHASIS in positive sentences, as in *Byron did dance*.

Like *have* and *be*, *do* can function as an auxiliary verb and as a transitive lexical verb. In [89] we have both.

[89] They didn't do the exercises.

Questions – fronting the tensed auxiliary

Look at [90a] and [90b]:

[90a] Byron was dancing. [90b] Was Byron • dancing?

The rule for forming the question is this:

The tensed auxiliary verb moves in front of the subject.

We have already encountered movement, in passive sentences. Notice that, in passives, phrases were moved only into positions already acknowledged – subject position and VP-adverbial position. This suggests there should be a structural position in the phrase marker that is able to accept the fronted auxiliary. The question is: **what STRUCTURAL position does the tensed auxiliary move to?** No such position has been mentioned yet. So I need to introduce it now. Look carefully at [91].

[91]

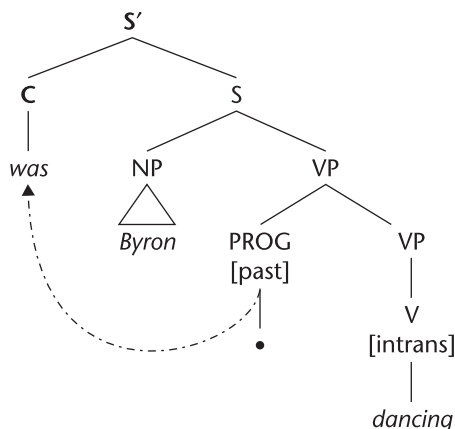

There are two new nodes here (in bold). First, there is an **S'** node. This is called 'S-bar'. Then there is a 'C' node. 'C' is for 'Complementiser'. **The Complementiser position is: sister of S and daughter of S-bar (S')**. So, the structural position that a fronted auxiliary moves to is the Complementiser position. As with passive, the movement has left a gap in the original position.

It may seem that I have just invented this new position simply to find a place for the fronted auxiliary. Well, that would be a good enough reason. But I've not invented it. We'll see in later chapters that this position is real and is required for other purposes as well.

To help you get used to all this, try drawing a phrase marker for [92]. It is given as **Discussion 5** (page 134).

[92] Could Simon have written these words?

Just like the negative rule considered earlier, the question rule makes crucial reference to the TENSED AUXILIARY. Lexical verbs never move in front of the subject (**Danced he?*). So, again, auxiliary *do* is required to carry the tense in the absence of any auxiliary. It is *do* that moves to C – and thus in front of the subject. Here is the phrase marker for *Does Byron dance?*

[93]

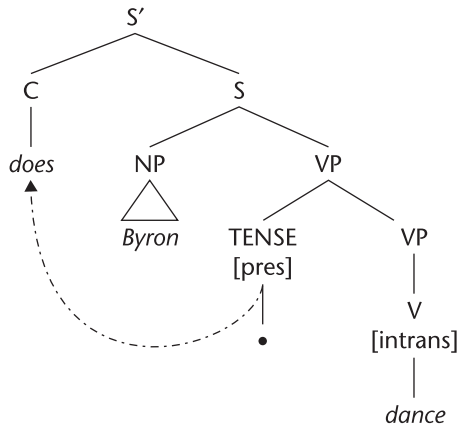

Now look at [94a].

[94a] Hasn't Oleg been arrested?

This is **both a question and passive**. So it exhibits both movements explained in this chapter – auxiliary-fronting to C and passive object-to-subject – creating two different gaps.



Bearing this in mind, draw a phrase marker for [94a]. **Discussion 6** (page 134).

More on *have* and *be*

I have mentioned that *have* and *be* can function both as auxiliary verbs and as lexical verbs. As you might expect, when FUNCTIONING as auxiliaries, they BEHAVE like auxiliaries: fronting to C in questions and accepting the negative particle ([95] and [96]). *Do*, which is normally required in the absence of an auxiliary, is ungrammatical with the auxiliary use of *have* and *be* ([97] and [98]).

- [95a] Are they going? [95b] They aren't going.
 [96a] Have they gone? [96b] They haven't gone.
 [97a] *Do they be going? [97b] *They don't be going.
 [98a] *Do they have gone? [98b] *They don't have gone.

Surprisingly, *have* can BEHAVE like an auxiliary OR like a lexical verb even when it is FUNCTIONING as a lexical verb. All the following are grammatical:

Functioning as a lexical verb, behaving like a lexical verb:

- [99a] Do we have any garlic? [99b] We don't have any garlic.

Functioning as a lexical verb, behaving like an auxiliary:

- [100a] Have we any garlic? [100b] We haven't any garlic.

Be is more regular in its irregularity: it ALWAYS behaves like an auxiliary – whether functioning as auxiliary or lexical. Only [101a–b] are grammatical:

Functioning as a lexical verb, behaving like an auxiliary:

- [101a] Was Kubla extravagant? [101b] Kubla wasn't extravagant.

***Functioning as a lexical verb, behaving like a lexical verb:**

- [102a] *Did Kubla be extravagant? [102b] *Kubla didn't be extravagant.

The phrase marker for [101a] looks like this:

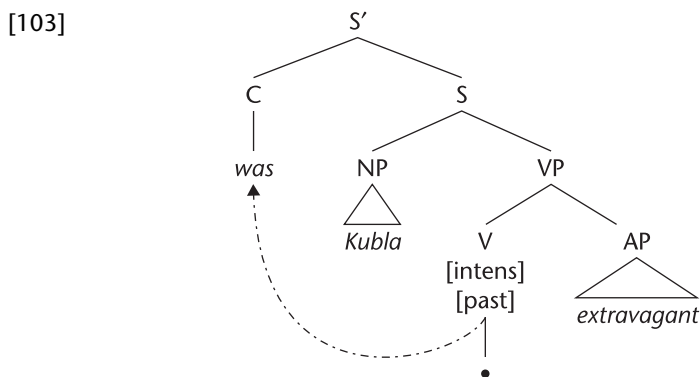

Discussion of in-text exercises

1.

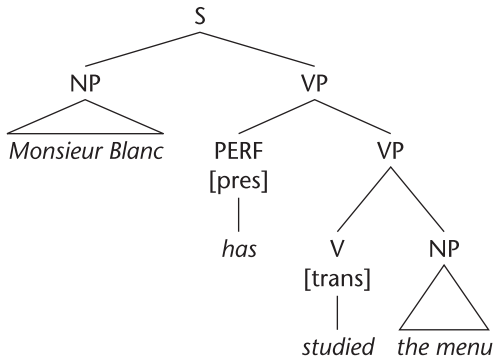

2.

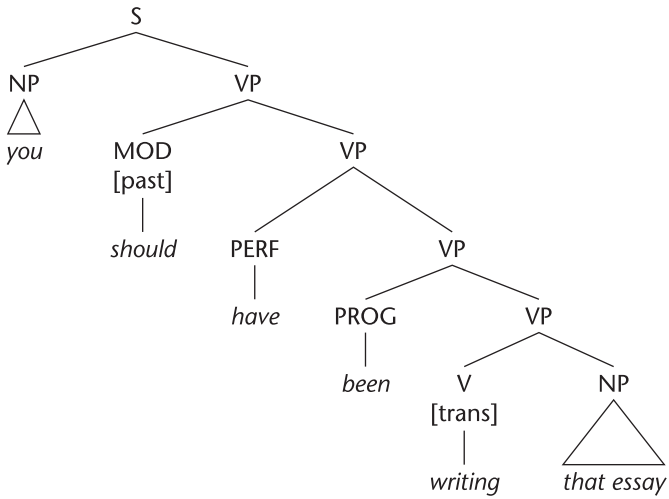

3.

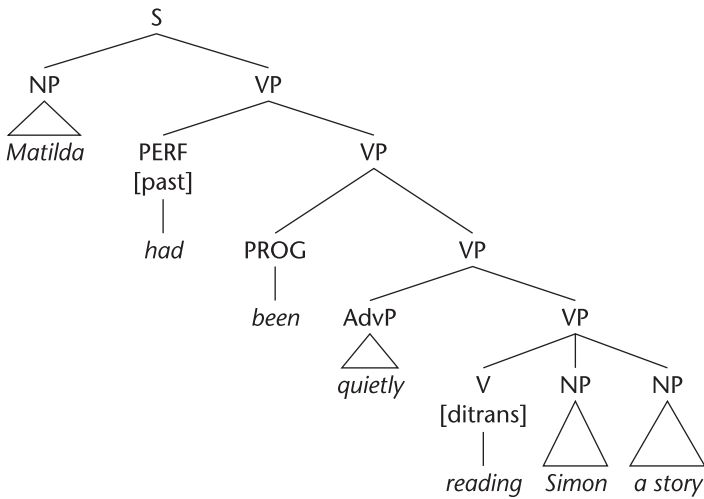

4.

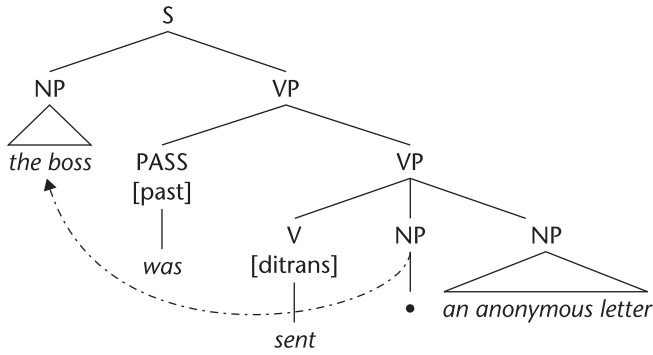

5.

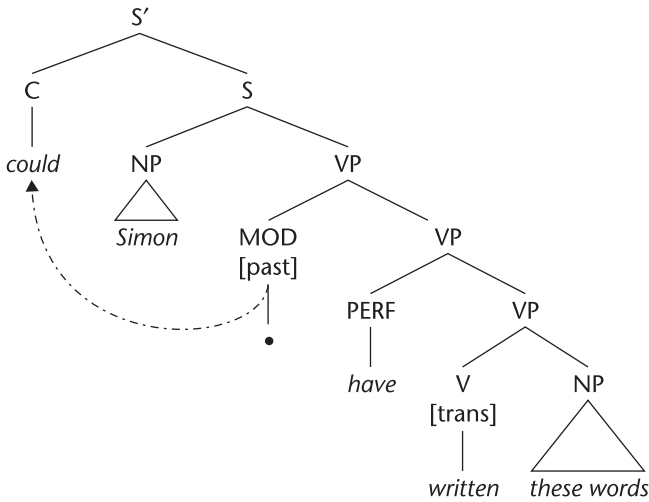

6.

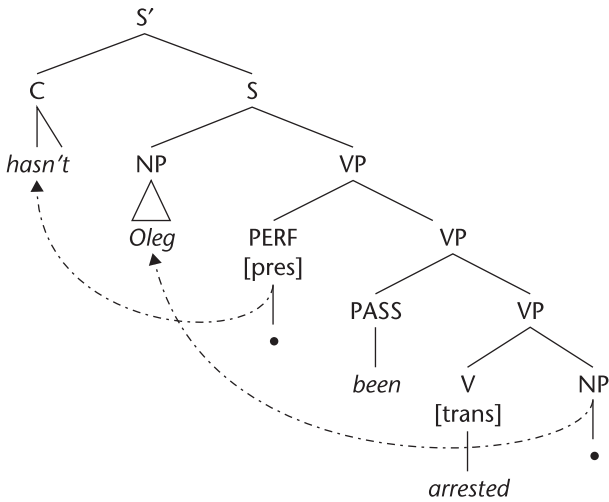

Exercises for Part I

1. Draw phrase markers for the following sentences using triangles for all NPs, APs, PPs, AdvPs (but not, of course, VPs).

- (1) Nanny is being a nuisance again.
- (2) Millie will have filled the pool by tonight.
- (3) Andy has been on court for five hours now.

2. Turn to the first page of the 'Preface to the Second Edition' in this book (page xi) and identify the following verbs and their forms.

Example: *had* on the first line is the past tense form of the lexical verb.

- (1) Line 4: *be*. (2) Line 8: *were*. (3) Line 1 of para 2: *have*.
- (4) Line 1 of para 2: *made*. (5) Line 2 of para 2: *made*.
- (6) Line 3 of para 2: *come*. (7) Line 5 of para 2: *want*.

Exercises for Part II

3. Using triangles for all NPs, APs, AdvPs, and PPs, draw phrase markers for the following.

- (a) Max and Adrian were having a really tedious conversation this morning.
- (b) The cattle are being persecuted by flies.
- (c) Could this have been her famous purple wig?
- (d) Was this put in my pocket by you?
- (e) His article was accepted and quickly published.

Discussion of exercises

1. (1)

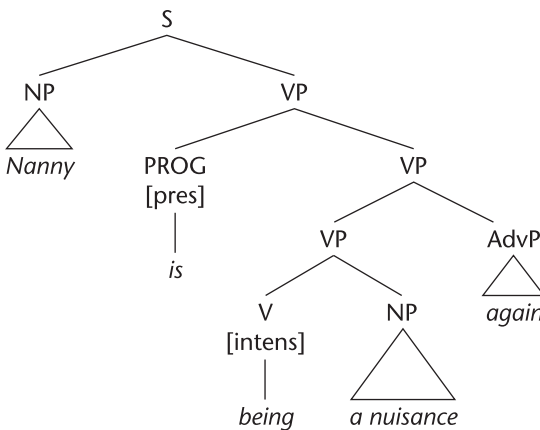

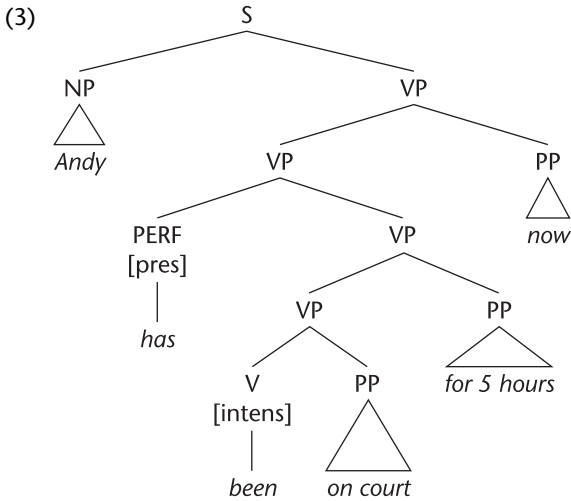
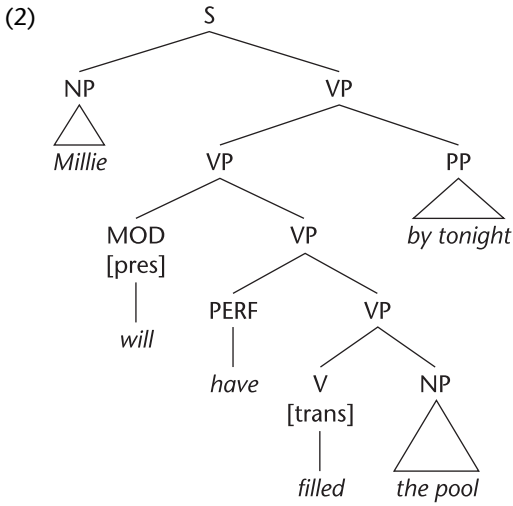

2. (1) Stem form of progressive *be*. (2) Past tense, lexical (copula) *be*.
 (3) Present tense, perfect *have*. (4) Passive participle.
 (5) Past tense. (6) Perfect participle. (7) Present tense.

3. (a)

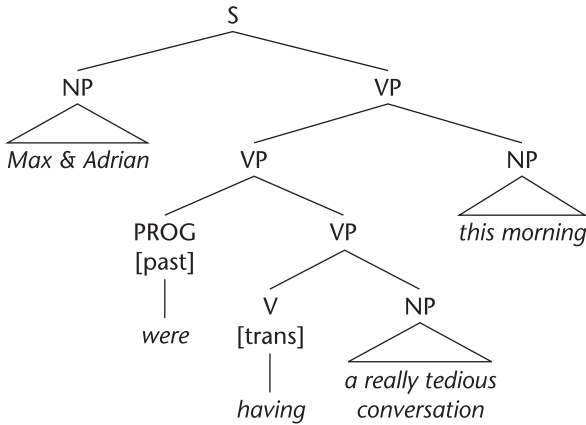

(b)

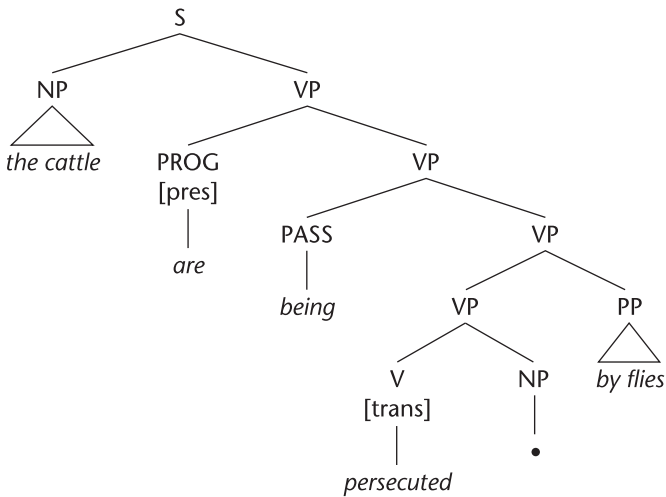

(c)

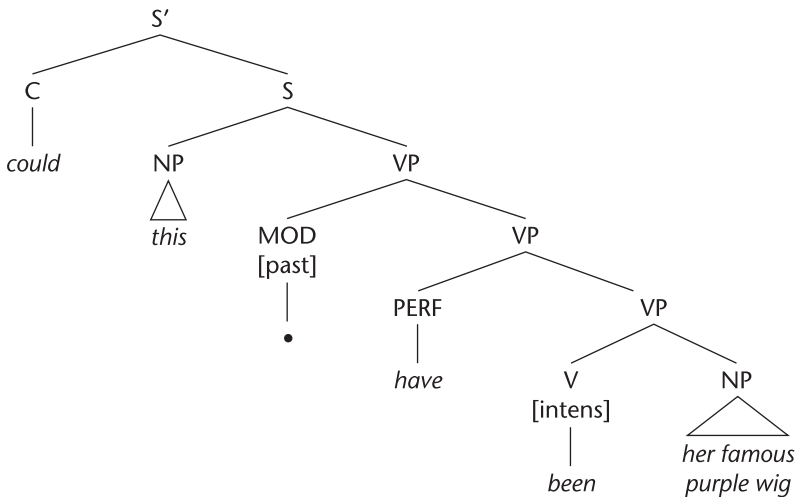

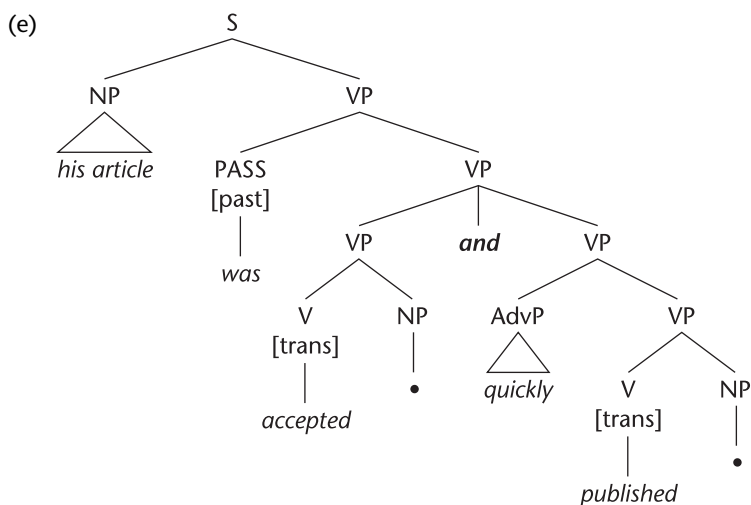
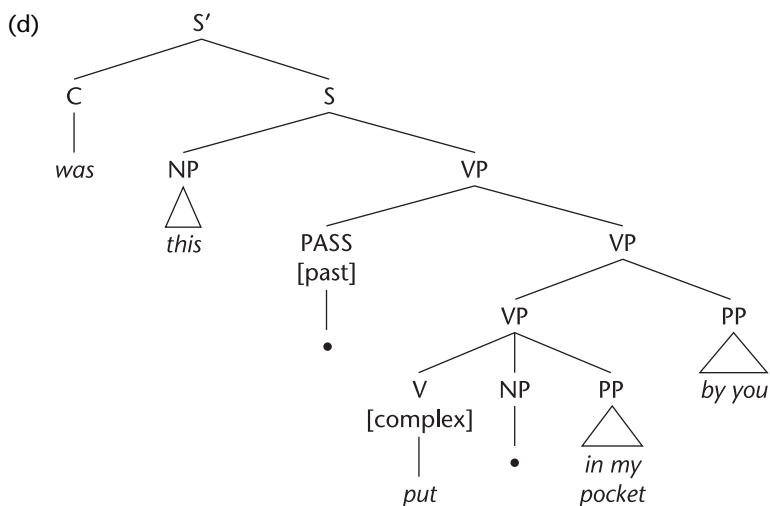

Further exercises (Part I)

1. Turn to page 255 of this book and identify the following on that page:
 - (1) Three different examples of lexical verbs in the present tense. Include at least one that does *not* have a third-person singular subject.
 - (2) Five different examples of lexical verbs in the past tense form.
 - (3) Two past tense modals *and* two present tense modals.
 - (4) Two perfect participle forms.
 - (5) A passive participle form.

- (6) Passive *be* in its bare stem form.
 - (7) Two different tensed forms of passive *be*.
 - (8) Two lexical verbs in the (non-finite) bare stem form.
 - (9) A sentence in which both lexical and perfect *have* occur.
2. For each of the italicised forms of the verb *be* in the following sentences, say whether it is an instance of the lexical (copula) verb, the progressive auxiliary, or the passive auxiliary.
- (1) His behaviour may *be* peculiar.
 - (2) It *was* becoming noticeable.
 - (3) He *was* overheard by Polonius.
 - (4) It *was* unexpected.
 - (5) Hamlet *was being* offensive.
 - (6) Ophelia *was being* driven mad.
 - (7) He had *been* going mad.
 - (8) He could have *been* her husband.
 - (9) The play *was* unnerving.
 - (10) The play *was* unnerving the king.
 - (11) The wine *was* drunk by Hamlet.
 - (12) Hamlet *was* drunk by midnight.
 - (13) Yorick had *been* buried for years.
 - (14) Hamlet *was* buried the next day.
3. Draw phrase markers for the following sentences, using triangles for all NPs, APs, PPs, and AdvPs (but not VPs).
- (1) They might have slipped out for a chat.
 - (2) She always has dyed her hair deep purple.
 - (3) The exercises should have been much easier.
 - (4) I will be happily looking after your charming children.
 - (5) William must have surreptitiously shown Millie the answers.
 - (6) We had already run out of sausages by ten pm.
 - (7) They were peeling the bananas and slicing them lengthways.
 - (8) They will have prepared their answers and be reading them out in tomorrow's seminar. (This one needs care!)

Further exercises (Part II)

4. What *exactly* is wrong with each of the following? Explain briefly but clearly.
- (1) *Emily can may have thrown away those pork pies.
 - (2) *She is having questioned their freshness.
 - (3) *She didn't went to another shop.
 - (4) *Complained she to the manager?
 - (5) *Would she be treated her complaint politely?
 - (6) *Be she never going there again?

(7) *She is persuasive and getting her money back.

(i.e. for (7), why can't we ellipt the second occurrence of *is* in *She is persuasive and is getting her money back?*)

5. Draw phrase markers for the following sentences, using triangles for NPs, APs, AdvPs, PPs (but not VPs).

(1) I don't lend my toothbrush to anybody.

(2) You will be seen by the doctor within five minutes.

(3) Doesn't Max ever sit quietly?

(4) Have all the applicants been interviewed already?

(5) All the information will be made available shortly.

(6) They will be drunk soon. (ambiguous!)

(7) Gomez may have been keeping quiet and minding his own business.

(8) Should we invite the boss or would that be misunderstood?

(9) I've never read your diary but Mary has quite consistently.

7

The structure of Noun Phrases

From the preceding chapters you will have gained an idea of how phrasal categories (NP, VP, AP, PP and AdvP) fit into the structure of sentences. Of these, we have only looked in detail at the structure of VP: complements in VP, adverbials in VP and auxiliary verbs (and their VP complements). In this chapter, I look in more detail at the internal structure of other phrasal categories, Noun Phrases in particular.

So far we have only looked the internal structure (such as it is) of NPs consisting of just a PRONOUN or just a NAME – single words that count as full NPs in themselves. Here’s a reminder of what they look like.

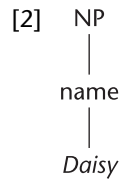
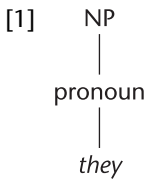

The NP node in [1] and [2] is said to be NON-BRANCHING – it just goes straight down. NPs consisting of a PRONOUN or a NAME are the ONLY NON-BRANCHING NPs allowed for in this book. All other NPs have branching representations. They all have two immediate constituents.

In the basic case, the two immediate constituents of NP are: DET and NOM (Determiner and Nominal). Here are two examples:

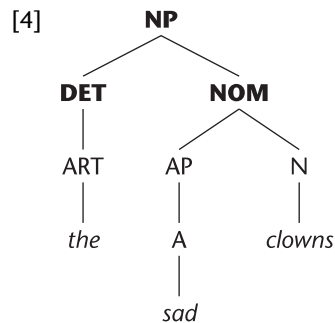
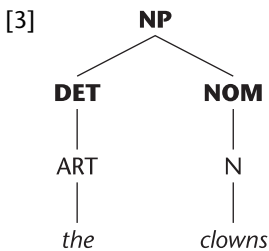

DET always has NOM as its sister. DET determines NOM. NOM is a level of NP-structure INTERMEDIATE between the PHRASAL (NP) level and the LEXICAL (N) level. In [4], *sad* is a modifier of the head noun. **All modifiers of the head noun fall under NOM.** Since modifiers are optional, it follows that NOM can consist just of N, as in [3]. I look first at the elements that can come under the DET node.

Determiners

These are a fixed set of ‘grammatical’ words which give information relating to definiteness and indefiniteness (roughly, whether the thing referred to by the NP is familiar to both speaker and hearer or not) and information about quantity and proportion.

The basic determiners are the ARTICLES (ART): the DEFINITE ARTICLE – *the* – and the INDEFINITE ARTICLE – *a(n)*. The articles are ‘basic’ in the sense that they provide a touchstone as to what counts as a determiner. **Any expression that occupies the same position in NP structure as an article counts as a determiner.** How can you tell whether an expression is occupying the same (determiner) position as an article? Well, if a word can appear in sequence with an article – put another way, if a word can CO-OCCUR with an article – in an NP, then that word must be analysed as occupying a different position; it cannot be the determiner.

There is a small set of words which perform the same function as the articles:

DEMONSTRATIVES (DEM): *this, that, these, those*

Certain QUANTIFIERS (Q): *some, any, no, each, every, either, neither*

POSSESSIVES (POSS): *my, your, its, her, his, our, their, John’s*

None of these can co-occur in sequence with an article in an NP (for example: **this the clown, *the this clown, *a some clown, *some a clown, *the my shoe, *your the shoe, *any a day*). So they are determiners themselves.

[5], [6], and [7] are the phrase marker representations of *those trampolines*, *some mistake*, and *my address*.

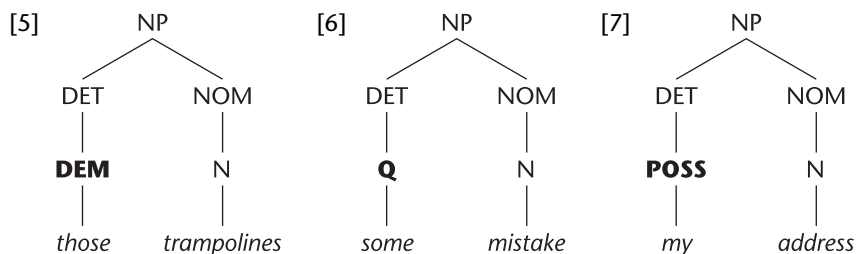

Now, the **determiner position may not always be filled by an actual word**. Look at the subject NPs in the following:

[8] *Essays* should be word-processed.

[9] *Smoke* gets in your eyes.

Although these NPs contain just one word, they should still be analysed as having a [DET + NOM] structure, as in [10]:

[10]

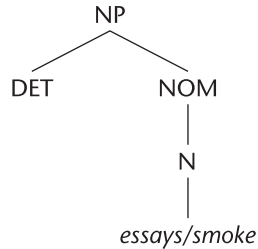

The reason for this ‘**EMPTY DETERMINER**’ analysis is this. First, both of these NPs **COULD** take a determiner (*the/some smoke, the/your essays*). We need to allow for this by making a DET slot available, as in [10]. Furthermore, the empty determiner affects the interpretation of the NP. **The empty determiner gives the NP an INDEFINITE and/or more GENERAL interpretation**. The subject of [9], for example, is clearly indefinite, as compared with the definite NP *the smoke*. It is also more general than the indefinite NP *some smoke*.

Which head nouns can take the empty determiner? There are just two types of noun that can do so: **plural count nouns** (as in [8]) and **mass nouns** (as in [9]).

As mentioned, the subjects in [8] and [9] are single-word NPs – and they have that in common with NPs that consist of a pronoun or a name. The empty DET + NOM analysis clearly distinguishes these NPs from pronoun NPs and name NPs. The lack of a determiner with a name indicates neither indefiniteness nor generality. On the contrary, names don’t normally take determiners precisely because names are inherently definite. Pronouns, too, are inherently definite (e.g. *she, we, they, them*) or inherently indefinite (*someone, anyone*), independently of any determiner.

Consider now the NP in [11]:

[11] *John’s* father.

John’s was listed above among the possessive determiners. Now, *John* is a name and therefore counts as a full NP in its own right. So it appears that a **possessive determiner (POSS) can be simple (*my, your, etc.*, as in [7] above) or consist of a full NP plus -s**. This is called the **POSSESSIVE, or GENITIVE, -s**. The addition of -s to *John* makes for a possessive determiner. So [11] has [12] as its phrase marker.

[12]

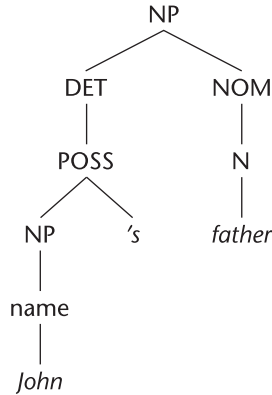

More generally, the addition of *-s* to ANY NP makes for a possessive determiner. There's nothing to prevent the NP within possessive determiners displaying all the structure that other NPs do, including DET + NOM. In the light of this, draw a phrase marker for *the book's cover*. It is given as [14] below.

In fact, a possessive NP can itself be determined by another possessive NP, as in [13]:

[13] Hieronimo's brother's behaviour.

In principle, there is no limit to the number of times this can be done. Draw the phrase marker for [13]. **Discussion 1**, page 157.

Here is the phrase marker for *the book's cover*:

[14]

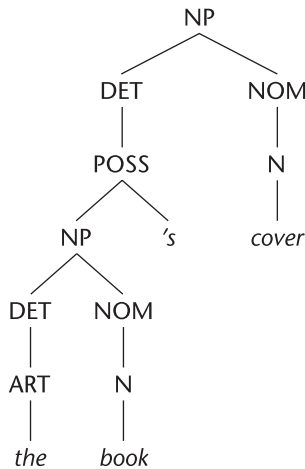

Pre-determiners

Consider now the words *all*, *both*, and *half*. These resemble the determiners we have looked at. However, they do co-occur with and precede determiners:

[15] all the men [16] both those trampolines [17] half Jim's money

So they cannot be determiners themselves. Instead, I categorise them as PRE-DETERMINERS (PRE-DET). Expressions like *double*, *treble*, and so forth are also pre-determiners (cf. *double that amount*).

In deciding how pre-determiners fit into the structure of NPs, we must decide what they (pre-)determine. Give this a thought. Notice the following: within the NP *all the men*, there is a sequence that looks very much like a familiar constituent, namely *the men*. What, then, would you suggest as a likely analysis of *all the men*?

The points just made suggest that **pre-determiners determine an NP**. The pre-determined NP in [15] consists of *the* (DET) + *men* (NOM). And the whole thing is itself an NP. So PRE-DET should be represented as sister of an NP within NP:

[18]

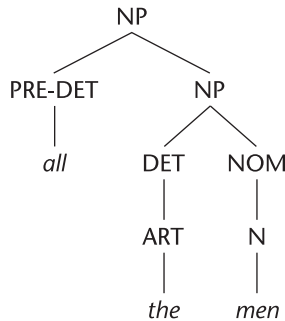

Now look at [19] and [20]:

[19] all men [20] both men.

Although they don't precede determiners in these NPs, *all* and *both* are still analysed as pre-determiners here. The determiner position itself is empty. The idea that there is an empty determiner in [19], with *all*, is perhaps more plausible than in [20] with *both*. *All men* (= *all DET men*) is both more indefinite and more general than *all the men*. By contrast, *both the men* and *both men* differ neither in definiteness nor generality. Nevertheless, I shall continue to analyse *both* in [20] as a pre-determiner since, as [16] shows, it can co-occur with, and precede, the article.

Notice that the majority of determiners and all the pre-determiners are capable of functioning as if they were pronouns:

- [21] I've always wanted *those*. [22] *Some* fell on stony ground.
 [23] *John's* are turning blue. [24] *All* is ruined.

There is a section on this at the end of the chapter.

Among the determiners that cannot function as pronouns, there are some that correspond to forms that can. For example, the quantifier *no* cannot function as a pronoun (**I want no*) but it corresponds to *none*, which can (*I want none*). And with the possessives, we find the following alternations:

DETERMINER:	my	your	her	his	our	their
PRONOUN:	mine	yours	hers	his	ours	theirs

It is predictable that pre-determiners, which pre-determine full NPs, should be able to co-occur with pronouns. Draw the phrase marker of the subject NP in *All mine are at the cleaners*. **Discussion 2**, page 157.

This concludes our brief survey of determiners and pre-determiners. Notice that **the discussion has allowed for just three ways the NP node can be expanded:**

- Non-branching: (1) NP \rightarrow $\left. \begin{array}{l} \text{pronoun} \\ \text{or} \\ \text{name} \end{array} \right\}$
- Branching: (2) NP \rightarrow DET + NOM
 (3) NP \rightarrow PRE-DET + NP

But, bearing in mind that any category can be co-ordinated, including NPs, there is of course a fourth way the NP node can be expanded:

- (4) NP \rightarrow NP + & + NP.

Pre-modifiers in NOM

The most obvious pre-modifiers of the noun within NOM are **Adjective phrases (APs)**, introduced in Chapter 3. The position of pre-modifying APs in NP was illustrated in [4] (*sad*). As [4] illustrates, A is always dominated by AP. The function of the A is head-of-AP. It is the AP that has the modifying function. And don't forget that APs have other functions: sP and oP in VP.

Here I shall mention other pre-modifiers in NP, before discussing the structure of NOMs in which there are several pre-modifiers.

Quantifying adjectives

Much, *many*, *few*, and *little* are quantifying adjectives (QA). As adjectives, they come under NOM in NPs. Here are my reasons for treating them as adjectives (rather than determiners):

- (a) Like adjectives, they co-occur with and follow determiners (*those many books, the little butter that I have, some few successes*), including an empty determiner: *many books* (= DET *many books*), *much garlic* (= DET *much garlic*).
- (b) Like adjectives, they may occur in the VP, functioning as subject-predicatives: *His mistakes were many, It wasn't much, It was little enough*.
- (c) Like adjectives, they are gradable: *very many books, too much garlic, so few ideas, very little tact*, where they are modified by DEG. The comparative and superlative forms of *many* and *much* are *more* and *most*; of *little*, *less* and *least*; of *few*, *fewer*, and *fewest*.

NUMERALS (the cardinal numerals *one, two, three . . .* and the ordinal numerals *first, second, third . . .*) should also be treated as quantifying adjectives within NOM, since they follow DET, including empty DET.

Quantifying adjectives (QAs) are head of AP. APs with a QA as head always precede other APs in NOM. Here are phrase markers for *very many mistakes* and *the one mistake*:

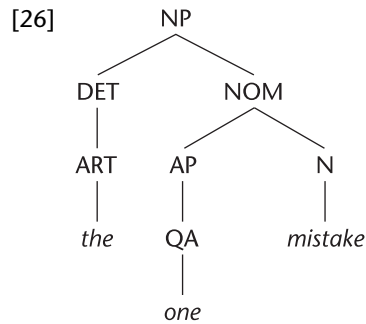
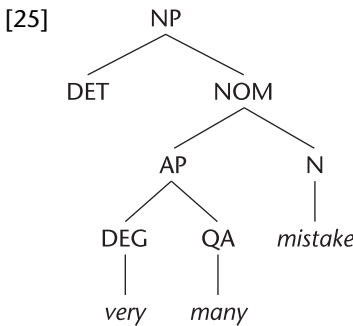

Participle phrases (PartP)

The non-finite forms of verbs referred to in Chapter 6 as the progressive, perfect, and passive participles (V-part, for short) may also appear as pre-modifiers within NOM:

PROGRESSIVE

[27a] the leering manager

[27b] the sleeping guard

PERFECT or PASSIVE

[28a] a faded dream

[28b] the departed nymphs

[28c] sliced cake

[28d] a forgotten valley

In this position, the perfect and passive participles can only be distinguished by appealing to the meaning. [28a and b] are perfect, referring to a dream that *has* faded and nymphs who *have* departed. [28c and d], by contrast, are passive – they refer to cake that has *been* sliced and a valley that has *been* forgotten.

Since these forms are verbal rather than adjectival, they are not gradable: **the very leering manager*, **rather sliced cake*, **the slightly sleeping guard*. They can be modified by general adverbs, however, as in *the rapidly congealing gravy*. Draw the phrase marker for this NP. Discussion 3, page 158.

As we saw in Chapter 6, certain true adjectives look very much like verb participles: *charming*, *pleasing*, *(un)interested*, *worrying*, *(un)surprising*, *unexpected*. However, since they are gradable, they are easily distinguished from participles: *rather pleasing*, *very interested*. Some of these, for example *unexpected*, don't even correspond to any known English verb anyway (cf. **unexpected*).

The distinction between true adjectives and verb participles is sometimes blurred. For example, although [29] might look as though it contains a passive lexical verb,

[29] They were very disturbed by the play.

the presence of *very* rules this out (cf. **The play very disturbed them*). *Very* here means we are dealing with an AP complementing the (intensive) copula *be*.

■ Nouns

Nouns themselves may act as pre-modifiers of nouns. Examples are *chess piece*, *traffic light*, *roof maintenance*, *carbon trader*, *computer game*. The relation between a head noun and a pre-modifying noun is much closer than that between the head noun and any other pre-modifier. In a sequence of modifiers that includes a noun modifier, **noun modifiers always appear last**. They cannot be separated from the head noun.

[30] some expensive roof maintenance

[31] *some roof expensive maintenance

Such **NOUN–NOUN combinations are COMPOUND NOUNS**. They are not treated as phrasal, but as compound words. The compound noun *roof maintenance* should therefore be dominated by N as in [32]:

[32]

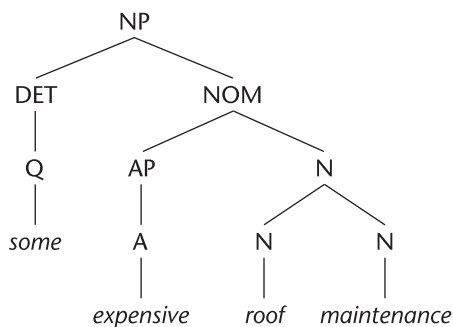

In the light of what you have read so far in this chapter about (a) pre-determiners, (b) determiners, (c) adjectival modifiers, and (d) noun modifiers, draw the phrase marker for the NP in [33]. **Discussion 4**, page 158.

[33] all those dusty gorilla suits

More on the structure of NOM

How should sequences of more than one AP within NOM be represented? Consider [34]–[35]:

[34] a red car [35] a new red car

Before deciding how [35] should be represented, give the phrase marker for [34].

The phrase marker for [34] will be almost exactly the same as that for *the sad clowns* – [4] at the beginning of the chapter. So [*red car*] is a NOM in [34] – and there is no reason to suppose that it is not a NOM in [35] as well. So in [35], *new* must be modifying the NOM [*red car*]. Furthermore, the NP in [35] is analysable as DET + NOM. You now have all the information needed to draw the phrase marker for [35].

The important thing to notice here is that, for [35], we need two NOMs. This follows from the comments of the preceding paragraph. So [36] is the phrase marker for [35].

[36]

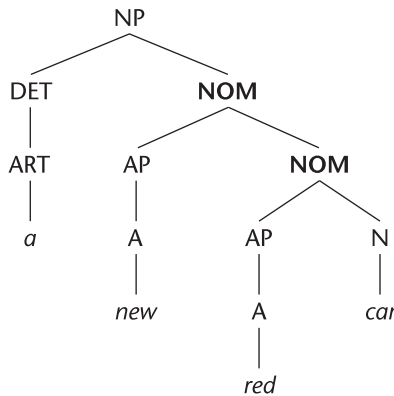

What this shows is that **NOM is a recursive category**. In other words, NOM can have NOM as an immediate constituent. In fact, apart from noun modifiers,

EVERY MODIFIER must be immediately dominated by a NOM. In the light of this, give the phrase markers for the following NPs. **Discussion 5**, page 158.

[37] some large greasy uneaten fritters

[38] those two very charming atomic scientists

I will be refining this analysis in Chapter 9. If you are interested in finding out now why it needs refining, see the Appendix at the end of this chapter.

Post-modifiers

In this section I look at just two of the categories that follow the head noun within NOM: Prepositional Phrases and certain types of Adjective Phrase.

Prepositional Phrases

In the NP *an expedition to the pub*, the head N is *expedition* and it is modified by the PP *to the pub*, which consists of P + NP. In this case, we have a post-modifying (PP) sister to the noun, within NOM. So:

[39a]

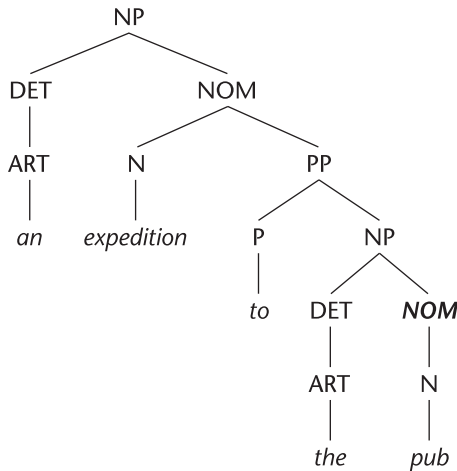

Now, just as *expedition* can be modified by a PP, so can *pub*. For example: (*an expedition to the pub in the village*). The phrase marker for this is going to start off exactly like [39a] – but the bold italicised **NOM** in [39a] will now branch, as in [39b]:

[39b]

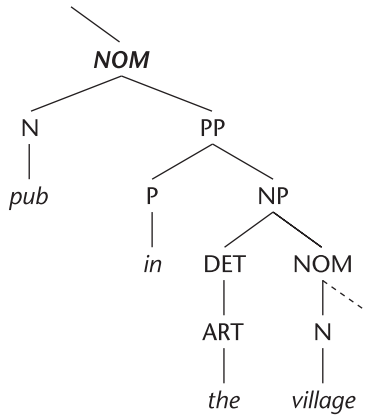

As my dotted line shows, this could go on indefinitely – for example,

[40] an expedition to the pub in the village at the foot of that mountain

This might seem complicated but it’s really very simple. It’s the same story again and again. Were you to draw the phrase marker for [40] and look at the right hand nodes, you’d find it goes NP – NOM – PP again and again (four times, in fact).

All those NPs have a REGULAR RIGHT-BRANCHING STRUCTURE. Now, at first glance, [41] might appear to have the same structure.

[41] an expedition to the pub for more cherry brandy

Not so. I hope you agree that, unlike *the pub in the village* in [39a–b], *the pub for more cherry brandy* is not a constituent of [41]. *For more cherry brandy* is not modifying *pub*. So what *is* it modifying? Consult your intuitions about its meaning and in the light of that suggest an appropriate analysis for [41]. Use a triangle for each of the PPs. Hint: remember that NOM is a recursive category.

You’ve got it, I’m sure. *For more cherry brandy* modifies a constituent that has *expedition* as its head – it’s an expedition (. . .) for more cherry brandy. So, it must be modifying *expedition to the pub*. Now, *expedition to the pub* is a NOM. And *expedition to the pub for more cherry brandy* is a NOM as well. So we have a NOM within a NOM – as in [42]:

[42]

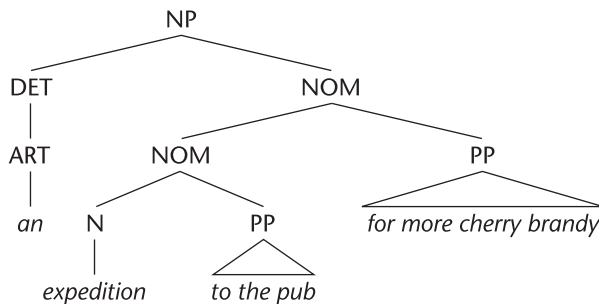

This is *not* a regular right-branching structure. Notice that the arrangement of (post-modifying) PPs is the mirror image of the arrangement of (pre-modifying) APs in [36]. Again, there are as many NOMS as there are modifiers.

You may remember the NP *an agreement between workers on overtime* from a previous exercise. This is ambiguous, depending on whether *on overtime* modifies (a) the NOM [*agreement (between workers)*] – ‘an overtime agreement’ – or (b) just the N *workers* – ‘workers who are on overtime’. Now decide what element the italicised PP in each of the following NPs modifies. Is it (a) modifying a NOM consisting of the head N plus PP (as in [42]), or is it (b) modifying the N within a PP (as in [39a–b])? **Discussion 6**, page 159.

- [43] those observations on alchemy *by Newton*.
- [44] an interpretation of that sentence *in Proust’s novel*.
- [45] a book of quotations *from Shakespeare*.
- [46] a book of quotations *from Oxford University Press*.

All the NPs considered so far have included just pre-modifiers or just post-modifiers. **What happens when NOM includes both a pre-modifying AP and a post-modifying PP?** To repeat, there must be as many NOMs as there are modifiers. So, with a pre-modifier and a post-modifier, there will be two NOMs. There are two possibilities, then:

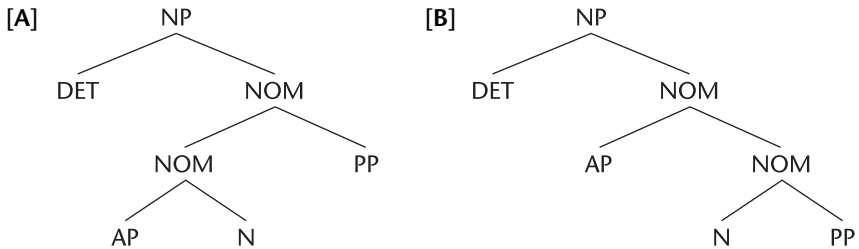

With some NPs, it does not matter much which analysis we give (I give examples later). For others it does matter, and deciding which analysis is appropriate involves attending to the meaning in each case. In each of the following, it matters. Try to decide which analysis – A or B – is appropriate in each case.

- [47] that nuclear scientist from Germany.
- [48] the famous writer of many detective stories.
- [49] an anxious applicant for the job.
- [50] structural engineers in disgrace.
- [51] the personal assistant in the hat.
- [52] their secret visits to the larder.
- [53] Larry’s neat summary of the argument.

Analysing [47] as in [B] – *[*nuclear*] [*scientist from Germany*] – is not right. *Nuclear scientist* denotes a CATEGORY of scientist. Since there *is* such a category, it is appropriate there should be an expression to denote it. So [*nuclear scientist*] is a constituent of [47]. The distinction between *nuclear* and *from Germany* (in their relation to *scientist*) is brought out clearly by noting that, while *That [nuclear scientist] IS from Germany* is quite natural, *That [scientist from Germany] IS nuclear* is just bizarre. Assuming that the PP *from Germany* means what *German* means, the same bizarre effect is achieved by the ordering **that nuclear German scientist*, where *nuclear* is again separated from the element it wants to form a constituent with. By contrast, *that German nuclear scientist* is fine. All this indicates analysis [A] for [47] – *from Germany* modifies [*nuclear scientist*].

The same kind of thinking suggests analysis [A] for [50] and [51]. By contrast, analysis [B] is appropriate for [48], [49], [52], and [53].

As regards the NP [53], for example, note its parallelism to the sentence [54]:

[53a] Larry's neat summary of the argument. (NOUN PHRASE)

[54a] Larry neatly summarised the argument. (SENTENCE)

Give the phrase marker for the sentence in [54a].

In the SENTENCE, *the argument* is the direct object of the verb *summarised*. As a complement, it combines with *summarised* to form a VP – and that VP is modified by *neatly*. Now, it is reasonable to expect the structural configuration of the NP to parallel that of the sentence. After all, [53a] is simply sentence [54a] recast as an NP:

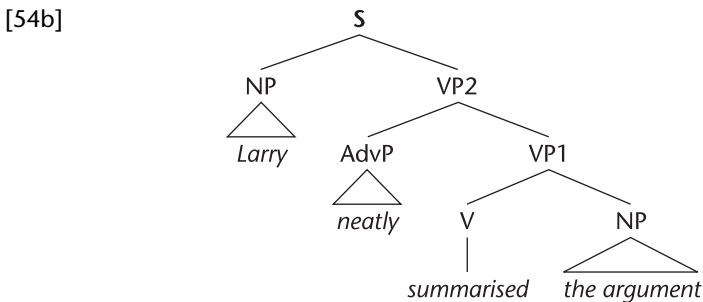
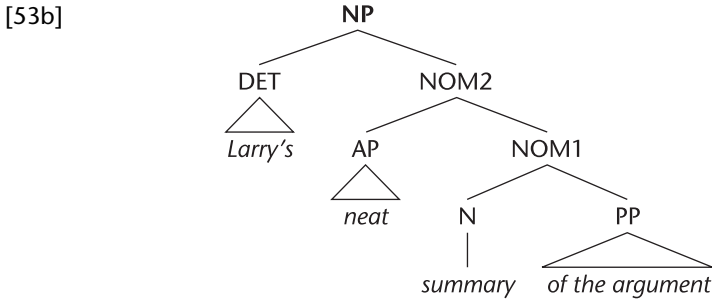

Only the categories have changed. Notice that the NOMs in the NP match the VPs in the S. The same goes for the NPs in [48], [49], and [52]. The Appendix to this chapter discusses a refinement suggested by this parallelism between S and NP.

Now compare the NPs in [47]–[53] above – in each of which the choice between analyses [A] and [B] clearly matters – with the following NPs:

[55] The unknown scientist from Germany.

[56] The new railings in the park.

[57] That tall student in the hat.

With these, either analysis is possible. The topmost NOM in [55], for example, could be analysed either as [A] [[*unknown scientist*] [*from Germany*]] or [B] [[*unknown*] [*scientist from Germany*]]. So which should we choose? Well, the analysis that associates the more PERMANENT and/or INTRINSIC property more closely with the head noun will generally seem more natural. Thus the [B] analysis seems more natural for [55], since being from Germany is more permanent/intrinsic than being unknown.

The NP in [58] includes three modifiers:

[58] that tall student of maths in the hat.

Bearing in mind that there will be as many NOMs as there are modifiers, and that *student of maths* corresponds to the VP constituent [*studies maths*], give a COMPLETE phrase marker for that NP (i.e. using no triangles). **Discussion 7**, page 159.

More on Adjective Phrases

A few adjectives (including *present*, *absent*, *responsible*, *visible*) can pre-modify or post-modify the head noun in NOM.

[59a] the responsible men [59b] the men responsible

[60a] the present members [60b] the members present

As post-modifiers, APs occupy the same position in the structure of NOM as post-modifying PPs. A difference in meaning is associated with this difference of position of the AP. In [59a] the men are responsible sort of people – that's their nature. But in [59b] they are responsible *FOR something*. In [60a] they are the current members. But in [60b] there were present *AT* (i.e. attended) *some event*. In contrast to the pre-modifying APs, when an AP appears in the post-modifying position, I hope you agree that it feels as if something has ellipted from the AP.

The ellipted element functions as **COMPLEMENT OF THE ADJECTIVE**. In the following APs, the complement is explicit.

- [61] responsible for the sauces. [62] happy in his job.
 [63] nervous of exams. [64] devoid of hope.

When, in an NP, a modifying AP includes a complement, it always **post-modifies the head noun**:

- [65a] the chef responsible for the sauces [66a] a stuntman happy in his job.
 [65b] *the responsible for the sauces chef [66b] *a happy in his job stuntman

Here's the phrase marker for [65a]:

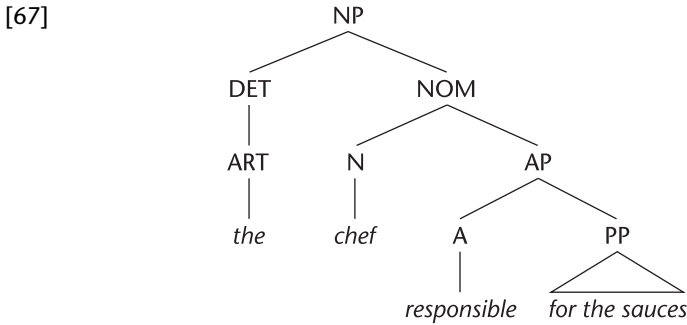

There's a reason why such APs must **post-modify** the Noun. Call it 'The Friendly Head Principle' (FHP): **within NOM, the head of a modifying phrase wants to be as close as possible to the head noun**. In [65a], the head of the AP (*responsible*) is right next to the head of the NP (*chef*). By contrast, in pre-modifying position, in *[65b], the head of the AP is separated from the noun by the AP's own complement. Notice that the FHP explains **why PPs with an NP complement (P+NP) always post-modify the head noun**. It also explains why, when a modifying AP includes – or even *could* include – (pre-)modification by DEG, it pre-modifies the head noun. Compare [68] and [69a–b]:

- [68] the very responsible men
 [69] a. *the chef very responsible
 b. *the chef very responsible for the sauces.

Modification of pronouns

I have said that pronouns replace full NPs. It is rather awkward, therefore, to find pronouns combining with an AP [70a–b] or PP [71a–b] *within* the structure of an NP.

- [70a] something outrageous. [70b] anyone intelligent.
 [71a] someone in the crowd. [71b] no-one/none from the bank.

In the case of indefinite pronouns such as *something/one*, *anything/one*, *nothing/no-one/none*, what has happened, historically, is that a determiner (*some*, *any*, *no*) and a head noun (*thing/one*) have coalesced into a single word (*some surprising thing* → *something surprising*, *any intelligent one* → *anyone intelligent*). The fact that such pronouns can only be post-modified (not pre-modified, as in **intelligent anyone*) is connected with this historical fact. It means we must allow for phrase marker representations like [72a–b].

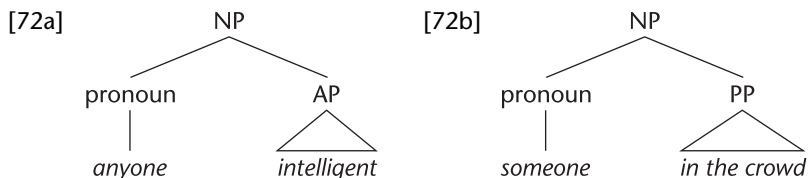

The same analysis might seem appropriate for [73]–[74], especially since the italicised words are often categorised as pronouns:

[73a] *some* of the animals. [73b] *those* in the cabin.

[74] $\left\{ \begin{array}{l} all \\ both \\ half \end{array} \right\}$ of the bottles.

However, IF (big ‘if’) they are pronouns, notice they are also **determiners** ([73a–b]) or **pre-determiners** ([74]). In fact, pronouns that cannot also function as determiners or pre-determiners cannot be post-modified: **they from the factory*, **he of the men*.

It is arguable, then, that the ‘pronouns’ in [73]–[74] are not pronouns at all, but are what they always were: determiners or pre-determiners. They appear to have changed into pronouns – and thus be functioning as the head of their NP – only because **the real head of the NP has been ellipted**. This suggests that [73a], for example, should be analysed as in [75], in which *animals* is the ellipted head:

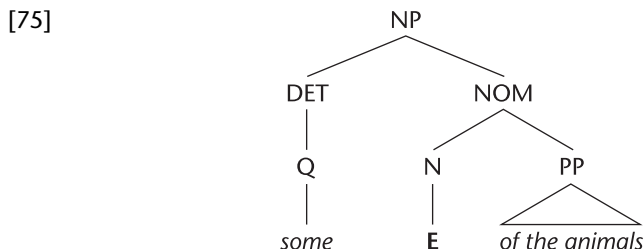

I shall adopt **this elliptical head analysis**. This maintains the categorisation of the italicised words in [73]–[74] as determiners/pre-determiners. Applied to [76], for example, the elliptical head analysis allows us to maintain the categorisation of numerals (e.g. *two*) as quantifying adjectives (QA).

[76] the two in the dungeons.

Give the phrase marker for [76]. **Discussion 8**, page 180.

There are facets of NP structure that this chapter has not engaged with. Some are dealt with in the chapters that follow. Furthermore, several problems have been skirted over. You can get an idea of what these are by looking closely at NPs in any piece of writing and seeing to what extent the analyses proposed here can handle them. A refinement to the analysis, which you and/or your tutor may want to incorporate, is discussed in the Appendix to this chapter.

Discussion of in-text exercises

1.

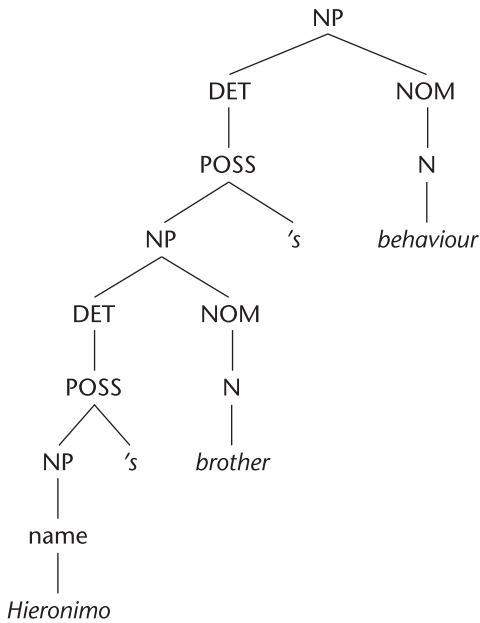

2.

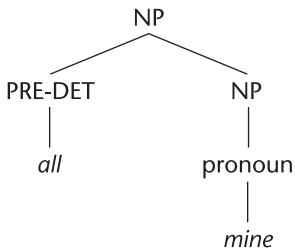

3.

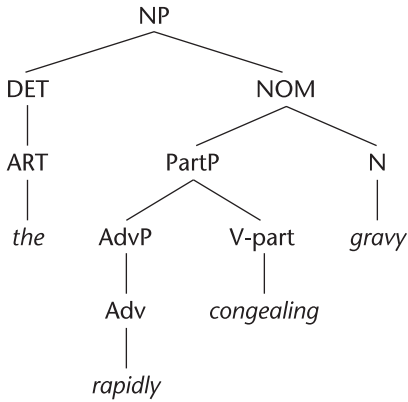

4.

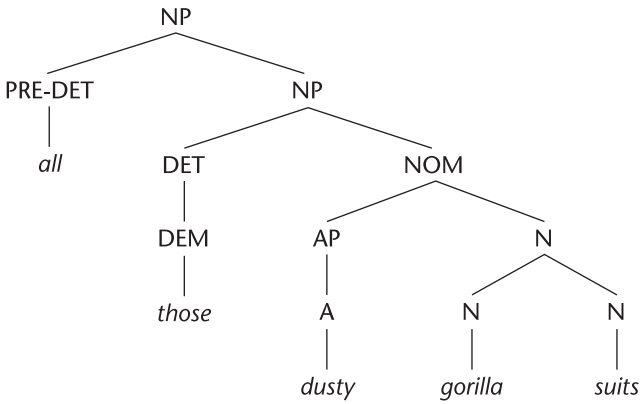

5.

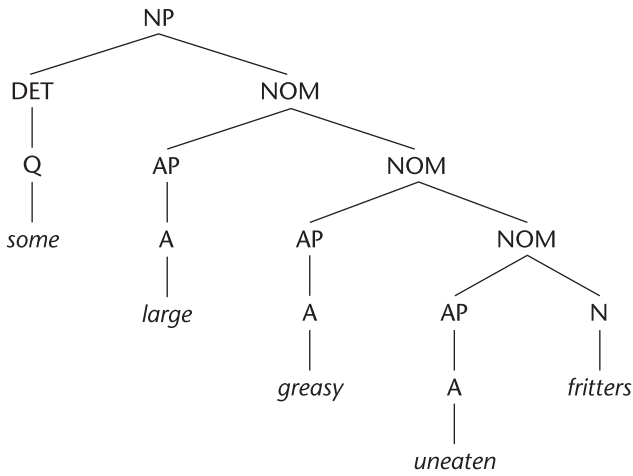

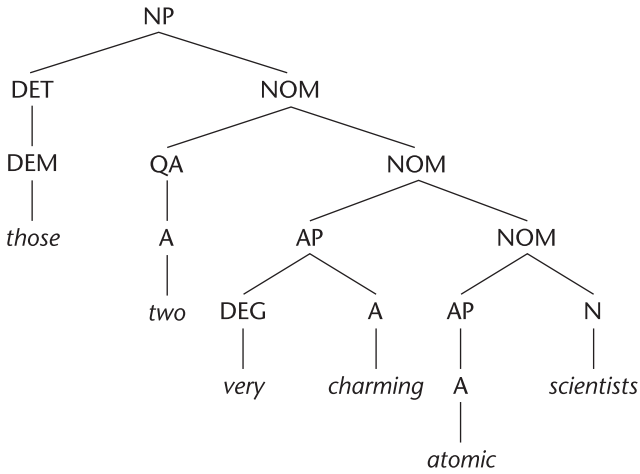

- 6. [48] Those [[observations on alchemy] [by Newton]]. (a)
- [49] An [[interpretation] [of that sentence in Proust's novel]]. (b)
- [50] A [[book] [of quotations from Shakespeare]]. (b)
- [51] A [[book of quotations] [from Oxford University Press]]. (a)

7. *Of maths* relates most closely to the head N *student*. And *tall* denotes a more permanent property than *in a hat*. So I suggest:

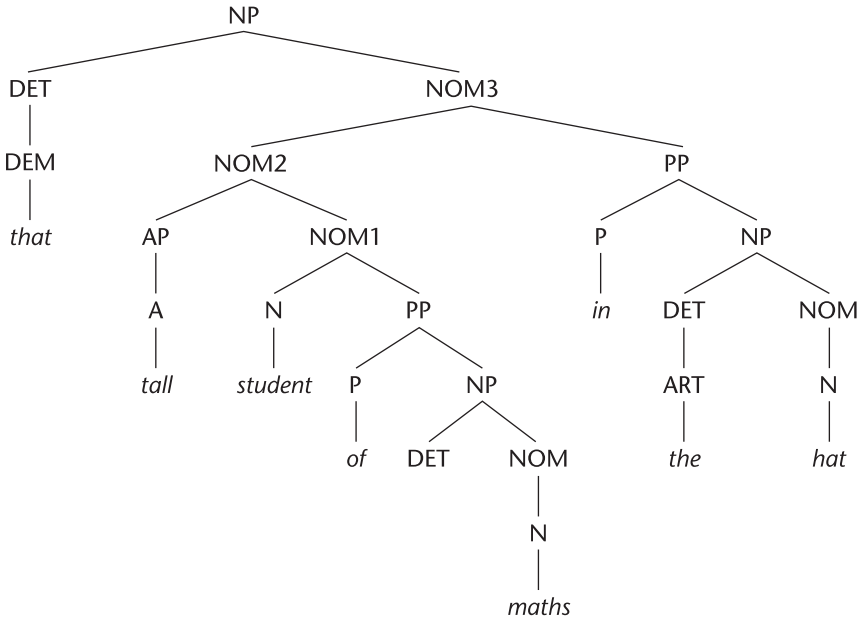

8.

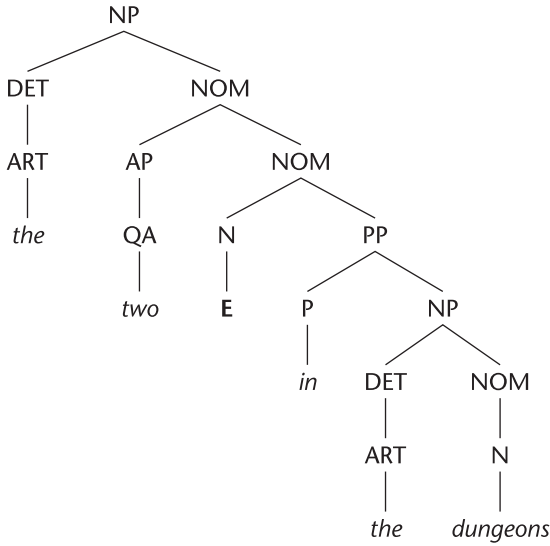

Exercises

Draw complete phrase markers for the following NPs. 'Complete' means not using any triangles. Several of them involve empty DET (sometimes more than once). (c) is ambiguous and should be assigned two phrase markers. (f) contains a co-ordination. Remember that the mother and the two sisters of the co-ordinator *and* must be of the same category. Before attempting (f), ask yourself whether it is a co-ordination at the lexical (N), intermediate (NOM), or phrasal (NP) level.

- (a) Experts at syntax.
- (b) Those ten paintings of his garden by Monet.
- (c) More ferocious curries.
- (d) The dying king's final message.
- (e) All Gulbenkian's contributions to charity.
- (f) Some rather off-putting gestures and remarks.

Discussion of exercises

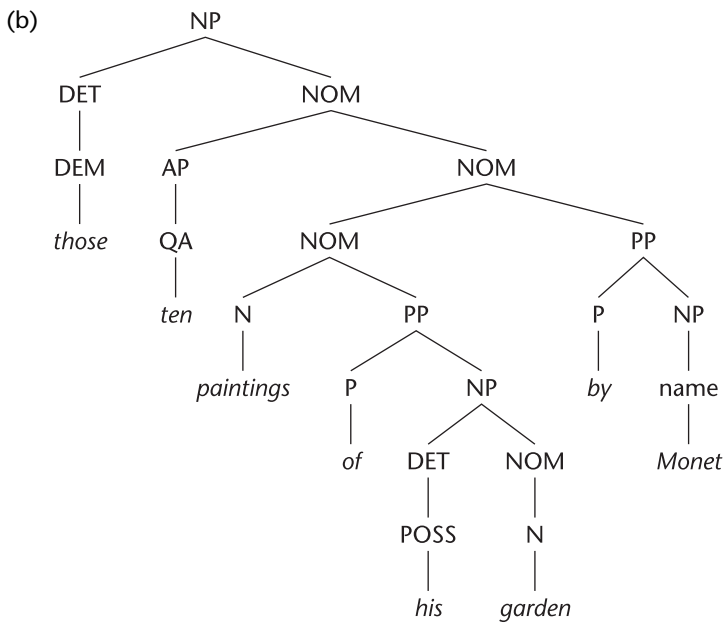
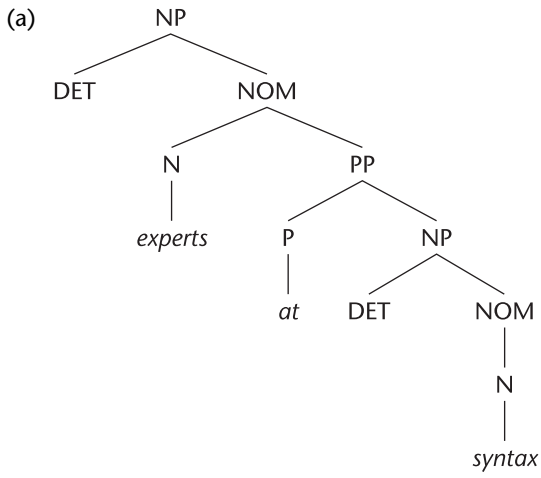

(c) (i)

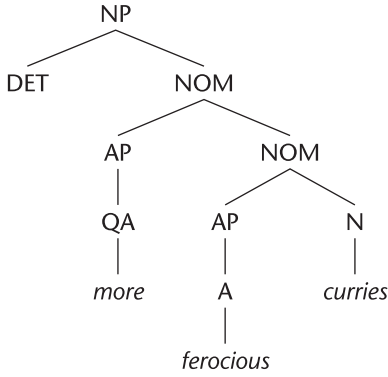

(ii)

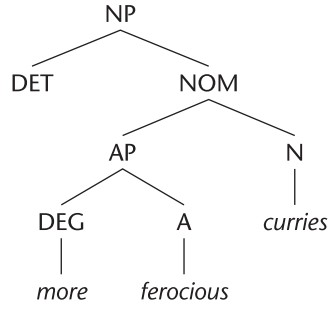

(d)

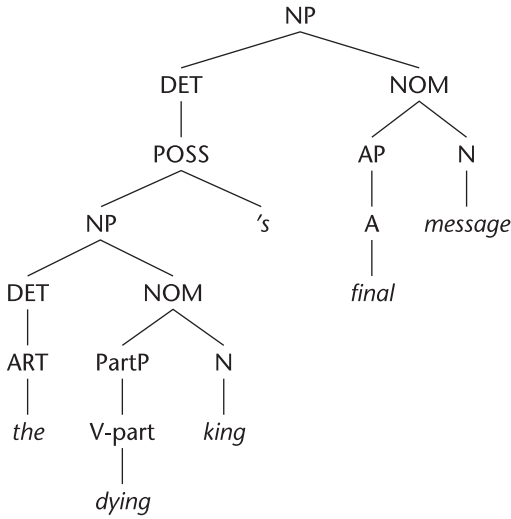

(e)

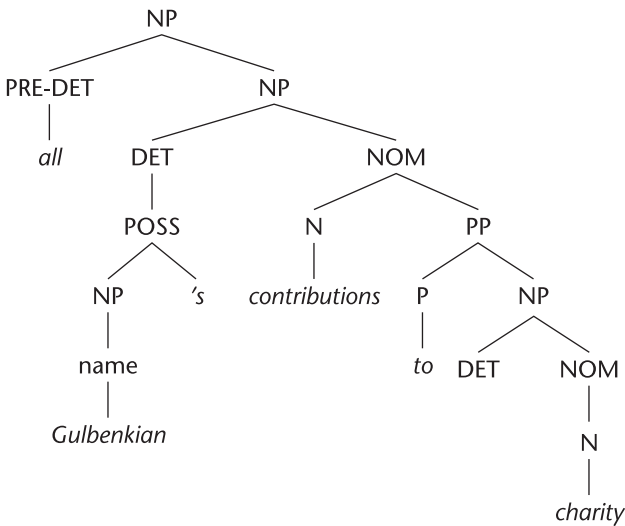

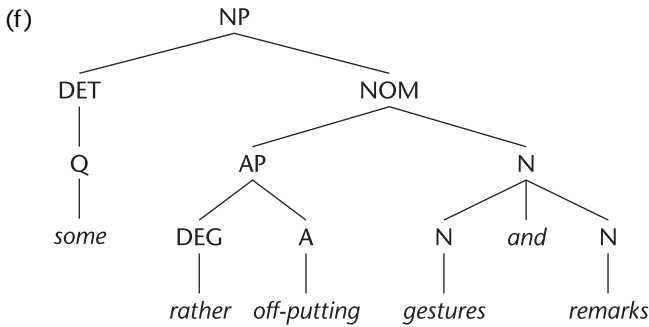

Further exercises

1. On page 146, *few* was categorised as a quantifying adjective (QA), so *the few students* would be analysed as in (a):

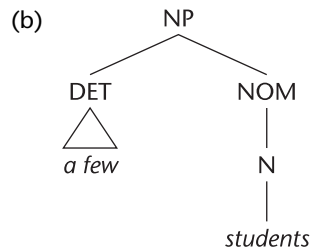
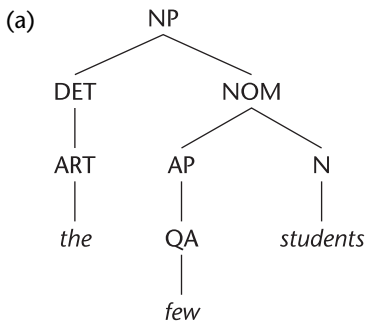

However, analysis (a) is not appropriate for the NP *a few students*. For this, I propose analysis (b), in which *a few* is represented as a constituent. Explain what is wrong with analysing *a few students* as in (a). A similar issue arises with the NP *a little butter*. *A few* and *a little* are special – highly irregular – determiners.

2. Draw complete phrase markers for the following NPs. (Note: I would never be so boring as to give two examples exactly the same.)

Set 1

- Melancholy thoughts.
- Some very clever chess moves.
- The boat's sudden move to the left.
- The word on the tip of my tongue.
- Some contributions to the fund from unknown sources.
- All performers absent from the rehearsal.

Set II

- (a) Coffee and oranges.
(Not ambiguous, but three analyses are possible. If you give only one of these, save ink and give the simplest.)
- (b) Three stars visible to the naked eye.
- (c) The king of England's short and turbulent reign.
- (d) These well-dressed men and women. (ambiguous)
- (e) Both the man's eyes.
- (f) Both the men's behaviour.
(e) and (f) need care. (e) means 'both eyes of the man', not *'the eyes of both the man'. (f) means 'the behaviour of both the men', not *'both the behaviour of the men'.

Set III

- (a) The few remaining pieces of kitchen furniture.
 - (b) Anyone capable of rational thought or reasonably sensitive.
 - (c) Some of those people at the back.
 - (d) These two coins and the three in the pocket of your coat.
 - (e) Three tall passengers angry about the altered height of the bulkheads.
 - (f) Many of the more successful chess players.
2. This chapter concludes my survey of simple sentences. The remaining chapters deal with complex sentences (sentences that contain sentences as constituents). So this is an appropriate point to revise what has been covered thus far on simple sentences. Draw *complete* phrase markers, then, for the following. Leave yourself plenty of room. Several contain co-ordinations; before analysing them, satisfy yourself as to the category of the constituents co-ordinated in them.
- (a) Obviously, this calls for a thorough examination of the facts.
 - (b) Did the old man's secretary open the mail on that particular day?
 - (c) You must always bring the vehicle to a halt at a red traffic light.
 - (d) Extra hands have been hired for no good reason, apparently.
 - (e) Bruno and the spy at the embassy might be the same person.
 - (f) The driver of a passing limousine didn't stop or offer them a lift to the castle.
 - (g) Could Olaf be being investigated by the Intelligence Agency?
 - (h) Aren't any students or staff signing up for the parachute jump?

Appendix: NOM and the pro-form *one*

Here I introduce a refinement of the analysis provided in this chapter. Your tutor may ask you to adopt this.

Look again at the discussion on pages 153–4, especially the discussion of the NP [53] and its corresponding sentence [54], repeated here:

- [1] Larry's neat summary of the argument. (NP)
- [2] Larry neatly summarised the argument. (S)

In Chapter 5, we saw that in sentences like [2] there are two VPs, one within the other: VP1 [*summarised the argument*] and VP2 [*neatly summarised the argument*]. I gave evidence for this, involving the expression *do so*. *Do so* replaces VPs and ONLY VPs (not Vs, for example).

- [3] Larry summarised the argument neatly and Bill did so too.

We understand [3] in a way that demands that *did so* be thought of as replacing VP2 (*summarised the argument neatly*). In [4], by contrast, *did so* must be understood as replacing just VP1, [*summarised the argument*]:

- [4] Larry summarised the argument neatly but Bill did so clumsily.

It is the ungrammaticality of [5] that shows that *did so* cannot replace just the V *summarised*:

- [5] *Larry summarised the argument and Bill did so the conclusion.

In the text I drew attention to the parallelism between VP and NOM. For every VP in the S there is a corresponding NOM in the NP. Since *do so* provides a test for VP, you might ask whether there is a corresponding **test for NOM** in NP. There is. **It involves the pronoun *one***. In fact *one(s)* should really be called a **pro-NOM**, since it only ever replaces the intermediate category NOM (never a full NP and never just N). Look:

- [6] Larry's neat summary of the argument and [this *one*], too.
(*one* = NOM2: *neat summary of the argument*)
- [7] Larry's neat summary of the argument and [Bill's clumsy *one*].
(*one* = NOM1: *summary of the argument*)
- [8] *Larry's summary of the argument and [Bill's *one* of the conclusion].
(!**one* = N: *summary*)

Just as *do so* cannot replace just the V *summarised* but only a VP, so *one* cannot replace just the N *summary* but only a NOM.

So, *one* provides a test for whether we have a NOM or not. Feel free to check the NOMs in any of the examples in the text of the chapter. You will find that

wherever there is a NOM, that sequence of words can be replaced by *one(s)*. So, if everything is going so swimmingly, why is a refinement needed?

Well, take for example one of the first NPs considered in this chapter, *the sad clowns*. Draw the phrase marker. Then check it against phrase marker [4] on page 141. That phrase marker only contains one NOM [*sad clowns*]. If that is correct, the *one* test for NOMs suggests that we should ONLY be able to replace [*sad clowns*] by *ones*. Well, we can indeed do that:

- [9] Bill hired those sad clowns and you hired these ones.
(*ones* = *sad clowns*)

However, we can also have:

- [10] For heaven's sake, fire the sad clowns and hire *some happy ones!*

Before reading further, think carefully about why this is a problem for the analysis proposed in [4] in the text. How should we alter that analysis to make it consistent with the acceptability of [10]?

In [10], *ones* cannot be understood as replacing the NOM [*sad clowns*]. If it were, [10] would be demanding that some happy sad clowns be hired. Even if it is possible for a clown to be both happy and sad, that's not what [10] means. [10] implies a contrast between happy ones and sad ones. So, in [10] *ones* is replacing just *clowns*. In phrase marker [4], though, *clowns* by itself is just a simple N, not a NOM. But we have seen that *one(s)* cannot replace just simple nouns. If *one(s)* could replace a simple noun, [8] would have been grammatical. This suggests that phrase marker [4] is wrong. Certainly, *clowns* is a noun but – because it is replaceable by *ones* – it must also be a NOM as well as an N. So the phrase marker must look like [11], with an extra NOM (in bold) dominating N.

[11]

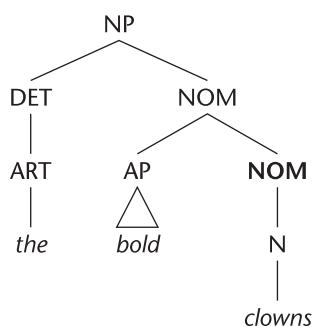

An important contrast has emerged. This is the contrast between the NOM *sad clowns* in [11] – which contains an extra, non-branching, NOM node – and the NOM *summary of the argument* in [1] – which does not. In other words, in those two examples, *clowns* is, in its own right, a NOM as well as an N, but *summary* is just an N, not a NOM in its own right.

How can you tell when the extra NOM node is required? Well, you can test for it by replacement by *one*. However, while that will help you to get things right, it does not in itself *explain* the nature of the contrast. What you really need to know is *WHY one* can replace just *clowns* in *sad clowns* but not just *summary* in *summary of the argument*.

The answer lies in the different ways in which *sad* and *of the argument* relate to their respective heads. It comes down to this: *sad* is a **sister of NOM**, whereas *of the argument* is a **sister of N**. Put this way, this should remind you of the distinction, within VP, between **sister of VP (ADJUNCT)** and **sister of V (COMPLEMENT)**. The point is that, within the NP, the PP *of the argument* relates to the head N *summary* in exactly the same way as, within the VP, the direct object NP *the argument* relates to the V *summarise*. They are both functioning as **COMPLEMENTS of the head, whether that head is an N or a V**. By contrast, there is no intuitive reason to suppose that *sad* relates to the head N *clowns* as a complement does to a V. This intuition is borne out by the fact that *the sad ones* is grammatical, indicating that *sad* is not modifying an N, but a NOM. *Sad* relates to *clowns* (NOM) in exactly the same way that *neat* relates to *summary (of the argument)*; and this, essentially, is how **ADJUNCTS** relate to the VP (*summarise the argument*).

In sum, the distinction between sister-of-V and sister-of-VP – which is the distinction between complement and adjunct – is paralleled by the distinction between sister-of-N and sister-of-NOM. So, a **sister-of-N in an NP functions as a COMPLEMENT in the NP** and a **sister-of-NOM functions as an ADJUNCT in NP**.

As another example, consider [48] in the chapter, repeated as [12a]:

[12a] the famous writer of many detective stories.

In this NP, *of many detective stories* relates to *writer* as a **COMPLEMENT** (in parallel with the VP *wrote many detective stories*). And, sure enough, **The one of many detective stories* is ungrammatical. So *of many detective stories* must be the sister of N. *Famous*, by contrast, is more peripheral in its relation to *writer*. It is a (modifying) adjunct. As such it is the sister of a NOM (*writer of detective stories*). This predicts that *the famous one* will be grammatical, which it is.

In respect of this example, we have simply confirmed what was established in the chapter. The refinement being presented here concerns not [12a] so much as [12b]:

[12b] the famous writer.

We have established that *famous* is a NOM-sister in [12a]. Clearly, *famous* has exactly the same relation to *writer* in [12b] as it does in [12a]. So it must be a NOM-sister in [12b] as well. *One* can replace just *writer* in [12b]. So [12b] must have the extra NOM node.

The effect of the analysis proposed in this Appendix then is this: the distinction between sister-of-N and sister-of-NOM is now a linguistically significant

distinction. It is the distinction, within NP, between COMPLEMENT and ADJUNCT. **If an expression can co-occur with the pro-NOM *one*, it must be a sister of NOM – functioning as an adjunct** (regardless of whether or not there is a sister-of-N present, i.e. regardless of whether the NOM branches or not).

Now that we have a consistent distinction between adjuncts and complements in NP, we can explain some obvious ordering facts. For example *of maths* and *in hats* have to appear in the order given in [13a]:

[13a] those students of maths in hats. [13b] *those students in hats of maths.

The explanation is that *of maths* relates to the N *student* as *maths* relates to the verb *studies* in the VP *studies maths*. It's a complement – and as such, it is sister-of-N. Inevitably, a sister-of-N will appear immediately adjacent to N, as in [13a]. [13b] is ungrammatical because *of maths* is in a position in which it could only be the sister of the NOM *students in hats*. *In hats*, on the other hand, is an adjunct and thus sister-of-NOM – so it tolerates being separated from the head noun.

Consider now:

[14] a painter with real talent from Germany.

[15] a painter from Germany with real talent.

What conclusion can be drawn from the acceptability of both these orders, in the light of what was said about order in [13a] and [13b]?

Since *from Germany* can modify *painter with real talent*, as in [14], it must be a sister-of-NOM (an adjunct). Now, *painter with real talent* could consist of N + PP or NOM + PP. But which? Put another way, is *with real talent* a complement or an adjunct? The fact that it can be separated from the head N – as in [15], where it is modifying *painter from Germany* (a NOM) – indicates that it too is a sister-of-NOM (an adjunct). So *with real talent* and *from Germany* are both adjuncts (sisters of NOM) and this explains why they can occur in either order. Consistent with this, notice that, in both [14] and [15], *one* can replace just *painter*.

In the light of the analysis proposed in this Appendix, draw the phrase markers for the following. They are given as Answers to Exercise at the end of this Appendix.

[16] those observations by Newton.

[17] Larry's neat summary.

[18] Larry's summary of the argument.

There is a final point to notice about *one*. Remember, it is a pro-NOM. As a NOM, it co-occurs with DET (*the one, that one*). But what about the following NPs?

[19a] one from Poland. [20a] one (as in *I've just eaten one*).

By contrast with *the one from Poland*, which is definite, [19a] and [20a] are indefinite. This suggests that *one* can be determined by empty DET.

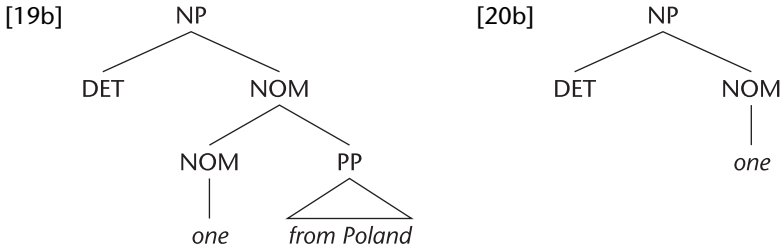

Notice that, in this one case, NOM does not dominate N, but dominates *one* directly. *One* must be immediately dominated by NOM and not by N, because it is a pro-NOM, not a pro-N (not a PRONOUN).

■ Answers to exercise

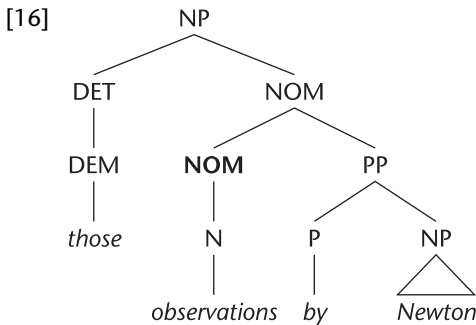

By Newton tolerates being separated from *observations* – as in *those observations on alchemy by Newton* – so it is sister-of-NOM (cf. *those ones by Newton*).

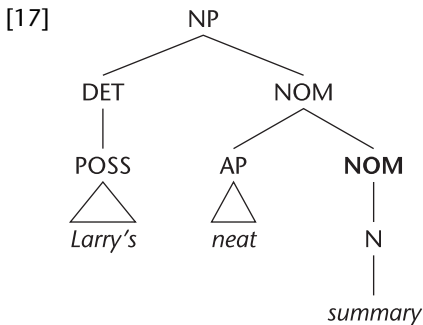

[18]

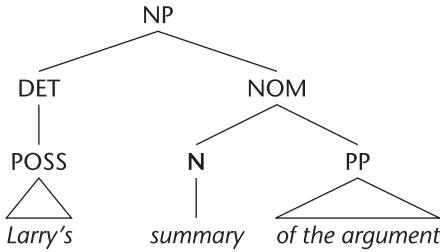

Further exercise

Decide, for each of the following italicised expressions, whether they are complements or adjuncts. Some are ambiguous. In this connection, notice that *a diplomatic appointment* can mean either 'an appointment that was (very) diplomatic' or 'the appointment of a diplomat'. Which of these interpretations does *a diplomatic one* have? Answering that will help you correlate the interpretative distinction (complement vs. adjunct) with the distinction between sister-of-N and sister-of-NOM.

- | | |
|---|--|
| (a) Contributions <i>from unknown sources</i> . | (b) Contributions <i>to the fund</i> . |
| (c) The destruction <i>of the building</i> . | (d) The destruction <i>of April 1944</i> . |
| (e) The applicant <i>in the waiting room</i> . | (f) The applicant <i>for the job</i> . |
| (g) An adviser <i>to royalty</i> . | (h) A <i>royal</i> adviser. |
| (i) A <i>nuclear</i> scientist. | (j) A <i>charming</i> scientist. |
| (k) An <i>attentive</i> student. | (l) A <i>French</i> student. |
| (m) A <i>criminal</i> lawyer. | (n) A <i>stellar</i> observatory. |
| (o) A <i>pessimistic</i> engineer. | (p) A <i>structural</i> engineer. |

8

Sentences within sentences

You are now familiar with the idea that a constituent can contain constituents of the same category as itself. For example, an NP may contain further NPs, a NOM may contain further NOMs, a VP further VPs, and so on. This is called recursion. This and the next two chapters are concerned with the description of **sentences that contain sentences as constituents** – in other words, with sentential recursion.

You should not have much difficulty in picking out, within the structure of the following sentence, a sequence that can itself be analysed as a sentence.

[1a] Georgette said she burned the fritters.

The verb *say* is transitive and its direct object is [*she burned the fritters*], which is itself analysable as a sentence. Here is an initial phrase marker for [1a] (I modify it slightly below):

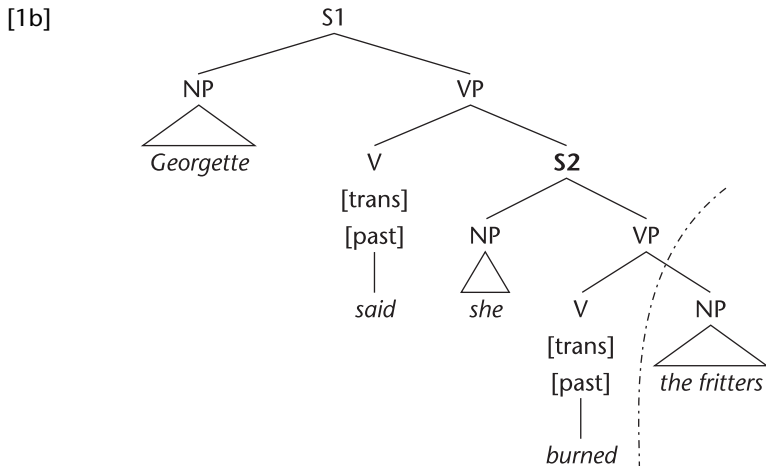

[1a] is a **COMPLEX sentence**: it contains a sentential structure as a constituent (marked off by the dotted line). Contrast [1a] with the **co-ordinate, COMPOUND sentence** [2]:

[2] He hired the acrobats and you hired the clowns.

The two sentential structures in [2] are independent of each other. Neither is a constituent of the other. They are at the same level in the structure of [2]. That is why they are described as CO-ORDINATE – with the emphasis on ‘co’.

You can see that the two sentential structures in [1a/b] are *not* at the same level of structure. S2 is part of the structure of S1. Stripped down to essentials, S1 = [*Georgette said S2*]. So, S2 is said to be **SUBORDINATE** to S1, with the emphasis on ‘sub’. It is **LOWER** in the structure. And S1 itself is **SUPERORDINATE** to S2 – emphasis on ‘super’. It is **HIGHER** than and includes S2.

Subordinate sentential structures are traditionally called **SUBORDINATE CLAUSES** (less traditionally, ‘embedded sentences’). So this chapter is all about subordinate clauses, and their relation to their superordinate clauses.

Now look at [3], which contains two subordinate clauses:

[3] I thought Georgette said she burned the fritters.

As before, [*she burned the fritters*] is a sentential structure (a clause) which is subordinate to, and contributes to the structure of, [*Georgette said S*]. But now, in [3], [*Georgette said S*] is in turn subordinate to [*I thought S*]. We thus have three clauses in [3].

Every clause has a lexical verb. So we can identify clauses in terms of their lexical verbs, referring in [3] to the *burn*-clause, the *say*-clause and the *think*-clause. [3] shows that a clause can simultaneously be subordinate to one clause and superordinate to another. In [3] the *say*-clause is subordinate to the *think*-clause but superordinate to the *burn*-clause. The *burn*-clause is subordinate to both the other clauses.

The clause that is not subordinate to any other clause is referred to as the **MAIN CLAUSE**. In [3], then, the main clause is the *think*-clause. The lexical verb of the main clause is the **MAIN VERB**. In phrase markers, the main clause will be the highest clause.

If we want to concentrate just on what clauses a sentence contains and on how those clauses relate to each other in the structure, we can strip away all other details and use triangles for clauses. I shall call any phrase marker that does just this an **ABBREVIATED CLAUSAL ANALYSIS (ACA)**. The ACA of [3] is:

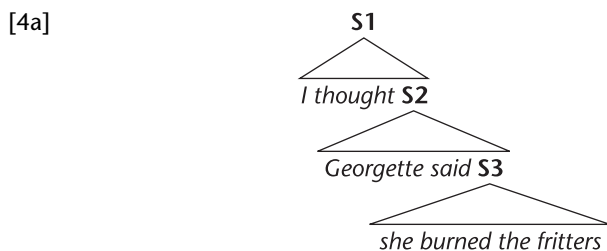

Alternatively, an ACA can take the form of a labelled bracketing, as in [4b]:

[4b] S1[I thought S2[Georgette said S3[*she burned the fritters*]]]

The representation in [4a] shows that [3] is a right-branching clausal structure: each subordinate clause branches off regularly from the right of its superordinate clause. Although right-branching is preferred in the structure of English, not all clausal structures are right-branching. To see this, identify the subordinate clause in [5] and the two subordinate clauses in [6]. Which is the main verb in [5] and in [6]?

[5] He reminded the men that he was in command at every opportunity.

[6] The fact that you received no greeting from Mars doesn't mean that it is uninhabited.

Within the structure of [5], [7] can be identified as subordinate clause, and within the structure of [6], [8a], and [8b] can.

[7] He was in command.

[8a] You received no greeting from Mars. [8b] It is uninhabited.

Reminded is the main verb of [5] and *mean* is the main verb of [6].

It is important to note that, in [5], *at every opportunity* has its function in respect of the main verb *reminded*. *At every opportunity*, then, belongs in the main clause: *He reminded the men . . . at every opportunity*. It can't be considered as part of the subordinate clause, since, even were it clear what *he was in command at every opportunity* means, that is clearly not part of the meaning of [5].

The abbreviated clausal analysis of [5], then, will be:

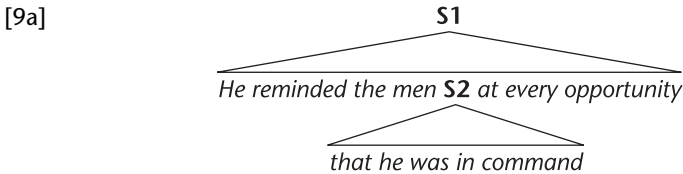

[9b] S1[He reminded the men S2[that he was in command] at every opportunity]

As you can see from [9a], [5] is not right-branching. Now try an abbreviated clausal analysis of [6] above.

You may remember the subject~predicate analysis of this sentence from Chapter 2, Exercise 1(f): SUBJECT [*the fact that you received no greeting from Mars*], PREDICATE [*doesn't mean that it is uninhabited*]. The first subordinate clause [8a], falls wholly within the main clause subject, while the second, [8b], falls wholly within the main clause predicate. So, although [6], like [3], contains two subordinate clauses, it differs from [3] in that each subordinate clause is subordinated directly to the main clause; neither is subordinate to the other subordinate clause. As the following analysis shows, [6] is not a regularly right-branching structure either.

[10a]

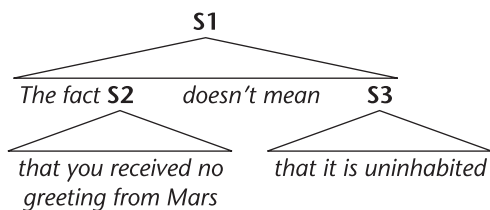

[10b] S1[the fact S2[that you received no greeting from Mars] doesn't mean S3[that it is uninhabited]]

As noted, subordinate clauses are straightforwardly analysable as sentences, exactly as in previous chapters. In the rest of the chapter, then, I concentrate not so much on the internal structure of subordinate clauses but on how they fit into the structure of, and their functions within, their superordinate clauses.

Complementisers: *that* and *whether*

You will have noticed that the subordinate clauses in [5] and [6] were preceded by *that*. **THAT** is a marker of clausal subordination. It serves to introduce subordinate clauses. When it functions in this way (rather than as a determiner), **THAT** is a **COMPLEMENTISER**.

As a complementiser, *that* fills the C position occupied by fronted auxiliaries in questions. This was introduced in Chapter 6. Remember, **the complementiser position – ‘C’ – is defined as: daughter of S-bar (S')** and sister of a following S. The representation of the complementiser and subordinate clause in [5], then, is as in [11a]. This can be further abbreviated as in [11b].

[11a]

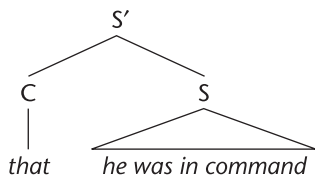

[11b]

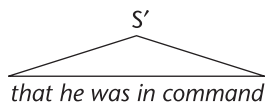

From now on, I shall assume that **all subordinate clauses are introduced by a complementiser and therefore dominated by S-bar**. However, we have seen that the complementiser may not always be overtly present. In [5] and [6] it was overt. By contrast, neither of the subordinate clauses in [3] was overtly introduced by a complementiser – though both could have been, as in [12].

[12] I thought *that* Georgette said *that* she wouldn't burn the fritters.

When the complementiser introducing a subordinate clause is absent, think of it as having been ellipted. As it were, it *is* there, but not overtly. There are circumstances in which the complementiser simply cannot be ellipted. In my

dialect at least, it cannot be ellipted in the first subordinate clause of [6] – as in [13] – but it can in the second – see [14].

[13] *The fact [• [you received no greetings from Mars]] . . .

[14] . . . doesn't mean [• [it is uninhabited]].

The subordinate clause within the VP in [14] would be fully represented as in [15], with the complementiser position left unfilled.

[15]

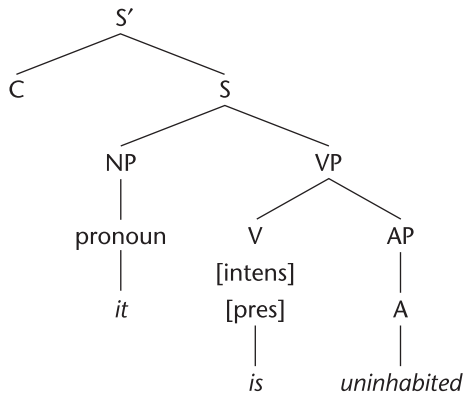

The ‘complementiser position’ – C – has that name, then, because it is the position occupied by the complementiser *that* (overt or not). As noted, the C position is needed for fronted auxiliaries in questions. Interestingly, auxiliary-fronting is possible only in main clauses, never in subordinate clauses. The explanation for this is that **complementiser *that* and fronted auxiliaries occupy the same position, namely C**: auxiliaries cannot be fronted to a position already occupied by a complementiser (whether the complementiser is overt or not).

I will refer to clauses which can be introduced by *that* as ***that*-clauses**. Not all subordinate clauses are *that*-clauses, however. **Another expression that can occupy C, and thus introduce a subordinate clause, is *WHETHER***.

[16] Sarah asked [whether those stupid sausages were ready yet].

[17] Rashid doesn't know [whether his disguise was successful].

[18] [Whether Rory should be promoted or fired] was worrying them.

[19] [Whether Millie will go up in that machine] is doubtful.

The big difference between a *whether*-clause and a *that*-clause is this. In [16] Sarah is reported as *asking* something. So, without actually being used itself to ask a question, [16] does allude to a question, and it does so by means of the subordinate clause [*whether those stupid sausages were ready yet*]. If [16] is true, then, Sarah in all probability said ‘Are those stupid sausages ready yet?’ Much the same goes for [17], where Rashid is reported as not knowing the answer

to a question, the question represented by the clause [*whether his disguise was successful*]. These subordinate clauses are interrogative in character.

So, in addition to functioning (like *that*) as a marker of clausal subordination, *whether* indicates that the subordinate clause is an INTERROGATIVE CLAUSE. The *yes/no* questions considered in Chapter 6 are interrogative clauses. As MAIN interrogative clauses, they display auxiliary-fronting and are used actually to ASK a question. *Whether*-clauses are SUBORDINATE interrogative clauses; they are subordinate counterparts to *yes/no* questions. They cannot display auxiliary-fronting to the complementiser position because that position is filled by *whether* (cf. **Sarah asked whether were those sausages ready yet*). Incidentally, notice that the interrogative complementiser can take the form of *if*. It can in [16] and [17], but not in [18] or [19].

In addition to *that*-clauses and interrogative *whether*-clauses, subordinate clauses can be introduced by subordinating conjunctions. Before dealing with these, I look at the functions of the clauses dealt with so far.

This would be a good point to try Exercise 1 at the end of the chapter.

The functions of *that*- and *whether*-clauses

I shall consider the following functions:

1. Subject – and extraposed subject.
2. Complement of V (within VP).
3. Complement of A (within AP).
4. Complement of N (within NP).
5. Complement of P (within PP).

Subject – and extraposed subject

Divide the following sentences into subject and predicate:

[20a] That the king was in his counting house disconcerted her.

[21a] That the book had a missing chapter was noticed by the critics.

[22a] That Rashid's disguise was a success is undeniable.

Your analysis should show that a subordinate *that*-clause is functioning as subject in each case:

SUBJECT:	PREDICATE:
[20a] That the king was in his counting house	disconcerted her
[21a] That the book had a missing chapter	was noticed by the critics
[22a] That Rashid's disguise was a success	is undeniable

And, in [18] and [19] above, we had examples of an interrogative (*whether*-) clause functioning as subject (with *was worrying them* and *is doubtful* functioning as predicates).

Now, we have been analysing subjects as NPs. So I shall analyse these subject clauses (otherwise known as ‘clausal subjects’) as dominated by NP. So, for example, [20a] will be represented by [23], though I have summarised liberally with triangles.

[23]

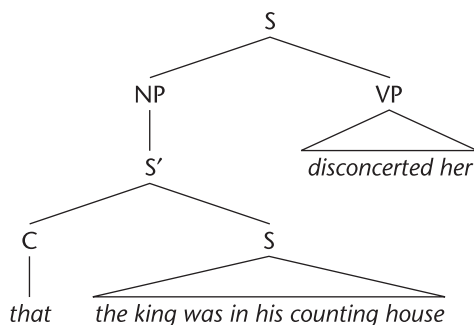

In support of having clausal subjects dominated by NP, notice that they can be replaced by a pronoun: *it disconcerted her*, *it wasn't noticed by the critics*, *it is undeniable*.

Having a clause as subject makes for a very ‘heavy’ subject. If [20a]–[22a] seemed at all unnatural to you, you are almost certainly responding to this. In English we generally prefer to defer such complexity to the end of the sentence. So a characteristic of CLAUSAL SUBJECTS is that they can be EXTRAPOSED from under the subject NP node to the end of the sentence, leaving behind the empty pronoun *it*. Here are the extraposed versions of [20a]–[22a]:

[20b] *It* disconcerted her [that the king was in his counting house].

[21b] *It* was noticed by the critics [that the book had a missing chapter].

[22b] *It* is undeniable [that Rashid's disguise was a success].

What are the extraposed versions of [18] and [19] above? (I give them below.)

The *it* that takes the place of the clausal subject is special: it is quite empty of meaning. It simply serves as a ‘dummy’ subject. This is the *it* of *it is raining*, which is there just to give the verb *rain* a subject, obligatory in English though not in some other languages, e.g. Italian (*piove: it is raining*). Just as it makes no sense to ask ‘What is raining?’ (the only possible answer being ‘rain’), it makes no sense to ask ‘What disconcerted her that the king was in his counting house?’ This is called **EXPLETIVE IT**, to distinguish it from referring uses of *it*.

I shall represent these extraposed subjects as daughters of the main clause S, as in [24], for example.

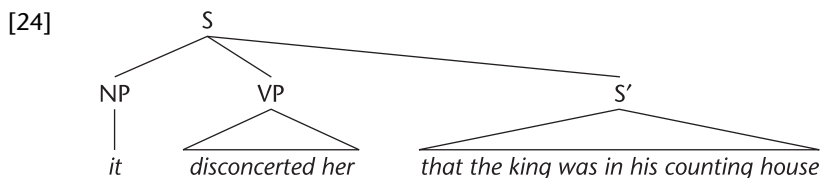

The extraposed versions [18] and [19] are:

[25] It was worrying them whether Rory should be promoted or fired.

[26] It is doubtful whether Millie will go up in that machine.

So, **the extraposed subject construction** has a clausal subject displaced to the end of the sentence and expletive *it* in the normal subject position, dominated directly by NP. But now look at the following:

[27a] It seems [that the recipe involves some dubious ingredients].

[28a] It happens [that dinosaurs are extinct].

With these, if you try putting the subordinate clause ('back?') into the normal subject position, the result is totally unacceptable:

[27b] *[That the recipe involves some dubious ingredients] seems.

[28b] *[That dinosaurs are extinct] happens.

There is a handful of special verbs – including *seem*, *appear*, *transpire*, and *happen* – that cannot have clauses in the normal subject position. This raises the question whether the subordinate clauses in [27a]–[28a] can really be regarded as extraposed subjects. However, since [27a] and [28a] display the expletive *it* associated with the extraposed subject construction, I shall analyse them as such, with an analysis like that in [24]. Since this implies that the subordinate clauses *are* to be regarded as subjects, this group of verbs must be thought of as being [intransitive] in this use.

Notice, by contrast, that in [18]–[22], none of the verbs involved were [intransitive]. Those in [18], [20], and [21] were [transitive] and those in [19] and [22] were [intensive]. With these, extraposition of the clausal subject was **OPTIONAL**: the subordinate clause could appear either in the normal subject position or extraposed. In connection with our 'special' verbs, then, the generalisation seems to be that extraposition of a clausal subject is **OBLIGATORY** when the verb is [intransitive].

Now draw phrase markers for the following sentences, using triangles for all NPs. **Discussions 1 and 2**, page 188.

[29] That the squid sauce was a mistake soon became clear.

[30] It isn't my fault Max crushed your monocle.

■ Complement of V within VP

Look again [3] above, repeated here as [31]:

[31] I thought S2[Georgette said S3[*she burned the fritters*]]

Here we have two *that*-clauses functioning as complements of transitive verbs (i.e. as direct objects). In fact, this chapter has included several other examples of a subordinate clause functioning as the complement of a transitive verb. Review the examples given so far and list the clauses functioning as complements of verbs.

In addition to those in [3], the subordinate clause in [5], the second subordinate clause in [6], that in [16], and that in [17] are all functioning as complements of a verb. Furthermore, the subordinate clause in [21a/b] is the subject of a passive sentence, so it too originated as a verb complement in the active sentence [32]:

[32] The critics *noticed* [that the book had a missing chapter].

So, in addition to *notice* (as in [32]), verbs that can take clausal direct objects include *think* ([3]), the ditransitive verb *remind* ([5]), *mean* ([6]), *ask* ([16]), and *know* ([17]), and a host of others. Some of these can take a *that*-clause or an interrogative (*whether*-) clause (e.g. *know*, *tell*, and *worry*), some can only take a *that*-clause (e.g. *claim* and *remind*) and some can only take an interrogative clause (e.g. *ask* and *wonder*).

We have seen that the ditransitive verb *remind* can take a clausal direct object. Other such ditransitive verbs are *tell*, *convince*, *warn*, *persuade*, *promise*, and *inform*.

[33] Anna told him (that) his shirt was hanging out.

[34] She finally convinced him (that) he needed a shave.

That- and *whether*-clauses cannot function as indirect objects of ditransitive verbs for the simple reason that indirect objects must be able to refer to animate entities, whereas clauses (sentences) cannot. They don't refer even to concrete entities but denote propositions. Propositions are abstract and hence not animate.

That- and *whether*-clauses can function as the complements of verbs which also take NPs (including pronouns) as direct objects, as in [35]:

[35] I have always {
admitted
denied
thought
claimed
believed } it.

Furthermore clauses functioning as objects in active sentences can become subject NPs in the passive. So I shall analyse them as being dominated by an NP node, just like the clausal subjects considered in the last section. Here is the phrase marker for [33].

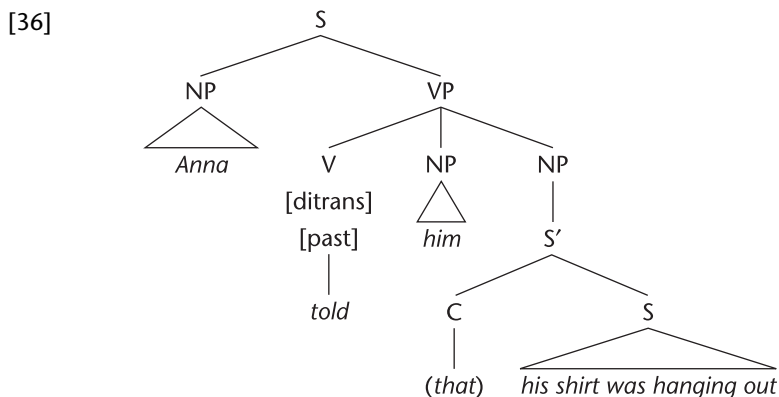

You should note, however, that not all verbs that take clausal complements can take an NP complement. *Hope* and *insist*, for example, cannot:

[37a] She hoped/insisted [(that) the performance would be a success].

[37b] *She hoped/insisted it.

Furthermore, not all object clauses can appear as subjects in passive sentences:

[38] *That his shirt was hanging out was told him.

[39] *That he should abandon the monocle was insisted by the whole company.

Since some transitive verbs cannot take a clausal object but only an NP (e.g. *kick*, *boil*, and *analyse*, among many others), and since not all transitive verbs that do take clausal objects can take NP objects, the sub-categorisation label '[transitive]' is not much help here. There is a strong case for going beyond the sub-categorisations given in Chapter 4 and sub-categorising verbs according to whether they can take clausal complements. However, the subcategorisations introduced in Chapter 4 will suffice for present purposes. This matter does become important in Chapter 10, however.

Now, using triangles for PPs and NPs, draw the phrase marker for [21b] on page 177. Bear in mind (a) that its main verb is a passive [transitive] V, (b) that *by the critics* is a VP-adverbial and (c) that the subordinate clause is an extraposed subject. **Discussion 3**, page 188.

In addition to functioning as direct objects in the complementation of V, *that-* and *whether-clauses* can function as **SUBJECT-PREDICATIVES**:

[40] The consensus is that you should taste the stew first.

[41] The question is whether he should have accepted that offer.

Notice that, of all the intensive verbs, only the copula (*be*) can take a clausal predicative. *Taste*, *smell*, *sound*, and *look* cannot. *Appear* and *seem* are, at least in one use, intensive verbs (*Julia seemed restless*, *Magda appeared happy*). However, when those verbs are followed by clauses, we are analysing those clauses, not as subject-predicatives, but as extraposed subjects. This is because *that*-clauses only follow *appear* and *seem* when those verbs have expletive *it* as subject. So [42], with its non-expletive subject (*Julia*), is ungrammatical:

[42] *Julia seemed that she was restless.

In the extraposed-subject construction, remember, *appear* and *seem* are [intransitive].

As regards clausal subject-predicatives, since we have already allowed that a range of categories can function as subject-predicatives, there is no motive for having the clause dominated by NP. So we can just allow that – in addition to NP, AP, and PP – *S'* can function a subject predicative as well.

Now draw the phrase marker for [40], using the triangle notation for all NPs. **Discussion 4**, page 189.

■ Complement of A within AP

As noted in Chapter 7, an AP can consist of A complemented by a PP (e.g. *nervous of exams*, *worried about the outcome*, *full of hope*). Adjectives can also be complemented by a *that*-clause or a *whether*-clause. So: **an AP can consist of the head A plus a CLAUSAL (*S'*) complement**. Examples are:

[43a] happy (that) they had not been chosen.

[44a] aware (that) he had overstepped the mark.

[45a] unsure whether he should sacrifice that pawn.

Such APs have all the usual range of functions for AP: subject-predicative ([43b] and [44b]), object-predicative ([45b]), modifier of N, or NOM, within NP ([46]).

[43b] The men seemed _{AP}[happy [they had not been chosen]].

[44b] Hassan was _{AP}[unsure [whether he should sacrifice that pawn]].

[45b] She made him _{AP}[aware [that he had overstepped the mark]].

[46] Drivers _{AP}[anxious [that they had made mistakes]] complained.

Clauses complementing adjectives are represented as sister of A in AP:

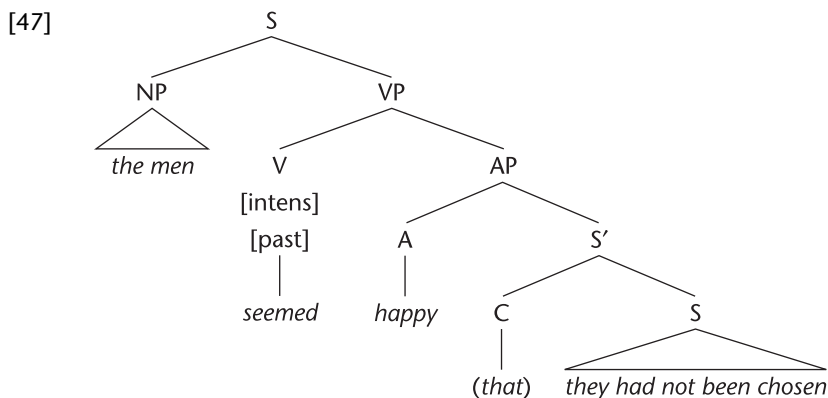

Using triangles for NPs and the embedded S, draw a phrase marker for the sentence in [45b], bearing in mind that *make* in that sentence has two complements. **Discussion 5**, page 189.

By way of revision, why not draw a *complete* phrase marker for the sentence [46]? You'll need to leave yourself plenty of room. **Discussion 6**, page 190.

An important point to notice here is the distinction between:

[48] It is certain that her hair is dyed.

[49] William is certain that her hair is dyed.

Can you explain the difference? (Look again at pages 176–178.)

Only one of them contains an AP with a clausal complement of the A. The other contains an extraposed-subject clause. It is only in [49] that [*certain that her hair is dyed*] is an AP. [48] has the expletive *it* as subject and this means [*that her hair is dyed*] is an extraposed subject. Note that [48] is paraphrased by *That her hair is dyed is certain*. So in [48] the AP just consists of the adjective *certain*.

■ Complement of N within NP

Consider the following NP:

[50] the fact that you received no greetings from Mars.

This NP contains a *that*-clause complementing the N (*fact*). A feature of **noun complement clauses** – useful in distinguishing them from other clauses that can appear in NPs – is that they can only complement **ABSTRACT** nouns like *fact*,

rumour, idea, news, claim, suggestion, rule, message, indication, etc. Thus we have NPs like those in [51] but not those in [52]:

[51] The {
news
contention
idea
suggestion
rumour
} that Sophie has arrived.

[52] *The {
book
newspaper article
programme
bucket
} that Sophie has arrived.

The clause is said to ‘complement the noun’ because it is in the same relation to the N within NP as clauses that complement the V in VP. The same goes for clauses complementing A in AP. Compare the following:

[53a] His absence [INDICATES that he disapproves]. (VP)

[53b] His absence is [INDICATIVE that he disapproves]. (AP)

[53c] His absence is [an INDICATION that he disapproves]. (NP)

The bracketed string in [53b] is simply an AP version of the VP in [53a] – minus the tense. And that in [53c] is simply the NP version of that VP (again, minus the tense). To capture the parallelism of the AP in [53b] and the NP in [53c] to the VP in [53a], we must regard the clause as a COMPLEMENT of the A in [53b] and of the N in [53c] because in [53a] it is clearly functioning as COMPLEMENT of the V *indicates*. And, since the clause complementing the V in [53a] is represented as a sister of that V, the clausal complement of the A in AP is represented as the sister of the head A. And the same goes for the clausal complement in NP. As a sister of the head N, it will be dominated by NOM. The NP in [50], then, will look like this:

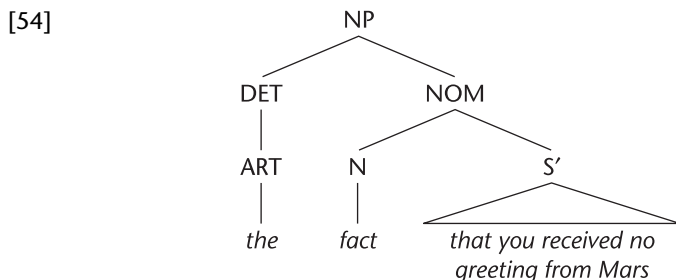

In Chapter 9 I deal with another kind of clause – the relative clause – that figures in the structure of NP. Relative clauses have a different relation to the head N and this will be reflected in how they are represented in phrase markers.

The distinction between noun-complement clauses and relative clauses need not concern you in this chapter, but it will become important in the next, and that's why I mention it here.

NPs containing complement clauses have the functions usually expected of NPs. When an NP with a clausal complement functions as subject-predicative, however, a possible confusion with the extraposed subject clause arises again. All the following sentences include a *that*-clause following a noun, but only in two of them does that clause function as noun-complement clause within an NP. Identify them.

- [55] It is a disappointment that his monocle was not stolen.
- [56] One small difficulty is the fact that dinosaurs were extinct by then.
- [57] It was a message that the party had been cancelled.
- [58] It is a well known fact that beavers build dams.
- [59] It is our contention that you could dispense with that silly monocle.

Since extraposed subject (ES) clauses only ever occur with expletive *it*, and since *it* does not figure in [56], you can be sure that in [56] we are dealing, not with an ES clause but with a noun-complement clause, within the NP *the fact that dinosaurs were extinct by then*. The others all have *it* as subject. The question is whether the *it* is EXPLETIVE or not. If this is not intuitively obvious, you can check by seeing whether the *it* in subject position can be replaced by the subordinate clause. If it can, you are dealing with an ES clause. This works with [55], [58], and [59]:

- [55a] That his monocle was not stolen is a disappointment.
- [58a] That beavers build dams is a well known fact.
- [59a] That you could dispense with that silly monocle is our contention.

In [57], by contrast, *it* does actually refer to something (a phone call perhaps). Replacing *it* with the subordinate clause yields [57a]:

- [57a] *That the party had been cancelled was a message.

Even if grammatical, this is not a true paraphrase of [57]. So, in [57], *a message that the party was cancelled* is an NP with a noun complement clause, not an ES clause.

■ Complement of P within PP

- [60a] The question *of* whether they should set up a website was raised.
- [60b] Sarah's concerns *about* whether anyone had enough time were ignored.
- [60c] It depends *on* whether the rations arrive in time.

[60a–c] show that an interrogative (*whether*-) clause can function as the complement of a preposition within PP – represented as in [61]:

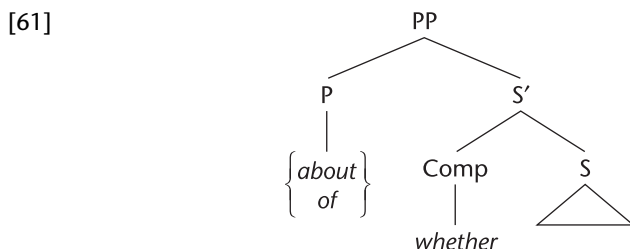

By contrast, *that*-clauses cannot function as complement to a P within PP.

[62a] *about that she left

[63a] *of that the tree falls down

[62b] *about she left

[63b] *of the tree falls down

As [62b]–[63b] show, things are made no better by omission of *that*.

But consider now *after*, *until*, *before*, and *since*. These four words do admit of a following clause, but not one introduced by *that*:

[64a] after (*that) she left.

[65a] until (*that) the tree falls down.

[66a] before (*that) it gets cold.

[67a] since (*that) you came.

Some grammars explain this by categorising these four words – *after*, *until*, *before*, and *since* – as a kind of complementiser. As complementisers, they would fill the ‘C’ slot and thus leave no room for the complementiser *that*. Well, that’s quite a nice explanation of why these four words cannot co-occur with *that*. However, it means categorising these words in two different ways: as COMPLEMENTISERS when they take a clause but as PREPOSITIONS when they take an NP as in [64b]–[67b]:

[64b] after the game

[65b] until this evening.

[66b] before the meeting

[67b] since his arrival.

It is simpler to say that these four words (*after*, *until*, *before*, and *since*) are prepositions which can take EITHER a clause (S) OR an NP as complement. They don’t change their category simply because they have S rather than NP as complement. So I shall analyse [67a], for example, as in [67c]:

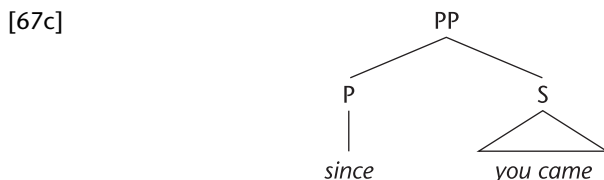

This PP analysis distinguishes these four words – *after*, *until*, *before*, *since* – from other seemingly similar words that can ONLY take a CLAUSAL complement (not an NP complement). I turn to these now, in discussing adverbial clauses.

Adverbial clauses

What distinguishes adverbial clauses from *that*- and *whether*-clauses, and clauses complementing a P within PP, is that they are introduced by **SUBORDINATING CONJUNCTIONS** such as *although*, *unless*, *if*, *because*, *once*, *as*, *now*, *so*, *while*, *since*. These are subordinating conjunctions – rather than prepositions – because they can only introduce clauses (not NPs).

I shall also take certain word-sequences as phrasal complementisers without further analysis (using triangles): *now that*, *so that*, *except that*, *as if*, *in case*, *in order that*, *as soon as*.

As subordinating conjunctions, these occupy the complementiser position, C. Compared with the complementisers *that* and *whether*, they carry extra meaning and it is this extra meaning that allows the clause they introduce to function as an adverbial. For example, in

[68] Things will be rather dull *if Hieronimo leaves*.

it is the subordinating conjunction *if* that makes the subordinate clause function as a **CONDITIONAL** adverbial clause (as does its negative counterpart, *unless*). *Because* makes for an adverbial clauses of **REASON** or **RESULT**. *So* makes for an adverbial clause of **PURPOSE**.

[69] Taxes are rising *because the bankers need huge bonuses*.

[70] I'm slaving away here *so you can have clean clothes tomorrow*.

Here, slightly abbreviated, is a phrase marker for [68].

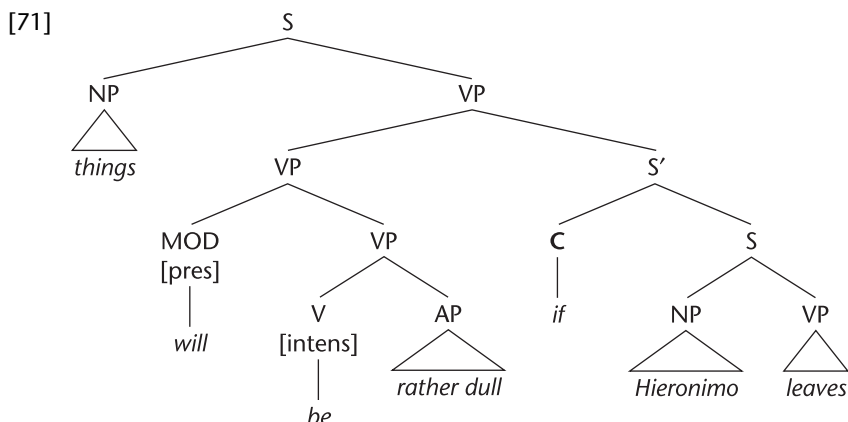

You may have noticed I have listed *since* twice: once, in the last section, as a preposition and, in this section, as a subordinating conjunction. This is not a mistake. As a preposition, *since* has a temporal meaning – [67a/b] above and [72] below. By contrast, the subordinating conjunction *since* has a meaning akin to *because* or *as* – see [73] – and, with that meaning, it can only introduce a clause, not an NP.

[72] *Since he became a friend*, I've been to all his concerts.

[73] *Since he is a friend*, I go to all his concerts.

It may seem implausible to categorise the italicised expression in [72] as a PP but that in [73] as a clause. However, notice that, as a PP, the italicised expression in [72] can function as a modifier in an NP (see [74]) but the adverbial clause cannot (see [75]). Adverbials cannot modify N or NOM.

[74] his behaviour *since he became a friend*.

[75] *his behaviour *since he is a friend*.

Equally, *before*, *after*, and *until* are prepositions – head of PP – and PPs can post-modify Ns in NP:

[76] the discussion *after you left*.

[77] a long wait *until the pubs opened*.

[78] the weeks *before the fighting started*.

By contrast, *unless*, *as if*, and *although*, for example, are subordinating conjunctions, which make for adverbial clauses. Again, adverbials cannot modify N or NOM:

[79] *_{NP}[the discussion *unless you go*]

[80] *_{NP}[his behaviour *as if you weren't there*]

[81] *_{NP}[the lack of activity *although war had been declared*]

Finally, all the examples of adverbial clauses given so far are VP-adverbials. Here are **examples of adverbial clauses functioning as S-adverbials**:

[82] *Unless I'm gravely mistaken*, you are King Kong.

[83] *Since you ask*, my name is Ozymandias.

[84] That's my toothbrush, *in case you were wondering*.

As a final exercise, give phrase markers for [69] and [82] above. Use triangles for NPs and APs. **Discussions 7 and 8** respectively, pages 190 and 191.

Discussion of in-text exercises

1.

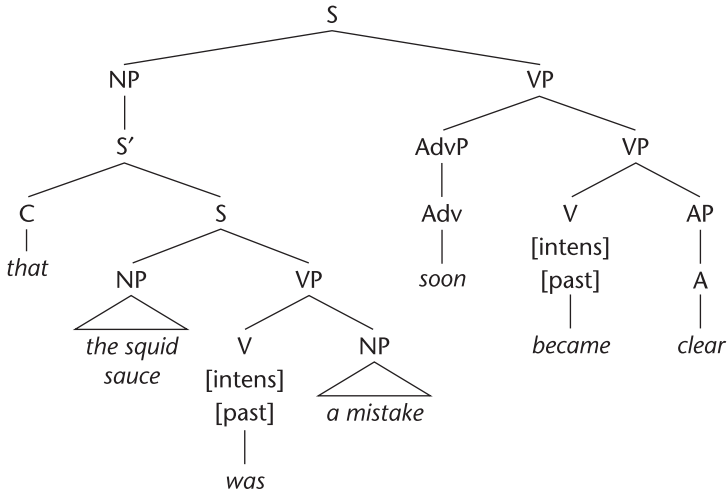

2.

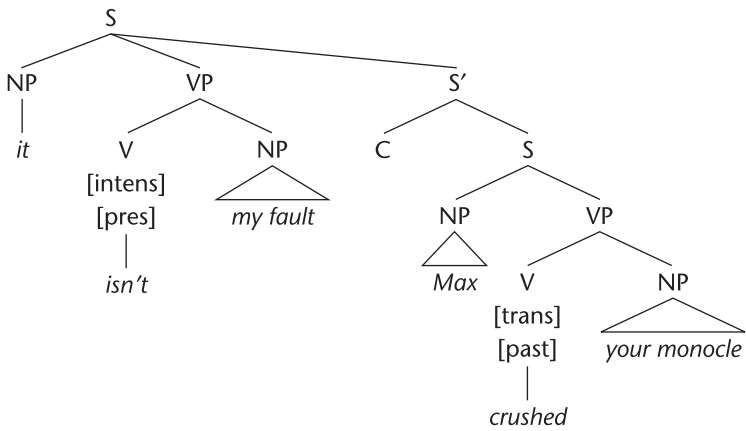

3.

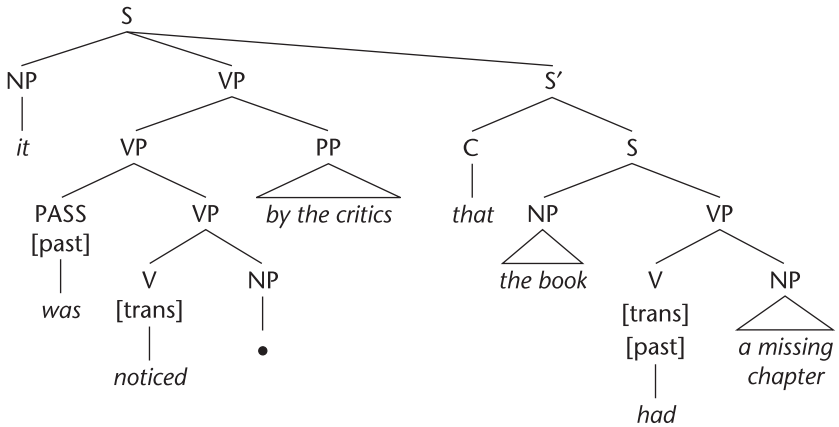

4.

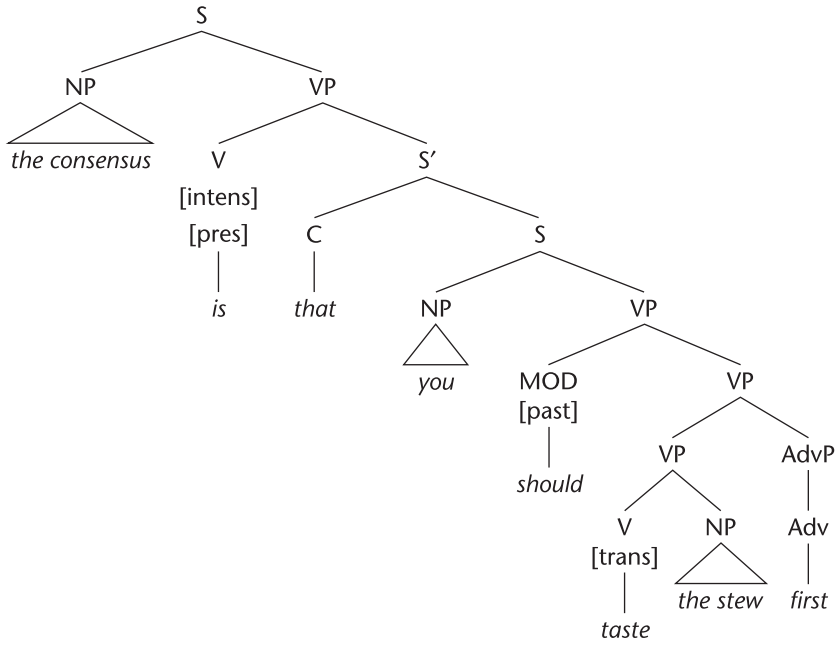

5.

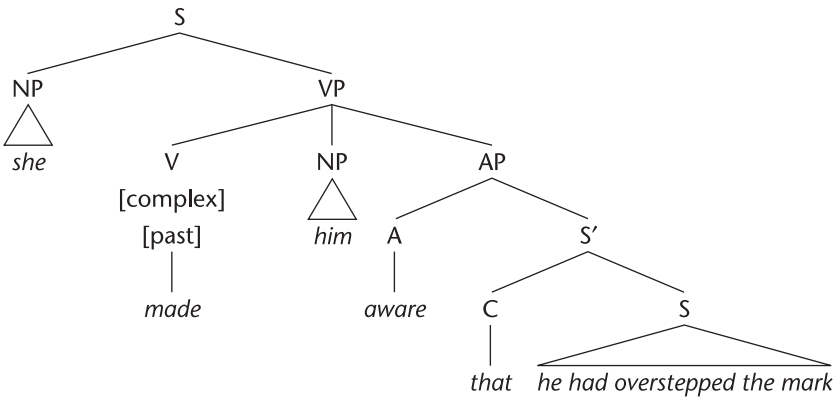

6.

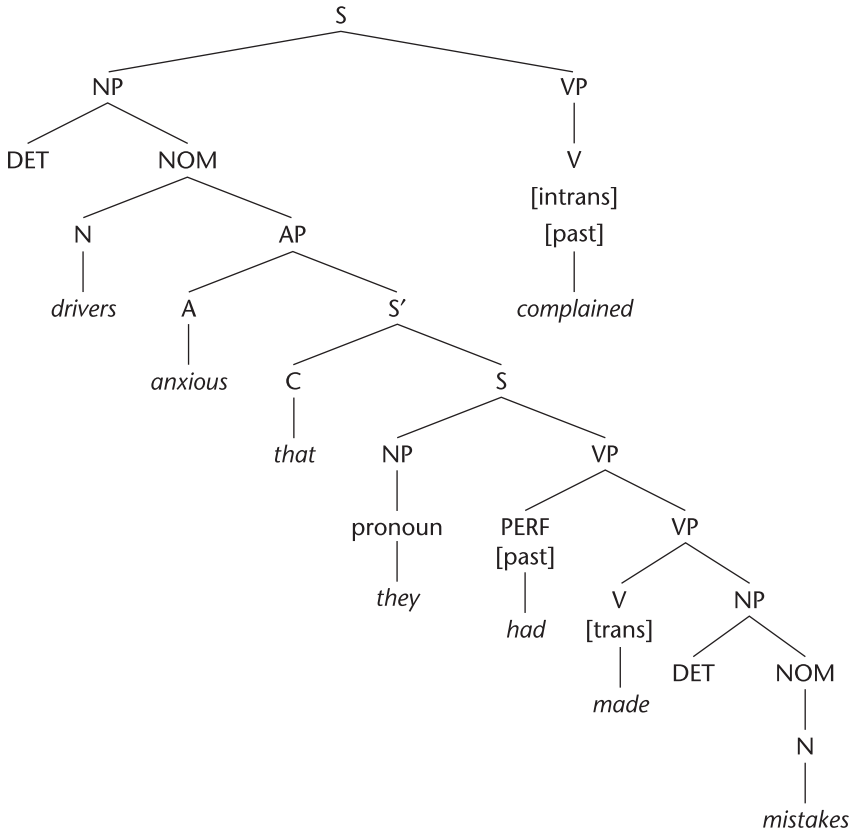

NB: In terms of the analysis in the Appendix of Chapter 7, the AP will be represented as a sister of an extra non-branching NOM node.

7.

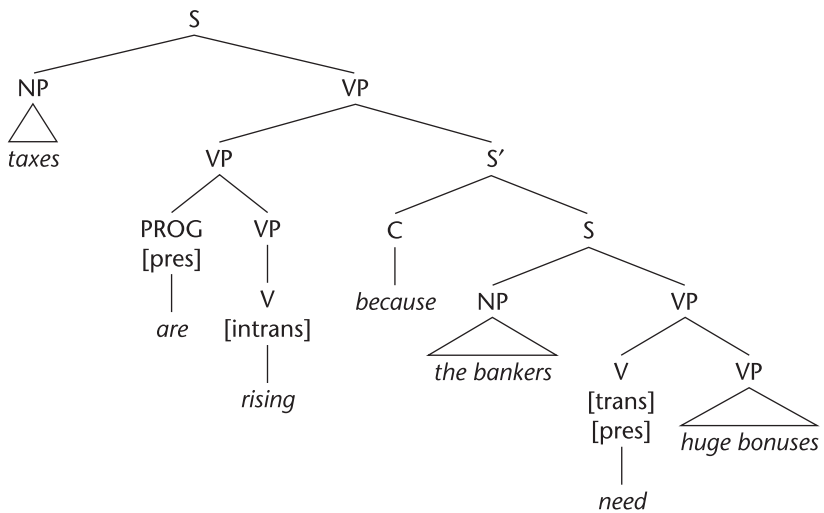

8.

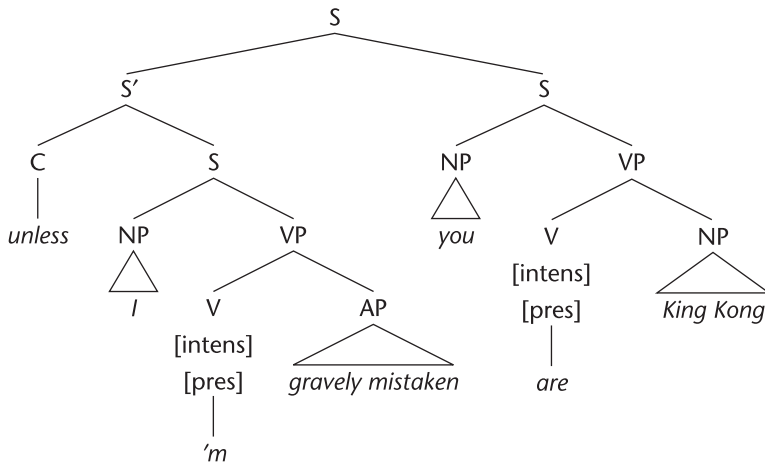

Exercises

1. Give abbreviated clausal analyses (ACAs) of the following sentences. (c) and (d) contain two subordinate clauses each. **Include all complementisers within the subordinate clause triangle.** Strictly speaking, this should mean that all subordinate clause triangles should be labelled S' (S-bar) but, for ease of presentation, I have omitted the bar in my phrase markers and I suggest you do so too. Apart from the main clause – which should always be 'S1' – it is not important how the clauses are numbered.

Here are **SOME HINTS ON HOW TO PROCEED**. First decide how many clauses there are. You can do this by **counting the lexical verbs** (one per clause). Then identify the main verb and everything associated with it in the main clause. Draw the main clause triangle and label it 'S1'. All the other clauses will be subordinate to S1 and hence below it (and contained within it). Then deal likewise with the subordinate clauses.

- They did not suspect they were being observed at all.
 - That the ejector seat didn't work was quite forgotten.
 - I don't think the fact that the moped has an ejector seat is a great selling point.
 - Your suggestion that Max might refuse a second zabaglione just shows you don't know Max.
2. Give ACAs of the following *and* give the function of all subordinate clauses.
- Until you mentioned it, it had not struck me that the book would make a good film.
 - I am surprised Rory has learned so much because he is usually asleep.
 - As soon as the princess has ascended, I knew the palanquin would not budge.

- (d) The fact that you endorse Omar’s feeling that life is too short doesn’t imply you should get drunk every day.
- (e) It appears that the new chef thought he could slip away before the missing steaks were noticed.
- (f) If you are wondering whether Max is turning up, the rumour is that, since he’s getting married, he won’t be in for a month.

Discussion of exercises

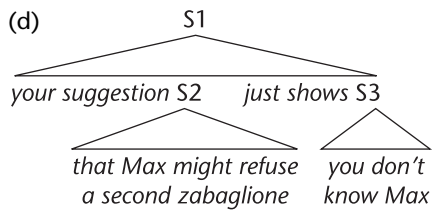
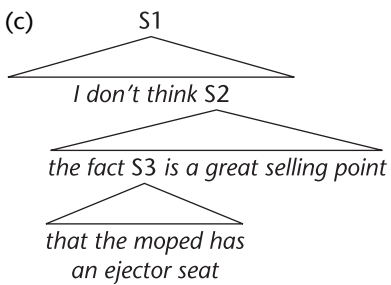
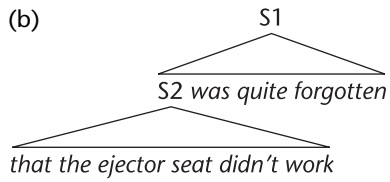
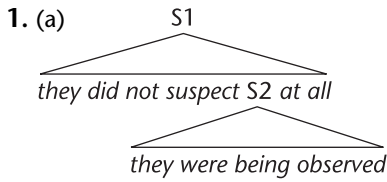

Alternatively:

- (a) s_{17} [They did not suspect s_{27} [they were being observed] $_{s_{27}}$ at all] $_{s_{17}}$.
- (b) s_{17} [s_{27} [That the ejector seat didn't work] $_{s_{27}}$ was quite forgotten] $_{s_{17}}$.
- (c) s_{17} [I don't think s_{27} [the fact s_{37} [that the moped has an ejector seat] $_{s_{37}}$ is a great selling point] $_{s_{27}}$] $_{s_{17}}$.
- (d) s_{17} [Your suggestion s_{27} [that Max might refuse a second zabaglione] $_{s_{27}}$ just shows s_{37} [you don't know Max] $_{s_{37}}$] $_{s_{17}}$.

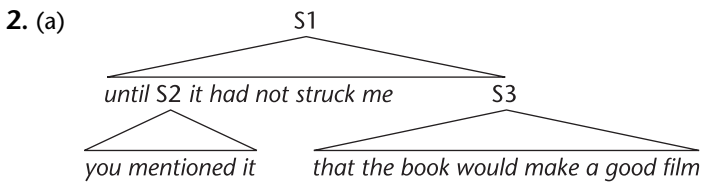

s_{17} [Until s_{27} [you mentioned it] $_{s_{27}}$ it had not struck me s_{37} [that the book would make an excellent film] $_{s_{37}}$] $_{s_{17}}$.

- S1 = main clause.
- S2 = complement to P (*until*).
- S3 = extraposed subject.

(b)

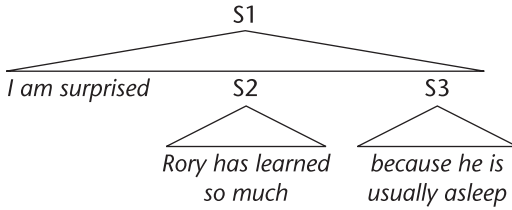

$_{S1}$ [I am surprised $_{S2}$ [Rory has learned so much] $_{S2}$ $_{S3}$ [because he is usually asleep] $_{S3}$] $_{S1}$.

S1 = main clause.

S2 = complement to A (*surprised*).

S3 = VP-adverbial – in S1. Were S3 an adverbial in S2 rather than in S1, S2 would be [Rory has learned so much because he is usually asleep], which is presumably not what was intended!

(c)

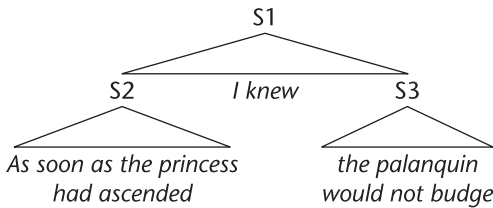

$_{S1}$ [$_{S2}$ [As soon as the princess had ascended] $_{S2}$ I knew $_{S3}$ [the palanquin would not budge] $_{S3}$] $_{S1}$.

S1 = main clause.

S2 = VP-adverbial.

S3 = complement to V (*knew*): direct object.

(d)

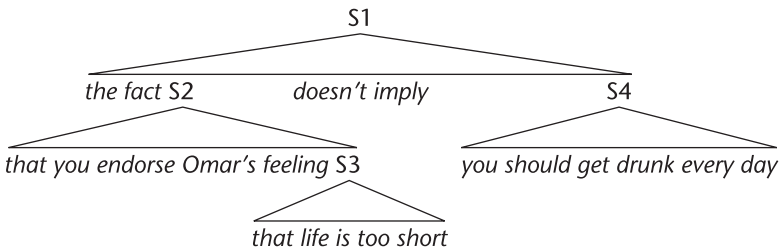

$_{S1}$ [The fact $_{S2}$ [that you endorse Omar's feeling $_{S3}$ [that life is too short] $_{S3}$] $_{S2}$ doesn't imply $_{S4}$ [that you should get drunk every day] $_{S4}$] $_{S1}$.

S1 = main clause.

S2 = complement to N (*fact*).

S3 = complement to N (*feeling*).

S4 = complement to V (*imply*): direct object.

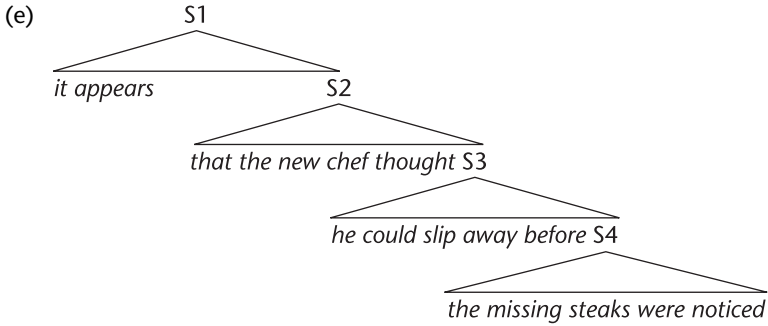

s_1 [It appears s_2 [that the new chef thought s_3 [he could slip away s_4 [before the missing steaks were noticed] s_4] s_3] s_2] s_1 .

S1 = main clause.

S2 = extraposed subject. (S1 has expletive *it* as subject.)

S3 = complement to V (*thought*): direct object.

S4 = Complement to P (*before*).

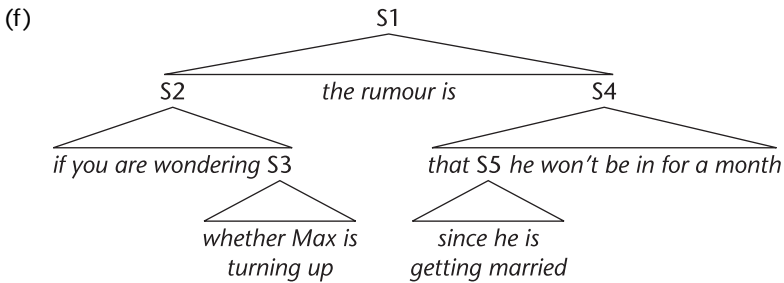

s_1 [s_2 [If you are wondering s_3 [whether Max is turning up] s_3] s_2 the rumour is s_4 [that s_5 [since he's getting married] s_5 he won't be in for a month] s_4] s_1 .

S1 = main clause.

S2 = S-adverbial.

S3 = complement to V (*wondering*): direct object.

S4 = complement to V (*is*): subject-predicative.

S5 = VP-adverbial.

Further exercises

1. Give Abbreviated Clausal Analyses (either by means of trees or by means of brackets) of the following sentences. For each subordinate clause, say what its function is. Look at Exercise 1 above for hints on how to proceed. The first few contain just one subordinate clause. Later examples contain more.

(a) He told me Rory had composed five symphonies at our first meeting.

(b) That anyone would actually like his paintings came as a surprise.

- (c) The big idea here is that we all become rich as quickly as possible.
- (d) The announcement that Frank has resigned will be made after the plane takes off.
- (e) It's well known that Max thinks syntax is good for the brain.
- (f) Before the exhibition opened, the gallery had been certain his paintings would sell extremely well.
- (g) That Savonarola came to power is a direct consequence of Lorenzo's insistence that his sermons were harmless.
- (h) Once it was certain that all the paintings were copies, the exhibition closed.
- (i) The gallery's defence was that they didn't realise they were copies until it was too late.

2. Draw **complete** phrase markers for the following sentences:

- (a) Do you think she's good at syntax?
- (b) This is a proposal that we should support the strike.
- (c) Whether Frank or Bill would be promoted wasn't entirely clear.
- (d) His friends were certain he would not pass the test.
- (e) It is most unfortunate the lecture was cancelled.
- (f) Is it so obvious that she doesn't like the paintings?
- (g) The exhibition closed because the paintings were copies.
- (h) Max was under the impression that Cynthia was glad he had arrived.

3. Consider the following sentences carefully. How do you suggest the function of the subordinate clauses should be described? This possibility has not been mentioned in the chapter, but it is related to a function that has been mentioned.

- (a) They thought it a shame that no-one had crushed that silly monocle.
- (b) She considered it odd that so few had signed the petition.

4. Another possibility not mentioned is illustrated by the following:

- (a) The thought occurred to him that he should have done the washing up.
- (b) The claim was made that syntax is actually good for the brain.
- (c) A rumour is spreading that the Prime Minister has resigned.

In the light of the discussion in this chapter, how *exactly* would you describe the function of the subordinate clause in these? Precisely how does it differ from anything explicitly described in the chapter?

9

Wh-clauses

In Chapter 1, I used replacement by a single word to show that a sequence of words should be analysed as a constituent. As pointed out there, **wh-words** – *who, what, which, whose, why, when, where, how* – can be used in this way. For example, given

[1] Vince is taking Violetta's icon to Athens.

we can replace *Vince* with *who* – as in [2], *Violetta's icon* with *what* – as in [3], *Violetta's* with *which* or *whose* – as in [4], and *to Athens* with *where* – as in [5]:

[2] **Who** is taking Violetta's icon to Athens?

[3] Vince is taking **what** to Athens?

[4] Vince is taking **whose/which** icon to Athens?

[5] Vince is taking Violetta's icon **where**?

Similarly, *by plane* and *secretly* could be replaced by *how*; *in two hours* or *on Tuesday* could be replaced by *when*, and *for restoration* and *so it can be restored* could be replaced by *why*.

Clauses that include a wh-word are called WH-CLAUSES. Wh-words can appear in main clauses and in subordinate clauses. As you can see from [2]–[5], the inclusion of a wh-word in a MAIN clause has the effect of making it into a question – more specifically, a WH-QUESTION. Wh-questions contrast with the *yes/no* questions introduced in Chapter 6. A *yes/no* question asks whether something is the case or not. A wh-question, by contrast, questions some particular constituent – for example, the subject in [2], the direct object in [3], and so on. Hence wh-questions are commonly called **constituent questions**.

I begin by describing **main wh-clauses** – wh-questions, in other words – and then go on to discuss subordinate wh-clauses.

Wh-questions

Compare [3] above, repeated here, with [6]:

[3] Vince is taking what to Athens?

[6] What is Vince taking to Athens?

When the wh-question takes the form in [3] there is nothing special about its analysis. It can be analysed exactly as [1] would be – except that, where [1] has the NP *Violetta's icon*, [3] has an NP consisting of the wh-pronoun *what*.

But the more usual form of that question – and the real interest of wh-clauses in general (indeed the whole point of this chapter) – is illustrated in [6]. It will help you to focus on the differences between [3] and [6] if you first draw a phrase marker for [3]. Assume that *take* is [transitive] and that the PP *to Athens* is therefore a VP-adverbial. Use triangles for NPs and PPs. The phrase marker will be given shortly.

Now, [6] differs from [3] in exactly two ways. Try to identify the two differences.

In both [3] and [6], *what* is understood as the direct object of the V, *take*. The first difference is that, while *what* is actually IN the direct object position in [3], it has moved to the front of the sentence in [6] (i.e. it is fronted). The second difference is that [6], but not [3], exhibits fronting of the tensed auxiliary. So the two differences are: (1) **fronting of the wh-phrase**, (2) **fronting of the tensed auxiliary**.

Write down the sentences that correspond to [4] and [5] as [6] corresponds to [3].

You will have discovered for yourself that in [4] we cannot front just the wh-word. That would give **Whose is Vince taking icon to Athens?* or **Which is Vince taking icon to Athens?* In [4], *which* and *whose* are functioning as determiners. Only the full phrasal category – NP – can be fronted. So it is the full NP containing that wh-determiner (*which icon* or *whose icon*) that is fronted:

[7] {Whose icon}
 {Which icon} is Vince taking to Athens?

[8] Where is Vince taking Violetta's icon?

As for the auxiliary-fronting displayed in [6]–[8], this is exactly the auxiliary-fronting introduced in Chapter 6 for *yes/no* questions. This is fronting to the 'C' position – daughter of S-bar and sister of S. Nothing new there, then. What is new here is the **fronting of the wh-phrase** ('wh-fronting').

As with the movement of an object to the subject position in passive sentences – and, more generally, as with **all movements** – **wh-fronting leaves behind a gap (•) of the appropriate category**. I'll show this in a moment.

But first we have to ask: **Where does the wh-phrase move to?** As mentioned, auxiliary-fronting is fronting to the C position. But if the fronted auxiliary occupies the C position, where does the wh-phrase get fronted to? Clearly, it moves in front of the fronted auxiliary.



That tells us where in the linear order it appears, but it doesn't tell us what structural position it occupies. Is the wh-phrase in the C position *as well as* the fronted auxiliary? Well, in the last chapter, I suggested we don't get auxiliary fronting in *that*- and *whether*-clauses because auxiliaries cannot move to a position already filled by *that/whether* (overtly or otherwise). The fact that a sentence can exhibit both auxiliary-fronting AND wh-fronting suggests that the wh-phrase does not move to the C position that auxiliaries move to. It moves above-and-beyond that C position.



This in turn suggests that it moves into another C position. So we need a **second – higher – C position**.

Just as the already familiar C position introduces S (and is dominated by S-bar – S'), this second C position introduces S'. So it must be dominated by a node that also dominates S'. I shall call this node 'S-double-bar' – S''. So, **this second, higher C position – the landing site for fronted wh-phrases – can be defined as: daughter of S'', sister of S'**:

[10]

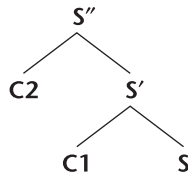

We can now give a representation of [6]. Essentially, it will be like the representation of [3], except for the two frontings and the S' and S'' nodes. So let's remind ourselves explicitly of the points made so far. [6] displays fronting of a wh-NP from the direct object position to the C2 position just defined. The object position following the V must therefore have an NP gap. And the auxiliary carrying tense (in this case, PROG *be*) has been fronted to the familiar C1 position, leaving a gap under the PROG node. Earlier I asked you for a phrase marker for [3]. It is given in [11a]. Compare it with [11b], the phrase marker for [6]:

[11a]

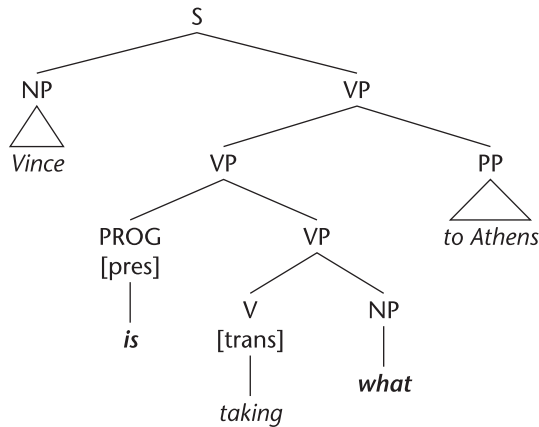

[11b]

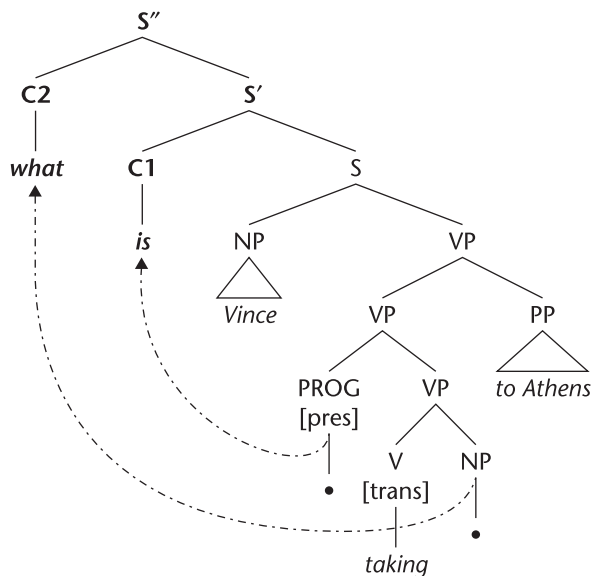

As before, the dotted movement lines are not part of the phrase marker but they do help to show what is going on here. It may help you to get things right if you draw such movements in your own phrase markers.

To summarise, we now have two C positions:

C1 (lower): Daughter of S-bar (S') and sister of S

Filled, in subordinate clauses, by *that*, *whether*, and subordinating conjunctions.
 Filled, in main clauses, by fronted tensed auxiliaries.

C2 (higher): Daughter of S-double-bar (S'') and sister of S-bar (S')

Filled, in both main and subordinate clauses, by fronted wh-expressions.

The major contrast between *that/whether* (and subordinating conjunctions) in C1 and the wh-expressions in C2 is this: *that/whether*, etc. are SIMPLY

complementisers – complementisers and nothing else. They belong to no other syntactic category. They are not fronted from within the clause they introduce and hence have no function *within* that clause. By contrast, wh-expressions in C2 are always fronted from within the clause (the basic S). So, in addition to introducing the clause, they do have a function within that clause and this function is indicated by the position of the gap they leave behind. These fronted wh-expressions in the C2 position must, then, belong to categories capable of having clausal functions: NP, AP, PP, AdvP. The fact that *what* in the C2 position is an NP is captured by there being an NP gap in the clause (the basic S).

Now give the (auxiliary and wh-) fronted versions of the following sentences:

[12a] You are giving which books to Bill?

[12b] Julia will give the pen to who(m)? (two wh-fronting options here)

[12c] He drank that beer how quickly?

[12d] Max is how tall?

These examples show the variety of phrases that can be fronted. In [12a] it is, again, a (direct object) NP. In [12b] we have two options. In very formal styles, the whole PP (*to whom*) can be fronted – leaving a PP gap in S. In my dialect, the wh-pronoun must then be in the objective case (*whom*). In ordinary conversational style, however, just the wh-NP is fronted. This will leave the preposition (and the PP of which it is head) in place in S and there will be just an NP gap. In my dialect, when just the NP is fronted from within the PP, it is not (except in *very* formal style) in the objective case. As regards [12c–d], *how* is a degree adverb and degree adverbs cannot be fronted alone. So, the whole AdvP *how quickly* must be fronted in [12c]. The same goes for the AP *how tall* in [12d].

[13a] **Which books** are you giving • to Bill? (• = NP)

[13b] (i) **Who** will Julia give the pen to • ? (• = NP)

(ii) **To whom** will Julia give the pen • ? (• = PP)

[13c] **How quickly** did he drink that beer • ? (• = AdvP)

[13d] **How tall** is Max • ? (• = AP)

Notice that the verb in [13d] is the intensive verb, copula *be*. Recall that, although the copula is a full verb, it behaves (when tensed) like an auxiliary. In other words, it fronts to the C1 position in questions. This, together with the fact that the whole AP (*how tall*) has to be fronted, means that very little is actually left in the clause (the basic S) itself. In fact, only the subject (*Max*) is left in its original place!

Take time now to draw a phrase marker for each of the five sentences in [13]. Use triangles for NPs, APs, and AdvPs. Leave yourself plenty of room. **Discussion 1**, page 121.

Now look again at [2]–[5] at the beginning of this chapter. [3]–[5] are unfronted questions. These unfronted question forms are commonly called **echo-questions**: they are used to echo – and ask about – something said earlier. They all have normal (non-echo) alternative forms displaying auxiliary- and wh-fronting, namely [6]–[8]. But what about [2], repeated here as [14]?

[14] Who is taking Violetta's icon to Athens?

[2]/[14] is itself the only possible form for that particular question, and it doesn't sound noticeably echoic. [2]/[14] is distinctive because, there, it is the subject constituent that is questioned. The point is that, as subject, the wh-phrase appears at the beginning of the sentence anyway. So, the first question raised by this example is: **should a wh-SUBJECT be represented as actually being in the subject position or represented as fronted to the C2 position?** In other words, does [14] display wh-fronting – just like [6]–[8] – or not?

In research on wh-questions, both answers have been given. For convenience, I shall make the following general assumption: **without exception, all wh-expressions appearing at the front of clauses are to be represented as occupying the higher C2 position.** In moving to the C2 position, however, a subject does not cross any other expression, so the movement makes no difference to the order of words.

The next question is: **does [14] display auxiliary-fronting?** Again, given our assumption that the wh-phrase is up in C2, auxiliary-fronting makes no difference to the order of words. And, again, I'll adopt the strategy of assuming that, **without exception, auxiliary-fronting to C1 occurs in all (non-echo) questions.** (If you are interested in thinking further about this question, look at Further Exercise 3.)

In the light of the above answers (in bold) to our two questions, draw a phrase marker for [14]. Use triangles for the NP and the PP. **Discussion 2**, page 213.

A word now about *where*, *when*, *how*, and *why*. These are often regarded as adverbs and hence as head of AdvP. But, as mentioned at the beginning of the chapter, they don't only stand in place of AdvPs, but also PPs, APs, and even clauses. I have adopted a representation whereby you are not required to give the category of the wh-phrase in the C2 position. But you do still have to decide on the most likely category of the gap it has left behind. In this connection, suggest complete phrase markers for the following. **Discussion 3**, page 213.

[15] How are you? (Possible answer: *well/good*.)

[16] Where did Lisa put it? (Possible answer: *under the bed*.)

To conclude this survey of wh-questions, it is important to notice that a wh-phrase can be fronted, not just from the (immediately following) main clause, but also from a subordinate clause. Here are two examples.

[17a] Whose poem did Stevens suggest would be ideal for the lecture?

[17b] Who did Leopold think Haydn admired?

In each of these, insert a blob (•) exactly where the gap corresponding to the fronted wh-phrase should be. On the basis of that, decide on the function of the wh-expression. Giving Abbreviated Clausal Analyses might help here.

Possible answers to these questions are:

[18a] Stevens suggested S2 [*his own poem* would be ideal for the lecture].

[18b] Leopold thought S2 [Haydn admired *Mozart*].

So, in [17a] there is a subject gap in S2. In [17b] the gap is in the direct object position in S2.

[19a] S1″[Whose poem S1′[did S1[Stevens suggest S2[• would be ideal for the lecture]]]]?

[19b] S1″[Who S1′[did S1[Leopold think S2[Haydn admired •]]]]?

Subordinate wh-clauses

The big idea in this chapter is that wh-clauses are introduced by a fronted wh-phrase occupying the C2 position (daughter of S″, sister of S′) and this corresponds to a gap of the appropriate category in the position from which it was fronted.

This goes for all wh-clauses, whether main or subordinate. The one structural difference between a main and a subordinate wh-clause is that only main wh-clauses display auxiliary-fronting as well as wh-fronting. **Auxiliary-fronting occurs only in main clauses.** In the rest of this chapter, I deal with two types of subordinate wh-clause, interrogative clauses and relative clauses.

Subordinate wh-interrogative clauses

The distinction between MAIN wh-interrogative (WH-QUESTIONS) and SUBORDINATE wh-interrogative clauses is exactly the same as that between main and subordinate *yes/no* interrogatives. See Chapter 8, pages 175–6.

The following all contain subordinate wh-interrogative clauses:

[20] Martha enquired why he wore it on his foot.

[21] How he would fare on the trapeze preoccupied him.

[22] It is my affair what I wear at night.

[23] Marcel wasn't certain who he sent the flowers to.

[24] The immediate problem was where they could hide those fritters.

[25] The little matter of who is going to pay for all this has yet to be resolved.

The subordinate wh-clauses in each of these sentences have functions familiar to you from previous chapters. First, identify the subordinate clauses and, for each, state what its function is. Second, identify the position of the gap and (relatedly) state the function of the wh-phrase.

- [20a] [why [he wore it on his foot •]] – dO of [trans] V, *enquire*.
Why: VP-adverbial.
- [21a] [how [he would fare on the trapeze •]] – subject.
How: VP-adverbial.
- [22a] [what [I wear • at night]] – extraposed subject.
What: dO of trans V, *wear*.
- [23a] [who [he sent the flowers to •]] – complement of A (*certain*) in AP.
Who: complement of P (*to*) in PP.
- [24a] [where [they could hide those fritters •]] – sP of intensive V, *was*.
Where: oP of complex V, *hide*.
- [25a] [who [• is going to pay for all this]] – complement of P (*of*) in PP.
Who: subject.

As mentioned, these subordinate wh-clauses have exactly the same structure as the wh-questions considered in the last section: the fronted wh-phrase occupies the higher C2 position. Since these interrogative clauses are subordinate and therefore don't display auxiliary fronting, the lower C1 position will be empty. Here is the phrase marker for [23]:

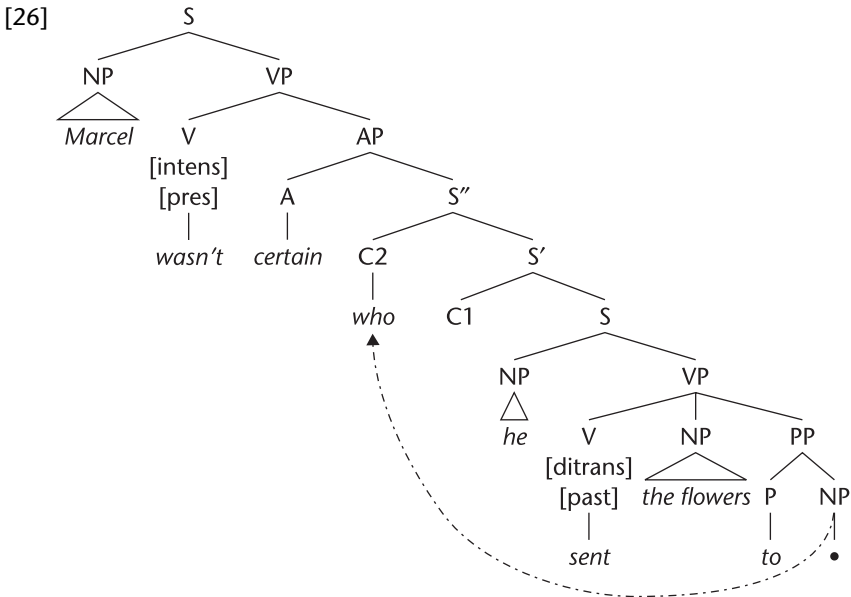

Phrase markers for [20] and [22] are given in Discussion 4, page 214.

Relative clauses

It would be understandable if you had formed the impression that all wh-clauses are interrogative clauses. Not so. **Relative clauses are non-interrogative wh-clauses.** In contrast to interrogative clauses (which can be main or subordinate), relative clauses are, by their nature, subordinate. This is because **relative clauses function as modifiers.** They can modify a range of categories, but I focus here just on their modifying function within NP.

Have a good look at the following NPs, all of which contain a wh-clause – a relative clause. Identify (a) the relative clause in each and (b) the function of the wh-phrase within that clause.

- [27] The trampolines which they had bought.
- [28] The fool who lent you a fiver.
- [29] A friend whose house we borrowed.
- [30] The usher who I showed my ticket to.
- [31] The place where we had that picnic.

When wh-forms occur in a relative clause, they are traditionally referred to as **relative pronouns**, in contrast to their occurrence in interrogative clauses when they are traditionally referred to as interrogative pronouns. These relative clauses have exactly the same structure as the subordinate wh-interrogative clauses discussed in the previous sections. They display wh-fronting into the higher C2 position, from within the clause:

- [27a] [which [they had bought •]] (*which* = dO)
- [28a] [who [• lent you a fiver]] (*who* = subject)
- [29a] [whose house [we borrowed •]] (*whose house* = dO)
- [30a] [who [I showed my ticket to •]] (*who* = complement to P in PP)
- [31a] [where [we had that picnic •]] (*where* = VP-adverbial)

What concerns us here, then, is not their (by now familiar) internal structure but how they fit into the structure of sentences – more specifically, how they fit into the structure of the NPs in which they function as modifiers. In this connection, **compare relative clauses with noun complement (*that*-) clauses**, introduced in the last chapter. Among the following NPs, the [a] examples contain noun complement clauses, while the [b] examples contain relative clauses.

- [32a] The conclusion [that Mars was inhabited].
- [32b] The conclusion [which Gomez disputes].
- [33a] The thought [that he should have done the washing up].
- [33b] The thought [which occurred to him].

[34a] The claim [that syntax is good for the brain].

[34b] The claim [with which he ended his lecture].

The contrast here is that THE NOUN-COMPLEMENT CLAUSES in [a] give us central information about the head noun; it tells us the ACTUAL CONTENT of the conclusion, thought, or claim (what exactly the conclusion etc. was), while THE RELATIVE CLAUSES tell something else about it, something more peripheral. From [32b], for example, we don't know what nature of conclusion Gomez disputes; we only know that it is the one he disputes.

Noun 'COMPLEMENT' clauses are so-called because the clause relates to the Noun exactly as a clause complementing a Verb relates to that Verb. Compare the [a] NPs above with the [bracketed] VPs in the following sentences, in which the clauses function as direct object of the Verbs:

[35] He [concluded *that Mars was inhabited*].

[36] He [thought *he should have done the washing up*].

[37] Surely he couldn't [claim *that syntax is good for the brain*].

As complements, NOUN-COMPLEMENT CLAUSES are sisters to the head N within NOM, just as verb complements are sisters to V within VP. Here, then, is a reminder of how NPs with complement clauses are represented:

[38] NP WITH NOUN-COMPLEMENT CLAUSE (reminder):

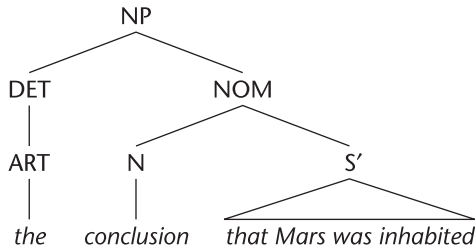

Noun-complement clauses, remember, are introduced by the lower, C1 complementiser *that*, dominated by S-bar (S'). Since nothing has been fronted from within it, the clause itself is complete (no gaps). By contrast, the relative clause is a *wh*-clause: the *wh*-phrase is in the higher, C2 position, dominated by S-double-bar (S''). It has been fronted, leaving a gap.

The points just made serve to distinguish noun-complement clauses and relative clauses quite clearly as regards their internal structure. But we still haven't answered the question of how relative clauses fit into the structure of NPs. Well, relative clauses clearly don't relate to the head noun as noun-complement clauses do. They are NOT complement clauses; so they cannot be represented as sisters of the head N. I have anyway mentioned that relative clauses give more peripheral information about the head N. To reflect this, RELATIVE CLAUSES are represented, not as sisters-of-N, but as sisters-of-NOM within a higher NOM:

[39] NP WITH RELATIVE CLAUSE:

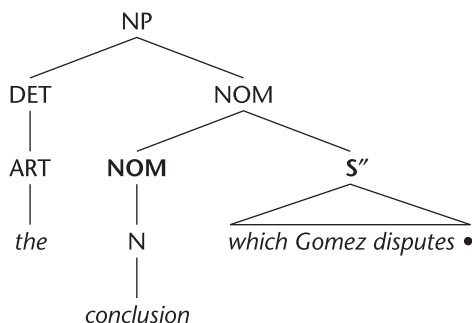

So, in addition to differences in their internal structure, noun-complement clauses and relative clauses are distinguished by their position in the structure of NPs: **noun-complement clauses are sisters-of-N but relative clauses are sisters-of-NOM**. Relative clauses are **MODIFIERS**, not complements. If you tackled the Appendix of Chapter 7, the distinction between modifier and complement within NP will be already familiar to you, as will the following discussion.

Evidence supporting this distinction between sister-of-N (complement) and sister-of-NOM (modifier) comes from the pro-form *one*. You will need to read what follows carefully. ***One* is a pro-NOM**: it stands in place of NOMs. It cannot replace an N by itself unless N is the *only* constituent of a NOM. So we must interpret *one* as replacing, not the noun itself, but the NOM that dominates it. Now, since a noun-complement clause is the sister of the N itself, a NOM is created **ONLY** by the combination of N plus complement clause together. So we predict that the pro-NOM *one* should **NOT** be able to replace just the N in the context of a following complement clause. By contrast, since a relative clause is sister-of-NOM, we predict that, even if that NOM contains nothing other than an N, it should still be replaceable by the pro-NOM *one*. In short, **the prediction is that [*one* + complement clause] will be ungrammatical, but [*one* + relative clause] will be fine**. These predictions are fully borne out:

- [40a] *The one that Mars is inhabited.
- [40b] The one which Gomez disputes.
- [41a] *The one that he should have done the washing up.
- [41b] The one which occurred to him.
- [42a] *The one that syntax is good for the brain.
- [42b] The one with which he ended his lecture.
- [43a] *I accept all the conclusions, including the one that Mars is inhabited.
- [43b] I accept all the conclusions, including the one which Gomez disputes.

Notice that, if an N-complement clause is sister-of-N in parallel with a V-complement (sister-of-V), then the structural position of a relative clause

(sister-of-NOM, daughter-of-NOM) parallels the structural position of adjunct adverbials (sister-of-VP, daughter-of-VP). In other words, **you can think of relative clauses as ADJUNCTS in the structure of NP.** (For more detail on the distinction between modifiers and complements in NP, see the Appendix of Chapter 7.)

Now give a complete phrase marker for the NP in [34b] above, *the claim with which he ended his lecture*. **Discussion 5**, page 215.

■ Omission of the wh-phrase

In many cases, the wh-form in a relative clause can be omitted (by ellipsis). Look again at [27]–[31] above and decide for yourself in which of those it can be ellipted. Under what two different circumstances can it NOT be ellipted? Consider also [32b]–[34b] above.

[44] The trampolines \wedge they had bought (were dangerous).

[45] *The fool \wedge lent you a fiver (also lent me a tenner).

[46] *A friend \wedge house we borrowed (needs it now).

[47] The usher \wedge I showed my ticket to (has had it framed).

[48] The place \wedge we had that picnic (is too far away now).

See also: *The conclusion \wedge Gomez disputes (was indeed absurd)*, **The thought \wedge occurred to him (cheered him up)*, **The claim with \wedge he ended his lecture (surprised them)* vs. *The claim \wedge he ended his lecture with (surprised them)*.

The fronted wh-form cannot be ellipted (1) when it functions as subject ([45] and [33b]) or (2) when other material has been fronted with it ([46] and [34b]). Generally, ellipsis is possible only when it does not interfere with the interpretation or with ease of comprehension. For example, fronted wh-subjects – e.g. in [45] and [33b] – cannot be ellipted because this would create the misleading first impression that *lent/occurred* are the MAIN verbs, whereas in fact each is the verb of a SUBORDINATE clause. In the absence of the wh-form, the mistake would only become apparent when the real main verb (*is, cheered*) makes its appearance.

■ That again

Now look at the following NPs:

[49] The fool *that* lent you a fiver.

[50] The thought *that* occurred to him.

[51] The trampolines *that* they had bought.

[52] The conclusion *that* Gomez disputes.

In these NPs, the clause is introduced by *that*. What should we make of these? Are they relative (wh-) clauses or noun-complement (*that*) clauses? Try to decide.

Relative clauses always include a gap. In genuine *that*-clauses, by contrast, *that* has not been fronted, so the clause itself (the basic S) is complete. Now, the clauses in [49]–[52] are clearly NOT complete: [*• lent you a fiver*], [*• occurred to him*], [*they had bought •*], [*Gomez disputes •*]. This indicates that, despite the presence of *that* rather than a wh-form, these are indeed relative clauses, not *that*-clauses. Compare the relative clauses in the following [a] examples with the noun-complement clauses in the [b] examples:

[53a] This is a proposal *that we should support*.

[53b] This is a proposal *that we should support the strike*.

[54a] *The news that she had given John* shocked them all.

[54b] *The news that she had given John a good kick* shocked them all.

One traditional approach to *that* in relative clauses is simply to say that, in this kind of relative clause, wh-forms can be replaced by *that*. In other words, *that* is regarded as an alternative form of the relative pronoun, and the NP [*the conclusion that Gomez disputes*] will be represented exactly like [*the conclusion which Gomez disputes*] – see Discussion 5 – but with *that* in C2 instead of *which*. This approach has the merit of simplicity so, for convenience, I shall adopt it here. In the light of this, draw contrasting phrase markers for the italicised NPs in [53a] and [53b]. **Discussion 6**, pages 215–6.

An alternative analysis would insist that *that* is the C1 complementiser and is permitted to make an overt appearance in (the C1 position of) a relative clause only when the wh-phrase in C2 has been ellipted.

Restrictive vs. non-restrictive

All the relative clauses considered so far are RESTRICTIVE relative clauses. The other kind of relative clause is described as NON-RESTRICTIVE (OR APPOSITIVE). The internal structure of these two kinds of clause is identical. **The difference between restrictives and non-restrictives lies in the way they relate to the head noun within the overall NP.** In the following sentences, all the subject NPs contain relative clauses. Those in the [a]s are restrictive, those in the [b]s are non-restrictive.

[55a] The books which John has consulted are out of date.

[55b] The books, which John has consulted, are out of date.

[56a] The dogs which have rabies are dangerous.

[56b] The dogs, which have rabies, are dangerous.

As you can see, the non-restrictives are distinguished in writing from restrictives by being marked off by commas. The difference between them, though, does not consist in the presence vs. absence of commas, so we need to ask what the commas in the [b] examples are telling us about the relation between the main clause and the relative clause. This can be brought out by showing that certain relative clauses can **ONLY** be used non-restrictively in certain contexts:

[57a] *The dogs which are mammals need treatment.

[57b] The dogs, which are mammals, need treatment.

[58a] *Triangles which have three sides are fascinating.

[58b] Triangles, which have three sides, are fascinating.

The oddity of the (restrictive) [a] examples is due to the fact that **RESTRICTIVE relative clauses specify more exactly which of the things picked out by the head noun are being mentioned.** In [55a], for example, the relative clause tells us *which* books are out of date. It is described as ‘restrictive’ because it serves to restrict the set of books to a **SUB-SET** of books, namely those consulted by John. It is that more restricted set of books that are said, in [55a], to be out of date. But the relative clauses in [57] and [58] cannot be used to pick out a more highly specified set of dogs or triangles, because all dogs are mammals – and all triangles three-sided – anyway. So, you cannot (as in [58a]) use *which have three sides* to pick out a **SUB-SET** of triangles. Nevertheless, there is nothing to stop us, **PARENTHETICALLY**, adding the extra information that triangles have three sides or that dogs are mammals. This is precisely what the non-restrictive clause allows us to do. **NON-RESTRICTIVE relative clauses serve to add extra – parenthetical – information, without restricting the set of things (triangles, dogs, books, etc.) being mentioned.**

In the light of this, compare [56a] and [56b]. [56a], with the restrictive clause, does not imply that all the relevant dogs are dangerous; it is only the rabid ones that are said to be dangerous. But [56b], with the non-restrictive clause, does imply that all the relevant dogs are dangerous – and it adds the **FURTHER INFORMATION** that they also have rabies.

The big difference, then, is that [56a] makes just ONE statement – a statement about the rabid dogs to the effect that they dangerous – but [56b] makes TWO separate statements: (1) that the dogs are dangerous, (2) that the dogs have rabies.

The representation of NPs containing a restrictive relative clause has already been given. As a reminder, that in [56a] is given here as [59]:

[59] NP with **RESTRICTIVE** relative clause (reminder):

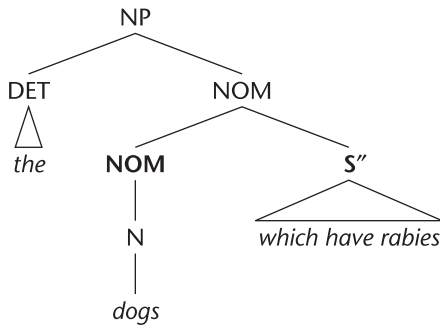

Notice that in [59], the determiner is the sister of a constituent that **INCLUDES** the relative clause – namely, the NOM [*dogs which have rabies*]. This means that the restrictive clause falls **WITHIN THE SCOPE** of the determining function of the definite article (in other words, *the* is determining, not *dogs*, but *dogs which have rabies*). So, in [56a], there is no NP of the form *the dogs* that is the subject of the VP *are dangerous*. This seems right: we have agreed that, in [56a], no statement is made about the dogs as such, only about a sub-set of them, the rabid dogs.

What about [56b] – with the non-restrictive clause? Well, we agreed (I hope) that in [56b] two statements are made, both of them about the dogs. Here, the subject of the main clause predicate VP (*are dangerous*) is indeed **THE DOGS**. So, the non-restrictive clause must be seen as a modifier, not just of *dogs*, but of *the dogs*, which is an NP in its own right. **As the modifier of a complete NP, the non-restrictive relative clause is represented as the sister of that NP within a higher NP**, as in [60]:

[60] NP with **NON-RESTRICTIVE** relative clause:

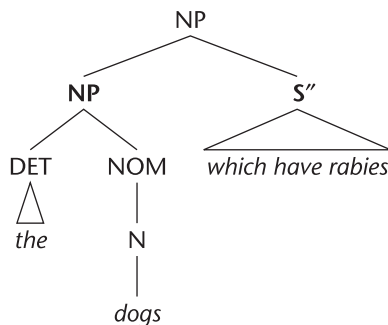

There are a couple of further differences between restrictive and non-restrictive relative clauses: (1) in contrast with restrictives, the wh-phrase in non-restrictives cannot be ellipted; (2) the wh-phrase cannot be replaced by *that*.

In conclusion, it is worth stepping back briefly to review the kinds of clauses that can appear within NP. There are three: (a) noun-complement clauses,

(b) restrictive relative clauses, and (c) non-restrictive relative clauses. Restrictive relatives are more peripheral than noun-complement clauses, and non-restrictive relatives more peripheral still. This three-way distinction corresponds with the three levels of NP structure: (a) the lexical (lowest) level, N itself, (b) the intermediate level, NOM, and (c) the phrasal (highest) level, the NP itself.

Noun-complement clause: sister of N (within NOM).

Restrictive relative clause: sister of NOM (within NOM).

Non-restrictive relative clause: sister of NP (within NP).

Discussion of in-text exercises

(I show the movements only in the first example.)

1. (a)

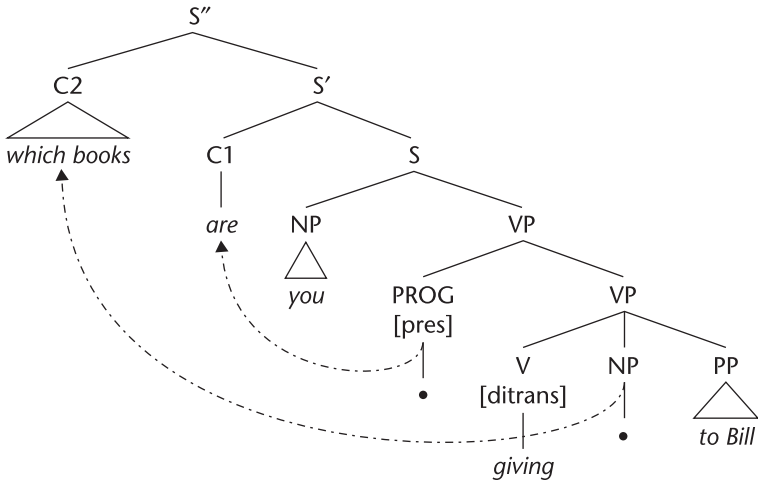

(b) (i)

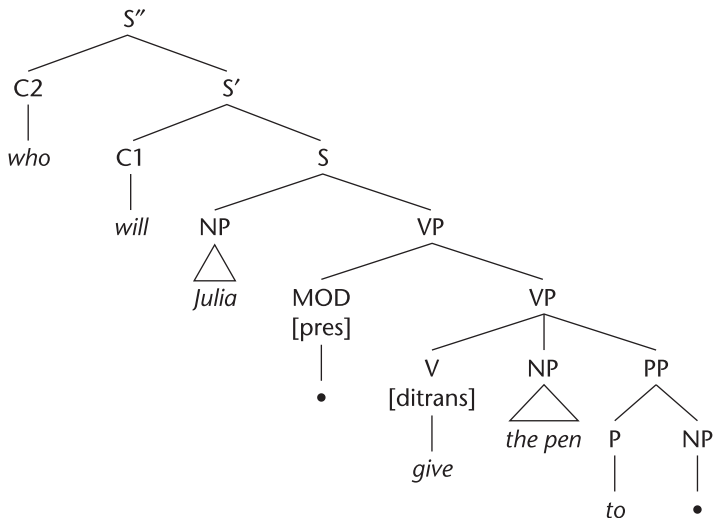

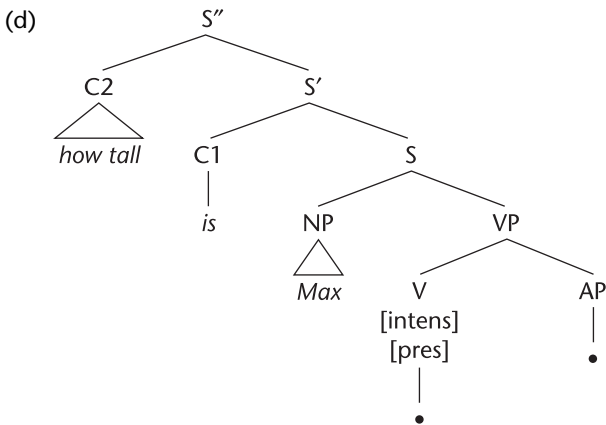
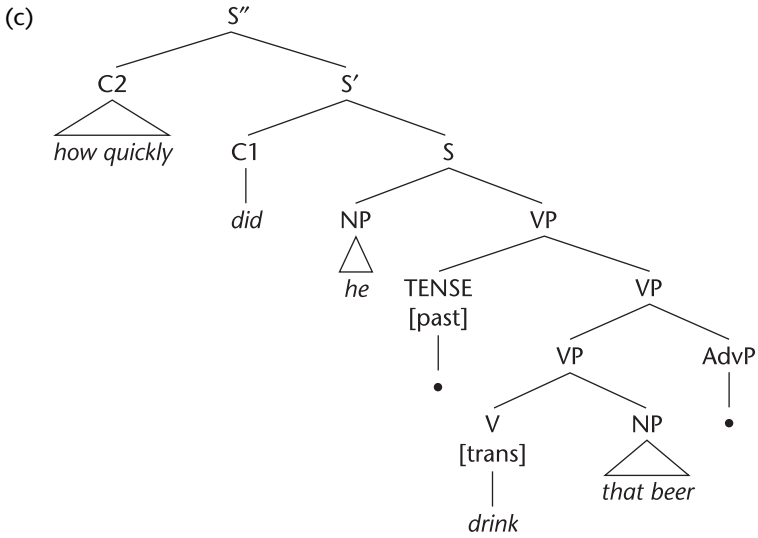
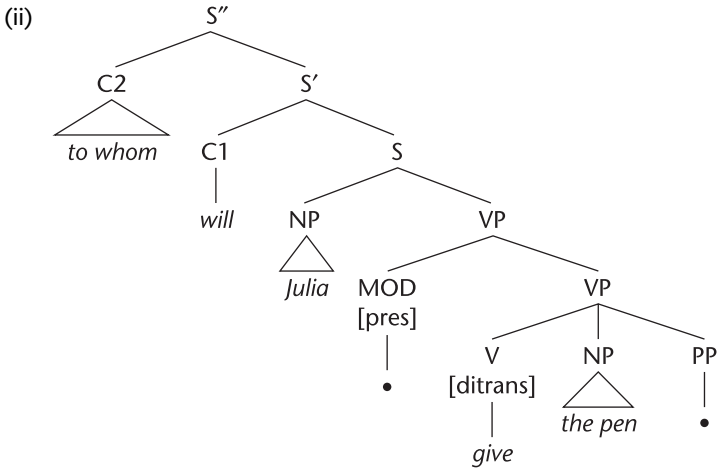

2.

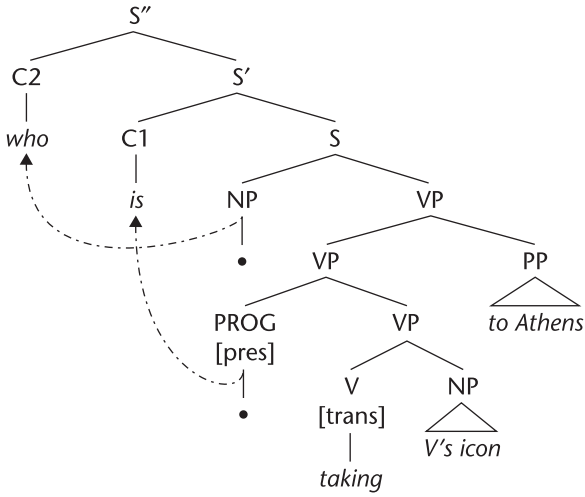

3. (a)

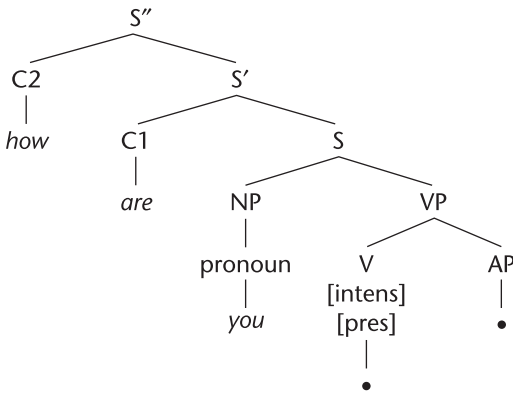

Since most answers to the question are APs (*well, good, awful, too busy*), I have assumed that *how* corresponds to an AP gap. But a PP is possible (*in good spirits*).

(b)

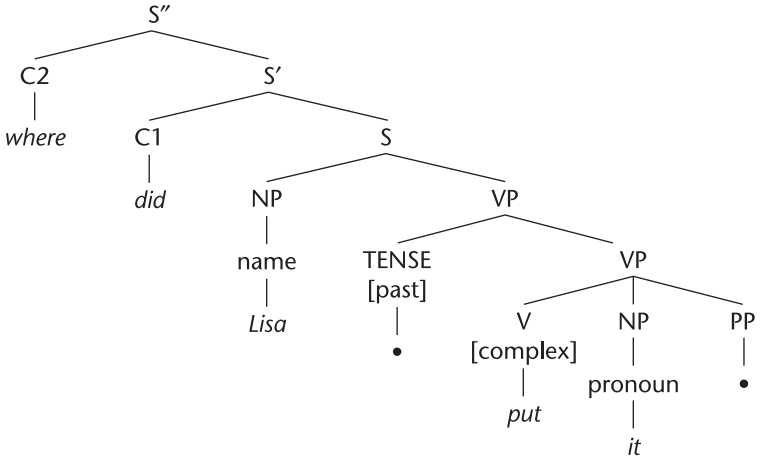

As indicated, *put* is complex transitive, generally taking an NP and a PP. So I have represented *where* as corresponding to a PP gap.

4. [20]

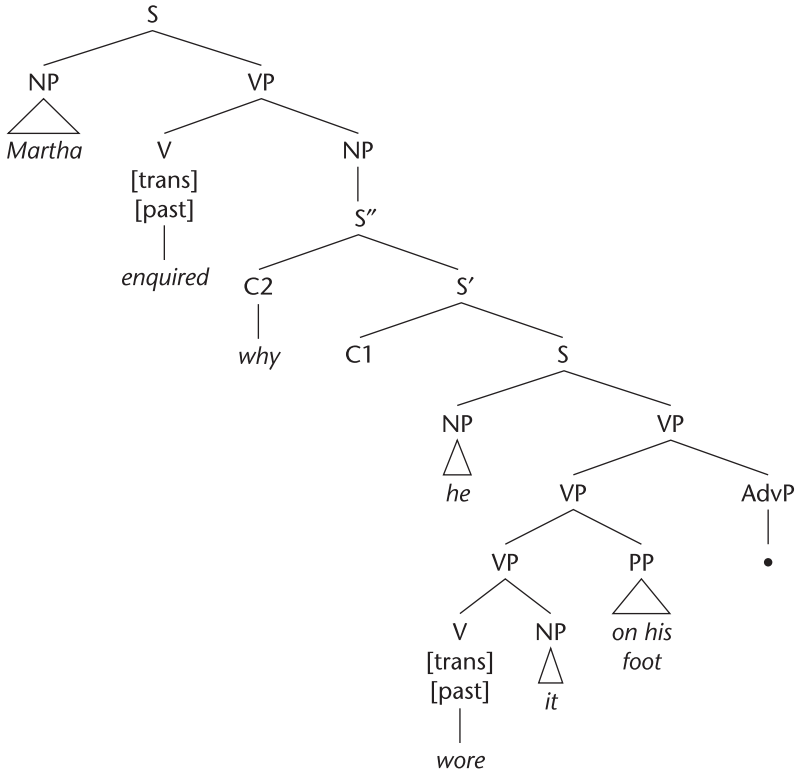

[22]

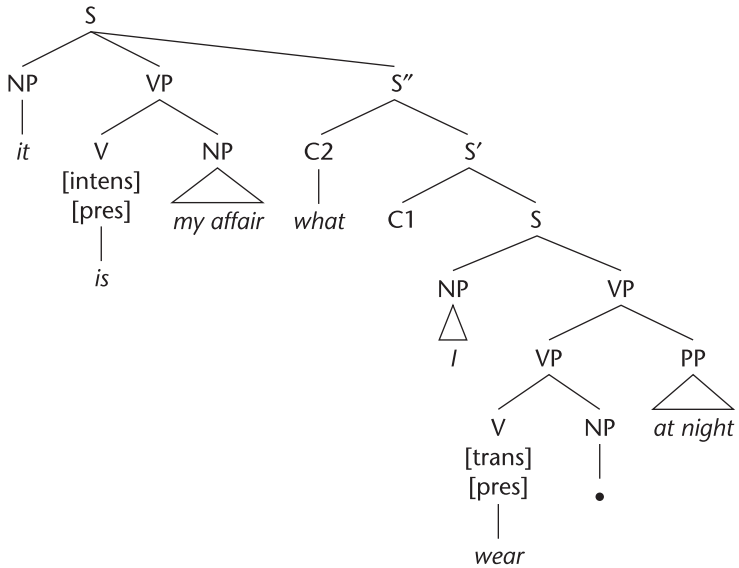

5.

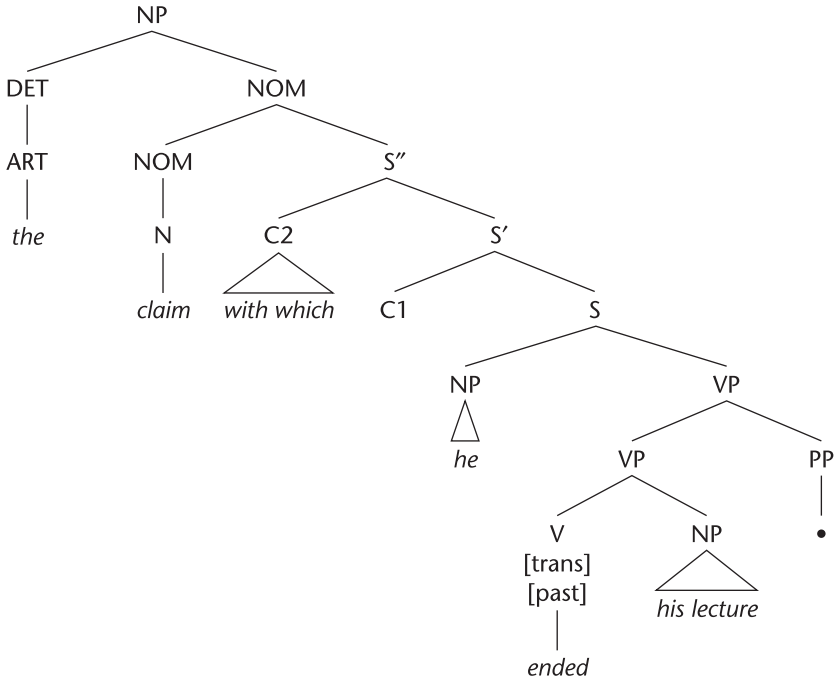

6. [53a]

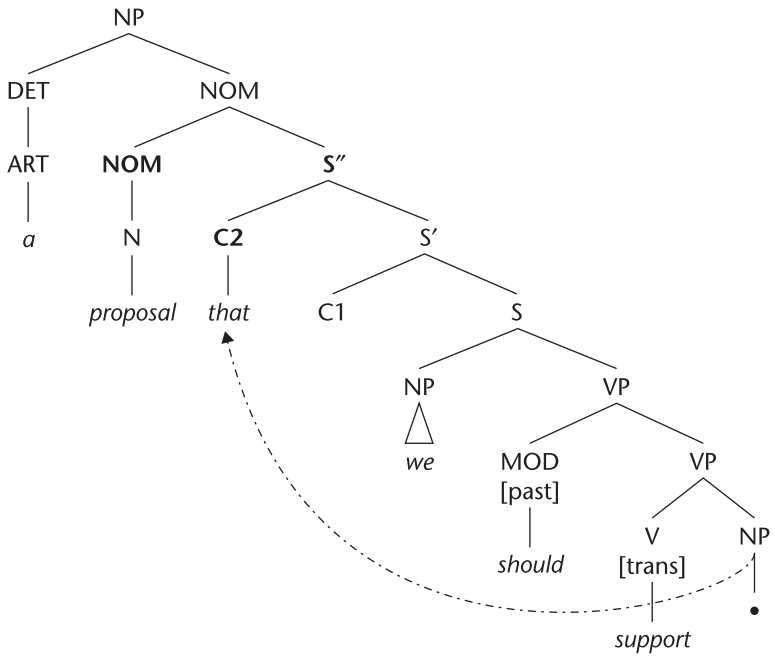

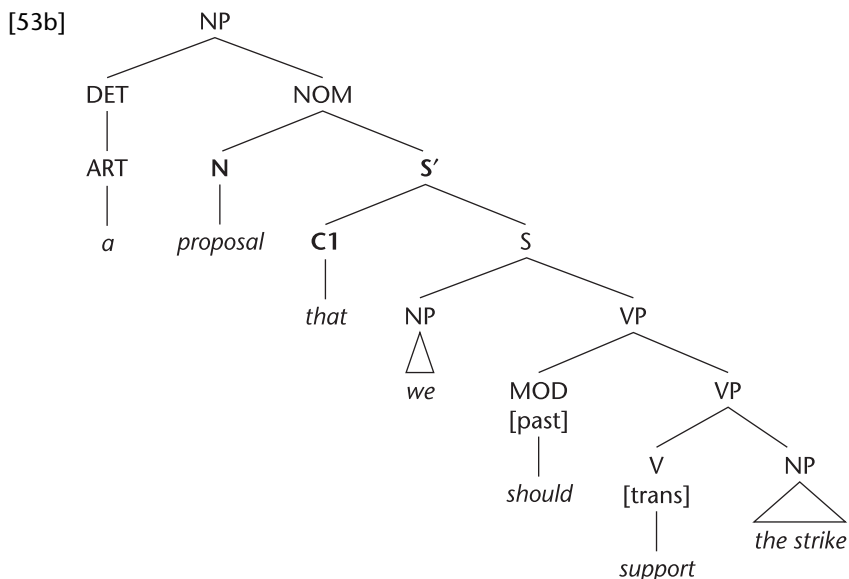

Exercises

1. Replace the italicised constituent in the following sentences by an appropriate wh-word, and give the question that results from wh- and auxiliary fronting.

- We shall feed the cat *smoked salmon* today.
- He got to London *by hitch-hiking*.
- The man at the front* was laughing.
- A recidivist is *a persistent offender*.
- He can get *extremely arrogant*.
- Lola showed up in *dark glasses*.
- Tessa pocketed the fried egg *because it was too greasy to eat*.
- He cleaned his keyboard with *his sister's toothbrush*.
- Mary suggested *Lomax should be fired*.

2. For each of the following, embed the (i) clause as a relative clause in an NP of the (ii) clause, giving the sentence that results.

Example: (i) and (ii) would yield (iii):

- You mislaid some Stilton last Christmas.
- The Stilton has just strolled into the bedroom.
- The Stilton which you mislaid last Christmas has just strolled into the bedroom.

- (a) (i) I had been trying to extract a cork.
 (ii) The cork suddenly launched itself at Widmerpool.
- (b) (i) Some officer issued this ridiculous order.
 (ii) I am going to override the officer.
- (c) (i) Crusoe said he had been marooned on an island.
 (ii) The island has never been discovered.
- (d) (i) I had borrowed a passenger's toothbrush.
 (ii) The passenger was seething.

3. For each of the following sentences, decide whether the relative clause that follows it could be (a) only restrictive, (b) only non-restrictive, or (c) either, when included in the italicised NP. Then draw the phrase marker for sentence (a) including the relative clauses. (Use triangles for PP and *the penal code*.)

- (a) *Napoleon* died in exile.
 who inaugurated the penal code.
- (b) I haven't owned *a pig* in my life.
 which could fly.
- (c) I prefer (i) *cats* to (ii) *cats*.
 (i) which have stripes.
 (ii) which have spots.
- (d) *The acrobat* ate ravenously.
 who I had just hired.
- (e) *The source of the Nile* was discovered by Speke.
 which I have just visited.

4. Give Abbreviated Clausal Analyses of the following sentences. For each subordinate clause, state what type of clause it is (*that*-clause, interrogative, or relative (restrictive or non-restrictive)) and give its function.

Example: *The books from the library that John has consulted are out of date.*

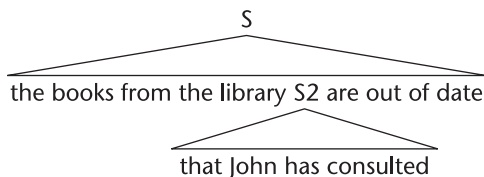

S2: restrictive relative clause – modifier of NOM (*books from the library*).

- (a) I never understood how the theory worked until I read your book.
- (b) Why Max didn't answer the accusation that he had cheated is a mystery.
- (c) Why Max didn't answer the poor man that he had cheated is a mystery.
- (d) The acrobat, who is injured, is insistent that the high-wire is strengthened if it is used again.

■ Discussion of exercises

1. (a) What shall we feed the cat today?
 (b) How did he get to London?
 (c) Who was laughing?
 (d) What is a recidivist?
 (e) How arrogant can he get?
 (f) What did Lola show up in?
 (g) Why did Tessa pocket the fried egg?
 (h) Whose toothbrush did he clean his keyboard with? (With whose toothbrush did he clean his keyboard?)
 (i) Who did Mary suggest should be fired?

2. (a) The cork which/that I had been trying to extract suddenly launched itself at Widmerpool.
 (b) I am going to override the officer who issued this ridiculous order.
 (c) The island on which Crusoe said he had been marooned has never been discovered. (Or: The island which Crusoe said he had been marooned on . . .)
 (d) The passenger whose toothbrush I had borrowed was seething.

3. (a) Non-restrictive only. Since *Napoleon*, a name, already uniquely identifies a particular individual, it is impossible to restrict the range of reference of this NP further.
 (b) Restrictive only. If we included the clause as non-restrictive, the whole sentence would be equivalent to *I haven't owned a pig and a pig could fly* which hardly makes sense. In the context of this (negative) sentence, the expression *a pig* does not pick out any particular pig. Only if it did pick out a particular pig could we add the further information that it could fly.
 (c) (i) and (ii) must both be restrictive. If either or both of them were non-restrictive, the resulting sentence would be contradictory, as indeed (c) is without the relative clauses.
 (d) Both restrictive and non-restrictive are possible here.
 (e) Non-restrictive only. *The source of the Nile* already uniquely identifies a fully specified thing.

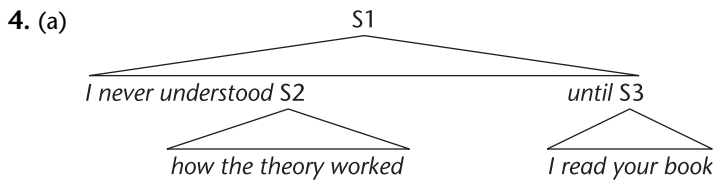
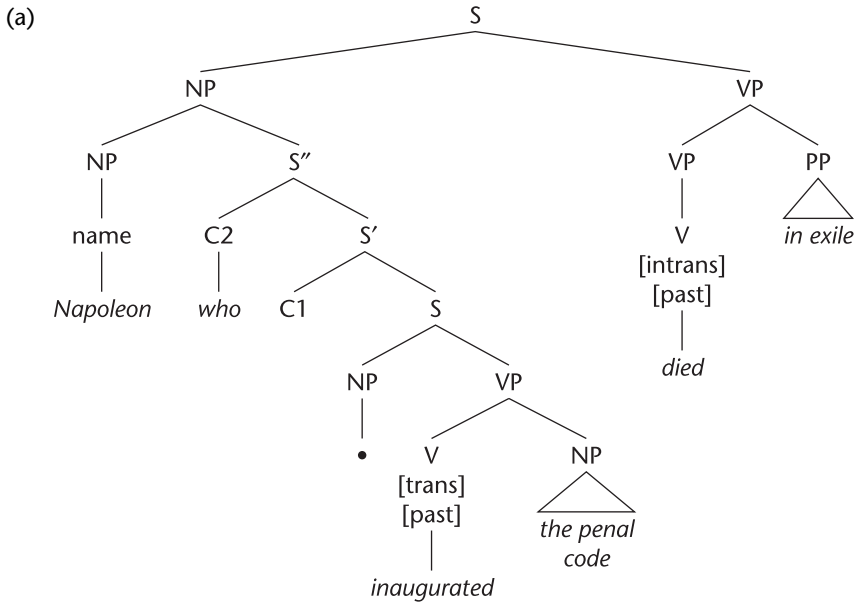

S1: Main clause.

S2: Wh-interrogative clause: Complement (dO) of V (*understood*).

S3: Complement of P (*until*).

(b) and (c)

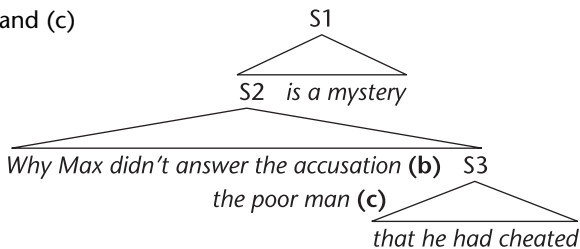

S1: Main clause.

S2: Wh-interrogative clause: subject of S1.

(b) S3: *That*-clause: complement to noun (*accusation*). *Cheat* is [intrans] here.

(c) S3: Restrictive relative clause: modifier of NOM (*poor man*). *Cheat* is [trans] here, with a gap in dO position.

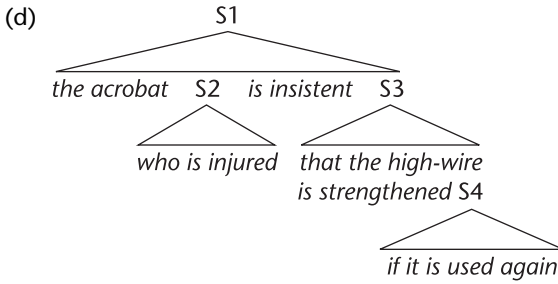

S1: Main clause.

S2: Non-restrictive relative clause: modifier of NP (*the acrobat*).

S3: *That*-clause: complement to A (*insistent*).

S4: Adverbial clause.

Further exercises

Questions and interrogatives

1. Draw complete phrase markers for the following.

Set I

- (1) Which salami shall we buy?
- (2) Where have I put my glasses?
- (3) Where did they have the picnic?
- (4) Who's been eating my porridge?
- (5) How much food should I give the dog?
- (6) Which of these books does John recommend?
- (7) Do you know what they ate?
- (8) What do you think they put in that soup?

(In (8), notice, *what* has been fronted from a subordinate clause.)

Set II

- (9a) I don't know who he found an amusing companion.
- (9b) I don't know whether he found an amusing companion.
- (10a) Who did Granny say should play?
- (10b) Who did Granny say I should play?
- (11a) Who is a phonologist?
- (11b) What is a phonologist?

Set III

(These need care.)

- (12) Which exam was it certain Julia would pass?
- (13) Who has been sacked?
- (14) Who were they given to?
- (15) Who did John ask which films they had seen?
(Note that in (15) there are two *wh*-frontings.)

- 2. (a) (1) and (2) have different phrase markers (you could give them, if you want practice). What is the big difference between the two questions? Another way of asking this is: Why is *who* not fronted in (1) as it is in (2)?
 - (1) Did you discover who was giving the lecture?
 - (2) Who did you discover was giving the lecture?
- (b) In (2), we could replace *discover* with *say*, *know*, *hope*, and *assume*, but in (1) we can only replace it with *say* and *know*, not *hope* or *assume*. Try and explain this difference between *discover/say/know* and *hope/assume*.

- 3. In connection with *wh*-subject questions such as that in (2)

- (1) Vince is taking the icon to Athens
- (2) Who is taking the icon to Athens?

I assumed that fronting to C1 (auxiliary fronting) always occurs in *wh*-questions, even though it doesn't change the order of words. But was that the right decision? And how could we know? Well, here is one small piece of evidence. If we change *is taking* to *took* in (1), this gives (3). Now, the *wh*-question that corresponds to (3) is (4), not (5).

- (3) Vince took the icon to Athens
- (4) Who took the icon to Athens?
- (5) *Who did take the icon to Athens?

(5) is only grammatical if *did* is an instance of EMPHATIC *do*. How does this bear on the question of whether fronting to C1 occurs in *wh*-subject questions? Does it confirm or disconfirm the analysis adopted in the chapter?

■ Relative clauses and other matters

- 4. Draw complete phrase markers for the following NPs:

- (1) The chef who I fired.
- (2) The woman in whose care we left you.
- (3) The spy who loved me.
- (4) The place where we had the picnic.
- (5) The reason why it spits.
- (6) A style he thought appropriate.

5. Draw complete phrase markers for the following sentences:

- (1a) The man they cheated is furious.
- (1b) The reason they cheated is clear.
- (2a) I have an idea we should think about.
- (2b) I have an idea we should think about exams.
- (3a) The fact that I communicated with Mona is crucial.
- (3b) The fact that I communicated to Mona is crucial.

6. I have discussed only relative clauses appearing in the structure of NPs. A difference between restrictive and non-restrictive relatives is that, while the former only ever function as modifiers within NP, non-restrictives can modify a range of categories. Give the constituents (and their categories) that the non-restrictive relative clauses are modifying in (1)–(3). Then draw a complete phrase marker for (1).

- (1) He was very rude, which I never am.
- (2) Lomax argued for trampolines, which surprised me.
- (3) Hedda got out with the aid of a trampoline, which seemed a sensible way of doing it.

7. (1)–(2) below illustrate a function of wh-clauses not explicitly discussed in this chapter. Decide on their function and then draw a phrase marker for each sentence.

- (1) Lola merely smiled when I proposed marriage.
- (2) They pitched the tent where they always pitch it.

8. Give Abbreviated Clausal Analyses of the following sentences. Indicate the gaps. For each subordinate clause, state what type of clause it is (*that*-clause, *yes/no* interrogative, *wh*-interrogative, or relative (restrictive or non-restrictive)) and give its function. For all *wh*-clauses, identify and give the function of the *wh*-phrase that introduces it (whether that *wh*-phrase is overt or not). For examples of what I'm asking for here, see the answers to Exercise 5 above.

- (1) The man who broke the bank at Monte Carlo is now my butler.
- (2) Which animals Bertram feeds is his decision.
- (3) We should find out who the visitors to the restaurant were.
- (4) It's hardly surprising you can't get your teeth into the fritters Jim cooks.
- (5) When we are going for a picnic is a question that he is always asking.
- (6) I'm nervous that the hoops that have been alight will topple over when the hippos jump through them.
- (7) Watson, who was never very quick, is wondering if Holmes's theory that the governess is the guilty party can possibly be right.

- (8) Do you know how many players have guessed what instrument Miss Scarlet was murdered with?
 - (9) None of the people who went to Narnia when it was first created ever explained how they got there.
 - (10) Marcel often wondered whether Gilberte ever asked Swann what the boy she'd seen in the garden was called.
9. The following are ambiguous. For each, draw a phrase marker for each interpretation. Abbreviate them as far as possible (but not so far as to obscure the distinction between the interpretations).
- (a) I forgot how bitter beer tastes.
 - (b) When did you say he should go?
 - (c) The news that Max left Greta was alarming.
 - (d) He asked the man who he had seen.

10

Non-finite clauses

All the sentences/clauses considered so far in this book have been finite. In other words, they all included a finite verb (auxiliary or lexical) – tensed for present or past. A **non-finite clause** is a clause in which there is no tensed verb. They are TENSELESS clauses. Main clauses, remember, are always finite. So **non-finite clauses can only be subordinate**.

The chapter comes in two parts. Part I is about the FORM of non-finite clauses and Part II is about their FUNCTIONS.

Part I: The form of non-finite clauses

There is in fact more to the difference between finite and non-finite clauses than just the presence vs. absence of tense. So, before we look at non-finite verbs and how to represent them, a general point about non-finite clauses needs to be made.

In addition to lacking tense, **non-finite clauses may lack one or more major overt NPs**. They frequently lack an overt subject, for example. In a finite clause, the finite verb must have an overt subject to agree with. Non-finite verbs are not subject to this constraint.

When this is so, I'll say that the relevant NP is **COVERT**. There are two separate circumstances governing the occurrence of a covert NP:

- (a) the reference of the NP is general (indefinite, non-specific), or
- (b) its reference is identical to a constituent in a higher (superordinate) clause.

Consider, for example, the (three) subordinate clauses in [1] and [2]. Their verbs (*chatting* and *wasting*) are tenseless and they lack an overt subject.

[1] [*Chatting with the construction workers*] is a good way of [*wasting time*].

[2] Hedda enjoys [*chatting with the construction workers*].

[3] Hedda doesn't enjoy [*Anna chatting with the construction workers*].

There is a clear difference between the non-finite clauses in [1] and those in [2] and [3]. In [1], we have two examples of (a) above. [1] mentions chatting with

the construction workers and wasting time IN GENERAL – REGARDLESS OF WHO DOES IT. We don't have anyone specific in mind. Contrast that with the covert subject of the non-finite clause in [2]. Here we have an example of (b) above. The understood subject here is perfectly specific. It is identical with the subject of the main clause – namely, *Hedda*. What Hedda enjoys in [2] is HEDDA chatting with construction workers. Anna, it seems, is another matter! In [3], the subject of the subordinate clause has to be overt precisely because it differs from the main clause subject.

We need a short-hand term for this contrast between NPs that are covert because general and nonspecific – (a) – and those that are covert because understood as identical to a constituent in a higher clause – (b). **When a covert NP is understood as identical to an overt element in a higher clause, the higher overt element is said to CONTROL the covert NP.** So the subject of the subordinate clause in [2] is CONTROLLED by the main clause subject (*Hedda*). By contrast, neither of the covert subjects in [1] has a controller in the main clause. That is why they have such a nonspecific, general interpretation. **A covert constituent that is NOT CONTROLLED is described as 'FREE'.**

Try Exercise 1 (page 247) before reading further.

I'll represent covert NPs in the same way as gaps – by '•'. That will do for covert constituents that are FREE. For covert constituents that are CONTROLLED, however, we need to indicate that they are controlled and what they are controlled by. Using subscript numerals for this, we can indicate that the covert subject of the subordinate clause in [2], for example, is controlled by *Hedda* by adding a subscript '1' to both '•' and the subject NP node in the main clause, thus: •₁ and NP₁. This numeral is called an INDEX. So, giving two nodes the same index is 'CO-INDEXING'. From now on, we will always co-index a controlled gap, including gaps created by movement (passive and wh).

The form of non-finite verbs

Non-finite verbs are traditionally divided into (I) infinitives and (II) participles. Each of these is further divided: (Ia) BARE infinitives and (Ib) TO-infinitives; (IIa) PASSIVE participles and (IIb) -ING participles.

I. INFINITIVE verbs:

- a. Bare infinitive b. *To*-infinitive

II. PARTICIPLE verbs:

- a. Passive participle b. *-ing* participle

Ia. Bare infinitive verbs

These just consist of the (untensed) STEM of a LEXICAL verb. The lexical verb is not preceded by any auxiliary verb. It is called ‘bare’ because it lacks the INFINITIVE PARTICLE *to*. Examples of sentences with bare infinitive clauses are:

[4] She made him [*darn* her socks].

[5] All you have to do is [*squeeze* the trigger slowly].

These non-finite (untensed) forms can be distinguished from simple present tense forms (as in *I darn her socks every week*) by a [-TENSE] feature on V, to be read as ‘minus tense’, as in [6].



[-TENSE] will figure – in one way or another – in all non-finite clauses.

Ib. To-infinitive verbs

[7] We declined his invitation [*to* taste the wine].

[8] He is thought [*to* be hiding in Brazil].

[9] Gomez is unlikely [*to* be beaten by a six year old].

[10] [For Max *to* have been beaten] is barely credible.

As you can see, when the INFINITIVE PARTICLE *to* is present, auxiliary possibilities mentioned in Chapter 6 – PERF, PROG, PASS – can also make an appearance. However, since modals (MOD) are always tensed, modals don’t figure in non-finite clauses.

Like the verb that follows MOD, the verb following the infinitive particle *to* has the basic stem form. In several respects, then, it is appropriate to think of *to* as replacing the MOD option. So I shall analyse *to* itself as a [-TENSE] AUXILIARY. For example:

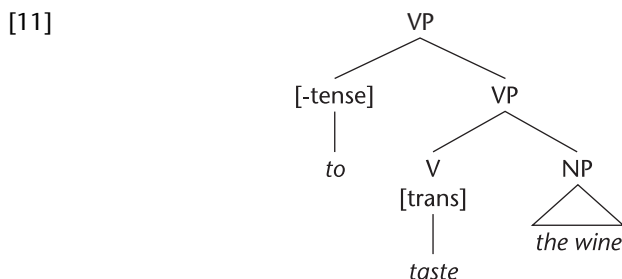

[12]

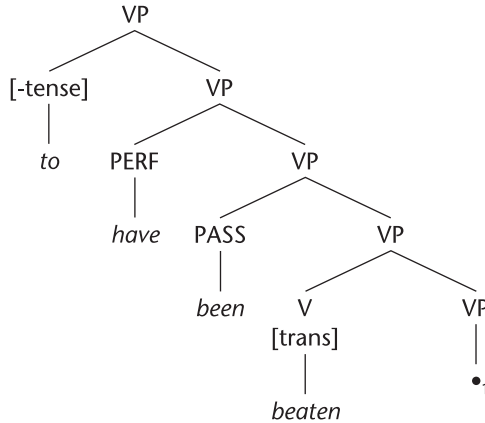

Note that I have indexed the gap. Had I represented the whole clause (*for Max to have been beaten*), it would be co-indexed with the (subject) NP node dominating *Max*.

■ Ila. Passive participle verbs

These are like bare infinitives in consisting of just a LEXICAL verb – but in the passive participle form (with a passive meaning). Here are some examples:

[13] [The palanquin *loaded*], we took a rest.

[14] [*Loaded* to capacity], the palanquin lurched on.

[15] I saw [your book *reviewed* in the paper].

[16] I want [these accusations *investigated*].

As with the bare infinitives, [-tense] will appear as a feature on V.

[17]

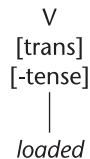

Remember that only verbs taking objects in the active ([trans], [ditrans], and [complex] verbs) can be passive, since passive entails promoting an object to the subject, leaving A GAP IN OBJECT POSITION. In [13], [15], and [16] this subject is overt (*the palanquin, your book, those accusations*). In [14] it is not overt but is controlled by – understood as identical to – the main clause subject (*the palanquin*). In the subordinate clause of [14], then, there will be both a subject-gap and an object-gap:

[14a]

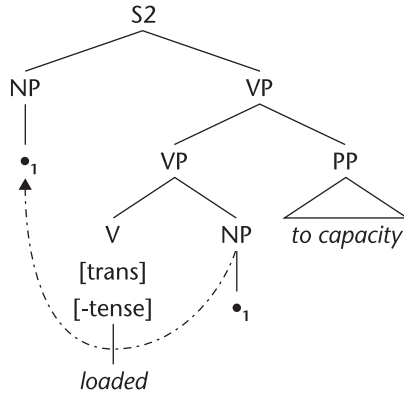

In [14a], I have co-indexed the two gaps. When this subordinate clause is plugged into its super-ordinate main clause (as in [14] above), these gaps need to be co-indexed with the main clause subject, *the palanquin*.

IIb. -ing participle verbs

As with *to*-infinitive clauses, auxiliaries can figure in *-ing* participle clauses. Instead of the first verb being preceded by *to*, it takes the *-ing* affix.

[18] He always had difficulty in [apologising].

[19] Judith was busy [stuffing the peppers].

[20] [Murtlock having been hospitalised], I conducted a bedside interview.

I will attach [-tense] as a feature to the Verb in the *-ing* form (whether lexical or auxiliary).

[21]

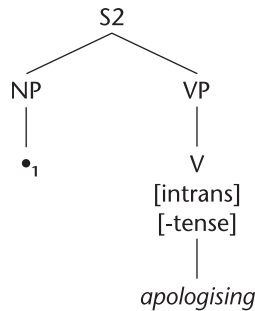

[22]

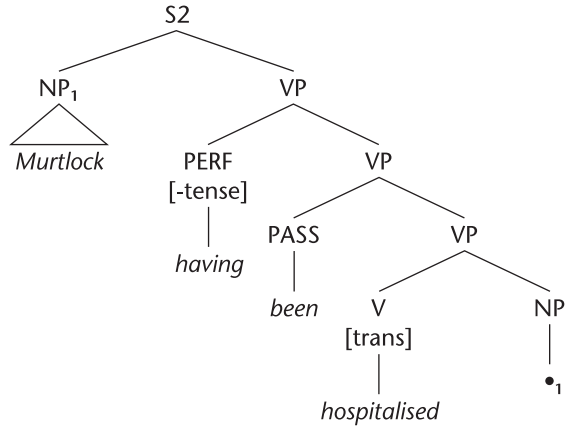

In [21] the gap will be co-indexed with the main clause subject of [18], *he*.

Notice I have called the initial verb in these non-finite clauses ‘*-ing* participle’, NOT ‘*progressive* participle’. While the participles discussed under Iia above clearly are passive, *-ing* participles cannot be regarded as progressive. The reason for this is that there are verbs (called *STATIVE* verbs), such as *know* and *own*, which CANNOT appear in the progressive participle form following *PROG be* ([23a], [24a]) but CAN appear in non-finite *-ing* participle clauses ([23b], [24b]):

- [23a] *I am knowing the Beethoven trios intimately.
- [23b] Knowing the Beethoven trios intimately helps a lot.
- [24a] *He was owning that mangrove swamp.
- [24b] Owning that mangrove swamp meant nothing to him.

Furthermore, we know that progressive *be* cannot precede perfect *have*. This means that perfect *have* cannot assume the progressive participle *-ing* form demanded by a preceding progressive. See [25a]. Nevertheless, perfect *have* can assume the *-ing* participle form in non-finite clauses, as in [25b]. So the *-ing* form that figures in non-finite clauses must be distinguished from the progressive participle.

- [25a] *Buster is having sold the swamp.
- [25b] Having sold the swamp, Buster departed.

I now turn to more general aspects of the form of non-finite clauses.

Complementisers and non-finite clauses

As in finite clauses, there are two complementiser positions in non-finite clauses. These are filled by the (unfronted) C1 complementisers, *for* and *whether*, and (fronted) C2 *wh*-expressions. I shall represent all subordinate clauses as

introduced by C1 and dominated by S' (unless complementing a preposition) but I shall only represent the C2 position and S'' when necessary.

■ C1: *for* and *whether*

Only *to*-infinitive clauses can be introduced by the C1 interrogative complementiser *whether* or – a new C1 complementiser, this – *for*.

For figures overtly only in (*to*-infinitive) clauses WITH AN OVERT SUBJECT. See [26]–[28]. Even then – as [29] shows – *for* is not always possible, in which case the C1 position will be empty.

- [26] [**For** Angelo to get all the blame] seems unfair.
 [27] The police issued orders [**for** the vehicles to be removed].
 [28] It will be difficult [**for** me to get there on time].
 [29] The magician expected [(***for**) the rabbits to disappear].

Notice, incidentally, the form of pronominal subject in [28]: although it is subject, it has accusative case form. I mention this again below.

The phrase marker for the non-finite clause in [26] is given as **Discussion 1**, page 244.

To-infinitive *whether*-clauses, by contrast, never have an overt subject. Generally, the covert subject is controlled by the subject of the superordinate clause, as in [30] and [31]. Notice that when the *whether*-clause is itself functioning as subject, as in [32], the covert subject is not controlled (it's free):

- [30] [King Louis]₁ was uncertain [whether [_•₁ to support the Pope]].
 [31] [Olsen]₁ asked the Captain [whether [_•₁ to cut the engines]].
 [32] [Whether [_• to permit such activities]] is a tricky question.

■ C2: fronted *wh*-phrases

Non-finite *wh*-clauses can be interrogative or relative. First, **INTERROGATIVE clauses**. As with the (*yes/no*) interrogative *whether*-clauses just looked at, non-finite *wh*-interrogative clauses can only be *to*-infinitive and always have a covert subject.

- [33] Sarah₁ asked me [[how many guests]₂ [_•₁ to expect _•₂]].
 [34] He told me₁ [[where]₂ [_•₁ to put it _•₂]] in no uncertain terms.
 [35] The Orsini₁ never had doubts about [[who]₂ [_•₁ to vote for _•₂]].
 [36] It was not clear [[who]₁ [_• to nominate _•₁]].

In [36] the main clause subject is expletive *it*. This is not a referring expression and so cannot control the interpretation of the covert subject of the subordinate clause (which is, therefore, free). Notice also a difference between *tell* and *ask*. In [33], with *ask*, the subject of the interrogative clause is controlled by the main clause SUBJECT (*Sarah*). In [34], with *tell*, by contrast, it is controlled by the OBJECT (*me*).

Since the subject in the subordinate clauses must be either free – as in [36] – or controlled by a constituent in the superordinate clause, the subject is the one constituent that cannot be fronted to the C2 position of the subordinate clause. Here is a phrase marker for the subordinate clause in [33].

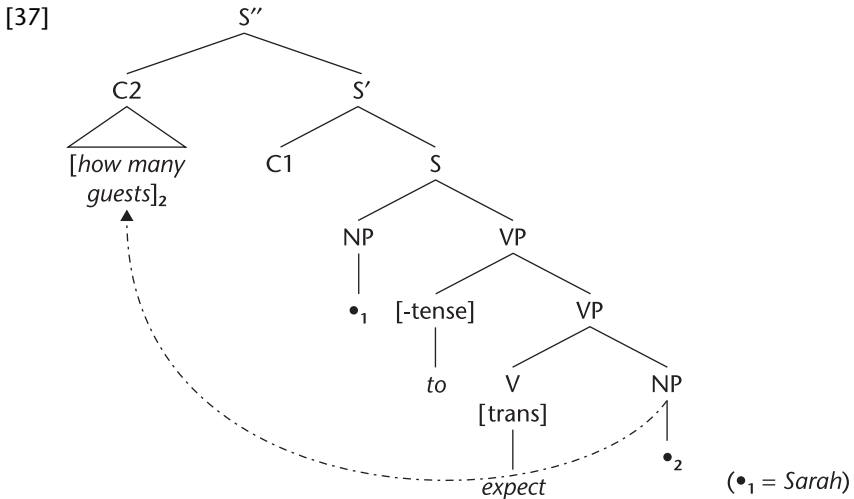

Assuming that *Sarah* in the main clause of [33] has the index ‘1’, I have co-indexed the covert subject with *Sarah*. And, to keep track of all these gaps, I have co-indexed *how many guests* in C2 with the direct object gap. Since *how many guests* has here been fronted from the dO position, it is reasonable to think of it as being the controller of that position (controlling the interpretation of the gap).

As for **non-finite relative clauses**, these are less readily identifiable as *wh*-clauses (with fronting) than the *wh*-interrogative clauses just considered. This is because **the fronted *wh*-phrase is never overt in the non-finite relative clause**. As the following show, all forms of non-finite verb are permitted in relative clauses except the bare infinitive:

- [38a] The instrument [to use] is a No.9 scalpel.
- [39a] A book [for you to review] is in the post.
- [40a] There are no WCs on the overnight train [now departing].
- [41a] A cat [fed on smoked salmon] will start demanding champagne.

Although there is no overt *wh*-phrase in these, we know they must be relative clauses (a) because they are functioning as modifiers within NP (modifiers of NOM) and (b) because – in addition to any covert constituent they may have in virtue of being non-finite – they always have a further gap, created by the fronting of a covert *wh*-phrase (to C2). In the following, I give the closest corresponding finite clause, each of which is an overt relative clause.

[38b] [• to use •]	[38c] which [one should use •]
[39b] [for [you to review •]]	[39c] which [you might/should review •]
[40b] [• now departing]]	[40c] which [• is now departing]
[41b] [• fed • on smoked salmon]	[41c] which [• has been fed • on smoked salmon].

In [38] the subject of *use* is free and the object is controlled by a fronted *wh*-phrase (covert in [b], overt in [c]). In [39] the object gap is due to the fronting of a covert *wh*-phrase. The same goes for the subjects in [40] and [41]. As for the object gap in [41b], this is due to the *passive* participle. The object has been promoted to subject – and then *wh*-fronted.

Part II: The functions of non-finite clauses

The functions of non-finite clauses will be familiar to you from previous chapters. They are illustrated (some of them several times) in the examples given so far in this chapter. Before reading further, then, take time to go through the examples of sentences containing non-finite clauses presented thus far and decide on the function of that clause in each. List them by function; when you encounter a function for the first time, start a new list. This (quite big) exercise is answered in the following sections.

In the rest of this chapter I simply list those functions, giving further examples where necessary. Occasionally it will be necessary to comment on particular issues but I have kept these to a minimum. Complementation of verbs by non-finite clause requires more discussion and this has been reserved until the end.

Subject and extraposed subject

This function is illustrated in [1] (first clause), [10], [23b], [24b], [26] and [32]. As with the finite clauses of Chapter 8, a non-finite clausal subject should be dominated by NP. In [28] and [36] the subject clause is extraposed.

[42a] [Stripping wallpaper] is a wretched business.

[42b] It's a wretched business [stripping wallpaper].

Notice that *-ing* participle clauses WITH OVERT SUBJECT cannot be extraposed:

[43a] [Oscar attempting the double somersault] should amuse you.

[43b] *It should amuse you [Oscar attempting the double somersault].

The phrase marker for [42a] is given as **Discussion 2**, page 244.

Complement of A in AP

This function of non-finite clauses was illustrated in [9], [19], and [30] (not [28], as this is an example of extraposed subject). This is an intriguing construction. There are several types of adjective complementation by *to*-infinitive clause, depending on the head adjective itself. Here I distinguish two main types, exemplified by

[44a] Max is reluctant [to try it].

[44b] That piano is impossible [to move].

Adjectives that pattern [a] like *reluctant* are: *anxious*, *eager*, *keen*, *hesitant*, *unwilling*, *happy*, and *liable*. Adjectives that pattern [b] like *impossible* are: *easy*, *hard*, *difficult*, *tough*, *tiresome*, *boring*, *enjoyable*, *disgusting*, and *delicious*. Focusing on the interpretation of the covert constituents, what is the difference between these?

With the [a] adjectives, the higher subject controls the covert SUBJECT of the adjective complement clause. By contrast, with the [b] adjectives, the higher subject controls the OBJECT of that clause. The lower subject with the [b] adjective cannot be controlled: it must either be free, as in [44b], or overt, as in [45].

[45] That piano is impossible for *the dancers* to move.

Sentences with a *to*-infinitive clause complementing a [b]-type adjective correspond to sentences in which the object figures overtly, in a clause functioning as subject or extraposed subject. Thus [44b] (repeated here) is paraphrased by [46] and [47]:

[44b] That piano is impossible [to move].

[46] [To move that piano] is impossible.

[47] It is impossible [to move that piano].

It could be argued, then, that the [b]-construction actually involves, not a complement of A in AP, but extraposition of the clausal subject (as in [47]). However, in the absence of expletive *it* in [44b], I shall treat the clause there as an A-complement. Phrase markers for [44a]–[44b] are given as **Discussion 3**, pages 245.

Complement of P in PP

Only *-ing* participle clauses can complement a preposition within PP. Examples are [1] (**second clause**) and those in [18] and [35]. In each of those, the PP itself is functioning as a noun-complement in NP. But PPs with a non-finite clausal complement have other functions too. Give the functions of the relevant PP in the following.

[48] John re-parked the car in his absence *by* [leaving the handbrake off].

[49] *With* [the troglodytes approaching], Argon capitulated.

[50] We became zombies *through* [watching too much TV].

[51] This resulted *in* [Murtlock being hospitalised].

[52] He was hopeless *at* [writing letters].

The PPs in [48]–[50] are functioning as adverbials, that in [51] as complement of the [prep] verb *result*, and that in [52] as complement to A (*hopeless*) in AP. The phrase marker for [50] is given as **Discussion 4**, page 246.

Adverbial

We have just seen that non-finite clauses can function as the complement of P in a PP functioning as an adverbial. They can also function as adverbials in their own right. Examples already given are: [13], [14], [20], and [25b]. As the following show, the subject must either be overt or controlled by the subject of the superordinate clause.

-ing participle (with and without overt subject):

[53a] [The Count having invited us], we cancelled other plans.

[53b] [_•₁ Having furnished ourselves with garlic], we₁ set off.

To-infinitive (with and without overt subject):

[54a] We hung around [for the Count to appear].

[54b] We₁ helped ourselves to wine [_•₁ to relieve the boredom].

Passive participle (with and without overt subject):

[55a] [The wine finished], we dozed fitfully in our chairs.

[55b] We, returned, [•, disappointed by our evening].

The phrase marker for [55b] is given as **Discussion 5**, page 246.

Mention should be made here of non-finite adverbial clauses with a (C1) **subordinating conjunction**. Examples are:

[56] I will come [*if* needed].

[57] The mixture will explode [*unless* kept below freezing].

[58] [*Although* feeding twice a day], he still seems hungry.

[59] I can do this [*without* using my hands].

[60] Max brandished the weapon [*as if* to frighten them].

Complement of N in NP

Examples were given in [7] and [27] above. Here are further examples:

[61] We simply ignored [his appeals [for us to join the folk-dance]].

[62] [His ability [to think]] was severely impaired by the experience.

[63] [His proposal [to show us his holiday snaps]] was treated politely.

Which constituent controls the covert subject in the infinitive clauses of [62] and [63]?

The bracketed NPs in [62] and [63] are NP versions of the following clauses:

[64] He was able to think. [65] He proposed to show us his holiday snaps.

In these, the covert subject of the infinitive clause is controlled by the subject of the superordinate clause. Now, in the NPs in [62] and [63], this subject has assumed the form of a possessive determiner. So the covert subject of the infinitive clauses in [62] and [63] is controlled by the **DETERMINER** of the NP in which the clause appears.

The phrase marker for the subject NP of [62] is given as **Discussion 6**, page 247.

Modifier in NP

Examples are [38a]–[41a]. There is little more that needs to be said here. Clausal modifiers in NPs are **RELATIVE** clauses with a covert *wh*-phrase. They are **RESTRICTIVE ONLY** and thus **modifiers of NOM in NP**.

Here is a phrase marker for the subject NP of [38a] above:

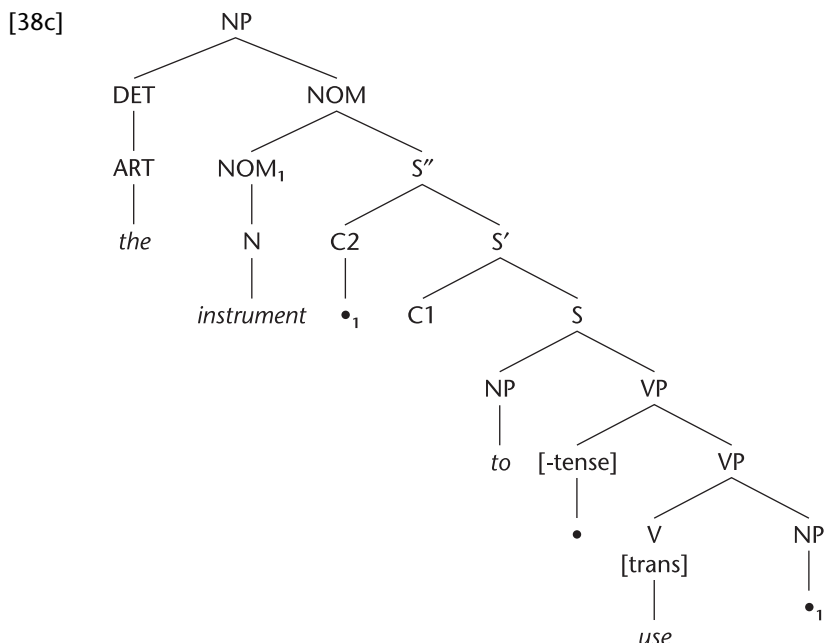

Notice that, in addition to co-indexing the object NP gap and the covert C2, I have co-indexed both with the NOM *instrument*. This captures the fact that the direct object of *use* is understood as an NP having *instrument* as head.

Complement of V

As mentioned, complementation of verbs by non-finite clause requires more discussion. What follows is intended to give an initial impression of this rich and controversial area of English grammar.

Since Chapter 4 we have operated with a six-way sub-categorisation of verbs. This has the effect of assigning more specific functions to their complements (direct and indirect object, subject- and object-predicative, prepositional complement). It is not clear, however, that this sub-categorisation system is appropriate in cases of complementation by non-finite clause.

For example, there are straightforwardly transitive verbs (taking an NP as direct object) that can also take a non-finite clause as complement (e.g. *believe* as in [66a–b]), but there are other verbs that can take a clause but not an NP (e.g. *hope* and *condescend* as in [67a–b]).

[66a] I believe his story/William.

[66b] I believe William to have been in the garden.

[67a] Michelangelo condescended/hoped to decorate the ceiling.

[67b] *Michelangelo condescended/hoped the decoration of the ceiling.

Can we then think of the clause in [67a] as a direct object exactly?

Furthermore, *promise* and *ask* are ditransitive verbs, taking an indirect object NP and a direct object NP (as in [68a], [69a]). This might lead us to analyse [68b] and [69b] as ditransitive and analyse the non-finite clause as the direct object:

[68a] I promised [Herzog] [my spaghetti machine].

[68b] I promised [Herzog] [to wear the wig].

[69a] I asked [Astrid] [a question].

[69b] I asked [Astrid] [to make no comment].

So far, so good. There are good reasons, though, for analysing VPs with *force* and *dare* as having the same constituent structure as those with *promise* and *ask*.

[70] I $\left\{ \begin{array}{l} \text{forced} \\ \text{dared} \end{array} \right\}$ [Astrid] [to wear the wig].

Yet neither *force* nor *dare* can take two NPs (i.e. they are not obviously ditransitive). Besides, it's not obvious that *Astrid* in [70] (and even in [69b]) is really describable as an indirect object.

Rather than give further examples of specific problems to do with the functions of complements in the various sub-categories, I will mention a more general consideration. To capture the full intricacy of verb complementation, we really need to sub-categorise verbs in a way independent of, and more detailed than, the six subcategory feature labels used so far.

For example: subcategorising *kick*, *believe*, *say*, and *watch*, as '[trans]' hardly does justice to the different complements they can or cannot take. True, all four can take a direct object NP (*kicked the chessboard*, *believed the story*, *said the prayer*, *watched the fun*). But, unlike *say* and *believe*, *kick* and *watch* can't take a *that*-clause.

[71] She said that Rashid had the perfect disguise.

[72] She believed that William was in the outhouse.

[73] *Gomez kicked that he had lost the match.

[74] *Talullah watched that the clown was putting on his make-up.

Furthermore, leaving *kick* aside (since it cannot take any clause), *believe* can take a *to*-infinitive clause with overt subject, but *say* and *watch* cannot.

[72a] She believed William to be in the outhouse.

[73a] *She said Rashid to have the perfect disguise.

[74a] *Talullah watched the clown to put on his make-up.

On the other hand, *watch* can take an *ing*-participle clause, but *believe* and *say* can't.

[72b] Talullah watched the clown putting on his make-up.

[73b] *She believed William being in the outhouse.

[74b] *She said Rashid having the perfect disguise.

A fully detailed and explicit sub-categorisation system, one that did justice to the intricacy of your knowledge of this aspect of the English language, would need to sub-categorise each verb for at least the following:

- [75] (a) whether it can take a clause as complement;
 (b) if so, whether that clause may or must be interrogative;
 (c) whether it can be finite or non-finite;
 (d) if non-finite, which of the four types of non-finite clause are permitted;
 (e) whether an NP can intervene between the finite and the non-finite verbs;
 (f) if so, what the function of that NP is;
 (g) what constituent, if any, controls the covert constituents (if any) in the non-finite clause.

Answering these questions for the several thousand English verbs would be ambitious by any standard – well beyond the scope of this chapter. Even so, as I hope the discussion of *kick*, *say*, etc. shows, it would result in an approach to the sub-categorisation of verbs rather different from that employed so far, one independent of the functions dO, iO, sP, and oP. This is not to say there is no correspondence between verb complementation by non-finite clause and the six-way sub-categorisation of previous chapters. There is, as we saw with *ask* and *promise*. Consider also the complements of the [intensive] copula *be* in the following, which are clearly subject-predicatives.

[76] The noise you can hear is [Tessa slurping her coffee].

[77] All he ever did was [lounging about and cleaning his ears].

When a non-finite clause complements a verb, then, I shall not attempt to assign that clause a more specific function (dO, iO, sP, oP) in terms of the sub-categorisation of the verb that it complements. This means that the sub-categorisation feature on that verb can be dispensed with. And, since we have questioned whether such complement clauses do function precisely as direct objects, I won't demand they be dominated by an NP node.

For **verbs complemented just by a non-finite clause without overt subject**, it suffices to note that only *to*-infinitive and *-ing* participle clauses are admitted. The covert subject is always controlled by the subject of the superordinate clause. Further examples are [78]–[79]. Notice the distinction in meaning between the

to-infinitive (which implies that he didn't kiss her) and the *ing*-particle (which implies he did).

[78] He didn't remember to kiss Millie.

[79a] He didn't remember kissing Millie.

[79b]

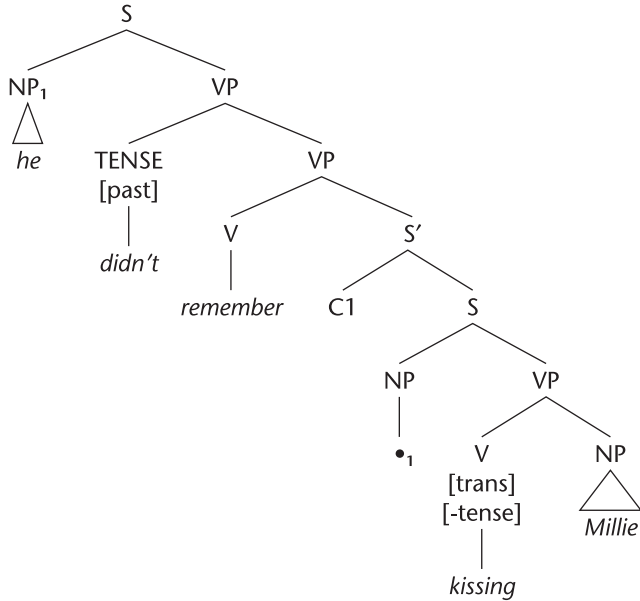

Matters are not so straightforward when an NP intervenes between the verb of the superordinate clause and the non-finite verb of the subordinate clause. In the following, the relevant NP is italicised.

V + NP + *to*-infinitive.

[80] I'd prefer *the butler* to taste it first.

[81] She encouraged *Muldoon* to buy her the diamonds.

[82] Machiavelli believed *him* to be the ideal prince.

[83] I'd like *the Right Honourable Member* to try it for a week.

V + NP + *-ing* participle.

[84] He had heard *Victoria and Albert* singing that duet.

[85] I caught *the clowns* helping the elephants onto the trapeze.

V + NP + bare infinitive.

[86] Marcel made *Celeste* peel him a grape.

[87] He watched *Magda* polish off the toast.

V + NP + passive participle.

[88] She found *the icon* buried in the wall.

[89] She kept *Raleigh* imprisoned in the tower.

The question raised by these examples is [75(f)] above. **Is the italicised NP the SUBJECT of the SUBORDINATE clause or the OBJECT of the SUPERORDINATE clause?** Take [87]. Is *Magda* subject of *polish off* or is it object of *watched*? It makes a difference to the constituent analysis of the higher VP: (I) If that NP is the SUBJECT OF THE LOWER VERB, the higher VP will consist of V and a non-finite clause (with OVERT subject) functioning as the ONE COMPLEMENT of V. By contrast, (II) if the NP is OBJECT OF THE HIGHER VERB, then it must be a constituent in the structure of the higher VP (a sister of the higher V). The higher V will then have TWO COMPLEMENTS, an NP and a non-finite clause with COVERT subject.

I. Subject of lower V

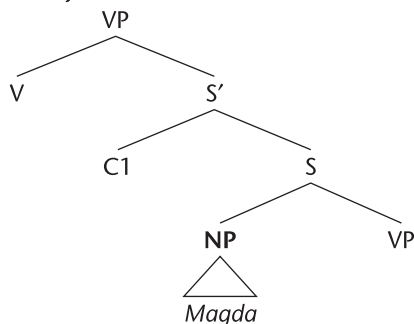

II. Object of higher V

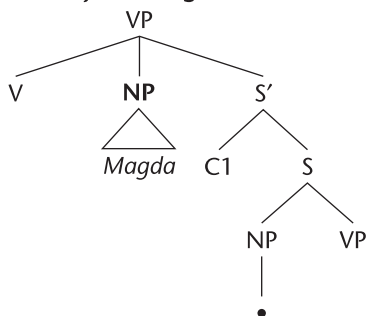

This uncertainty arises for several reasons, three of which I shall mention here.

(i) When functioning as the complement of V, non-finite clauses very rarely allow an overt complementiser. *Prefer* is among the very few verbs, in British English at least, to do so – and then only for some speakers.

[90] I'd prefer [*for the butler to taste it*].

Since the function of the complementiser is to introduce the subordinate (lower) clause, it very clearly MARKS THE DIVISION between the higher and the lower clause. In [90] (and [80] above), then, *the butler* falls squarely within the lower clause and must be regarded as its subject. However, in the (much more usual) absence of an overt complementiser, no such obvious clue as to the function of the NP is provided.

(ii) If you replace the italicised NPs in [80]–[89] by pronouns, those pronouns must appear in the objective (accusative) case: *me, him, her, us, them*. This might suggest that those NPs must be functioning as objects rather than as subjects (cf. *She loves him and he loves her*). Against this, it could be (indeed has been) argued that it is not just OBJECTS that take accusative case form, but also SUBJECTS OF NON-FINITE CLAUSES. And the following examples, in which the accusative pronoun clearly is functioning as subject of its clause, bear this out.

[91] [For *him* to attempt it] would be ludicrous.

[92] The noise you can hear is [*them* slurping their drinks].

So, the fact that the NP is accusative is consistent with either analysis.

(iii) The fact that the relevant NP may be understood as the subject of the lower verb doesn't help us either – for, again, this can be explained in either of two ways. On the one hand, the NP is *understood* as the subject of the lower verb because it actually *is* the subject of the lower verb (Analysis I). What could be more straightforward? On the other hand, however, it is possible to say that, while it is actually the object of the higher verb, that higher object **CONTROLS THE COVERT SUBJECT** of the lower verb. On this analysis (Analysis II) the fact that it is *understood* as the subject of the lower clause is consistent with its actually *being* object in the higher clause.

These structures have been subject to much discussion. The one point of agreement is that they cannot all receive the same analysis: **it depends on the verb that heads the higher VP**. For the purposes of this chapter, I shall divide verbs taking non-finite clausal complements into **TWO TYPES**: verbs that take just a single clausal complement with overt subject (Analysis I) and verbs taking two complements, a direct object NP and a clausal complement with a (controlled) covert subject (Analysis II).

Type I verbs include: *assume, believe, consider, desire, dread, expect, feel, hear, know, like, observe, prefer, regret, suppose, watch*.

Type II verbs include: *advise, ask, coax, compel, dare, encourage, force, promise, persuade*.

The rest of this chapter discusses how to decide which type a given verb belongs to.

TYPE I VERBS TAKE A CLAUSE AS THEIR SINGLE COMPLEMENT. Clauses (finite or non-finite) only denote the kind of thing that can be true or false. In other words, **clauses denote PROPOSITIONS**. It is propositions that are thought, said, considered, supposed, believed, wanted, desired, dreaded (etc.). You think (say, consider, suppose, believe, want, etc.) certain propositions to be true. You regret (dread, imagine, like, prefer) certain propositions being true. Accordingly, all the verbs alluded to in this paragraph are Type I verbs, taking just a clause with overt subject as complement.

By contrast, a proposition just isn't the kind of thing you can advise, ask, coax, dare, encourage, persuade (etc.). So these verbs, and others like them, cannot be thought of as taking just a clause (which denotes a proposition) as complement. Type II verbs call for complements referring to things that have volition – i.e. **AGENTS** (people or animals). You cannot advise, persuade (etc.) volition-less things to do something. **So, these verbs require an agentive NP as (dO) complement in addition to the non-finite clause**. In other words, they are **Type II verbs**.

Consistent with this general picture, the vast majority of Type I verbs can also be complemented just by a finite *that*-clause (cf. *He believed [that Cesare was the ideal prince]*). By contrast, Type II verbs are not in general capable of taking just a *that*-clause. They take two complements. Compare **He persuaded [that Cesare was the ideal prince]* with *He persuaded [us] [that Cesare was the ideal prince]*.

To make this clearer, let's consider:

[93] The tree lost its leaves. [94] *!* advised the tree.

[93] expresses something that can be believed without making any special assumption about trees. [94], by contrast, requires the fairy-tale assumption that a tree can follow advice. So, [93] shows that no special assumption is required for *the tree* to be subject of *lost its leaves*, while [94] shows that the special assumption is required for it to be object of *advise*. Now consider [95], in which the function of the italicised NP is in question.

[95] *!* advised *the tree* to lose its leaves.

[96] I expected *the tree* to lose its leaves.

[95] requires exactly the special assumption about trees that [94] did. This shows that in [95] *the tree* is functioning as it did in [94] – i.e. as dO of *advise*. Certainly, *the tree* is understood as the subject of *to lose its leaves* – but this is because, while functioning as dO of *advise*, it controls the covert subject of *to lose its leaves*.

Another way of testing this involves EXPLETIVE *THERE*, as illustrated in [97b]:

[97a] Five gorillas are in the outhouse.

[97b] There are five gorillas in the outhouse.

In contrast to expletive *it* (which can function as subject or object), expletive *there* can only function as SUBJECT, never as object. Since the NP following a Type II verb functions as its object, expletive *there* can only follow Type I verbs, not Type II verbs – and we get the following contrast:

[98–Type I] Rowena expected there to be more food.

[98–Type II] *Rowena advised there to be more food.

[99–Type I] I prefer there to be plenty of exercises.

[99–Type II] *I persuaded there to be plenty of exercises.

[100–Type I] He dreaded there being reporters in the lobby.

[100–Type II] *He forced there to be reporters in the lobby.

With just one verb, *promise*, there is an even more compelling reason for assigning it to Type II. With all other verbs of Type II, the covert subject of the lower clause is controlled by the OBJECT of the higher clause. This was one of the reasons given for wondering which position (subject or object) the intervening NP actually occupied. But with *promise*, the covert subject of the lower clause is controlled, not by the overt object of the higher clause, but by the SUBJECT.

Promise thus very clearly demands both a direct object AND a clause with a distinct (covert) subject. Compare *promise* and *beg* (which are both Type II) in Exercise 1 below. Further Exercise 5 deals with an intriguing further difference between the two types of verb.

To conclude, then: [101a], with the Type I verb *expect*, should be represented as in [101b], and [102a], with the Type II verb *persuade*, as in [102b].

[101a] They expected the bear to dance.

[102a] They persuaded the bear to dance.

[101b]

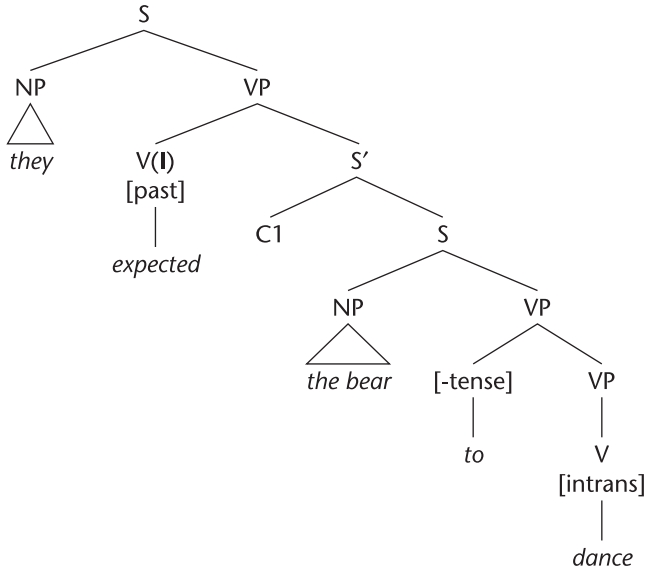

[102b]

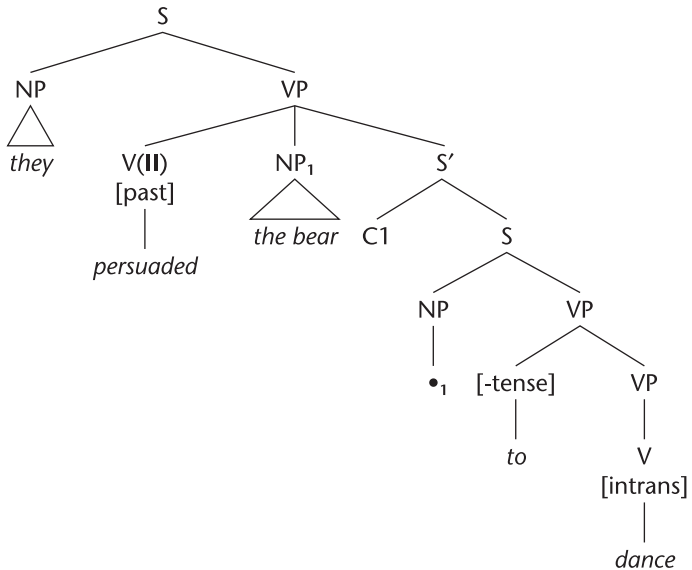

Now decide for yourself which type each of the following verbs belongs to: *teach, claim, love, forbid, find, hate, want, invite, beg, warn, tell, prove, recommend, imagine, prevent, urge, mean*. The answers are given as **Discussion 7**, on page 247.

Discussion of in-text exercises

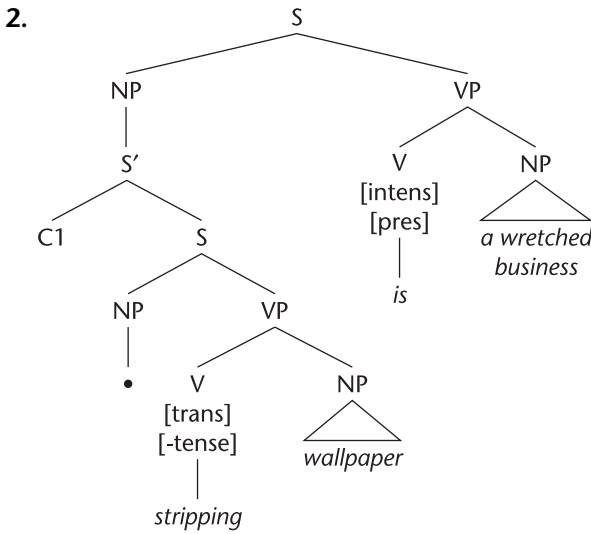
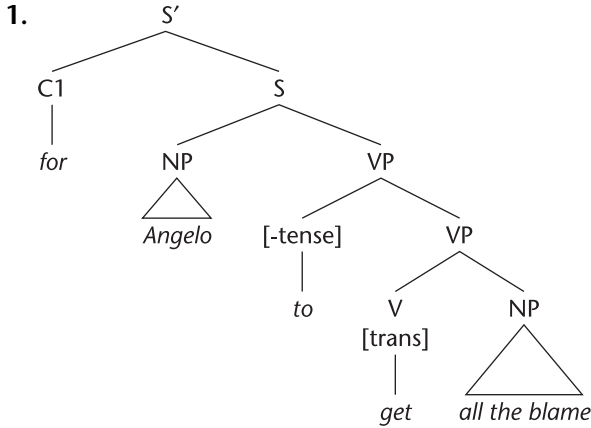

(The subject of the non-finite clause is free.)

3. [44a]

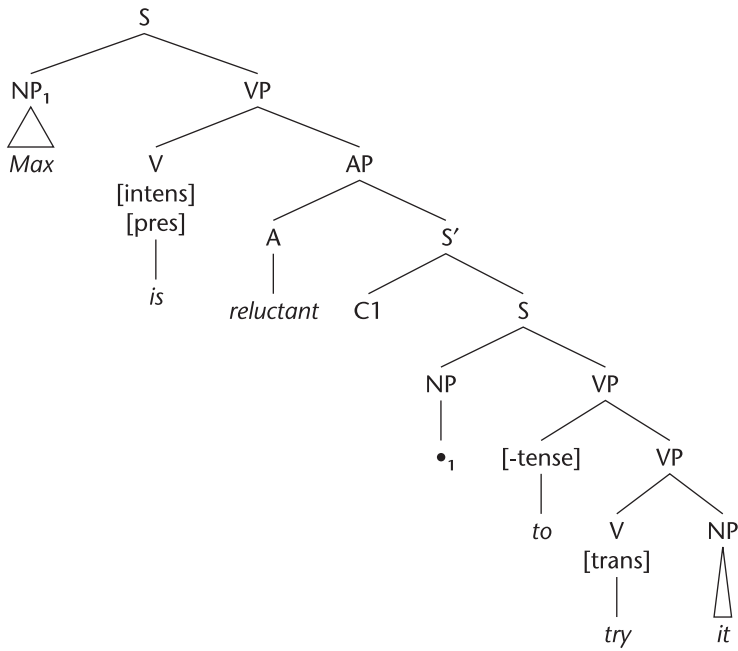

[44b]

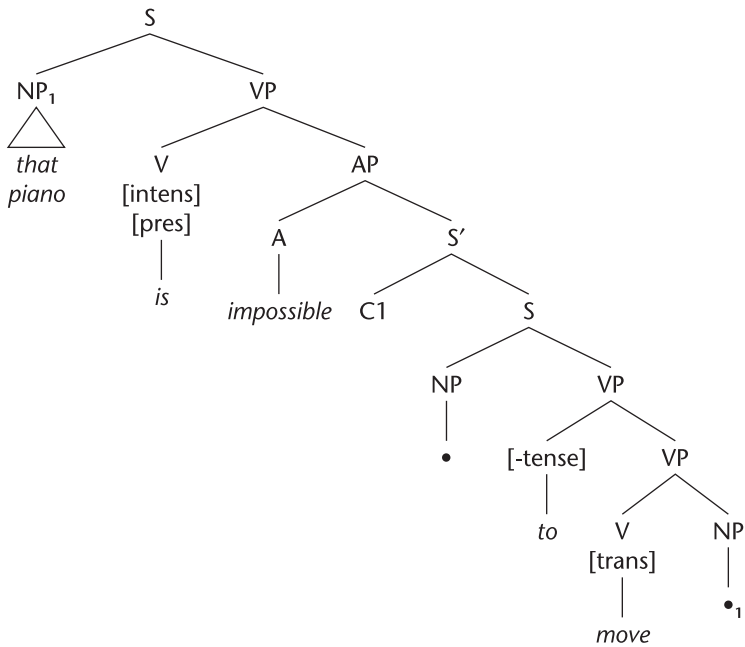

(The subject of the non-finite clause is free.)

4. [50]

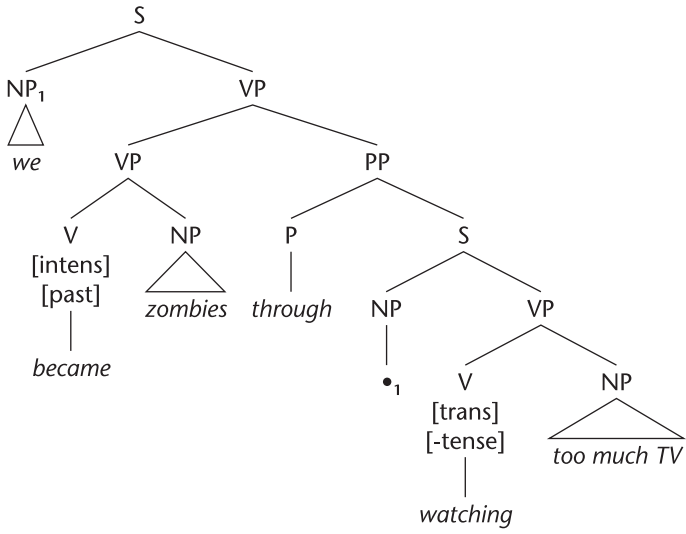

5. [55b]

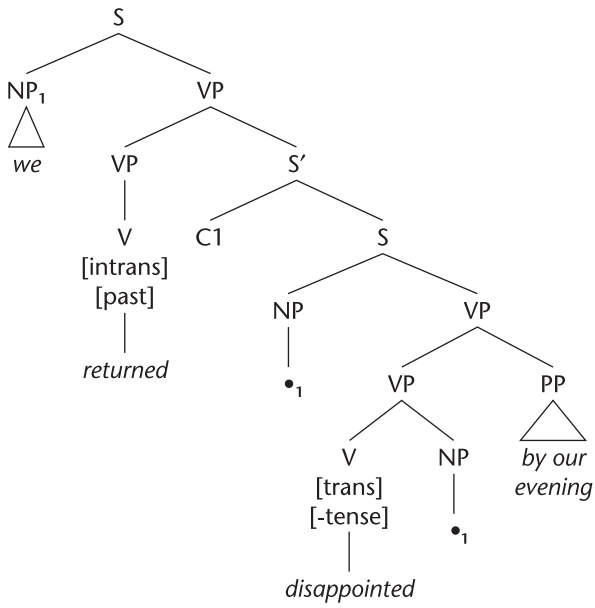

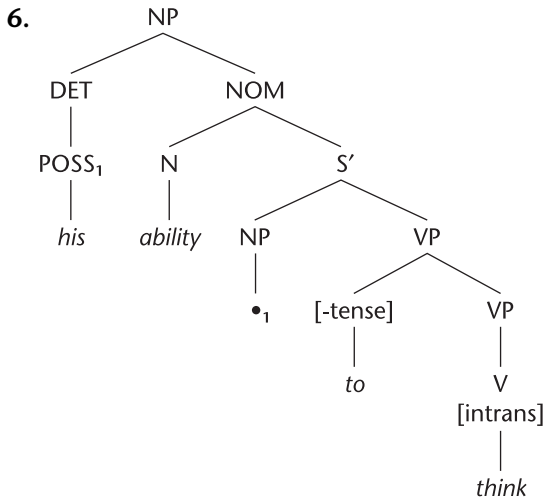

7. Type I verbs: *claim, love, find, hate, prove, want, imagine, prevent, mean*.
 Type II verbs: *teach, forbid, invite, beg, warn, tell, recommend, urge*.

Exercises

1. (a) Identify the covert constituents (if any) in the bracketed non-finite clauses of the following sentences.
 (b) State whether they are controlled or free. If they are controlled, identify the controller.

Example: *Louis was wondering [whether • to support the Pope].*

(a) Subject, (b) controlled by main clause subject (*Louis*).

- (i) I want [to be alone].
- (ii) I wanted [John to be alone].
- (iii) Morgan promised Bill [to give it a good review].
- (iv) Morgan begged Bill [to give it a good review].
- (v) [Getting to the top] finished Hedda off.
- (vi) [Giving it a swift kick] sometimes works.
- (vii) The trombone is too old [to play].
- (viii) Max is too stubborn [to talk].
- (ix) Max is too stubborn [to talk to].
- (x) Svengali was too clever [for them to entrap].
- (xi) It should be clear [how to do this].
- (xii) John was not clear [how to do this].

2. Under complement of A in AP, we considered

(i) This piano is impossible to move.

Notice that we could refer to the piano by means of the pronoun *it*:

(ii) It is impossible to move.

But now (ii) is ambiguous. The ambiguity is created by two distinct factors. First, the *it* of (ii) is ambiguous. Out of context we cannot tell whether it's the expletive *it* associated with an extraposed subject, or whether it's a referring expression (referring e.g. to a piano). Second, *move* can be either transitive or intransitive. Bearing these points in mind, draw a phrase marker for each interpretation of (ii).

3. (a) Draw Abbreviated Clausal Analyses of the following sentences:

(b) Indicate covert constituents (with '•'). If they are controlled, co-index them with their controllers.

(c) For each clause, give its form and function.

Example: *Having shaved your head, will you ask the wig man if he is ready to fit you?*

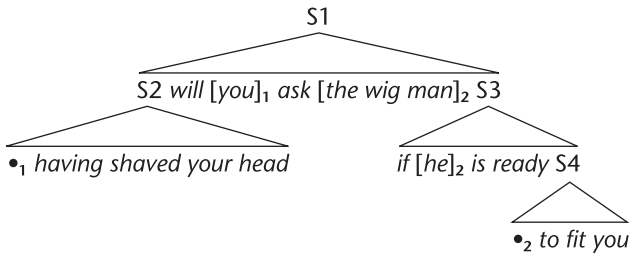

S1: finite *yes/no* interrogative, main.

S2: non-finite (*-ing* participle), adverbial.

S3: finite interrogative, complement of V (*ask*).

S4: *to*-infinitive, complement to A (*ready*).

- (i) The Doge of Venice appears to have been eager to join the Crusade.
- (ii) Which authors does the professor hope to lecture on this term?
- (iii) Plans to recover the vehicles abandoned during the night are under consideration.
- (iv) The first chef to be informed of it congratulated Melvin on rescuing the steaks without damaging them.
- (v) It seems that, having been taught by Mozart himself, Joachim knew the quintet to be well within his capacities.

Discussion of exercises

1. (i) Subject, controlled by main clause subject (*I*).
 - (ii) No covert constituents.
 - (iii) Subject, controlled by main clause subject (*Morgan*).
 - (iv) Subject, controlled by main clause indirect object (*Bill*).
 - (v) Subject, controlled by main clause object (*Hedda*).
 - (vi) Subject, free.
 - (vii) Subject, free. Object, controlled by main clause subject (*the trombone*).
 - (viii) Subject, controlled by main clause subject (*Max*).
 - (ix) Subject, free. Object of P in PP, controlled by main clause subject (*Max*).
 - (x) Object, controlled by main clause subject (*Svengali*).
 - (xi) Subject, free.
 - (xii) Subject, controlled by main clause subject (*John*).
2. With *it* as a referring expression, the clause complements A, and the covert object of the transitive verb *move* is controlled by the main clause subject (the referring expression *it*). See (a) below. On the other (b) interpretation, *it* is expletive and the clause is an extraposed subject. Expletive *it* cannot be a controller (see Exercise 1 (xi) above). Here *move* is intransitive, and (ii) is equivalent to *Moving is impossible*.

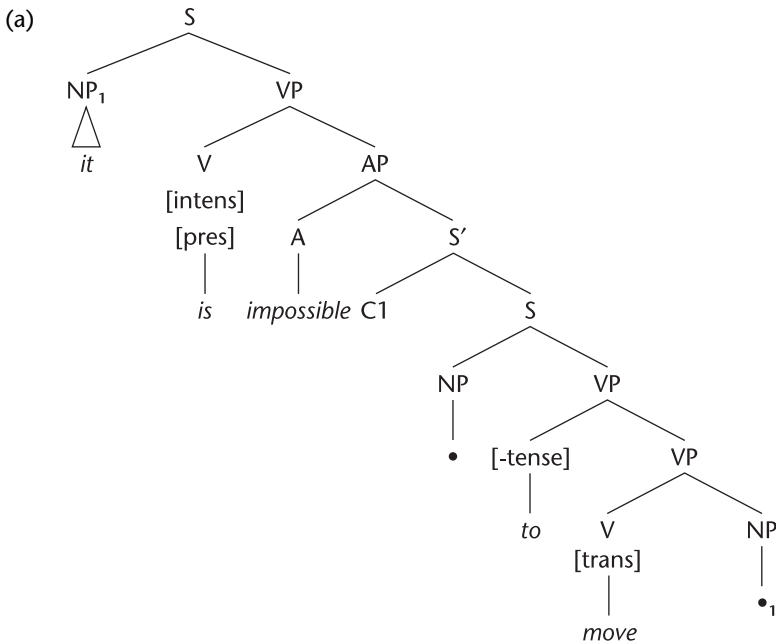

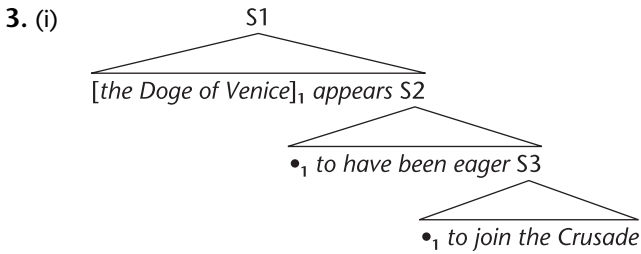
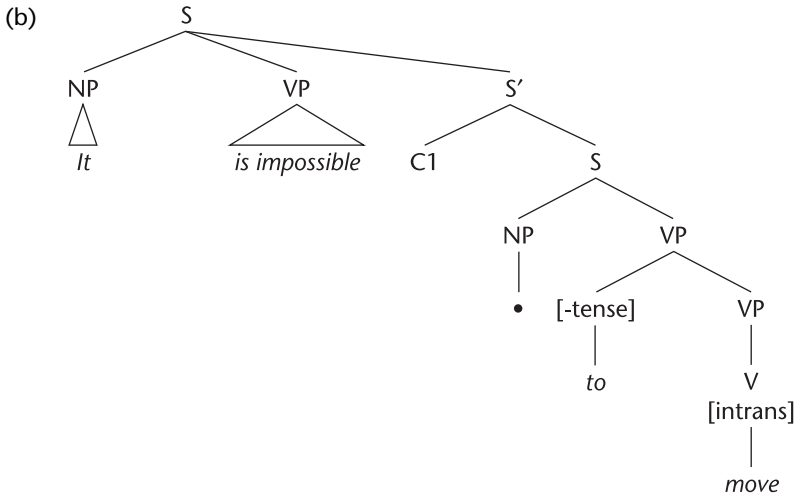

S1: Finite, main.

S2: Non-finite (to-infinitive), complement of V (appears).

S3: Non-finite (to-infinitive), complement to A (eager).

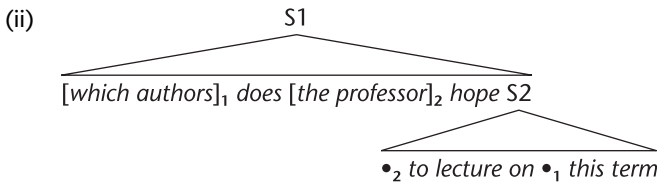

S1: Finite Wh-interrogative, main.

S2: Non-finite (to-infinitive), complement of V (hope).

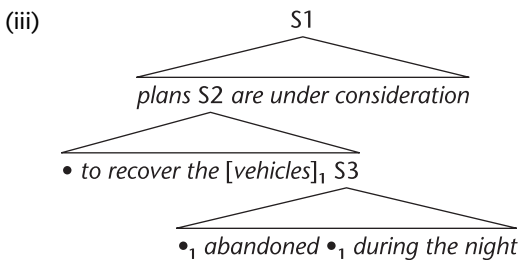

- S1: Finite, main.
- S2: Non-finite (*to*-infinitive), complement to N (*plans*).
- S3: Non-finite (passive participle) relative, modifier of NOM (*vehicles*).

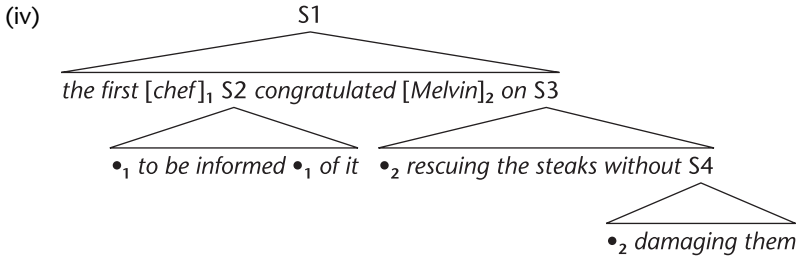

- S1: Finite, main.
- S2: Non-finite (*to*-infinitive) relative, modifier of NOM (*chef*).
- S3: Non-finite (*-ing* participle), complement of P (*on*).
- S4: Non-finite (*-ing* participle), complement of P (*without*).

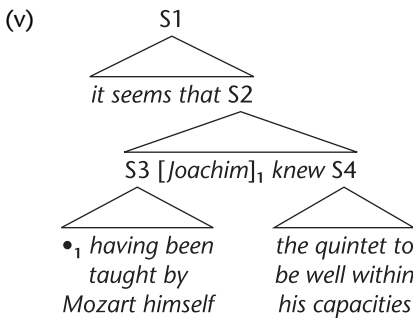

- S1: Finite, main.
- S2: Finite, extraposed subject.
- S3: Non-finite (*-ing* participle), adverbial.
- S4: Non-finite (*to*-infinitive), complement of V (*knew*).

Further exercises

1. Draw Abbreviated Clausal Analyses (with the information asked for in Exercise 3 above) for the following. (c), by the way, is a definition of what it is to mangle. With eight clauses, (f) is ridiculously complex, but it *is* the very last.
 - (a) Who did Sarah try to tell what to say?
 - (b) Tutors can decide whether to insist on these distinctions being respected.
 - (c) Malingering is pretending to be ill with the intention of avoiding work.

- (d) Virginia is reluctant to ask any of the players which court it made them most nervous playing on.
- (e) Don't you remember suggesting that any circus staff caught allowing animals on the trapeze should be fired?
- (f) The invitation to attend the ball sent to Cinderella at her stepmother's address was intercepted by her ugly sisters, who were anxious not to be outshone in beauty while dancing and to have the washing-up done in their absence.

Note: Readers who feel confident with the material in this chapter and who have lots of time and paper to spare could amuse themselves by drawing complete phrase markers for some or all of these.

2. Draw phrase markers for each of the interpretations of the following ambiguous sentences. In (d) and (e), the differences are a matter of indexing only.

- (a) Richard has plans to leave.
- (b) I saw the boy studying in the library. (Three possibilities)
- (c) Flying planes can be dangerous.
- (d) The chicken is ready to eat.
- (e) Max thought Jim too old to play.

Note. In respect of (e), assume there are three levels of AP structure: AP, ADJ, and A, (parallel to NP, NOM, and N) and that *too* pre-modifies ADJ (*old to play*).

3. In the light of the section 'Complement of A in AP' above, explain the ungrammaticality of **John is impossible to sleep*.

4. Draw phrase markers for the following, paying special attention to indexing. To bring out the intricate differences between the examples, assign indexes to all NPs, including the pronoun *them*. Where *them* cannot be co-indexed with another NP, can you explain why it cannot? It will help if you consider what small change to that object NP would be required to allow (indeed force) it to be co-indexed with another NP.

- (a) I wonder who the men expected to see.
- (b) I wonder who the men expected to see them.
- (c) I wonder how the men expected to see them.

5. The difference between Type I and Type II verbs manifests itself in more ways than were discussed in the text. Compare, for example, the following three (a)–(b) pairs. Discuss precisely how the difference in interpretation (and acceptability) between the (a)s and (b)s further illustrates the distinction. Try this out with other verbs.

- (1a) (i) Sarah believed Dr. Fernandez to have treated Paul.
- (ii) Sarah believed Paul to have been treated by Dr. Fernandez.
- (1b) (i) Sarah persuaded Dr. Fernandez to treat Paul.
- (ii) Sarah persuaded Paul to be treated by Dr. Fernandez.
- (2a) (i) She wanted her colleagues to trust Paul.
- (ii) She wanted Paul to be trusted by her colleagues.
- (2b) (i) She encouraged her colleagues to trust Paul.
- (ii) *!She encouraged Paul to be trusted by her colleagues.
- (3a) (i) She expected all trainees to crush the garlic really well.
- (ii) She expected the garlic to be crushed really well by all trainees.
- (3b) (i) She reminded all trainees to crush the garlic really well.
- (ii) *!She reminded the garlic to be crushed really well by all trainees.

11

Languages, sentences and grammars

This concluding chapter is concerned with the general background to, and ultimate purpose of, the kind of analysis you've encountered in previous chapters, rather than with extending that analysis.

Languages

I'll begin by considering a very general question:

[1] What is a language?

How do you begin to think about this? The question seems so general as to be almost empty of content. How one goes about answering such a question depends very much on one's reasons for asking it in the first place. It would not be far from the truth to say that one could really understand the question only in the light of particular answers to it. Different thinkers about language have answered it in their different ways and, in doing so, have given the question a different significance.

A natural answer often given is

[2] A language is a system of communication.

Expanding that answer (deciding e.g. what we meant by 'system' and 'communication', and what it is about the system that permits communication) and exploring its implications would open up one avenue of thought about language, and a perfectly valid one. But other answers are possible. My purpose in considering the question in [1] is to raise certain questions about the kind of analysis encountered in previous chapters, and to put it in context. To do this, I'll consider the following answer:

[3] A language is a set of sentences.

It would be understandable if at this stage you felt that this was a rather dry, unappealing answer to our question, one that fails to do justice to any sense of the wonder of language. I hope by the end of this chapter to show that this

answer – when its implications are properly teased out – does do justice to the wonder of language. It was Noam Chomsky (Massachusetts Institute of Technology) who early in his career suggested that thinking of a language in this way (as a set of sentences) opened up a fruitful avenue of thought on the nature of language, more interesting and accurate than any other idea around at the time. Taken alone and out of context it makes little sense. But answers like that are just beginnings: we have to ask what [3] means, what its implications are for how languages are to be described, what further questions it raises. In fact, the further questions raised by [3] have had a profound effect on the development of language study over the last sixty years or so.

Before considering these, however, we need to compare this account with what is perhaps a more common idea of what a language is. If a language really is a set of sentences, it follows that **different languages are distinguished by being made up of different sets of sentences**. Two people will speak exactly the same language if (and only if) the set of sentences in each of their languages are exactly the same. A consequence of this is that, almost certainly, no two people speak exactly the same language.

By way of illustration of this, consider again [4]:

[4] Max put his bike in the garage and Bill did so in his bedroom.

If I had inadvertently said this, I would consider it a mistake on my part and, given the opportunity, I would want to correct myself. So, for me, [4] is not a (grammatical) sentence of my language, even though I find it perfectly understandable. In fact, there is a measure of agreement among English speakers that [4] is not a sentence of their language. But suppose we do find someone who could use [4] without any feeling that there is something wrong with it. Then, for that person, [4] *is* a sentence of his or her language. Now, if a language is a set of sentences, that person and I must be said to speak slightly different languages, different to the extent that the set of (grammatical) sentences that constitutes his or her language includes [4] whereas the set of sentences that constitutes my language excludes [4].

When I say that this other speaker and I speak ‘slightly’ different languages, I’m assuming for the purposes of the discussion that she and I agree about the other sentences mentioned in this book, disagreeing only about this sentence [4]. But wait a moment. If all the (grammatical) sentences mentioned in this book are sentences of this other speaker’s language, doesn’t that mean that this other speaker speaks what is known as *English*? And don’t I, as author of this book, speak English too? And English, after all, is a language. Surely, then, we speak the *same* language.

This appears to contradict the idea that a language is a set of sentences and that particular languages are distinguished by consisting of different sets of sentences. English is normally regarded as a language, yet by the definition of a

language given in [3], speakers of English are characterised as speaking more or less different languages. Do speakers of English speak the same language or don't they?

This last question is really a matter for us to decide, because it amounts to this: should we use the expression 'a language' in a way that allows us to say that English is a language, the common language of its speakers (this is a decision to abandon [3]), or should we use that expression in a way that obliges us to say that strictly speaking, English is not a language itself, but a gigantic collection of largely overlapping languages? Answer [3] encourages this second use – and is arguably closer to the facts of the matter.

There is nothing to stop us using the expression 'a language' in both of these ways. In fact, we normally do use it in both ways. It depends on the context. Clearly, by comparison with French (or, the huge collection of overlapping languages that go to make up what is known as French), English is an identifiable language (in the first sense above), absolutely distinct from the French language. But within what is known as English, you know as well as I that there are differences. Geordies, Glaswegians, Londoners, Californians, Belfastians, Jamaicans, Canberrans, Sidneysiders speak differently. This is not simply a matter of accent. Each and every Geordie, Glaswegian, Californian (etc.) has a language and each of these languages can be described as a set of sentences. These sets are known to differ to a greater or lesser degree. I'll give just two small examples. [5] is a grammatical sentence of the language spoken by most Geordies:

[5] You can't do it, can't you not?

but not of the languages spoken by, for example, Jamaicans, Californians, or Glaswegians. Conversely, [6]

[6] Did you eat yet?

is a grammatical sentence of the language of Californians (and most US languages) but not, for example, of Geordies, Jamaicans, or Londoners.

The discussion so far suggests that it is not in fact such a calamity to conclude that, **in one useful sense of the expression 'a language', English is not a single language but a huge collection of overlapping languages.**

There's almost no limit to the variety within English we may recognise if it suits our purpose. I've mentioned general variation associated with geographical differences. I could also have mentioned variation associated with age differences, educational, social, and political differences, and I would still have said nothing about linguistic variation across time, variation caused by the fact that languages change through the centuries. In one sense of 'a language', we, Shakespeare, Chaucer, and the Gawain poet have different languages. In another sense, it is all the same language. Amid all the variety, we cannot lose sight of the common ground, the overlap between the varieties. It is this overlap that justifies

the label ‘the English language’ (and the use of the word ‘English’ in the subtitle of this book) and it is this that enables its speakers, with more or less success, to communicate with each other.

Linguistic variation is a study in its own right (sometimes called socio-linguistics, or dialectology) and is not the topic of this book. I shall continue to assume, safely I believe, that the sentences and structures analysed in this book fall within the common ground, forming a central part of the language of its readers. Let’s now consider some more specific consequences of [3] for the description of languages.

Describing languages

If a language is a set of sentences, then the job of describing a language consists in indicating, for every sequence of words, whether or not that sequence counts as a grammatical sentence of the language.

The idea that a language is a set of sentences suggests to many people encountering it for the first time that you should be able to gather all the sentences of a language together, make a list of them, and say ‘This is the complete language’. And certainly, if you could make a list of all the sentences of a language, [3] suggests a very easy way to go about *describing* a language: to give a fully explicit and comprehensive description of a language, all that’s required is to draw up such a list, one that includes all the word sequences that are grammatical sentences of the language and excludes all word sequences that are not.

Imagine, if you can, a language in which there are just ten sentences. We could call this language ‘Justen’. If a language is a set of sentences, we have only to list those ten sentences in order to have an explicit and comprehensive description of Justen. By consulting that list we would be able to tell immediately what was, and what was not, Justen.

How realistic is this? Can you imagine a language in which you could say just ten things? I doubt whether such a ‘language’ properly deserves the name. ‘Code’ would be a more appropriate description. So, that account of what a language is works well enough for Justen, but Justen is altogether unreal. Should we, then, reject that account?

Well, if you share the feeling that [3], as a definition of what a language is, makes it appear as though all languages are as simple as Justen, then you probably do want to reject it. This is probably because the definition suggests to you that a language has to be a fairly small set of sentences, small enough at least to make a list of and put a number on. But there is nothing in the idea that a language is a set of sentences to suggest that it has to have *any* limit on it. A set of things can be indefinitely large. Indeed, there is no reason why a set of things should even be finite. For example, numbers form a set of things, and this set is

infinite: there is no largest number. What about the set of sentences that form a language?

We have agreed that Justen is unreal. But how unreal is it? If your language does not contain just ten sentences, how many does it contain? Five hundred? Five thousand? Five million . . . ? Could you, in fact, put a number on it?

In asking this, I am not asking how many sentences you have actually used and understood so far in your life. Nor am I asking how many you will have used and understood by the time you die. These are questions, not about your *language as such*, but about your *use of language*. We are concerned with your language, not the use you happen to make of it. So **the question concerns the number of word sequences that you would accept as being sentences of your language, available for your use whether or not you actually get to make use of them.** Now, if what we are concerned with is not the number you will actually use in your lifetime but the number that are in principle *available* for use, we come closest to the truth in saying that **you speak an infinite language.**

There are well-known ways of demonstrating this. Take, for example, a single word of your language, the word *and*. We can be perfectly confident that Justen does not include any word having the same function as *and*. How can we be so sure of this? Adding this one word to that ten-sentence language changes it, at a stroke, into an infinite language. One of the functions of *and* is to join any two or more sentences together to form another, co-ordinate, sentence. Say we number the sentences of the original Justen, S1 to S10. With the addition of *and* a whole new language opens up, one that includes the following four sentences:

- (i) [S1 and S2]
- (ii) [S1, S2, and S3]
- (iii) [[S1 and S2] and S5]
- (iv) [[S1 and S2], [S6 and S3], and S8]

and an infinity of further sentences.

Your language includes *and*. There is no sentence of which you could say, 'This is the longest sentence in my language'. For any sentence that you care to think of, however long, it is always possible to create another, longer, sentence by co-ordinating a further clause within it.

And is not the only device that allows you to elaborate the length and complexity of your sentences. Another, encountered in Chapter 9, is the relative clause. Think of the nursery rhyme 'This is the house that Jack built'. Here's the last sentence: *This is the farmer sowing his corn that kept the cock that crowed in the morn that woke the priest all shaven and shorn that married the man all tattered and torn that kissed the maiden all forlorn that milked the cow with the crumpled horn that tossed the dog that chased the cat that killed the rat that*

ate the malt that lay in the house that Jack built. Each new sentence is created by subordinating the previous sentence as a relative clause functioning as a modifier in a newly-introduced NP. This could go on for ever. The fact that it doesn't go on longer has nothing to do with the language itself but with factors affecting the *use* of language: boredom, exhaustion, hunger and, finally, mortality.

Before I continue, let me summarise the last two most important points. (1) In contrast to the artificial example of Justen, *natural* languages (the languages which, in the words of the phrase, we learn at our mother's knee) are *infinite*. (2) The infinity of natural languages in no way conflicts with the idea that a language is a set of sentences; sets can be infinite and a language can be defined as an infinite set of sentences.

Describing infinite languages

But now we have a new question and it is this:

[7] How do you describe an infinite set of sentences (an infinite language)?

Clearly, we must abandon the idea of listing. Just as you cannot list an infinity of numbers, so you cannot list an infinity of sentences. [7] is perhaps *the* important question posed by [3]. By suggesting we think of a language as a set of *sentences*, Chomsky was implicitly questioning an influential view of language proposed in the late nineteenth century by the great Swiss linguist Ferdinand de Saussure. Saussure readily recognised it was impossible to list the sentences of a person's language. He therefore limited the notion of a language (*langue*) to those expressions that *could* be finitely listed – morphemes, words, fixed phrases, idioms. Sentences were excluded as pertaining, not to the language as such, but to a person's particular *use* of language (*parole*). Chomsky, in focusing on sentences, encourages us to see the enterprise of describing a person's language as the enterprise of describing and explaining a mental *capacity*, the capacity to utter/understand an infinity of sentences (which he calls linguistic 'competence') – something Saussure, for all his insights, had less to say about. It is in this sense – by forcing us to concentrate on a person's capacity to speak an infinite language and on how that capacity is acquired – that [3] does seem to address the real wonder of language. [3] forces us to state explicitly which are the grammatical sentences of the language and which are not, and do this for an infinity of sentences and non-sentences. Since listing is out, [3] encourages us to find an alternative principle on which to base our description.

We can approach this alternative by comparing the two artificial languages considered above, Justen and the language that consists of the ten sentences of Justen augmented by *and*. We can call this second language 'Justenand'. I've shown that nothing is easier than the complete description of Justen: because

it is a finite language, we merely list its ten sentences. But we can't do this for Justenand. Before reading further, ask yourself whether it is possible to give a complete description of Justenand and, if so, how you would go about doing so. Remember, in asking for a complete description of Justenand, I want to know categorically, for any sequence I care to think of, whether it is a sentence of the language or not.

If you have thought about this, you will have realised that Justenand, infinite though it is, is still a very rudimentary language. It is not only possible to describe this language in its entirety, it is not even very difficult. The description will fall into two parts. The first part must be the original list of ten sentences. To account for the infinity of other sentences which have become possibilities by the addition of *and*, something different is required. What we need, for the second part, is an *explicit statement* to the effect that **a sentence of Justenand may consist of any two or more sentences of Justen joined by *and***. This statement tell us that, given that S1, S2, and S3 are sentences of Justen, (i) and (ii) above are also sentences, having the form

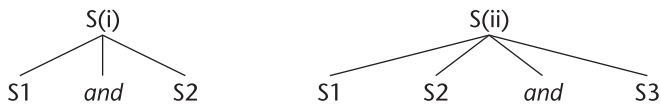

And, since S(i) has just been admitted as a sentence of Justenand (and S5 is listed) we know, by the same token, that (iii) is one too:

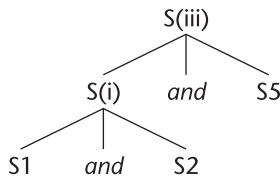

and so on *ad infinitum*. Notice that, from the explicit statement in bold above, we not only derive the information that (iii) is indeed a sentence of Justenand, but are given a clue as to how to analyse that sentence. The statement automatically implies a partial description of S(iii).

By means of the statement in the second part of the description, we have given a complete description of Justenand without resorting to an infinite and hence uncompletable list. We have, in fact, provided a finite description of an infinite set of sentences. Although a list is included in the full description (and it is this list that makes Justenand hardly less artificial than Justen), that list has been supplemented by something quite different, namely a *rule*. For that is what the above statement is, a rule for forming the infinity of Justenand sentences. **It is by means of rules that we can give finite descriptions of infinite sets of sentences.**

This difference between list and rule is of central importance in language study. The very idea of 'sentence' as you and I understand it is bound up with

the notion of ‘rule’. To see this, think about Justen again. This toy language is probably more different from your own language than you realise. In particular, it is not even clear that what we have been calling its ‘sentences’ bear any relation at all to the things that you call sentences in your language. In explanation, remember that, since Justen is a finite ‘language’, it is actually possible to identify its ‘sentences’ by numbers. Indeed, the speakers of this so-called language could themselves identify their ten sentences by number. The only problem with this idea is that whereas numbers are infinite, Justen has only ten sentences. But, if it is unlikely that numbers would be used, there is nothing to prevent these speakers having *names* for their ten sentences. S1 could be *Oink*, S2 *Woops*, S3 *Umph*, S4 *Whack*, and so on.

Do you see, then, how different Justen is from your language? Names are *simple* words. They don’t have syntactic structure. In other words, a language that could consist of names alone has no need of, indeed cannot be said to have, hierarchical structure, syntactic categories, or syntactic functions. In a word, it would have no syntax. The very distinction between ‘sentence’ and ‘word’ is meaningless for Justen. Rules would have no part to play in the description of such a language. Not only can we list the ‘sentences’ of this language, we *must* list them if we want to describe it.

By contrast, sentence-listing plays no part either in the description of your language or in the way you use that language. You don’t have a list of ready-made sentences in your head. If you did, the language would have to be finite; your head, after all, has a finite capacity. Furthermore, if you could hold them all in your head, as pre-packaged sentences, there would be no need for them to be complex, i.e. there would be no need for them to have structure. If knowing a natural language could be a matter of remembering sentences as such, why bother with *complex* things like sentences at all? It would be easier to remember simple names, and more efficient.¹

Instead, you have to construct your sentences as and when the need arises. And it is the fact that you do construct sentences on the spot that enables you to utter any of an infinite number of sentences, appropriate to an infinite variety of situations. Knowing a natural language, then, does not consist in having an inventory of sentences in your head, but in knowing *how* to construct the sentences. But, and this is the important point, in order to know how to construct the grammatical sentences of a natural language, you have to know in very general terms what counts as a grammatical sentence of the language.

When it comes to describing languages, we can take our cue from this. Our ultimate task in describing a language is still to specify what the grammatical sentences of the language are. But we cannot expect to do this directly. What we

¹ Jorge Luis Borges, in ‘Funes the Memorious’ (*Labyrinths*, Penguin) wrote an interesting story on the effects of an infallible memory on a person’s language.

can and must do is specify what it is that *makes* a sequence of words grammatical or ungrammatical. This amounts to saying that, **in order to describe a particular language, you have to give a general definition of the concept ‘grammatical sentence’ for that language.** It is by reference to this general definition that we can state, for each of an infinity of word-sequences, whether it is a grammatical sentence or not. This will be done, not by consulting a sentence-list, but by *prediction*. The general definition forces us to make predictions about word-sequences we had never even thought about or encountered before. This in turn means that, in describing an infinite language, we cannot say that a particular sequence of words is not a grammatical sentence of the language without simultaneously *explaining* why it isn’t.

This was not done for Justen. In listing the ‘grammatical sentences’ of Justen, we did not define what it was for something to be a Justen sentence. This, as we saw, was not necessary. In fact, it is not even possible. The idea of ‘knowing how to construct a sentence’ is completely inappropriate in the context of Justen. In the first place, you can only *construct* something if that thing is *complex*, has structure. But the sentences of Justen are perfectly simple. In the second place, you can only ‘know how to construct’ the things in a set by knowing general principles that apply to them. And this entails knowing not only what distinguishes them from each other but what they have in common. But only complex things (things that have parts) can have something in common and yet be different. Totally simple things can only be absolutely the same (identical) or absolutely different.

If an English-speaking ‘speaker’ of Justen were to point out that we had overlooked the existence of an eleventh ‘sentence’, all we could do would be to shrug our shoulders and add it to the list. We would have learnt nothing more about what it was to be a Justen sentence. There is no way we could have predicted or explained its existence because we have no general idea – no general definition – of what counts as a Justen sentence in the first place.

We have a better general idea of what counts as a Justenand sentence, though, and this is expressed in the general statement (the rule) that formed the second part of its description. That rule gives a partial definition of what it is for something to be a grammatical sentence of Justenand. It is only partial, since we still don’t have any definition that covers the original ten sentences.

Grammars

At the risk of repetitiveness, I shall summarise what seems to have emerged so far. The discussion of Justen is neatly summarised in the following statement:

[8] A finite language is its own grammar.

I've not used the term 'grammar' before in this chapter. Instead, I have talked about language description. But this is what a grammar is, the description of a language. In the terms established so far, then, **the function of the grammar of a language is to specify which word sequences are, and which are not, in the infinite set of its sentences.**

Justen illustrates [8] as follows: If a language is a set of sentences, then Justen *is* exactly those ten 'sentences.' A grammar describes a language. But, as we have seen, the grammar of Justen *is* the list of those ten sentences. The ten sentences of Justen, then, constitute both the grammar itself and the language itself. It is in this sense that Justen, being a finite language, is its own grammar.

It's an odd sort of grammar, though, that doesn't specify any kind of syntax for its language, one far removed from our ordinary conception of what a grammar is. And this is pretty well what is said in [8]. Essentially, there is no real grammar of Justen. In view of our conclusion that Justen cannot seriously be considered as a language, this is not surprising.

By contrast, the discussion of natural languages and their grammars can be summarised as follows.

- (a) A natural language is an *infinite* set of sentences.
- (b) The description of a language (the *grammar* of a language) states which are, and which are not, in the infinite set of its sentences.
- (c) It is the *complexity* of natural language sentences (the fact that they have structure) that makes it possible to construct an *infinity* of sentences, and it is the infinity of natural languages that makes a *general definition* of 'sentence' necessary in order to achieve what is described in (b) above.
- (d) Equally, it is the fact that the sentences of a natural language are complex that allows each different sentence to have more or less *in common with* every other different sentence.
- (e) And it is the fact that the sentences of a language do have more or less in common with every other different sentence that makes it possible to state *general principles* (to *formulate rules*) about them.
- (f) The *complexity* of natural language sentences, then, makes a general definition of 'sentence' both possible and necessary.
- (g) In conclusion, the ideal envisioned here is that a grammar is the description of a language by means of a **general definition of 'sentence'** in that language. The definition takes the form of a set of rules. It has two interrelated functions: (i) it admits (or defines) as a sentence whatever conforms to the rules, excluding whatever does not, and (ii) gives a structural description of whatever it admits as a sentence. These are connected, for the grammar admits a sentence only in virtue of assigning a structural description to it. Furthermore, by reference to the general definition of sentence embodied in the

grammar, we can expect to derive explanations of the ungrammaticality of non-sentences.

I alluded earlier to the idea that the enterprise of describing a language is the enterprise of describing *a mental capacity*. Chomsky's suggestion is that this internal capacity is constituted by a grammar. In 'knowing' (or having) a language, a speaker 'knows' (or has) an internal grammar, a set of rules constituting the definition of 'sentence' in that language. And when we, as linguists, attempt to describe a language, we are attempting to model the speaker's knowledge of language by formulating a grammar that corresponds as closely as possible to the mind-internal grammar of the speaker of that language. (It is actually slightly misleading to talk just of '*speakers* of a language' here. '*Possessors* of a language' would be better, since it is possible – and in fact not uncommon – to have a language without being able actually to speak it. Stroke victims and victims of total paralysis are an example.)

The main thrust behind Chomsky's thinking here is that language (and thus the notion of 'sentence' defined by the grammar) is a wholly mental (internal) phenomenon. It does not exist externally to or independently of internal 'knowledge' of it. This is all very abstract, so I shall give a concrete illustration of what is at issue here. Further Exercise 4 of Chapter 10 invited the reader to consider the differences between three sentences, two of which I represent here.

[9] I wonder who the men expected to see them.

[10] I wonder how the men expected to see them.

The two sentences are radically different. You can get an idea of the difference by asking yourself whether *them* can refer to *the men* or not. Having satisfied yourself as to the differences, reflect on this. This book has been concerned with what is involved in the analysis of sentences. Now, a common view of sentences is that they are the sort of (mind-external) thing you can actually see on the page (a view implied by regarding sentences as things that begin with a capital letter and end with a full stop). As a possessor of the language, you know just how different the relevant sentences are. But look at [9] and [10] again. What difference between [9] and [10] is actually there to be *SEEN*? Hardly anything. Simply, the letter *w* has hopped over the *h* and the *o*. That simple visible difference can hardly be held responsible for the intricate interpretative differences between the two sentences. The linguistic difference does not consist in the difference in position of the letter *w*. Someone capable only of identifying that typographical difference could stare at those letter sequences for ever without forming the merest idea of the *linguistic* (grammatical) differences so important to you as a possessor of the language.

The point I am drawing your attention to here is simply this. The external, visible, difference between [9] and [10] is exhaustively described by saying that

the letter *w* is the eighth letter in [9] but the tenth letter in [10]. Since this statement, although entirely accurate, completely fails even to touch on the crucial *linguistic* differences between two sentences of your language, we must conclude that in analysing linguistic expressions such as sentences, we are not analysing anything that is there to be seen on the page. Indeed, we are not analysing anything that is external to your mentally constituted possession of the language. In considering the *linguistic* differences, you looked inwards and consulted your mentally constituted grammar.

A caveat is in order here. You need to bear in mind that, when Chomsky suggests that language does not exist externally to or independently of internal ‘knowledge’ of it, he is emphatically *not* saying that language (or linguistic expressions such as sentences) is in any sense unreal. Quite the contrary. Linguistic expressions (the grammars in terms of which they are defined) are real enough, believe me: the linguistic difference (i.e. the internally constituted ‘knowledge’ of the difference) between *Flick the switch or the bomb will explode* and *Flick the switch and the bomb will explode* might one day have the very real effect of saving your life.

Grammars and sentence analysis

How do these very general considerations relate to the analyses discussed in previous chapters? You might be forgiven if at some point in your reading of those chapters you had asked yourself whether phrase markers were the be-all-and-end-all of syntax. You might be forgiven for thinking, ‘OK, so now I know how to draw a plausible phrase marker. Where do we go from here?’

We have seen what phrase markers can do. They provide explicit descriptions of sentences in terms of category, function, and constituency. Descriptions of sentences, whether given in the form of phrase markers or some equivalent notation (e.g. labelled brackets), are an important part of language-description. They are not the whole story. Your reading of this chapter should have given you an idea of what phrase markers, in themselves, cannot do.

For example, you know that [11] does not represent a (grammatical) sentence of your language.

[11] *Stream a beside sunbathed Sam.

Nothing I have said so far in this book, however, prevents us assigning it a phrase marker, [12] for example:

[12]

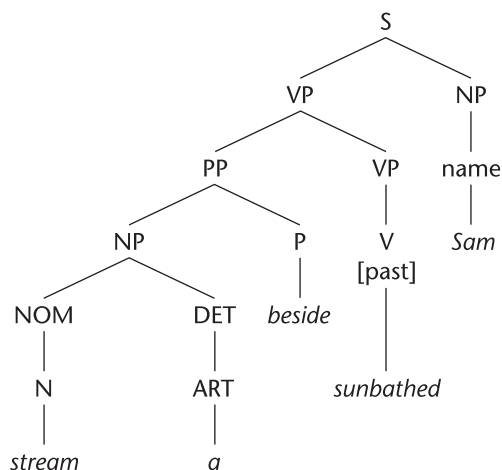

In fact, there is nothing that obliges us to give it that phrase marker even.

I have suggested that, to describe a natural language, a definition is required of what it is to be a (grammatical) sentence of the language. And I have suggested that such a definition would, automatically and simultaneously, predict which are the grammatical sentences and which are not, describe the grammatical sentences, and explain the non-sentences. In other words, if you wish to predict that [11] is not a grammatical S in your language, nor *Stream a beside sunbathed* a grammatical VP, nor *stream a beside* a grammatical PP, nor *stream a* a grammatical NP, you must explain why not and, in order to explain why not, you must describe (by means of rules) what does count as a grammatical S, VP, PP, NP . . . in your language.

While phrase markers *describe* sentences, they don't, in themselves, give an indication of what it is to be a sentence; hence they do not, in themselves, make any *predictions*, or give any *explanations*. Ultimately, then, we must make the connection between the phrase markers on the one hand and, on the other, the *rules* that constitute the definition of what it is to be a grammatical sentence.

This is a natural connection to make. It is clear from the discussion of this chapter that the rules of the grammar must be expressed in terms of syntactic categories and how they are structured into sentences. After all, it is the complexity of natural language sentences (i.e. all that we understand by their having structure) that makes such rules both possible and necessary. And the descriptions given in previous chapters are expressed in phrase markers in just these terms. This suggests that the rules should be formulated in such a way that they, in some sense, create phrase markers as their descriptions of sentences, so that, in admitting a sequence of words as a grammatical sentence, the rules assign it a descriptive phrase marker.

Phrase markers, in themselves, then, are just a beginning. A variety of questions now present themselves. The most general and obvious one is: What are

the rules governing the construction of phrase markers? But there are others, among them: What are the best rules? And what counts as ‘best’ in this context? Given that the rules will be formulated in terms of syntactic categories, what syntactic categories do we need to recognise? Can everything we want to say about sentences be expressed in phrase markers? Can everything we want to say about each sentence be expressed in a single phrase marker?

Of course, it will have occurred to you that, although no explicit mention was made of rules in the preceding chapters, the analyses suggested there are not just arbitrary; in suggesting them, I have been guided *implicitly* by general principles. In asking ‘What are the rules?’, then, we are concerned with laying bare those general principles, with making them fully *explicit*, and with whether those are the best general principles available.

Such questions, and the thinking that leads up to them, open up the prospect of a rich and extremely ambitious method of language description. When a grammar is conceived of in the terms outlined in this chapter, it is called a generative grammar. In giving a general definition of ‘sentence’ for a language, the grammar is said to ‘generate’ the sentences of that language. In the Further Reading section that follows, I briefly discuss more detailed introductions to the enterprise of generative grammar. Here I have been concerned to give an idea of the kind of thinking that gives rise to that enterprise, and to place the phrase marker descriptions within a more general context. Of course, a conclusion that consists of questions like those above is something of a cliff-hanger. If you feel this, I have at least succeeded in whetting your appetite.

Finally, why bother? Why is it so important to formulate the rules of natural languages in a fully explicit manner? After all, we all speak one language or another without bother. Why not leave it at that?

There are two related answers to this. The first takes us back to comments made in the Introduction. It is precisely the fact that we all speak (and, more mysteriously, acquire) a language without bother that gives this enterprise its interest and importance. There is a sense in which you know the rules of your language. This must be so, since you are capable of making an infinite number of judgements as to what is and what is not a grammatical sentence of your language. But the sense in which you know these rules is different from the sense in which you know the rules of chess, know how to read music, make zabaglione, or drive a car. You know (and acquired) the rules of your language *implicitly*, as if by instinct. The job of the generative grammarian of a language is to describe what its speakers implicitly and instinctively know about that language; in other words, to make *explicit* what it is that speakers know in knowing their language.

Second, the discussion above might have given the impression that the grammarian first of all decides what the most appropriate descriptions of sentences are and then goes to work on the rules that govern the construction of those descriptions. It is not quite like this, however. There is no guarantee that, when

we attempt to state the rules in the best possible way and as explicitly as possible, we will not want to revise our ideas as to what the best descriptions are. Quite the opposite in fact: it is by attempting to formulate a systematic and fully explicit set of rules for a language that we can expect to gain new insights into its structure – that is, new insights into what it is that a speaker knows in knowing that language.

Further reading

There is a wide range of texts on descriptive English grammar and on linguistics in general. The following is a small selection of those appropriate as further reading in connection with the present text, which has been influenced both by a descriptive English grammar tradition and by the theoretical perspective of generative grammar.

Bas Aarts' *English Syntax and Argumentation* should be easy to follow after reading the present text. Although not exactly a textbook, Jim McCawley's monumental *The Syntactic Phenomena of English* offers an advanced, in-depth, and fascinating rummage through the language by an acute observer of it.

Apart from my assumption of some correlation between constituent structure and meaning, little has been said about meaning. This was particularly marked in the discussion of verbs. Leech's *Meaning and the English Verb*, though venerable, is an excellent short introduction.

Geoff Poole's *Syntactic Theory* is a good and not too lengthy introduction to generative syntactic theory, using mainly (but not exclusively) examples from English. For a more general but quite detailed introduction to generative linguistics, I can recommend Andrew Radford *et al.*'s *Linguistics: an Introduction*.

There are two reference grammars that should be mentioned. Quirk *et al.*'s *A Comprehensive Grammar of the English Language* is a standard reference work on descriptive English grammar, offering a wealth of detail on the structures mentioned here and lots more besides. The verb sub-categorisation of my Chapter 4 is based on theirs. A more recent (and even bigger) reference grammar, and one more explicitly informed by generative grammar, is Rodney Huddleston and Geoff Pullum's *The Cambridge Grammar of the English Language*. These are not textbooks. Furthermore (and, unfortunately, this is something that pervades descriptive English grammar) they differ in their terminology, both from each other and from the present text.

More generally, I can recommend Stephen Pinker's *The Language Instinct*, which is entertaining and intriguing. On Chomsky's conception of language, I recommend Neil Smith's *Chomsky: Ideas and ideals*. Of Chomsky's own work, *The Architecture of Language* is short and accessible. Only slightly longer is his *On Nature and Language*.

AARTS, B. (2008) *English Syntax and Argumentation*. 3rd edition. Palgrave Publishers.

CHOMSKY, N. (2000) *The Architecture of Language*. Oxford University Press.

CHOMSKY, N. (2002) *On Nature and Language*. Cambridge University Press.

HUDDLESTON, R. AND PULLUM, G. (2002) *The Cambridge Grammar of the English Language*. Cambridge University Press.

LEECH, G. (1971) *Meaning and the English Verb*. Longman.

MCCAWLEY, J. (1998) *The Syntactic Phenomena of English*. Chicago University Press.

FURTHER READING

PINKER, S. (1994) *The Language Instinct*. Penguin.

POOLE, G. (2010) *Syntactic Theory*. 2nd edition. Palgrave Publishers.

QUIRK, R., S. GREENBAUM, G. LEECH, and J. SVARTVIK (1985) *A Comprehensive Grammar of the English Language*. Longman.

RADFORD, A., ATKINSON, M., BRITAIN, D., CLAHSN, H., AND SPENCER, A. (1999) *Linguistics: an Introduction*. Cambridge University Press.

SMITH, N. (1999) *Chomsky: Ideas and ideals*. Cambridge University Press.

Index

- a/an* *see* indefinite article
- abbreviated clausal analysis (ACA) 172–3
- abstract noun 182–3
- acceptability 97
see also grammaticality
- accusative *see* objective case
- active voice 119
- active vs. passive sentences
- adjective (A) 54–5
characteristic endings 54
comparative and superlative 54
complement of, within AP 181–2, 233–4
co-ordinate 60–1
gradable 54–5, 68, 147, 148
non-gradable 54–5
quantifying 146–7
- adjective phrase (AP) ix, 55–6, 60, 146
complement of A in 181–2, 233–4
as complement of intensive verb 74, 75
as post-modifier 154–5
- adjunct adverbial 87–93, 98
vs. complement 89–90, 91–2, 167–8
discussion of in-text exercises 101–2
exercises 103–10
mobility of 92–3
as modifier 88–9, 98
relative clause as 207
see also VP-adverbial
- adverb (Adv) 88
degree (DEG) 54–5, 56, 147, 200
general 56
- adverb phrase (AdvP)
as adjunct adverbial 87–8, 100
wh-expressions and 201
- adverbial ix
and auxiliary verb 122, 123–5
see also adjunct adverbial; sentence
adverbial; VP-adverbial
- conjunct xii, 98, 100
- disjunct 98–9
- as function 88
- non-finite clause as 234–5
by-phrase as 126
- adverbial clause 186–7
- after* ix–x, 185, 187
- agent 241
- agreement *see* subject-verb agreement
- although* 187
- ambiguity 18, 23, 39–40, 41, 77, 86, 94, 95,
152, 223
- and* 258, 259–60, 262
- appear* 181
- appositive clause *see* non-restrictive relative
clause
- article (ART) 142
definite (*the*) 142, 210
indefinite (*a/an*) 49, 142
- as if* 187
- ask* 230–1, 237, 238
- asterisk 7, 11
- auxiliary-fronting 130–1, 175, 176,
197–201, 202
- auxiliary verb ix
and adverbial 122, 123–5
constructions that depend on 125–32
discussion of in-text exercises 133–4
exercises, 135–40
finite vs. non-finite 113–14
vs. lexical verb 67, 111–25
modal (MOD) 111, 115–16, 118, 119, 226–7
in negative sentences 128–30
passive (PASS) 119–21
in passive sentences 125–8
perfect (PERF) 116–18, 119
primary 111
progressive (PROG) 118–19, 124–5
in questions 130–1
and structure of VP 121–5
tensed 112–14, 115–19, 120, 128–9, 130–1
- bare infinitive verbs 226
- be* 67, 11, 117

- be* (*cont'd*)
 always behaves as an auxiliary, 132
 as copula 74, 118–19, 181, 200, 238
 as passive auxiliary 119–21, 126
 as progressive auxiliary 118–19, 120,
 124–5, 229
- because* 186
- before* ix–x, 185, 187
- brackets, labelled 172–3, 265
- C1 and C2 *see* complementiser positions
- case
 objective (accusative) 70–1, 72, 200, 230,
 240–1
 subjective (nominative) 70–1
- category 6, 8, 10, 46–66
 co-ordinate phrase 57–62
 diagrams for in-text exercises 62
 exercises 62–6
 and function 29–31
 lexical vs. phrasal 47, 50–4
 recursive 149–50
 words can belong to more than one 68
see also specific categories
- Chomsky, Noam 255, 259, 264
- clausal subject 176–8
- clause
 abbreviated clausal analysis 172–3
 adverbial 186–7
 as complement 179–86, 204–7, 233–4,
 235, 236–44
 interrogative 175–6, 230–1
 lexical verb essential to 172
 main 172–3
 and non-finite verb 225–9
 superordinate vs. subordinate 172
see also non-finite clause; subordinate
 clause; *that*-clause; *wh*-clause;
whether-clause
- co-indexing 225
- common noun 48–9
- comparative 54
- complement ix
 of A 181–2, 233–4
 vs. adjunct adverbial 89–90, 91–2, 167–8
 clausal 179–86, 204–7, 233–4, 235,
 236–44
 head-complement relation 35–8, 69
 vs. modifier 69, 87, 91
 in modifying AP 154–5
 of N 182–4, 204–7, 235
 of P 184–6, 234
 of V 68–80, 96, 121, 179–81, 236–44
 VP as ix, 121–2, 141
- complementiser 130–1, 174
after, *until*, *before* and *since* as? 185
 and ellipsis 174–5
for 230
 and fronted auxiliary 175
 and non-finite clause 229–32
 overt 240
 subordinating conjunction 186–7
that and *whether* 174–86
- complementiser positions x
 C1 x, 198–200, 201, 203, 205, 208,
 229–30
 C2 x, 198–200, 201, 202, 203, 204, 205,
 208, 230–2
- complex sentence 24–8, 171–2
- complex transitive verb 76–8, 79, 127–8
- complexity 6, 7, 262, 263
- compound noun 148
- compound sentence 171–2
- conditional adverbial clause 186
- conjunct adverbial xii, 98, 100
- conjunction
and 258, 259–60, 262
 subordinating ix–x, 186–7, 199, 235
- constituent 6, 7–10
 in co-ordinate phrase 60
 establishing 10–18
 exercises 19–23
 and function 24–8
 immediate 7–9
 sisters 31–2
- constituent question xiii, 196
see also wh-question
- context 96–8
- controlled vs. free 225, 231, 232, 233
- co-ordinate sentence 171–2
- co-ordination (co-ordinate phrase) 57–62
 lexical vs. phrasal 61
- co-ordinator 58
- copula *be* 74, 118–19, 181, 200, 238
- count noun 49, 143
- covert subject 224–5, 230, 231–2, 233, 235,
 238, 241, 242–3
see also overt subject

- dare* 237
 daughter 31
 definite article 142, 210
 definite pronoun 50, 143
 definiteness 143
 degree adverb (DEG) 54–5, 56, 147, 200
 demonstrative (DEM) 50, 142
 dependency 14, 33, 69
 and function 31–8
 one-way 33, 35–6
 two-way 35–6, 37
 determiner (DET) 141–4
 empty 143, 145, 147
 possessive 143–4, 235
 pre-determiner ix, 145–6
 pronoun as 156
 vs. quantifying adjective 146–7
 wh-determiner 197
 direct object 71, 72, 73, 75, 77, 95, 179–80
 disjunct adverbial 98–9
 distribution 46–7, 48
 ditransitive verb 72–3, 77, 79, 179
 effect of PASS on 128
 and ellipsis 96, 97
 and non-finite clause 237
do 67, 111, 114, 128–30, 131, 132
do so ix, 91, 108, 121, 165
 domination 17, 31, 146, 150, 169
 in *that*- and *whether*-clauses 177, 178,
 180, 181

 echo-question 201
 ellipsis 96–8, 121, 156, 174–5, 207
 ellipted head 156–7
 embedded sentence 172
 see also subordinate clause
 emphasis 130
 empty determiner 143, 145, 147
expect 243
 expletive 26–7
 it 177–8, 184, 231
 there 242
 extraposed subject (ES) 177–8, 184, 232–3

 feature
 sub-categorisation 71, 75–6
 tense feature 113
fill 111, 112, 113, 117
 finite vs. non-finite verb 112–14, 115, 117, 224

for (complementiser) 230
force 237
 free vs. controlled 225, 231, 232, 233
 Friendly Head Principle (FHP) 155
 fronting *see* auxiliary-fronting; *wh*-fronting
 function 8, 24–45
 co-ordinate phrase and 61–2
 dependency and 31–8
 exercises 38–45
 head 32–8
 modification 32–3
 noun phrase and verb phrase 29–31
 subject and predicate 24–8
 summary 38
 future time 114, 115

 gaps x, 127–8
 and relative clause 205, 208
 and *wh*-clause 197, 198, 200, 202, 203
 gender 51
 general adverb 56
 generative grammar 267
 genitive 48, 143
 see also possessive
 gerund *see ing*- participle form
give 96
 governor xii, 71
 see also head
 gradable adjective 54–5, 68, 147
 vs. participle 148
 grammar 262–8
 generative 267
 grammaticality 1–3, 7, 261–2, 266
 vs. acceptability 97

have
 -*ing* participle form 229, 234
 lexical vs. auxiliary 67, 111, 114, 116, 132
 as perfect auxiliary (PERF) 116–18, 119
 head 32, 38, 50–2
 adjective as 55
 in co-ordinate phrase 57–8
 ellipted 156–7
 Friendly Head Principle (FHP) 155
 head-complement relation 35–8, 69
 modifier-head relation 32–5
 hierarchical structure 6, 8, 16
 and auxiliaries 121–3
hope 180

- how* 87, 196, 200, 201
see also wh-question
- idiomaticity 102
- idioms 259
- if* 186
- immediate constituent 7–9
- immediately dominate 17
- imperative 66
- indefinite article 49, 142
- indefinite pronoun 50, 143, 156
- indefiniteness 143, 145
- index 225
- indirect object 72, 73, 179
- infinitive particle *to* 115, 116, 226–7, 230,
 233, 234, 237, 238
- infinitive verb 225–7
- inflection 54, 68, 112
- ing* participle form 118, 228–9, 234,
 238–9
- insist* 180
- intensive verb 74–6, 79, 119, 126, 181
see also copula be
- interrogative clause 175–6, 230–1
see also question
- interrogative pronoun 50
see also wh-question
- intransitive verb 71–2, 79, 126, 178
- irregular verb 111, 112, 113, 117
- it* (expletive) 177–8, 184, 231
- language(s) 3, 254–62
 as collection of overlapping languages
 256–7
 complexity 6, 7, 262, 263
 describing 257–62
 and grammar 262–8
 grammaticality 1–3, 7, 97, 261–2, 266
 infinite 258–62, 263
 as mental phenomenon 264
 natural 259, 261, 263, 266
 possession of 264
 prediction 262, 266
 rules 260–1, 263–4, 266–8
 as set of sentences 254–6, 257–62, 263
- lexical verb 67–8
 vs. auxiliary 67, 111–25
 complement of 68–80
see also verb
- lexical vs. phrasal category 47
see also category
- lexical vs. phrasal co-ordination 61
- location 36, 56
 spatial vs. temporal 57
- mass noun 49, 143
- meaning 15
see also ambiguity; semantics
- mobility of adverbials 92–3
- modal (MOD) 111, 115–16, 118, 119,
 226–7
- modification (modifier) 32–3, 37, 46–7
 adjunct adverbial as 88–9, 98
 in AP 55, 60
 vs. complement 69, 87, 91
 and dependency 35–6
 NOM and 142, 149–50
 in NP 52, 53, 187, 235–6
 optionality 52, 69, 142
 post-modifier 150–5, 156
 PP as 69, 73, 78, 187
 pre-modifier 146–9, 156
 of pronoun ix, 155–7
 proper noun and 49
 relative clause and 204–11, 232
 in VP 87, 88–9, 91, 99
- modifier-head relation 32–5, 36, 37, 38, 53
- morphemes 3, 259
- morphology 3, 48
- mother 31
- must* 116
- names (proper noun) x, 48, 49, 52, 143
- need* 115, 116
- negative particle 114, 128–30
- negative sentence 128–30
- no* (quantifier) 142
- nodes 17
 labelling 30
 non-branching 141
 relationships 31
- nominal (NOM) 141–2, 149–50
 modified by relative clause 205–6
 post-modifier in 150–5
 pre-modifier in 146–9
 and the pro-form *one* 165–70
- nominative *see* subjective case
- non-finite clause 224–53

- non-finite clause (*cont'd*)
 as complement of V 236–44
 complementiser and 229–32
 discussion of in-text exercises 244–7
 exercises 247–53
 form 224–32
 functions 232–44
 function of NP and 239–41
- non-finite verb
 bare infinitive 226
 vs. finite verb 112–14, 115, 117, 224
 form 225–9
 -*ing* participle form 118, 228–9, 234, 238–9
 passive participle form 120, 227–8, 235
to-infinitive 115, 116, 226–7, 230, 233, 234, 237, 238
- non-restrictive relative clause 208–11
- not* 128–30
- noun (N) 29, 47–50
 abstract 182–3
 common 48–9
 compound 148
 count vs. mass 49, 143
 as noun phrase (NP) 52–3
 as pre-modifier 148–9
 proper 48, 49, 52, 143
- noun-complement clauses 182–4, 204–8, 235
 vs. relative clause 204–7
- noun phrase (NP) 29–32, 48, 49, 50–4
 as adverbial 88
 complement of N in 182–4, 204–8, 235
 as complement to complex verb 76–8
 as complement to ditransitive verb 72–3
 as complement to transitive verb 70–1, 74, 75
 co-ordinate 57–60
 determiners in 141–4
that- and *whether*-clauses as 179–180
 discussion of in-text exercises 157–60
 exercises 160–4, 170
 modification of pronoun 155–7
 modifier in 52, 53, 187, 235–6
 NOM and the pro-form *one* 165–70
 covert in non-finite clauses 224–5
 non-finite clauses in 235–6
 function in non-finite clause 239–42
 noun as 52–3
- pre-determiners in 145–6
 as predicative 75
 post-modifiers in 150–5
 pre-modifiers in 146–9
 pronoun as 53
 and relative clause 204–8
 restrictive and non-restrictive relative clause in 208–11
 structure 141–70
 structure of NOM 141–2, 149–50
- number 51
see also plural; singular
- numerals 49, 147
- object
 direct 71, 72, 73, 75, 77, 95, 179–80
 indirect 72, 73, 179
 and non-finite clause 240–3
 and passive sentence 126–8
that- and *whether*-clauses as 179–80
- object-predicative 76–8
- objective case (accusative) 70–1, 72, 200, 230, 240–1
- obligatory *see* optionality
- one*
 pro-form 165–70, 206
 pro-NOM 206
- optionality 11–12, 32, 36, 52, 69, 89, 142, 178
 vs. ellipsis 96–7
- overt subject 224–5, 227, 230, 233, 234–5, 237, 241
see also covert subject
- parenthesis 209
- participle
 -*ing* form 118, 228–9, 234, 238–9
 passive 120, 227–8, 235
 perfect 117, 120
 progressive 118, 229
- participle phrase (PartP) 147–8
- particle 94–5
 infinitive *to* 115, 116, 226–7, 230, 233, 234, 237, 238
 negative 114, 128–30
 passive auxiliary *be* (PASS) 119–21, 126
 passive participle 120, 227–8, 235
 passive sentence 125–8, 130
 passive voice 119

- past participle
 passive 120, 227–8, 235
 perfect 117, 120
- past tense 68, 112, 113–14
 and modal 115–16
 perfect auxiliary and 116–18
- perfect auxiliary *have* (PERF) 116–18, 119
- perfect participle 117, 120
- person
 and verb *be* 112–13
 third 112–13, 116
- persuade* 243
- phonology 3
- phrasal categories 29–31, 47
- phrasal verb 93–5
- phrase 9–10, 12–18, 35
 vs. constituent 9–10, 12–13
 co-ordinate 57–62
 and dependency 36
 head 32
 noun phrase and verb phrase 29–31
 participle phrase 147–8
 single word as 52–4, 57
see also adjective phrase; adverb phrase;
 noun phrase; prepositional phrase;
 verb phrase
- phrase marker 12, 13–14, 17, 30–1, 37–8, 265–7
 abbreviated clausal analysis 172–3
 features 71, 75–6, 113
 index/co-indexing 225
 right-branching 173
 tree diagram 7, 8, 9, 10, 12
 triangle 16, 30
see also nodes
- plural 14, 51, 58
 count noun 49, 143
see also number
- positive sentence 130
- possessive (POSS) 48, 50, 142, 143–4
- possessive determiner 235
- post-modifier 150–5, 156
- pre-determiner ix, 145–6
- predicate
 subject and 24–8, 37, 38, 173
 verb phrase as 29–32
- predicative 74–5
 vs. direct object 74
 object-predicative 76–8
 subject-predicative 75–6, 126–7, 180–1
- prediction 262, 266
- prefer* 240
- pre-modifier 146–9, 156
- preposition (P) ix, 56–7
after, until, before, since ix–x, 185–6
 complement of, within PP 184–6, 234
 vs. subordinating conjunction ix–x, 186–7
- prepositional complement 78–9
- prepositional phrase (PP) ix, 56–7, 59–60, 61
 as adjunct adverbial 87, 89–90, 92, 93–4, 100
 as complement 78
 complement of P within 184–6, 234
 governor in 71
 as indirect object 73
 as modifier 69, 73, 78, 187
 as post-modifier 150–4
 as subject-predicative 76
- prepositional verb 78–9
- present tense 68, 112, 114
 and modal 115–16
- primary auxiliary 111
- pro-form 91
one 165–70, 206
- progressive auxiliary *be* (PROG) 118–19, 120, 124–5, 229
- progressive participle 118, 229
- promise* 237, 238, 242–3
- pro-NOM *one* 206
- pronoun 29, 50, 51–2, 141
 accusative (in non-finite clause) 240–1
 and clausal subject 177
 definite 50, 143
 determiner functioning as 145–6
 indefinite 50, 143, 156
 interrogative 204
 modification of ix, 155–7
 as noun phrase 53
 as pro-form 91
 relative 204, 208
 sub-categories 50
- proper noun (name) x, 48, 49, 52, 143
- property 74–5
- proposition 179, 241
- purpose 186

- quantifier (Q) 142
 quantifying adjective (QA) 146–7
 question 13, 18
 auxiliary verb and 114
 constituent xiii, 196
 echo 201
 fronting the tensed auxiliary 130–1
 interrogative clause 175–6, 230–1
 interrogative pronoun 50
 wh-question 13, 14–15, 196–202
 whether clause as allusion to 175–6
 yes/no 26, 29, 196, 197
 question movement test 26–8, 29, 58

 recursion 171
 sentential 171–4
 recursive category 149–50
 reflexive 50
 regular verb 111–12, 117
 relation 25
 head-complement relation 35–8
 modifier-head relation 32–5
 relative clause 204–11, 235–6, 258–9
 non finite 230, 231–2
 vs. noun complement clause 204–7
 omission of the *wh*-phrase 207
 restrictive vs. non-restrictive 208–11, 235–6
 and *that* 207–8
 relative pronoun 204, 208
 right-branching 173
 rules 260–1, 263–4, 266–8

 S adverbial *see* sentence adverbial
 S-bar (S') x, xii, 130, 174, 205
 S-double-bar (S'') x, xiii, 198, 199, 205
 Saussure, Ferdinand de 259
seem 181
 semantic unit 15
 semantics 3
 see also ambiguity
 sentence
 analysis 8–10, 265–8
 as basis of language 254–6, 257–62, 263
 complexity and 24–8
 complex vs. compound 171–2
 definition 263–4
 embedded 172
 and grammar 263–8
 grammaticality 1–3, 7, 97, 261–2, 266
 negative 128–30
 noun phrase and verb phrase 29–31
 passive 125–8, 130
 simple 24
 vs. utterance 97
 sentence adverbial (S adverbial) 98–101, 123, 187
 sentential recursion 171–4
 see also subordinate clause
 sequence 11–13
 since ix–x, 185, 186, 187
 singular 49, 51, 58, 112–113
 sister ix, 31–3
 sister-of-N vs. sister-of-NOM 167–8, 206–7
 sister-of-V vs. sister-of-VP 91, 167
 stative verb 229
 structural ambiguity *see* ambiguity
 structure 6–10, 16, 121–3, 261
 sub-categorisation
 ellipsis and 96–8
 features 71, 75–6, 113
 of noun 48–9
 of pronoun 50
 of verb 69–86, 96–8, 180, 236, 237–8, 241–4
 subject
 and accusative case 240–1
 and C2 position 231
 clausal 176–8
 controlled vs. free 225, 231, 232, 233
 covert 224–5, 230, 231–2, 233, 235, 238, 241, 242–3
 ‘dummy’ 177
 and ellipsis 96–7
 extraposed 177–8, 184, 232–3
 and non-finite clause 225, 231, 232–4, 235, 238, 240–1, 242–3
 noun phrase as 29–32, 53
 overt 224–5, 227, 230, 233, 234–5, 237, 241
 and passive sentence 126–8
 and predicate 24–8, 37, 38, 173
 subject-auxiliary inversion *see*
 auxiliary-fronting
 subject-predicative 75–6, 126–7, 180–1
 subject-verb agreement 113, 116
 subjective case (nominative) 70–1

- subordinate clause 171–95
 adverbial 186–7
 complementisers *that* and *whether* 174–86
 discussion of in-text exercises 188–91
 exercises 191–5
 as subject 176–8
see also non-finite clause; relative clause;
wh-clause
- subordinating conjunction 186–7
 superlative 54
 superordinate clause 172
 syntactic unit 15
- tell* 230–1
- tense 68, 111–21, 128–32
 feature 113
 modals and 111, 115–16, 118, 119,
 226–7
 negative sentence and auxiliary *do*
 128–30
 and non-finite clause 224, 226, 227
 passive auxiliary *be* 119–21, 126
 perfect auxiliary *have* 116–18, 119
 progressive auxiliary *be* 118–19, 120,
 124–5, 229
 in questions 130–2
 and time 114, 117
- that*
 as complementiser 174–5, 199–200
 in relative clause 207–8
- that*-clause 175–86, 242
 complement of A within AP 181–2
 complement of N within NP 182–4,
 204–6
 complement of P within PP 184–6
 complement of V within VP 179–81
 subject and extraposed subject 176–8
 as subject-predicative 180–1
 vs. *whether*-clause 175–6
- the see* definite article
- there* (expletive) 242
- third person singular 112–13, 116
- time and tense 114, 117
- to* (infinitive particle) 115, 116, 226–7, 230,
 233, 234, 237, 238
- transitive verb 70–1, 74, 75, 79
 and clausal object 180
 and ellipsis 97–8
 and non-finite clause 236–7
 and passive sentence 126–7
 phrasal 94
 tree diagram *see* phrase marker
- unless* 187
- until* ix–x, 185, 187
- utterance vs. sentence 97
- verb (V) 29, 67–86
 and clausal subject 178
 in clause 172
 complement of 68–80, 121, 179–81,
 236–44
 discussion of in-text exercises 80
 exercises 80–6
 finite vs. non-finite 112–14, 115, 117, 224
 infinitive 225–7
 inflection 68, 112
 irregular vs. regular 111, 112, 113, 117
 lexical vs. auxiliary 67, 111–25
 main 172
 phrasal 93–5
 stem 112, 116
 sub-categories 69–86, 96–8, 180, 236,
 237–8, 241–4
 subject-verb agreement 113, 116
 Type I and Type II 241–4
see also auxiliary verb; non-finite verb;
 participle
- verb phrase (VP) ix, x, 29–32, 37, 52
 and adjunct adverbial 88–93, 98, 100
 auxiliary verb in structure of 121–5
 complement of V within 179–81
 intransitive verb as 71–2
 levels of 88–92
 modifier in 87, 88–9, 91, 99
 and NOM 165
do so as replacement for 91
 quantifying adjective in 147
 single word as 54
- VP-adverbial xii, 98–100, 186–7, 203
see also adjunct adverbial
- wh*-clause 196–223
 discussion of in-text exercises 211–16
 exercises 216–23
 omission of *wh*-phrase 207
 relative 204–11
 restrictive vs. non-restrictive 208–11

- wh*-clause (*cont'd*)
 - main vs. subordinate 202–4
 - to*-infinitive 230
 - subordinate interrogative 202–3
 - see also wh*-fronting; *wh*-question
- wh*-determiner 197
- wh*-expression 199–200, 201
 - omission of 207
- wh*-fronting 197–202, 204, 207
 - of degree adverb 200
 - of determiner 197
 - in non-finite clause 230–2
 - of subject 201
- wh*-question 13, 14–15, 196–203
- wh*-subject 201
- whether*-clause 175–86
 - complement of A within AP 181–2
 - complement of N within NP 182–4
 - complement of P within PP 184–6
 - complement of V within VP 179–81
 - subject, and extraposed subject
 - 176–8
 - as subject-predicative 180–1
 - vs. fronted *wh*-expression 199–200
- will* 115
- write* 68, 111, 112, 113, 117
- yes/no* question 26, 29, 196, 197

