

Introduction to Solid State Physics, 8th Edition
Charles Kittel

CHAPTER 1: CRYSTAL STRUCTURE.

Periodic Array of Atoms.
Fundamental Types of Lattices.
Index System for Crystal Planes.
Simple Crystal Structures.
Direct Imaging of Atomic Structure.
Nonideal Crystal Structures.
Crystal Structure Data.

CHAPTER 2: WAVE DIFFRACTION AND THE RECIPROCAL LATTICE.

Diffraction of Waves by Crystals.
Scattered Wave Amplitude.
Brillouin Zones.
Fourier Analysis of the Basis.

CHAPTER 3: CRYSTAL BINDING AND ELASTIC CONSTANTS.

Crystals of Inert Gases.
Ionic Crystals.
Covalent Crystals.
Metals.
Hydrogen Bonds.
Atomic Radii.
Analysis of Elastic Strains.
Elastic Compliance and Stiffness Constants.
Elastic Waves in Cubic Crystals.

CHAPTER 4: PHONONS I. CRYSTAL VIBRATIONS.

Vibrations of Crystals with Monatomic Basis.
Two Atoms per Primitive Basis.
Quantization of Elastic Waves.
Phonon Momentum.
Inelastic Scattering by Phonons.

CHAPTER 5: PHONONS II. THERMAL PROPERTIES.

Phonon Heat Capacity.
Anharmonic Crystal Interactions.
Thermal Conductivity.

CHAPTER 6: FREE ELECTRON FERMI GAS.

Energy Levels in One Dimension.
Effect of Temperature on the Fermi-Dirac Distribution.
Free Electron Gas in Three Dimensions.
Heat Capacity of the Electron Gas.

Electrical Conductivity and Ohm's Law.
Motion in Magnetic Fields.
Thermal Conductivity of Metals.

CHAPTER 7: ENERGY BANDS.

Nearly Free Electron Model.
Bloch Functions.
Kronig-Penney Model.
Wave Equation of Electron in a Periodic Potential.
Number of Orbitals in a Band.

CHAPTER 8: SEMICONDUCTOR CRYSTALS.

Band Gap.
Equations of Motion.
Intrinsic Carrier Concentration.
Impurity Conductivity.
Thermoelectric Effects.
Semimetals.
Superlattices.

CHAPTER 9: FERMI SURFACES AND METALS.

Construction of Fermi Surfaces.
Electron Orbits, Hole Orbits, and Open Orbits.
Calculation of Energy Bands.
Experimental Methods in Fermi Surface Studies.

CHAPTER 10: SUPERCONDUCTIVITY.

Experimental Survey.
Theoretical Survey.
High-Temperature Superconductors.

CHAPTER 11: DIAMAGNETISM AND PARAMAGNETISM.

Langevin Diamagnetism Equation.
Quantum Theory of Diamagnetism of Mononuclear Systems.
Paramagnetism.
Quantum Theory of Paramagnetism.
Cooling by Isentropic Demagnetization.
Paramagnetic Susceptibility of Conduction Electrons.

CHAPTER 12: FERROMAGNETISM AND ANTIFERROMAGNETISM.

Ferromagnetic Order.
Magnons.
Neutron Magnetic Scattering.
Ferrimagnetic Order.
Antiferromagnetic Order.
Ferromagnetic Domains.

Single Domain Particles.

CHAPTER 13: MAGNETIC RESONANCE.

Nuclear Magnetic Resonance.

Line Width.

Hyperfine Splitting.

Nuclear Quadrupole Resonance.

Ferromagnetic Resonance.

Antiferromagnetic Resonance.

Electron Paramagnetic Resonance.

Principle of Maser Action.

CHAPTER 14: PLASMONS, POLARITONS, AND POLARONS.

Dielectric Function of the Electron Gas.

Plasmons.

Electrostatic Screening.

Polaritons.

Electron-Electron Interaction.

Electron-Phonon Interaction: Polarons.

Peierls Instability of Linear Metals.

CHAPTER 15: OPTICAL PROCESSES AND EXCITONS.

Optical Reflectance.

Excitons.

Raman Effects in Crystals.

Energy Loss of Fast Particles in a Solid.

CHAPTER 16: DIELECTRICS AND FERROELECTRICS.

Macroscopic Electric Field.

Local Electric Field at an Atom.

Dielectric Constant and Polarizability.

Structural Phase Transitions.

Ferroelectric Crystals.

Displacive Transitions.

CHAPTER 17: SURFACE AND INTERFACE PHYSICS.

Surface Crystallography.

Surface Electronic Structure.

Magnetoresistance in a Two-Dimensional Channel.

p-n Junctions.

Heterostructures.

Semiconductor Lasers.

Light-Emitting Diodes.

CHAPTER 18: NANOSTRUCTURES.

Imaging Techniques for Nanostructures.

Electronic Structure of 1D Systems.

Electrical Transport in 1D.

Electronic Structure of 0D Systems.

Electrical Transport in 0D.

Vibrational and Thermal Properties of Nanostructures.

CHAPTER 19: NONCRYSTALLINE SOLIDS.

Diffraction Pattern.

Glasses.

Amorphous Ferromagnets.

Amorphous Semiconductors.

Low Energy Excitations in Amorphous Solids.

Fiber Optics.

CHAPTER 20: POINT DEFECTS.

Lattice Vacancies.

Diffusion.

Color Centers.

CHAPTER 21: DISLOCATIONS.

Shear Strength of Single Crystals.

Dislocations.

Strength of Alloys.

Dislocations and Crystal Growth.

Hardness of Materials.

CHAPTER 22: ALLOYS.

General Consideration.

Substitutional Solid Solutions – Hume-Rotherby Rules.

Order-Disorder Transformation.

Phase Diagrams.

Transition Metal Alloys.

Kondo Effect.

CHAPTER 1

1. The vectors $\hat{x} + \hat{y} + \hat{z}$ and $-\hat{x} - \hat{y} + \hat{z}$ are in the directions of two body diagonals of a cube. If θ is the angle between them, their scalar product gives $\cos \theta = -1/3$, whence $\theta = \cos^{-1} 1/3 = 90^\circ + 19^\circ 28' = 109^\circ 28'$.

2. The plane (100) is normal to the x axis. It intercepts the a' axis at $2a'$ and the c' axis at $2c'$; therefore the indices referred to the primitive axes are (101). Similarly, the plane (001) will have indices (011) when referred to primitive axes.

3. The central dot of the four is at distance

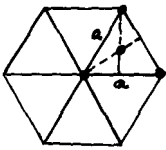

$$a \frac{\cos 60^\circ}{\cos 30^\circ} = a \operatorname{ctn} 60^\circ = \frac{a}{\sqrt{3}}$$

from each of the other three dots, as projected onto the basal plane. If the (unprojected) dots are at the center of spheres in contact, then

$$a^2 = \left(\frac{a}{\sqrt{3}} \right)^2 + \left(\frac{c}{2} \right)^2,$$

or

$$\frac{2}{3}a^2 = \frac{1}{4}c^2; \quad \frac{c}{a} \sqrt{\frac{8}{3}} = 1.633.$$

CHAPTER 2

1. The crystal plane with Miller indices hkl is a plane defined by the points \mathbf{a}_1/h , \mathbf{a}_2/k , and \mathbf{a}_3/ℓ . (a) Two vectors that lie in the plane may be taken as $\mathbf{a}_1/h - \mathbf{a}_2/k$ and $\mathbf{a}_1/h - \mathbf{a}_3/\ell$. But each of these vectors gives zero as its scalar product with $\mathbf{G} = h\mathbf{a}_1 + k\mathbf{a}_2 + \ell\mathbf{a}_3$, so that \mathbf{G} must be perpendicular to the plane hkl . (b) If $\hat{\mathbf{n}}$ is the unit normal to the plane, the interplanar spacing is $\hat{\mathbf{n}} \cdot \mathbf{a}_1/h$. But $\hat{\mathbf{n}} = \mathbf{G}/|\mathbf{G}|$, whence $d(hkl) = \mathbf{G} \cdot \mathbf{a}_1/h|\mathbf{G}| = 2\pi/|\mathbf{G}|$. (c) For a simple cubic lattice $\mathbf{G} = (2\pi/a)(h\hat{\mathbf{x}} + k\hat{\mathbf{y}} + \ell\hat{\mathbf{z}})$, whence

$$\frac{1}{d^2} = \frac{G^2}{4\pi^2} = \frac{h^2 + k^2 + \ell^2}{a^2}.$$

2. (a) Cell volume $\mathbf{a}_1 \cdot \mathbf{a}_2 \times \mathbf{a}_3 = \begin{vmatrix} \frac{1}{2}\sqrt{3}a & \frac{1}{2}a & 0 \\ -\frac{1}{2}\sqrt{3}a & \frac{1}{2}a & 0 \\ 0 & 0 & c \end{vmatrix}$

$$= \frac{1}{2}\sqrt{3}a^2c.$$

(b) $\mathbf{b}_1 = 2\pi \frac{\mathbf{a}_2 \times \mathbf{a}_3}{|\mathbf{a}_1 \cdot \mathbf{a}_2 \times \mathbf{a}_3|} = \frac{4\pi}{\sqrt{3}a^2c} \begin{vmatrix} \hat{\mathbf{x}} & \hat{\mathbf{y}} & \hat{\mathbf{z}} \\ -\frac{1}{2}\sqrt{3}a & \frac{1}{2}a & 0 \\ 0 & 0 & c \end{vmatrix}$

$$= \frac{2\pi}{a} \left(\frac{1}{\sqrt{3}}\hat{\mathbf{x}} + \hat{\mathbf{y}} \right), \text{ and similarly for } \mathbf{b}_2, \mathbf{b}_3.$$

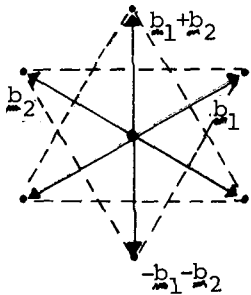

(c) Six vectors in the reciprocal lattice are shown as solid lines. The broken lines are the perpendicular bisectors at the midpoints. The inscribed hexagon forms the first Brillouin Zone.

3. By definition of the primitive reciprocal lattice vectors

$$\begin{aligned} V_{BZ} &= (2\pi)^3 \frac{(\mathbf{a}_2 \times \mathbf{a}_3) \cdot (\mathbf{a}_3 \times \mathbf{a}_1) \times (\mathbf{a}_1 \times \mathbf{a}_2)}{|\mathbf{a}_1 \cdot \mathbf{a}_2 \times \mathbf{a}_3|^3} = (2\pi)^3 / |\mathbf{a}_1 \cdot \mathbf{a}_2 \times \mathbf{a}_3| \\ &= (2\pi)^3 / V_C. \end{aligned}$$

For the vector identity, see G. A. Korn and T. M. Korn, *Mathematical handbook for scientists and engineers*, McGraw-Hill, 1961, p. 147.

4. (a) This follows by forming

$$|F|^2 = \frac{1 - \exp[-iM(\mathbf{a} \cdot \Delta\mathbf{k})]}{1 - \exp[-i(\mathbf{a} \cdot \Delta\mathbf{k})]} \cdot \frac{1 - \exp[iM(\mathbf{a} \cdot \Delta\mathbf{k})]}{1 - \exp[i(\mathbf{a} \cdot \Delta\mathbf{k})]}$$

$$= \frac{1 - \cos M(\mathbf{a} \cdot \Delta\mathbf{k})}{1 - \cos(\mathbf{a} \cdot \Delta\mathbf{k})} = \frac{\sin^2 \frac{1}{2} M(\mathbf{a} \cdot \Delta\mathbf{k})}{\sin^2 \frac{1}{2} (\mathbf{a} \cdot \Delta\mathbf{k})}.$$

(b) The first zero in $\sin \frac{1}{2} M\varepsilon$ occurs for $\varepsilon = 2\pi/M$. That this is the correct consideration follows from

$$\sin M\left(\pi h + \frac{1}{2}\varepsilon\right) = \underbrace{\sin \pi Mh}_{\substack{\text{zero,} \\ \text{as } Mh \text{ is} \\ \text{an integer}}} \cos \frac{1}{2} M\varepsilon + \underbrace{\cos \pi Mh}_{\pm 1} \sin \frac{1}{2} M\varepsilon.$$

$$5. S(v_1 v_2 v_3) = f \sum_{\mathbf{j}} e^{-2\pi i(x_j v_1 + y_j v_2 + z_j v_3)}$$

Referred to an fcc lattice, the basis of diamond is 000; $\frac{1}{4} \frac{1}{4} \frac{1}{4}$. Thus in the product

$$S(v_1 v_2 v_3) = S(\text{fcc lattice}) \times S(\text{basis}),$$

we take the lattice structure factor from (48), and for the basis

$$S(\text{basis}) = 1 + e^{-i \frac{1}{2} \pi(v_1 + v_2 + v_3)}.$$

Now $S(\text{fcc}) = 0$ only if all indices are even or all indices are odd. If all indices are even the structure factor of the basis vanishes unless $v_1 + v_2 + v_3 = 4n$, where n is an integer. For example, for the reflection (222) we have $S(\text{basis}) = 1 + e^{-i3\pi} = 0$, and this reflection is forbidden.

$$6. \quad f_G = \int_0^\infty 4\pi r^2 (\pi a_0^3 G r)^{-1} \sin Gr \exp(-2r/a_0) dr$$

$$= (4/G^3 a_0^3) \int dx x \sin x \exp(-2x/Ga_0)$$

$$= (4/G^3 a_0^3) (4/Ga_0) / (1 + r/G^2 a_0^2)^2$$

$$16 / (4 + G^2 a_0^2)^2.$$

The integral is not difficult; it is given as Dwight 860.81. Observe that $f = 1$ for $G = 0$ and $f \propto 1/G^4$ for $Ga_0 \gg 1$.

7. (a) The basis has one atom **A** at the origin and one atom **B** at $\frac{1}{2}\mathbf{a}$. The single Laue equation $\mathbf{a} \cdot \Delta\mathbf{k} = 2\pi \times (\text{integer})$ defines a set of parallel planes in Fourier space. Intersections with a sphere are a set of circles, so that the diffracted beams lie on a set of cones. (b) $S(n) = f_A + f_B e^{-i\pi n}$. For n odd, $S = f_A -$

f_B ; for n even, $S = f_A + f_B$. (c) If $f_A = f_B$ the atoms diffract identically, as if the primitive translation vector were $\frac{1}{2} \mathbf{a}$ and the diffraction condition $(\frac{1}{2} \mathbf{a} \cdot \Delta \mathbf{k}) = 2\pi \times (\text{integer})$.

CHAPTER 3

1. $E = (\hbar^2/2M) (2\pi/\lambda)^2 = (\hbar^2/2M) (\pi/L)^2$, with $\lambda = 2L$.

2. bcc: $U(R) = 2N\varepsilon[9.114(\sigma/R)^{12} - 12.253(\sigma/R)^6]$. At equilibrium $R_0^6 = 1.488\sigma^6$, and $U(R_0) = 2N\varepsilon(-2.816)$.

fcc: $U(R) = 2N\varepsilon[12.132(\sigma/R)^{12} - 14.454(\sigma/R)^6]$. At equilibrium $R_0^6 = 1.679\sigma^6$, and $U(R_0) = 2N\varepsilon(-4.305)$. Thus the cohesive energy ratio bcc/fcc = **0.956**, so that the fcc structure is more stable than the bcc.

3. $|U| = 8.60 N\varepsilon$
 $= (8.60)(6.02 \times 10^{23})(50 \times 10^{-16}) = 25.9 \times 10^9 \text{ erg/mol}$
 $= 2.59 \text{ kJ/mol}$.

This will be decreased significantly by quantum corrections, so that it is quite reasonable to find the same melting points for H₂ and Ne.

4. We have $\text{Na} \rightarrow \text{Na}^+ + e - 5.14 \text{ eV}$; $\text{Na} + e \rightarrow \text{Na}^- + 0.78 \text{ eV}$. The Madelung energy in the NaCl structure, with Na⁺ at the Na⁺ sites and Na⁻ at the Cl⁻ sites, is

$$\frac{\alpha e^2}{R} = \frac{(1.75) (4.80 \times 10^{-10})^2}{3.66 \times 10^{-8}} = 11.0 \times 10^{-12} \text{ erg},$$

or 6.89 eV. Here R is taken as the value for metallic Na. The total cohesive energy of a Na⁺ Na⁻ pair in the hypothetical crystal is 2.52 eV referred to two separated Na atoms, or 1.26 eV per atom. This is larger than the observed cohesive energy 1.13 eV of the metal. We have neglected the repulsive energy of the Na⁺ Na⁻ structure, and this must be significant in reducing the cohesion of the hypothetical crystal.

5a.

$$U(R) = N \left(\frac{A}{R^n} - \frac{\alpha q^2}{R} \right); \quad \alpha = 2 \log 2 = \text{Madelung const.}$$

In equilibrium

$$\frac{\partial U}{\partial R} = N \left(-\frac{nA}{R_0^{n+1}} + \frac{\alpha q^2}{R_0^2} \right) = 0; \quad R_0^n = \frac{nA}{\alpha q^2},$$

and

$$U(R_0) = -\frac{N\alpha q^2}{R_0} \left(1 - \frac{1}{n} \right).$$

b.
$$U(R_0 - R_0\delta) = U(R_0) + \frac{1}{2} \frac{\partial^2 U}{\partial R^2} R_0 (R_0\delta)^2 + \dots,$$

bearing in mind that in equilibrium $(\partial U/\partial R)_{R_0} = 0$.

$$\left(\frac{\partial^2 U}{\partial R^2} \right)_{R_0} = N \left(\frac{n(n+1)A}{R_0^{n+2}} - \frac{2\alpha q^2}{R_0^3} \right) = N \left(\frac{(n+1)\alpha q^2}{R_0^3} - \frac{2\alpha q^2}{R_0^3} \right)$$

For a unit length $2NR_0 = 1$, whence

$$\left(\frac{\partial^2 U}{\partial R^2} \right)_{R_0} = \frac{\alpha q^2}{2R_0^4} (n-1); \quad C = R_0^2 \left. \frac{\partial^2 U}{\partial R^2} \right|_{R_0} = \frac{(n-1)q^2 \log 2}{R_0^2}.$$

6. For KCl, $\lambda = 0.34 \times 10^{-8}$ ergs and $\rho = 0.326 \times 10^{-8}$ Å. For the imagined modification of KCl with the ZnS structure, $z = 4$ and $\alpha = 1.638$. Then from Eq. (23) with $x \equiv R_0/\rho$ we have

$$x^2 e^{-x} = 8.53 \times 10^{-3}.$$

By trial and error we find $x \approx 9.2$, or $R_0 = 3.00$ Å. The actual KCl structure has $R_0(\text{exp}) = 3.15$ Å. For the imagined structure the cohesive energy is

$$U = \frac{-\alpha q^2}{R_0} \left(1 - \frac{p}{R_0} \right), \quad \text{or} \quad \frac{U}{q^2} = -0.489$$

in units with R_0 in Å. For the actual KCl structure, using the data of Table 7, we calculate $\frac{U}{q^2} = -0.495$,

units as above. This is about 0.1% lower than calculated for the cubic ZnS structure. It is noteworthy that the difference is so slight.

7. The Madelung energy of $\text{Ba}^+ \text{O}^-$ is $-\alpha e^2/R_0$ per ion pair, or -14.61×10^{-12} erg = -9.12 eV, as compared with $-4(9.12) = -36.48$ eV for $\text{Ba}^{++} \text{O}^-$. To form Ba^+ and O^- from Ba and O requires $5.19 - 1.5 = 3.7$ eV; to form Ba^{++} and O^- requires $5.19 + 9.96 - 1.5 + 9.0 = 22.65$ eV. Thus at the specified value of R_0 the binding of $\text{Ba}^+ \text{O}^-$ is 5.42 eV and the binding of $\text{Ba}^{++} \text{O}^-$ is 13.83 eV; the latter is indeed the stable form.

8. From (37) we have $e_{xx} = S_{11}X_x$, because all other stress components are zero. By (51), $3S_{11} = 2/(C_{11} - C_{12}) + 1/(C_{11} + C_{12})$.

$$\text{Thus } Y = (C_{11}^2 + C_{12}C_{11} - 2C_{12}^2)/(C_{11} + C_{12});$$

further, also from (37), $e_{yy} = S_{21}X_x$,

$$\text{whence } \sigma = e_{yy}/e_{xx} = S_{21}/S_{11} = -C_{12}/(C_{11} + C_{12}).$$

9. For a longitudinal phonon with $\mathbf{K} \parallel [111]$, $u = v = w$.

$$\omega^2 \rho = [C_{11} + 2C_{44} + 2(C_{12} + C_{44})]K^2/3,$$

$$\text{or } v = \omega/K = [(C_{11} + 2C_{12} + 4C_{44}/3\rho)]^{1/2}$$

This dispersion relation follows from (57a).

10. We take $u = -w$; $v = 0$. This displacement is \perp to the [111] direction. Shear waves are degenerate in this direction. Use (57a).

11. Let $e_{xx} = -e_{yy} = \frac{1}{2}e$ in (43). Then

$$U = \frac{1}{2}C_{11}(\frac{1}{4}e^2 + \frac{1}{4}e^2) - \frac{1}{4}C_{12}e^2$$

$$= \frac{1}{2}[\frac{1}{2}(C_{11} - C_{12})]e^2$$

so that $\left(\frac{\partial^2 U}{\partial R^2}\right)_{R_0} = N\left(\frac{n(n+1)A}{R_0^{n+2}} - \frac{2\alpha q^2}{R_0^3}\right) = N\left(\frac{(n+1)\alpha q^2}{R_0^3} - \frac{2\alpha q^2}{R_0^3}\right)$ is the effective shear

constant.

12a. We rewrite the element $a_{ij} = p - \delta_{ij}(\lambda + p - q)$ as $a_{ij} = p - \lambda' \delta_{ij}$, where $\lambda' = \lambda + p - q$, and δ_{ij} is the Kronecker delta function. With λ' the matrix is in the “standard” form. The root $\lambda' = Rp$ gives $\lambda = (R - 1)p + q$, and the $R - 1$ roots $\lambda' = 0$ give $\lambda = q - p$.

b. Set

$$u(\mathbf{r}, t) = u_0 e^{i[(K/\sqrt{3})(x+y+z) - \omega t]},$$

$$v(\mathbf{r}, t) = v_0 e^{i[\dots]},$$

$$w(\mathbf{r}, t) = w_0 e^{i[\dots]},$$

as the displacements for waves in the [111] direction. On substitution in (57) we obtain the desired equation. Then, by (a), one root is

$$\omega^2 \rho = 2p + q = K^2(C_{11} + 2C_{12} + 4C_{44})/3,$$

and the other two roots (shear waves) are

$$\omega^2 \rho = K^2(C_{11} - C_{12} + C_{44})/3.$$

13. Set $u(\mathbf{r}, t) = u_0 e^{i(\mathbf{K} \cdot \mathbf{r} - t)}$ and similarly for v and w . Then (57a) becomes

$$\omega^2 \rho u_0 = [C_{11}K_y^2 + C_{44}(K_y^2 + K_z^2)]u_0$$

$$+ (C_{12} + C_{44})(K_x K_y v_0 + K_x K_z w_0)$$

and similarly for (57b), (57c). The elements of the determinantal equation are

$$M_{11} = C_{11}K_x^2 + C_{44}(K_y^2 + K_z^2) - \omega^2 \rho;$$

$$M_{12} = (C_{12} + C_{44})K_x K_y;$$

$$M_{13} = (C_{12} + C_{44})K_x K_z.$$

and so on with appropriate permutations of the axes. The sum of the three roots of $\omega^2 \rho$ is equal to the sum of the diagonal elements of the matrix, which is

$(C_{11} + 2C_{44})K^2$, where

$$K^2 = K_x^2 + K_y^2 + K_z^2, \text{ whence}$$

$$v_1^2 + v_2^2 + v_3^2 = (C_{11} + 2C_{44})/\rho,$$

for the sum of the (velocities)² of the 3 elastic modes in any direction of K.

14. The criterion for stability of a cubic crystal is that all the principal minors of the quadratic form be positive. The matrix is:

$$\begin{matrix} C_{11} & C_{12} & C_{12} & & & \\ C_{12} & C_{11} & C_{12} & & & \\ C_{12} & C_{12} & C_{11} & & & \\ & & & C_{44} & & \\ & & & & C_{44} & \\ & & & & & C_{44} \end{matrix}$$

The principal minors are the minors along the diagonal. The first three minors from the bottom are C_{44} , C_{44}^2 , C_{44}^3 ; thus one criterion of stability is $C_{44} > 0$. The next minor is $C_{11} C_{44}^3$, or $C_{11} > 0$. Next: $C_{44}^3 (C_{11}^2 - C_{12}^2)$, whence $|C_{12}| < C_{11}$. Finally, $(C_{11} + 2C_{12})(C_{11} - C_{12})^2 > 0$, so that $C_{11} + 2C_{12} > 0$ for stability.

CHAPTER 4

1a. The kinetic energy is the sum of the individual kinetic energies each of the form $\frac{1}{2} M u_s^2$. The force between atoms s and $s+1$ is $-C(u_s - u_{s+1})$; the potential energy associated with the stretching of this bond is $\frac{1}{2} C(u_s - u_{s+1})^2$, and we sum over all bonds to obtain the total potential energy.

b. The time average of $\frac{1}{2} M u_s^2$ is $\frac{1}{4} M \omega^2 u^2$. In the potential energy we have

$$u_{s+1} = u \cos[\omega t - (s+1)Ka] = u \{ \cos(\omega t - sKa) \cdot \cos Ka \\ + \sin(\omega t - sKa) \cdot \sin Ka \}.$$

$$\text{Then } u_s - u_{s+1} = u \{ \cos(\omega t - sKa) \cdot (1 - \cos Ka) \\ - \sin(\omega t - sKa) \cdot \sin Ka \}.$$

We square and use the mean values over time:

$$\langle \cos^2 \rangle = \langle \sin^2 \rangle = \frac{1}{2}; \quad \langle \cos \sin \rangle = 0.$$

Thus the square of $u\{\}$ above is

$$\frac{1}{2} u^2 [1 - 2\cos Ka + \cos^2 Ka + \sin^2 Ka] = u^2 (1 - \cos Ka).$$

The potential energy per bond is $\frac{1}{2} C u^2 (1 - \cos Ka)$, and by the dispersion relation $\omega^2 = (2C/M) (1 - \cos Ka)$ this is equal to $\frac{1}{4} M \omega^2 u^2$. Just as for a simple harmonic oscillator, the time average potential energy is equal to the time-average kinetic energy.

2. We expand in a Taylor series

$$u(s+p) = u(s) + pa \left(\frac{\partial u}{\partial x} \right)_s + \frac{1}{2} p^2 a^2 \left(\frac{\partial^2 u}{\partial x^2} \right)_s + \dots;$$

On substitution in the equation of motion (16a) we have

$$M \frac{\partial^2 u}{\partial t^2} = \left(\sum_{p>0} p^2 a^2 C_p \right) \frac{\partial^2 u}{\partial x^2},$$

which is of the form of the continuum elastic wave equation with

$$v^2 = M^{-1} \sum_{p>0} p^2 a^2 C_p.$$

3. From Eq. (20) evaluated at $K = \pi/a$, the zone boundary, we have

$$\begin{aligned} -\omega^2 M_1 u &= -2Cu ; \\ -\omega^2 M_2 v &= -2Cv . \end{aligned}$$

Thus the two lattices are decoupled from one another; each moves independently. At $\omega^2 = 2C/M_2$ the motion is in the lattice described by the displacement v ; at $\omega^2 = 2C/M_1$ the u lattice moves.

$$4. \quad \omega^2 = \frac{2}{M} A \sum_{p>0} \frac{\sin pk_0 a}{pa} (1 - \cos pKa) ;$$

$$\begin{aligned} \frac{\partial \omega^2}{\partial K} &= \frac{2A}{M} \sum_{p>0} \sin pk_0 a \sin pKa \\ &\quad \frac{1}{2} (\cos (k_0 - K) pa - \cos (k_0 + K) pa) \end{aligned}$$

When $K = k_0$,

$$\frac{\partial \omega^2}{\partial K} = \frac{A}{M} \sum_{p>0} (1 - \cos 2k_0 pa) ,$$

which in general will diverge because $\sum_p 1 \rightarrow \infty$.

5. By analogy with Eq. (18),

$$\begin{aligned} M d^2 u_s / dt^2 &= C_1 (v_s - u_s) + C_2 (v_{s-1} - u_s); \\ M d^2 v_s / dt^2 &= C_1 (u_s - v_s) + C_2 (u_{s+1} - v_s), \quad \text{whence} \\ -\omega^2 M u &= C_1 (v - u) + C_2 (v e^{-iKa} - u); \\ -\omega^2 M v &= C_1 (u - v) + C_2 (u e^{iKa} - v) , \quad \text{and} \end{aligned}$$

$$\begin{vmatrix} (C_1 + C_2) - M\omega^2 & -(C_1 + C_2 e^{-iKa}) \\ -(C_1 + C_2 e^{iKa}) & (C_1 + C_2) - M\omega^2 \end{vmatrix} = 0$$

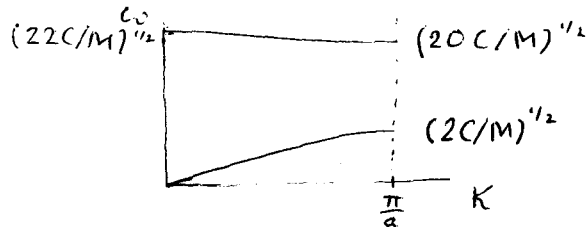

For $Ka = 0$, $\omega^2 = 0$ and $2(C_1 + C_2)/M$.

For $Ka = \pi$, $\omega^2 = 2C_1/M$ and $2C_2/M$.

6. (a) The Coulomb force on an ion displaced a distance r from the center of a sphere of static or rigid conduction electron sea is $-e^2 n(r)r^2$, where the number of electrons within a sphere of radius r is $(3/4 \pi R^3) (4\pi r^3/3)$. Thus the force is $-e^2 r/R^2$, and the

force constant is e^2/R^3 . The oscillation frequency ω_D is $(\text{force constant}/\text{mass})^{1/2}$, or $(e^2/MR^3)^{1/2}$. (b) For sodium $M \approx 4 \times 10^{-23}$ g and $R \approx 2 \times 10^{-8}$ cm; thus $\omega_D \approx (5 \times 10^{-10}) (3 \times 10^{-46})^{1/2} \approx 3 \times 10^{13}$ s⁻¹ (c) The maximum phonon wavevector is of the order of 10^8 cm⁻¹. If we suppose that ω_0 is associated with this maximum wavevector, the velocity defined by $\omega_0/K_{\text{max}} \approx 3 \times 10^5$ cm s⁻¹, generally a reasonable order of magnitude.

7. The result (a) is the force of a dipole $e_p u_p$ on a dipole $e_0 u_0$ at a distance pa . Eq. (16a) becomes $\omega^2 = (2/M)[\gamma(1 - \cos Ka) + \sum_{p>0} (-1)^p (2e^2 / p^3 a^3)(1 - \cos pKa)]$.

At the zone boundary $\omega^2 = 0$ if

$$1 + \sigma \sum_{p>0} (-1)^p [1 - (-1)^p] p^{-3} = 0,$$

or if $\sigma \sum [1 - (-1)^p] p^{-3} = 1$. The summation is $2(1 + 3^{-3} + 5^{-3} + \dots) = 2.104$ and this, by the properties of the zeta function, is also $7 \zeta(3)/4$. The sign of the square of the speed of sound in the limit $Ka \ll 1$ is given by the sign of $1 = 2\sigma \sum_{p>0} (-1)^p p^{-3} p^2$, which is zero when $1 - 2^{-1} + 3^{-1} - 4^{-1} + \dots = 1/2\sigma$. The series is just that for $\log 2$, whence the root is $\sigma = 1/(2 \log 2) = 0.7213$.

CHAPTER 5

1. (a) The dispersion relation is $\omega = \omega_m \left| \sin \frac{1}{2} Ka \right|$. We solve this for K to obtain $K = (2/a) \sin^{-1}(\omega/\omega_m)$, whence $dK/d\omega = (2/a)(\omega_m^2 - \omega^2)^{-1/2}$ and, from (15), $D(\omega) = (2L/\pi a)(\omega_m^2 - \omega^2)^{-1/2}$. This is singular at $\omega = \omega_m$. (b) The volume of a sphere of radius K in Fourier space is $\Omega = 4\pi K^3/3 = (4\pi/3)[(\omega_0 - \omega)/A]^{3/2}$, and the density of orbitals near ω_0 is $D(\omega) = (L/2\pi)^3 |d\Omega/d\omega| = (L/2\pi)^3 (2\pi/A^{3/2})(\omega_0 - \omega)^{1/2}$, provided $\omega < \omega_0$. It is apparent that $D(\omega)$ vanishes for ω above the minimum ω_0 .

2. The potential energy associated with the dilation is $\frac{1}{2} B(\Delta V/V)^2 a^3 \approx \frac{1}{2} k_B T$. This is $\frac{1}{2} k_B T$ and not $\frac{3}{2} k_B T$, because the other degrees of freedom are to be associated with shear distortions of the lattice cell. Thus $\langle (\Delta V)^2 \rangle = 1.5 \times 10^{-47}$; $(\Delta V)_{\text{rms}} = 4.7 \times 10^{-24} \text{ cm}^3$; and $(\Delta V)_{\text{rms}}/V = 0.125$. Now $3\Delta a/a \approx \Delta V/V$, whence $(\Delta a)_{\text{rms}}/a = 0.04$.

3. (a) $\langle R^2 \rangle = (\hbar/2\rho V) \Sigma \omega^{-1}$, where from (20) for a Debye spectrum $\Sigma \omega^{-1} = \int d\omega D(\omega) \omega^{-1} = 3V\omega_D^2/4\pi^3 v^3$, whence $\langle R^2 \rangle = 3\hbar\omega_D^2/8\pi^2 \rho v^3$. (b) In one dimension from (15) we have $D(\omega) = L/\pi v$, whence $\int d\omega D(\omega) \omega^{-1}$ diverges at the lower limit. The mean square strain in one dimension is $\langle (\partial R/\partial x)^2 \rangle = \frac{1}{2} \Sigma K^2 u_0^2 = (\hbar/2MNv) \Sigma K = (\hbar/2MNv)(K_D^2/2) = \hbar\omega_D^2/4MNv^3$.

4. (a) The motion is constrained to each layer and is therefore essentially two-dimensional. Consider one plane of area A . There is one allowed value of K per area $(2\pi/L)^2$ in K space, or $(L/2\pi)^2 = A/4\pi^2$ allowed values of K per unit area of K space. The total number of modes with wavevector less than K is, with $\omega = vK$,

$$N = (A/4\pi^2)(\pi K^2) = A\omega^2/4\pi v^2.$$

The density of modes of each polarization type is $D(\omega) = dN/d\omega = A\omega/2\pi v^2$. The thermal average phonon energy for the two polarization types is, for each layer,

$$U = 2 \int_0^{\omega_D} D(\omega) n(\omega, \tau) \hbar\omega d\omega = 2 \int_0^{\omega_D} \frac{A\omega}{2\pi v^2} \frac{\hbar\omega}{\exp(\hbar\omega/\tau) - 1} d\omega,$$

where ω_D is defined by $N = \int_D^{\omega_D} D(\omega) d\omega$. In the regime $\hbar\omega_D \gg \tau$, we have

$$U \cong \frac{2A\tau^3}{2\pi v^2 \hbar^2} \int_0^\infty \frac{x^2}{e^x - 1} dx.$$

Thus the heat capacity $C = k_B \partial U / \partial \tau \propto T^2$.

(b) If the layers are weakly bound together, the system behaves as a linear structure with each plane as a vibrating unit. By induction from the results for 2 and 3 dimensions, we expect $C \propto T$. But this only holds at extremely low temperatures such that $\tau \ll \hbar \omega_D \approx \hbar v N_{\text{layer}} / L$, where N_{layer}/L is the number of layers per unit length.

5. (a) From the Planck distribution $\langle n \rangle + \frac{1}{2} = \frac{1}{2} (e^x + 1) / (e^x - 1) = \frac{1}{2} \coth(x/2)$, where $x = \hbar \omega / k_B T$. The partition function $Z = e^{-x/2} \sum e^{-sx} = e^{-x/2} / (1 - e^{-x}) = [2 \sinh(x/2)]^{-1}$ and the free energy is $F = k_B T \log Z = k_B T \log [2 \sinh(x/2)]$. (b) With $\omega(\Delta) = \omega(0) (1 - \gamma \Delta)$, the condition $\partial F / \partial \Delta = 0$ becomes $B \Delta = \gamma \sum \frac{1}{2} \hbar \omega \coth(\hbar \omega / 2 k_B T)$ on direct differentiation. The energy $\langle n \rangle \hbar \omega$ is just the term to the right of the summation symbol, so that $B \Delta = \gamma U(T)$. (c) By definition of γ , we have $\delta \omega / \omega = -\gamma \delta V / V$, or $d \log \omega = -\gamma d \log V$. But $\theta \propto \omega_D$, whence $d \log \theta = -\gamma d \log V$.

CHAPTER 6

1. The energy eigenvalues are $\epsilon_k = \frac{\hbar^2}{2m} k^2$. The mean value over the volume of a sphere in k space is

$$\langle \epsilon \rangle = \frac{\hbar^2}{2m} \frac{\int k^2 dk \cdot k^2}{\int k^2 dk} = \frac{3}{5} \cdot \frac{\hbar^2}{2m} k_F^2 = \frac{3}{5} \epsilon_F.$$

The total energy of N electrons is

$$U_0 = N \cdot \frac{3}{5} \epsilon_F.$$

2a. In general $p = -\partial U / \partial V$ at constant entropy. At absolute zero all processes are at constant entropy (the Third Law), so that $p = -dU_0 / dV$, where $U_0 = \frac{3}{5} N \epsilon_F = \frac{3}{5} N \frac{\hbar^2}{2m} \left(\frac{3\pi^2 N}{V} \right)^{2/3}$, whence

$$p = \frac{2}{3} \cdot \frac{U_0}{V}. \quad \text{(b) Bulk modulus}$$

$$B = -V \frac{dp}{dV} = V \left(-\frac{2}{3} \frac{U_0}{V^2} + \frac{2}{3V} \frac{dU_0}{dV} \right) = \frac{2}{3} \cdot \frac{U_0}{V} + \left(\frac{2}{3} \right)^2 \frac{U_0}{V} = \frac{10}{9} \frac{U_0}{V}.$$

(c) For Li,

$$\begin{aligned} \frac{U_0}{V} &= \frac{3}{5} (4.7 \times 10^{22} \text{ cm}^{-3}) (4.7 \text{ eV}) (1.6 \times 10^{-12} \text{ erg/eV}) \\ &= 2.1 \times 10^{11} \text{ erg cm}^{-3} = 2.1 \times 10^{11} \text{ dyne cm}^{-2}, \end{aligned}$$

whence $B = 2.3 \times 10^{11} \text{ dyne cm}^{-2}$. By experiment (Table 3.3), $B = 1.2 \times 10^{11} \text{ dyne cm}^{-2}$.

3. The number of electrons is, per unit volume, $n = \int_0^\infty d\epsilon D(\epsilon) \cdot \frac{1}{e^{(\epsilon-\mu)/\tau} + 1}$, where $D(\epsilon)$ is the density of orbitals. In two dimensions

$$\begin{aligned} n &= \frac{m}{\pi \hbar^2} \int_0^\infty d\epsilon \frac{1}{e^{(\epsilon-\mu)/\tau} + 1} \\ &= \frac{m}{\pi \hbar^2} (\mu + \tau \log(1 + e^{-\mu/\tau})), \end{aligned}$$

where the definite integral is evaluated with the help of Dwight [569.1].

4a. In the sun there are $\frac{2 \times 10^{33}}{1.7 \times 10^{-24}} \approx 10^{57}$ nucleons, and roughly an equal number of electrons. In a white dwarf star of volume

$$\frac{4\pi}{3}(2 \times 10^9)^3 \approx 3 \times 10^{28} \text{ cm}^3$$

the electron concentration is $\approx \frac{10^{57}}{3 \times 10^{28}} \approx 3 \times 10^{28} \text{ cm}^{-3}$. Thus

$$\epsilon_F = \frac{\hbar^2}{2m} (3\pi^2 n)^{2/3} \approx \frac{1}{2} 10^{-27} \cdot 10^{20} \approx \frac{1}{2} 10^{-7} \text{ ergs, or } \approx 3 \cdot 10^4 \text{ eV. (b) The value of } k_F \text{ is not}$$

affected by relativity and is $\approx n^{1/3}$, where n is the electron concentration. Thus $\epsilon_F \approx \hbar c k_F \approx \hbar c^3 \sqrt[3]{n}$. (c) A change of radius to $10 \text{ km} = 10^6 \text{ cm}$ makes the volume $\approx 4 \times 10^{18} \text{ cm}^3$ and the concentration $\approx 3 \times 10^{38} \text{ cm}^{-3}$. Thus $\epsilon_F \approx 10^{-27} (3 \cdot 10^{10})(10^{13}) \approx 2 \cdot 10^{-4} \text{ erg} \approx 10^8 \text{ eV}$. (The energy is relativistic.)

5. The number of moles per cm^3 is $81 \times 10^{-3}/3 = 27 \times 10^{-3}$, so that the concentration is $16 \times 10^{21} \text{ atoms cm}^{-3}$. The mass of an atom of He^3 is $(3.017)(1.661) \times 10^{-24} = 5.01 \times 10^{-24} \text{ g}$. Thus $\epsilon_F \approx [(1.1 \times 10^{-54})/10^{-23}][(30)(16) \times 10^{21}]^{2/3} \approx 7 \times 10^{-16} \text{ erg, or } T_F \approx 5\text{K}$.

6. Let E, v vary as $e^{-i\omega t}$. Then

$$v = -\frac{eE/m}{-i\omega + (1/\tau)} = -\frac{e\tau E}{m} \cdot \frac{1 + i\omega\tau}{1 + (\omega\tau)^2},$$

and the electric current density is

$$j = n(-e)v = \frac{ne^2\tau}{m} \cdot \frac{1 + i\omega\tau}{1 + (\omega\tau)^2} E.$$

7. (a) From the drift velocity equation

$$i\omega v_x = (e/m)E_x + \omega_c v_y ; i\omega v_y = (e/m)E_y - \omega_c v_x.$$

We solve for v_x, v_y to find

$$(\omega_c^2 - \omega^2)v_x = i\omega(e/m)E_x + \omega_c(e/m)E_y ;$$

$$(\omega_c^2 - \omega^2)v_y = i\omega(e/m)E_y + \omega_c(e/m)E_x .$$

We neglect the terms in ω_c^2 . Because $j = n(-e)v = \sigma E$, the components of σ come out directly. (b) From the electromagnetic wave equation

$$c^2 \nabla^2 E = \epsilon \partial^2 E / \partial t^2,$$

we have, for solutions of the form $e^{i(kz - \omega t)}$, the determinantal equation

$$\begin{vmatrix} \epsilon_{xx} \omega^2 - c^2 k^2 & \epsilon_{xy} \omega^2 \\ \epsilon_{yx} \omega^2 & \epsilon_{yy} \omega^2 - c^2 k^2 \end{vmatrix} = 0.$$

Here $\epsilon_{xx} = \epsilon_{yy} = 1 - \omega_p^2/\omega^2$ and $\epsilon_{xy} = -\epsilon_{yx} = i\omega_c\omega_p^2/\omega^3$. The determinantal equation gives the dispersion relation.

8. The energy of interaction with the ion is

$$e \int_0^{r_0} (\rho/r) 4\pi r^2 dr = -3e^2/2r_0 ,$$

where the electron charge density is $-e(3/4\pi r_0^3)$. (b) The electron self-energy is

$$\rho^2 \int_0^{r_0} dr (4\pi r^3/3)(4\pi r^2) r^{-1} = 3e^2/5r_0 .$$

The average Fermi energy per electron is $3\epsilon_F/5$, from Problem 6.1; because $N/V = 3/4\pi r_0^3$, the average is $3(9\pi/4)^{2/3} \hbar^2/10m r_0^2$. The sum of the Coulomb and kinetic contributions is

$$U = -\frac{1.80}{r_s} + \frac{2.21}{r_s^2}$$

which is a minimum at

$$\frac{1.80}{r_s^2} = \frac{4.42}{r_s^3}, \text{ or } r_s = 4.42/1.80 = 2.45.$$

The binding energy at this value of r_s is less than 1 Ry; therefore separated H atoms are more stable.

9. From the magnetoconductivity matrix we have

$$j_y = \sigma_{yx} E_x = \frac{\omega_c \tau}{1 + (\omega_c \tau)^2} \sigma_0 E_x .$$

For $\omega_c \tau \gg 1$, we have $\sigma_{yx} \cong \sigma_0/\omega_c \tau = (ne^2 \tau/m)(mc/eB\tau) = neB/c$.

10. For a monatomic metal sheet one atom in thickness, $n \approx 1/d^3$, so that

$$R_{sq} \approx mv_F/nd^2 e^2 \approx mv_F d/e^2 .$$

If the electron wavelength is d , then $mv_F d \approx \hbar$ by the de Broglie relation and

$$R_{sq} \approx \hbar/e^2 = 137/c$$

in Gaussian units. Now

$$\begin{aligned} R_{\text{sq}}(\text{ohms}) &= 10^{-9} c^2 R_{\text{sq}}(\text{gaussian}) \\ &\approx (30)(137)\text{ohms} \\ &\approx 4.1\text{k}\Omega . \end{aligned}$$

CHAPTER 7

1a. The wavevector at the corner is longer than the wavevector at the midpoint of a side by the factor $\sqrt{2}$. As $\epsilon \propto k^2$ for a free electron, the energy is higher by $(\sqrt{2})^2 = 2$. b. In three dimensions the energy at a corner is higher by $(\sqrt{3})^2$ than at the midpoint of a face. c. Unless the band gap at the midpoint of a face is larger than the kinetic energy difference between this point and a corner, the electrons will spill over into the second zone in preference to filling up the corner states in the first zone. Divalent elements under these conditions will be metals and not insulators.

2. $\epsilon = \hbar^2 k^2 / 2m$, where the free electron wavevector k may be written as the sum of a vector K in the reduced zone and of a reciprocal lattice vector G . We are interested in K along the $[111]$ direction: from

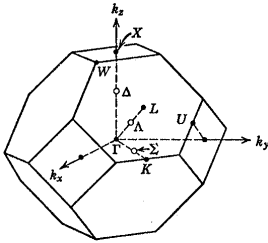

Chap. 2, $K = (2\pi/a)(1,1,1)u$, with $0 < u < \frac{1}{2}$, will lie in the reduced zone.

The G 's of the reciprocal lattice are given by $G = (2\pi/a)[(h-k+l)\hat{x} + (h+k-l)\hat{y} + (-h+k+l)\hat{z}]$, where h, k, l are any integers. Then $\epsilon = (\hbar^2/2m)$

$$(2\pi/a)^2 [(u+h-k+l)^2 + (u+h+k-l)^2 + (u-h+k+l)^2].$$

We now have to consider all combinations of indices h, k, l for which the term in brackets is smaller than $6[3(1/2)^2]$ or $9/2$. These indices are (000) ; $(\bar{1}\bar{1}\bar{1})$; $(\bar{1}00)$, $(0\bar{1}0)$, and $(00\bar{1})$; (100) , (010) , and (001) ; (111) ; $(\bar{1}\bar{1}0)$, $(\bar{1}0\bar{1})$, and $(0\bar{1}\bar{1})$; (110) , (101) , and (011) .

3. (a) At $k = 0$ the determinantal equation is $(P/Ka) \sin Ka + \cos Ka = 1$. In the limit of small positive P this equation will have a solution only when $Ka \ll 1$. Expand the sine and cosine to obtain in lowest order

$$P \approx \frac{1}{2}(Ka)^2. \quad \text{The energy is } \epsilon =$$

$\hbar^2 K^2 / 2m \approx \hbar^2 P / ma^2$. (b) At $k = \pi/a$ the determinantal equation is $(P/Ka) \sin Ka + \cos Ka = -1$. In the same limit this equation has solutions $Ka = \pi + \delta$, where $\delta \ll 1$. We expand to obtain

$$(P/\pi)(-\delta) + \left(-1 + \frac{1}{2}\delta^2\right) = -1, \text{ which has the solution } \delta = 0 \text{ and } \delta = 2P/\pi. \text{ The energy gap is}$$

$$E_g = (\hbar^2/2ma^2)(2\pi\delta) = (\hbar^2/2ma^2)(4P).$$

4. (a) There are two atoms in the basis, and we label them a and b . Then the crystal potential may be written as $U = U_1 + U_2 = U_1(\mathbf{r}) + U_1\left(x + \frac{1}{4}a, y + \frac{1}{4}a, z + \frac{1}{4}a\right)$ and the Fourier transform has

components $U_{\mathbf{G}} = U_{1\mathbf{G}} + U_{2\mathbf{G}} = U_{1\mathbf{G}} \left(1 + e^{i(G_x + G_y + G_z)\frac{1}{4}a}\right)$. If $\mathbf{G} = 2A\hat{x}$, then the exponential is

$e^{i\frac{1}{2}Aa} = e^{i\pi} = -1$, and $U_{\mathbf{G}=2A} = 0$, so that this Fourier component vanishes. Note that the quantity in parentheses above is just the structure factor of the basis. (b) This follows directly from (44) with U set equal to zero. In a higher order approximation we would go back to Eq. (31) where any non-vanishing $U_{\mathbf{G}}$ enters.

5. Let $\mathbf{k} = \mathbf{K} + i\mathbf{H}$; $\lambda_{\pm 1} = \frac{\hbar^2}{2m} \left[\left(\frac{1}{2} \mathbf{G} \right)^2 \pm i\mathbf{GH} - H^2 \right]$.

The secular equation (46) is now

$$\begin{vmatrix} \lambda_1 - \varepsilon & U \\ U & \lambda_{-1} - \varepsilon \end{vmatrix} = 0,$$

and for $H \ll G$ we have, with $\sigma = \varepsilon - \frac{\hbar^2}{2m} \left(\frac{1}{2} \mathbf{G} \right)^2$,

$$\left(\sigma + i\mathbf{GH} \cdot \frac{\hbar^2}{2m} \right) \left(\sigma - i\mathbf{GH} \cdot \frac{\hbar^2}{2m} \right) = U_1^2;$$

$$\sigma^2 - \left(\frac{\hbar^2}{2m} \mathbf{GH} \right)^2 = U_1^2;$$

$$\therefore \frac{\hbar^2}{2m} H^2 = \frac{U_1^2 - \sigma}{\frac{\hbar^2}{2m} G^2}.$$

6. $U(x,y) = -U[e^{i(2\pi/a)(x+y)} + \text{other sign combinations of } \pm x \pm y]$. The potential energy contains the four reciprocal lattice vectors $(2\pi/a)(\pm 1; \pm 1)$. At the zone corner the wave function $e^{i(\pi/a)(x+y)}$ is mixed with $e^{-i(\pi/a)(x+y)}$. The central equations are

$$(\lambda - \varepsilon) \mathcal{C} \left[\frac{\pi}{a}; \frac{\pi}{a} \right] - U \mathcal{C} \left[-\frac{\pi}{a}; -\frac{\pi}{a} \right] = 0;$$

$$(\lambda - \varepsilon) \mathcal{C} \left[-\frac{\pi}{a}; -\frac{\pi}{a} \right] - U \mathcal{C} \left[\frac{\pi}{a}; \frac{\pi}{a} \right] = 0,$$

where $\lambda = 2 \left(\hbar^2 / 2m \right) (\pi/a)^2$. The gap is $2U$.

CHAPTER 8

1a. $E_d = 13.60 \text{ eV} \times \frac{m^*}{m} \times \frac{1}{\epsilon^2} \approx 6.3 \times 10^{-4} \text{ eV}$

b. $r = a_H \times \epsilon \times \frac{m}{m^*} \approx 6 \times 10^{-6} \text{ cm}$

c. Overlap will be significant at a concentration

$$N = \frac{1}{\frac{4\pi}{3} r^3} \approx 10^{15} \text{ atoms cm}^{-3}$$

2a. From Eq. (53), $n \approx (n_0 N_d)^{1/2} e^{-E_d/2k_B T}$, in an approximation not too good for the present example.

$$n_0 \equiv 2 \left(\frac{m^* k_B T}{2\pi \hbar^2} \right)^{3/2} \approx 4 \times 10^{13} \text{ cm}^{-3};$$

$$\frac{E_d}{2k_B T} \approx 1.45; \quad e^{-1.45} \approx 0.23.$$

$$n \approx 0.46 \times 10^{13} \text{ electrons cm}^{-3}.$$

b. $R_H = -\frac{1}{nec} \approx -1.3 \times 10^{-14} \text{ CGS units}$

3. The electron contribution to the transverse current is

$$j_y(e) \approx ne\mu_e \left(\frac{\mu_e B}{c} E_x + E_y \right);$$

for the holes $j_y(h) \approx ne\mu_h \left(\frac{-\mu_h B}{c} E_x + E_y \right).$

Here we have used

$$\omega_{ce} \tau_e = \frac{\mu_e B}{c} \text{ for electrons; } \quad \omega_{ch} \tau_h = \frac{\mu_h B}{c} \text{ for holes.}$$

The total transverse (y-direction) current is

$$0 = (ne\mu_e^2 - pe\mu_h^2)(B/c)E_x + (ne\mu_e + pe\mu_h)E_y, \quad (*)$$

and to the same order the total current in the x-direction is

$$j_x = (pe\mu_h + ne\mu_e)E_x.$$

Because (*) gives

$$E_y = E_x B \frac{p\mu_h^2 - n\mu_e^2}{p\mu_h + n\mu_e} \cdot \frac{1}{c},$$

we have for the Hall constant

$$R_H = \frac{E_y}{j_x B} = \frac{1}{ec} \cdot \frac{p\mu_h^2 - n\mu_e^2}{(p\mu_h + n\mu_e)^2}.$$

4. The velocity components are $v_x = \hbar k_x / m_t$; $v_y = \hbar k_y / m_t$; $v_z = \hbar k_z / m_\ell$. The equation of motion in k space is $\hbar dk/dt = -(e/c)v \times B$. Let B lie parallel to the k_x axis; then $dk_x/dt = 0$; $dk_y/dt = -\omega_\ell k_z$; $\omega_\ell \equiv eB/m_\ell c$; $dk_z/dt = \omega_t k_y$; $\omega_t \equiv eB/m_t c$. We differentiate with respect to time to obtain $d^2 k_y/dt^2 = -\omega_\ell dk_z/dt$; on substitution for dk_z/dt we have $d^2 k_y/dt^2 + \omega_\ell \omega_t k_y = 0$, the equation of motion of a simple harmonic oscillator of natural frequency

$$\omega_0 = (\omega_\ell \omega_t)^{1/2} = eB/(m_\ell m_t)^{1/2} c.$$

5. Define $Q_e \equiv eB\tau_e/m_e c$; $Q_h \equiv eB\tau_h/m_h c$. In the strong field limit $Q \gg 1$ the magnetoconductivity tensor (6.64) reduces to

$$\sigma \approx \frac{ne^2\tau_e}{m_e} \begin{pmatrix} Q_e^{-2} & -Q_e^{-1} & 0 \\ Q_e^{-1} & Q_e^{-2} & 0 \\ 0 & 0 & 1 \end{pmatrix} + \frac{pe^2\tau_h}{m_h} \begin{pmatrix} Q_h^{-2} & Q_h^{-1} & 0 \\ -Q_h^{-1} & Q_h^{-2} & 0 \\ 0 & 0 & 1 \end{pmatrix}.$$

We can write $ne^2\tau_e/m_e$ for $ne^2\tau_e/m_e$ and $pe^2\tau_h/m_h$ for $pe^2\tau_h/m_h$. The strong field limit for σ_{yx} follows directly. The Hall field is obtained when we set

$$j_y = 0 = \frac{ec}{H} \left[(n-p)E_x + \left(\frac{n}{Q_e} + \frac{p}{Q_h} \right) E_y \right].$$

The current density in the x direction is

$$j_x = \frac{ec}{B} \left[\left(\frac{n}{Q_e} + \frac{p}{Q_h} \right) E_x - (n-p)E_y \right];$$

using the Hall field for the standard geometry, we have

$$j_x = \frac{ec}{H} \left[\left(\frac{n}{Q_e} + \frac{p}{Q_h} \right) + \frac{(n-p)^2}{\left(\frac{n}{Q_e} + \frac{p}{Q_h} \right)} \right] E_x.$$

CHAPTER 9

1.

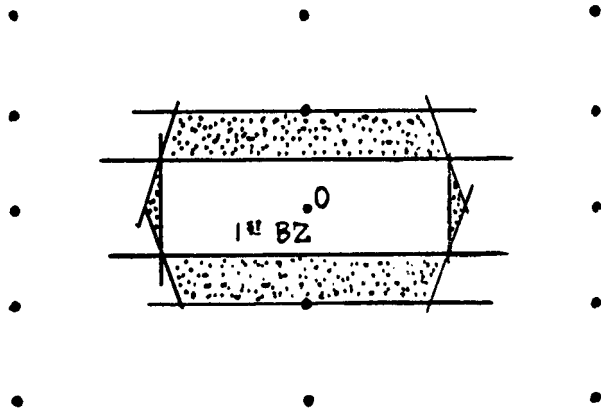

2a.

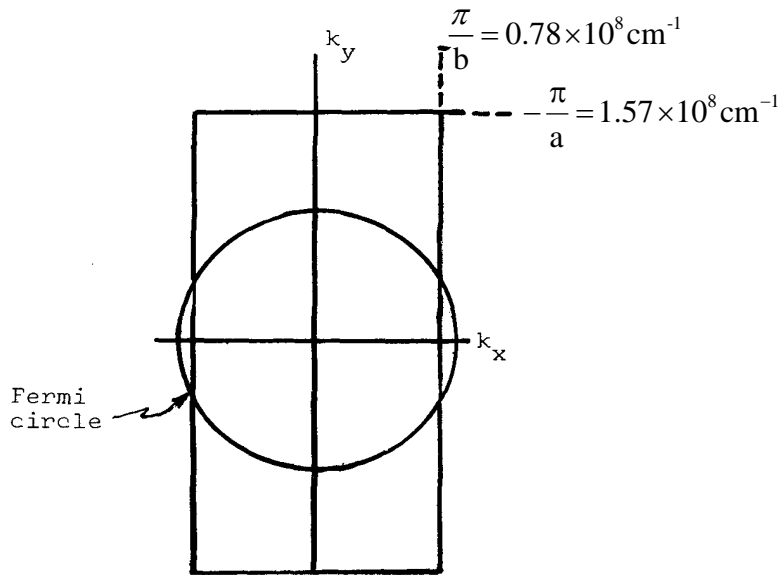

b.

$$N = 2 \times \frac{\pi k_F^2}{(2\pi/k)^2}$$

$$n = N/L^2 = k_F^2 / 2\pi$$

$$k_F = \sqrt{2\pi n}$$

$$n = \frac{1}{8} \times 10^{16} \text{ els/cm}^2$$

$$k_F = 0.89 \times 10^8 \text{ cm}^{-1}$$

c.

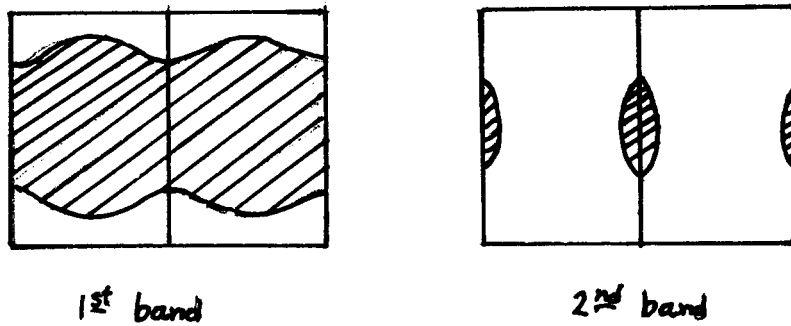

3a. In the hcp structure there is one atom whose z coordinate is 0 and one at $\frac{1}{2}c$. The structure factor of the basis for $\underline{G}_c = \frac{2\pi}{c} \hat{z}$ is

$$S_{\underline{G}_c}(\text{basis}) = 1 + e^{-i\pi} = 1 - 1 = 0,$$

so that by the same argument as in Problem 9.4 the corresponding component $U_{\underline{G}_c}$ of the crystal potential is zero.

b. But for $U_{2\underline{G}_c}$ the structure factor is

$$S_{2\underline{G}_c}(\text{basis}) = 1 + e^{-i2\pi} = 2.$$

c. The two valence electrons can just fill the first BZ. All we need is an adequate energy gap at the zone boundary and for simple hex. there is no reason against a gap.

d. In hcp there will be no gap (at least in lowest order) on the top and bottom faces of the BZ, by the argument of part a.

4.

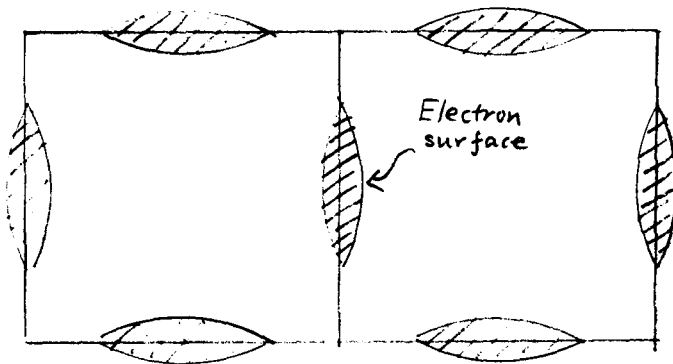
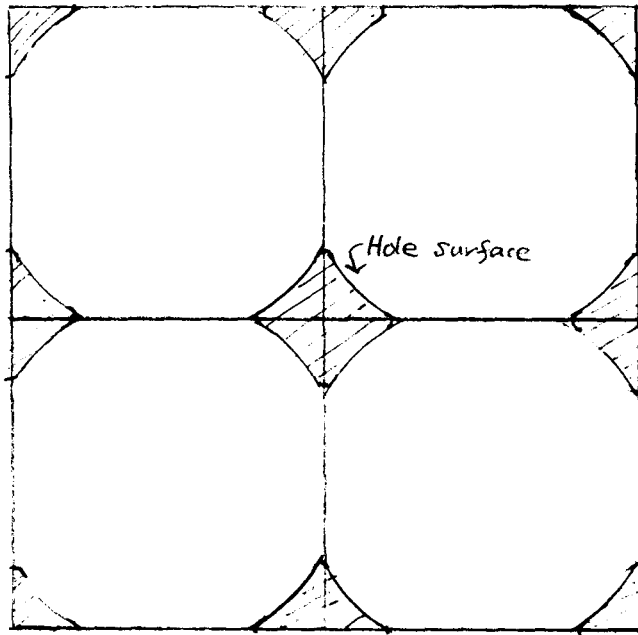

$$5a. \hbar \frac{dk}{dt} = -\frac{e}{c} \vec{v} \times \vec{B};$$

$$T = \frac{\hbar G c}{e v B}$$

$$\approx \frac{10^{-27} \text{ erg sec} (2 \times 10^8 \text{ cm}^{-1}) (3 \times 10^{10} \text{ cm s}^{-1})}{(5 \times 10^{-10} \text{ esu}) (10^8 \text{ cm d}^{-1}) (10^3 \text{ gauss})}$$

$$\approx 1.2 \times 10^{-10} \text{ sec.}$$

b. The electron moves in a direction normal to the Fermi surface -- more or less in a straight line if the Fermi surface is close to planar in the region of interest. The magnetic field puts a wiggle on the motion, but the field does not make the electron move in a helix, contrary to the behavior of a free electron.

6a.

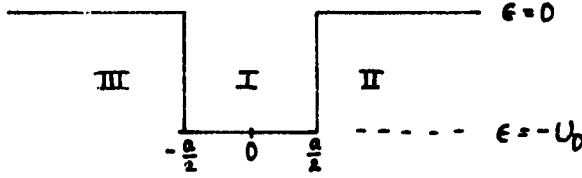

Region I:

$$\left(-\frac{\hbar^2}{2m} \frac{d^2}{dx^2} - U_0 \right) \psi = \varepsilon \psi$$

$$\psi = A \cos kx ; \quad \varepsilon = \frac{\hbar^2 k^2}{2m} - U_0 (*)$$

Region II:

$$-\frac{\hbar^2}{2m} \frac{d^2}{dx^2} \psi = \varepsilon \psi \quad (*)$$

$$\psi = B e^{-qx} ; \quad \varepsilon = -\frac{\hbar^2 q^2}{2m}$$

Boundary condition $\frac{1}{\psi} \frac{d\psi}{dx}$ continuous.

$$k \tan(ka/2) = q, \quad (**)$$

with k and q related to ε as above.

b. The lazy way here is to show that the ε 's in the equations marked (*) above are equal when k and q are connected by (**), with $\varepsilon = -0.45$ as read off Fig. 20. This is indeed so.

7a. $\Delta\left(\frac{1}{H}\right) = \frac{2\pi e}{\hbar c S}$, where $S = \pi k_F^2$, with $k_F = 0.75 \times 10^8 \text{ cm}^{-1}$ from Table 6.1, for potassium. Thus

$$\Delta\left(\frac{1}{H}\right) \approx \frac{2}{137 k_F^2 e} \approx 0.55 \times 10^{-8} \text{ G}^{-1}.$$

b.

$$\begin{aligned}\omega_c R &= v_F ; \quad R = \frac{v_F m c}{e B} = \frac{\hbar k_F c}{e B} \\ &\approx 0.5 \times 10^{-3} \text{ cm} \\ \pi R^2 &\approx 0.7 \times 10^{-6} \text{ cm}^2.\end{aligned}$$

8. Write (17) as $H = H_0 + H_1$, where $H_1 = (\hbar/m) \underline{k} \cdot \underline{p}$. Then (18) is an eigenfunction of H_0 with the eigenvalue $\varepsilon_n(0) + \hbar^2 k^2 / 2m$. In this representation the diagonal matrix element of H_1 is equal to $(\hbar/m) \int dV \underline{u}_0(\underline{r}) \underline{k} \cdot \underline{p} U_0(\underline{r})$. In a cubic crystal $U_0(\underline{r})$ will be even or odd with respect to the inversion operation $\underline{r} \rightarrow -\underline{r}$, but \underline{p} is an odd operator. It follows that the diagonal matrix element vanishes, and there is no first-order correction to the energy. The function $U_{\underline{k}}(\underline{r})$ to first order in H_1 is

$$U_{\underline{k}}(\underline{r}) = U_0(\underline{r}) + \sum'_j \frac{\langle j0 | H_1 | n0 \rangle}{\varepsilon_n(0) - \varepsilon_j(0)},$$

and the energy to second order is

$$\varepsilon_n(\underline{k}) = \varepsilon_n(0) + (\hbar k)^2 / 2m + (\hbar/m)^2 \sum'_j \frac{|\langle n0 | \underline{k} \cdot \underline{p} | j0 \rangle|^2}{\varepsilon_n(0) - \varepsilon_j(0)}.$$

The effective mass ratio is the coefficient of $\hbar^2 k^2 / 2m$, or

$$\frac{m}{m^*} = 1 + \frac{2}{m} \sum'_j \frac{|\langle n0 | \underline{p} | j0 \rangle|^2}{\varepsilon_n(0) - \varepsilon_j(0)}.$$

9a.

$$\begin{aligned}&\int dV w^*(\underline{r} - \underline{r}_n) w(\underline{r} - \underline{r}_m) \\ &= N^{-1} \sum_{\underline{k}} \sum_{\underline{k}'} e^{i\mathbf{k}' \cdot \underline{r}_n} e^{-i\mathbf{k} \cdot \underline{r}_m} \int dV \psi_{\underline{k}'}^*(\underline{r}) \psi_{\underline{k}}(\underline{r}) \\ &= N^{-1} \sum_{\underline{k}} e^{i\mathbf{k} \cdot (\underline{r}_n - \underline{r}_m)}\end{aligned}$$

where the summation is zero unless $n = m$, when it is equal to N .

b. $w(\underline{x} - \underline{x}_n) = N^{-1/2} U_0(\underline{x}) \sum_{\underline{k}} e^{i\mathbf{k} \cdot (\underline{x} - \underline{x}_n)}$. The summation is

equal to

$$\begin{aligned} \sum_P e^{i2\pi p(x-x_n)/Na} &\simeq \int_{-N/2}^{N/2} e^{i2\pi p(x-x_n)/Na} dp \\ &= \frac{e^{i\pi(x-x_n)/a} - e^{-i\pi(x-x_n)/a}}{i2\pi(x-x_n)/Na} = \frac{\sin [\pi(x-x_n)/a]}{\pi(x-x_n)/Na}, \end{aligned}$$

whence

$$w(x-x_n) = N^{1/2} u_0(x) \frac{\sin [\pi(x-x_n)/a]}{\pi(x-x_n)/a}.$$

10a. $j_y = \sigma_0 (Q^{-1} E_x + sE_y) = 0$ in the Hall geometry, whence $E_y = -E_x/sQ$.

b. We have $j_x = \sigma_0 (Q^{-2} E_x - Q^{-1} E_y)$, and with our result for E_y it follows that

$$j_x = \sigma_0 (Q^{-2} + s^{-1}Q^{-2}) E_x,$$

whence $\rho = E_x/j_x = (Q^2/\sigma_0) \frac{s}{s+1}$.

CHAPTER 10

1a. $\frac{d^2\mathbf{B}}{dx^2} = \frac{1}{\lambda^2}\mathbf{B}$; this is the London equation. The proposed solution is seen directly to satisfy this and to satisfy the boundary conditions $\mathbf{B}\left(\pm\frac{1}{2}\delta\right) = \mathbf{B}_a$. (b) For $\delta \ll \lambda_L$,

$$\cosh \frac{x}{\lambda} = 1 + \frac{1}{2} \left(\frac{x}{\lambda_L} \right)^2 + \dots$$

$$\cosh \frac{\delta}{2\lambda} = 1 + \frac{1}{2} \left(\frac{\delta}{2\lambda} \right)^2 + \dots$$

therefore $\mathbf{B}(x) = \mathbf{B}_a - \mathbf{B}_a (1/8\lambda^2)(\delta^2 - 4x^2)$.

2a. From (4), $dF_S = -\mathbf{M}d\mathbf{B}_a$ at $T = 0$. From Problem 1b,

$$\mathbf{M}(x) = -\frac{1}{4\pi} \cdot \frac{1}{8\lambda^2} \mathbf{B}_a \cdot (\delta^2 - 4x^2),$$

whence

$$F_S(x, \mathbf{B}_a) - F_S(0) = \frac{1}{64\pi\lambda^2} (\delta^2 - 4x^2) \mathbf{B}_a^2.$$

b. The average involves

$$\frac{\int_0^{1/2\delta} (\delta^2 - 4x^2) dx}{\frac{1}{2}\delta} = \frac{\frac{1}{2}\delta^3 - \frac{4}{3} \cdot \frac{\delta^3}{8}}{\frac{1}{2}\delta} = \frac{2}{3}\delta^2,$$

whence

$$\langle \Delta F \rangle = \frac{1}{96\pi} \mathbf{B}_a^2 \left(\frac{\delta}{\lambda} \right)^2, \text{ for } \delta \ll \lambda.$$

c. Let us set

$$\frac{1}{96\pi} \mathbf{B}_{af}^2 \left(\frac{\delta}{\lambda} \right)^2 = \frac{1}{8\pi} \mathbf{B}_{ac}^2,$$

where B_{af} is the critical field for the film and B_{ac} is the bulk critical field. Then

$$B_{af} = \sqrt{12} \cdot \frac{\lambda}{\delta} B_{ac}.$$

$$3a. \text{ (CGS) } \text{curl } \mathbf{H} = \frac{4\pi\mathbf{j}}{c} + \frac{1}{c} \frac{\partial \mathbf{E}}{\partial t} = \frac{4\pi}{c} \left(\sigma_0 \mathbf{E} - \frac{c}{4\pi\lambda^2} \mathbf{A} \right) + \frac{1}{c} \frac{\partial \mathbf{E}}{\partial t}.$$

$$\text{curl curl } \mathbf{H} = -\nabla^2 \mathbf{H} = \frac{4\pi}{c} \left(\sigma_0 \text{curl } \mathbf{E} - \frac{c}{4\pi\lambda^2} \mathbf{B} \right) + \frac{1}{c} \frac{\partial \text{curl } \mathbf{E}}{\partial t}.$$

Now in CGS in nonmagnetic material \mathbf{B} and \mathbf{H} are identical. We use this and we use the Maxwell equation

$$\text{curl } \mathbf{E} = -\frac{1}{c} \frac{\partial \mathbf{B}}{\partial t}$$

to obtain

$$\nabla^2 \mathbf{B} - \frac{1}{\lambda^2} \mathbf{B} - \frac{1}{c^2} \frac{\partial^2 \mathbf{B}}{\partial t^2} - \frac{4\pi\sigma_0}{c^2} \frac{\partial \mathbf{B}}{\partial t} = 0.$$

If $\mathbf{B} \sim e^{i(\mathbf{k} \cdot \mathbf{r} - \omega t)}$, then

$$-k^2 - \frac{1}{\lambda^2} + \frac{\omega^2}{c^2} + \frac{4\pi i \sigma_0 \omega}{c^2} = 0. \quad \text{Q.E.D.}$$

$$b. \frac{1}{\lambda^2} = \frac{\omega_p^2}{c^2} \gg \frac{\omega^2}{c^2}; \text{ also, } \omega^2 \ll 4\pi\sigma_0\omega \text{ and } \frac{1}{\lambda^2} \gg \frac{4\pi\sigma_0\omega}{c^2}.$$

Thus the normal electrons play no role in the dispersion relation in the low frequency range.

4. The magnetic influence of the core may be described by adding the two-dimensional delta function $\Phi_0 \delta(\boldsymbol{\rho})$, where Φ_0 is the flux quantum. If the magnetic field is parallel to the z axis and $\text{div } \mathbf{B} = 0$, then

$$\mathbf{B} - \lambda^2 \nabla^2 \mathbf{B} = \Phi_0 \delta(\boldsymbol{\rho}),$$

or

$$\lambda^2 \left(\frac{\partial^2 \mathbf{B}}{\partial \rho^2} + \frac{1}{\rho} \frac{\partial \mathbf{B}}{\partial \rho} \right) - \mathbf{B} = -\Phi_0 \delta(\rho).$$

This equation has the solution $\mathbf{B}(\rho) = (\Phi_0/2\pi\lambda^2) K_0(\rho/\lambda)$, where K_0 is a hyperbolic Bessel function * infinite at the origin and zero at infinity:

$$\begin{aligned} (\rho \ll \lambda) \mathbf{B}(\rho) &\approx (\Phi_0/2\pi\lambda^2) \ell n(\lambda/\rho); \\ (\rho \gg \lambda) \mathbf{B}(\rho) &\approx (\Phi_0/2\pi\lambda^2) (\pi\lambda/2\rho)^{1/2} \exp(-\rho/\lambda). \end{aligned}$$

The total flux is the flux quantum:

$$2\pi \int_0^\infty d\rho \rho \mathbf{B}(\rho) = \Phi_0 \int_0^\infty dx x K_0(x) = \Phi_0.$$

5. It is a standard result of mechanics that $\mathbf{E} = -\text{grad } \varphi - c^{-1} \partial \mathbf{A} / \partial t$. If $\text{grad } \varphi = 0$, when we differentiate the London equation we obtain $\partial \mathbf{j} / \partial t = (c^2/4\pi\lambda_L^2) \mathbf{E}$. Now $\mathbf{j} = nq\mathbf{v}$ and $\partial \mathbf{j} / \partial t = nq \partial \mathbf{v} / \partial t = (nq^2/m) \mathbf{E}$. Compare the two equations for $\partial \mathbf{j} / \partial t$ to find $c^2/4\pi\lambda_L^2 = nq^2/m$.

* Handbook of mathematical functions, U.S. National Bureau of Standards AMS 55, sec. 9.6.

6. Let x be the coordinate in the plane of the junction and normal to \mathbf{B} , with $-w/2 \leq x \leq w/2$. The flux through a rectangle of width $2x$ and thickness T is $2xTB = \phi(x)$. The current through two elements at x and $-x$, each of width dx is

$$dJ = (J_0/w) \cos[e\phi(x)/\hbar c] dx = (J_0/w) \cos(2xTeB/\hbar c) dx,$$

and the total current is

$$J = (J_0/w) \int_0^{w/2} \cos(xTeB/\hbar c) dx = J_0 \frac{\sin(wTBe/\hbar c)}{(wTBe/\hbar c)}.$$

7a. For a sphere $H(\text{inside}) = B_a - 4\pi M/3$; for the Meissner effect $H(\text{inside}) = -4\pi M$, whence $B_a = -8\pi M/3$.

b. The external field due to the sphere is that of a dipole of moment $\mu = MV$, when V is the volume. In the equatorial plane at the surface of the sphere the field of the sphere is $-\mu/a^3 = -4\pi M/3 = B_a/2$. The total field in this position is $3B_a/2$.

CHAPTER 11

1. From Eq. (10),

$$\chi = -N \frac{e^2}{6mc^2} \langle r^2 \rangle.$$

$$\text{Here } \langle r^2 \rangle = \frac{1}{\pi a_0^3} \cdot 4\pi \int_0^\infty r^2 dr \cdot e^{-2r/a_0} = 3a_0^2.$$

The numerical result follows on using $N = 6.02 \times 10^{23} \text{ mol}^{-1}$.

2a. Eu^{++} has a half-filled f shell. Thus $S = 7 \times 1/2 = 7/2$. The orbitals $m_L = 3, 2, 1, 0, -1, -2, -3$ have one spin orientation filled, so that $L = \Sigma m_L = 0$. Also $J = L + S = 7/2$. Hence the ground state is $^8S_{7/2}$.

b. Yb^{+++} has 13 electrons in the f shell, leaving one hole in the otherwise filled shell. Thus $L = 3$, $S = 1/2$, $J = 7/2$ -- we add S to L if the shell is more than half-filled. The ground state symbol is $^2F_{7/2}$.

c. Tb^{+++} has 8 f electrons, or one more than Eu^{++} . Thus $L = 3$; $S = 7/2 - 1/2 = 3$; and $J = 6$. The ground state is 7F_6 .

3a. The relative occupancy probabilities are

$$\begin{aligned} & \frac{e^{-(\Delta+\mu B)/kT}}{e^{-(\Delta+\mu B)/kT} + e^{-\Delta/kT} + e^{-(\Delta-\mu B)/kT} + 1} \quad (\text{Here } \Delta \text{ stands for } k_B \Delta) \\ & \frac{e^{-\Delta/kT}}{e^{-(\Delta+\mu B)/kT} + e^{-\Delta/kT} + e^{-(\Delta-\mu B)/kT} + 1} \\ & \frac{e^{-(\Delta-\mu B)/kT}}{e^{-(\Delta+\mu B)/kT} + e^{-\Delta/kT} + e^{-(\Delta-\mu B)/kT} + 1} \\ & \frac{1}{e^{-(\Delta+\mu B)/kT} + e^{-\Delta/kT} + e^{-(\Delta-\mu B)/kT} + 1} \end{aligned}$$

The average magnetic moment is

$$\langle \mu \rangle = \mu \frac{e^{-(\Delta-\mu B)/kT} - e^{-(\Delta+\mu B)/kT}}{Z}$$

$$\text{where } Z = 1 + e^{-(\Delta-\mu B)/kT} + e^{-\Delta/kT} + e^{-(\Delta+\mu B)/kT}.$$

b. At high temperatures $e^{-\Delta/kT} \rightarrow 1$ and

$$\langle \mu \rangle \rightarrow \mu \cdot \frac{\left(1 + \frac{\mu B}{kT} + \dots\right) - \left(1 - \frac{\mu B}{kT} + \dots\right)}{4}$$

$$= \frac{\mu^2 B}{2kT}; \quad \chi \rightarrow \frac{N\mu^2}{2kT}.$$

c. The energy levels as a function of field are:

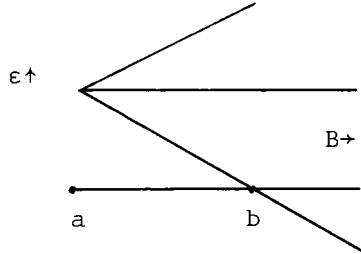

If the field is applied to take the system from a to b we increase the entropy of the spin system from ≈ 0 to $\approx N \log 2$. If the magnetization is carried out constant total entropy, it is necessary that the lattice entropy be reduced, which means the temperature \downarrow .

$$4a. Z = 1 + e^{-\Delta/T};$$

$$E = \frac{k_B \Delta e^{-\Delta/T}}{1 + e^{-\Delta/T}} = \frac{k_B \Delta}{e^{\Delta/T} + 1}$$

$$C = \left(\frac{\partial E}{\partial T} \right)_\Delta = k_B \Delta \frac{\frac{\Delta}{T^2} e^{\Delta/T}}{(e^{\Delta/T} + 1)^2}.$$

$$b. \text{ For } \Delta/T \ll 1, e^{\Delta/T} \rightarrow 1 \text{ and } C \rightarrow \frac{1}{4} k_B \left(\frac{\Delta}{T} \right)^2.$$

5a. If the concentration in the spin-up band is $N^+ = 1/2 N (1 + \zeta)$, the kinetic energy of all the electrons in that band is

$$\frac{3}{5} N^+ \frac{\hbar^2}{2m} (3\pi^2 N^+)^{2/3} = E_0 (1 + \zeta)^{5/3},$$

and the magnetic energy is $-N^+ \mu B = -1/2 N(1 + \zeta) \mu B$.

$$b. \text{ Now } E_{\text{tot}} = E_0 \left\{ (1 + \zeta)^{5/3} + (1 - \zeta)^{5/3} \right\} - N\zeta\mu B;$$

$$\frac{\partial E_{\text{tot}}}{\partial \zeta} = \frac{5}{3} E_0 \underbrace{\left\{ (1+\zeta)^{2/3} - (1-\zeta)^{2/3} \right\}}_{\frac{4}{3}\zeta} - N\mu B = 0$$

$$\therefore \zeta = \frac{9N\mu B}{20E_0} = \frac{3\mu B}{2\varepsilon_F}$$

$$M = N\mu\zeta = \frac{3N\mu^2}{2\varepsilon_F} B . \quad \text{Q.E.D.}$$

6a. The number of pairs of electrons with parallel spin up is

$$\frac{1}{2}(N^+)^2 = \frac{1}{8}N^2(1+\zeta)^2 ,$$

so that the exchange energy among the up spins is

$$-\frac{1}{8}VN^2(1+\zeta)^2 ;$$

and among the down spins the exchange energy is

$$-\frac{1}{8}VN^2(1-\zeta)^2 .$$

b. Using these results and those from Prob. 5 we have $E_{\text{tot}} = E_0 \left\{ (1+\zeta)^{5/3} + (1-\zeta)^{5/3} \right\}$

$-\frac{1}{8}VN^2(1+\zeta^2)2 - N\zeta\mu B$. Thus (for $\zeta \ll 1$)

$$\frac{\partial E_{\text{tot}}}{\partial \zeta} \approx \frac{20}{9}E_0\zeta - \frac{1}{2}VN^2\zeta - N\mu B = 0 ;$$

$$\begin{aligned} \zeta &= \frac{N\mu B}{\frac{20}{9}E_0 - \frac{1}{2}VN^2} \\ &= \frac{N\mu B}{\frac{2N\varepsilon_F}{3} - \frac{1}{2}VN^2} \end{aligned}$$

and

$$M = N\mu\zeta = \frac{3N\mu^2}{2\varepsilon_F - \frac{3}{2}VN} B$$

c. For $B = 0$ and $\zeta = 0$.

$$\frac{\partial^2 E_{\text{tot}}}{\partial \zeta^2} \approx \frac{20}{9} E_0 - \frac{1}{2} V N^2 < 0 \text{ if } V > \frac{40}{9} \frac{E_0}{N^2} = \frac{4}{3} \frac{^\circ\text{F}}{N}$$

7a. The Boltzmann factor gives directly, with $\tau = k_B T$

$$U = -\Delta \frac{e^{\Delta/\tau} - e^{-\Delta/\tau}}{e^{\Delta/\tau} + e^{-\Delta/\tau}} = -\Delta \tanh \Delta/\tau;$$

$$C = k_B \, dU/d\tau = k_B \left(\Delta/k_B T \right)^2 \text{sech}^2 \left(\Delta/k_B T \right),$$

because $d \tanh x/dx = \text{sech}^2 x$.

b. The probability $P(\Delta) \, d\Delta$ that the upper energy level lies between Δ and $\Delta + d\Delta$, referred to the midpoint as the zero of energy, is $P(\Delta) \, d\Delta = (d\Delta) / \Delta_0$. Thus, from (a),

$$\langle U \rangle = - \int_0^{\Delta_0} d\Delta \left(\Delta/\Delta_0 \right) \tanh \Delta/\tau,$$

$$\langle C \rangle = k_B \int_0^{\Delta_0} d\Delta \left(\Delta^2/\Delta_0 \tau^2 \right) \text{sech}^2 \left(\Delta/\tau \right)$$

$$= \left(k_B \tau / \Delta_0 \right) \int_0^{x_0} dx \, x^2 \text{sech}^2 x ,$$

where $x \equiv \Delta/\tau$. The integrand is dominated by contributions from $0 < \Delta < \tau$, because $\text{sech} \, x$ decreases exponentially for large values of x . Thus

$$\langle C \rangle \approx \left(k_B \tau / \Delta_0 \right) \int_0^{\infty} dx \, x^2 \text{sech}^2 x .$$

$$8. \frac{\langle \mu \rangle}{\mu} = \frac{e^{\mu B/\tau} - e^{-\mu B/\tau}}{1 + 2 \cosh x} = \frac{2 \sinh x}{1 + 2 \cosh x}$$

CHAPTER 12

1. We have $\mathcal{S}_{\rho+\delta} = \mathcal{S}_{\rho} e^{i\mathbf{k}\cdot\delta}$. Thus

$$\begin{aligned}\frac{d\mathcal{S}_{\rho}^x}{dt} &= \left(\frac{2JS}{\hbar}\right) \left(6 - \sum_{\delta} e^{i\mathbf{k}\cdot\delta}\right) \mathcal{S}_{\rho}^y \\ &= \left(\frac{2JS}{\hbar}\right) \left[6 - 2(\cos k_x a + \cos k_y a + \cos k_z a)\right] \mathcal{S}_{\rho}^y; \\ \frac{d\mathcal{S}_{\rho}^y}{dt} &= -\left(\frac{2JS}{\hbar}\right) \left[6 - 2(\cos k_x a + \cos k_y a + \cos k_z a)\right] \mathcal{S}_{\rho}^x.\end{aligned}$$

These equations have a solution with time-dependence $\sim \exp(-i\omega t)$ if

$$\omega = (2JS/\hbar) (6 - 2 \cos k_x a - 2 \cos k_y a - 2 \cos k_z a).$$

2. $U = \sum_{\mathbf{k}} n_{\mathbf{k}} \hbar \omega_{\mathbf{k}} = \hbar \int d\omega D(\omega) \omega \langle n(\omega) \rangle$. If $\omega = Ak^2$, then $d\omega/dk = 2Ak = 2\sqrt{A} \omega^{1/2}$, and

$$D(\omega) = \frac{4\pi}{8\pi^3} \frac{\omega}{A} \frac{1}{2\sqrt{A}\omega^{1/2}} = \frac{1}{4\pi^2} \frac{\omega^{1/2}}{A^{3/2}}.$$

Then

$$U = \frac{\hbar}{4\pi^2 A^{3/2}} \int d\omega \omega^{3/2} \frac{1}{e^{\beta\hbar\omega} - 1}.$$

At low temps,

$$\int \approx \frac{1}{(\hbar\beta)^{5/2}} \int_0^{\infty} dx \frac{x^{3/2}}{e^x - 1} = \frac{1}{(\hbar\beta)^{5/2}} \underbrace{\Gamma\left(\frac{5}{2}\right)}_{\text{gamma function}} \underbrace{\zeta\left(\frac{5}{2}; 1\right)}_{\text{zeta function}}$$

[See Dwight 860.39]

$$U \approx 0.45 (k_B T)^{5/2} / \pi^2 A^{3/2} \hbar^{3/2}$$

$$C = dU/dT \approx 0.113 k_B (k_B T/\hbar A)^{3/2}.$$

3.

$$M_A T = C(B - \mu M_B - \varepsilon M_A) \quad (B = \text{applied field})$$

$$M_B T = C(B - \varepsilon M_B - \mu M_A)$$

Non-trivial solution for $B = 0$ if

$$\begin{vmatrix} T + \varepsilon C & \mu C \\ \mu C & T + \varepsilon C \end{vmatrix} = 0; \quad T_C = C(\mu - \varepsilon)$$

Now find $\chi = (M_A + M_B)/B$ at $T > T_C$:

$$MT = 2CH - CM(\varepsilon + \mu); \quad \chi = \frac{2C}{T + C(\mu + \varepsilon)}$$

$$\therefore \theta/T_C = (\mu + \varepsilon)/(\mu - \varepsilon).$$

4. The terms in $U_{el} + U_c + U_K$ which involve e_{xx} are

$$\frac{1}{2}C_{11}e_{xx}^2 + C_{12}e_{xx}(e_{yy} + e_{zz}) + B_1\alpha_1^2 e_{xx}.$$

Take $\partial/\partial e_{xx}$:

$$C_{11}e_{xx} + C_{12}(e_{yy} + e_{zz}) + B_1\alpha_1^2 = 0, \text{ for minimum.}$$

Further:

$$C_{11}e_{yy} + C_{12}(e_{xx} + e_{zz}) + B_1\alpha_2^2 = 0.$$

$$C_{11}e_{zz} + C_{12}(e_{xx} + e_{yy}) + B_1\alpha_3^2 = 0.$$

Solve this set of equations for e_{xx} :

$$e_{xx} = B_1 \frac{C_{12} - \alpha_2^2 (C_{11} + 2C_{12})}{(C_{11} - C_{12})(C_{11} + 2C_{12})}.$$

Similarly for e_{yy} , e_{zz} , and by identical method for e_{xy} , etc.

5a.

$$U(\theta) = K \sin^2 \theta - B_a M_s \cos \theta$$

$$\approx K\varphi^2 - B_a M_s \frac{1}{2} \varphi^2, \text{ for } \theta = \pi + \varphi$$

and expanding about small φ .

For minimum near $\varphi = 0$ we need $K > \frac{1}{2} B_a M_s$. Thus at $B_a = 2K/M_s$ the magnetization reverses direction (we assume the magnetization reverses uniformly!).

b. If we neglect the magnetic energy of the bidomain particle, the energies of the single and bidomain particles will be roughly equal when

$$M_s^2 d^3 \approx \sigma_w d^2 ; \text{ or } d_c \approx \sigma_w / M_s^2 .$$

For Co the wall energy will be higher than for iron roughly in the ratio of the (anisotropy constant K_1)^{1/2}, or $\sqrt{10}$. Thus $\sigma_w \approx 3 \text{ ergs/cm}^2$. For Co, $M_s = 1400$ (at room temperature), so $M_s^2 \approx 2 \times 10^6 \text{ erg/cm}^3$. We have $d_c \approx 3/2 \times 10^6 \approx 1.10^{-6} \text{ cm}$, or $\approx 100 \text{ \AA}$, as the critical size. The estimate is very rough (the wall thickness is d_c ; the mag. en. is handled crudely).

6. Use the units of Eq. (9), and expand

$$\tanh \frac{m}{t} = \frac{m}{t} - \frac{1}{3} \frac{m^3}{t^3} + \dots \text{ [Dwight 657.3]}$$

Then (9) becomes $m \approx \frac{m}{t} - \frac{m^3}{3t^3} + \dots$;

$$3(t^3 - t^2) \approx m^2 ; m^2 \approx 3t^2(1-t) ,$$

but $1 - t$ is proportional to $T_c - T$, so that $m \propto \sqrt{T_c - T}$ for T just below T_c .

7. The maximum demagnetization field in a Néel wall is $-4 \pi M_s$, and the maximum self-energy density is $\frac{1}{2}(4\pi M_s) M_s$. In a wall of thickness Na , where a is the lattice constant, the demagnetization contribution to the surface energy is $\sigma_{\text{demag}} \approx 2\pi M_s^2 Na$. The total wall energy, exchange + demag, is $\sigma_w \approx (\pi^2 JS^2/Na^2) + (2\pi M_s^2 Na)$, by use of (56). The minimum is at

$$\partial\sigma_w/\partial N = 0 = -\pi^2 JS^2/N^2 a^2 + 2\pi M_s^2 a, \text{ or}$$

$$N = \left(\frac{1}{2} \pi JS^2 / M_s^2 a^3 \right)^{1/2},$$

and is given by

$$\sigma_w \approx \pi M_s S (2\pi J/a)^{1/2} \approx (10)(10^3)(10^{-4}/10^{-8})^{1/2} \approx 10 \text{ erg/cm}^2,$$

which is larger than (59) for iron. (According to Table 8.1 of the book by R. M. White and T. H. Geballe, the Bloch wall thickness in Permalloy is 16 times that in iron; this large value of δ favors the changeover to Néel walls in thin films.)

8. (a) Consider the resistance of the up and down spins separately.

Magnetizations parallel:

$$R_{\uparrow\uparrow}(up) = \sigma_p^{-1}(L/A) + \sigma_p^{-1}(L/A) = 2\sigma_p^{-1}(L/A)$$

$$R_{\uparrow\uparrow}(down) = \sigma_a^{-1}(L/A) + \sigma_a^{-1}(L/A) = 2\sigma_a^{-1}(L/A)$$

These resistances add in parallel:

$$R_{\uparrow\uparrow} = R_{\uparrow\uparrow}(down)R_{\uparrow\uparrow}(up)/[R_{\uparrow\uparrow}(down) + R_{\uparrow\uparrow}(up)] = 2(L/A)/(\sigma_a + \sigma_p)$$

Magnetizations antiparallel:

$$R_{\uparrow\downarrow}(up) = \sigma_p^{-1}(L/A) + \sigma_a^{-1}(L/A)$$

$$R_{\uparrow\downarrow}(down) = \sigma_a^{-1}(L/A) + \sigma_p^{-1}(L/A) = R_{\uparrow\downarrow}(up)$$

These (equal) resistances add in parallel :

$$R_{\uparrow\downarrow} = R_{\uparrow\downarrow}(up)/2 = (L/A)(\sigma_a^{-1} + \sigma_p^{-1})/2$$

The GMRR is then:

$$GMRR = R_{\uparrow\downarrow}/R_{\uparrow\uparrow} - 1 = (\sigma_a^{-1} + \sigma_p^{-1})(\sigma_a + \sigma_p)/4 - 1$$

$$= (\sigma_a/\sigma_p + \sigma_p/\sigma_a - 2)/4$$

(b) For the $\uparrow\downarrow$ magnetization configuration, an electron of a given spin direction must always go through a region where it is antiparallel to the magnetization. If $\sigma_a \rightarrow 0$, then the conductance is blocked and the resistance $R_{\uparrow\downarrow}$ is infinite.

CHAPTER 13

1. Consider a coil which when empty has resistance R_0 and inductance L_0 . The impedance is $Z_0 = R_0 - i\omega L_0$. When the coil is filled with material of permeability $\mu = 1 + 4\pi\chi$ the impedance is $Z = R_0 - i\omega L_0(1 + 4\pi\chi) = R_0 - i\omega L_0(1 + 4\pi\chi' + 4\pi i\chi'')$, or

$$Z = \underbrace{R_0 + 4\pi\omega\chi''L_0}_R - i\omega L_0 \underbrace{(1 + 4\pi\chi')} _L.$$

$$2a. \frac{d\vec{F}}{dt} = \frac{dF_x}{dt} \hat{x} + F_x \frac{d\hat{x}}{dt} + \dots.$$

$$= \left(\frac{d\vec{F}}{dt} \right)_R + \left(F_x \frac{d\hat{x}}{dt} + F_y \frac{d\hat{y}}{dt} + F_z \frac{d\hat{z}}{dt} \right).$$

Now

$$\frac{d\hat{x}}{dt} = (\underline{\Omega} \times \hat{x}); \quad \frac{d\hat{y}}{dt} = (\underline{\Omega} \times \hat{y}); \quad \frac{d\hat{z}}{dt} = (\underline{\Omega} \times \hat{z}).$$

$$F_x \frac{d\hat{x}}{dt} + \dots = \underline{\Omega} \times \vec{F}.$$

$$b. \frac{d\vec{M}}{dt} = \gamma \vec{M} \times \vec{B} : \left(\frac{d\vec{M}}{dt} \right)_R + \underline{\Omega} \times \vec{M} = \gamma \vec{M} \times \vec{B}.$$

$$\left(\frac{d\vec{M}}{dt} \right)_R = \gamma \vec{M} \times \left(\vec{B} + \frac{\underline{\Omega}}{\gamma} \right).$$

c. With $\underline{\Omega} = -\gamma B_0 \hat{z}$ we have

$$\left(\frac{d\vec{M}}{dt} \right)_R = \gamma \vec{M} \times B_1 \hat{x},$$

so that \vec{M} precesses about \hat{x} with a frequency $\omega = \gamma B_1$. The time $t_{1/2}$ to give $t_{1/2}\omega = \pi$ is $t_{1/2} = \pi/\gamma B_1$.

d. The field \vec{B}_1 rotates in the xy plane with frequency $\Omega = \gamma B_0$.

3a. $\langle B_i^2 \rangle = \left(\frac{a}{N}\right)^2 \sum_j \sum_k \langle I_j^z I_k^z \rangle$, where for $I = \frac{1}{2}$ we have $\langle I_j^z I_k^z \rangle = \frac{1}{4} \delta_{jk}$. Thus

$$\langle B_i^2 \rangle = \left(\frac{a}{N}\right)^2 \frac{1}{4} \sum_{jk} \delta_{jk} = \frac{a^2}{4N}.$$

b. $\langle B_i^4 \rangle = \left(\frac{a}{N}\right)^4 \sum_{jklm} \langle I_j^z I_k^z I_l^z I_m^z \rangle$.

Now

$$\begin{aligned} \langle I_j^z I_k^z I_l^z I_m^z \rangle &= \frac{1}{16} [\delta_{jk} \delta_{kl} \delta_{lm} + \delta_{jk} \delta_{lm} \\ &\quad + \delta_{jl} \delta_{km} + \delta_{jm} \delta_{kl}], \text{ and} \\ \langle B_i^4 \rangle &= \left(\frac{a}{N}\right)^4 \frac{1}{16} [N + 3N^2] \simeq \left(\frac{a}{N}\right)^4 \frac{3N^2}{16}. \end{aligned}$$

4. For small θ , we have $U_K \simeq K\theta^2$. Now the magnetic energy density $U_M = -BM \cos \theta \simeq -BM + \frac{1}{2} BM\theta^2$, so that with proper choice of the zero of energy the anisotropy energy is equivalent to a field

$$B_A = 2K/M$$

along the z axis. This is valid for $\theta \ll 1$. For a sphere the demagnetizing field is parallel to M and exerts no torque on the spin system. Thus $B_0 + B_A$ is the effective field.

5. We may rewrite (48) with appropriate changes in M , and with $B_{\text{anisotropy}} = 0$. Thus

$$\begin{aligned} -i\omega M_A^+ &= -i\gamma_A (M_A^+ \lambda |M_B| + M_B^+ \lambda |M_A|); \\ -i\omega M_B^+ &= i\gamma_B (M_B^+ \lambda |M_A| + M_A^+ \lambda |M_B|). \end{aligned}$$

The secular equation is

$$\begin{vmatrix} \gamma_A \lambda |M_B| - \omega & \gamma_A \lambda |M_A| \\ -\gamma_B \lambda |M_B| & \gamma_B \lambda |M_A| - \omega \end{vmatrix} = 0,$$

or

$$\omega^2 - \omega(\gamma_A \lambda |\mathbf{M}_B| - \gamma_B \lambda |\mathbf{M}_A|) = 0 .$$

One root is $\omega_0 = 0$; this is the uniform mode. The other root is

$$\omega_0 = \lambda(\gamma_A |\mathbf{M}_B| - \gamma_B |\mathbf{M}_A|) = 0;$$

this is the exchange mode.

CHAPTER 14

1. $E_{x0} = -\frac{\partial\phi}{\partial x} = kA \sin kx e^{kz}$, and at the boundary this is equal to E_{xi} . The normal component of \mathbf{D} at the boundary, but outside the medium, is $\varepsilon(\omega)kA \cos kx$, where for a plasma $\varepsilon(\omega) = 1 - \omega_p^2/\omega^2$. The boundary condition is $-kA \cos kx = \varepsilon(\omega)kA \cos kx$, or $\varepsilon(\omega) = -1$, or $\omega_p^2 = 2\omega^2$. This frequency $\omega = \omega_p/\sqrt{2}$ is that of a surface plasmon.

2. A solution below the interface is of the form $\phi(-) = A \cos kx e^{kz}$, and above the interface $\phi(+) = A \cos kx e^{-kz}$, just as for Prob. (1). The condition that the normal component of \mathbf{D} be continuous across the interface reduces to $\varepsilon_1(\omega) = -\varepsilon_2(\omega)$, or

$$1 - \frac{\omega_{p1}^2}{\omega^2} = -1 + \frac{\omega_{p2}^2}{\omega^2}, \text{ so that } \omega^2 = \frac{1}{2}(\omega_{p1}^2 + \omega_{p2}^2).$$

3. (a) The equation of motion of the electrons is

$$-\omega^2 x_e = -(e/m_e)E_x + i\omega\omega_e y_e; \quad -\omega^2 y_e = -(e/m_e)E_y - i\omega\omega_e x_e.$$

$$-\omega^2 x_h = (e/m_h)E_x + i\omega\omega_h y_h; \quad -\omega^2 y_h = (e/m_h)E_y - i\omega\omega_h x_h.$$

The result follows on forming $\xi_e = x_e + iy_e$ and $\xi_h = x_h + iy_h$. (b) Expand

$$(\omega_e + \omega)^{-1} \approx \omega_e^{-1}(1 - \omega/\omega_e) \quad \text{and} \quad (\omega_h - \omega) \approx \omega_h^{-1}(1 + \omega/\omega_h).$$

In this approximation $(\xi_h - \xi_e)/E^+ \approx (c/B)(\omega_h^{-1} + \omega_e^{-1}) = (c^2/eB^2)(m_h + m_e)$.

4. From the solution to Problem 3 we have $P^+ = pe^2 E^+ / m_h \omega_h \omega$, where we have dropped a term in ω^2 in comparison with $\omega_h \omega$. The dielectric constant

$$\varepsilon(\omega) = 1 + 4\pi P^+ / E^+ \approx 4\pi pe^2 / m_h \omega_h \omega, \text{ and the dispersion relation } \varepsilon(\omega)\omega^2 = c^2 k^2 \text{ becomes}$$

$$4\pi pe^2 \omega / (eB/c) = c^2 k^2. \text{ Numerically, } \omega \approx [(10^3)(3 \times 10^{10}) / (10)(3 \times 10^{22})(5 \times 10^{-10})] \approx 0.2 \text{ s}^{-1}.$$

It is true that $\omega\tau$ will be $\ll 1$ for any reasonable relaxation time, but $\omega_c \tau > 1$ can be shown to be the applicable criterion for helicon resonance.

$$5. m d^2 \mathbf{r} / dt^2 = -m\omega^2 \mathbf{r} = -e\mathbf{E} = 4\pi e \mathbf{P} / 3 = -4\pi n e^2 \mathbf{r} / 3. \text{ Thus } \omega_o^2 = 4\pi n e^2 / 3m.$$

6. $m d^2 \mathbf{r} / dt^2 = -m\omega^2 \mathbf{r} = -(e/c)(\mathbf{v} \times \mathbf{B}\hat{\mathbf{z}}) - m\omega_o^2 \mathbf{r}$, where $\omega_o^2 = 4\pi n e^2 / 3m$, from the solution to A. Thus, with $\omega_c \equiv eB/mc$,

$$-\omega^2 x = i\omega\omega_c y - \omega_o^2 x;$$

$$-\omega^2 y = -i\omega\omega_c x - \omega_o^2 y.$$

Form $\xi \equiv x + iy$; then $-\omega^2\xi - \omega\omega_c\xi + \omega_o^2\xi = 0$, or $\omega^2 + \omega\omega_c - \omega_o^2 = 0$, a quadratic equation for ω .

7. Eq. (53) becomes $c^2K^2E = \omega^2[\varepsilon(\infty)E + 4\pi P]$, where P is the ionic contribution to the polarization. Then (55) becomes

$$\begin{vmatrix} \omega^2\varepsilon(\infty) - c^2K^2 & 4\pi\omega^2 \\ Nq^2/M & \omega^2 - \omega_T^2 \end{vmatrix} = 0,$$

or

$$\omega^4\varepsilon^2(\infty) - \omega^2 \left[c^2K^2 + \varepsilon(\infty)\omega_T^2 + 4\pi Nq^2/M \right] + c^2K^2\omega_T^2 = 0.$$

One root at $K = 0$ is $\omega^2 = \omega_T^2 + 4\pi Nq^2/\varepsilon(\infty)M$. For the root at low ω and K we neglect terms in ω^4 and in ω^2K^2 . Then

$$\begin{aligned} \omega^2 &= c^2K^2 \omega_T^2 / [\varepsilon(\infty)\omega_T^2 + 4\pi Nq^2/M] \\ &= c^2K^2 / [\varepsilon(\infty) + 4\pi Nq^2/M\omega_T^2] = c^2K^2/\varepsilon(0), \end{aligned}$$

where $\varepsilon(0)$ is given by (58) with $\omega = 0$.

$$8(a). \quad \sigma = ne^2\tau/m = (\omega_p^2/4\pi)\tau = 0.73 \times 10^{15} \text{ s}^{-1} = 800(\Omega \text{ cm})^{-1}$$

$$(b) \quad \omega_p^2 = 4\pi ne^2/m^*; \quad m^* = 4\pi ne^2/\omega_p^2 = 4.2 \times 10^{-27} \text{ g}; \quad m^*/m = 4.7.$$

9. The kinetic energy of a Fermi gas of N electrons in volume V is

$$U = N(3/5)(\hbar^2/2m)(3\pi^2N/V)^{2/3}. \quad \text{Then } dU/dV = -(2/3)U/V \text{ and } d^2U/dV^2 = (10/9)U/V^2.$$

$$\text{The bulk modulus } B = Vd^2U/dV^2 = (10/9)U/V = (10/9)(3/5)n(mv_F^2/2) = nmv_F^2/3.$$

The velocity of sound $v = (B/\rho)^{1/2}$, where the density $\rho = n(m+M) \approx nM$, whence

$$v \approx (m/3M)^{1/2} v_F.$$

10. The response is given, with $\rho = 1/\tau$, by

$$m \left(d^2x/dt^2 + \rho dx/dt + \omega_p^2 x \right) = F(t).$$

The conductivity σ does not enter this equation directly, although it may be written as $\sigma = \omega_p^2\tau/4\pi$. For order of magnitude,

$$\sigma = (1/10^{-6})(9 \times 10^{11}) \approx 10^{18} \text{ s}^{-1} ;$$

$$\rho = 1/\tau = v_F/\ell \approx (1.6 \times 10^8)/(4 \times 10^{-6}) \approx 0.4 \times 10^{14} \text{ s}^{-1} ;$$

$$\omega_p = (4\pi n e^2/m)^{1/2} \approx (10 \times 10^{23} \times 23 \times 10^{-20}/10^{-27})^{1/2}$$

$$\approx 1.5 \times 10^{16} \text{ s}^{-1} .$$

The homogeneous equation has a solution of the form $x(t > 0) = Ae^{-\lambda t} \sin(\omega t + \phi)$,

where $\omega = [\omega_p^2 + (\rho/2)^2]^{1/2}$ and $\lambda = \rho/2$. To this we add the particular solution $x = -e/m\omega$ and find A and ϕ to satisfy the initial conditions $x(0) = 0$ and $\dot{x}(0) = 0$.

11. The Laplacian $\nabla^2\phi = 0$, whence

$$\frac{d^2f}{dz^2} - K^2f = 0 .$$

This has solutions

$$f = Ae^{Kz} \text{ for } z < 0$$

$$f = Ae^{-K(z-d)} \text{ for } z > d$$

$$f = B \cosh K(z-d/2) \text{ for } 0 < z < d .$$

This solution assures that ϕ will be continuous across the boundaries if $B = A/\cosh(Kd/2)$. To arrange that the normal component of D is continuous, we need $\epsilon(\omega) \partial\phi/\partial z$ continuous, or $\epsilon(\omega) = -\tanh(Kd/2)$.

CHAPTER 15

1a. The displacement under this force is

$$x(t) = \frac{1}{2\pi} \int_{-\infty}^{\infty} \alpha(\omega) e^{-i\omega t} d\omega.$$

With $\omega = \omega_R + i\omega_I$, the integral is $\int \alpha(\omega) e^{-i\omega_R t} e^{\omega_I t} d\omega$. This integral is zero for $t < 0$ because we may then complete a contour with a semicircle in the upper half-plane, over which semicircle the integral vanishes. The integral over the entire contour is zero because $\alpha(\omega)$ is analytic in the upper half-plane. Therefore $x(t) = 0$ for $t < 0$.

1b. We want

$$x(t) = \frac{1}{2\pi} \int_{-\infty}^{\infty} \frac{e^{-i\omega t} d\omega}{\omega_0^2 - \omega^2 - i\omega\rho}, \quad (\text{A})$$

which is called the retarded Green's function of the problem. We can complete a contour integral by adding to $x(t)$ the integral around an infinite semicircle in the upper half-plane. The complete contour integral vanishes because the integrand is analytic everywhere within the contour. But the integral over the infinite semicircle vanishes at $t < 0$, for then

$$\exp[-i(\omega_R + i\omega_I)(-|t|)] = \exp(-\omega_I |t|) \exp(i\omega_R |t|),$$

which $\rightarrow 0$ as $|\omega| \rightarrow \infty$. Thus the integral in (A) must also vanish. For $t > 0$ we can evaluate $x(t)$ by carrying out a Cauchy integral in the lower half-plane. The residues at the poles are

$$\pm \frac{1}{2} \left(\omega_0^2 - \frac{1}{4}\rho^2 \right)^{\frac{1}{2}} \exp\left(-\frac{1}{2}\rho t\right) \exp\left[\mp i \left(\omega_0^2 - \frac{1}{4}\rho^2 \right)^{\frac{1}{2}} t\right],$$

so that

$$x(t) = \left(\omega_0^2 - \frac{1}{4}\rho^2 \right)^{\frac{1}{2}} \exp\left(-\frac{1}{2}\rho t\right) \sin\left(\left(\omega_0^2 - \frac{1}{4}\rho^2 \right)^{\frac{1}{2}} t \right).$$

2. In the limit $\omega \rightarrow \infty$ we have

$$\alpha'(\omega) \rightarrow -\sum f_j / \omega^2$$

from (9), while from (11a)

$$\alpha'(\omega) \rightarrow -\frac{2}{\pi\omega^2} \int_0^{\infty} s\alpha''(s) ds.$$

3. The reflected wave in vacuum may be written as

$$-E_y(\text{refl}) = B_z(\text{refl}) = A' e^{-i(kx+\omega t)},$$

where the sign of E_y has been reversed relative to B_z in order that the direction of energy flux (Poynting vector) be reversed in the reflected wave from that in the incident wave. For the transmitted wave in the dielectric medium we find

$$\begin{aligned} E_y(\text{trans}) &= ck B_z(\text{trans})/\varepsilon\omega \\ &= \varepsilon^{-1/2} B_z(\text{trans}) = A'' e^{i(kx-\omega t)}, \end{aligned}$$

by use of the Maxwell equation $c \text{ curl } H = \varepsilon \partial E / \partial t$ and the dispersion relation $\varepsilon\omega^2 = c^2 k^2$ for electromagnetic waves.

The boundary conditions at the interface at $x = 0$ are that E_y should be continuous: $E_y(\text{inc}) + E_y(\text{refl}) = E_y(\text{trans})$, or $A - A' = A''$. Also B_z should be continuous, so that $A + A' = \varepsilon^{1/2} A''$. We solve for the ratio A'/A to obtain $\varepsilon^{1/2}(A - A') = A + A'$, whence

$$\frac{A'}{A} = \frac{1 - \varepsilon^{1/2}}{\varepsilon^{1/2} + 1},$$

and

$$r \equiv \frac{E(\text{refl})}{E(\text{inc})} = -\frac{A'}{A} = \frac{\varepsilon^{1/2} - 1}{\varepsilon^{1/2} + 1} = \frac{n + ik - 1}{n + ik + 1}.$$

The power reflectance is

$$R(\omega) = r * r = \left(\frac{n - ik - 1}{n - ik + 1} \right) \left(\frac{n + ik - 1}{n + ik + 1} \right) = \frac{(n-1)^2 + K^2}{(n+1)^2 + K^2}.$$

4. (a) From (11) we have

$$\sigma''(\omega) = -\frac{2\omega}{\pi} \text{P} \int_0^{\infty} \frac{\sigma'(s)}{s^2 - \omega^2} ds.$$

In the limit $\omega \rightarrow \infty$ the denominator comes out of the integrand and we have

$$\lim_{\omega \rightarrow \infty} \sigma''(\omega) = \frac{2}{\pi\omega} \int_0^{\infty} \sigma'(s) ds.$$

(b) A superconductor has infinite conductivity at zero frequency and zero conductivity at frequencies up to ω_g at the energy gap. We can replace the lost portion of the integral (approximately $\sigma'_n \omega_g$) by a delta function $\sigma'_n \omega_g \delta(\omega)$ in $\sigma'_s(\omega)$ at the origin. Then the KK relation above gives

$$\sigma''_s(\omega) = \frac{2}{\pi\omega} \sigma'_n \omega_g.$$

(c) At very high frequencies the drift velocity of the conduction electrons satisfies the free electron equation of motion

$$m dv/dt = -eE; \quad -i\omega m v = -eE,$$

so that the current density is

$$j = n(-e)v = -ine^2 E/m\omega$$

and $\omega\sigma''(\omega) = ne^2/m$ in this limit. Then use (a) to obtain the desired result.

5. From (11a) we have

$$\varepsilon'(\omega) - 1 = \frac{4\pi ne^2}{m} P \int_0^{\infty} \frac{\delta(s - \omega_g)}{s^2 - \omega^2} ds = \frac{\omega_p^2}{\omega_g^2 - \omega^2}.$$

6. $n^2 - K^2 + 2inK = 1 + 4\pi i\sigma_0/\omega$. For normal metals at room temperature $\sigma_0 \sim 10^{17} - 10^{18} \text{ sec}^{-1}$, so that in the infrared $\omega \ll \sigma_0$. Thus $n^2 \approx K^2$, so that $R \approx 1 - 2/n$ and $n \approx \sqrt{(2\pi\sigma_0/\omega)}$, whence $R \approx 1 - \sqrt{(2\omega/\pi\sigma_0)}$. (The units of σ_0 are sec^{-1} in CGS.)

7. The ground state of the line may be written $\psi_g = A_1 B_1 A_2 B_2 \dots A_N B_N$. Let the asterisk denote excited state; then if specific single atoms are excited the states are $\varphi_j = A_1 B_1 A_2 B_2 \dots A_j^* B_j \dots A_N B_N$; $\theta_j = A_1 B_1 A_2 B_2 \dots A_j B_j^* \dots A_N B_N$. The hamiltonian acts thusly:

$$H\varphi_j = \varepsilon_A \varphi_j + T_1 \theta_j + T_2 \theta_{j-1};$$

$$H\theta_j = \varepsilon_B \theta_j + T_1 \varphi_j + T_2 \varphi_{j+1}.$$

An eigenstate for a single excitation will be of the form $\psi_k = \sum_j e^{ijka} (\alpha\phi_j + \beta\theta_j)$. We form

$$\begin{aligned}
 H\psi_k &= \sum_j e^{ijka} [\alpha\varepsilon_A\phi_j + \alpha T_1\theta_j + \alpha T_2\theta_{j-1} \\
 &\quad + \beta\varepsilon_B\phi_j + \beta T_1\phi_j + \beta T_2\phi_{j+1}]. \\
 &= \sum_j e^{ijka} [(\alpha\varepsilon_A + \beta T_1 + e^{-ika}\beta T_2)\phi_j \\
 &\quad + (\alpha T_1 + \beta\varepsilon_B + e^{ika}\alpha T_2)\theta_j] \\
 &= E\psi_k = \sum_j e^{ijka} [\alpha E\phi_j + \beta E\theta_j].
 \end{aligned}$$

This is satisfied if

$$\begin{aligned}
 (\varepsilon_A - E)\alpha + (T_1 + e^{-ika}T_2)\beta &= 0; \\
 (T_1 + e^{ika}T_2)\alpha + (\varepsilon_B - E)\beta &= 0.
 \end{aligned}$$

The eigenvalues are the roots of

$$\begin{vmatrix}
 \varepsilon_A - E & T_1 + e^{-ika}T_2 \\
 T_1 + e^{ika}T_2 & \varepsilon_B - E
 \end{vmatrix} = 0.$$

CHAPTER 16

1. $\frac{e^2}{r} \cdot \frac{x}{r} = eE$; $ex = r^3 E = p$; $\alpha = p/E = r^3 = a_H^3$.

2. $E_i = E_0 - \frac{4\pi}{3} P = 0$ inside a conducting sphere. Thus $p = \frac{4\pi}{3} a^3 P = a^3 E_0$, and $\alpha = p/E_0 = a^3$.

3. Because the normal component of \mathbf{D} is continuous across a boundary, $E_{\text{air}} = \epsilon E_{\text{diel}}$, where $E_{\text{air}} = 4\pi Q/A$, with Q the charge on the boundary. The potential drop between the two plates is $E_{\text{air}} qd + E_{\text{diel}} d = E_{\text{air}} d \left(q + \frac{1}{\epsilon} \right)$. For a plate of area A , the capacitance is

$$C = \frac{A}{4\pi d \left(q + \frac{1}{\epsilon} \right)}.$$

It is useful to define an effective dielectric constant by

$$\frac{1}{\epsilon_{\text{eff}}} = \frac{1}{\epsilon} + q.$$

If $\epsilon = \infty$, then $\epsilon_{\text{eff}} = 1/q$. We cannot have a higher effective dielectric constant than $1/q$. For $q = 10^{-3}$, $\epsilon_{\text{eff}} = 10^3$.

4. The potential drop between the plates is $E_1 d + E_2 qd$. The charge density

$$\frac{Q}{A} = \frac{D_1}{4\pi} = \frac{\epsilon E_1}{4\pi} = \frac{i\sigma}{\omega} E_2, \quad (\text{CGS})$$

by comparison of the way σ and ϵ enter the Maxwell equation for curl \mathbf{H} . Thus

$$E_1 + \frac{4\pi i\sigma}{\epsilon\omega} E_2; \quad V = E_2 d \left(\frac{4\pi i\sigma}{\epsilon\omega} + q \right);$$

$$Q = \frac{\sigma A i}{\omega} E_2; \quad \text{and thus } C \equiv \frac{Q}{V} = \frac{A}{4\pi d \left(\frac{1}{\epsilon} - \frac{i\omega q}{4\pi\sigma} \right)},$$

$$\text{and } \epsilon_{\text{eff}} = (1+q) \frac{\epsilon}{1 - (i\omega\epsilon q/4\pi\sigma)}.$$

$$5a. E_{\text{int}} = E_0 - \frac{4\pi}{3} P = E_0 - \frac{4\pi}{3} \chi E_{\text{int}} .$$

$$E_{\text{int}} = \frac{E_0}{1 + \frac{4\pi}{3} \chi} .$$

$$b. P = \chi E_{\text{int}} = \frac{\chi}{1 + \frac{4\pi}{3} \chi} E_0 .$$

$$6. E = 2P_1/a^3. P_2 = \alpha E = 2\alpha P_1/a^3. \text{ This has solution } p_1 = p_2 = 0 \text{ if } 2\alpha = a^3; \alpha = \frac{1}{2} a^3 .$$

7 (a). One condition is, from (43),

$$\gamma(T_c - T_0) - |g_4| P_s^2 + g_6 P_s^4 = 0 .$$

The other condition is

$$\frac{1}{2} \gamma(T_c - T_0) P_s^2 - \frac{1}{4} |g_4| P_s^4 + \frac{1}{6} g_6 P_s^6 = 0 .$$

Thus

$$\begin{aligned} -|g_4| P_s^2 + g_6 P_s^4 &= -\frac{1}{2} |g_4| P_s^2 + \frac{1}{3} g_6 P_s^4 ; \\ \frac{2}{3} g_6 P_s^2 &= \frac{1}{2} |g_4| ; P_s^2 = \frac{3 |g_4|}{4 g_6} . \end{aligned}$$

(b) From the first line of part (a),

$$\gamma(T_c - T_0) = \frac{3 |g_4|^2}{4 g_6} - \frac{9 |g_4|^2}{16 g_6} = \frac{3 g_4^2}{16 g_6} .$$

8. In an electric field the equilibrium condition becomes $-E + \gamma(T - T_c)P + g_4 P^3 = 0$, where the term in g_6 is neglected for a second-order transition. Now let $P = P_s + \Delta P$. If we retain only linear terms in ΔP , then $-E + \gamma(T - T_c)\Delta P + g_4 3P_s^2 \Delta P = 0$, with use of (40). Further, we can eliminate P_s^2 because $P_s^2 = (\gamma/g_4)(T_c - T)$. Thus $\Delta P/E = 1/2\gamma(T_c - T)$.

9 a. $\left| \begin{array}{cccc} \leftarrow & a & \rightarrow & \\ \rightarrow & & \leftarrow & \end{array} \right| \dots \rightarrow \leftarrow \rightarrow \leftarrow \dots \cos \frac{\pi}{a}(na)$

b. $\left| \begin{array}{cccc} \leftarrow & 2a & \rightarrow & \\ \dots & & \dots & \end{array} \right| \dots$

Deforms to new stable structure of dimers, with lattice constant $2 \times$ (former constant).

c.

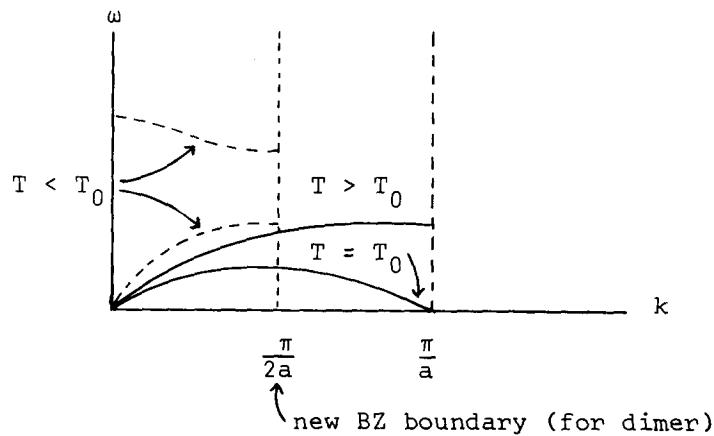

10. The induced dipole moment on the atom at the origin is $p = \alpha E$, where the electric field is that of all other dipoles: $E = (2/a^3) \sum p_n = (4p/a^3) (\sum n^{-3})$; the sum is over positive integers. We assume all dipole moments equal to p . The self-consistency condition is that $p = \alpha(4p/a^3) (\sum n^{-3})$, which has the solution $p = 0$ unless $\alpha \geq (a^3/4) (1/\sum n^{-3})$. The value of the summation is 1.202; it is the zeta function $\zeta(3)$.

CHAPTER 17

1. (a) The interference condition for a linear lattice is $a \cos \theta = n\lambda$. The values of θ that satisfy this condition each define a cone with axis parallel to the fiber axis and to the axis of the cylindrical film. Each cone intersects the film in a circle. When the film is flattened out, parallel lines result. (b) The intersection of a cone and a plane defines a conic section, here a hyperbola. (c) Let \mathbf{a} , \mathbf{b} be the primitive axes of a square lattice. The Laue equations (2.25) give $\mathbf{a} \cdot \Delta\mathbf{k} = 2\pi q$; $\mathbf{b} \cdot \Delta\mathbf{k} = 2\pi r$, where q , r are integers. Each equation defines a set of planes. The intersections of these planes gives a set of parallel lines, which play in diffraction from a two-dimensional structure the role played by reciprocal lattice points in diffraction from a three-dimensional structure. In the Ewald construction these lines intersect a sphere of radius $k = 2\pi/\lambda$ in a set of points. In two dimensions any wavelength (below some maximum) will give points; in three dimensions only special values of λ give points of intersection because one more Laue equation must be satisfied. The points correspond to the directions \mathbf{k}' of the diffraction maxima. If the photographic plate is flat the diffraction pattern (2 dim.) will appear distorted.

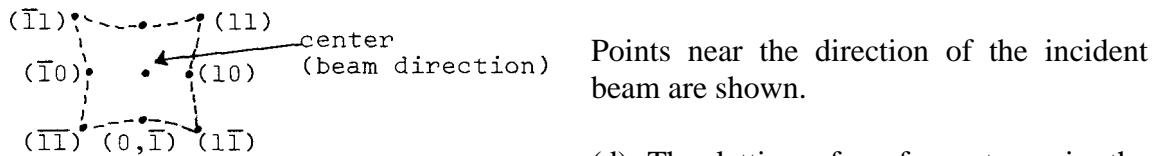

(d) The lattice of surface atoms in the (110) surface of an fcc crystal is simple rectangular. The long side of the rectangle in crystal (real) space is a short side in the reciprocal lattice. This explains the 90° rotation between (21a) and (21b).

2. With the trial function $\psi = \exp(-ax)$, the normalization integral is $\int_0^\infty dx x^2 \exp(-2ax) = 1/4a^3$. The kinetic energy operator applied to the trial function gives

$$-\left(\hbar^2/2m\right)d^2u/dx^2 = -\left(\hbar^2/2m\right)(a^2x - 2a)\exp(-ax)$$

while $Vu = eEx^2 \exp(-ax)$. The definite integrals that are needed have the form $\int_0^\infty dx x^n \exp(-ax) = n!/a^{n+1}$. The expectation value of the energy is $\langle \epsilon \rangle = (\hbar^2/2m)a^2 + (3eE/2a)$, which has an extremum with respect to the range parameter a when $d\langle \epsilon \rangle/da = (\hbar^2/2m)2a - 3eE/2a^2 = 0$, or $a^3 = 3eEm/2\hbar^2$. The value of $\langle \epsilon \rangle$ is a minimum at this value of a , so that

$$\begin{aligned} \langle \epsilon \rangle_{\min} &= \left(\hbar^2/2m\right)\left(3eEm/\hbar^2\right)^{2/3} + (3eE/2)\left(2\hbar^2/3eEm\right)^{1/3} \\ &= \left(\hbar^2/2m\right)^{1/3} (3eE/2)^{2/3} \left(2^{-2/3} + 2^{1/3}\right), \end{aligned}$$

where the last factor has the value 1.89 The Airy function is treated in Sec. 10.4 of the NBS Handbook of mathematical functions.

$$3. (a) D(\varepsilon) = \frac{dN}{dk} \frac{dk}{d\varepsilon} = \frac{2}{(2\pi/L)^2} \frac{d(\pi k^2)}{dk} \frac{m}{\hbar^2 k} = \frac{m}{\pi \hbar^2} A$$

where $A = L^2$.

Note: There are two flaws in the answer $m/\pi\hbar^2$ quoted in the text. First, the area A is missing, meaning the quoted answer is a density per unit area. This should not be a major issue. Second, the h should be replaced by \hbar .

$$(b) N = \frac{2}{(2\pi/L)^2} \cdot \pi k_F^2 \quad \Rightarrow \quad n_s = N/A = k_F^2/2\pi$$

(c) $R_s = \frac{L}{W} \frac{m}{n_s e^2 \tau}$ where n_s is the 2D sheet density. For a square sample, $W=L$, so:

$$R_s = \frac{2\pi m}{k_F^2 e^2 \tau} \quad \text{and using } \hbar k_F / m = v_F :$$

$$R_s = \frac{2\pi \hbar}{k_F v_F e^2 \tau} = \frac{h}{e^2} \frac{1}{k_F \ell}$$

CHAPTER 18

1. Carbon nanotube band structure.

(a) $\mathbf{b}_i \cdot \mathbf{a}_j = 2\pi\delta_{ij} \Rightarrow \mathbf{b}_1 = \left(-\frac{2\pi}{a}, \frac{2\pi}{\sqrt{3}a}\right), \quad \mathbf{b}_2 = \left(\frac{2\pi}{a}, \frac{2\pi}{\sqrt{3}a}\right).$

(b) The angle between \mathbf{K} and \mathbf{b}_1 is 30° ; A right triangle is formed in the first BZ with two sides of length K and $b_1/2$. Now $b_1 = \frac{4\pi}{\sqrt{3}a}$, so:

$$K = (b_1/2)/\cos(30^\circ) = 4\pi/3a.$$

(c) Quantization of k along x : $k_x(na) = 2\pi j = k_x = 2\pi j/na$.

Assume $n = 3i$, where i is an integer. Then: $k_x = K(j/2i)$. For $j = 2i$, $k_x = K$. Then

$$\Delta\mathbf{K} = k_y \hat{j} \text{ and there is a massless subband.}$$

(d) For $n = 10$, $k_x = 2\pi j/10a = K(3j/20)$. The closest k comes to K is for $j = 7$, where $\Delta k_x = K/20$. Then:

$$\varepsilon_{11} = 2\hbar v_F (4\pi/3a)/10 = 1.8 \text{ eV.}$$

The next closest is for $j = 6$, where $\Delta k_x = K/10$, twice the previous one. Therefore:

$$\varepsilon_{22} = 2\varepsilon_{11}.$$

(e) For the lowest subband: $|\Delta\mathbf{k}|^2 = (K/20)^2 + k_y^2$, so:

$$\varepsilon^2 = [(\hbar K/20v_F)v_F^2]^2 + (\hbar k_y v_F)^2$$

This is of the desired form, with $m^* = \hbar K/20v_F$.

$$m^*/m = \hbar K/20mv_F = 0.12.$$

2. Filling subbands

$$\varepsilon(n_x, n_y) = \frac{\hbar^2 \pi^2}{2mW^2} (n_x^2 + n_y^2) \Rightarrow \text{States are filled up to } \varepsilon(2,2) = \frac{\hbar^2 \pi^2}{2mW^2} (8) \quad (8)$$

$$(1,1) \text{ subband: } \frac{\hbar^2 k_{1,1}^2}{2m} = \frac{\hbar^2 \pi^2}{2mW^2} (8-2) \Rightarrow k_{1,1} = \frac{\sqrt{6}\pi}{W} \Rightarrow n_{1,1} = \frac{2}{\pi} k_{1,1} = \frac{2\sqrt{6}}{W}$$

$$(2,1) \text{ subband: } \frac{\hbar^2 k_{2,1}^2}{2m} = \frac{\hbar^2 \pi^2}{2mW^2} (8-5) \Rightarrow k_{2,1} = \frac{\sqrt{3}\pi}{W} \Rightarrow n_{2,1} = \frac{2}{\pi} k_{2,1} = \frac{2\sqrt{3}}{W}$$

(2,1) subband: same.

$$n = \frac{2\sqrt{6}}{W} + \frac{4\sqrt{3}}{W} = 5.9 \times 10^8 / \text{m}.$$

3. Breit-Wigner form of a transmission resonance

$$(a) \quad \cos(\delta\varphi) \cong 1 - \delta\varphi^2 / 2 \quad ; \quad |r_i| = \sqrt{1 - |t_i|^2} \cong 1 - \frac{1}{2}|t_i|^2 - \frac{1}{8}|t_i|^4$$

The denominator of (29) is then:

$$\begin{aligned} 1 + (1 - |t_1|^2)(1 - |t_2|^2) - 2(1 - \frac{1}{2}|t_1|^2 - \frac{1}{8}|t_1|^4)(1 - \frac{1}{2}|t_2|^2 - \frac{1}{8}|t_2|^4)(1 - \frac{1}{2}\delta\varphi^2) \\ = \frac{1}{4}(|t_1|^4 + |t_2|^4) + \frac{1}{2}|t_1|^2|t_2|^2 + \delta\varphi^2 = \frac{1}{4}(|t_1|^2 + |t_2|^2)^2 + \delta\varphi^2 \\ \mathfrak{D} = \frac{4|t_1|^2|t_2|^2}{(|t_1|^2 + |t_2|^2)^2 + 4\delta\varphi^2}. \end{aligned}$$

$$(b) \quad \delta\varphi = 2L\delta k \quad \text{and} \quad \delta k / \delta\varepsilon = \Delta k / \Delta\varepsilon = (\pi / L) / \Delta\varepsilon. \quad \text{Combining:} \\ \delta\varphi = (2L)(\pi / L)\delta\varepsilon / \Delta\varepsilon \quad \Rightarrow \quad \delta\varphi / 2\pi = \delta\varepsilon / \Delta\varepsilon$$

(c) Combining:

$$\mathfrak{D} = \frac{4|t_1|^2|t_2|^2 (\Delta\varepsilon / 2\pi)^2}{(\Delta\varepsilon / 2\pi)^2 (|t_1|^2 + |t_2|^2)^2 + 4\delta\varepsilon^2} \quad \text{which is (33).}$$

4. Barriers in series and Ohm's law

(a)

$$\begin{aligned} \frac{1}{\mathfrak{D}} &= \frac{1 - |r_1|^2|r_2|^2}{|t_1|^2|t_2|^2} = 1 + \frac{1 - |r_1|^2|r_2|^2 - |t_1|^2|t_2|^2}{|t_1|^2|t_2|^2} = 1 + \frac{1 - (1 - |t_1|^2)|r_2|^2 - (1 - |r_1|^2)|t_2|^2}{|t_1|^2|t_2|^2} \\ &= 1 + \frac{1 - (|r_2|^2 + |t_2|^2) + |t_1|^2|r_2|^2 + |r_1|^2|t_2|^2}{|t_1|^2|t_2|^2} = 1 + \frac{|r_2|^2}{|t_2|^2} + \frac{|r_1|^2}{|t_1|^2} \quad \text{which gives (36).} \end{aligned}$$

$$(b) \quad \sigma_{1D} = \frac{n_{1D}e^2\tau}{m} = \frac{2k_F e^2\tau}{\pi m}, \quad \text{and} \quad \frac{\hbar k_F}{m} = v_F \quad \Rightarrow \quad \sigma_{1D} = \frac{2v_F e^2\tau}{\hbar\pi} = \frac{2e^2(2v_F\tau)}{h}$$

$$\text{But: } \ell_B = v_F\tau_B = 2v_F\tau \quad \Rightarrow \quad \sigma_{1D} = \frac{2e^2\ell_B}{h}.$$

5. Energies of a spherical quantum dot

$$(a) \quad \int_A \mathbf{E} \cdot d\mathbf{a} = Q_{\text{encl}} / \varepsilon\varepsilon_0 \quad \Rightarrow \quad E = q / 4\pi\varepsilon\varepsilon_0 r^2 \quad \text{Integrating from inner to outer shell:}$$

$$V = \int_R^{R+d} \frac{qdr}{4\pi\varepsilon\varepsilon_0 r^2} = \frac{q}{4\pi\varepsilon\varepsilon_0} \left(\frac{1}{R} - \frac{1}{R+d} \right) = \frac{q}{4\pi\varepsilon\varepsilon_0} \frac{d}{R(R+d)}$$

$$C = \frac{q}{V} = 4\pi\epsilon\epsilon_0 \frac{R(R+d)}{d} \quad \text{and therefore} \quad U = \frac{e^2}{C} = \frac{e^2}{4\pi\epsilon\epsilon_0} \frac{d}{R(R+d)}.$$

(b) For $d \ll R$, $C \cong 4\pi\epsilon\epsilon_0 \frac{R^2}{d} = \epsilon\epsilon_0 \frac{A}{d}$.

(c) For $d \gg R$, $U = \frac{e^2}{4\pi\epsilon\epsilon_0 R}$. Also $\epsilon_{0,0} = \frac{\hbar^2 \pi^2}{2m^* R^2} \Rightarrow \frac{U}{\epsilon_{0,0}} = \frac{e^2}{4\pi\epsilon\epsilon_0 R} \cdot \frac{2m^* R^2}{\hbar^2 \pi^2}$

$$\frac{U}{\epsilon_{0,0}} = \frac{e^2}{4\pi\epsilon\epsilon_0 R} \cdot \frac{2m^* R^2}{\hbar^2 \pi^2} = \frac{e^2}{4\pi\epsilon\epsilon_0} \cdot \frac{2m^* R}{\hbar^2 \pi^2} = \frac{2}{\pi^2} \frac{R}{a_B^*}$$

6. Thermal properties in 1D

(a) $D(\omega) = \frac{2K}{2\pi/L} \frac{1}{v} = \frac{L}{\pi v}$

$$U_{tot} = \int_0^{\omega_p} \frac{d\omega D(\omega) \hbar \omega}{\exp(\hbar\omega/k_B T) - 1} \cong \frac{\hbar L}{\pi v} \int_0^{\infty} \frac{\omega d\omega}{\exp(\hbar\omega/k_B T) - 1} = \frac{\hbar L}{\pi v} \left(\frac{k_B T}{\hbar} \right)^2 \int_0^{\infty} \frac{x dx}{\exp(x) - 1}$$

Obtaining value from table of integrals:

$$U_{tot} = \frac{L k_B^2 T^2}{\hbar \pi v} \frac{\pi^2}{6} = \frac{\pi^2 L k_B^2 T^2}{3 \hbar v}$$

$$C_V = \partial U_{tot} / \partial T|_V = \frac{2\pi^2 L k_B^2 T}{3 \hbar v}$$

(b) The heat flow to the right out of reservoir 1 is given by:

$$J_R = \int_0^{\infty} \frac{D_R(\omega)}{L} \cdot v \cdot \frac{d\omega \hbar \omega}{\exp(\hbar\omega/k_B T_1) - 1} \mathfrak{S} = \frac{\hbar \mathfrak{S}}{2\pi} \int_0^{\infty} \frac{\omega d\omega}{\exp(\hbar\omega/k_B T_1) - 1} = \frac{\hbar \mathfrak{S}}{2\pi} \left(\frac{k_B T_1}{\hbar} \right)^2 \frac{\pi^2}{6} = \frac{\pi^2 k_B^2 T_1^2}{6 \hbar} \mathfrak{S}$$

and similarly for J_L . The difference is:

$$J_R - J_L = \frac{\pi^2 k_B^2 \mathfrak{S}}{6 \hbar} (T_1^2 - T_2^2)$$

Let $T_1 = T + \Delta T$, $T_2 = T \Rightarrow (T_1^2 - T_2^2) \approx 2T\Delta T$ for small ΔT .

$$\Rightarrow J_R - J_L = \frac{\pi^2 k_B^2 \mathfrak{S}}{3 \hbar} \Delta T \quad \text{which gives (78).}$$

CHAPTER 20

1. $U = nE_I$.

The number of ways to pick n from N is $N! / (N-n)!n!$. The number of ways to put n into $N' = n! / (N' - n)!n!$.

$$\text{Entropy } S = k_B \left(\log \frac{N!}{(N-n)!n!} + \log \frac{N'!}{(N'-n)!n!} \right).$$

$$\log \frac{N!}{(N-n)!n!} \approx N \log N - (N-n) \log(N-n) - n \log n$$

$$\log \frac{N'!}{(N'-n)!n!} \approx N' \log N' - (N'-n) \log(N'-n) - n \log n$$

$$\left(\frac{\partial F}{\partial n} \right)_T = \frac{\partial U}{\partial n} - T \frac{\partial S}{\partial n} = 0 \text{ in equilibrium; thus}$$

$$\begin{aligned} E_I &= k_B T \left(\log \frac{N-n}{n} + \log \frac{N'-n}{n} \right) \\ &= k_B T \log \frac{(N-n)(N'-n)}{n^2}. \text{ For } n \ll N, N', \end{aligned}$$

$$E_I = k_B T \log (NN'/n^2); \quad n = \sqrt{NN'} e^{-E_I/2k_B T}.$$

2. From (2), $n = N e^{-E/k_B T}$. For sodium, $N = 2.5 \times 10^{22}$ atoms/cm³. Thus

$$n \approx (2.5 \times 10^{22})(4 \times 10^{-18}) \approx 10^5 \text{ per cm}^3.$$

3a. $\hbar\omega = \frac{13.6}{\epsilon^2} \cdot \frac{3}{4}$ eV. From Table 10.3 we have $\epsilon(\infty) = 2.25$ for NaCl, whence $\hbar\omega = 2.0$ eV. The observed value quoted in Table 18.2 is 2.7 eV.

b. From Vol. I of Atomic energy levels, Circular 467 of the Nat. Bur. of Standards, 3p-3s = 16960 cm⁻¹ = 2.1 eV.

CHAPTER 21

1. In fcc the nearest neighbors to a given atom lie in $[110]$ and equivalent directions -- thus these directions are lines of closest packing. In bcc the nearest neighbors lie in $[111]$ and equivalent directions. There is a lively interest in the channeling of fast ions along open channel directions in crystals.

2a.

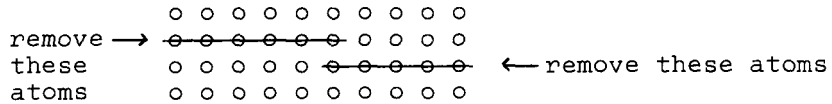

b.

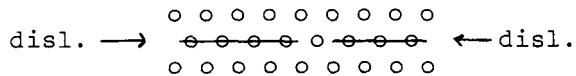

3. When a dislocation moves a distance L through the crystal, the crystal advances by a distance b . The work $\sigma L^2 b$ may be expressed as

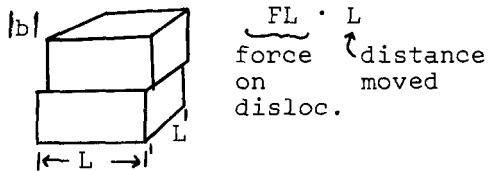

Thus $F = \sigma b$ is the force/unit length on the dislocation.

CHAPTER 22

1. Disordered state: S given by Eq. (2.48) with $\langle f \rangle$ as averaged over 3 Cu and 1 Au atom.

Ordered state:

$S(hk\ell) = f_{\text{Au}} + f_{\text{Cu}}(e^{-i\pi(k+\ell)} + e^{-i\pi(h+\ell)} + e^{-i\pi(h+k)})$ Consider the following reflections: (x \equiv refl. present)

<u>Indices</u>	<u>Disordered</u>	<u>Ordered</u>
100	no	x
110	no	x
111	x	x
200	x	x
210	no	x
211	no	x
220	x	x
221	no	x
222	x	x

2. $C = \partial E / \partial T$; now use E from Eq. (5): $E = E_0 + 2NUP^2$. Thus $C_{\text{config}} = 4NUP(T) \partial P / \partial T$, and we recall that U is negative, as otherwise an ordered state does not occur.

From Fig. 7b,

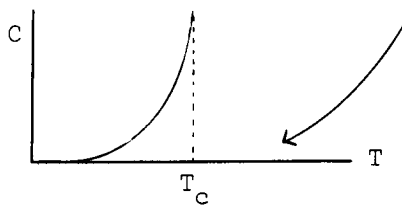

in this region a treatment based on P alone gives $C_{\text{config}} = 0$. We should look at the short range order!