

LECTURE NOTES

For Environmental Health Science Students

Sanitary Construction I



**Ethiopia Public Health
Training Initiative**

Gashaw Andargie

University of Gondar

In collaboration with the Ethiopia Public Health Training Initiative, The Carter Center,
the Ethiopia Ministry of Health, and the Ethiopia Ministry of Education

2004



Funded under USAID Cooperative Agreement No. 663-A-00-00-0358-00.

Produced in collaboration with the Ethiopia Public Health Training Initiative, The Carter Center, the Ethiopia Ministry of Health, and the Ethiopia Ministry of Education.

Important Guidelines for Printing and Photocopying

Limited permission is granted free of charge to print or photocopy all pages of this publication for educational, not-for-profit use by health care workers, students or faculty. All copies must retain all author credits and copyright notices included in the original document. Under no circumstances is it permissible to sell or distribute on a commercial basis, or to claim authorship of, copies of material reproduced from this publication.

©2004 by Gashaw Andargie

All rights reserved. Except as expressly provided above, no part of this publication may be reproduced or transmitted in any form or by any means, electronic or mechanical, including photocopying, recording, or by any information storage and retrieval system, without written permission of the author or authors.

This material is intended for educational use only by practicing health care workers or students and faculty in a health care field.

Preface

The importance of well-developed teaching materials to produce the required qualified health professionals, who are considered to shoulder the responsibility of important water and sanitation projects, should not be underestimated. Lack of appropriate textbooks and lecture notes that can meet the need to train environmental health professionals has been the major problem in the existing higher institutions in Ethiopia.

This lecture note on Sanitary Construction is created to be used as a teaching material to train mainly environmental health and other health related professionals in the country. It is expected that the lecture note will contribute significantly to solve the critical shortage of reference books and texts on the subject matter. It is also designed to make the training very practical and applicable to the actual situation in the country.

This lecture note consists of four chapters. Chapter One explains planning and organizing sanitary workshop including safety rules and care of hand tools and machines. Chapter Two elaborates on the fundamentals of carpentry. Moreover, it describes carpentry tools, materials and machines and the techniques related to them. Chapter Three points out different techniques and applications of plumbing in water supply and wastewater management. Finally, Chapter Four explains

about types of pumps and their principles of operation. Accordingly, each chapter is presented in simple language and provides learning objectives, technical explanations and exercises that can demonstrate the actual context in the country.

This lecture note received many inputs from different places. Primarily, different books, journals and existing lecture notes were used with some modification to show the actual local condition in the country. Secondly, useful ideas of different instructors of the course were also incorporated to standardize it to the present status, which the author hopes will further improve the draft through consultations, pretests and revisions. It is also hoped that this lecture note will be of particular use not only for students of health professionals in colleges and universities but also for those graduates working in health care delivery institutions.

Acknowledgments

I would like to acknowledge The Carter Center for close follow-up and material support. My special thanks go to Prof. Dennis Carlson and Mr. Aklilu Mulugeta and other Carter Center staff members in Addis Ababa for their kind and helpful advice and support throughout the preparation of the lecture note. I am also indebted to my colleagues, Shiferaw Gezahegn, Takele Tadesse, Mamo Wubshet, Yifokire Tefera, Ansha Nega and Mengesha Admassu of the Environmental Health Department and other instructors from other universities for their critical revision and comment on the lecture note material. My special thanks also go to Ato Esayas Alemayehu for reviewing and commenting on this lecture note from Jimma University and Mrs. Mulu Gebeyehu for kindly typing the manuscript.

Table of Contents

Preface	i
Acknowledgement	iii
Table of Contents	iv
List of Figures	vi
CHAPTER ONE: PLANNING AND ORGANIZING SANITARY WORKSHOP	1
1.1 Introduction	1
1.2 Learning Objectives	2
1.3 Care of Hand Tools and Machines	2
1.4 Safety Rules	4
Review Questions	7
CHAPTER TWO: CARPENTRY WORK	8
2.1 Introduction	8
2.2 Learning Objectives	14
2.3 Carpentry Materials, Tools and Machines	14
2.4 Basic Woodwork Techniques	32
Review Questions	43
CHAPTER THREE: PLUMBING	44
3.1 Introduction	44
3.2 Learning Objectives	45
3.3 Plumbing Tools and Materials	46
3.4 Drainage and Sewerage Line System	53

3.5 Basic Techniques in Plumbing	61
Review Questions	65
CHAPTER FOUR: TYPES AND PRINCIPLE OF OPERATION OF PUMPS	66
4.1 Principles of Operation of Pumps	66
4.2 Learning Objectives	70
4.3 Type of Pumps	70
4.4 Procedure of Installation of Hand Pumps	86
4.5 Tools Needed to Install Hand Pumps	86
Review Questions	87
Glossary	88
References	90



List of Figures

Fig. 1	Measuring tools	17
Fig. 2	Cutting tools	20
Fig. 3	Smoothing tools	22
Fig. 4	Boring and drilling tools	26
Fig. 5	Sharpening tools	28
Fig. 6	Finishing tools	29
Fig. 7	Butt joint	35
Fig. 8	Scabbed joint	36
Fig. 9	Cleated joint	36
Fig. 10	Half –lap joint	37
Fig. 11	Miter joint	37
Fig. 12	Dowel joint	38
Fig. 13	Dado and Rabbet joints	39
Fig. 14	Tongue and groove joint	39
Fig. 15	Coped joint	40
Fig. 16	Scribed joint	40
Fig. 17	The pitcher pump parts	67
Fig. 18	Typical pitcher pump being primed	68
Fig. 19	The pitcher pump During up ward stroke of plunger	69
Fig. 20	The pitcher pump plunger rod at down ward stroke.	69
Fig. 21	Shallow well pumps	73
Fig. 22	Deep well pumps	74
Fig. 23	Double acting pumps	80
Fig. 24	Centrifugal force pumps in cross section	82
Fig. 25	Wind mill tower and pump	85

CHAPTER ONE

PLANNING AND ORGANIZING SANITARY WORKSHOP

1.1 Introduction

Planning is a general term and may be as simple as determining activities for a day or as complicated as planning a house, a school building, or even a space capsule. It means thinking through an activity before it is performed. In modern industry, planning and organizing are the chief functions of the engineering department, which includes such divisions as product selection and design, methods of fabrication, time schedules, plant layout, and equipment selection. Great emphasis is placed on this activity because careful planning and organizing a workshop can save time, materials, and energy and insure a good product and a profitable operation.

In the sanitary workshop, you will find that careful planning will help you avoid mistakes, get more work done, and do better work. A complete planning operation in sanitary workshop will include the following activities:

- Selection of project
- Equipment

- Developing or refining the design
- Preparing presentation drawing and working drawings
- Developing procedures
- Listing materials
- Estimating costs

In order to do a good job of planning in a sanitary workshop, you must have some knowledge of tools, materials, and methods of construction.

1.2. Learning Objectives

Upon the completion of this chapter, the student will be able to:

1. Define sanitary construction.
2. Describe how to organize and plan a sanitary workshop.
3. Identify and apply safety rules in workshop.
4. Enumerate how to take care of hand tools and machines.

1.3. Care of Hand Tools and Machines

The life of a hand tool, a hand-powered tool or a piece of powered machinery depends a lot on the care taken to keep the tool in good working order. Obviously, all metal tools should be stored or placed where they are not likely to be exposed to moisture. If a tool does become wet, or even

damp, it should be wiped immediately and oiled to prevent rusting.

Since an orderly arrangement of a toolbox or a workshop means much in terms of efficient work and quality performance, too much time cannot be spent in carefully planning for the placing and storing of working equipment.

A few simple rules will suffice to cover the care of equipment:

1. Provide a place for everything and keep them in their place.
2. See that all tools are carefully protected when stored.
3. When using a plane, be sure to lay it down on its side when it is not in use; this will prevent the sharp plane bit from coming in contact with material which might ruin the sharp edge and thus will eliminate the necessity of a grinding and oilstone sharpening to put the plane back into cutting condition.
4. Avoid getting moisture on tools. On outside jobs this is sometimes impossible, and it is then essential to wipe and oil the tools carefully after using them.
5. Avoid loaning tools. Loaned tools have a way of disappearing.
6. Put tools away in their proper place after using; they will then be ready for the next time.

7. Keep tools locked up. This is good insurance against loss by theft.
8. Always buy good tools; they last longer and do better work. A good name-brand tool is always a safe buy.

1.4 Safety Rules

Woody says: An important part of your experience in woodwork will be learning to follow safe practices and procedures that will prevent injuries to yourself and others. Give close attention to the instructions and demonstrations given by your instructor and study the directions for using tools and machines listed in this lecture note. As you learn to use them the correct way you are also learning to use them the safe way.

Develop a good attitude toward safety. This means that you have a strong feeling toward the importance of safety and are willing to give time and attention to learning the safest way to perform your work. It means that you will be certain to work carefully and follow the rules even when no one is watching you. A safe attitude will protect you and others, not only in the shop but also in activities outside of school.

1. **Secure approval-** Secure your instructor's approval for all work you plan to do in the shop. He/she is the one to

decide if the work can and should be done and will be able to suggest the best, easiest, and safest way to do it.

2. **Clothing-** Dress properly for your work. Remove coats, and jackets; tuck in your tie and roll up loose sleeves. It is advisable to wear a shop apron that is strongly tied.
3. **Eye protection-** Wear safety glasses or face shield when doing any operation that may endanger your eyes. Be sure you have enough good light to see what you are doing without straining your eyes.
4. **Clean hands-** Keep your hands clean and free of oil or grease. You will do better and safer work, and the tools and your project work will stay in good condition.
5. **Consideration of others-** be thoughtful and helpful toward other students in the class. Be sure that the work you are doing does not endanger someone else. Caution other students if they are violating a safety rule.
6. **Tool selection** -Select the proper size and type of tool for your work. An expert never uses a tool unless it is sharp and in good condition. Inform your instructor if tools are broken, have loose handles, or need adjustments.
7. **Carrying tools** -Keep edged and pointed tools turned down and do not swing your arms or raise them over your head while carrying them. Carry only a few tools at one time unless they are in a special holder. Do not carry sharp tools in your pockets.

- 8. Using tools-** hold a tool in the correct position while using it. Most edged tools should be held in both hands with the cutting motion away from yourself and other students. Be careful when using your hand or fingers as a guide to start a cut. Test the sharpness of a tool with a strip of paper or a scrap of wood. Do not use your fingers
- 9. Working speed-** do not rush and tear through your work. The good Craftsman knows that a steady, unhurried pace is safest and will produce the best work.
- 10. Bench organization** - keep your project materials carefully organized on your bench with tools located near the center. Do not "pile" tools on top of each other. Never allow edged or pointed tools to extend out over the edge of the bench. Close your vise when it is not in use and see that the handle is turned down. Keep drawers and cabinet doors closed.
- 11. Floor safety-** the floor should be clear of scrap blocks and excessive litter. Keep projects, sawhorses and other equipment and materials you are using out of traffic lines. Wipe up immediately any liquids spilled on the floor.
- 12. Material and project storage-** store and stack your project works carefully in assigned areas. If the storage is overhead, be sure the material will not fall off. Straighten the lumber rack when you remove a board. Do not leave narrow strips protruding from the end of the storage rack, especially at or near eye level.

- 13. Lifting** - protect your back muscles when lifting heavy objects. Have someone help you and lift with your arm and leg muscles. Secure help with long boards, even though they are not heavy.
- 14. Fire protection-** Apply and handle finishing materials only in approved areas. Close cans of finishing materials and thinners immediately after use. Use flammable liquids in very small quantities. Be sure the container is labeled. Dispose of oily rags and other combustible materials immediately or store them in an approved container. Secure the instructor's approval before you bring any flammable liquids into the shop.
- 15. Injuries-** reports all injuries, even though slight, to your instructor.

Review Questions

1. What is sanitary construction?
2. Explain how to organize and plan a sanitary workshop for water and sanitation activities.
3. Mention some of the safety rules that should be considered in a sanitary workshop.
4. Explain how you care for tools in a sanitary workshop during and after the workshop.

CHAPTER TWO

CARPENTRY WORK

2.1 Introduction

Starting from ancient civilization carpentry is widely used in all construction; there is no construction that does not utilize carpentry technology. That is why it is included in this sanitary construction course.

There is definite evidence that wood, wherever it was available, became the favorite material for building shelters. The reasons why any construction utilizes wood as construction material are: easily available; simple to work; less cost of construction; too simple to get the required shape; easily and quickly joined with fasteners and adhesives; etc. Carpentry, as a craft, is actually thousands of years old. The earliest carpentry crafts men applied their skill to the making of many products for which wood was the principal material. In the beginning of the eightieth century, carpenters made all the fine interior cabinet work to be found in the great houses, castles, and churches in Europe. They also designed and made the beautiful furniture of that period. Present day furniture is still copied and modified from the original designs of those early master carpenters.

During the construction of a house, the carpenters are recognized as the key craftsmen. There is an old saying that carpenters drive the first location stakes and finally hand the front-door keys over to the owners. The first step in the construction of houses is the driving of location stakes. Carpenters plan for and drive those stakes. During the construction period, carpenters generally guide all the work.

The work of many other skilled craftsmen, such as plumbers, electricians, and plasterers are also essential to the completion of a house. However, they all look to the carpenters for information and for the good planning which is so necessary. Thus, to the carpenter falls the task of making all construction jobs progress efficiently and well.

As far as most ordinary types of houses are concerned, carpentry work is all-important. Carpenters construct the framework, which constitutes the "backbone" of a house and other furniture and materials. Unless framing is properly done, a house can't be safe or comfortable. Then, too, the accuracy of the framing has a great bearing on all the other work involved in residential construction and furniture. The final appearance of a house and furniture depends almost entirely up on the skill and judgment of the carpenter.

Production of wood for construction

Wood for construction is mostly produced from tree trunks, or logs and sometimes from branches and roots by direct cutting or industrial processes. This tree trunk is of two types in its species.

1. The broad leaved species of wood (tree)
2. The coniferous species of wood (tree)

Their difference is the structure of the internal fibers called the grain of the wood and their physical appearance:

- A broad leaved species of wood is identified by its network on the leaves which is seasonally dropped, and the internal grain structure seen on the lumber, which is a network of bow-shaped fibers. The type of wood produced from this species is called hard wood, due to its grain structure. It is good type of wood for construction due to its strength, attractive nature, grain structure and colour.
- The coniferous species of tree is identified by its needle-shaped ever-green leaves and internal parallel-running zigzag-shaped grain structure seen on the lumber. The type of wood produced from this species is called soft wood and is less valuable than that of hard wood. It is mostly used for packages, internal wall partitions, and so on due to its non-attractive grain structure and colour and less strength.

Main Section of a Tree-Trunk

When wood for construction is produced from a tree trunk we see three sections, due to the position of the cutting blade (saw) passing through the trunk.

1. **Cross-section:-** is seen when the cutting plane (blade) passes across the grain and circular rings are seen on the surface.
2. **Radial section:-** this is when the cutting blade passes along the grain through the central pith, and parallel running fibers are seen on the face.
3. **Tangential section:-** When the cutting blade passes along the grain at some distance from the central pith and a bow shaped grain structure is formed on the face.

The cross-section of a tree trunk shows us the three structural portions of a tree:

1. The outer covering portion called the bark
2. The central loosely joined tissues to thin straight line called the pith
3. The main valuable medium portion from the bark to the pith called the wood, divided into two: the dead cell called heart wood next to the pith, and; the life cell portion, called the sapwood next to the bark. It is this part from which wood for construction is produced and is the hard and stronger portion of a tree trunk.

The main forms of wood product

Wood for construction is commonly produced in two forms:

1. In solid form:- this is produced by directly cutting logs into timber, lumber, boards, etc. by hand saw or high scale cutting machine (e.g. lumbers, solid boards and stocks.) This form of wood product is very useful for construction, specially where there is a need of load carriage.
2. Fabricated and laminated form of wooden sheets and boards, as ply wood fiberboard, chip wood etc.

- **Ply wood** is made from a number of slices of wood encased in veneer, overlapping one another cross-wise or at right angle to each other in their grain (fiber) direction in order to increase strength.
- **The grain** of the consecutive layer of veneer overlaps should be three or more odd numbered layers, to ensure the same face on both surfaces.
- **Chip wood:** is an artificial board (sheets of wood) made from ground chips of tree trunk, branches and roots which is mixed with synthetic resin (glue), then pressed at high pressure and temperature. It is specially produced from low-grade wood and branches and roots. Its disadvantage is it does not resist any moisture and water
- **Fiber board** is another form of wood made from wood fibers felted (sliced) from wood or other vegetables,

mixed with resins and pressed, as that of chip wood. Chip wood and fiber boards are mostly used for ceilings, internal covering and where there is no exposure to moisture.

Effect of moisture on wood

Wood is more greatly affected by moisture than other construction material. Every wood has its own natural moisture content. This moisture is called normal wood moisture content. It is about 30% of the maximum moisture that a green wood can have. This normal moisture content is called saturation. If the moisture in wood goes beyond its normal point the wood will swell and tends to decay, which results in loss of strength, colour, and durability. If the moisture goes down (below its normal point) it results in wood defects such as creaks, twists, warping, etc.

But drying of wood has its own advantages. Therefore, to prevent these defects (creaks, twists, warping, etc.) wood should be dried in controlled method, which is called seasoning.

Seasoning:- is a process of removing moisture from wood in a controlled manner to prevent defects happened due to non-uniform shrinkage of wood.

Advantages of drying of wood by seasoning

- Minimizes decaying
- Decreases weight and stiffness
- Reduces defects as checking, creaks, warping and twists
- Facilitates taking up of gluing materials sanding and finishing materials
- Increases fastener-holding strength.

2.2 Learning Objectives

Upon completion of this chapter, the student will be able to:

1. Define carpentry.
2. Identify and apply basic woodwork techniques.
3. Enumerate and apply carpentry materials, tools and machines especially in water and sanitation projects.

2.3 Carpentry Materials, Tools and Machines

Carpentry is an art, which deals with making and repairing of any wooden objects.

A. Carpentry materials

These are any materials that are used to perform some carpentry activities.

1. Abrasives and sand papers

Since sandpaper is no longer made with sand, industry has adopted and uses the term "coated abrasive." This is a more descriptive term that can be generally used for various kinds of abrasive materials that are applied to paper or cloth, and then made into sheets, discs, drums, belts, and other forms.

There are four principal kinds of abrasive materials used for woodwork:

1. Flint
2. Garnet
3. Aluminum oxide
4. Silicon carbide

2. Wood adhesives

The most common wood adhesive is called glue. Glue is an adhesive substance that binds or fastens together any absorbent substances as paper, wood etc., by forming a binding force between the joined materials.

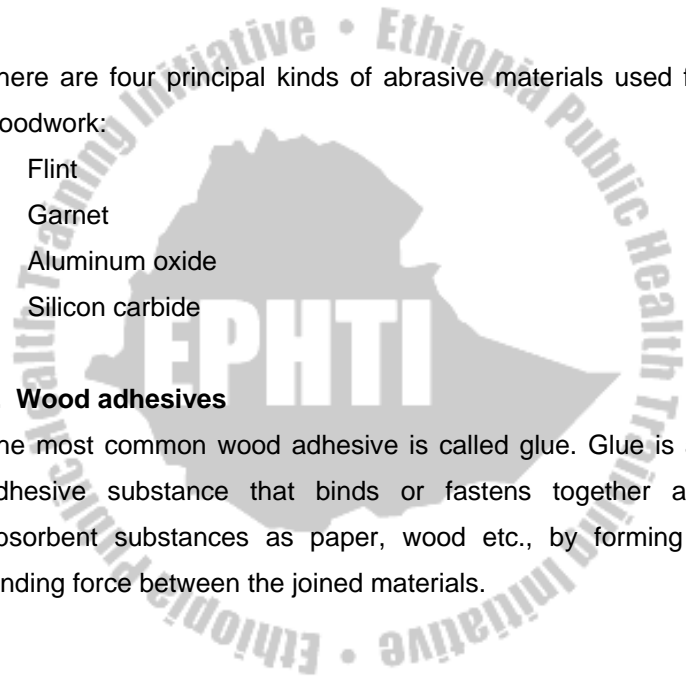

There are two types of glue:

a) Natural glue:

This is produced from direct extraction of animal protein, animal hides, skin, bones etc; and plant protein as oil residues and oil seeds etc.

b) Synthetic glue:

This is produced from the result of a reaction of condensation and polymerization of adhered substances. It is good glue for all woodwork joining and has enough resin.

3. Wood fasteners and wares

Human beings have been used glue as wood fasteners since early times. Good glue makes joints and parts even stronger than the wood. When we apply glue, it spreads over the surface and goes into the pores of the wood.

Fasteners and woodwork include: Nails, screws, staples, bolts, glue, spines, and many special items.

4. Finishing materials

Finishing materials and equipment used for finishing include brushes, wax, sand paper, linseed oil, alcohol, turpentine, steel wool, pumice, rotten stone, rubbing oil, thinner, varnish, shellac, lacquer and paint.

B. Carpentry tools and machines

1) Measuring tools-

Measuring tools are used for measuring before any activities are performed to have accurate performance. Some of the measuring tools are listed as follows. (See Figure 1)

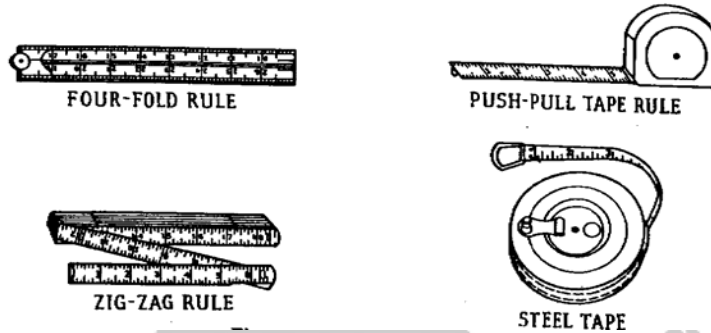

Figure 1 Measuring tools

A. Rules: are tools commonly used for measuring distances. There are different types of rules:

- **Pocket rules:** Pocket rules are made of either wood or metal and are used for any kind of measuring on projects made on a bench or as part of house. These rules are often referred to as folding or zigzag rules. The flexible push-pull 6 or 8 feet tape is also classified as a pocket rule.
- **Steel tape:** A steel tape is required for house-construction layout where measurements longer than 6 or 8 feet must

be made. The 50 feet tape is long enough for most carpentry needs. A cloth tape is not considered satisfactory for accurate measuring since it varies in length according to the amount of stretching done by the user.

B. Squares : are measuring tools used for measuring angles and checking squariness and flatness of a surfaces as well as for measuring distances of a work place.

The common types of squares are:-

- Framing square:- also called carpenter square. It is a large hard steel square used for base angle laying out for carpentry as well as masonry. It measures only right angles for testing squareness of internal and external angles.
- Try square: is built up of two parts; thin hard steel called the blade and thin hard metal called the handle. It measures right angles as well as 45° angles. It is a very important commonly used type of square and has divisions units to measure distance.
- Marking gauge: - made from wood or metal and has a beam and head that can be adjusted to various length. It is for making lines parallel to the given edge or end.
- Combination square: - it has a moveable head which is used for measuring 45° on one side and 90° on the other

side in addition to checking horizontal and vertical level with horizontal bleed.

- T-bevel is similar to try square except having a movable bleed and adjustable handle, which enables to lay out different angle measure and chamfer and bevel checking.

2) Layout tools

Layout tools are tools used for making or pointing the measurements on the working surface:

- Pencil: is one of marking (laying out) tools which marks the measured units with its lead colour. The common wood pencil is called carpenter pencil.
- Divider: resembles a compass, but both legs are sharp tipped metal instead of fixed pencil on one leg of a compass. It is used to transfer measurements from measuring tools to a work piece and to scribe circles, arcs etc. on a work piece by scratching lines.
- Trimmed point: is used for scribing large circle and arcs that are too large to be marked by divider. It has one horizontal beam on which two pointed legs, one of them is moveable, attached on it.
- Marking knives: puts mark of measured units by its sharp edge. It just looks like a knife.

3) Cutting tools

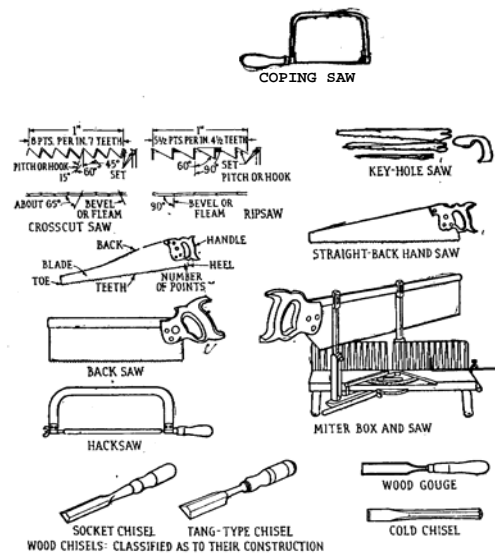

Fig. 2 Cutting tools

Cutting tools are varied in character and purpose (See figure 2). They include saws and chisels. The term cutting, as used here, refers not only to making two or more pieces from one piece, by means of a saw, but also to dapping hinges (cutting in a flat recess exactly to receive one leaf of a hinge) and shaping various parts of a project by means of a chisel or gouge.

Saws: are cutting tools that cut wood by its sharp tip of teeth. There are different types of saws. The commonest ones are:

- **Crosscut saws:** The carpenter should have two crosscut saws: one 8-point saw for cutting rough or green lumber and one 10-or 11-point saw for finish work. Each should be 26 inches in length.
 - **12 inch backsaw:** The 12-inch backsaw is very useful for fine cabinetwork. It has very small teeth designed for fine cutting. The manufacturer establishes the number of teeth per inch.
 - **Keyhole saw:** Usually purchased with detachable blades, of three different lengths, which can easily be removed and replaced on the handle, the keyhole saw is useful for cutting inside circles or small curved corners or angles.
 - **Miter box saw:** A miter box, actually a metal frame carefully designed to hold vertical posts in which the saw slides, permits fine duplicate precision cutting for any angle desired on material up to the width capacity of the box.
 - **Hacksaw:** A hack saw is a "must" for the mechanic who does a great variety of work. This tool is used for cutting metal, such as bolts and nails, and is constructed so that the blade can be replaced as it becomes worn.
- 3) **Smoothing tools:** are tools to smooth surfaces of the wood to produce leveled, plane and accurate angle surfaces.

Hand Plane:

Planes are the most commonly used woodworking cutting tools used to plane surfaces of the wood to produce leveled, smooth and accurate angled surfaces.

There are different type of hand planes, which differs from each others in size, working condition, shapes and the surfaces produced after planing. The most common wood planes are: (See figure 3)

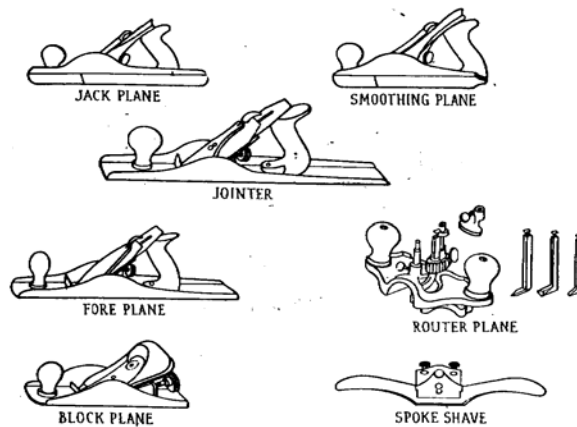

Fig. 3 Smoothing tools

There are different types of smoothing tools. The main ones are:

- **Jackplane:** The jackplane is an all-purpose plane, although it is generally used to remove the surface of a

rough piece of lumber, after which the smoothing plane is used to give a very smooth surface.

- **Smoothing plane:** The smoothing plane is used for the final smoothing of wood prior to sanding. If this tool is kept in sharp condition, much time and effort are saved in sanding.
- **Fore plane:** The fore plane, which is 18 inches in length, serves admirably as a jointer on short stock. It should not be used for hanging doors, except small cabinet doors.
- **Jointer plane:** A jointer is made either 22 or 24 inches in length and, as the name implies, is designed for making the edges of boards straight prior to gluing them together. The tool is also a necessity for full size door hanging.
- **Block plane:** is a small plane designed to cut end grain of wood. It is useful for general purpose planing because the plan can be held in one hand and the work piece with the other hand.
- **Rabbet plane:** is used for cutting rabbets grooves and slots along the grain of the wood. It is made from two chisel like blade adjusted at different depth.
- **Spoke shave:** is designed for smoothing curved edges and flat surfaces of wood. Its shape and size cutting principle is the same

Important parts of a hand plane

1. The Plane Iron: - also called the blade.

It is the main functional part in cutting the wood with its sharp edge. Since it is the important cutting part it should be kept sharp, grinding with a grinder or with metal files.

During grinding (sharpening) the plane iron, the following should be taken in to consideration.

- a. The beveled of sharp edge should approximately be from 2-2 ½ times blade thickness
 - b. The angle of the bevel should also be from 25° – 35°
 - c. The sharp edge should be right angled with the side edge of the blade
 - d. The sharp edge should be soaked in water to prevent the bald tip from turning blue due to extreme heat; it is the sign of loss in strength.
 - e. After grinding it should be wetted on a grindstone to remove sharp corners
2. Plane iron cap: is a bender metal fixed to the blade in assembling to reinforce it and to break the chips or shaves coming through the throat.
 3. The lever cap: is the outer covering metal which keeps the overall assembly stationed or fixed by pressing the piece fastened on it, called the cam.

4. The depth adjusting screw: is used to adjust the depth of the blade by pushing forward or pulling back the blade through the throat.
5. The lateral adjusting lever:- is a long thin flat metal fixed on the frog used to adjust the blade tip side-wise parallel to the bottom sole of the blade through the throat.
6. The gap through which the blade tip comes out to plane the wood surface is called the throat.
7. Wood chisels and gauges
 - a. **Chisels:** are cutting tools used to cut outside and inside curves of small radius, holes, slots and grooves and to remove wastes and shavings from slots and grooves. It is also used to cut joints, to make models and decorations on wood surfaces.
 - b. **Gauges:** are chisel like cutting tools with curved sharp cutting edge. They are used for cutting round holes, grooves, decorations, and used on wood lathe machine for rounding wood.

There are two types: one has an inside beveled gauge and the other one is an outside beveled gauge. The sharp edge of the gauge is a concave shaped tip.

4) Boring and Drilling tools

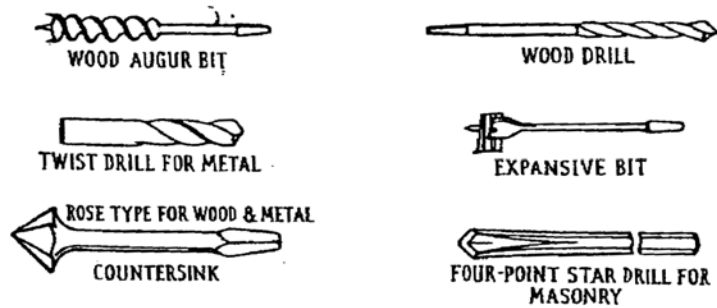

Figure 4 Boring and drilling tools

Boring and drilling tools are tools that are used to make a hole in materials. (See figure 4)

Boring tools are classified according to the nature of the work that is done with them. Typical boring tools that are used to make holes are augur bits, drill bits, expansive bits, counter sinks, and star drills.

- **Augur bits:** For boring holes in wood, augur bits are available that vary in size from $\frac{3}{16}$ to $1 \frac{1}{8}$ inches (by sixteenths) and from $1 \frac{1}{8}$ to 2 inches (by eighths).
- **Wood drill:** As its name implies, the wood drill is only used to drill wood materials. The skilled carpenter will usually have several of the smaller sizes, such as $\frac{1}{8}$ -inch, $\frac{1}{4}$ -inch, etc.

- **Twist drill:** The twist drill is designed for drilling in metal only. It can be used in shallow-hole drilling, and in electric, hand, and breast drills. Obviously, if the twist drill is, say, $\frac{3}{4}$ inch in size, it must be used with a power drill in order to bore a hole in metal.
- **Expansive bit:** This bit is particularly useful in fitting cylinder locks or for boring holes to receive metal pipes, etc. It can be purchased with two detachable expansive bits, each of a different size, permitting the cutting of holes up to 3 inches in diameter.
- **Star drill:** The star drill is a very useful tool for making holes in masonry to receive a bolt sleeve or a metal sleeve. Star drills come in several different sizes, which are designated by the diameter measurements as $\frac{1}{4}$ inch, $\frac{3}{8}$ inch, etc.

5) Sharpening Tools

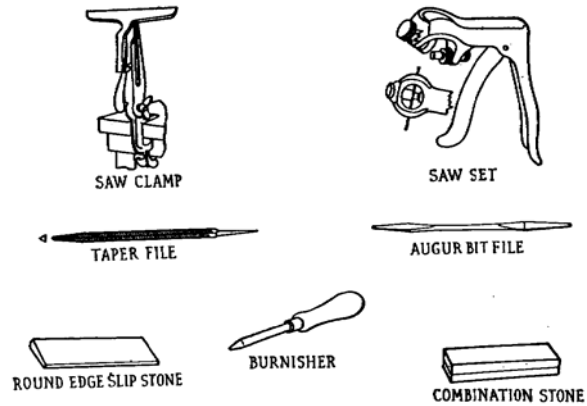

Fig. 5 Sharpening tools

Sharpening tools are divide into several groups. These are

- **Saw set:** A saw set is needed to set the teeth of a handsaw to provide cutting clearance so that the saw can slide freely; rough lumber requires a saw with considerable set; finish saws have a little set. The amount of set in a saw, provided that the saw is properly filed, determines whether the resulting cuts are smooth or rough.
- **Saw files:** Saw files are procurable in sizes designated as extra-slim taper, slim taper, and regular taper. They are made in various lengths. A saw file must be purchased on the basis of the type of saw to be filed. There are so many

variations that no description is possible here but a good hardware man will know what size to recommend for a specific type of saw.

- **Bit files:** For augur bits, a special file is obtainable with "safe edges" (no teeth) to permit filing the cutting edges of the bit without injuring the other metal parts.
- **Slip stone:** A slip stone is required for sharpening gouges and carving tools. Various shapes, sizes and fineness of grit are available. This tool is not a necessity unless one has a set of carving tools or a gouge or two in his tool kit. (See figure 5)

6) Finishing Tools

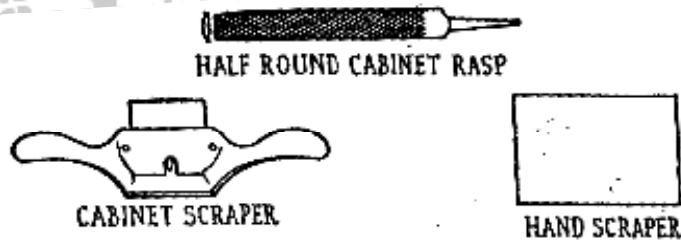

Fig. 6 Finishing tools

After a piece of finish stock has been planed to remove imperfections, it is often necessary to do more 'finishing' to prepare the stock for the stain, varnish, lacquer, or other

materials used to preserve the surface of the wood and give it an attractive appearance. (See figure 6)

- **Cabinet scraper-** The cabinet scraper is fitted with a removable beveled-edge scraper blade which, when properly sharpened by turning the sharp corner of the beveled edge with a burnisher, will smooth ridges or torn grain left by the smoothing plane.
- **Hand scraper** - The hand scraper is a piece of steel 2 or 3 inches in width and 4 to 6 inches in length. The sharp corners of this tool are sharpened by the use of a burnisher and will actually remove a very fine shaving. It is especially adaptable in close quarters, where it would not be possible to use the cabinet scraper.

7) Hammers

Two shapes of nail hammerheads are in common use:

1. The curved claw hammer
2. The ripping (straight) claw hammer.

The curved claw is the most common and more suitable for pulling nails. The ripping claw can be driven between fastened pieces and works somewhat like a chisel in prying them apart.

8) Ripping bars and nail claws

1. Mark the lumber to be sawed or ripped.
2. Hold the board on a saw horse if possible.

Claw hammer (nail claw) is used to drive and pull out nails. The size of the claw hammer is determined by the weight of the head. The sizes that are used mostly are 14 to 16 ounces. The claws may be curved or straight.

9) Screwdriver and chisels

The screwdriver is used to drive in and withdraw screws. A screwdriver with a square head is used together with brace. The screwdriver tip must be correctly shaped. It is the screw head that determines the shape of the screwdriver tip.

Chisels are essential cutting tools that are used in woodworking. They are used in joint construction, and in fitting, shaping and in cutting curves. There are two types of chisels:

1. **Tang chisel**
2. **Socket chisel**

The names indicates how the handle is fastened into the blade. Both types have a beveled cutting edge. The width of the blade determines the size of the wood chisel.

According to their use, chisels are divided into the following classes:

1. **Firmer:** has a strong blade and may be used for heavy and light work.

2. **Paring chisel:** has a slender blade, mainly used for hand chiseling.
3. **Framing chisels:** has a very heavy and strong blade and is used in rough carpentry work and shipbuilding.
4. **Butt chisel:** differs from others only in that it has a shorter blade and can be used in more inaccessible place. It is commonly use for cutting hinges.
5. **Mortise chisel:** as its name implies, it is used for cutting mortise.
6. **Gauge chisel:** is used for grooving, shaping edges and model making.

2.4 Basic Woodwork Techniques

A. Cutting

In cutting wood, the purpose of the cut, whether sawing, planing, boring, sapping, routing or sanding is to separate stock along its length, width or thickness. Every wood cutting tool is a wedge or a series of wedge with a single or double bevel.

The teeth of all saws (hand or machine saws) can be classified as:

1. Ripsaw
2. Cross-cut saw
3. Combination saw

The shearing is accompanied by the cutting edge of the blade or teeth being wedged into the stock in the sliding motion and usually to a regulated depth.

Complicated joints and work on the table saw may require a series of cuts. The cuts must be carefully planned. Some cuts that can easily be made at first may be difficult or impossible to make at the end of the sequence.

B. Boring

Boring means cutting larger holes with brace and auger bits. One must bore the holes in exactly the right place and in the correct direction. When the holes goes right through the stock, take care to prevent pieces from splitting off when the bit comes through.

C. Forming

Wood is formed into shape through the following techniques:

1. Bending
2. Compressing
3. Laminating

D. Jointing

Wood joints, as commonly used in wood working, means the place at which two separate piece of wood are connected, united or combined together for the purpose of changing

direction. There are many kinds of joints used in building construction, furniture construction, pattern-making, cabinet-making and boat-building. Most of them can be classified into a few basic groups.

In choosing wood joints for furniture construction, you need to give consideration to their strength, appearance and difficulty of construction. Your choice will also be based on the kind of wood you are using and the direction of the grain in the parts. Taking the appearance into consideration does not necessarily mean that the joint should be seen. Joints which can be seen but which have correct proportions and which fit may add to the character and attraction of the design.

The type of joint (or joints) selected is dependent on a number of factors:

1. The purpose of the job
2. The material to be used (i.e., its working qualities and strength) Soft woods may require a different type of joint than hard woods.
3. How the job is to be used. Is the job part of a whole that will be come a fixed part, such as a framed opening in a wall, or will it be moved occasionally, such as a piece of furniture?
4. Method of fastening the joint, which may require nails, screws, glue, dowels, or metal fasteners, or possibly a combination of several of these.

There are different kinds of joints. These are:

1. **Butt joint** - It is the simplest of all joints. In house framing, it is a good "load carrying" joint and a very easily made joint. The end of a board or framing member is cut off perfectly square and then butted against a piece of lumber having similar dimensions. The butt joint is an excellent joint for rough carpentry jobs, where strength is most important and appearance is not a prime requisite. (See figure 7)

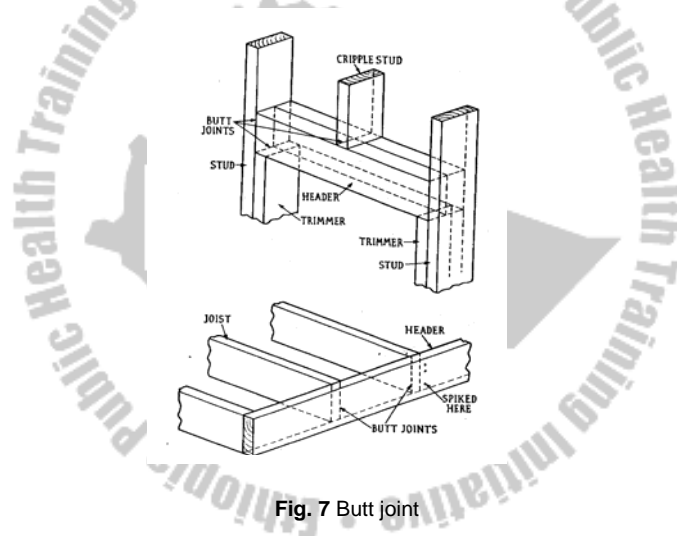

Fig. 7 Butt joint

2. **Scabbed joint**- Sometimes it is necessary to join two short pieces of lumber to make longer pieces. The scab ties the two pieces together. It is definitely a rough-carpentry joint and only used where appearance doesn't count or where the joint may eventually be completely hidden. The piece of lumber or scab

is usually face-nailed to the lumber to be joined. It is common that box nails of suitable length are used. (See figure 8)

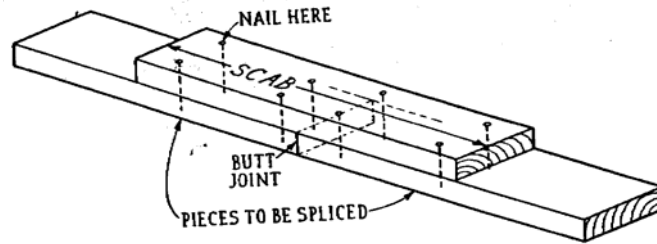

Fig. 8 Scabbed joint

3. **Cleated joint**- The cleated joint has some of the characteristics of the scabbed joint. It is, however, a carpentry semi finish method and used to fasten two (or more) boards together to make a wider board. It is often used in making rough doors for frame buildings and face cleats are fastened on with screws or nails. (See figure 9)

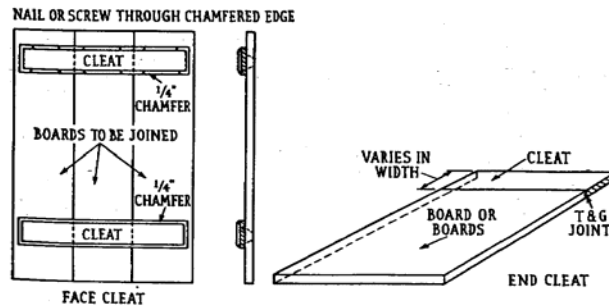

Fig. 9 Cleated joint

4. **Half-Jap joint:** A half-lap joint is useful in constructing a workbench. It is used primarily to provide rigidity and strength when two pieces are to be joined, usually at a 90° angle. The joint is formed when the two half laps are fitted together and held by means of nails (in very rough carpentry) or, preferably, by countersunk wood screws, at least two to each corner joint. To increase strength of the joint, use glue and clamps. (See figure 10)

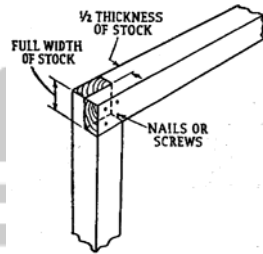

Fig. 10 Half-lap joint.

5. **Miter joint:** This is a finish joint and is not used where strength is the main factor. It is most often used to make the 90-degree angle formed by the top and side casing of a window or doorframe and to construct picture frame. If the pieces to be mitered are molded, the 45° angle of the cut must be very carefully laid out. (See figure 11)

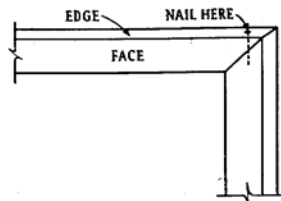

Fig. 11 Miter joint.

6. **Dowel joint-** Doweling stock is made from birch or maple. The dowel joint is used for fine cabinetwork, such as a cabinet door, to ensure strength and holding power where the rails and stiles are joined. Preparing a dowel joint is a good test of craftsmanship. The holes made to receive the dowels must be carefully bored at right angle to the joint edge. Hot glue is preferable on the dowel joint. Cold air will make hot glue set very quickly. Cold glue, however, is very satisfactory in regard to strength. (See figure 12)

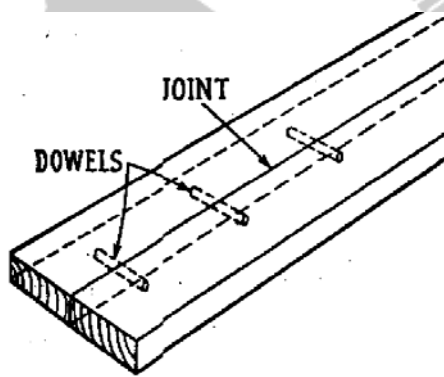

Fig. 12 Dowel Joint.

7. **Dado and Rabbet joints-** A dado joint and a rabbet joint are very similar in shape and purpose and are usually made with the same tools. The rabbet joint is used at the corners of a window or doorframe or in making a set of shelves. The dado joint, which is a groove made at right angle to the grain of a board, is used to hold a shelf in exact position to the

vertical supporting member. Dado and rabbet joints are commonly used on many cabinet and other finish carpentry jobs. (See figure 13)

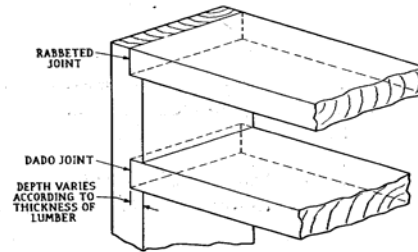

Fig. 13 Dado and Rabbet joints

8. **Tongue and groove joint-** A tongue and groove joint is usually a machine-made joint and is used primarily in flooring, wall sheathing, finished the face of a wall with knotty-pine boards, and doing any similar work in which a number of boards must be joined to make a smooth, flat surface. A groove is made in the edge of one board to receive a tongue made in the edge of another board. (See figure 14)

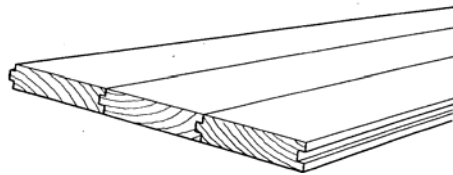

Fig 14 Tongue and groove joint

9. **Coped joint** - A coped joint is used when fitting one piece of molding at right angles to a second piece. This joint is most often used when fitting molding on the walls of a room or on the surface of a piece of paneling. (See figure 15)

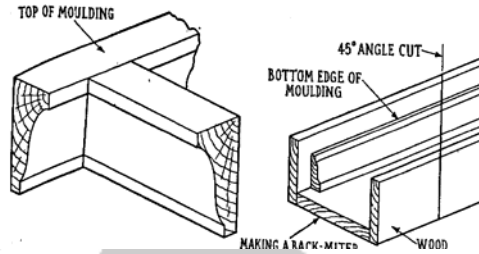

Fig. 15 Coped joint

10. **Scribed joint** - A scribed joint is required when a piece of finish stock is to be fitted at right angles against a slightly uneven surface, such as a plastered wall. (See figure 16)

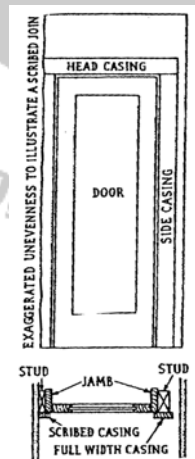

Fig 16 Scribed joint

E. Finishing

Finishing in construction is coating or covering of the external surface with protective and decorative film forming materials. Wood in its nature is a porous, absorbent material. Uncoated wooden materials tend to absorb moisture, fumes, oils etc., which causes it to swell, shrink, check, warp and discolor. It is also subjected to fungi and insect attacks, which result in wood defects.

Coating or covering the external surface with coating or film-forming materials such as paints, varnishes, enamels can slowdown or stop these external effects. This process is known as finishing of wood, as it is the final or last process in construction.

Purposes of finishing

1. To protect wooden materials against environmental effects such as:
 - Moisture
 - Heat
 - Fumes
 - Frost
 - Light, etc.
2. For decorating the external surfaces to:
 - Give attractive color
 - Clarify the attractive nature and grain texture
 - Produce smooth, level and shiny surface

3. Ease the problems of cleaning and reduce dust collection of surfaces.
4. Make odorless and non-attractive to insects and other organisms.

Types of finish

Depending on the nature of the materials used, there are two types of wood finish. There are opaque and transparent wood finishes.

1) Opaque wood finish: is the type of finish that hides or completely covers the natural color, grain texture and nature of the wood. The material used in this case is colored liquids such as paints, stains etc. It is used mostly for:

- Slightly water exposed furniture
- Low grade (non attractive nature) of wood
- Outdoor furniture and materials
- Special purpose furniture as hospital, baby, kitchen, furniture, etc.

2) Transparent Finish- as the work implies it is the type of finish in which all the natural color grain texture and attractive nature of the wood is clearly seen through the film-forming protective layer. The materials used for coating are colorless after drying, such as varnishes, wax, enamels, etc. It is applicable:

- For high quality (grade) wooden furniture

- On the opaque finish to give hard surface
- Where there is no need for covering the nature of the wood.

Finishing materials include:

1. Paint: produces colored protective layer
2. Varnishes, lacquers, shellacs are colorless, organic solvent-finishing materials, which produce transparent protective layer on the wood. It is a film-forming substance that clearly magnifies the natural texture, attractive nature and color of the wood.

Review Questions

1. What is carpentry?
2. What is the application of carpentry for water and sanitation activities?
3. Mention some carpentry tools, materials and machines required for water and sanitation activities.
4. Mention the types of finishing activities and materials used for finishing activities.

CHAPTER THREE

PLUMBING

3.1 Introduction

Plumbing includes the practice, materials and fixtures used in the installation, maintenance, extension, and alteration of all piping, fixtures, appliance, and all appurtenances in connection with any of the following: sanitary drainage or storm drainage facilities, the venting systems and the private water supply systems, within or adjacent to any building, structure or conveyance; and the practice and materials used in the installation, maintenance, extension, of the storm water, liquid waste and the water supply system of any premises to their connection with any point of public disposal or other acceptable terminal.

Plumbing can be categorized into two main classes: water supply and wastewater plumbing. These categories have their own principles, materials, tools and related techniques to deliver water or to dispose the by-product to appropriate places in a sanitary manner.

The importance of safe methods of sewage collection, and disposal, and provision of safe water supply are realized by all

sanitarians. One of the links of this chain is the house drainage system, in other words, the plumbing system. Its importance is enhanced by the fact that it is in far closer contact with everyday life of the citizen than is the common sewer or sewage treatment plant. The sewage, which the plumbing system carries, is potentially dangerous in that it frequently contains disease-producing bacteria. Leakage in plumbing systems, therefore, is a means to health in the house where well water supplies may be contaminated. In other cases, an offensive condition will result. A further danger is the possible entrance into the house of insects and rats from the drainage system, possibly bearing on their feet and bodies the germs of disease. Sewer air may also enter into the building through defective plumbing.

3.2 Learning Objectives

1. Define plumbing.
2. Identify and apply plumbing tools and machines.
3. Exercise basic techniques in plumbing.
4. Exercise basic techniques in drainage and sewerage systems.

3.3 Plumbing Tools and Materials

A. Plumbing Tools

1. Plumbing tools for measuring:

- Marking pen
- Plumb level
- Spirit level
- Flange square
- Fold meter
- Caliper
- Tape meter

2. Plumbing tools for threading:

- Threading die
- Die stock from 3/8 to 1 1/4 "
- Internal threading tools
- Adjustable threading tools

3. Plumbing tools for cutting:

- Steel pipe cutter
- Chain cutter
- Sharp chisel
- Hacksaw
- Holesaw
- Reamer

4. Plumbing tools for bending:
 - Bending machines
 - Bending spring

5. Plumbing tools for drilling:
 - The BI hand driving machine
 - Manual hand driving machine
 - Brick chisel
 - Concrete chisel

6. Other instruments for plumbing work:
 - Adjustable spanner
 - Adjustable wrench
 - Chain wrench
 - Pipe vise

B. Plumbing Materials

1) Pipes

Pipes used for rural and urban water supply and wastewater disposal projects are pressure pipes, and are usually manufactured from plastics, galvanized steel or asbestos, cement and copper pipes. Each material has particular advantages and disadvantages. When two or more materials are suitable for a given situation, the selection will be based on cost.

Choice of pipe materials depends on:

1. Required strength
2. Corrosion resistance
3. Erosion resistance
4. Roughness factors
5. Cost effectiveness

Kinds of pipes used for water supply system

1. Steel pipes - It is the most common employed pipe, normally connected to fittings by threaded joints. It is manufactured in 21-ft length and the fittings are factory-threaded. Screwing pipe and fittings together makes joints.

The steel pipe is the strongest pipe and the most rigid of the piping materials. Its cost is low, easily maintainable, easily portable, and a wide range of sizes are available.

2. Plastic pipes - For most projects it will be found that plastic pipe will prove the most suitable. While there are a number of different types of plastic pipe, rigid PVC is the most commonly used, though high density polyethylene is frequently used when long lengths of small diameter pipe are required. Apart from being highly competitive in purchase price, its extreme lightness makes site handling easier and, once laid, it presents no problems of corrosion or encrustations. A further

advantage is that, due to its low friction losses, it is usually possible to use PVC pipes one size smaller than a metal pipe for the same flow and head loss conditions.

Major Advantages and Disadvantages of Plastic Pipes.

Advantages

1. Low costs, capital, transport and laying
2. Lowest friction loss of all water pipe material
3. Non-corrosive
4. Non-toxic
5. Good insulation
6. Low thermal conductivity
7. Rapid and simple jointing
8. Good for laying under water
9. Flexible
10. Extremely light and easy to handle

Disadvantages

1. Brittle at certain temperatures
2. Loss of strength at high temperature
3. Not suitable for laying above ground
4. Requires ample ground cover to avoid damage
5. Can deform during storage

Copper tubing - It is the most expensive material used for the transportation of water and gases. It is non-corrosive with most water and used extensively in better grade houses. Also used where ground water is highly corrosive to well pipes.

Galvanized steel pipe - It is important to install under heavy loads, exposed as on bridges and lines under pressure. Pipe sizes are usually expressed as nominal diameter (in inches). The sizes normally used for small water supplies are $\frac{1}{2}$ ", $\frac{3}{4}$ ", 1", $1\frac{1}{4}$ ", $1\frac{1}{2}$ ", 2", $2\frac{1}{2}$ " and 3". Galvanized steel pipes are jointed by means of sockets; the pipe has a taper thread while the socket has parallel thread. Most pipes are zinc galvanized. However, ungalvanized or black pipe is available (primarily as well casing). Pipes are usually welded. These are somewhat cheaper than seamless pipes, and the former are entirely suitable for small community water supplies.

Major Advantages and Disadvantages of Galvanized Steel Pipes

Advantages

1. Robust but may bend
2. Easy to lay and joint
3. May be laid to above ground
4. Generally unaffected by climatic conditions
5. Fittings inexpensive extremes

Disadvantages

1. Liable to internal and external corrosion
2. Liable to incrustation
3. Higher friction head losses
4. Relatively high cost of purchase
5. Relatively high cost of transport

Asbestos - cement pipes - pipe comes in greater length, therefore has fewer joints; it has a smooth surface, is non-corrosive and easily jointed, and resistant to electric current and concentrated salts. The more common joint is asbestos - cement sleeve joint incorporating two rubber rings.

Major Advantages and Disadvantages of Asbestos - Cement Pipes

Advantages

1. Durability (known to exceed 50 years)
2. Immunity from corrosion
3. Low friction (low head loss)
4. Good thermal insulation
5. Lighter and cheaper than metal pipe

Disadvantages

1. Liable to damage in transit.
2. Not suitable for laying above ground or in rocky ground
3. Supplied in relatively short lengths, hence more joints
4. Asbestos can be very hazardous to your health

2. Fittings in water supply

Fittings in water supply are devices used to connect or bend or reduce/ enlarge or close pipes that serve different purposes.

Cap: A fitting into which the end of a pipe is screwed for the purpose of closing the end of the pipe.

Coupling: A pipe fitting with inside threads only used for connecting two pipes.

Elbow: A fitting joining two pipes at an angle.

Plug: A pipe fitting with outside thread and projecting head, often square, that is used for closing the opening in another fitting.

Reducer: A pipe fitting with inside threads, larger at one end than at the other. All such fittings having more than one size are reducers because of the custom of stating the larger size first.

Trap: A fitting constructed with a water seal that, when placed in a drainage pipe, will prevent the passage of air or gas through the drainage pipe but will not prevent the flow of liquids through it.

Union: A fitting used for joining the ends of two pipes neither of which can be turned. There are two kinds of unions.

Tee: An internally threaded fitting that is used to distribute pipes with a "T" mode.

Cross Tee: an internal threaded tee that is used for distributing pipes across the four sides by making an angle of 90° .

Nipple: a short piece of pipe with outside threads used for connecting pipes or fittings in threaded joints.

Y- branch: an internally threaded fitting used to distribute a pipe in a “Y” shaped mode.

3.4 Drainage and Sewerage Line System

A prerequisite to sound design of a distribution system is a complete survey covering all streets and showing elevation of all-important points. From this survey, a map is prepared on a scale to show streams, important geographical features and adjacent areas likely to require services during the design period, and proposed as well as present streets. With the aid of this map, the principle features of the system can be planned. These maps also show the exact locations of the pipes in the streets.

The higher valves should be used at high altitudes, where:

- a. The soil is wet
- b. The pipe runs under roads
- c. Driveways.

The pipes should be laid reasonably straight and on a uniform grade. An elevation of 20 ft will provide a satisfactory flow for moderate demands if the pipe is short and large enough, but for long distances, higher elevation is desirable.

A. Some Appurtenances in Sewerage System

Manhole: It is important when there is:

- change in direction.
- change of size of diameter pipes.
- a junction.
- a need of cleansing.
- a need for inspection

Manholes should be placed at distances of not more than 110m on long straight lengths. This distance may be increased in the case of large sized sewers. The reason is for maintenance and installation. In addition these requirements are primarily to facilitate rodding when blockages occur. Sometimes, it is believed that 110m is too large for small diameter pipes and one should provide manholes at 80m intervals on straight lengths.

Waste pipes - There are different pipes that can be used for the conveyance of wastewater from the source of generation to the final disposal site. Some of the common types are:

1. Concrete pipe

For small and medium size sewers, up to 24" in diameter, the use of non-reinforced concrete pipe is generally economical. If it is properly manufactured, it is highly resistant to weathering, chemicals (except acids) and wear. Acids should in general be kept out of sewers or neutralized.

2. Cast iron pipe

It has a long life span, provide good flow characteristics, has the ability to withstand high internal pressures and external loads, and is corrosion resistant in most soils.

3. Plastic pipe

It is rapidly increasing in popularity because of its light weight, and ease of handling and assembly. Although such pipe is becoming widely available, its uncertain life tends to prevent its widespread use for sewers. It is also free from corrosion, has good resistance to shock, acids and sunlight or bad weather, has flexibility, etc.

4. Asbestos-cement pipes

These pipes are highly subjected to corrosion. However, they are low in cost, watertight, have low infiltration, and good flow characteristics, and are lightweight and easy to handle and cut.

B. Construction of sewer pipe

Inspection is perhaps the most important part of sewer construction. The pipe is generally tested under inspection and marked before delivery to the job. Aside from quality of the finished products there are other important reasons:

- For close inspection safety
- To control pollution of groundwater
- To know the foundation is adequate

Concrete support is the best support for sewer pipes where good natural foundation does not exist. What goes around and over the sewer pipe is as important as the support under it. Back filling is a vital operation. Fill should be placed and tamped equally and carefully on each side to at least 2 ft above the top of sewer.

Vent pipes: are installed to provide a flow of air to or from a drainage system (pit). It also provides circulation of air within such a system to protect traps of backpressure. The various types of materials that are used for vent pipes are:

- PVC tubing
- Masonry works
- Plane sheet metals

Size of pipes depends on:

- The size of waste
- Number of fixtures

- Number of closets connected.

Smaller diameter pipes are prohibited because it may restrict venting action. The vent size should not less than 1 ¼ inches in diameter.

Fixture: is a receptacle attached to a plumbing system other than a trap in which water or wastes can be collected or retained for use and for proper discharge into the drains.

1. Water closet (W.C.): The water closet, popularly known in its abbreviated form the W.C., is a device for depositing human wastes directly into a properly designed bowl or pan. Then the excreta are immediately carried away by water, which is flushed under pressure. These pans are designed in connection with flushing water under pressure.

2. Flushing cistern: The flushing cistern attachment is designed to release a predetermined quantity of water under pressure in order to flush away excreta from W.C. pans or urinals.

3. Lavatory: is a fixture designed for the washing of the hands and face, sometimes called a washbasin. These, like other sanitary fittings, are designed in a standard form and various makes are found on the market. They are usually

made of glazed earthenware or porcelain. At the bottom they are connected to the wastewater discharge pipe. Since the room containing the washbasin often contains a W.C., the lavatory is often called the W.C.

4. Bathtub and shower: A modern bathroom is provided with a bathtub and/or a shower for washing the body. Here again the bath is designed in a standard form and shape. A typical bath is oval-shaped, made of glazed earthenware or enameled cast iron. It is provided with a discharge hole controlled by a stopper or plug and chain, and fitted with an overflow device, in case the water is accidentally left flowing into the bath. Hot and cold water faucets or taps are fitted for filling the tub. Showers may be installed together with the bathtub or separately.

5. Bidet: A bidet is an oval-shaped sitting-pan provided in some houses and fashionable hotels by the side of the W.C. and bathtubs. The bidet is not an essential component of bathroom fittings. It is provided for the purpose of intimate washing, especially for women. It is furnished with hot and cold water, and can produce an upward spray as desired.

6. Sink: Sinks are large basins permanently installed in kitchens for washing dishes, pans, etc., and for cleaning vegetables, etc. Sinks are provided with stoppers for keeping

water in them, and with an overflow device. They are connected through traps to the wastewater discharge pipes. Another sanitary fitting commonly found in a modern house is the laundry facility, for washing clothes. It is usually a large sink, or two large sinks side by side, for washing and rinsing out soap.

Traps: A Trap is a device or fitting so designed and constructed as to provide a filter when properly vented. A liquid seal will prevent the back passage of air without materially affecting the flow of sewage or wastewater through it. Trap seal is the maximum vertical depth of liquid that a trap will retain. It should have one clean-out hole. It is used to prevent passage of sewer gas into the house system.

Valves - The various types of valves likely to be used in different rural water supply projects are briefly described below. As these particular items are relatively expensive, care is needed in their selection.

1. Gate Valves - The gate valve (or sluice valve) is used to cut off flows in pipelines by lowering a solid-type wedge "gate"; during normal operation unrestricted straight-through flow is achieved as the "gate" is raised inside the valve body (referred to as the bonnet), so that the bore of the pipe is completely clear.

2. Butterfly Valves - The butterfly valve performs a function similar to that of the gate valve; its principle of operation is the turning of the disc through 90° to permit water to pass. The claimed advantages over the gate valve are lightness, greater speed of operation, low-pressure drop and low maintenance. Minimum size is 2" (50 mm).

3. Globe valves - Globe valves are less efficient than gate valves or butterfly valves, as the flow of water through them is not "straight", and thus greater head losses are induced. They are, however, cheaper, and in sizes up to 2" (50 mm) could be suitable for rural water supply pipelines. These valves are supplied complete with hand-wheels and have either double female threaded ends or double flanged ends.

4. Check Valves - Check valves close automatically when a reversal of flow occurs, thus preventing water from flowing back, e.g., in the case of a force main (pumping main) causing damage to the pump assembly.

5. Air valves - Air valves are located at all high spots on a pipeline and permit the discharge of air, which is likely to accumulate there. Such air, unless removed, induces water hammer; it can also seriously restrict the flow of water in the pipeline.

Valves have cast iron bodies. The ball is rubber covered. Ball size is selected to suit working pressure; the higher the pressure the larger the ball. These valves release air at any pressure below maximum working pressure.

3.5 Basic Techniques in Plumbing

A. Pipe Cutting

Chipped or damaged ends of asbestos-cement pipes are likely to produce non-watertight joints. Such ends should be cut off.

For small diameter pipes, the ends may be cut with a handsaw or a hacksaw. Alternatively, ratchet type pipe cutters can be used, which are quicker and usually give a better result. A single pipe cutter is available that can cut pipes from 2" to 6". Another model is the hydraulic pipe cutter, which involves wrapping a cutting chain around the hydraulic pipe cutter and then hand-operating the hydraulic pump. This builds up sufficient pressure on the chain to "pop" the pipe with a clean cut.

Steel pipes can be cut to length with metal hacksaws, but it is more usual to employ manually-operated heavy-duty pipe cutters (commonly 3 or 4 wheel type) if the pipe diameter exceeds 1- ½" (40 mm). A half-round coarse file is used to

trim the cut ends internally and externally. Both PE and PVC plastic pipe can be cut with a metal cutting saw. Special pipe cutters are available for PVC pipes, usually capable of cutting pipes of several sizes, e.g. ¼" to 3 - ½" or 4" to 6" (8-90 mm or 100 - 150 mm).

For PVC pipes using cement solvent, it is helpful to the joint if both male and female ends are roughened with sandpaper.

When "rubber ring push fit" joints are used on spigot and socket pipes, and when the spigot end has been damaged, the new cut end may be filed down to the necessary chamfer.

B. Pipe Threading

Steel pipes are jointed by threaded couplings (sockets) or by screwed - on flanges. In either case, a cut pipe will require a new thread.

Pipe stock and die sets are available for any desired pipe thread; these sets will usually cover several pipe sizes.

Supplementary equipment includes a pipe vise (which can be tripod-mounted or bench-mounted), a pair of "Stillson" pipe wrenches or chain pipe wrenches and an oiling can or patent "cutting" compound to prolong the life of the tool, as well as to facilitate the operation.

C. Connection of pipes and fixtures

When a water supply system includes a piped distribution network, the water mains must be tapped to make a connection for such outlets as public standpipes (public fountains/public stand posts) or for “private” connections to individual houses or public buildings.

For galvanized steel pipes a tee is inserted in the pipeline, but for asbestos-cement it is more usual to drill a threaded hole through the pipe to receive the connection. For the smaller diameter PVC water mains, tees can be used.

For the smaller diameter mains, PVC tees are available for branch connections off the water main and should be used. For the larger diameters, 4” (100 mm) and over, suitably sized tees are not usually available and so PVC saddles are used, as the pipe should not be directly tapped.

Inserting a tee with a reduced branch effects a connection to a galvanized steel pipeline; this branch can be further reduced in size by one or more reducers. The thin wall of these pipes precludes tapping as for asbestos-cement or PVC mains.

For larger size connections a saddle must be used. This is bolted to the water main and drilling is done through a boss, which is frequently pre-drilled. A gasket between the pipe and

saddle is commonly used. The connection pipe may be larger and effected by means of a reducer between the connection pipe and tapping.

These days, connection pipes are normally plastic (PVC or polyethylene). The galvanized steel pipe is likely to have a short life, loses capacity due to encrustation and can lead to water losses due to rust or zinc spelter becoming embedded in washers and so preventing water-tight closure.

All outlet taps should have a stopcock on the line between the main and tap to permit repairs to the tap. If the connection is metered, the stopcock is located downstream of the meter.

For public outlets (standpipes, fountains, etc.), the tap (faucet) may be the ordinary bib type. This may prove better than the patented "Waste-Not" type of automatic shut-off tap, which relies on a spring for closure.

Review Questions

1. What is plumbing?
2. What are some of the plumbing tools and materials required for water supply and wastewater applications?
3. What are some of the preconditions required for drainage and sewerage systems in your area?

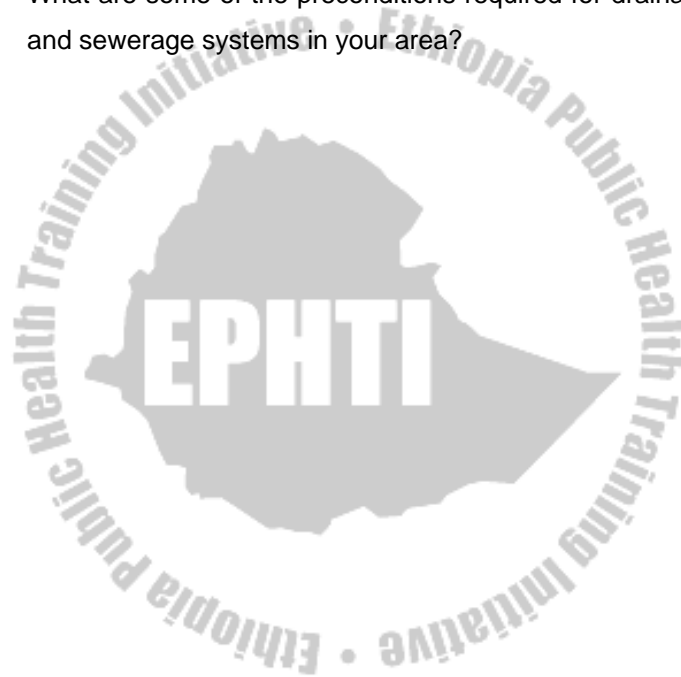

CHAPTER 4

TYPES AND PRINCIPLE OF OPERATION OF PUMPS

A Pump is a device for moving liquids or gases.

4.1. Principles of Operation of Pumps

The branch of physics which studies the laws dealing with the pumping of liquids is known as hydraulics.

There are numerous types of pumps designed and made by various manufacturers throughout the world. The selection of a specific type of pump depends upon several factors, the main ones being:

1. The type of driving force (prime mover): by hand, by internal combustion motor) engine, by electricity or win.
2. The total head or pressure against which the pump is intended to operate, and at what frequency.
3. The volume of water to be pumped, and height to which it is to be raised.
4. The practicability of the pump as regards installation, operation and maintenance in a given locality.

The principles of operation of the positive displacement type of pump may be illustrated by using a typical lift pump as an example. This type of pump is known by several other names, such as pitcher pump, spout pump, single-action displacement pump, reciprocating or alternating lift pump, etc. All of them work on the same principle, but for this discussion we shall call this type of pump a pitcher pump. (See figure 17)

The pitcher pump consists of the following main parts:

- A. A cylinder
- B. A plunger or piston connected to a handle
- C. Two valves:- The plunger-valve or piston-valve, and
- The foot –valve or check-valve
- D. A suction pipe or drop-pipe which extends down into the level of the static water.

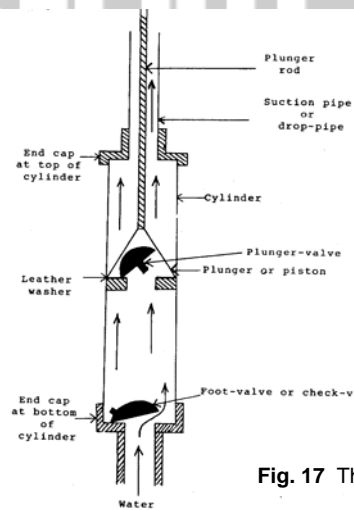

Fig. 17 The pitcher pump parts

Steps of Operation of Pumps

Step 1. The pump has to be primed with water from an outside source. The purpose of priming is to wet the plunger and the valves, particularly the washers, etc., in order to render them airtight. (see Figure 18 in which the plunger is shown in the upward position.)

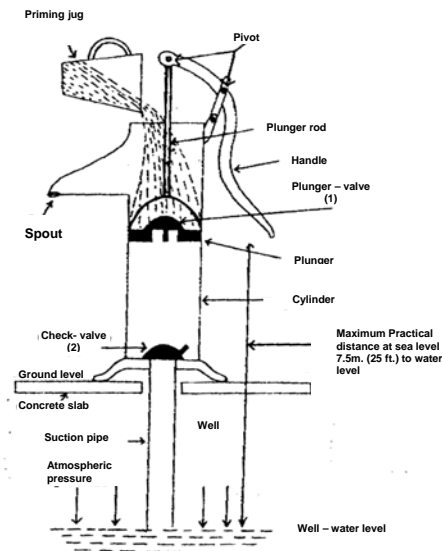

Fig. 18 Typical pitcher pump being primed

Step 2. With the pump primed, on the first upstroke and with the plunger rod moving upwards, the check-value (2) opens, because of the partial upward thrust. The plunger-valve (1) closes, because of the weight of the priming water above it (Figure 19).

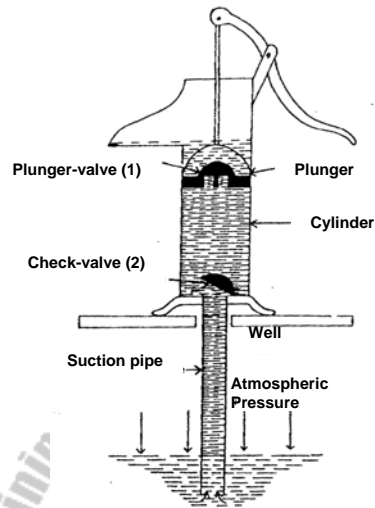

Fig. 19 The pitcher pump during upward stroke of plunger

Step 3. On the first downward stroke, the check-valve (2) closed due to the weight of compressed air opens, because of the compressed air pushing on it, and consequently the compressed air escapes through the priming water (Figure 20). Steps 2 and 3 are repeated until air is exhausted between the static water level in the suction pipe and the cylinder.

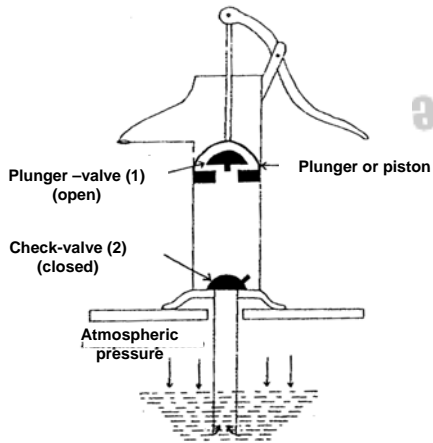

Fig 20 The Pitcher pump plunger rod at downward stroke plunger-valve (1) open check-valve (2) closed.

Step 4. On the successive upstrokes, the check-valve (2) opens, and water fills the suction pipe and the cylinder, due to the partial vacuum created by the upward-moving plunger. The plunger-valve (1) closes, due to its own weight and the weight of the water above it.

Step 5. On subsequent downward strokes, the water filling the cylinder escapes through the open plunger-valve and is discharged at the spout (Figure). Thus, at every downward stroke, water fills the cylinder, and at valve (2) closes, and the plunger-valve (1) opens. As valve (1) opens, the water, with every upstroke, is discharged at the spout.

4.2 Learning Objectives

At the end of this chapter, the student will be able to:

1. Elaborate basic principles in pump operation
2. Exercise how to assemble and dismantle hand pumps
3. Mention the types of hand operated pumps and write their differences.

4.3 Types of Pumps

1. Hand Pumps (Piston Type)

Hand pumps are installed over dug wells or tube wells. This method of supplying water is most suitable for scattered population and/or when water-bearing ground exists near the population to be served. There are two basic types of hand pumps:

The shallow well pump with the pump cylinder above ground, and the deep well pump with the pump cylinder below ground (normally below water level).

The term "shallow well" does not refer to the depth to which the well has been sunk, but rather to the water level below ground level. A well may be sunk over 100 ft. (30 m) before it strikes an aquifer, but once this level is reached the water may rise to within 10 ft. (3 m) of the ground level or even overflow; this would have a shallow well pump. A deep well pump may be located down a well only 50 ft. (15 m) deep but where the water remains at 30 ft. (10 m) below the ground level.

A. Shallow well pumps - The minimum output from a shallow well pump serving a number of families should be 6 U.S. gallons (22.7 liters)/minute and preferably 8 to 9 U.S. gallons (say 35 liters)/minute. This quantity should be delivered by 30 to 40 strokes of the pump. (See figure 21)

The discharge per stroke will depend on the cylinder's diameter and its effective length. There are obviously many variations in these dimension combinations to give the required output. Most pumps, however, have an internal diameter of approximately 3" (76.2 mm), and a 6" (152.5 mm) or 9" (228.6 mm) effective stroke length.

Cylinders are normally made of cast iron and, to avoid excessive wear on the cups, have a brass or PVC liner; the latter is cheaper and has proved satisfactory, and hence is preferred. Single cups are provided, and these were originally made of leather, but now neoprene cups are available, and either is acceptable.

Piston rods are usually polished steel or brass if the pump is purchased from manufacturers. But if it is locally produced, then ordinary mild steel rods are normally used.

The suction end is normally tapped for a 1¼" (32 mm) connection; the small difference in head loss between 1¼" and 1½" (nominal 32 and 40 mm) pipes does not justify the larger size, unless suction lift distance is critical.

The pitcher type spout is not recommended for public standpipes, as it is liable to greater contamination than the closed spout.

A stuffing box for the piston rod will also prevent ingress of dust and dirt, but the additional cost and machine-shop work involved will normally mean that this refinement is not possible on locally made pumps.

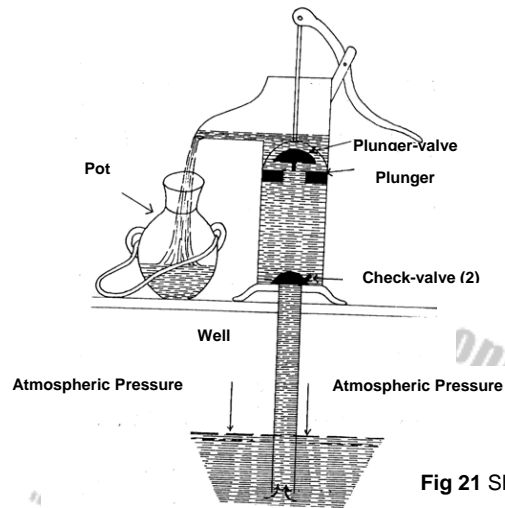

Fig 21 Shallow well pumps

B. Deep Well Pumps - Deep well pumps have the cylinder down the well. For large diameter wells the pump cylinder may have a relatively large internal diameter, but for tube wells it is small and can be as small as 8/15" (41.3 mm). However, the small sized cylinders have proved troublesome to operate and maintain.

There are two basic types: the closed type and the open type. The former is tapped to receive the riser pipe (suction lift) pipe, while the latter can be screwed directly to the well lining (casing) so that this becomes the riser pipe.

The advantage of the open type is that the plunger can be withdrawn to replace worn cups without taking out the cylinder; to replace cups on the closed type, the riser pipe and cylinder must be withdrawn.

The cylinders may be made of brass or cast iron with a brass or PVC liner. More recently, cylinders of PVC have become available, and their freedom from corrosion, their lightness and low cost, plus a claimed 25% greater effectiveness, makes them attractive for use in rural water supply projects.

Single cups are sometimes used but double cups are more common. For the deeper wells, or the larger diameter cylinders, three or four cups may be provided - obviously the greater the number of cups, the less the effective length of the cylinder.

Operation of these pumps is normally by a handle such as is used on shallow wells, but when the water level is low, a two-handed model is available for two-man operation. Also available are wheel-type handles and these again can be two-man operated. (see figure 22)

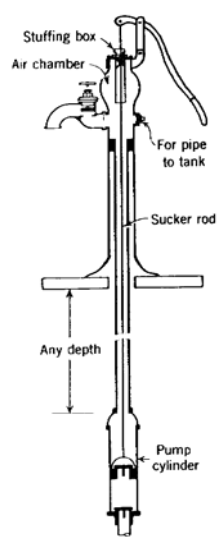

Fig 22 Deep well Pumps

2. Semi-Rotary Hand Pumps - The semi-rotary hand pump is not considered sufficiently robust for public standpipe usage, but is suitable for installation in schools, village health centers, officers' quarters, and similar locations. A major feature of this pump is that it can pump to elevated tanks to provide a gravity supply to a number of outlets at the same time.

These pumps have double-flanged inlets and outlets of the same diameter, normally with female threads for coupling direct to galvanized steel pipe. A foot-valve and strainer should be fixed to the suction end of the pipe to improve performance; without the foot-valve, suction is limited to about 10 ft. (3 m), but with the valve this can be increased to 20 ft. (6 m). The pump may be double acting or quadruple acting; the former is more common. The short stroke enables at least 100 double strokes/min to be made for the $\frac{3}{4}$ " (20 mm) inlet/outlet size, and about 60 double strokes for the 2" (50 mm) size.

3. Submersible Pumps - Submersible pumps are suitable for wells where the depth to water exceeds the capability of centrifugal pumps, and where the required discharge exceeds the capability of jet (ejector) pumps. These pumps have electric motors direct-coupled to the pump, which is usually a centrifugal type though some manufacturers have units which incorporate the helical rotor. Both pump and motor are

installed down the well below water level. No power is thus lost in driving a long shaft as in the case of the deep well turbine pump. Their range of performance is considerable: it can be as low as 10 US gal/min (say 38 liters) or over 1000 US gal/min (say 3800 liters); pumping heads can exceed 1000 ft. (300 m). The greater the head, the greater the number of stages in the pump; pumps of up to 35 stages are produced. These pumps can be installed in wells as small as 4" (100 mm) internal diameter. It is more usual to pump to an elevated storage tank, though these pumps can be connected to ground level pressure tanks (as described under "Jet Pumps"), or directly to the distribution system.

The electric motors may be as small as 1/3 HP; small HP electric motors are single phase, while the larger units are 3 phase. These motors are hermetically sealed. The smaller units (up to about 3 HP) are usually of the capacitor type; this motor is normally the oil filled type and lubricated for life.

Water containing sand is harmful to submersible pumps as this causes excessive wear and could cause binding. The safe upper limit of sand content in the water is generally taken as 25 grams per cubic meter of water.

4. Deep Well Turbine and Rotor Pump - A deep well turbine pump is usually selected when the suction lift is greater than

that at which a jet (ejector) pump can operate, and/or when the quantities of water required are beyond the capacity of the jet pump. Deep well turbine pumps can lift water 1,000 ft. (305 m) and can deliver up to 30,000 US gal/min (113 m³/min).

For rural water supply projects, deep well turbine pumps are available that can go into a 4" (102 mm) well; such pumps can either pump from "medium depth" deep wells, say down to 300 ft (30 m), delivering up to 100 US gal/min (378 liters/min), or from very deep wells of 1000 ft (305 m) with a smaller discharge of approximately 55 US gal/min (206 liters/min).

If electrical power is used, the motor is commonly vertically mounted over the well, directly coupled to the drive shaft, or vertically mounted offset from the well and used with a belt drive.

The right-angle gear drive, which is located directly over the well, may have standard speed increasing ratios of which the following are typical: 1:2; 2:3; 3:4; and 4:7. It can also have a speed-decreasing ration of 11:10. The vertical turbine pump consists of three major elements: the head and drives assembly, the column and shaft assembly, and the pump bowl assembly.

There are two basic models, one using oil lubrication and the other water lubrication. Oil lubrication involves the use of an

oil-enclosing tube around the line (drive shaft). This tube is not required if water lubrication is used, as here the pumped water lubricates the shaft bearings.

If the water being pumped is likely to be aggressive. (i.e., to attack the steel shaft) then oil lubrication is preferred. Otherwise, water lubrication is recommended, as this eliminates any possibility of oil getting into the water. It may be advisable to forward a chemical and physical water analysis to the manufacturer for his recommendation.

The "column" is the pipe up which the water is pumped; it is normally "standard pipe", threaded with faced ends and with a reduced taper so that when column ends butt against each other, the threads are tight. Column pipe is normally supplied in 10 ft (3 m) lengths, but the first length joined to the pump is usually 5 ft (1.5 m) long to facilitate lowering it down the well. Some suppliers provide all column pipes in 5 ft (1.5 m) lengths.

5. Double-Acting Piston Pumps - A double-acting piston pump is ideal for small to medium sized rural water supply projects where the water source is from a shallow well or impounding reservoir, etc., and water has to be pumped to a higher elevation some distance away. Its advantages over the centrifugal pump include greater efficiency, longer life due to

its slower speed, and its simplicity in operation, maintenance and repair.

The prime mover used is most commonly a petrol engine, though diesel engines can be used. If a reliable electricity supply is available, then an electric motor would be preferred. The pump set is located at ground level and has a maximum suction lift of about 25 ft (7.5 m) at sea level; delivery head can be at least 800 ft (244 m). The intake of the suction pipe should always be located well down below the water level and fitted with a foot valve and strainer.

The suction pipe should be as short as possible (i.e. the pump should be located close to the intake point). If the distance between source of supply and the pump is 100 ft (30 m) or more, the pump will require a suction air vessel (air chamber), which should be fixed as close to the pump as possible. Further, the suction pipe bore, in such a situation, should be at least one size larger than the pump inlet bore. An air vessel (air chamber) is always incorporated on the discharge side of the pump to smooth out the flow and to quiet the pump operation. The air vessel capacity should be at least twice the piston displacement.

It is recommended that, if an oil engine is used as the prime mover, then a low-starting torque device should be used. This

can be a tee piece and valve fitted on the delivery (discharge) pipe near to the pump. The valve is hand-opened prior to starting and closed when the engine has run a few seconds. If a stop valve (gate valve) is fitted to the delivery pipe, a spring relief (safety) valve is necessary between the valve and the pump. (see figure 23)

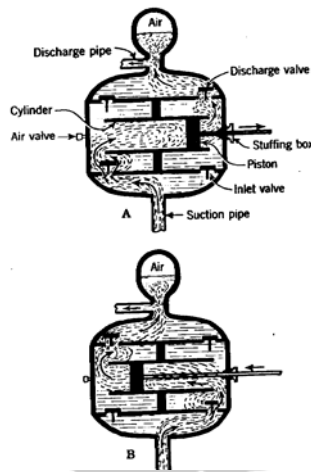

Fig. 23 Double acting pumps

6. Centrifugal Pumps - Centrifugal pumps, as their name implies, use centrifugal force to lift liquids from a lower to a higher level. They are also referred to as “velocity pumps”. Maximum suction lift (at sea level) is 25 ft (7.5 m) but delivery heads may exceed 1000 ft (300 m). Pumping capacity range extensive and may be as low as 3000 US gal/hr (1134 liters) to more than 7,000 US gal/hr (26,460 liters).

The prime mover is usually an electric motor, and this is either close coupled or flexible-coupled to the pump shaft; either arrangement is satisfactory. If no reliable electricity supply is available, oil engines can be used (gasoline or diesel). These engines may be flexible-couple to the pump, or a belt drive (flat or Vee-belt) may be used, though this is less efficient. Electric motors are preferred.

The pumps may be either single-stage or multi-stage (one or more sets of impellers). The latter is used for high delivery heads. There is no set limit of delivery head related to the number of stages; each manufacture has his own design(s). Single-stage pumps will normally not have a delivery head in excess of 400 ft (120 m) and frequently less.

The preferred and most common arrangement is for these pumps to have end suction inlets, where the water comes directly into the eye of the impeller. Double suction impellers are used only for pumps of large capacity, which normally exceed the demands of a rural water supply project.

Centrifugal pumps are normally of the split-case design, with the casing split along its horizontal centre line. This permits the removal of the top half of the casing for easy internal inspection and removal of the rotor as a complete unit, without disturbing the pipe connections. (see figure 24)

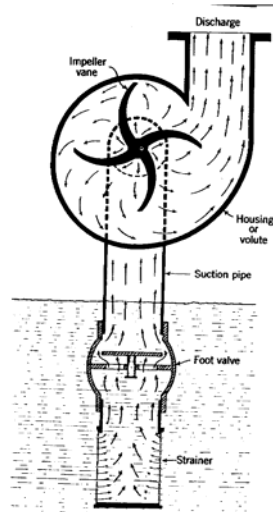

Fig 24 Centrifugal force pump in cross section.

7. Jet (or Ejector) Pumps - A jet pump is usually selected when the suction lift is greater than that at which a centrifugal pump can operate, and when the volume of water required is relatively small, and hence may not justify the more expensive deep well turbine pump.

The advantages include the fact that all moving parts are located above ground, thus facilitating maintenance. It is also suitable for small wells, which could not accommodate other types of pumps; they can be used in 2" diameter (50 mm) holes. Its disadvantage is low efficiency with an appreciable reduction in capacity output as depth down to water level increases.

Jet pumps can be used in shallow wells, medium depth wells or deep wells. The maximum depth down to water level for which jet pumps are used is normally 100 to 120 feet (30.5 to 36.5 m); at this depth, discharge will be about 200 US Gal/hr. (say 760 liters).

For shallow wells, down to 25 ft (7.6 m) depth to water level, the ejection unit is usually incorporated in the pump and can be removed, if so desired, so that the pump functions as a normal centrifugal pump. For medium depth wells, the ejector unit must be located down the well so that there are at least 5 ft (1.5 m) of submergence when the pump is in operation. For deep wells, the submergence should not be less than 6 ft (1.8 m).

The discharge from the pump may be direct to an elevated tank, in which case the pump will run continuously until the tank is filled. Alternatively, it can discharge to a pressure tank, and pressure control switches will cut-off and cut-in the pump as the water is used.

8. Windmill Pumps - A windmill pump, when conditions are suitable, provides a means of raising water from a well to an elevated tank without operational costs and with minimal maintenance costs. Through its ability to pump for 24 hours a day, water can be stored so that it can, at peak draw-off

periods, supply several public standpipes at the same time and at higher rates of discharge than a single hand pump drawing water from the same source. To put this another way, a single well and windmill can replace two or more wells with hand pumps, and obviate the necessity of hand pumping by providing a piped supply. The cost of the supporting tower and windmill assembly is thus offset, in some small part, by the savings in drilling costs, well linings, screens and pumps, and the elimination of hand pumping saves the villagers time and labor for other activities. (See figure 25)

Prerequisites for a Windmill Pump Installation

To be successful, certain conditions must prevail, and these include:

1. A wind of not less than 5 miles/hour (8 km/hr) for at least 60% of the time;
2. A well that is capable of continuous pumping without excessive drawdown;
3. Adequate storage provided which is equivalent to not less than 3 days' pumping capacity;
4. A clear sweep of wind that can reach the windmill, (i.e., it must be located above surrounding obstructions, such as buildings or trees within a radius of 400 ft (120 m)).

A windmill pump water system comprises a well (this could be a tube well or hand dug well), a suction pipe with screen

intake, a reciprocating pump with the piston rod of the pump connected to the pump rod from the windmill, a geared mill head or motor to convert the circular motion of the mill into a reciprocating vertical movement, the vane mill itself, mounted on a tower, and finally the necessary pipe work and elevated storage tank. It is common practice to provide the pump with a shut-off valve, a handle and a spout, so that if there is no wind the water may be pumped by hand for ground level discharge.

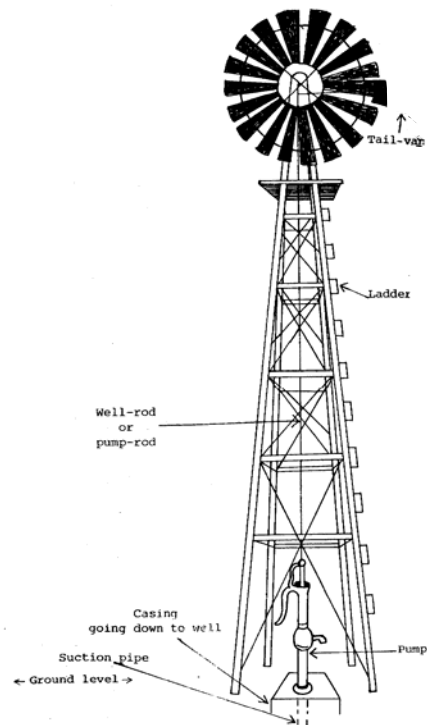

Fig 25 Windmill tower and pump

4.4 Procedure of Installation of Hand Pumps

1. Connect the jacket of the pump to the bracket with bolt and nut.
2. Connect the handle to the bracket.
3. Connect the eye of the plunger rod to the bracket.
4. Connect the rods as much as the depth of the well to the handle.
5. Connect the drop pipe as much as the depth of the well to the jacket of the pump.
6. Connect the cylinder to the drop pipe.
7. Keep the handle up stroke, cut the rod 2-3cm distance from the tower valve.
8. Thread the plunger rod with a threading tool to the size of the rod.
9. Fix the plunger to the plunger rod.
10. Connect lower cap of the cylinder to the cylinder.
11. Connect a strainer to the lower cup of the cylinder.

4.5 Tools Needed to Install Hand Pumps

- Adjustable wrench (at least two).
- Adjustable spanner (at least two).
- Chain wrench - to support the pump
- Pipe threading tool
- Rod threading tool
- Pipe vise

- Oil for lubrication
- Blow torch
- Hack saw
- Pipe cutter, etc.

Review Questions

1. What kind of pump do you recommend for the rural and urban dwellers in your area?
2. Explain some of the important parts in a hand pump.
3. Describe the procedures required in installing hand pumps.
4. Describe some of the basic techniques required for installing a hand pump in a village.

Glossary

1. **Bracket:** a part of a pump that attaches the handle with the jacket of the pump.
2. **Centrifugal pumps:** pumps that are driven by power sources.
3. **Cylinder:** a brass made pipe having valves designed for sucking water.
4. **Down-stroke:** the process of moving the handle of the pump up, thereby to move down the plunger rod.
5. **Up-stroke:** the process of moving the handle of the pump down thereby to move up the plunger rod.
6. **Fitting:** a device used to connect or bend or reduce/enlarge or close pipes that are serving for different purposes.
7. **Fixture:** a receptacle attached to a plumbing system other than a trap in which water or wastes can be collected or retained for use and for proper discharge into the drainages
8. **Drainage:** a system of pipes or ditches used for draining waste water.
9. **Hand pump:** a pump operated manually.
10. **Jacket of the pump:** the body of the pump usually marked by different colors.
11. **Pipe:** a conduit that carries water, gases or wastewater.

12. **Plunger/piston:** a device attached to a rod which sucks water inside the cylinder.
13. **Priming:** addition of water from an outside source to wet the plunger and valves, particularly the washer.
14. **Pump:** device for moving liquids or gases.
15. **Threading:** the process of making a raised line that winds round the outside of a screw or the inside of nut, etc.
16. **Valve:** a controlling center that lets and holds water inside the cylinder.
17. **Construction:** the process or method of building or making things, especially roads, buildings, bridges and other sanitary facilities.
18. **Sanitary-construction:** The process or method of building or making things to keep places clean and healthy to live, especially by removing human and other liquid wastes.

References

1. J. Douglas Wilson (1957): Practical House Carpentry Simplified Method for Building.
2. Harold E. Babbitt (1960): Plumbing
3. G. Wagner (1959): Water Supply for Rural Areas and Small Communities, WHO.
4. Daniel A. Okun (1975): Community Wastewater Collection and Disposal, WHO.
5. WHO (1975): Rural Water Supply and Sanitation in Developing Countries.
6. Ethiopia Building Construction and Architectural and Engineering Department (1985). Manual on Construction Standards, Addis Ababa.
7. Will H. Wagner: Modern Woodworking Tools, Materials and Procedures.
8. Skill Development Center (1997): Textbook of Wood Work, Ministry of Education, Addis Ababa.
9. J. Balfour Kirk, C.M.G (1949): A Manual of Practical Tropical Sanitation.
10. Fair and Geyer (1965): Water Supply and Waste Water Disposal, Wiley and Sons.
11. Forrest B. Wright (1965): Rural Water Supply and Sanitation, Wiley, second edition.
12. Ehlers and Steel (1958): Municipal and Rural Sanitation.
13. Gebre-Emanuel Teka (1982): Water Supply – Ethiopia, An Introduction to Environmental Health Practice.
14. Mengesha Admassu (1996): Water Supply for Sanitarians. Environmental Health Department, Gondar College of Medical Sciences, Ministry of Education, Ethiopia.