

Chapter 1

Introduction to Spectroscopy

Ephrem Tilahun (MSc., Ass.Prof)

Jimma University

- **Spectroscopy** is the study of the interaction between radiation (electromagnetic radiation or light, as well as particle radiation) and matter.
- **Spectrometry** is the measurement of these interactions
 - instrument which performs such measurement
 - spectrometer or
 - spectrograph.
- A plot of the interaction is referred to as a
 - spectrum

Classification of spectroscopic methods

- **Nature of radiation measured**
- The type of spectroscopy depends on the physical quantity measured.
- Normally, the quantity that is measured is an amount or intensity of something.
- Electromagnetic spectroscopy involves interactions with electromagnetic radiation, or light.
 - Ultraviolet-visible spectroscopy is an example.
- Electronic spectroscopy involves interactions with electron beams.
 - Auger spectroscopy involves inducing the Auger effect with an electron beam.
- Mechanical spectroscopy involves interactions with macroscopic vibrations, such as phonons.
 - An example is acoustic spectroscopy, involving sound waves.
- Mass spectroscopy involves the interaction of charged species with magnetic and/or electric fields, giving rise to a mass spectrum.

- **Measurement process**
- Most spectroscopic methods are differentiated as either [atomic](#) or [molecular](#) based on whether or not they apply to atoms or molecules.
- Along with that distinction, they can be classified on the nature of their interaction:
- [Absorption spectroscopy](#) uses the range of the electromagnetic spectra in which a substance absorbs.
 - [atomic absorption spectroscopy](#) and
 - various molecular techniques, such as [infrared spectroscopy](#) in that region a
 - [nuclear magnetic resonance \(NMR\) spectroscopy](#) in the [radio](#) region.
- [Emission spectroscopy](#) uses the range of electromagnetic spectra in which a substance radiates (emits).
 - [luminescence](#).
 - Molecular luminescence techniques include [spectrofluorimetry](#).
- [Scattering spectroscopy](#) measures the amount of light that a substance scatters at certain wavelengths, incident angles, and polarization angles.
 - The scattering process is much faster than the absorption/emission process.
 - [Raman spectroscopy](#)

Electromagnetic radiation

- EMR, or light, is a form of energy whose behaviour is described by the properties of both **waves** and **particles**.
- The optical properties of electromagnetic radiation, such as diffraction, are explained best by describing light as a **wave**.
- Many of the interactions between electromagnetic radiation and matter, such as **absorption** and **emission**,
 - however, are better described by treating light as **a particle, or photon**.
- the dual models of wave and particle behaviour provide a useful description for electromagnetic radiation

- **Wave Properties of Electromagnetic Radiation**
- Electromagnetic radiation consists of oscillating **electric and magnetic** fields that propagate through space along a linear path and with a constant velocity
- In a vacuum, electromagnetic radiation travels at the speed of light, c , which is 2.99792×10^8 m/s.
- Electromagnetic radiation moves through a medium other than a vacuum with a velocity, v , less than that of the speed of light in a vacuum.
- Oscillations in the electric and magnetic fields are perpendicular to each other, and to the direction of the wave's propagation.

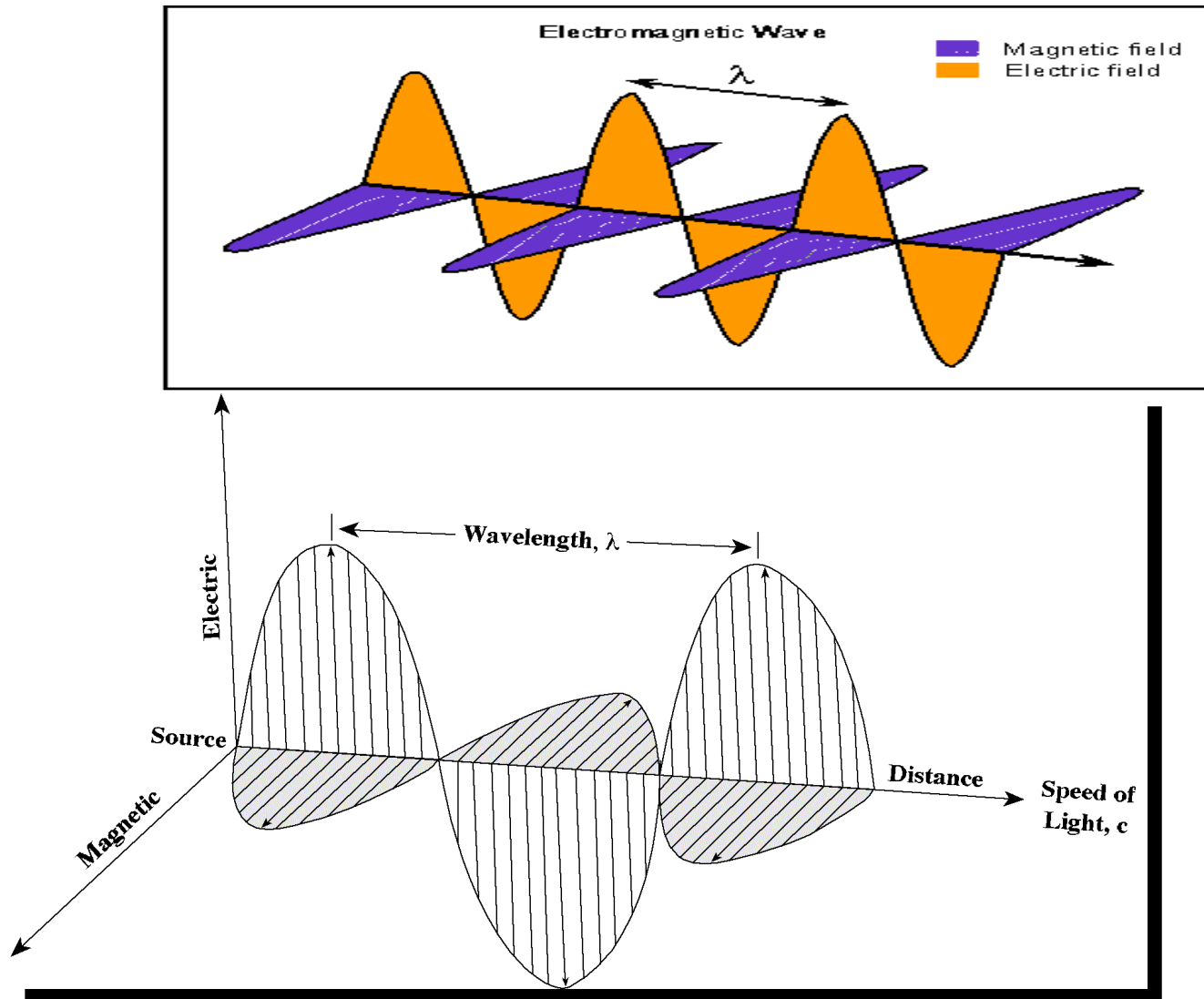
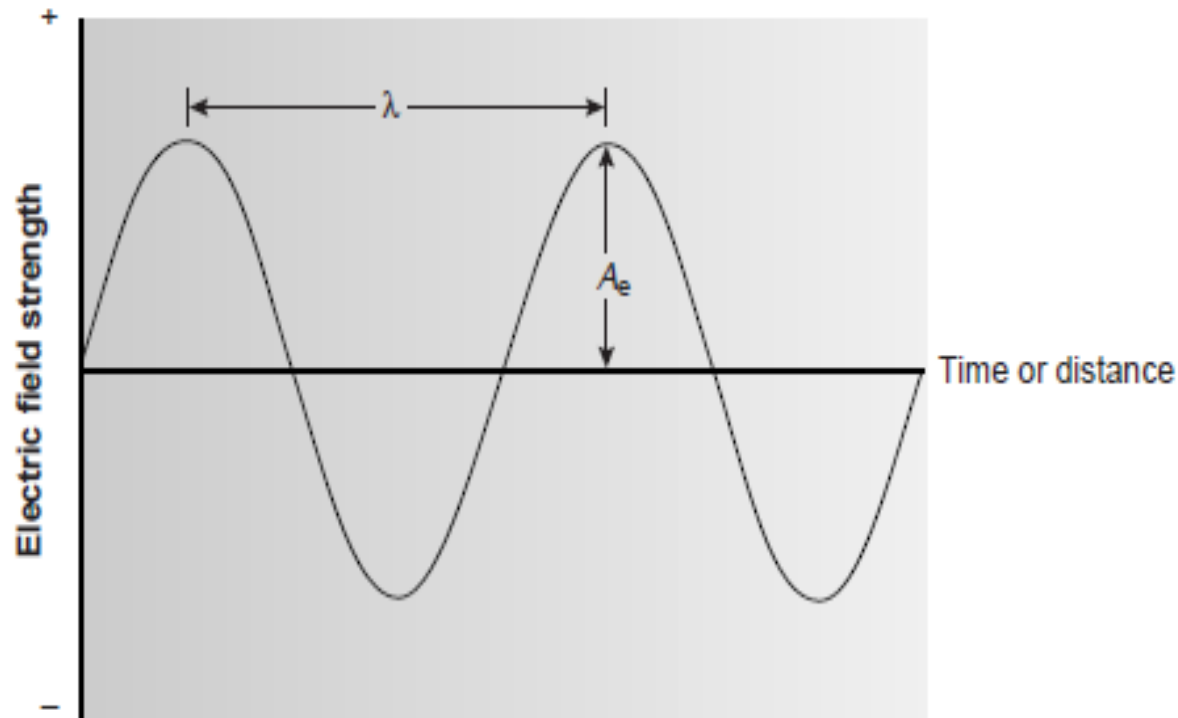

Figure shows an example of plane-polarized electromagnetic radiation consisting of an oscillating electric field and an oscillating magnetic field, each of which is constrained to a single plane.

- The interaction of electromagnetic radiation with matter can be explained using either the electric field or the magnetic field.
- For this reason, only the electric field component is shown in Figure



- The oscillating electric field is described by a sine wave of the form

$$E = A_e \sin(2\pi\nu t + \Phi)$$

- where E is the magnitude of the electric field at time t , A_e is the electric field's maximum amplitude,
 - ν is the **frequency**, or the number of oscillations in the electric field per unit time, and
 - Φ is a phase angle accounting for the fact that the electric field's magnitude need not be zero at $t = 0$.
- An identical equation can be written for the magnetic field, M

$$M = A_m \sin(2\pi\nu t + \Phi)$$

- where A_m is the magnetic field's maximum amplitude.
- only' the **electrical vector** is employed because it is the electrical force that is responsible for such phenomena as **transmission, reflection, refraction, and absorption of radiation.**
 - Magnetic responsible for the absorption of radio-frequency waves in NMR

Wave Parameters

- The time required for the passage of successive maxima through a fixed point in space is called the *period* (p) of the radiation.
- The *frequency* (ν) is the number of oscillations of the field that occurs per second and is equal to $1/p$.
- Another parameter of interest is the *wavelength* λ , which is the linear distance between *any two equivalent point on* successive maxima or minima of a wave.
- Multiplication of the frequency in reciprocal seconds by the wavelength in metres gives the velocity of propagation

$$V = \nu \lambda$$

- It is important to realize that *the frequency is determined by the source and remains invariant* regardless of the media traversed by the radiation.
- In contrast, the *velocity* of propagation v , the rate at which the wave front moves through a medium, is *dependent* upon both the medium and the frequency;
- In a vacuum the velocity of radiation becomes independent of frequency and is at its maximum.
- This velocity, given the symbol c , has been accurately determined to be $2.99792 \times 10^{10} \text{ cm/s}$. Thus, for a vacuum,
 - $c = v\lambda = 3 \times 10^{10} \text{ cm/s}$

- In any other medium, the rate of propagation is less because of interactions between the electromagnetic field of the radiation and the bound electrons in the atoms or molecules making up the medium.
- Since the radiant frequency is invariant and fixed by the source, the *wavelength must decrease* as it passes from a vacuum to a medium containing matter.

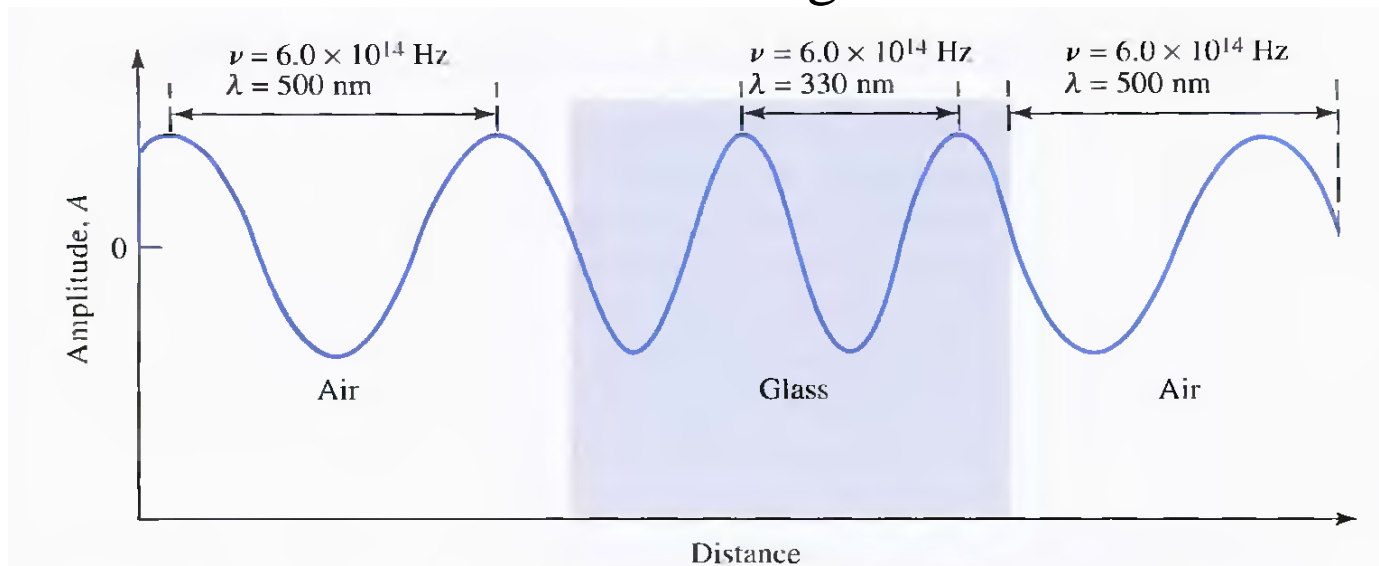

wave number, $\bar{\nu}$ which is the reciprocal of wavelength

$$\bar{\nu} = \frac{1}{\lambda}$$

- **Particle Properties of Electromagnetic Radiation**
- An understanding of certain interactions between radiation and matter requires that the radiation be treated as packets of energy called *photons* or *quanta*.
 - The energy of a photon depends upon the frequency of the radiation, and is given by

$$E = h\nu = \frac{hc}{\lambda}$$

where h is Planck's constant, which has a value of $6.626 \times 10^{-34} \text{ J} \cdot \text{s}$.

Photon : A particle of EMR having zero mass and an energy of $h\nu$.

Example 1:- The “D” line in the solar spectrum was due to the absorption of solar radiation by sodium atoms. The wavelength of the sodium D line is 589 nm. What are the frequency and the wave number for this line?

SOLUTION

The frequency and wave number of the sodium D line are

$$\nu = \frac{c}{\lambda} = \frac{3.00 \times 10^8 \text{ m/s}}{589 \times 10^{-9} \text{ m}} = 5.09 \times 10^{14} \text{ s}^{-1}$$

$$\bar{\nu} = \frac{1}{\lambda} = \frac{1}{589 \times 10^{-9} \text{ m}} \times \frac{1 \text{ m}}{100 \text{ cm}} = 1.70 \times 10^4 \text{ cm}^{-1}$$

Example 2:- What is the energy per photon of the sodium D line ($\lambda = 589 \text{ nm}$)?

SOLUTION

The energy of the sodium D line is

$$E = \frac{hc}{\lambda} = \frac{(6.626 \times 10^{-34} \text{ J} \cdot \text{s}) (3.00 \times 10^8 \text{ m/s})}{589 \times 10^{-9} \text{ m}} = 3.37 \times 10^{-19} \text{ J}$$

Electromagnetic (EM) spectrum

- The [electromagnetic \(EM\) spectrum](#) is just a name that scientists give a bunch of types of [radiation](#) when they want to talk about them as a group.
- Radiation is energy that travels and spreads out as it goes
 - [visible light](#) that comes from a lamp in your house or
 - [radio waves](#) that come from a radio station
- Other examples of EM radiation are [microwaves](#), [infrared](#) and [ultraviolet](#) light, [X-rays](#) and [gamma-rays](#).

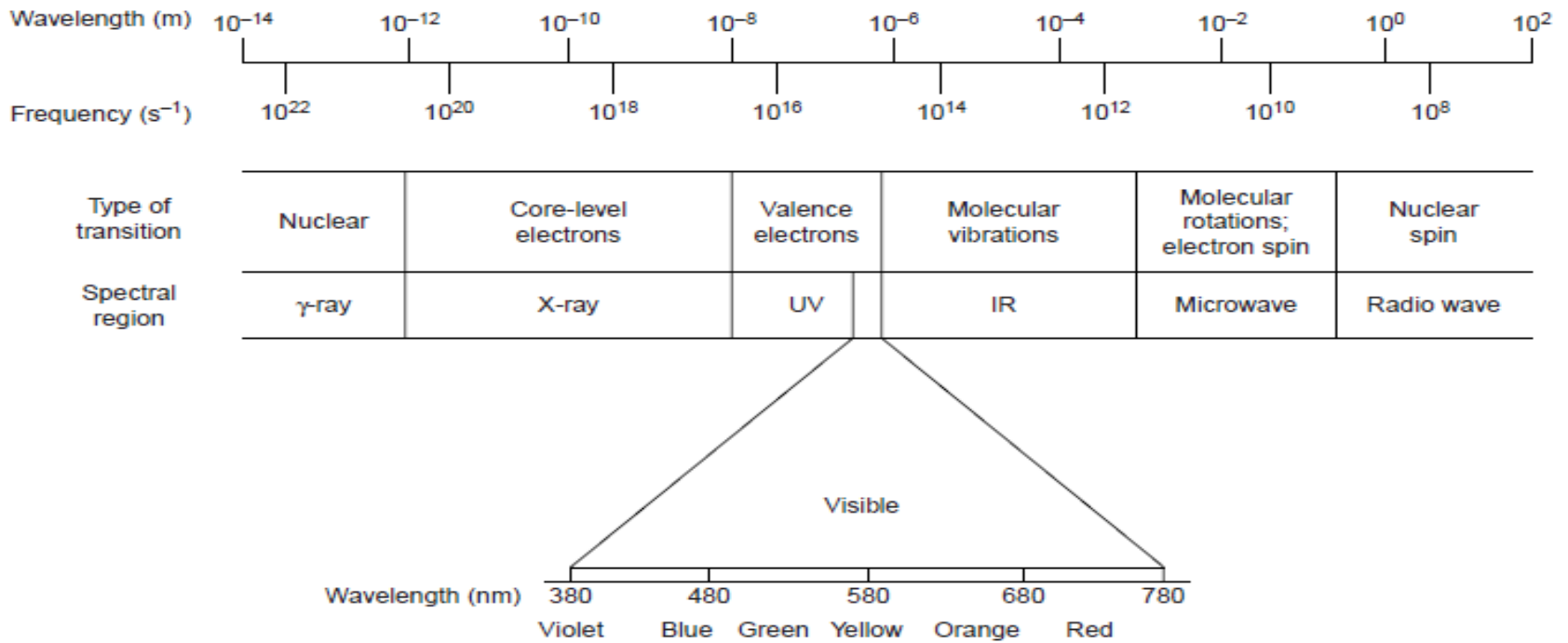

THE ELECTROMAGNETIC SPECTRUM

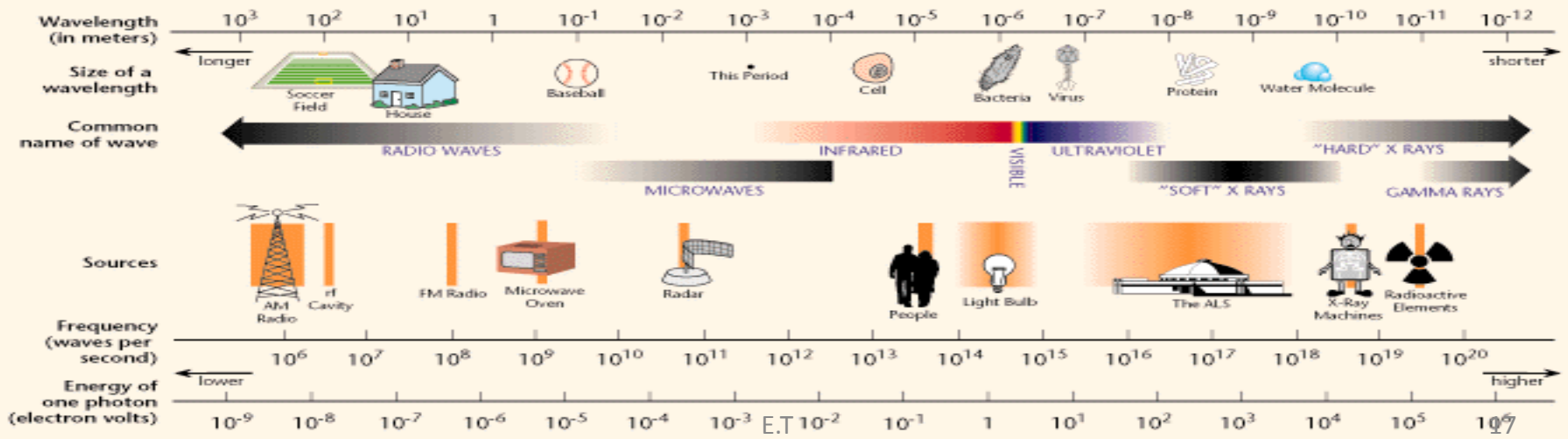

- **I. Absorption of Radiation**

- When radiation passes through a transparent medium contain chemical species, certain frequencies may be selectively attenuate by the process of *absorption*.
- EMR energy is transferred to the atoms or molecules constituting the sample; as a result, these particles are promoted from a lower energy state to higher-energy states, or *excited states*.
- At room temperature, most substances are in their lowest energy or *ground state*.
- Absorption then ordinarily involves a transition from the ground state to higher-energy states.
- Atoms, molecules, or ions have only at limited number of discrete, quantized energy levels;

- for absorption of radiation to occur, the energy of the exciting photon must exactly match the energy difference between the ground state and one of the excited states of the absorbing species.
- consider the three processes that may occur when a two-state system is subjected to radiation of frequency or wave number , corresponding to the energy separation ΔE where

$$\Delta E = E_n - E_m = h\nu = hc\tilde{\nu}$$

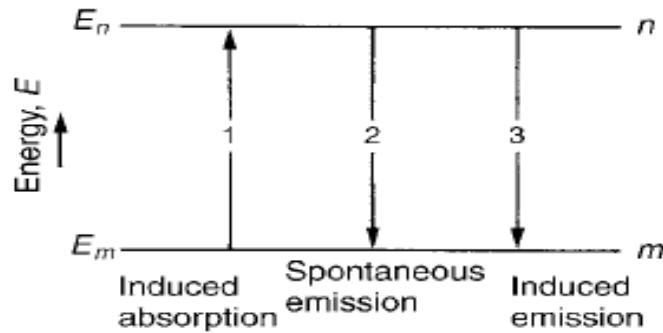

1. Induced absorption, in which the molecular (or atom) M absorbs a quantum of radiation and is excited from m to n :



Eg. the appearance of an aqueous solution of copper sulphate as blue due to the absorption of the complementary colour, red, by the solution.

2. Spontaneous emission, in which M^* (in state n) spontaneously emits a quantum of radiation:



Eg. a sodium vapour or tungsten filament lamp, is of the spontaneous type.

3. Induced, or stimulated, emission.

This is a different type of emission process from that of type 2 in that a quantum of radiation of wave number is required to induce, or stimulate, M^* to go from n to m .

The process is represented by



Since the energy d/n are unique for each species, a study of the frequencies of absorbed radiation provides a means of characterizing the constituents of a sample of matter.

For this purpose, a plot of absorbance as a function of wavelength or frequency is experimentally derived *absorption spectra*

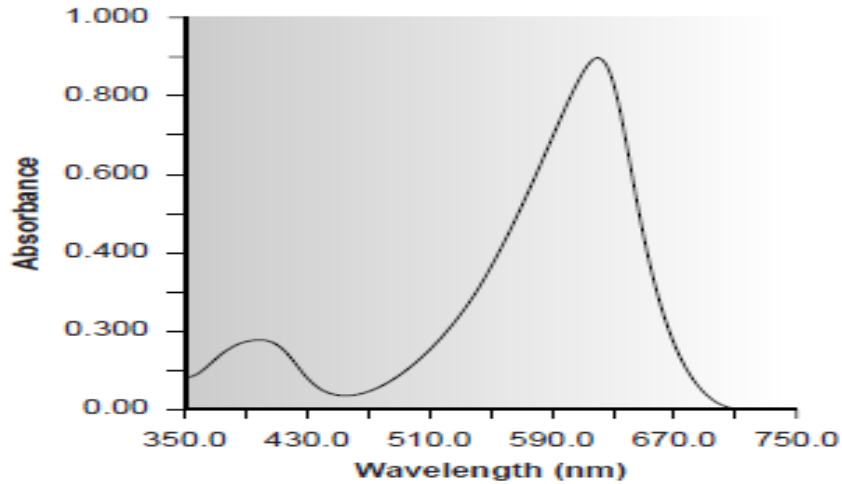

The general appearance of an absorption spectrum will depend upon

- ✓ the complexity,
- ✓ the physical state, and
- ✓ the environment of the absorbing species.

It is convenient to recognize two types of spectra, namely, those associated with

- ✓ atomic absorption and
- ✓ those resulting from molecular absorption.

- **A. Atomic Absorption**
- When a beam of polychromatic Uv or Vis radiation passes through a medium containing gaseous atoms, only a few frequencies are attenuated by absorption, and
- The spectrum consists of a number of very narrow **absorption lines**

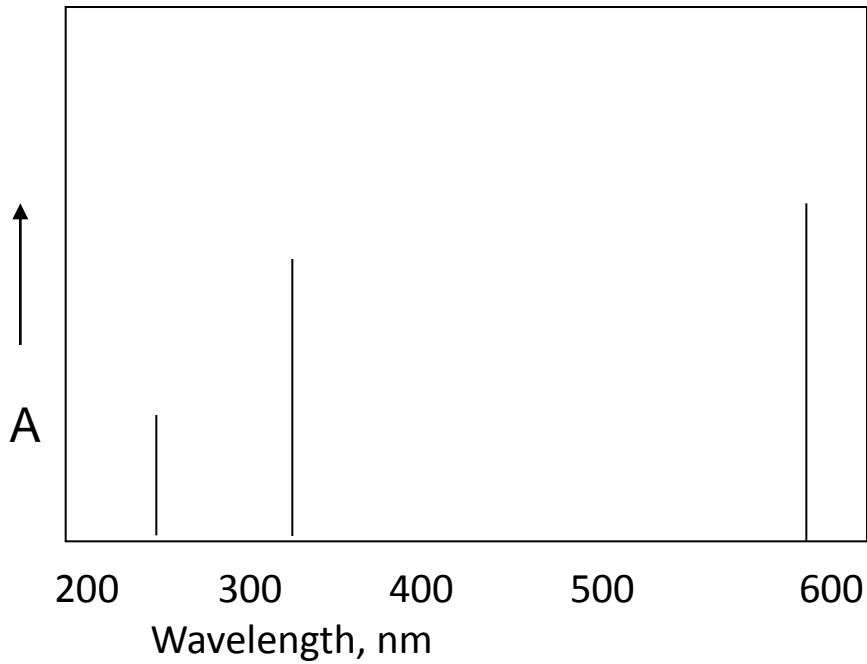

(a) Absorption spectrum for Na vapour

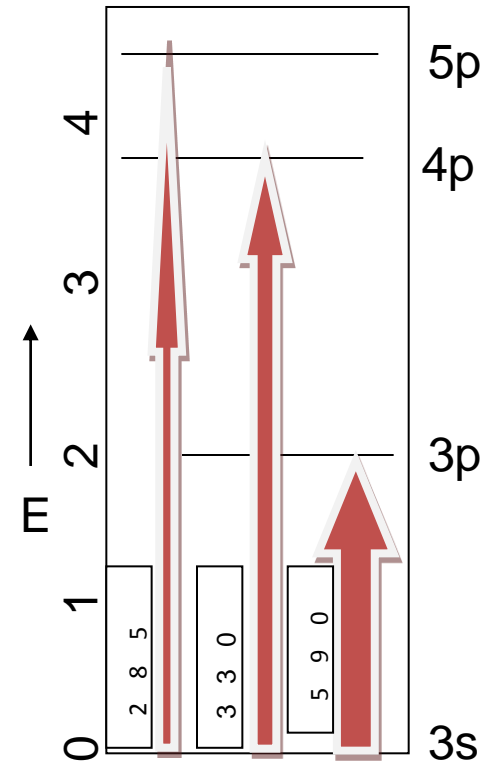

(b) partial energy level diagram for Na
Transitions involves excitation of the single outer electron of Na

- **B. Molecular Absorption**

- Molecules undergo three type of quantized transitions when excited by UV, visible and IR radiation.
- For UV and VIS radiation excitation involves promoting an electron from ground state (low energy molecular or atomic orbital)to excited state (a higher – energy orbital).
- The energy $h\nu$ of the photon must be exactly the same as the energy d/n b/n the two orbital energies.
- The transition known as Electronic transition
 - electronic absorption
- Molecules also exhibit two other types of radiation- induced transitions
 - Vibrational
 - Rotational
-

- For each electronic energy state of the molecule, there normally exist several possible vibrational states, and for each of these, in turn, numerous rotational states,

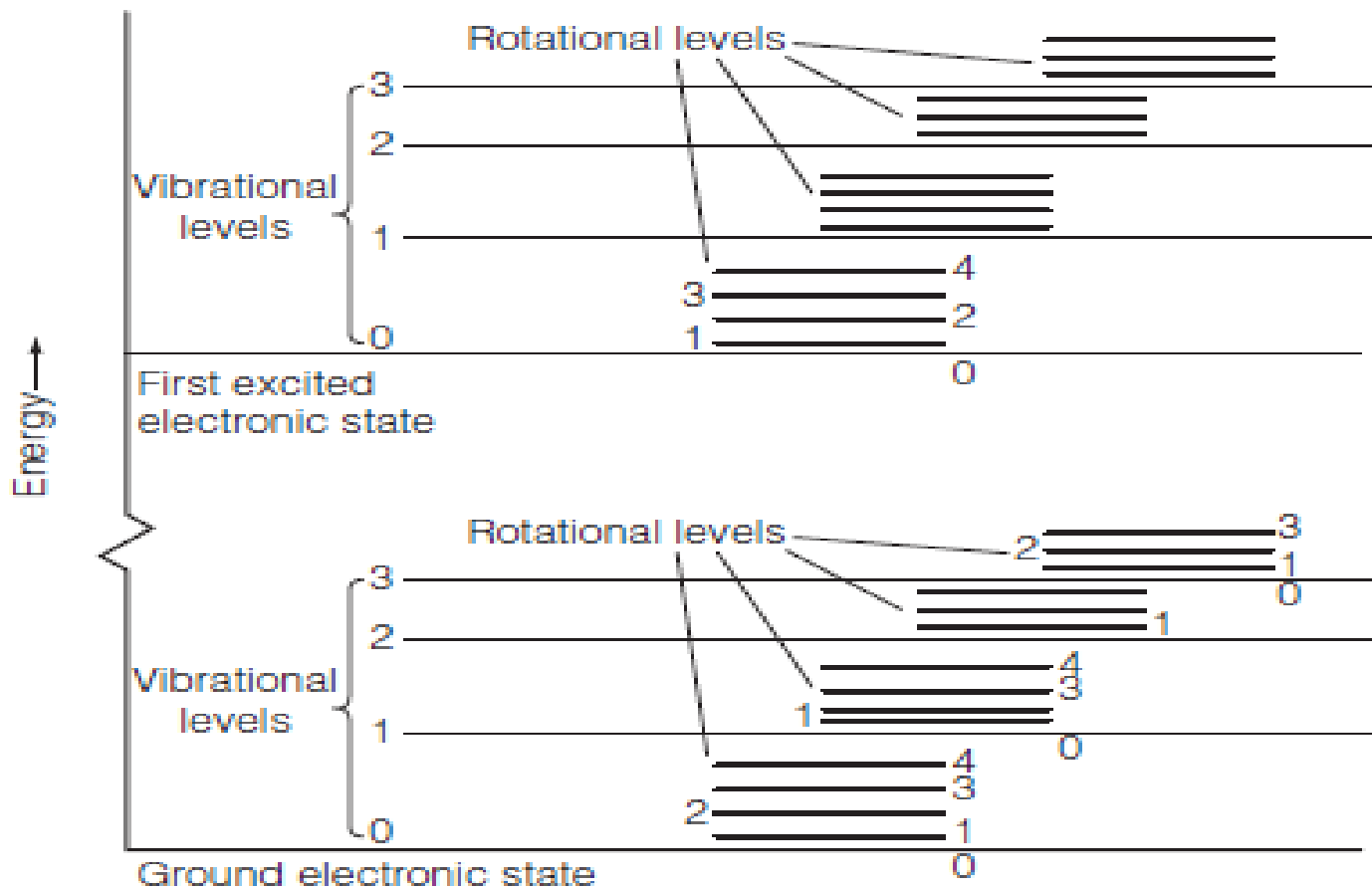
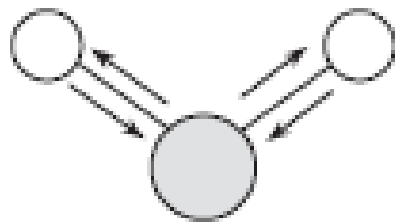

Fig. 5. Energy level diagram for a molecule.

E.T

Vibrational transition come about b/c a molecule has a multitude of quantized energy levels (vibrational state) associated with the bond that holed the molecule together.



Symmetric

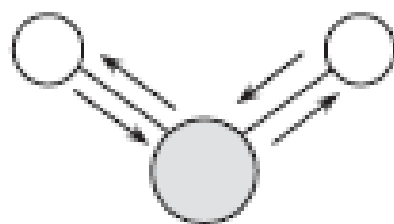

Asymmetric

A) Stretching Vibrations

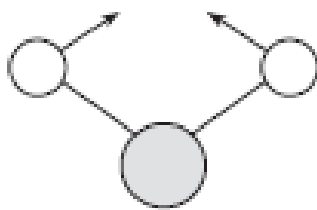

In- plane scissoring

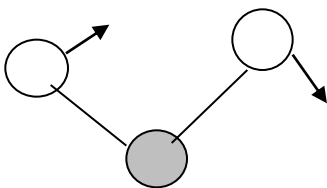

In-plane rocking

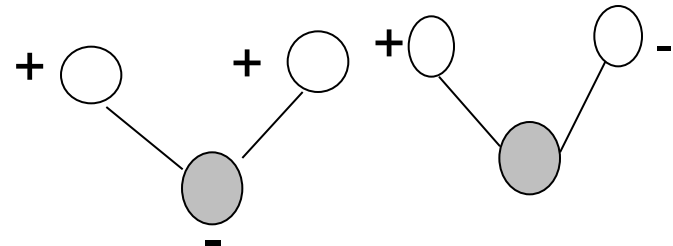

Out-plane wagging

Out-plane twisting

B) Bending vibrations

- Absorption by polyatomic molecules, particularly in the condensed state, is a considerably more complex process because the number of energy states is greatly enhanced.
- Here, the total energy of a molecule is given by
- $E = E_{\text{ele}} + E_{\text{vib}} + E_{\text{rot}}$
 - where E_{ele} describes the electronic energy of the molecule, and
 - E_{vib} refers to the energy of the molecule resulting from various atomic vibrations.
 - The third term accounts for the energy associated with the rotation of the molecule around its center of gravity.

Figure below is a graphical representation of the energies associated with few of the electronic and vibrational states of a molecule.

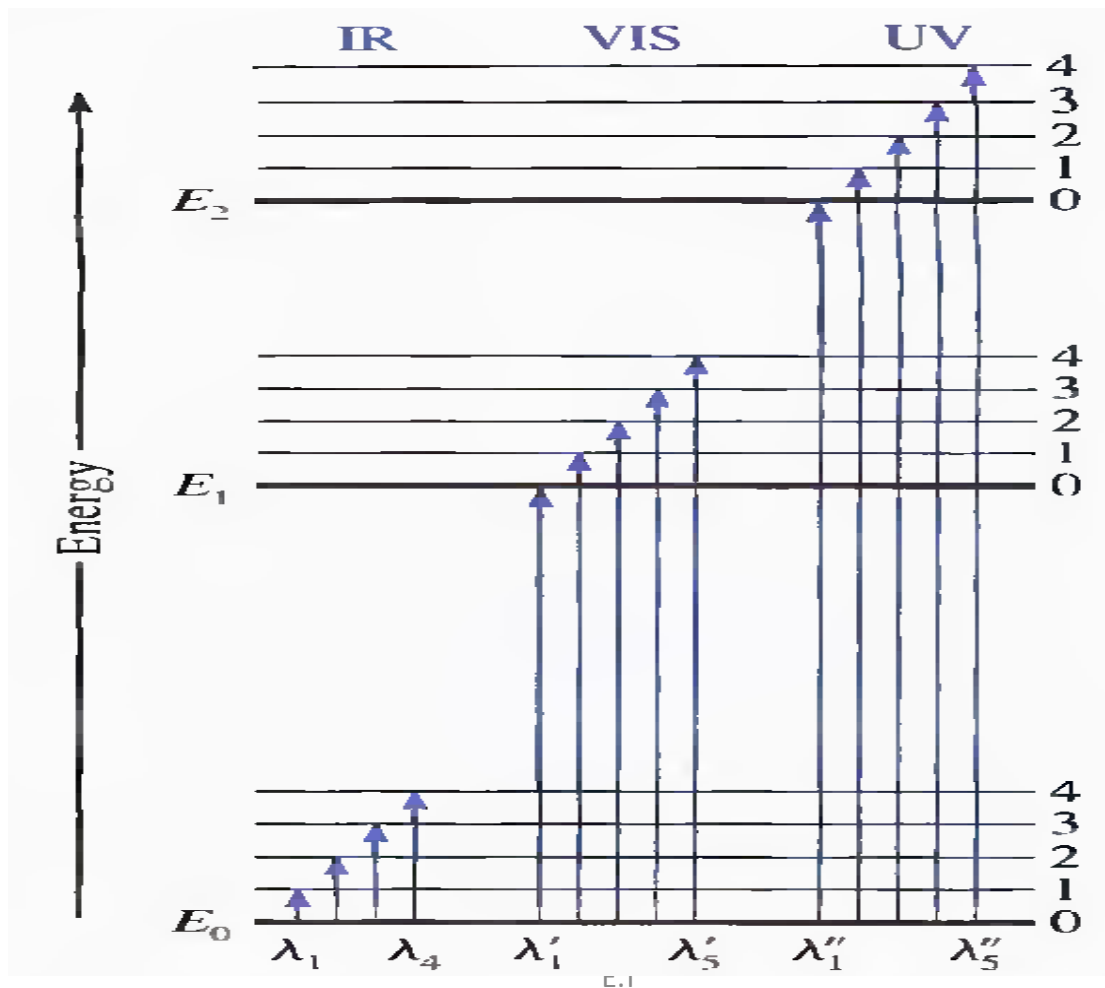

Fig.

- The heavy line labelled E_0 represents the electronic energy of the molecule in its ground state (its state of lowest electronic energy);
- the lines labelled E_1 and E_2 represent the energies of two excited electronic states.
- Several vibrational energy levels ($0, 1, \dots, 4$) are shown for each of these electronic states.
- the energy difference between the ground state and an electronically excited state is large relative to the energy differences b/n vibration levels in a given electronic state
 - (typically, the two differ by a factor of 10 to 100).

- Visible radiation causes excitation of an electron from E_0 to any of the vibration levels associated with E_1
- Ultraviolet causes excitation of an electron from E_0 to any of the vibration levels associated with E_2
- Finally, the less energetic near- and mid infrared radiation can only bring about transition among the vibrational levels of the ground state.
- Although they are not shown, several rotational energy levels are associated with each vibrational level.
- The energy difference between these is small relative to the energy difference between vibrational levels;

In contrast to atomic absorption spectra, which consist of a series of sharp, well-defined lines,

- **Molecular spectra** in the ultraviolet and visible regions are ordinarily characterized by **absorption bands**
- that often encompass a substantial wavelength the spectrum for a molecule ordinarily consists of a series of closely spaced absorption bands, such as that shown for benzene vapor in Figure below

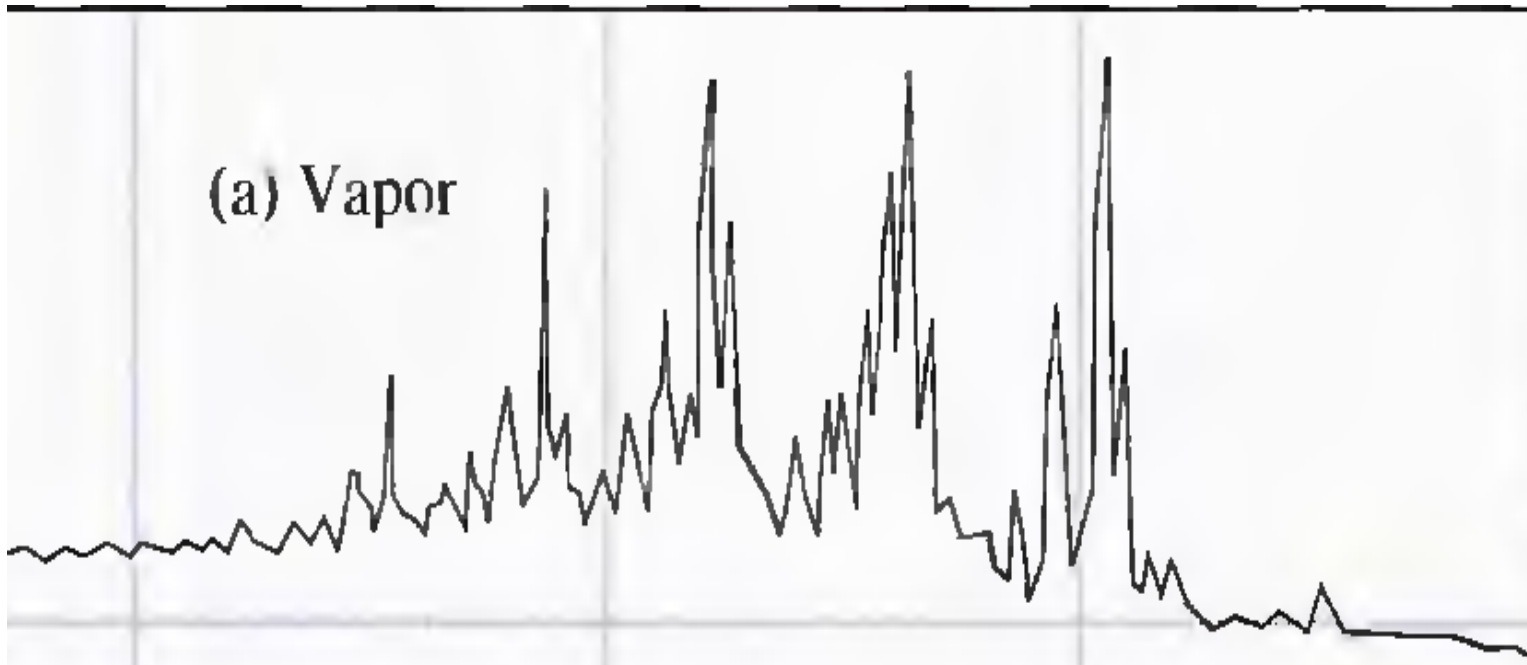

Unless a high-resolution instrument is employed, the individual bands may not be detected, and the spectra will appear as smooth curves.

Finally, in the condensed state and in the presence of solvent molecules, the individual bands tend to broaden to give spectra such as those shown in the Figure below

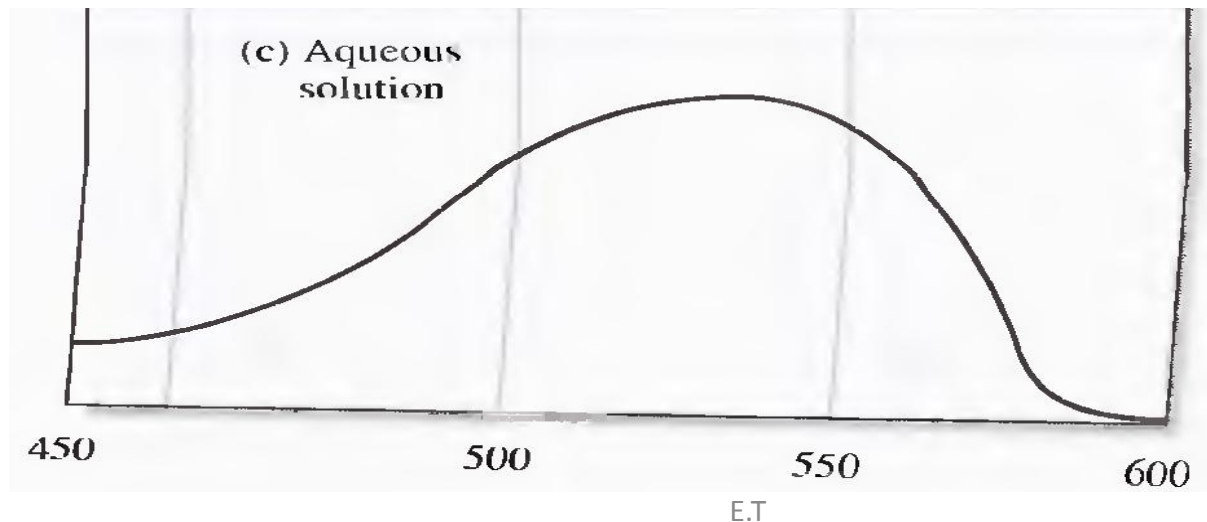

- **Pure vibrational absorption** can be observed in the **infrared region**.
 - where the energy of radiation is insufficient to cause electronic transitions.
- Variations in rotational levels may give rise to a series of peaks for each vibrational state.
 - However, rotation is often hindered or prevented in liquid or solid samples;
 - the effects of these small energy differences are not ordinarily detected in such samples.

- **Pure rotational spectra** for gases can be observed in the **microwave region**.
 - Absorption Induced by a Magnetic Field.
- When electrons or the nuclei of certain elements are subjected to a strong magnetic field additional quantized energy levels are produced as a consequence of magnetic properties of these elementary particles.
 - Absorption by nuclei or by electrons in magnetic fields is studied by *nuclear magnetic resonance* (NMR) and
 - *electron spin resonance* (ESR) techniques, respectively

Relaxation Processes

- Ordinarily, the lifetime of an atom or molecule excited by absorption of radiation is short because several *relaxation processes* exist which permit its return to the ground state.
- Two of the most important of these mechanisms
- nonradiative relaxation
- fluorescent relaxation

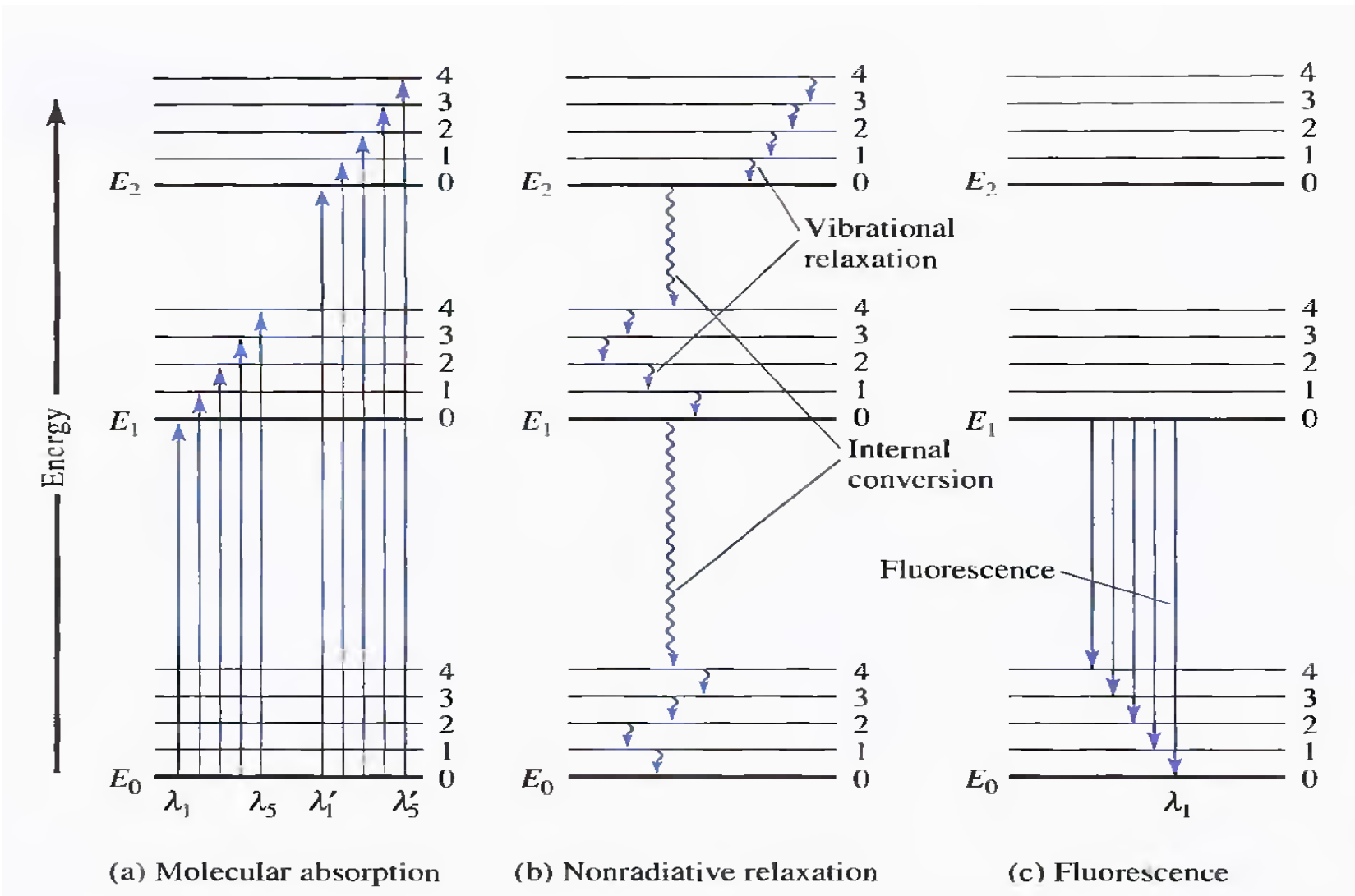

Fig. 5

- Two type of nonradiative relaxation are shown in the figure 5b
Vibrational deactivation or relaxation,
 - denoted by short arrows b/n vibrational energy levels,
 - involves the loss of energy in a series of small steps,
 - the excitation energy being converted to kinetic energy by collision with solvent molecules.
- These energy transferd to solvent molecule and reflacted by a tiny increase in the temperature of the medium.
- Non radiative relaxation b/n the lowest vibrational level of an exited electronic state and the upper vibrational level of another electronic level can also occur.
 - Represent by long arrow.
- Less efficient than vibrational relaxation and its life time is b/n 10^{-6} and 10^{-9}
- As shown in Figure 5c, relaxation can also occur by emission of fluorescent radiation.

II. Emission Radiation

- Excited particles (ions, atoms, or molecules) can be excited to one or more higher energy levels by a variety of means, including
 - bombardment with electrons or other elementary particles,
 - exposure to a high-potential alternating current spark,
 - heat treatment in an arc or a flame, or
 - absorption of electromagnetic radiation.
- The lifetime of an excited species is generally transitory (10^{-6} – 10^{-9} s) and
- a relaxation to a lower-energy levels or to their ground states takes place with the release of the excess energy in the form of Electromagnetic radiation, heat or perhaps both.

- Emission spectra
- A plot of the relative power of the emitted radiation

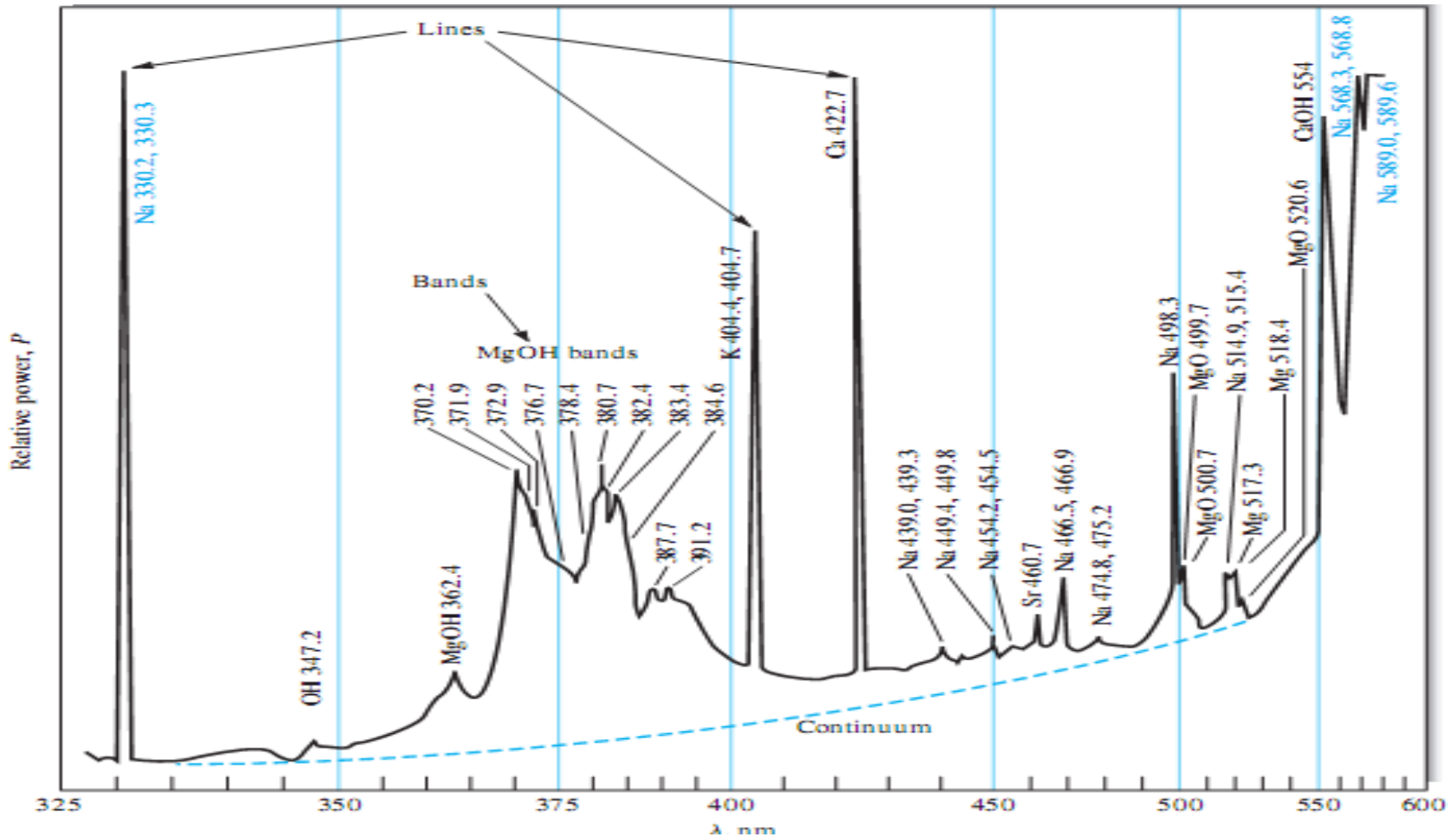

Figure 6 Emission spectrum of a brine sample obtained with an oxyhydrogen flame. The spectrum consists of the superimposed line, band, and continuum spectra of the constituents of the sample. The characteristic wavelengths of the species contributing to the spectrum are listed beside each feature. (R. Hermann and C. T. J. Alkemade, *Chemical Analysis by Flame Photometry*, 2nd ed., p. 484. New York: Interscience, 1979.)

- There are three type of spectra:- line, band and continues.
- Excitation can be brought about Radiating particles that are well separated from one another, as in the gaseous state, behave as independent bodies and often produce radiation containing relatively few specific wavelengths.
- The resulting spectrum is then *discontinuous* and is termed a *line spectrum*.
- *Made up of a series of sharp, well-defined peaks caused by an excitation of individual atom.*
- *In fig. 6 lines for Na, K, Sr and Ca*

- *The band spectrum consists of several groups of lines so closely spaced that they are not completely resolved.*
 - The source of the band is small molecules or radicals
 - In fig.6 bands of OH, MgOH and MgO
- Bands arise from the numerous quantized vibrational levels that are superimposed on the ground state electronic energy level of a molecule.
- *A continuous spectrum*, on the other hand, is one in which all wavelengths are represented over an appreciable range, or one in which the individual wavelengths are so closely spaced that resolution is not feasible by ordinary means.
 - The line and band spectra are superimposed
- Continuous spectra result from excitation of:
- (1) solids or liquids, in which the atoms are so closely packed as to be incapable of independent behaviour; or
- (2) complicated molecules possessing many closely related energy states.

- When solids are heated to incandescence, the continuous radiation that is emitted is more characteristic of the temperature of the emitting surface than of the material of which that surface is composed.
- Radiation of this kind (called *black-body radiation*)
- is produced by the innumerable atomic and molecular oscillations excited in the condensed solid by the thermal energy.

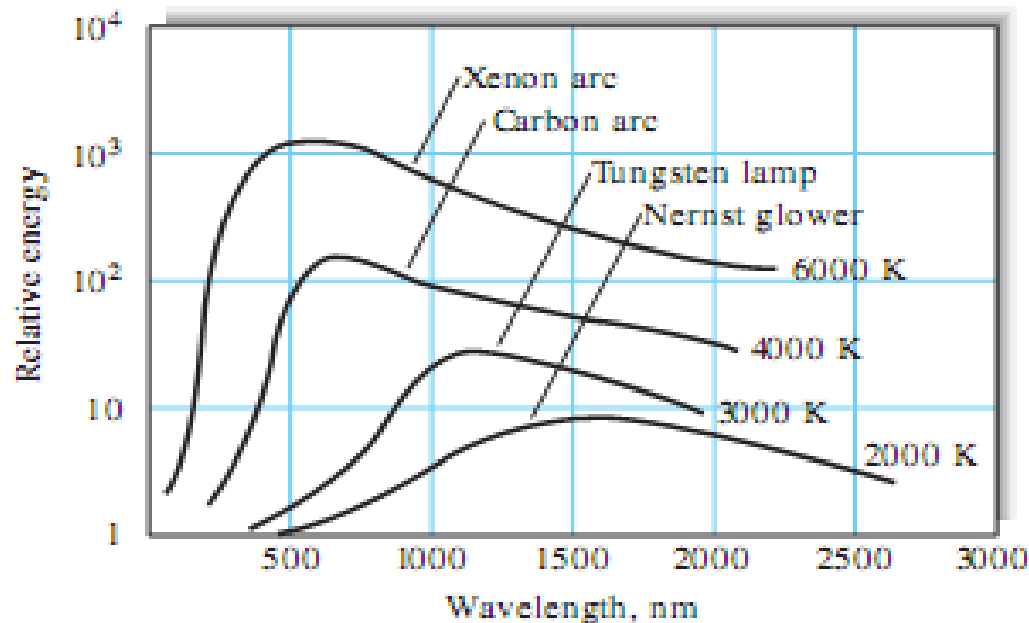

Figure 7 Blackbody radiation curves for various light sources. Note the shift in the peaks as the temperature of the sources changes.

- Both continuous spectra and line spectra are of importance in analytical chemistry.
- The former are frequently employed in methods based on the interaction of radiation with matter, such as spectrophotometry.
- Line spectra, on the other hand, are important because
 - they permit the identification and determination of the emitting species.

Absorption Law

Chapter 2

The absorption law

- also known as the Beer-Lambert law or just Beer's law,
- Tells us quantitatively how the amount of attenuation depends on the concentration of the absorbing molecules and the path length over which absorption occurs.
- As light traverses a medium containing an absorbing analyte, decreases in intensity occur as the analyte becomes excited.

Transmittance and Absorbance

- The common terms and alternative names/symbols employed in spectroscopy are listed in the table below. The recommended terms and symbols are listed under the column labeled Term and Symbol.

Terms and Symbols

Important Terms and Symbols Used in Absorption Measurements

Term and Symbol*	Definition	Alternative Name and Symbol
Incident radiant power, P_0	Radiant power in watts incident on sample	Incident intensity, I_0
Transmitted radiant power, P	Radiant power transmitted by sample	Transmitted intensity, I
Absorbance, A	$\log(P_0/P)$	Optical density, D ; extinction, E
Transmittance, T	P/P_0	Transmission, T
Path length of sample, b	Length over which attenuation occurs	l, d
Absorptivity, † a	$A/(bc)$	Extinction coefficient, k
Molar absorptivity, ‡ ϵ	$A/(bc)$	Molar extinction coefficient

*Terminology recommended by the American Chemical Society (*Anal. Chem.*, 1990, 62, 91).

† c may be expressed in g L^{-1} or in other specified concentration units; b may be expressed in cm or other units of length.

‡ c is expressed in mol L^{-1} ; b is expressed in cm.

Transmittance

Figure 1 depicts a beam of parallel radiation before and after it has passed through a layer of solution with a thickness of b cm and a concentration of c of an absorbing species.

As a consequence of interactions between the photons and absorbing particles, the power of the beam is attenuated from P_0 to P .

The transmittance T of the solution is the fraction

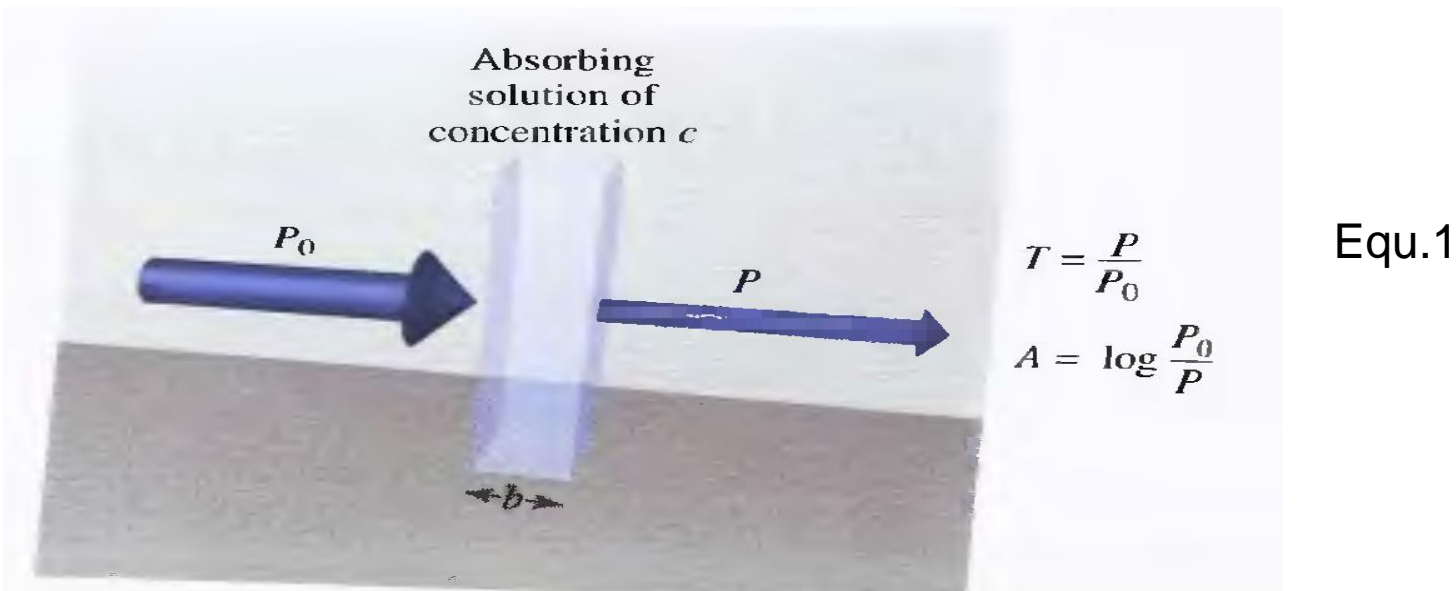

Absorbance

- Absorbance, like the previous table shows, can be defined as the base-ten logarithm of the reciprocal of the transmittance :

$$A = \log 1/T = -\log I/I_0 = -\log P/P_0 \quad \text{Equ.2}$$

- **Absorptivity and Molar Absorptivity**
- Absorbance is directly proportional to the path length through the solution and the concentration of the absorbing species.
 - That is, $A = abc$
- where a is a proportionality constant called
 - the *absorptivity*.
- *The magnitude will* clearly depend upon the units used for $b(\text{cm})$ and c (g/L).
- When the concentration is expressed in moles per liter and the cell length is in centimetres,
 - the absorptivity is called the *molar absorptivity* and given the special symbol ϵ
 - $A = \epsilon bc$

Experimental Measurements of *Absorbance and transmittance*

- The relationship given by Equation 1 and 2 is not directly applicable to chemical analysis.
- Neither *Absorbance* nor *Transmittance*, as defined, can be conveniently measured in the laboratory
 - because the solution to be studied must be held in some sort of container.
- Interaction between the radiation and the walls is inevitable leading to a loss by reflection at each interface;
- significant absorption may occur within the walls themselves.
- the beam may suffer a diminution in power during its passage through the solution as a result of scattering by large molecules or inhomogeneities.

Reflection and Scattering Losses

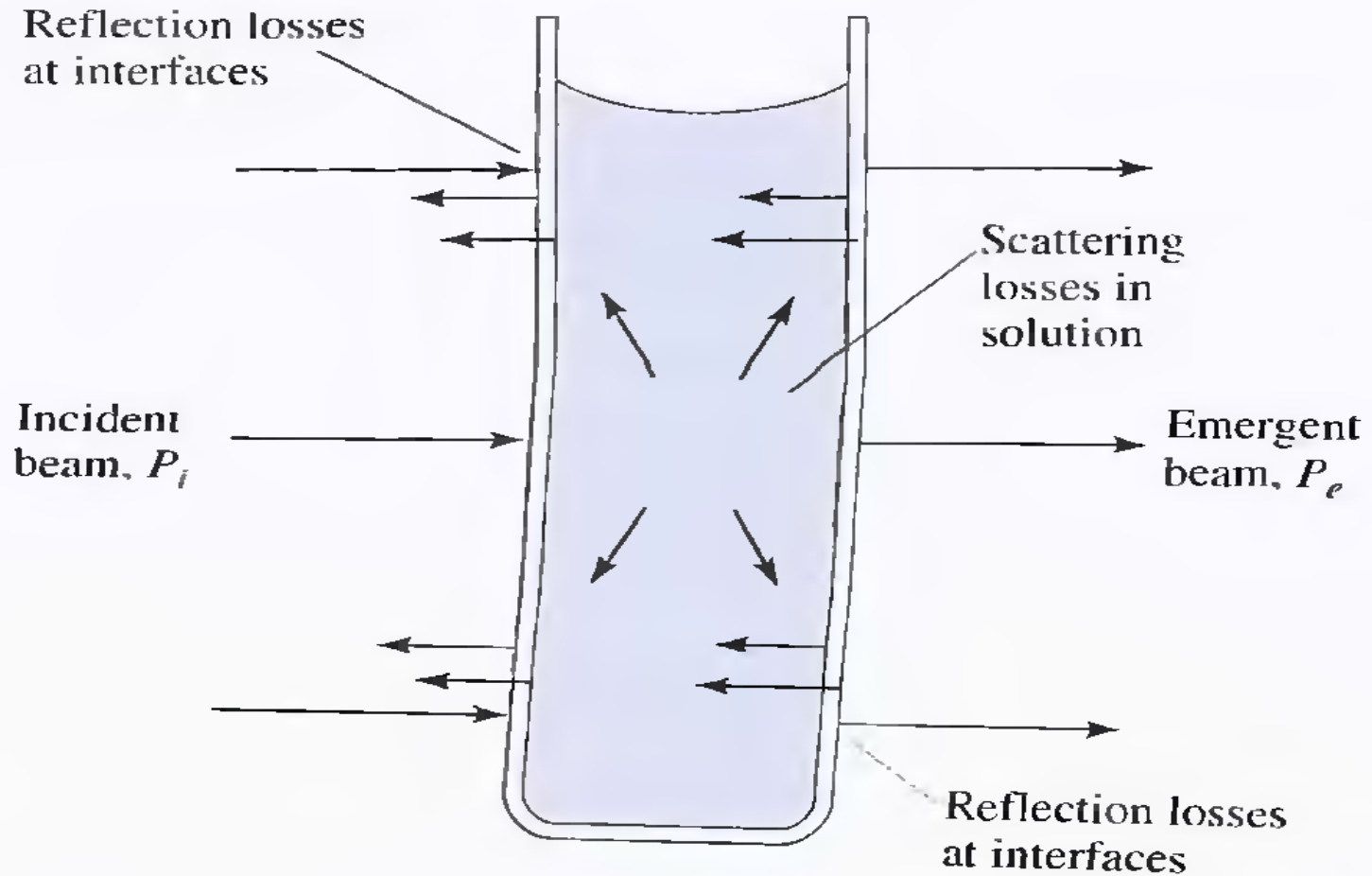

Reflection and Scattering Losses (cont)

- Reflection and scattering losses are significant and to compensate for these effects, the power of the beam transmitted by the analyte solution is ordinarily compared with the power of the beam transmitted by an identical cell containing only the solvent.
- An experimental absorbance that closely approximates the true absorbance is then obtained with the equation:

$$A = \log P_{\text{solvent}}/P_{\text{solution}} \approx \log P_o/P$$

- **Example:**
- A sample in a 1.0 cm cell is determined with a spectrometer to transmit 80 % light at a certain wavelength. If the absorptivity of this substance at this wavelength is 2.0, what is the concentration of the substance?
- **Solution:**
- The percent transmittance is 80 % and so $T = 0.80$:

$$\log \frac{1}{0.80} = 2.0 \text{ cm}^{-1} \text{ g}^{-1} \text{ L} \times 1.0 \text{ cm} \times c$$

$$\log 1.25 = 2.0 \text{ g}^{-1} \text{ L} \times c$$

$$c = \frac{0.10}{2.0} = 0.050 \text{ g} / \text{L}$$

Example.

A solution containing 1.00 mg ion (as the thiocyanate complex) in 100 mL was observed to transmit 70.0% of incident light compared to an appropriate blank.

- (a) What is the absorbance of the solution at this wavelength?
- (b) What fraction of light would be transmitted by a solution of iron four times as concentrated?

Solution: $T = 0.70$
 $A = \log \frac{1}{0.70} = \log 1.43 = 0.155$
 $0.155 = ab(0.0100 \text{ g / L})$

Therefore, $ab = 15.5 \text{ L / g}$
 $A = 15.5 \text{ L/g} (4 \times 0.0100 \text{ g/L}) = 0.620$
 $\log \frac{1}{T} = 0.620$
 $T = 0.240$

The absorbance of the new solution could have been calculated more directly:

E.T. $\frac{A_1}{A_2} = \frac{abc_1}{abc_2} = \frac{c_1}{c_2}$
 $A_2 = A_1 \times \frac{c_2}{c_1} = 0.155 \times \frac{4}{1} = 0.620_{56}$

Beer's Law

Consider This:

- A parallel beam of monochromatic radiation with power P_0 strikes the block perpendicular to a surface after passing through a length b of the material, which contains n absorbing particles, the beam's power is decreased to P as a result of absorption.

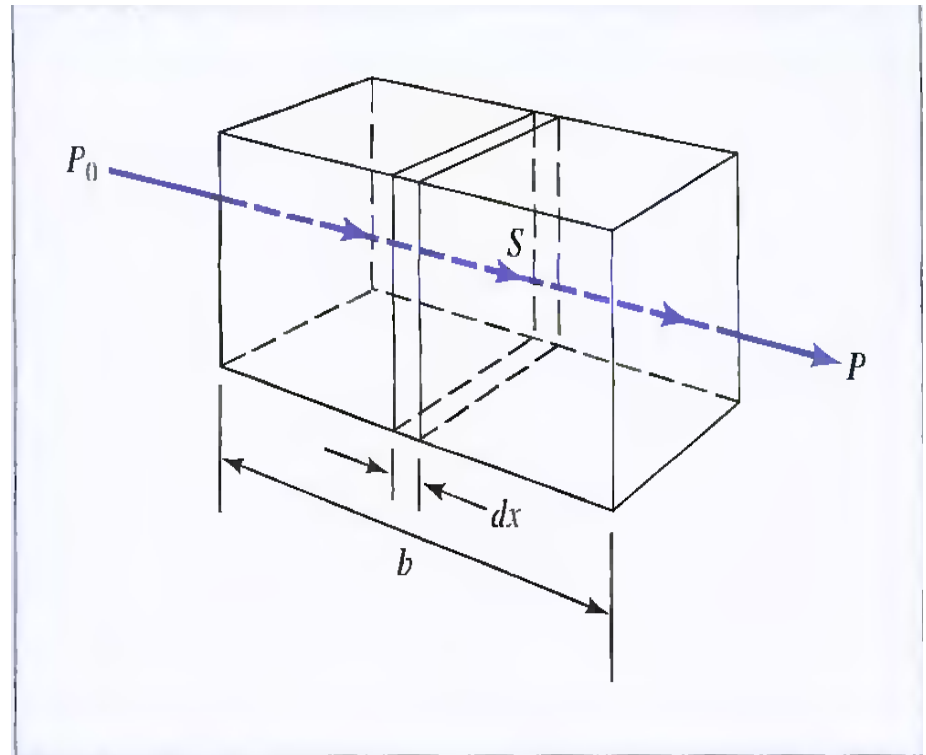

an

area S and an infinitesimal thickness dx .

➤ Within this section there are dn absorbing particles;

associated with each particle, we can imagine a surface

at which photon capture will occur.

➤ That is, if a photon reaches one of these areas by chance, absorption will follow immediately.

➤ The total projected area of these capture surfaces

within the section is designated as dS ;

➤ the ratio of the capture area to the total area, then, is

$$dS/S.$$

➤ On a statistical average, this ratio represents the

- The power of the beam entering the section, P_x , is proportional to the number of photons per square centimeter per second, and
- dP_x represents the quantity removed per second within the section;
- the fraction absorbed is then $-dP_x/P_x$, and this ratio also equals the average probability for capture.
- The term is given a minus sign to indicate that P undergoes a decrease. Thus,

$$\frac{dP_x}{P_x} = \frac{dS}{S} \quad \text{q.3}$$

Recall, now, that dS is the sum of the capture areas for particles within the section; it must therefore be proportional to the number of particles, or

$$dS = a dn \quad \text{eq. 4}$$

where dn is the number of particles and a is a proportionality constant, which can be called the *capture cross section*. Combining Equations 3 and 4 and summing over the interval between zero and n , we obtain

$$-\int_{P_0}^P \frac{dP_x}{P_x} = \int_0^n \frac{a dn}{S} \quad \text{eq 5}$$

Integration gives

$$-\ln \frac{P}{P_0} = \frac{an}{S}$$

converting to base 10 logarithms and inverting the fraction to change the sign, we obtain

$$\log \frac{P_0}{P} = \frac{an}{2.303 S} \quad 7$$

where n is the total number of particles within the block shown in Figure 2. The cross sectional area S can be expressed in terms of the volume of the block V and its length b .

Thus,

$$S = \frac{V}{b} \text{ cm}^2 \quad \text{q. 8}$$

Substitution of this quantity into Equation 7 yields

$$\log \frac{P_0}{P} = \frac{anb}{2.303 V}$$

Note that n/V has the units of concentration (that is, number of particles per cubic centimetre); we can readily convert n/V to moles per liter. Thus, number of moles given by

$$\text{number mol} = \frac{n \text{ particles}}{6.022 \times 10^{23} \text{ particles/mol}}$$

and c in mol/L is given by

$$\begin{aligned} c &= \frac{n}{6.022 \times 10^{23}} \text{ mol} \times \frac{1000 \text{ cm}^3/\text{L}}{V \text{ cm}^3} \\ &= \frac{1000 n}{6.022 \times 10^{23} V} \text{ mol/L} \end{aligned}$$

eq.9

Combining eq.8 and 9

$$\log \frac{P_0}{P} = \frac{6.022 \times 10^{23} abc}{2.303 \times 1000}$$

Finally, the constants in this equation can be collected into a single term ϵ to give

$$\log \frac{P_0}{P} = \epsilon bc = A$$

which is Beer's law.

Application of Beer`s Law to Mixture

- Beer's law also applies to a solution containing more than one kind of absorbing substance.
- Provided there is no interaction among the various species, the total absorbance for a multicomponent system is given by
$$A_{\text{total}} = A_1 + A_2 + \dots + A_n \quad (6-11) = \varepsilon_1 b c_1 + \varepsilon_2 b c_2 + \dots + \varepsilon_n b c_n$$
- where the subscripts refer to absorbing components 1, 2, ..., n.

Deviations from Beer's Law

- Beer's law states that a plot of absorbance versus concentration should give a straight line passing through the origin with a slope equal to ab . However, deviations from direct proportionality between absorbance and concentration are sometimes encountered.
- These deviations are a result of one or more of the following three things ; real limitations, instrumental factors or chemical factors.

Real Limitations

- Beer's law is successful in describing the absorption behavior of dilute solutions only ; in this sense it is a limiting law. At high concentrations ($> 0.01\text{M}$), the average distance between the species responsible for absorption is diminished to the point where each affects the charge distribution of its neighbors.
- This interaction, in turn, can alter the species' ability to absorb at a given wavelength of radiation
 - Because the extent of interaction depends upon concentration,
- the occurrence of this phenomenon thus leading to a deviation from Beer's law.

Limitations (cont)

- A similar effect is sometimes encountered in solutions containing low absorber concentrations and high concentrations of other species, particularly electrolytes.
- The close proximity of ions to the absorber alters the molar absorptivity of the latter by electrostatic interactions;
 - the effect is lessened by dilution
- Deviations also arise because ϵ is dependent upon the refractive index of the solution. Thus, if concentration changes cause significant alterations in the refractive index μ of a solution, departures from Beer's law are observed.

Chemical Deviations

- Apparent deviations from Beer's law are frequently encountered as a consequence of association, dissociation, or reaction of the absorbing species with the solvent to generate a product that has a different absorption spectrum with the analyte.
- A common example of this behavior is found with acid/base indicators.
- Deviations arising from chemical factors can only be observed when concentrations are changed.

Instrumental Deviations

- Unsatisfactory performance of an instrument may be caused by fluctuations in the power-supply voltage, an unstable light source, or a non-linear response of the detector-amplifier system.

Polychromatic Radiation

- Strict adherence to Beer's law is observed only with truly monochromatic radiation. This sort of radiation is only approached in specialized line emission sources.
- All monochromators, regardless of quality and size, have a finite resolving power and therefore minimum instrumental bandwidth.
- the use of radiation that is restricted to a single wavelength is seldom practical; devices that isolate portions of the output from a continuous source produce a more or less symmetric band of wavelengths around the desired one

Polychromatic Radiation (cont)

- A good picture of the effect of polychromatic radiation can be presented as follows. When radiation consists of two wavelengths, λ' and λ'' , and assuming that Beer's law applies at each of these individually
- the absorbance at λ' is given by:

$$\log (P'_0/P') = A' = \epsilon'bc$$

$$P'_0/P' = 10^{\epsilon'bc}$$

$$P' = p'_0 10^{-\epsilon'bc}$$

Similarly at λ'' is given by

$$P'' = p_0'' 10^{-\epsilon''bc}$$

- When an absorbance measurement is made with radiation composed of both wavelengths, the power of the beam emerging from the solution is given by $(P' + P'')$ and that of the beam from the solvent by $(P'_0 + P''_0)$.
- Therefore, the measured absorbance is

$$A_m = \log \left(\frac{P'_0 + P''_0}{P' + P''} \right)$$

We then substitute for P' and P'' and find that

$$A_m = \log \left(\frac{P'_0 + P''_0}{P'_0 10^{-\epsilon'bc} + P''_0 10^{-\epsilon''bc}} \right)$$

or

$$A_m = \log(P'_0 + P''_0) - \log(P'_0 10^{-\varepsilon'bc} + P''_0 10^{-\varepsilon''bc})$$

We see that when $\varepsilon' = \varepsilon''$, this equation simplifies to

$$\begin{aligned} A_m &= \log(P'_0 + P''_0) - \log[(P'_0 + P''_0)(10^{-\varepsilon'bc})] \\ &= \log(P'_0 + P''_0) - \log(P'_0 + P''_0) - \log(10^{-\varepsilon'bc}) \\ &= \varepsilon'bc = \varepsilon''bc \end{aligned}$$

- If the two molar absorptivities differ, however, the relationship between A_M and concentration will no longer be linear; moreover, greater departures from linearity can be expected with increasing differences between ϵ' and ϵ'' .

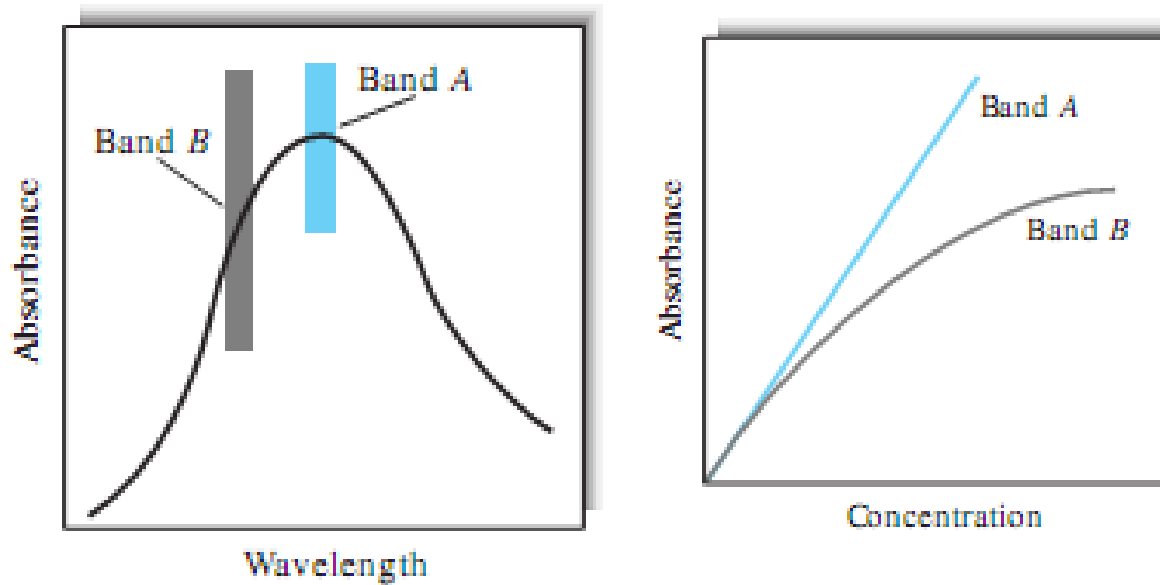

FIGURE the effect of polychromatic radiation on beer's law. In the spectrum at the left, the absorptivity of the analyte is nearly constant over band A from the source. Note in the beer's law plot at the right that using band A gives a linear relationship. In the spectrum, band B corresponds to a region where the absorptivity shows substantial changes. In the right plot, note the dramatic deviation from beer's law that results.

Chapter Three

Instruments for optical spectroscopy

- The basic components of analytical instruments
 - for emission,
 - absorption and
 - fluorescence spectroscopy
- Are remarkably alike in function and general performance requirements regardless of whether the instrument are designed for Uv, Vis or IR radiation.
 - Called **Optical instruments**

- Spectroscopic instruments contain five components, including:
- a stable source of radiant energy;
- a wavelength selector that permits the isolation of a restricted wavelength region;
- a transparent container for holding the sample;
- a radiation detector or transducer, that converts radiant energy to a usable signal (usually electrical); and
- a signal processor and *readout*

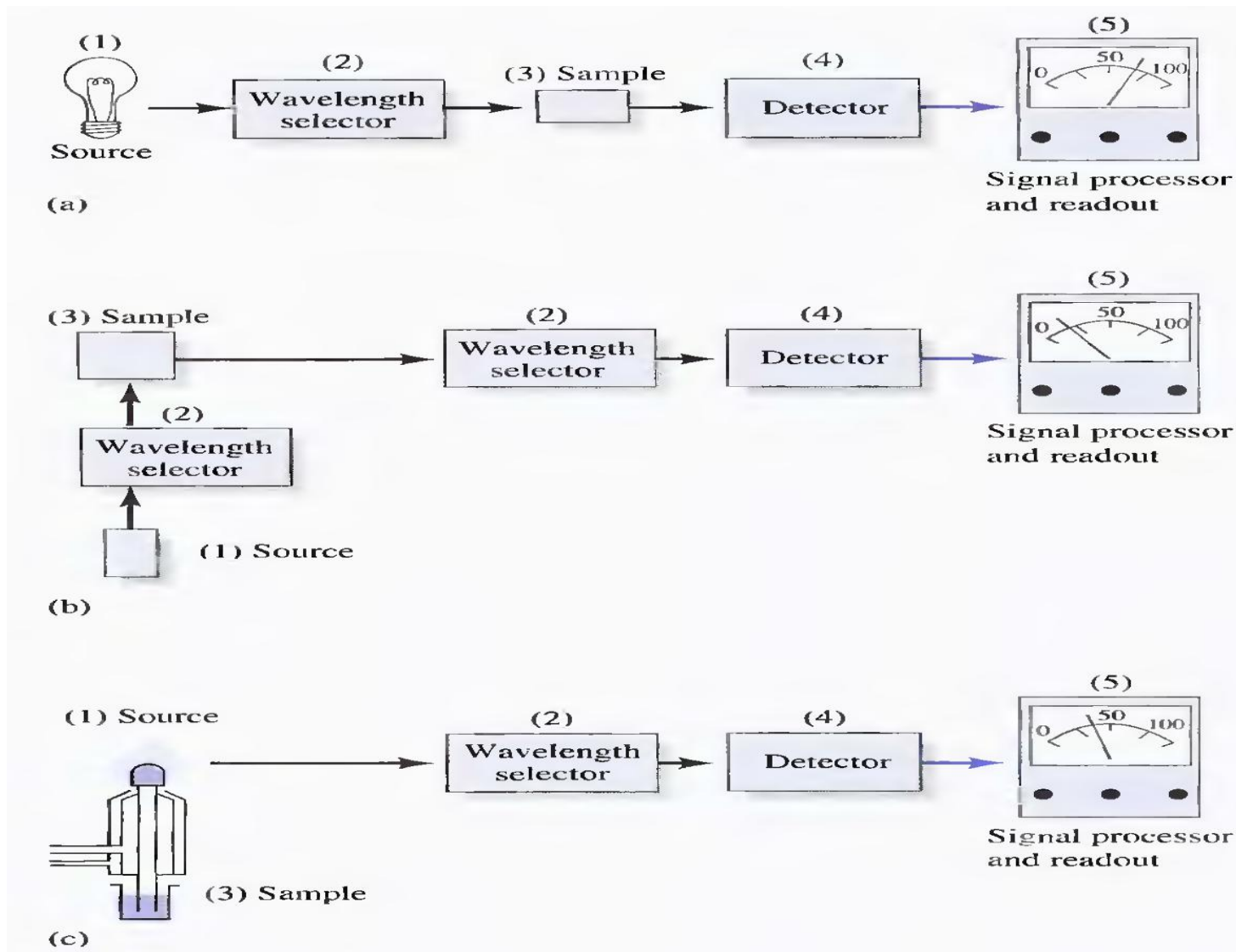

FIGURE 1 Components for various types of instruments for optical spectroscopy: (a) absorption spectroscopy, (b), fluorescence and scattering Spectroscopy and (c) emission spectroscopy

- As can be seen in the figure, the configuration of components (4) and (5) is the same for each type of instruments.
- **Emission spectroscopy** differ from the other two types in that components 1 & 3 are combined,
 - that no external radiation source is required;
 - the sample itself is the emitter.
 - the sample is usually fed into a plasma or a flame, which provides enough thermal energy to cause the analyte to emit characteristic radiation..
- Absorption and fluorescence spectroscopy require an external source of radiant energy and a cell to hold the sample.
- **For the absorption measurements**
- The beam from the source passes through the sample after leaving the wavelength selector.
- **In fluorescence** Here, two wavelength selectors are needed to select the excitation and emission wavelengths. The selected source radiation is incident on the sample and the radiation emitted is measured. usually at right angles to avoid scattering.

Optical Material

The cell, windows, lenses and wavelength – selecting elements in a optical spectroscopy instrument must transmit radiation in the wavelength region being investigated.

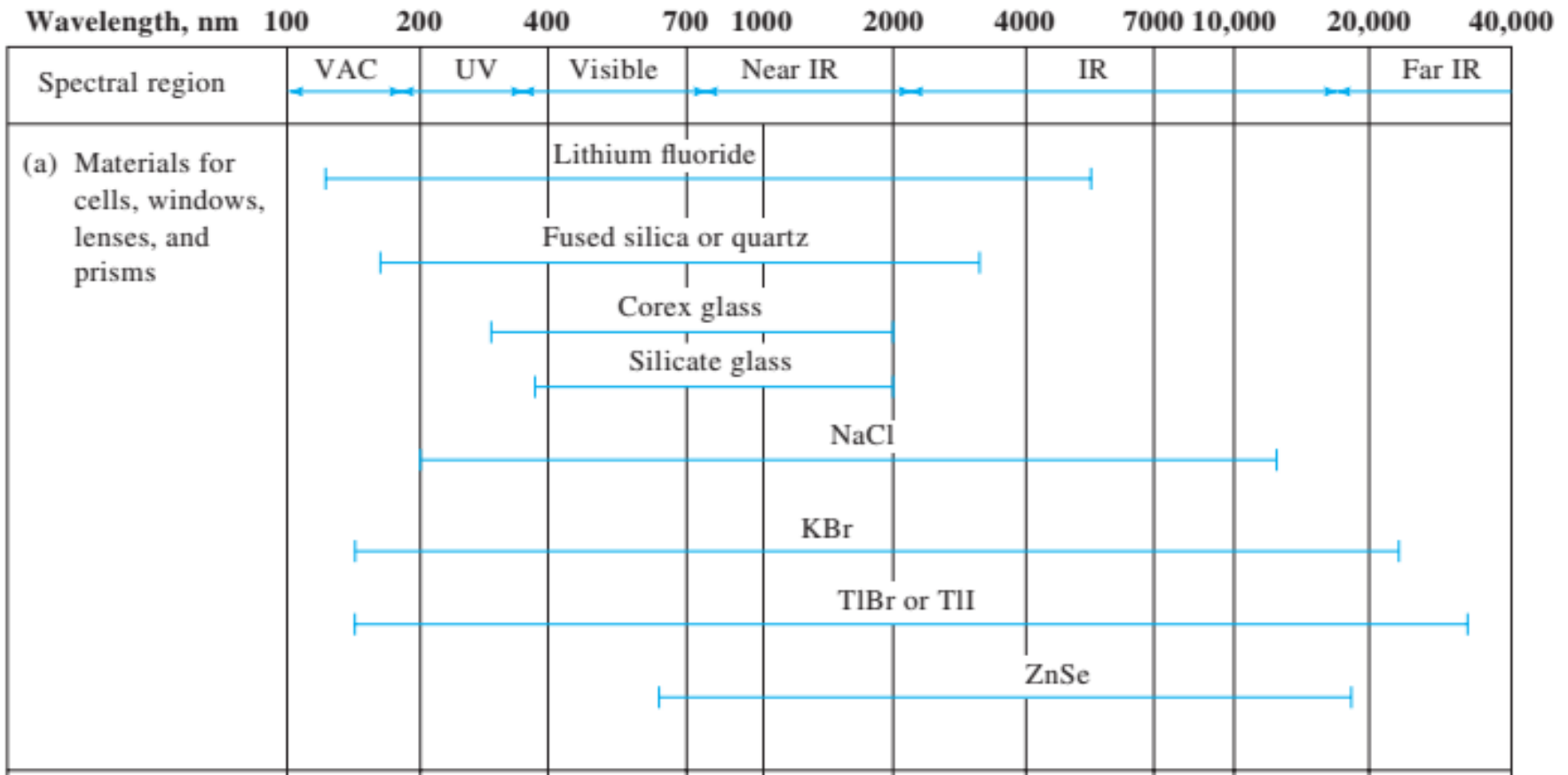

Figure 2a Transmittance ranges for various construction materials.

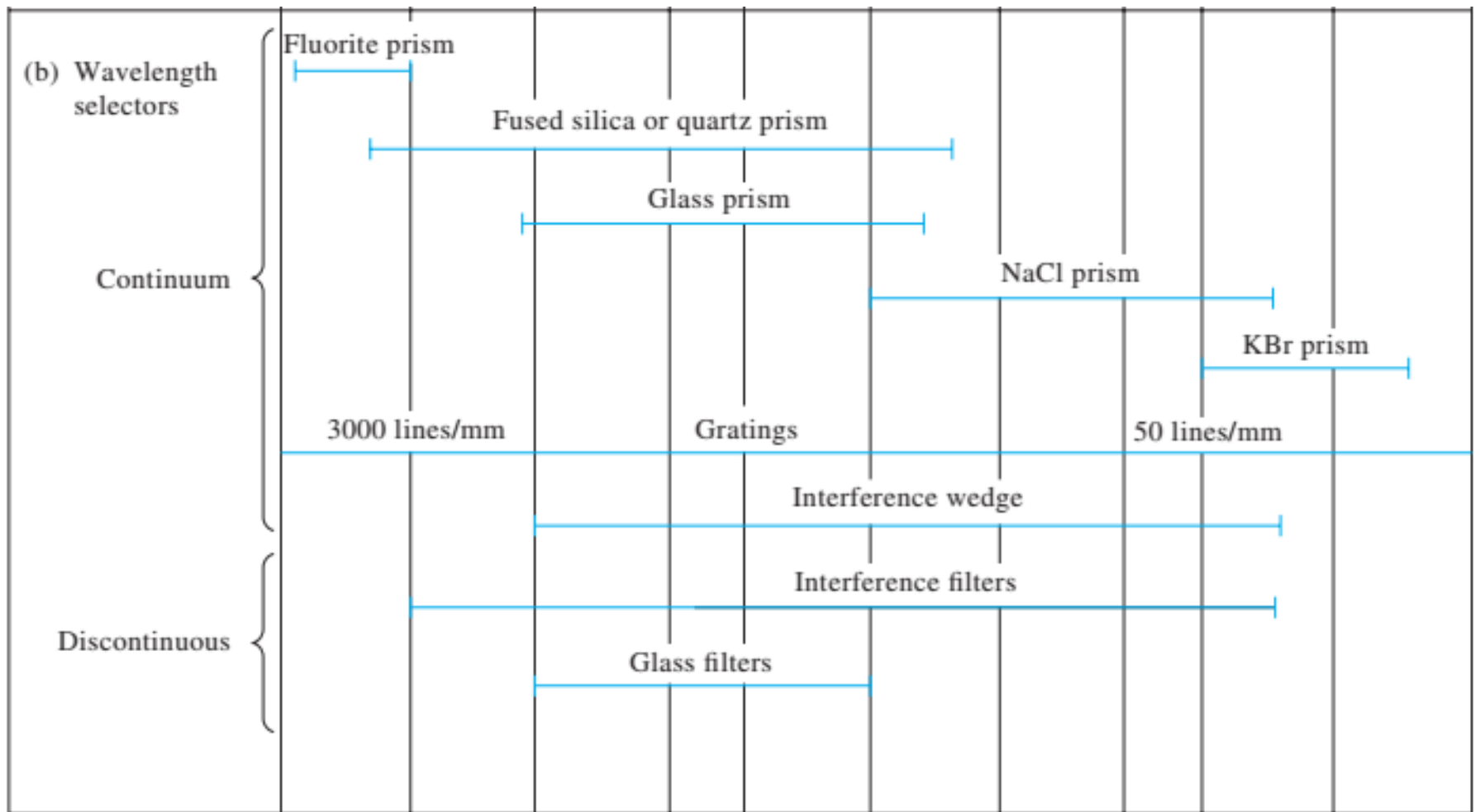

Figure 2b Transmittance ranges for wavelength selectors

- Ordinary silicate glass is completely adequate for use in the visible region and has the considerable advantage of low cost.
- In the UV region at wavelengths shorter than about 380 nm glass begins to absorb and fused silica or quartz must be substituted.
- Also, in the IR region, glass, quartz, and fused silica all absorb at wavelengths longer than about 2500nm.
- Hence, optical elements for IR spectrometry are typically made from halide salts or In some cases polymeric materials.

Spectroscopic Sources

- To be suitable for spectroscopic studies,
 - a source must generate a beam of radiation that is sufficiently powerful to allow easy detection and measurement.
 - its output power should be stable for reasonable periods of time.
- Typically, for good stability, a well-regulated power supply must provide electrical power for the source.
- Spectroscopic sources are of two types:
- continuum sources, which emit radiation that changes in intensity only slowly as a function of wavelength, and
- line sources, which emit a limited number of spectral lines, each of which spans a very limited wavelength range.
- The distinction between these sources is illustrated in Figure 3.

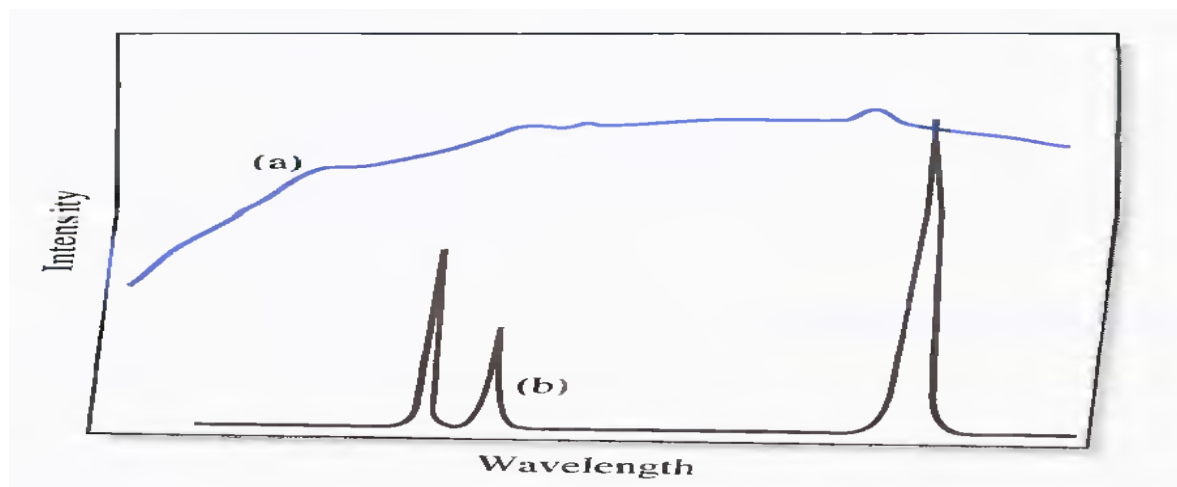
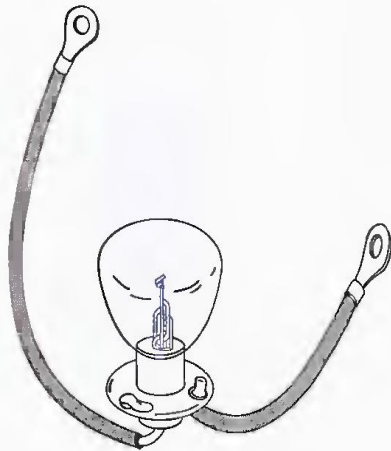

Fig. 3

Wavelength, nm	100	200	400	700	1000	2000	4000	7000	10,000	20,000	40,000																																																																																																																									
Spectral region	VAC		UV		Visible		Near IR		IR		Far IR																																																																																																																									
(a) Sources	<table border="0" style="width: 100%; border-collapse: collapse;"> <tr> <td style="width: 15%;"></td> <td style="width: 15%;">Ar lamp</td> <td colspan="10"></td> </tr> <tr> <td></td> <td>Xe lamp</td> <td colspan="10"></td> </tr> <tr> <td></td> <td>H₂ or D₂ lamp</td> <td colspan="10"></td> </tr> <tr> <td></td> <td>LEDs</td> <td colspan="10"></td> </tr> <tr> <td></td> <td>Tungsten lamp</td> <td colspan="10"></td> </tr> <tr> <td></td> <td>Nernst glower (ZrO₂ + Y₂O₃)</td> <td colspan="10"></td> </tr> <tr> <td></td> <td>Nichrome wire (Ni + Cr)</td> <td colspan="10"></td> </tr> <tr> <td></td> <td>Globar (SiC)</td> <td colspan="10"></td> </tr> <tr> <td></td> <td>Hollow cathode lamps</td> <td colspan="10"></td> </tr> <tr> <td></td> <td>Lasers</td> <td colspan="10"></td> </tr> </table>													Ar lamp												Xe lamp												H ₂ or D ₂ lamp												LEDs												Tungsten lamp												Nernst glower (ZrO ₂ + Y ₂ O ₃)												Nichrome wire (Ni + Cr)												Globar (SiC)												Hollow cathode lamps												Lasers										
	Ar lamp																																																																																																																																			
	Xe lamp																																																																																																																																			
	H ₂ or D ₂ lamp																																																																																																																																			
	LEDs																																																																																																																																			
	Tungsten lamp																																																																																																																																			
	Nernst glower (ZrO ₂ + Y ₂ O ₃)																																																																																																																																			
	Nichrome wire (Ni + Cr)																																																																																																																																			
	Globar (SiC)																																																																																																																																			
	Hollow cathode lamps																																																																																																																																			
	Lasers																																																																																																																																			
Continuum	<table border="0" style="width: 100%; border-collapse: collapse;"> <tr> <td style="width: 15%;"></td> <td style="width: 15%;">Ar lamp</td> <td colspan="10"></td> </tr> <tr> <td></td> <td>Xe lamp</td> <td colspan="10"></td> </tr> <tr> <td></td> <td>H₂ or D₂ lamp</td> <td colspan="10"></td> </tr> <tr> <td></td> <td>LEDs</td> <td colspan="10"></td> </tr> <tr> <td></td> <td>Tungsten lamp</td> <td colspan="10"></td> </tr> <tr> <td></td> <td>Nernst glower (ZrO₂ + Y₂O₃)</td> <td colspan="10"></td> </tr> <tr> <td></td> <td>Nichrome wire (Ni + Cr)</td> <td colspan="10"></td> </tr> <tr> <td></td> <td>Globar (SiC)</td> <td colspan="10"></td> </tr> </table>													Ar lamp												Xe lamp												H ₂ or D ₂ lamp												LEDs												Tungsten lamp												Nernst glower (ZrO ₂ + Y ₂ O ₃)												Nichrome wire (Ni + Cr)												Globar (SiC)																																		
	Ar lamp																																																																																																																																			
	Xe lamp																																																																																																																																			
	H ₂ or D ₂ lamp																																																																																																																																			
	LEDs																																																																																																																																			
	Tungsten lamp																																																																																																																																			
	Nernst glower (ZrO ₂ + Y ₂ O ₃)																																																																																																																																			
	Nichrome wire (Ni + Cr)																																																																																																																																			
	Globar (SiC)																																																																																																																																			
Line	<table border="0" style="width: 100%; border-collapse: collapse;"> <tr> <td style="width: 15%;"></td> <td style="width: 15%;">Hollow cathode lamps</td> <td colspan="10"></td> </tr> <tr> <td></td> <td>Lasers</td> <td colspan="10"></td> </tr> </table>													Hollow cathode lamps												Lasers																																																																																																										
	Hollow cathode lamps																																																																																																																																			
	Lasers																																																																																																																																			

- **Continuous Sources of Ultraviolet -Visible, and Near-Infrared Radiation**
- **Tungsten Filament Lamps**
- The most common source of visible and near-infrared radiation is the tungsten filament lamp.
 - The energy distribution of this source approximates that of a black body and is thus temperature dependent.
- Figure below illustrates the behaviour of the tungsten filament lamp at 3000°K. In most absorption instruments, the operating filament temperature is about 2900°K; the bulk of the energy is thus emitted in the infrared region.



(a)

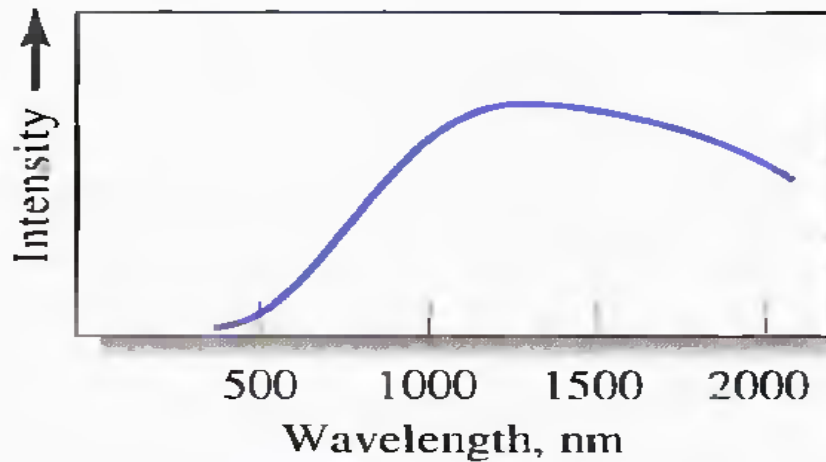

(b)

Figure 4 (a) A tungsten lamp of the type used in spectroscopy and its spectrum

(b). Intensity of the tungsten source is usually quite low at wavelengths shorter than about 350 nm. Note that the intensity reaches a maximum in the near-IR region of the spectrum (-1200 nm in this case).

- A tungsten filament lamp is useful for the wavelength region between 320 and 2500 nm.
- In the visible region the energy output of a tungsten lamp varies.
 - As a consequence close voltage control is required for a stable radiation source.
- Constant voltage transformers or electronic voltage regulators are often employed for this purpose

Hydrogen or Deuterium Lamps

- A truly continuous spectrum in the ultraviolet region is conveniently produced by the electrical excitation of hydrogen or deuterium at low pressure.
- The mechanism by which a continuum is produced involves the formation of excited molecule (D_2^* or H_2^*) by absorption of electrical energy.
- The species then dissociates to give two hydrogen or deuterium plus ultraviolet photon.

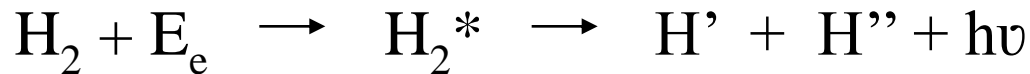

The energy of the overall process is

$$E_e = E_{H_2^*} = E_{H'} + E_{H''} + h\nu$$

$E_{H_2^*}$ is fixed quantized energy of H_2^* , $E_{H'}$ and $E_{H''}$ kinetic energy of H' and H''

- Most modern lamps for generating ultraviolet radiation contain deuterium and are of a low-voltage lamps.
 - an arc is formed between a heated, oxide-coated filament and a metal electrode.
- The heated filament provides 'electrons to maintain a dc current when a voltage of about 40 V is applied; a regulated power supply is required for constant intensities.
- Both hydrogen and deuterium lamps produce a continuous spectrum in the region of 160 to 375 nm.
- Quartz windows must be employed in the tubes, since glass absorbs strongly in this wavelength region.
- **Xenon Arc Lamps.**
- This lamp produces intense radiation by the passage of current through an atmosphere of xenon.
- The spectrum is continuous over the range between about 250 and 600 nm.

- **Continuous Sources of Infrared radiation**
- The common infrared source is an inert solid heated electrically to temperatures between
 - 1500 and 2000°K.
- The **Nernst glower** is composed of Zirconium and yttrium oxides formed into a cylinder having a diameter of 2 mm and length of perhaps 20 mm,
 - It emits infrared radiation when heated to a high temperature by an electric current.
- **The Global Source**
- A Global is a silicon carbide rod, usually about 50 mm in length and 5 mm in diameter.
- Radiation in the region 1 to 40 μm is emitted when the Global heated to 1500°C by passage of electricity

- **Line Sources**
- Sources that emit a few discrete lines find use in atomic absorption spectroscopy, Raman spectroscopy, refractometry, and polarimetry.
- **Hollow Cathode Lamps**
- The most common source for atomic absorption
- which consists of a tungsten anode and a cylindrical cathode sealed in a glass tube that is filled with neon or argon at a pressure of 1 to 5 torr
- The cathode is constructed of the metal whose spectrum is desired or serves as a support for a coating of that metal.

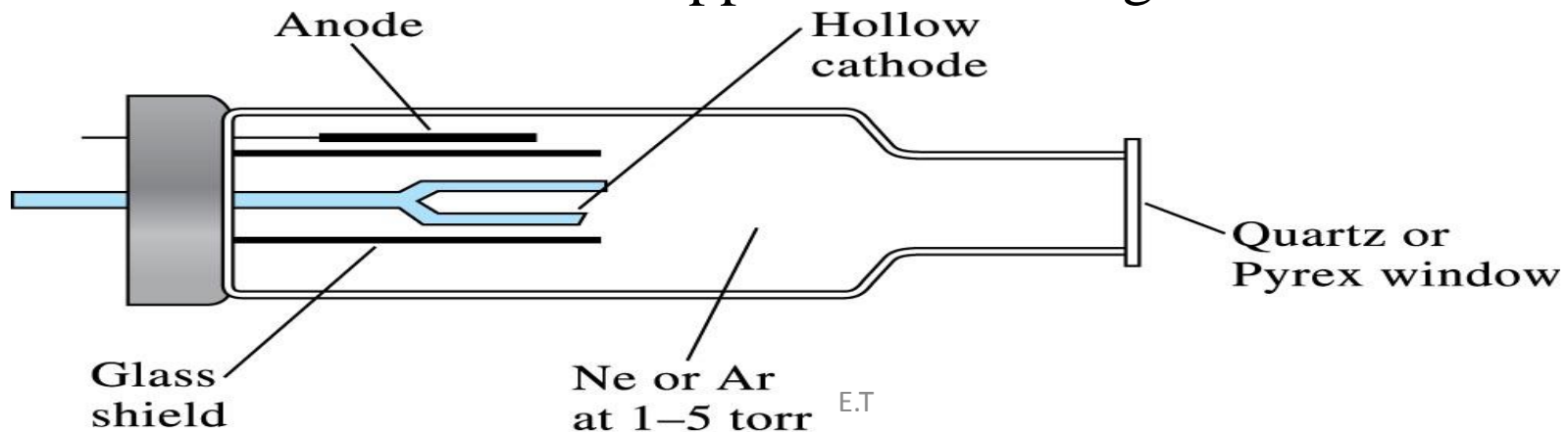

CELLS

UV Spectrophotometer

Quartz (crystalline silica)

Visible Spectrophotometer

Glass

IR Spectrophotometer

NaCl

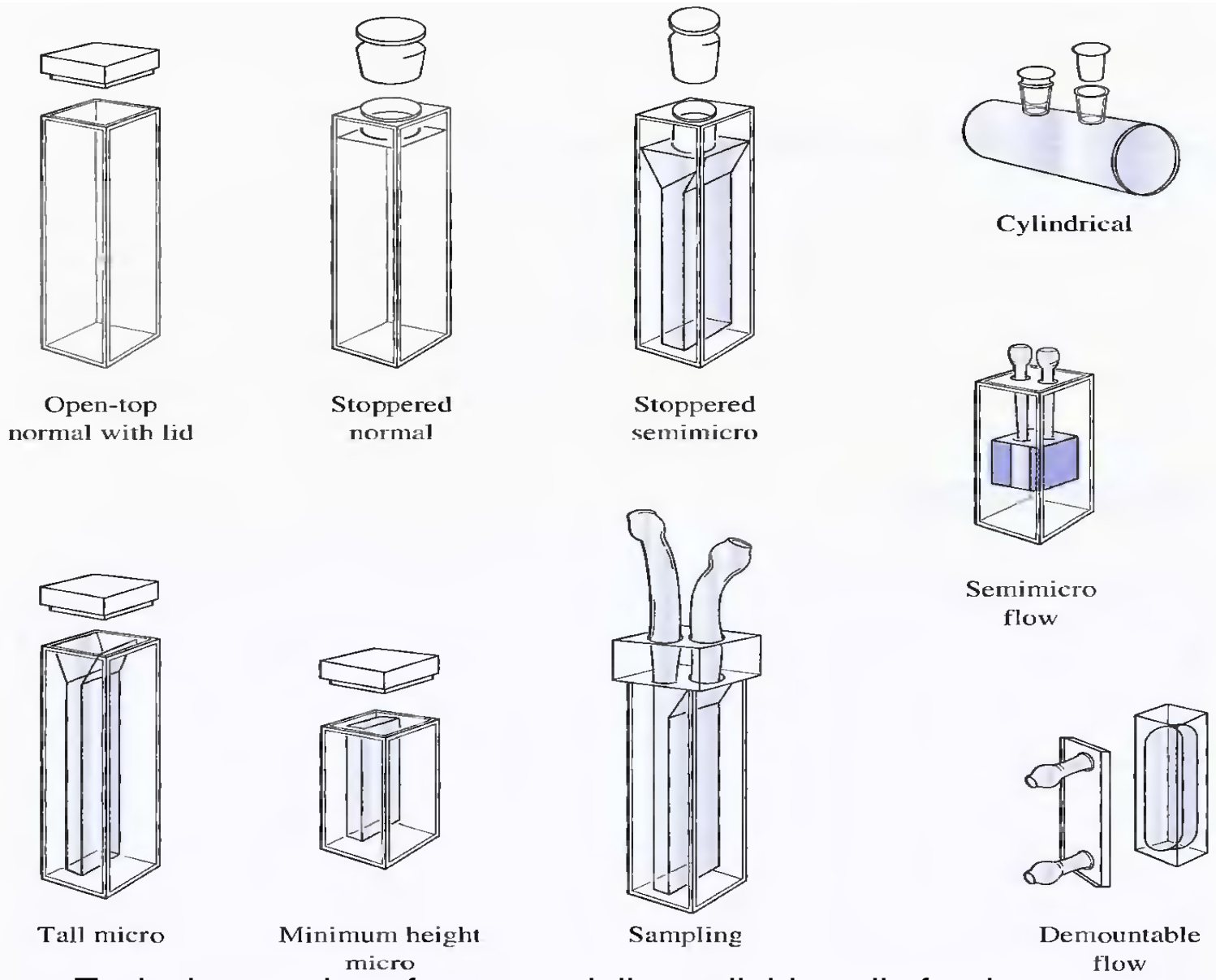
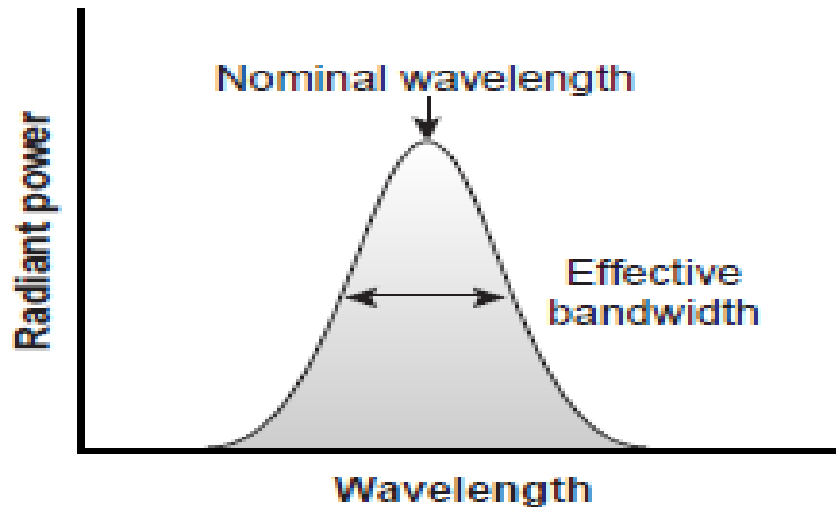

Figure Typical examples of commercially available cells for the UV/visible region.

- **Wavelength Selection**
- Spectroscopic instruments generally required a device that restricts the wavelength that is to be used to narrow band that is absorbed or emitted by the analyte.
 - Such device enhance selectivity and sensitivity of an instrument
- For absorption measurement, narrow bandwidths increase the likelihood of adherence to Beer's law.
- For this reason we usually try to select a single wavelength where the analyte is the only absorbing species.
 - Unfortunately, we cannot isolate a single wavelength of radiation from a continuum source.
- Instead, a wavelength selector passes a narrow band of radiation characterized by
 - a **nominal wavelength**, an **effective bandwidth**, and a maximum throughput of radiation.



- The **effective bandwidth** is defined as the width of the radiation at half the maximum throughput.
- The ideal wavelength selector has a high throughput of radiation and a narrow effective bandwidth.
 - A high throughput is desirable because more photons pass through the wavelength selector, giving a stronger signal with less background noise.
- A narrow effective bandwidth provides a higher **resolution**, with spectral features separated by more than twice the effective bandwidth being resolved.

- Generally these two features of a wavelength selector are in opposition
- Conditions favouring a higher throughput of radiation usually provide less resolution.
- Decreasing the effective bandwidth improves resolution, but at the cost of a noisier signal.
- For a qualitative analysis, resolution is generally more important than the throughput of radiation; thus,
 - smaller effective bandwidths are desirable.
- In a quantitative analysis a higher throughput of radiation is usually desirable

- **Wavelength Selection Using Filters**

- The simplest method for isolating a narrow band of radiation is to use an absorption or interference filter.

- **Absorption filters**

- work by selectively absorbing radiation from a narrow region of the electromagnetic spectrum .
 - Limited application to visible region.
- A simple example of an absorption filter usually consist of a colored glass plate that removes part of incident radiation by absorption.
 - A purple filter, for example, removes the complementary color green from 500–560 nm.
 - Commercially available absorption filters provide effective bandwidths from 30–250 nm.
- Interference filters are more expensive than absorption filters, but have narrower effective bandwidths, typically 10–20 nm, with maximum throughputs of ^{ET}at least 40%.

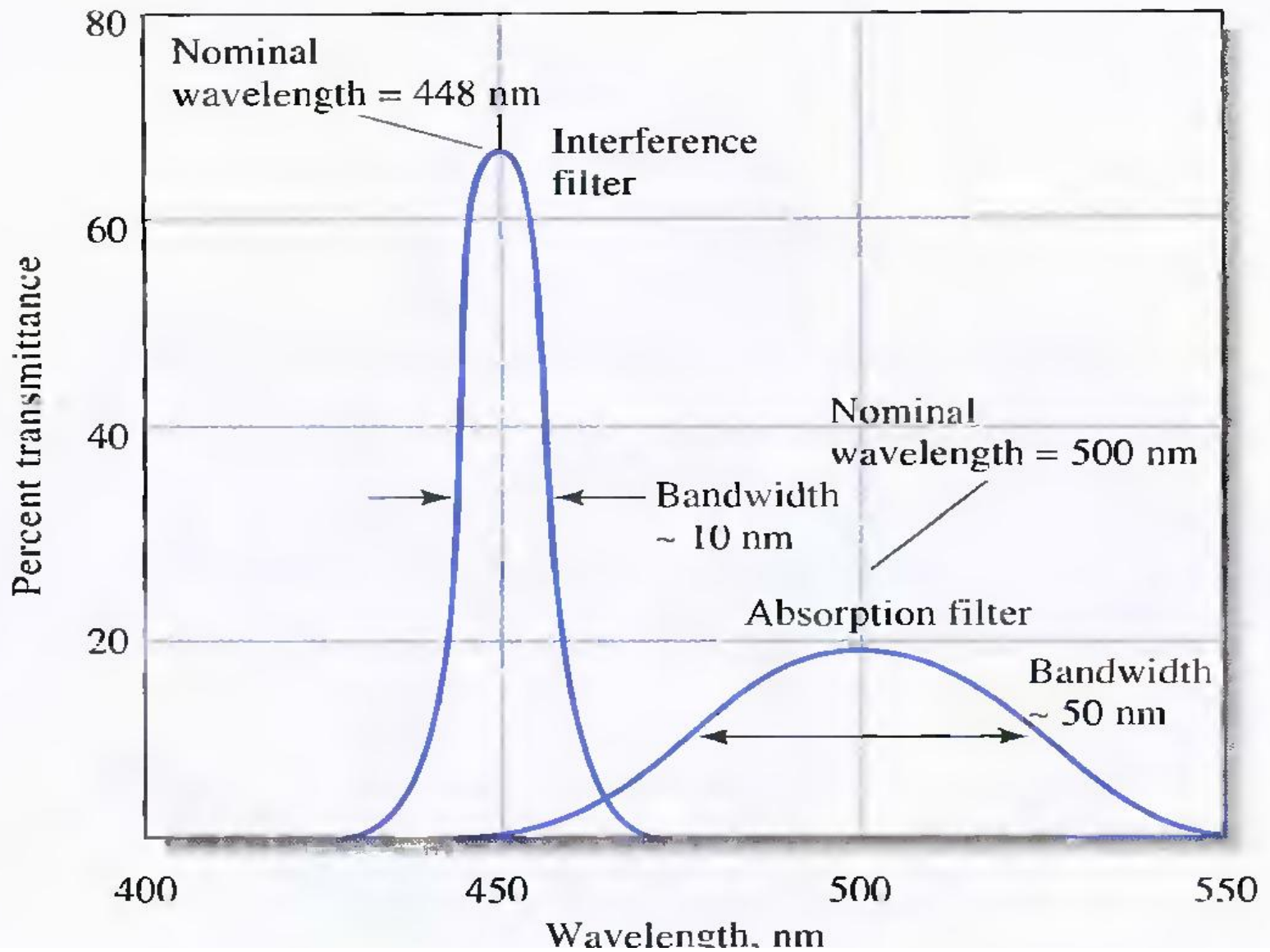

- **Wavelength Selection Using Monochromators**
- One limitation of an absorption or interference filter is that they do not allow for a continuous selection of wavelength.
- If measurements need to be made at two wavelengths, then the filter must be changed in between measurements.
- A further limitation is that filters are available for only selected nominal ranges of wavelengths.
- An alternative approach to wavelength selection, which provides for a continuous variation of wavelength, is the
 - **monochromator**
- Monochromators for ultraviolet, visible, and infrared radiation are all similar in mechanical construction in the sense that they employ slits, lenses, mirrors, windows, and prisms or gratings.

- **Components of Monochromator**
- All monochromators contain an entrance slit, a collimating lens or mirror to produce a parallel beam of radiation, a prism or grating as a dispersing element and a focusing element,
- which projects a series of rectangular images of the entrance slit upon a plane surface (the *focal plane*).

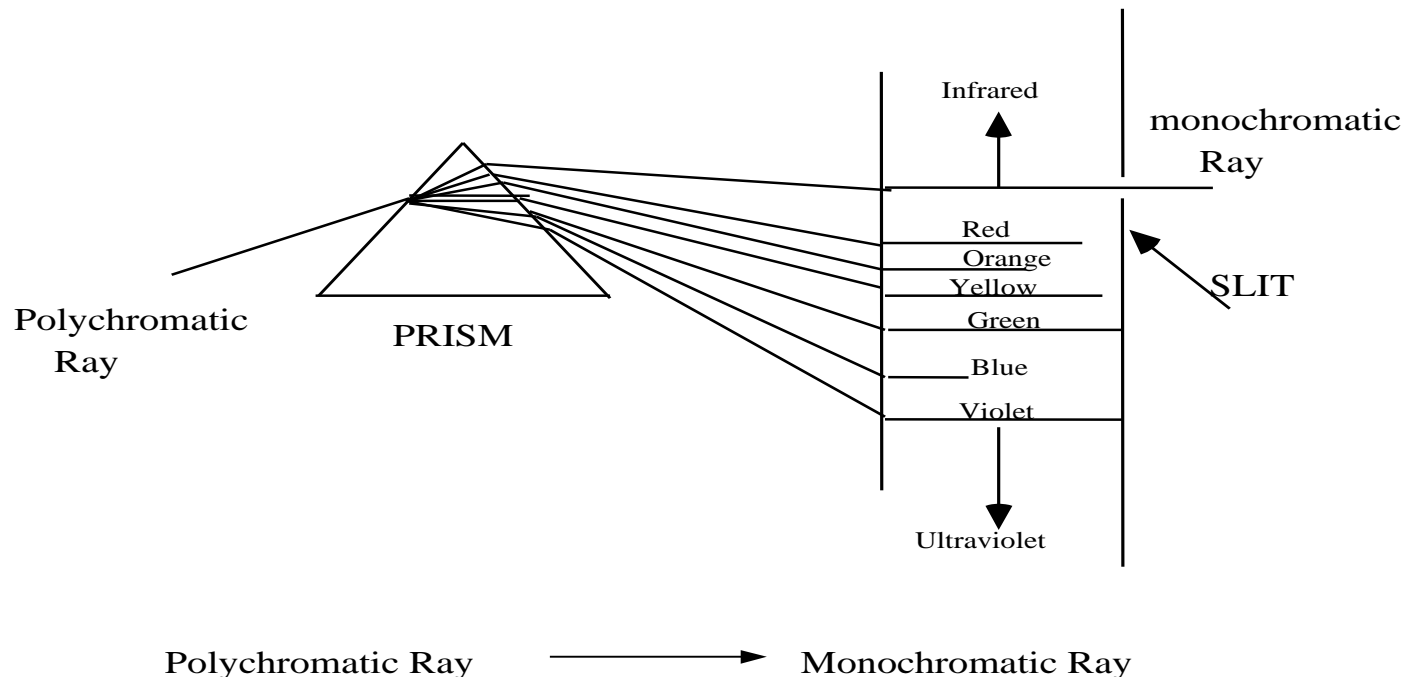

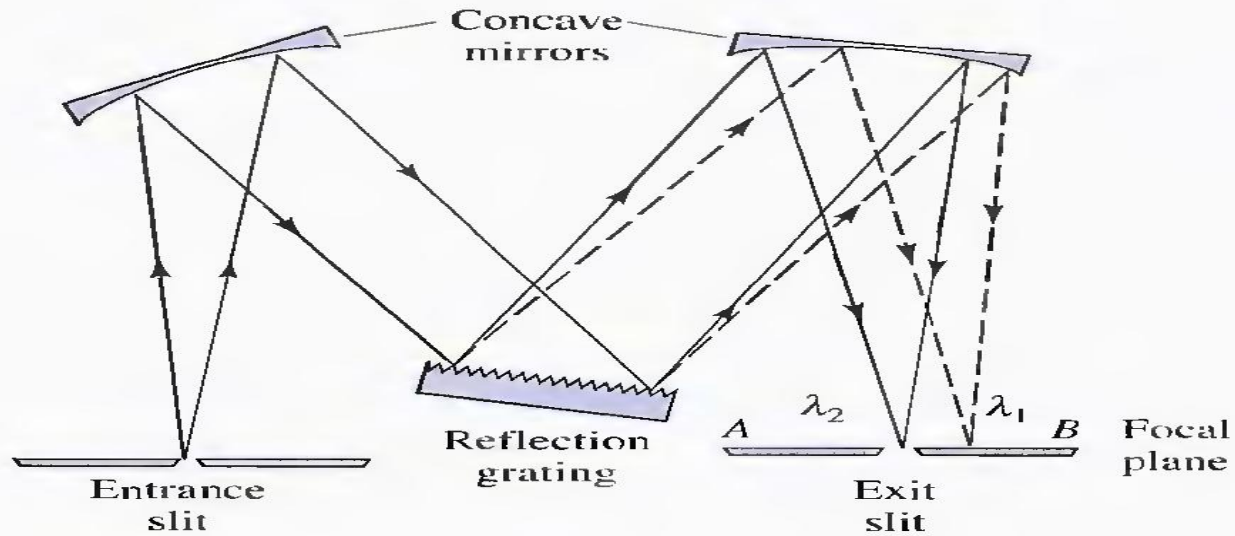

(a)

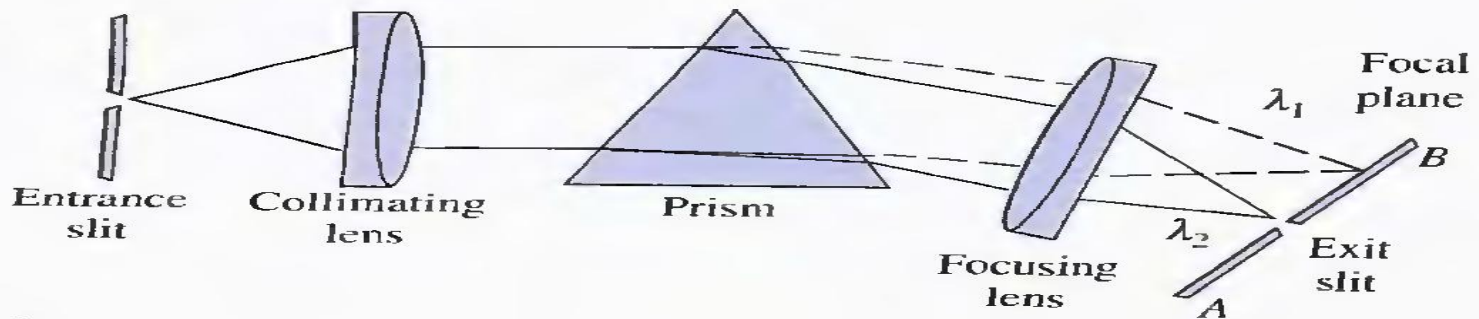

(b)

Figure Types of monochromators: (a) grating monochromator: (b) prism monochromator. The monochromator design in (a) is a Czerny- Turner design. while the prism monochromator in (b) is a Bunsen design. In both cases, , $\lambda_1 > \lambda_2$

- A source of radiation containing two wavelengths, λ_1 and λ_2 , is shown for purposes of illustration.
- This radiation enters the monochromators via a narrow rectangular opening or slit, is collimated, and then strikes the surface of the dispersing element at an angle.
- In the prism monochromator, refraction at the two faces results in angular dispersal of the radiation, as shown;
- for the grating, angular dispersion results from diffraction, which occurs at the reflective surface.
- In both designs, the dispersed radiation is focused on the focal plane AB where it appears as two "images of the entrance slit (one for each wavelength).

- **Radiation detectors and Transducers**
- A **detector** is a device that indicates the existence of some physical phenomenon.
- Photographic film indicating presence of EMR ,pointer of balance indicating mass d/n, mercury level in thermometer indicating temperature change.
 - Early instruments for the measurement of emission and absorption of radiation required visual or photographic methods for detection.
- A **transducer** is a special type of detector that converts signals, such as light intensity, pH, mass and temperature into electrical signals that can be subsequently amplified,
- manipulated and finally converted into numbers that are related to the magnitude of the original signal.

- **Properties of Transducers**

- To be useful the detector must respond rapidly to low levels of radiant energy over a broad wavelength range.
- produce an electrical signal that can be readily amplified, and have a relatively low noise level (for stability).
- Finally, it is essential that the signal produced be directly proportional to the beam power P ; that is,

$$G = KP + K'$$

- where G is the electrical response of the detector in units of current, resistance, or potential. The constant K measures the sensitivity of the detector in terms of electrical response per unit of radiant power.
- Many detectors exhibit a small constant response known as a *dark current* K' . even when no radiation impinges on their surfaces.

Types of Transducers

As indicated in Table, 10.4 two general types of radiation transducers are employed; one responds to photons, the other to heat.

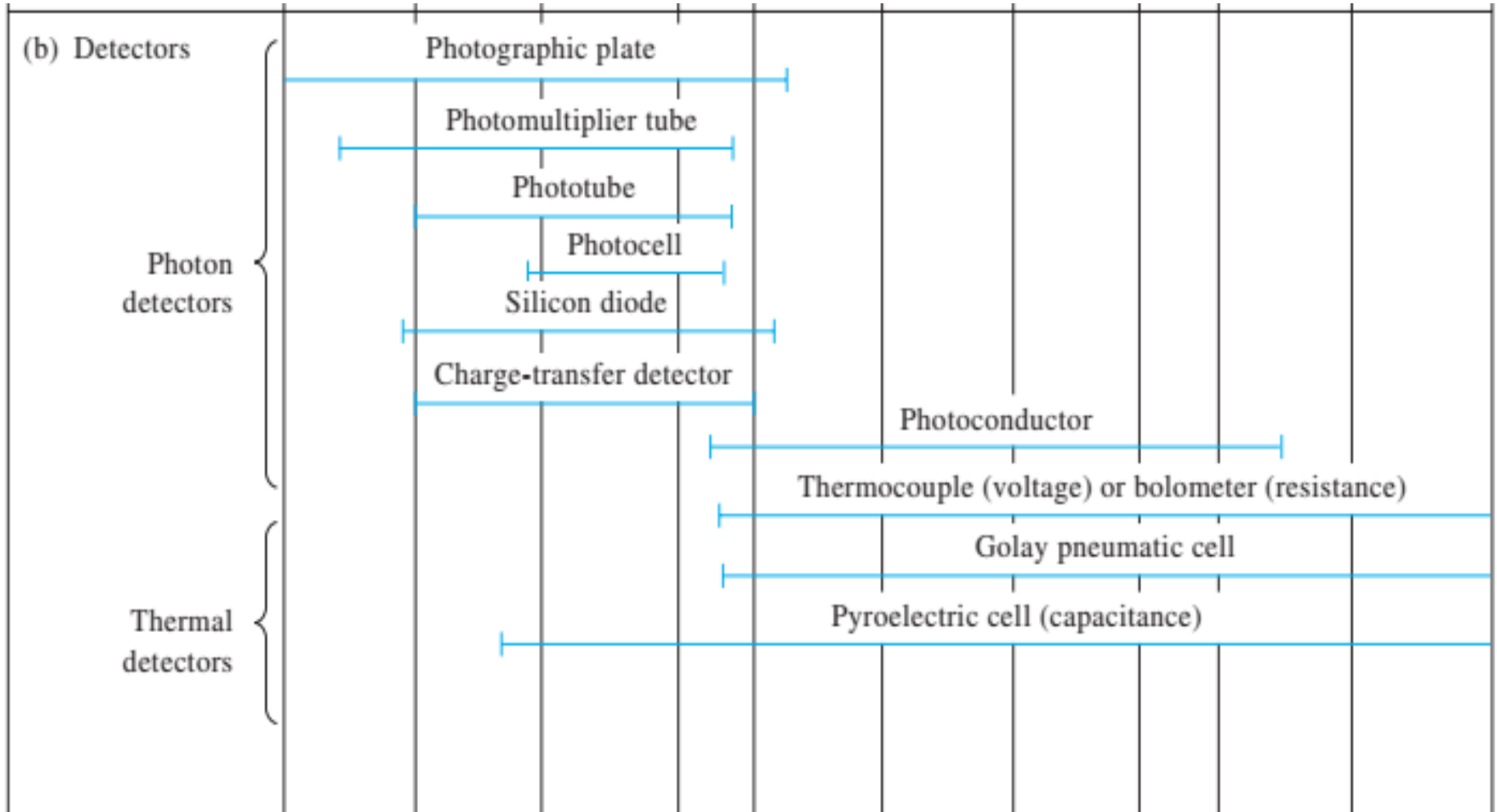

- All photon detectors are based upon interaction of radiation with a reactive surface to produce electrons (photoemission) or
- to promote electrons to energy states in which they can conduct electricity (photoconduction).
- Only ultraviolet, visible, and near-infrared radiations have sufficient energy to cause these processes to occur.
- Photoelectric detectors also differ from heat detectors in that their electrical signal results from a series of individual events (absorption of one photon).

- **Photon Detectors**

- Several types of photon detectors are available. including:
 - *photovoltaic cells, phototubes, photomultiplier tubes, semiconductor detectors, silicon diodes and charge –transfer device*

- **Phototubes**

- which consists of a semi cylindrical cathode and a wire anode sealed inside an evacuated transparent envelope.
- The concave surface of the electrode supports a layer of photoemissive material that tends to emit electrons upon being irradiated.
- When a potential is applied across the electrodes, the emitted electrons flow to the wire anode, generating a photocurrent.
- The currents produced are generally about one-tenth as great as those from a photovoltaic cell for a given radiant intensity.

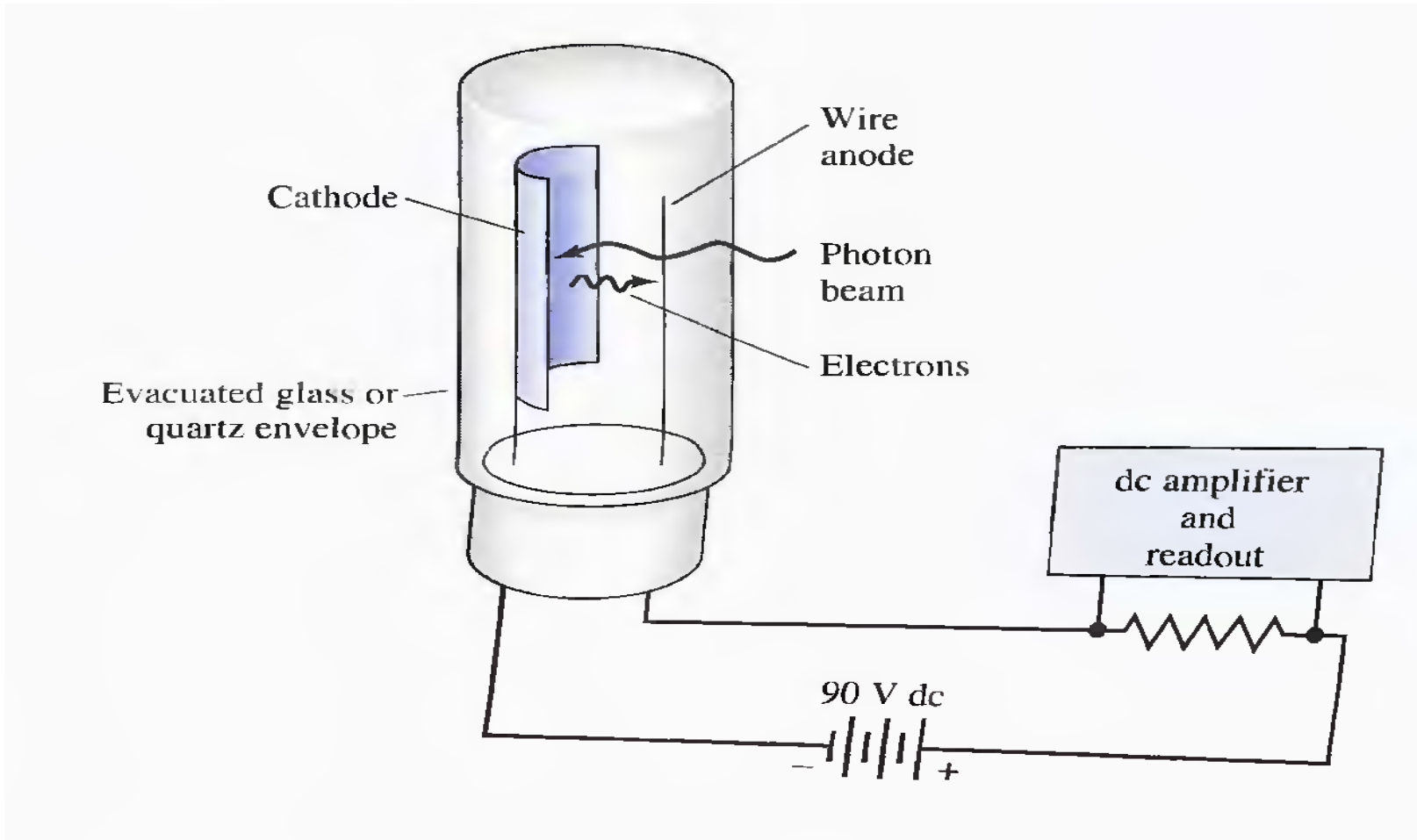

Figure A phototube and accompanying circuit. The photocurrent induced by the radiation causes a voltage across the measuring resistor: this voltage is then amplified and measured.

- The number of electrons ejected from a photoemissive surface is directly proportional to the radiant power of the beam striking that surface.
- As the potential applied across the two electrodes of the tube is about 90 V, the fraction of the emitted electrons reaching the anode to give current that is proportional to the radiant power.
- **Assignment Discuss in detail for the remaining four type of detectors**

- **Heat detector**
- Infrared radiation generally does not have sufficient energy to produce a measurable current when using a photon transducer.
 - A heat detector, therefore, is used for infrared spectroscopy.
- The absorption of infrared photons by a heat detector increases its temperature, changing one or more of its characteristic properties.
- The pneumatic transducer, for example consists of a small tube filled with xenon gas equipped with an IR-transparent window at one end, and a flexible membrane at the other end.
- A blackened surface in the tube absorbs photons, increasing the temperature and, therefore, the pressure of the gas.
- The greater pressure in the tube causes the flexible membrane to move in and out, and this displacement is monitored to produce an electrical signal.

- **SIGNAL PROCESSORS AND READOUTS**
- The **signal processor** is ordinarily an electronic device that amplifies the electrical signal from the detector; in addition, it may alter the signal from dc to ac (or the reverse)
 - change the phase of the signal, and filter it to remove unwanted components.
- Furthermore, the signal processor may be called upon to perform such mathematical operations on the signal as differentiation integration, or conversion to a logarithm.

Chapter Four

Atomic Absorption and Emission Spectroscopy

ATOMIC SPECTROSCOPY

- Elemental analysis at the trace or ultratrace level can be performed by a number of analytical techniques; however, atomic spectroscopy remains the most popular approach.
- Atomic spectroscopy can be subdivided into three fields:
 - Atomic emission spectroscopy (AES),
 - Atomic absorption spectroscopy (AAS), and
 - Atomic fluorescence spectroscopy (AFS)
- that differ by the mode of excitation and the method of measurement of the atom concentrations.

- The selection of the atomic spectroscopic technique to be used for a particular application should be based on the desired result, since each technique involves different measurement approaches.
- AES excites ground-state atoms and then quantifies the concentrations of excited-state atoms by monitoring their special deactivation.
- AAS measures the concentrations of ground-state atoms by quantifying the absorption of spectral radiation that corresponds to allowed transitions from the ground to excited states.
- AFS determines the concentrations of ground-state atoms by quantifying the radiative deactivation of atoms that have been excited by the absorption of discrete spectral radiation.

TABLE 28-1
Classification of Atomic Spectroscopic Methods

Atomization Method	Typical Atomization Temperature, °C,	Types of Spectroscopy	Common Name and Abbreviation
Inductively coupled plasma	6000–8000	Emission	Inductively coupled plasma atomic emission spectroscopy, ICPAES
		Mass	Inductively coupled plasma mass spectrometry, ICP-MS
Flame	1700–3150	Absorption	Atomic absorption spectroscopy, AAS
		Emission	Atomic emission spectroscopy, AES
		Fluorescence	Atomic fluorescence spectroscopy, AFS
Electrothermal	1200–3000	Absorption	Electrothermal AAS
		Fluorescence	Electrothermal AFS
Direct-current plasma	5000–10,000	Emission	DC plasma spectroscopy, DCP
Electric arc	3000–8000	Emission	Arc-source emission spectroscopy
Electric spark	Varies with time and position	Emission	Spark-source emission spectroscopy
		Mass	Spark-source mass spectroscopy

Flame Atomic Emission Spectroscopy

- Introduction Flame photometry, now more properly called flame atomic emission spectrometry, is a relatively old instrumental analysis method.
- Atomic emission is a fast, simple, and sensitive method for the determination of trace metal ions in solution.
- Because of the very narrow (ca. 0.01 nm) and characteristic emission lines from the gas-phase atoms in the flame plasma, the method is relatively free of interferences from other elements.
- The method is suitable for many metallic elements, especially for those metals that are easily excited to higher energy levels at the relatively cool temperatures of typical flames – Na, K, Ca, Rb, Cs, Cu, and Ba.

Theory

- Sample solution sprayed or aspirated as fine mist into flame.
- Conversion of sample solution into an aerosol by atomizer (scent spray) principle.
 - in this stage no chemical change in the sample
- Heat of the flame vaporizes sample constituents
 - Solvent vaporizes leaves solid partial of salt
- By heat of the flame + action of the reducing gas (fuel), molecules & ions of the sample species are decomposed and reduced to give ATOMS.
 - eg $\text{Na}^+ + \text{e}^- \rightarrow \text{Na}$
- Heat of the flame causes excitation of some atoms into higher electronic states.
- Excited atoms revert to ground state by emission of light energy, of characteristic wavelength; measured by detector.

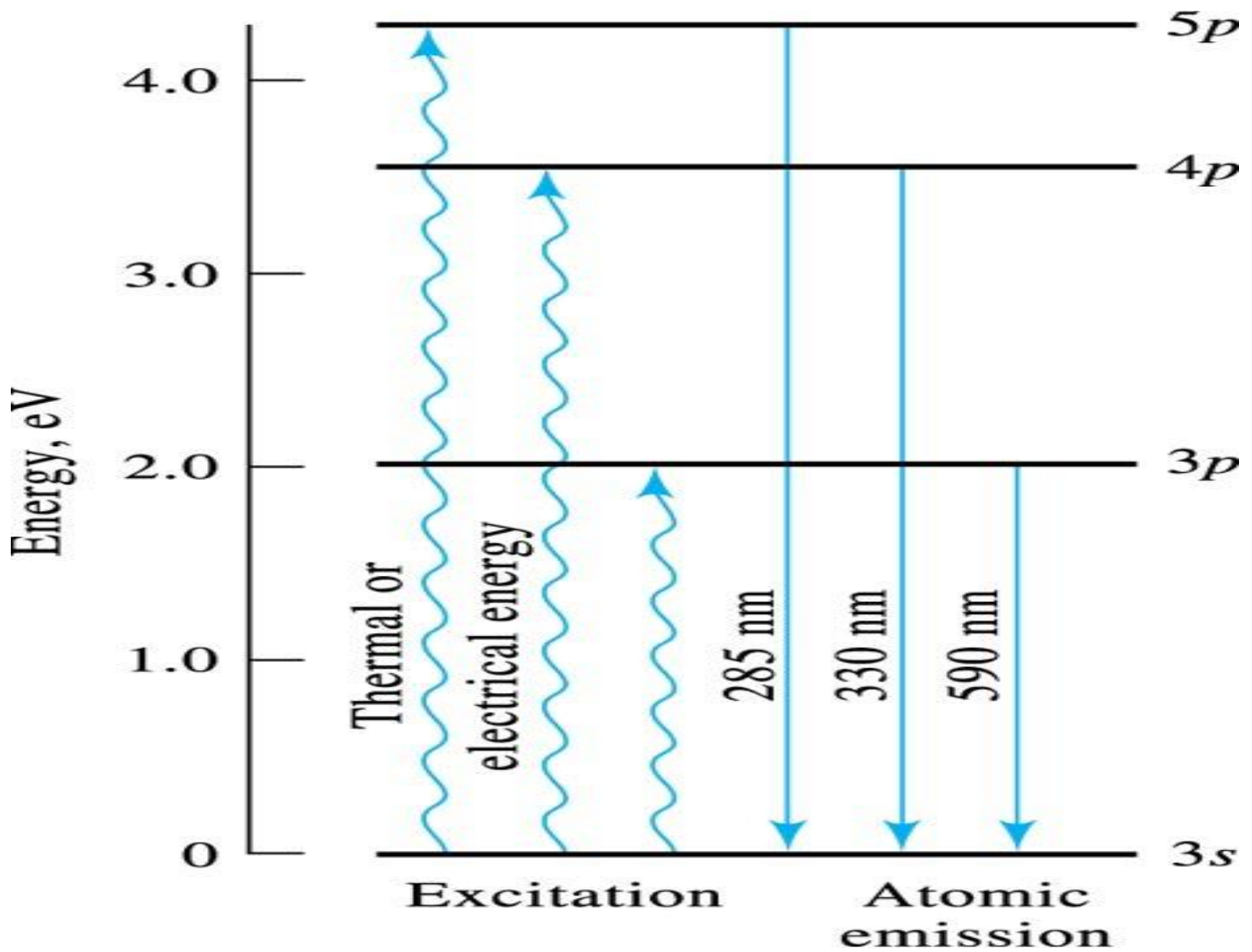

- Flame Emission -> it measures the radiation emitted by the excited atoms that is related to concentration.
- Atomic Absorption -> it measures the radiation absorbed by the unexcited atoms that are determined.
- Atomic absorption depends only upon the number of unexcited atoms, the absorption intensity is not directly affected by the temperature of the flame.
- The flame emission intensity in contrast, being dependent upon the number of excited atoms, is greatly influenced by temperature variations.

Instrumentation:

- Flame photometer consists of following components:
- Pressure regulators and flow meters for fuel gases
- Flame source
- The atomizing device
- Wavelength selectors: May be a filter or Monochromator
- Photosensitive detectors
- Read out unit.

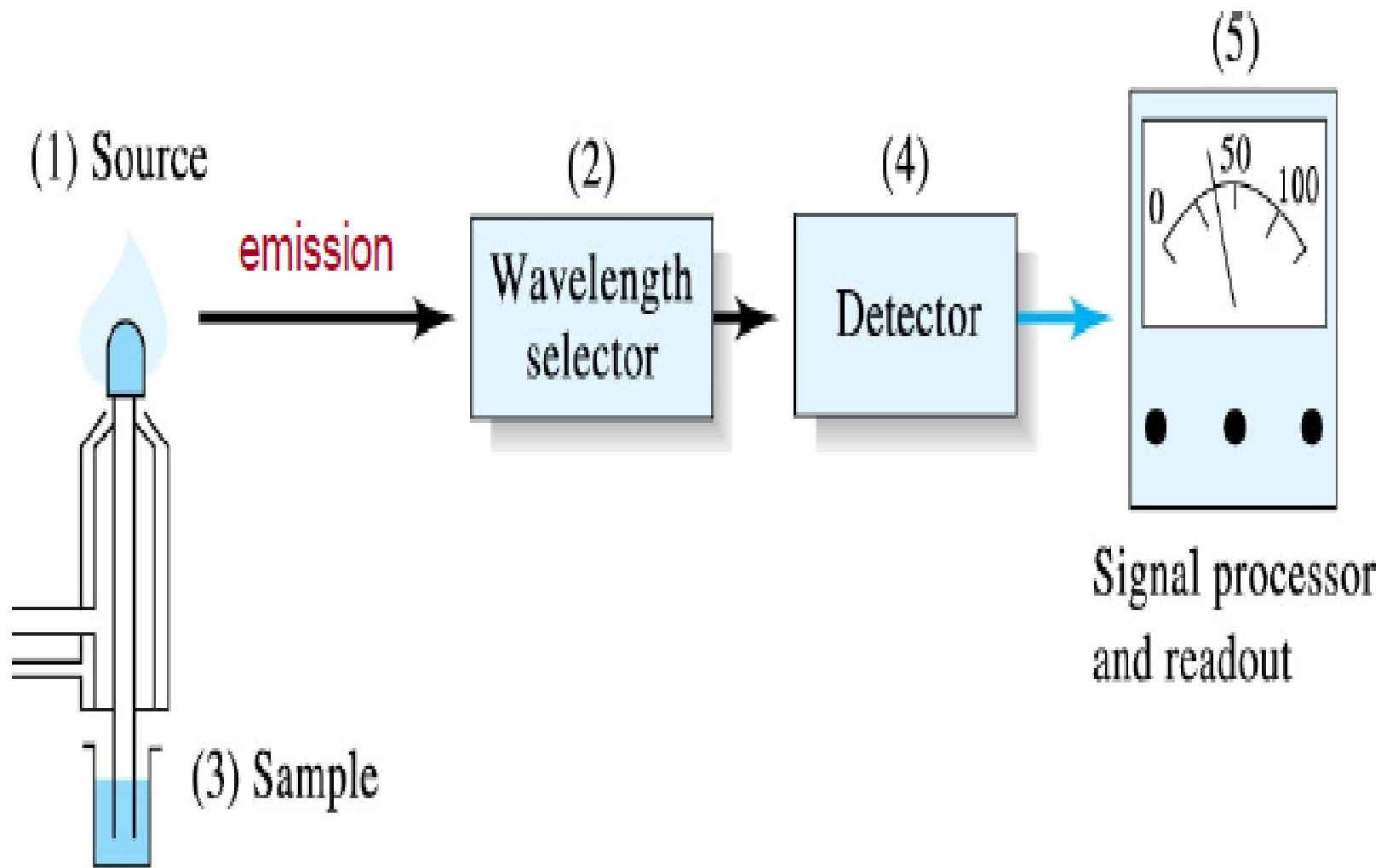

© 2004 Thomson - Brooks/Cole



- **Requirements of flame:**
- It should have proper temperature
- Temp. should remain constant throughout operation.
- There should not be any fluctuation during burning.
- Function flame includes:
 - To convert the constituent of the liquid sample in to vapor state.
 - To decompose the constituent into atoms or simple molecules.
 - To electronically excite a fraction of the resulting atomic or molecular spectra.

- Transformation of sample into vapour
- With a pneumatic nebulizer operated by a compressed gas, the solution is aspirated from the sample container and nebulized into a mist or aerosol of fine droplets.
- By desolvation, i.e., evaporation of the solvent from the droplets, this mist is converted into a dry aerosol which is volatilized in the flame.
- The atomization, i.e., the conversion of volatilized analyte into free atoms is performed by the flame or other atomizer.

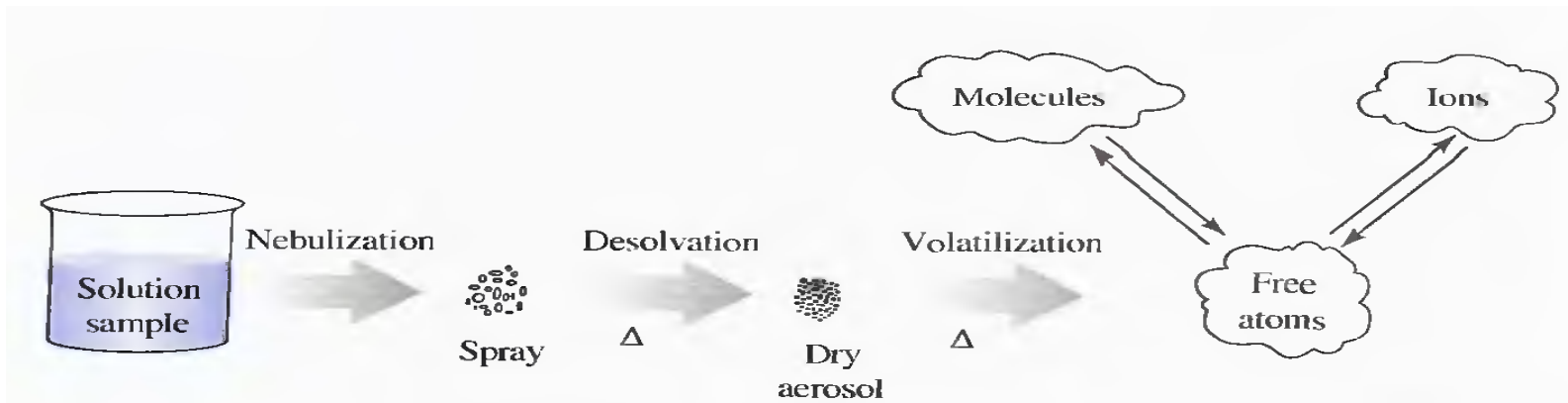

- **Nebulizers used in flame photometer**
- According to the source of energy used for nebulization as, for example, Pneumatic or ultrasonic nebulizers.
- According to the relative position of the capillaries for the nebulizing gas and the aspirated liquid, e.g., angular and concentric nebulizers

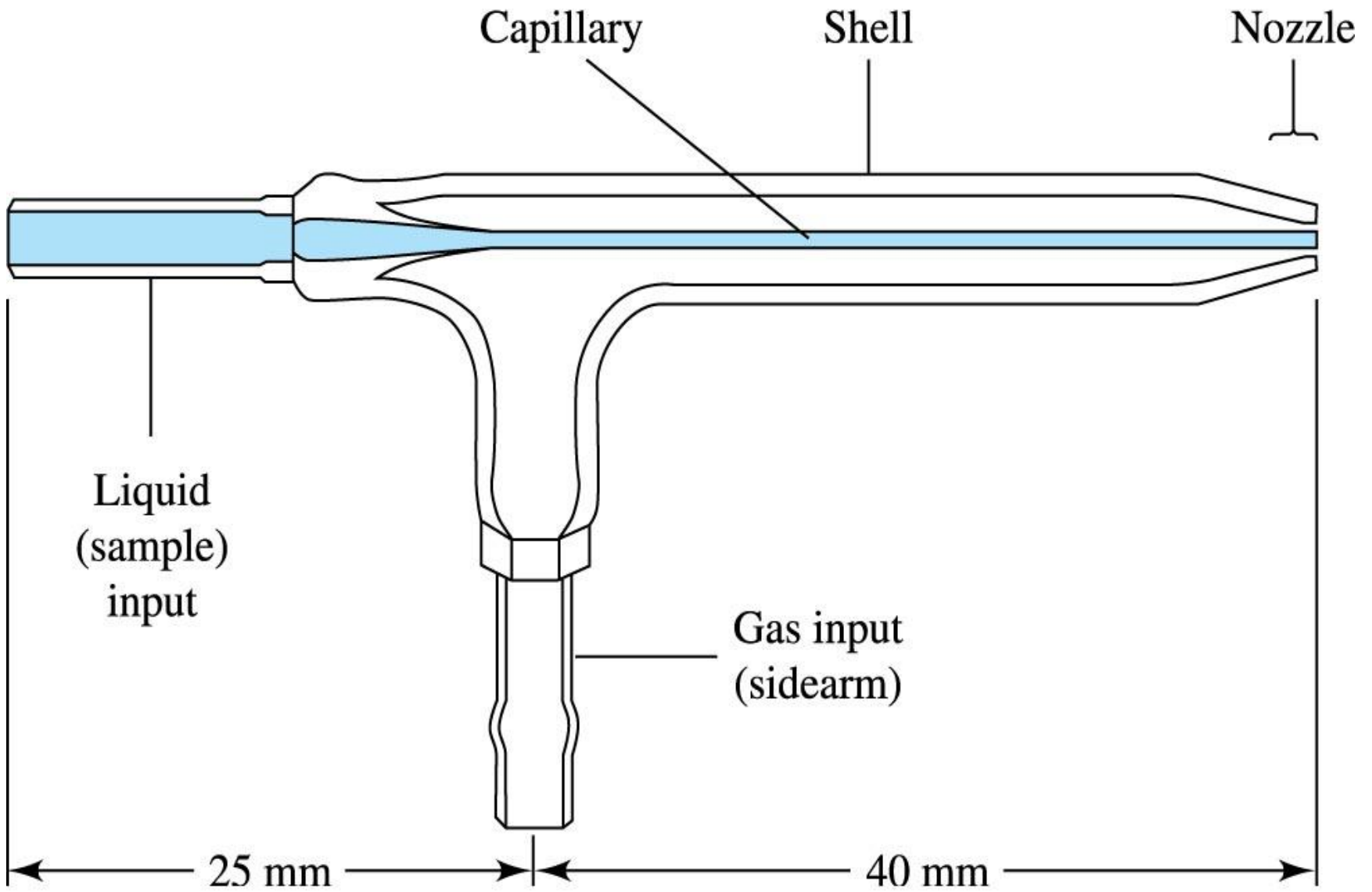

- **Burners**
- Flames are produced by means of a burner to which fuel and oxidant are supplied in the form of gases.
- With the premix burner, fuel and oxidant are thoroughly mixed inside the burner housing before they leave the burner ports and enter the primary combustion or inner zone of the flame.
- This type of burner usually produces an approximately laminar flame, and is commonly combined with a separate unit for nebulizing the sample.
- The direct-injection burner combines the function of nebulizer and burner.

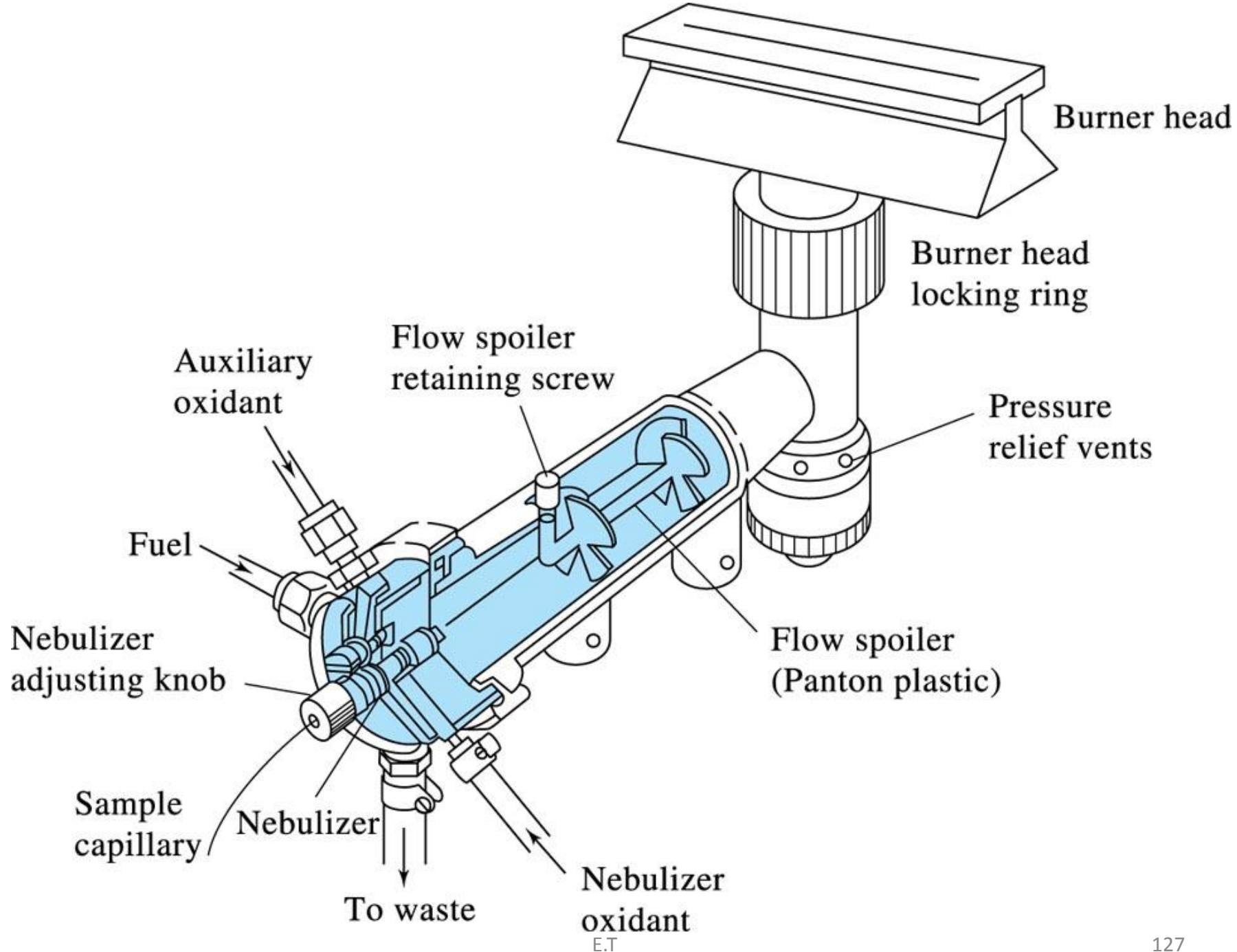

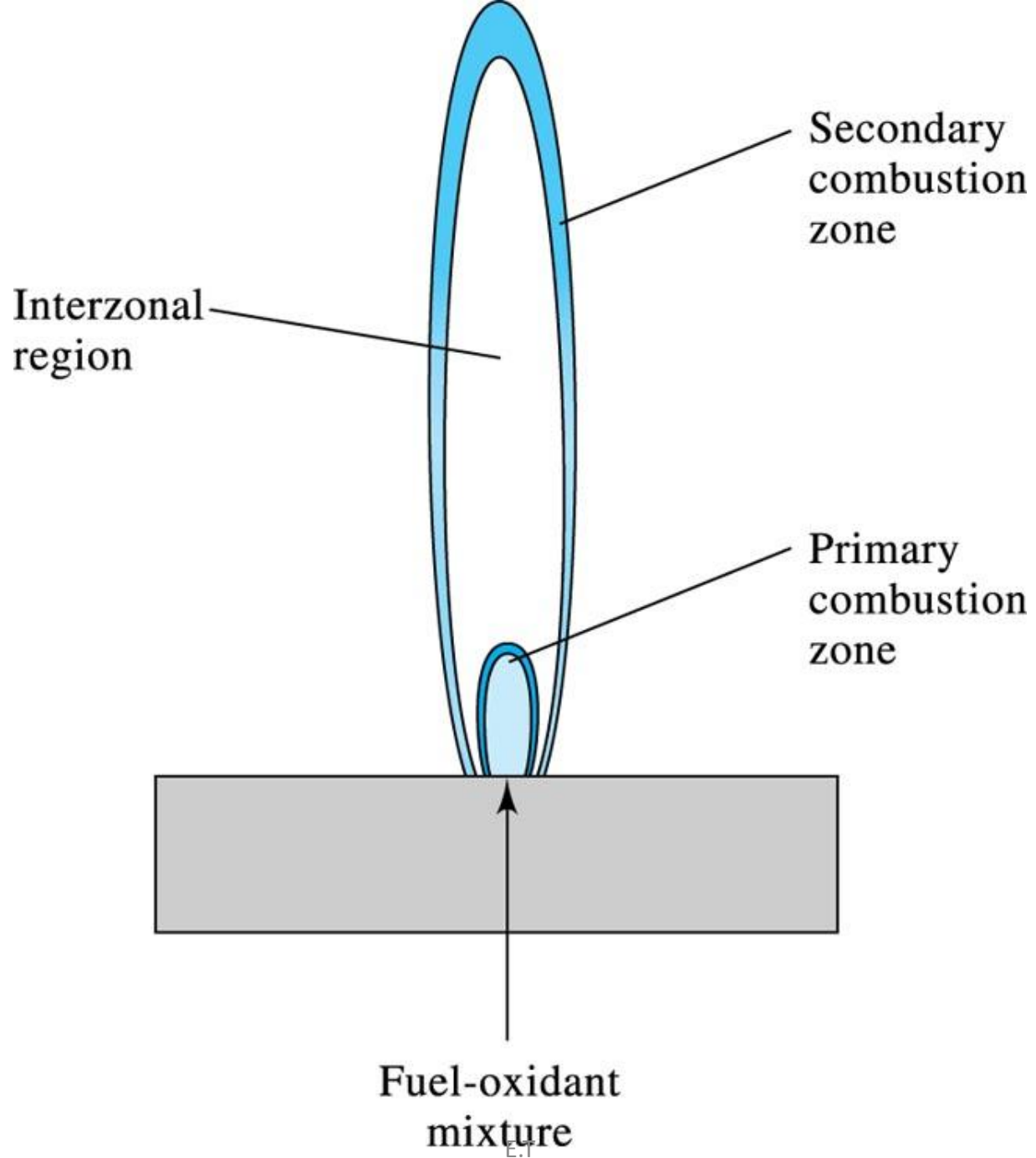

- Thermal energy in flame atomization is provided by the combustion of a fuel–oxidant mixture.
- Common fuels and oxidants and their normal temperature ranges are listed in Table 28.2. Of these, the air–acetylene and nitrous oxide-acetylene flames are used most frequently.

TABLE 28-2

Flames Used in Atomic Spectroscopy

Fuel and Oxidant	Temperature, °C
*Gas/Air	1700–1900
*Gas/O ₂	2700–2800
H ₂ /air	2000–2100
H ₂ /O ₂	2500–2700
†C ₂ H ₂ /air	2100–2400
†C ₂ H ₂ /O ₂	3050–3150
†C ₂ H ₂ /N ₂ O	2600–2800

*Propane or natural gas

†Acetylene

- **Flame temperature:**
- The optimum flame temp. depends upon several factors as excitation energy of the element, sensitivity of the measurement, Presence of other elements etc.
- The temp. of flame lies between 1000°C and 3000°C .
- Mixture of coal gas and air do not give very hot flames, because of presence of nitrogen.
- The cyanogens gas produces excellent spectra but it is toxic.
- Acetylene and hydrogen are most frequent choice

Atomic Absorption Spectroscopy (AAS)

- Atomic absorption spectroscopy is a quantitative method of analysis that is applicable to many metals and a few nonmetals.
- The technique was introduced in 1955 by Walsh in Australia (A. Walsh, Spectrochim. Acta, 1955, 7, 108)
- A much larger number of the gaseous metal atoms will normally remain in the ground state.
- These ground state atoms are capable of absorbing radiant energy of their own specific resonance wavelength.
- If light of the resonance wavelength is passed through a flame containing the atoms in question, then part of the light will be absorbed.
- The extent of absorption will be proportional to the number of ground state atoms present in the flame.

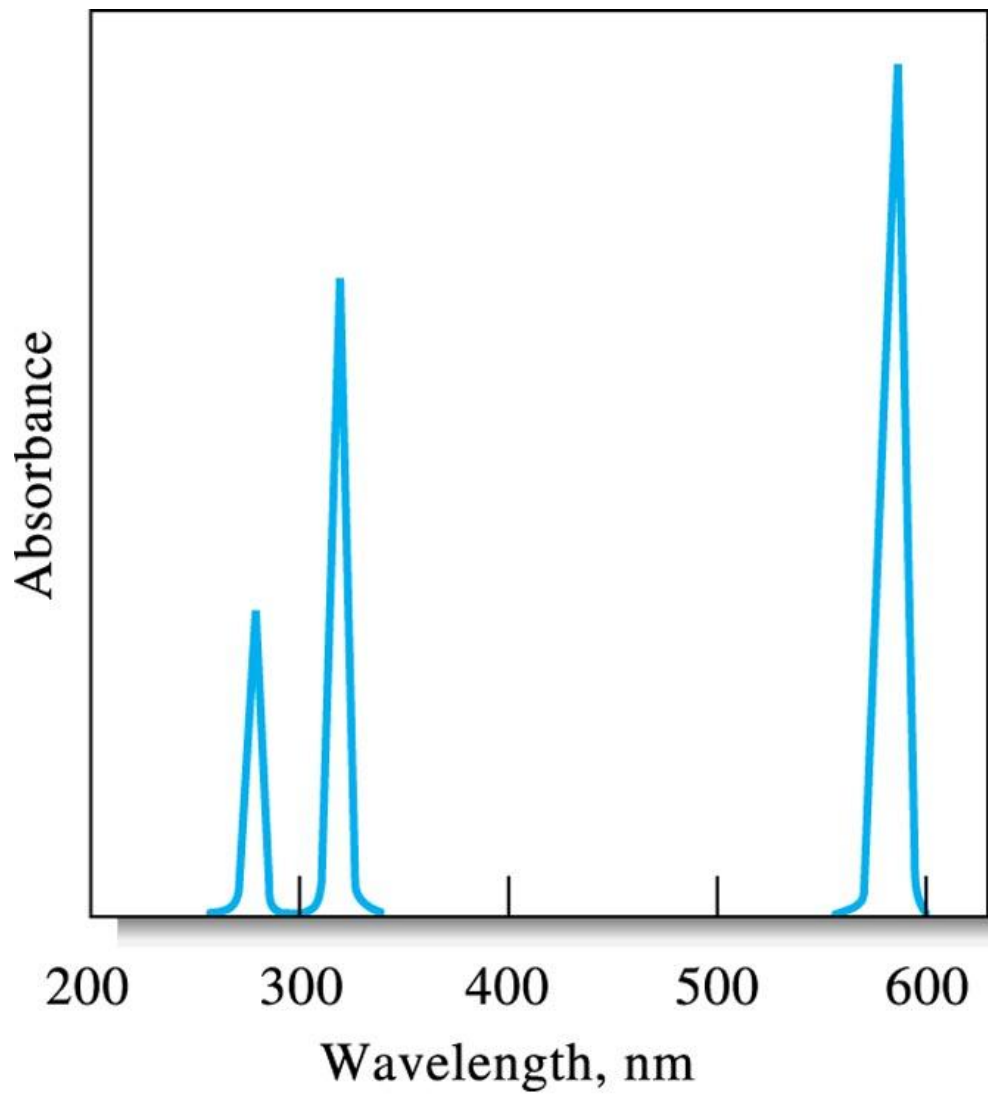
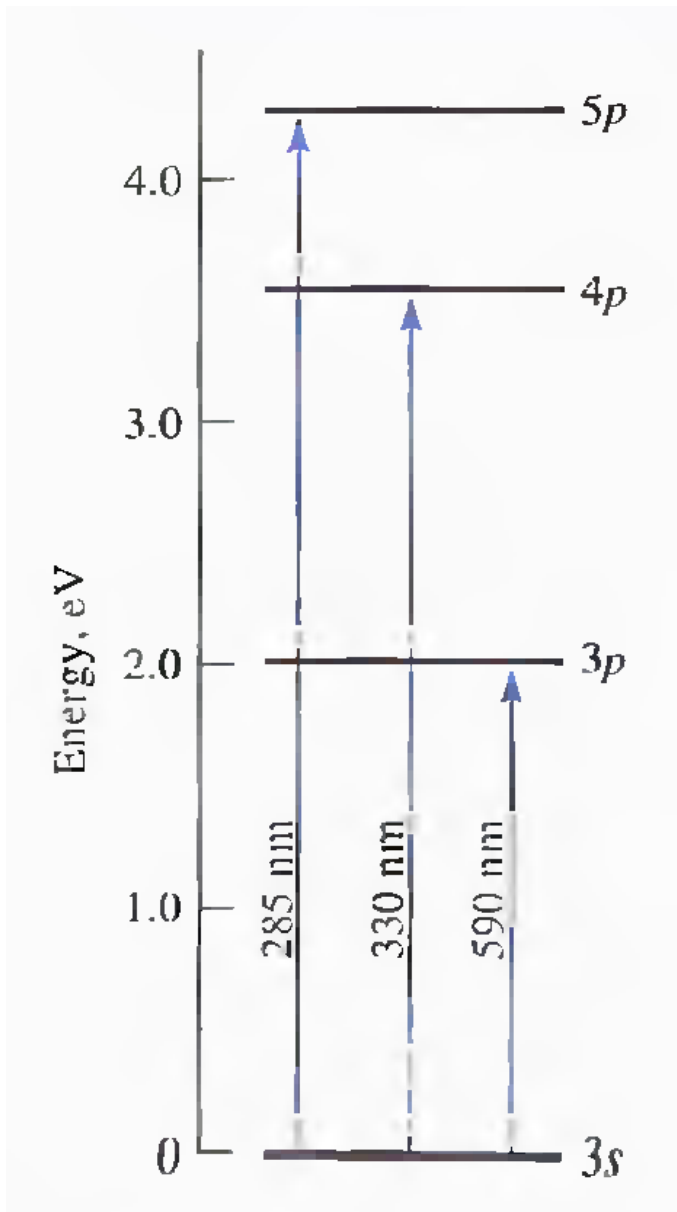

© 2004 Thomson - Brooks/Cole

Absorption of light and what is colour?

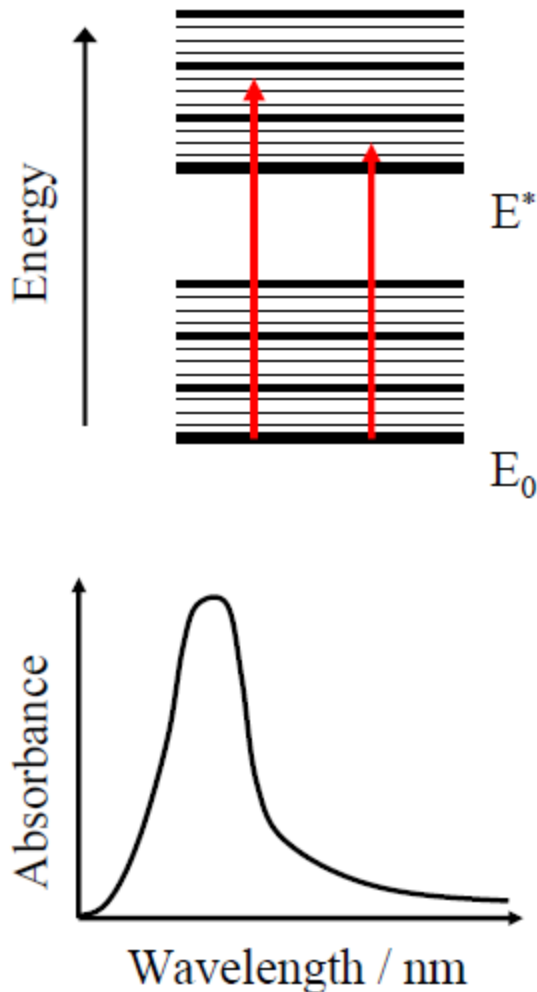

Wavelength of maximum absorption (nm)	Colour absorbed	Colour observed
380-420	Violet	Green-Yellow
420-440	Violet-Blue	Yellow
440-470	Blue	Orange
470-500	Blue-Green	Red
500-520	Green	Purple
520-550	Yellow-Green	Violet
550-580	Yellow	Violet-Blue
580-620	Orange	Blue
620-680	Red	Blue-Green
680-780	Purple	Green

Instrumentation

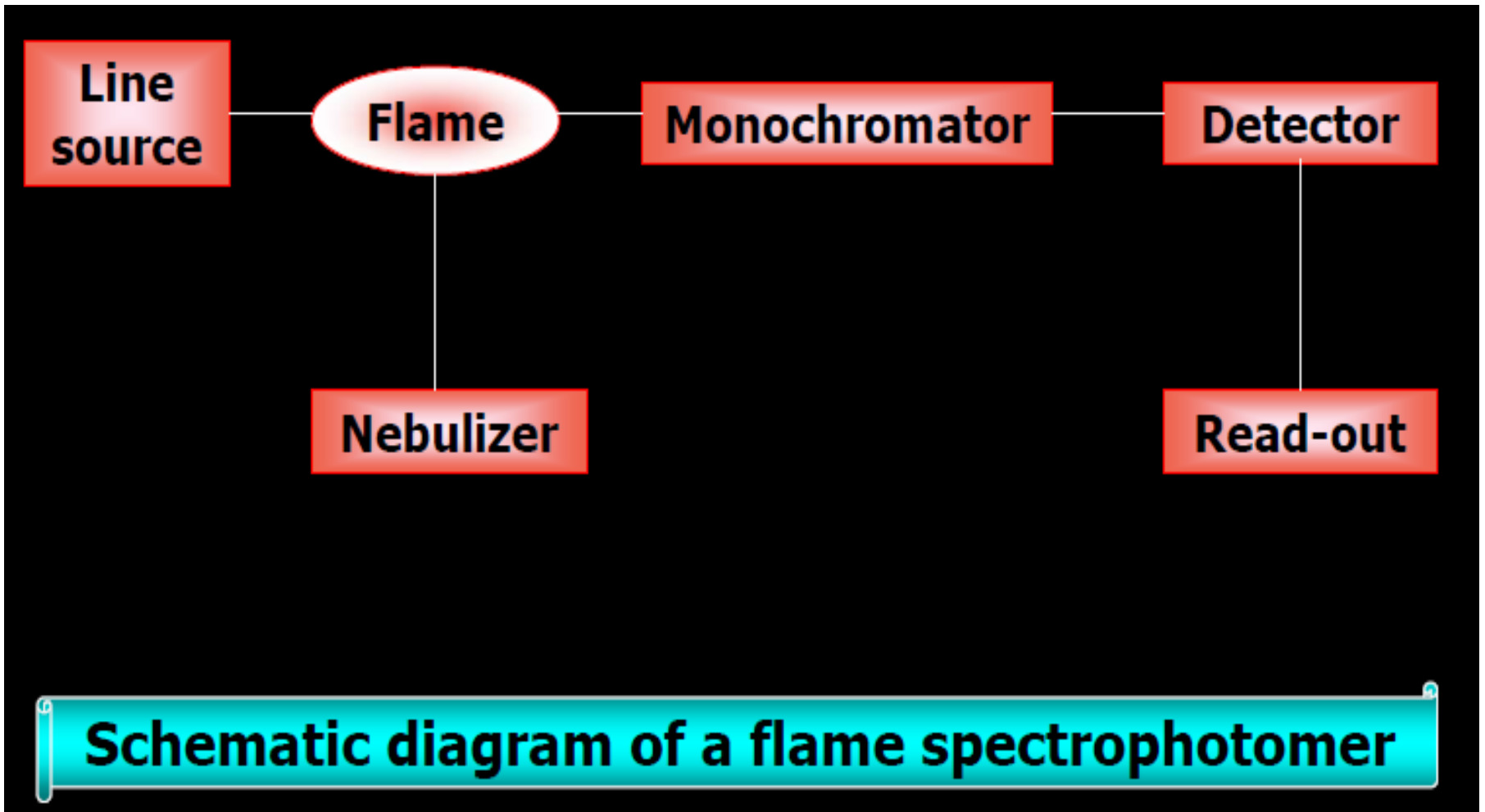

Light Source

- ❑ Laser
- ❑ Hollow-cathode lamp

Hollow-cathode lamp:

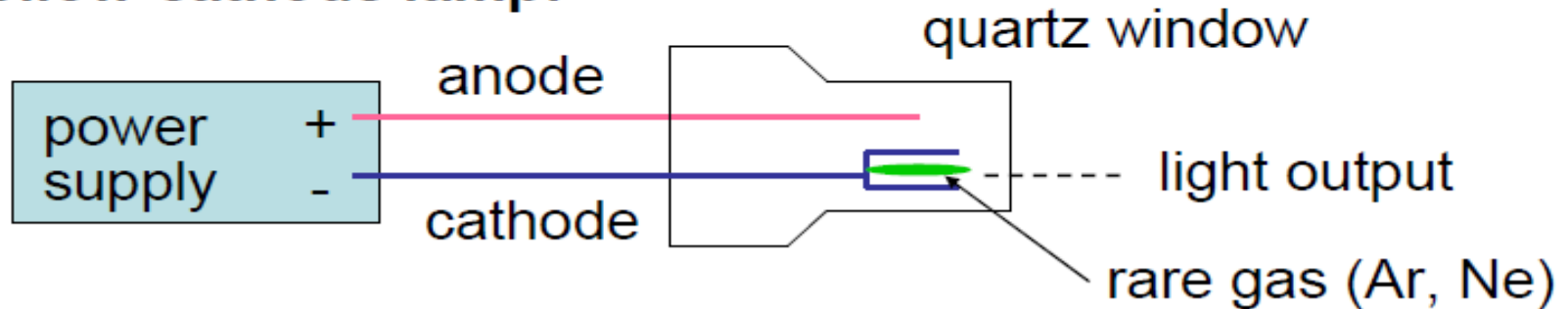

electric discharge

- ⇒ ionization of rare gas atoms
- ⇒ acceleration of gas into cathode
- ⇒ metal atoms of the cathode are sputtered into gas phase
- ⇒ collision of sputtered atoms with gas atoms or electrons excite metal atoms to higher energy levels
- ⇒ decay to lower energy levels by emission of light

Reactions in the hollow-cathode lamp

ionization of filler gas: $\text{Ar} + e^- \rightarrow \text{Ar}^+ + 2 e^-$

sputtering of cathode atoms: $\text{M}(\text{s}) + \text{Ar}^+ \rightarrow \text{M}(\text{g}) + \text{Ar}$

excitation of metal atoms: $\text{M}(\text{g}) + \text{Ar}^+ \rightarrow \text{M}^*(\text{g}) + \text{Ar}$

light emission: $\text{M}^*(\text{g}) \rightarrow \text{M}(\text{g}) + h\nu$

The cathode contains the element that is analysed.

- ⇒ Light emitted by hollow-cathode lamp has the same wavelength as the light absorbed by the analyte element.
- ⇒ Different lamp required for each element (some are multi-element)

Hollow-cathode lamps are discharge lamps that produce narrow emission from atomic species.

Atomic absorption and emission linewidths are inherently narrow. Due to low pressure and lower temperature in the lamp, lines are even narrower than those of analyte atoms.

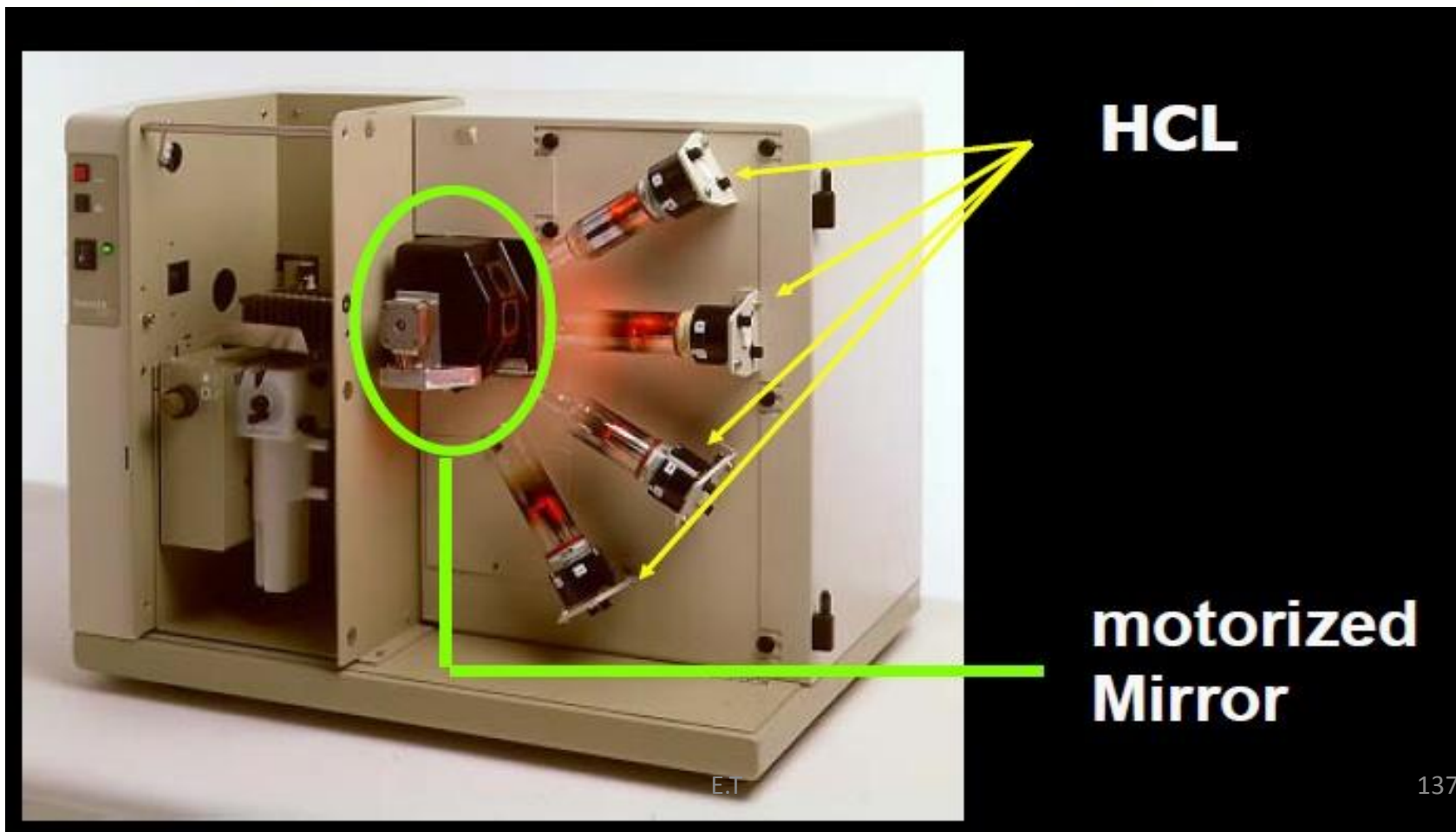

Atomization

Desolvation and vaporization of ions or atoms in a sample:
high-temperature source such as a flame or graphite furnace

⇒ **Flame atomic absorption spectroscopy**

⇒ **Graphite furnace atomic absorption spectroscopy**

Flame atomic absorption spectroscopy:

Sample introduction:

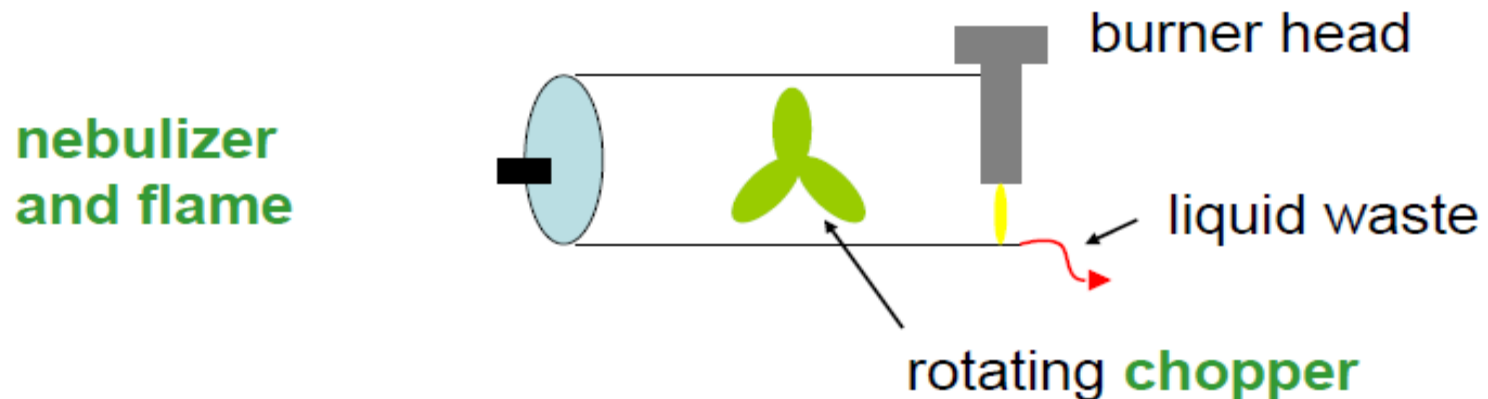

Nebulizer

- ❑ sucks up the liquid sample (= **aspiration**)
- ❑ creates a fine aerosol (fine spray) for introduction into flame
- ❑ mixes aerosol, fuel and oxidant thoroughly, creates a heterogenous mixture
- ❑ the smaller the size of the droplets produced, the higher the element sensitivity

fuel ⇒ **acetylene**

oxidant ⇒ **air (or nitrous oxide)**

Disadvantages of Flame Atomic Absorption Spectroscopy

- ❑ only solutions can be analysed
- ❑ relatively large sample quantities required (1 – 2 mL)
- ❑ less sensitivity (compared to graphite furnace)
- ❑ problems with refractory elements

Advantages

- ❑ inexpensive (equipment, day-to-day running)
- ❑ high sample throughput
- ❑ easy to use
- ❑ high precision

Graphite furnace atomic absorption spectroscopy

Sample holder: graphite tube

Samples are placed directly in the graphite furnace which is then electrically heated.

Beam of light passes through the tube.

Three stages:

1. drying of sample
2. ashing of organic matter
3. vaporization of analyte atoms

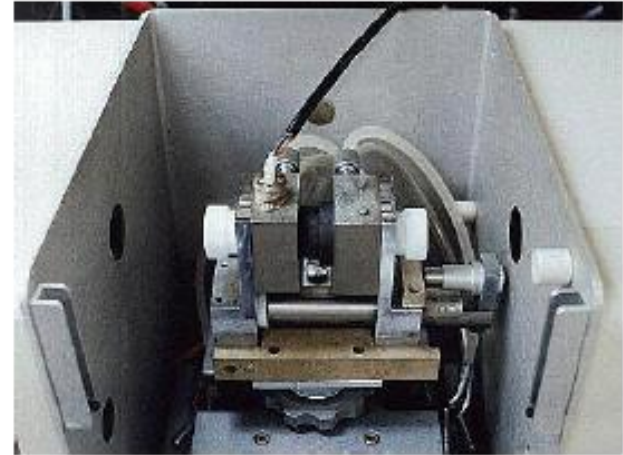

to burn off organic species that would interfere with the elemental analysis.
Molecules have broad absorption bands!

Stages in Graphite Furnace

typical conditions for Fe:

drying stage: 125 °C for 20 sec

ashing stage: 1200 °C for 60 sec

vaporization: 2700 °C for 10 sec

Advantages over flame atomic absorption spectroscopy:

- ❑ Solutions, slurries and solid samples can be analysed.
- ❑ much more efficient atomization
- ❑ greater sensitivity
- ❑ smaller quantities of sample (typically 5 – 50 μL)
- ❑ provides a reducing environment for easily oxidized elements

Disadvantages

- ❑ expensive
- ❑ low precision
- ❑ low sample throughput
- ❑ requires high level of operator skill

Monochromator

- isolation of the absorption line from background light and from molecular emissions originating in the flame, *i.e.* tuned to a specific wavelength
- multi-element lamps: large number of emitted lines; isolation of the line of interest

Detector

A photomultiplier measures the intensity of the incident light and generates an electrical signal proportional to the intensity.

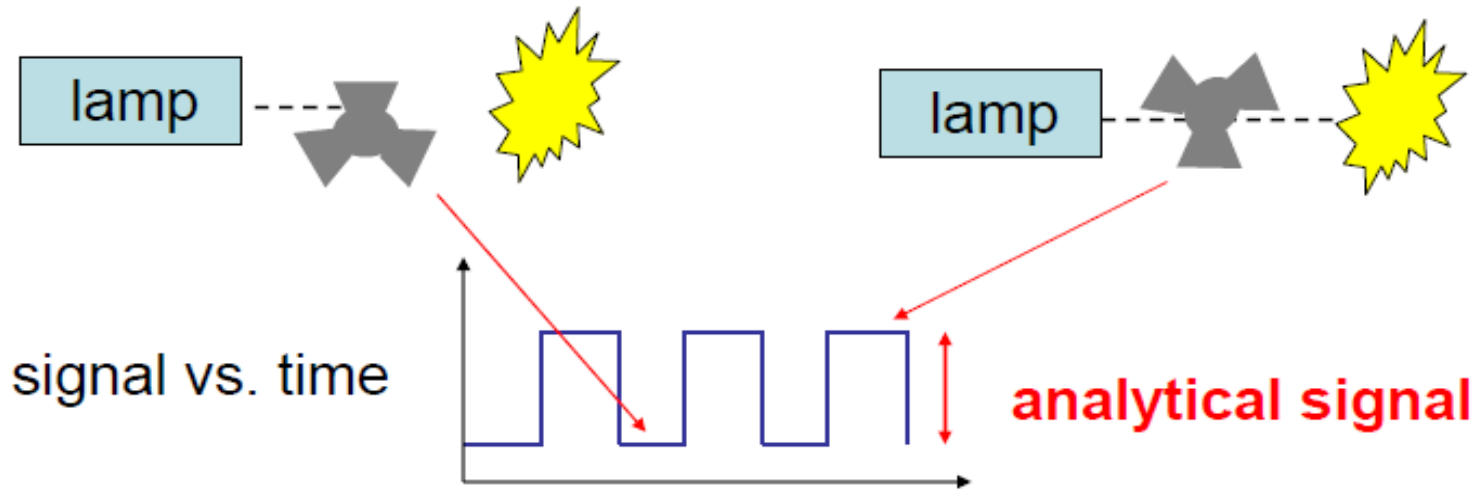

The rotating chopper eliminates unwanted emissions from the flame.

Effect of Temperature on Sodium Atoms

T / K	% ground state	% excited state
2600	99.9833	0.0167
2610	99.9826	0.0174

The effect of a 10 K temperature rise on the ground state population is negligible (*ca.* 0.02 %).

In the excited state the fractional change is:

$$(0.0174 - 0.0167) \times 100 / 0.0167 = 4 \%$$

Small changes in flame temperature (~ 10 K) have little effect in atomic absorption but have significant effects in atomic emission spectroscopy.

In atomic emission spectroscopy the control of the flame temperature is critical!

Interferences

effects on signal when analyte concentration remains unchanged

1. Chemical Interference: Formation of stable or refractory compounds

refractory: elements that form stable compounds that are not completely atomised at the temperature of the flame or graphite furnace

example:

calcium in the presence of phosphate forms stable calcium phosphate

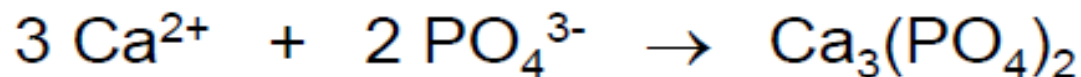

- ⇒ higher flame temperature (nitrous oxide / acetylene instead of air / acetylene)
- ⇒ release agents
- ⇒ chelating agent

Addition of a chelating agent for the analysis of calcium:

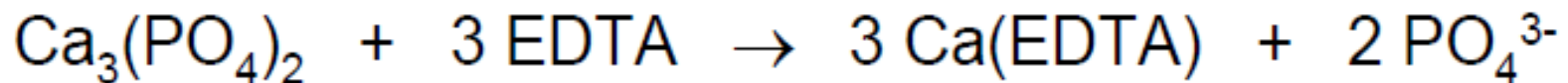

Addition of a release agent for the determination of calcium:

for example: addition of 1000 ppm LaCl_3

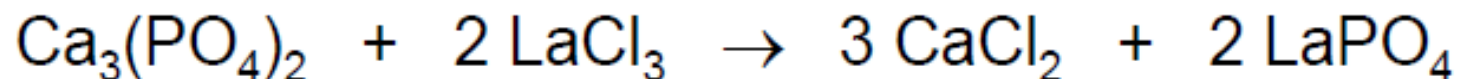

2. Ionisation Interference



problem in the analysis of alkali metal ions: alkali metals have lowest ionisation energies and are therefore most easily ionised in flames.

Example: 2450 K, $p = 0.1 \text{ Pa}$ \Rightarrow Na 5 % ionised
 \Rightarrow K 33 % ionised

Ionisation leads to reduced signal intensity, as energy levels of ions are different from those of the parent ions.

Ionisation of the analyt element can be suppressed by adding an element that is more easily ionised. Ionisation of the added element results in a high concentration of electrons in the flame.

Example:

Addition of 1000 ppm CsCl when analysing for Na or K

Influence of physical properties of the solution

The amount of sample that reaches the flame depends on

- ❑ viscosity
- ❑ surface tension
- ❑ density
- ❑ solvent or vapour pressure

of the solution.

Physical properties of sample and standard solutions for calibration curve should match as closely as possible.

Sensitivity of Atomic Absorption Spectroscopy

- ❑ high sensitivity for most elements
- ❑ flame atomisation: concentrations at the ppm level
- ❑ electro-thermal atomisation (graphite furnace): concentrations at the ppb level

$$1 \text{ ppm} = 10^{-6} \text{ g/g or } 1 \text{ } \mu\text{g/g}$$

If we assume that the density of the analyte solution is approximately 1.0, then

$$1 \text{ ppm} = 1 \text{ } \mu\text{g/g} = 1 \text{ } \mu\text{g/mL}$$

$$1 \text{ ppm Fe} = 1 \times 10^{-6} \text{ g Fe/mL} = 1.79 \times 10^{-5} \text{ mol/L}$$

Sensitivity = concentration of an element which will reduce the transmission by 1 %.

Application of Flame photometer

- Determination of Na^+ , K^+ , Ca^{++} , Mg^{++} in biological fluids (Serum, plasma & Urine),
Analysis of Industrial waste for pollutants
Hardness of water
- Determination of Heavy metal at trace and ultratrace level

Chapter Five



UV-Visible spectroscopy

◆ Electromagnetic Spectrum

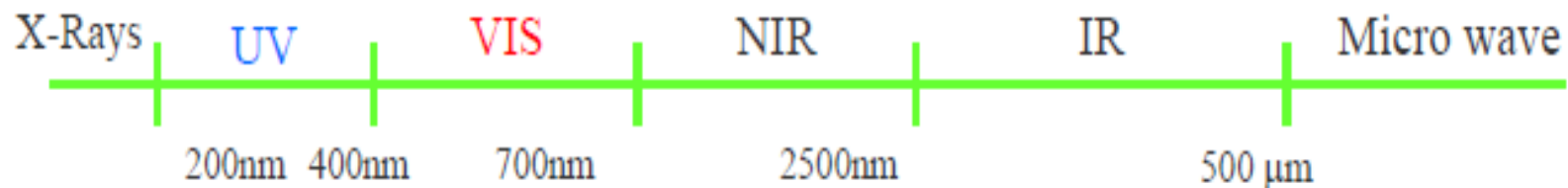

Type of Radiation	Type of Transition
X-Rays	Inner Electron
UV/VIS	Outer Electron
IR	Molecular vibration
Micro Wave	Molecular rotation

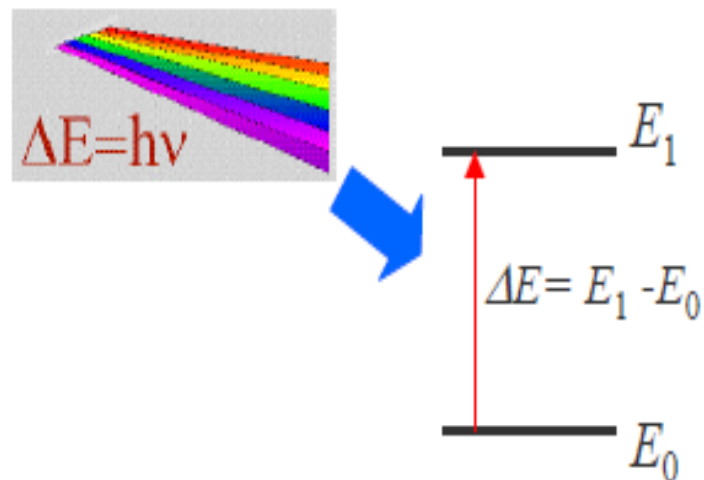

UV-Visible spectrum

- The part of the electromagnetic radiation spectrum that you are most familiar with is "visible light" but
- this is just a small portion of all the possible types
 - Violet :400 - 420 nm
 - Indigo : 420 - 440 nm
 - Blue : 440 - 490 nm
 - Green : 490 - 570 nm
 - Yellow : 570 - 585 nm
 - Orange :585 - 620 nm
 - Red : 620 - 780 nm

Ultraviolet and visible spectroscopy

- It is used to measure the multiple bonds or atomic conjugation within the molecule.
- The UV-Visible region is subdivided as below
 - Vacuum UV: 100-200 nm
 - Near UV: 200 to 400 nm
 - Visible region: 400 to 750 nm
- Vacuum UV is so named because molecule of air absorb radiation in these region.
- The radiation is assessable only in special vacuum equipments.

Basics of UV Light Absorption

- Ultraviolet/visible spectroscopy involves the absorption of ultraviolet/visible light by a molecule
- causing the promotion of an electron from a ground electronic state to an excited electronic state
- Absorption of this relatively high-energy light causes electronic excitation.
- The easily accessible part of this region (wavelengths of 200 to 800 nm)
- absorption only if conjugated pi-electron systems are present.

- The visible region of the spectrum comprises photon energies of 36 to 72 kcal/mole, and
- the near ultraviolet region, out to 200 nm, extends this energy range to 143 kcal/mole.
- Ultraviolet radiation having wavelengths less than 200 nm is difficult to handle, and is seldom used as a routine tool for structural analysis
- The energies are sufficient to promote or excite a molecular electron to a higher energy orbital.
- The absorption spectroscopy carried out in this region is sometimes called "electronic spectroscopy".

- Electronic transitions
 - d and f electrons
 - Charge transfer reactions
 - π , σ , and n (non-bonding) electrons

Absorption Involving d and f Electrons

- Most transition-metal ions absorb in the ultraviolet or visible region of the spectrum.
- For the lanthanide and actinide series, the absorption process results from electronic transitions of $4f$ and $5f$ electrons;
- for elements of the first and second transition-metal series, the $3d$ and $4d$ electrons are responsible for absorption.

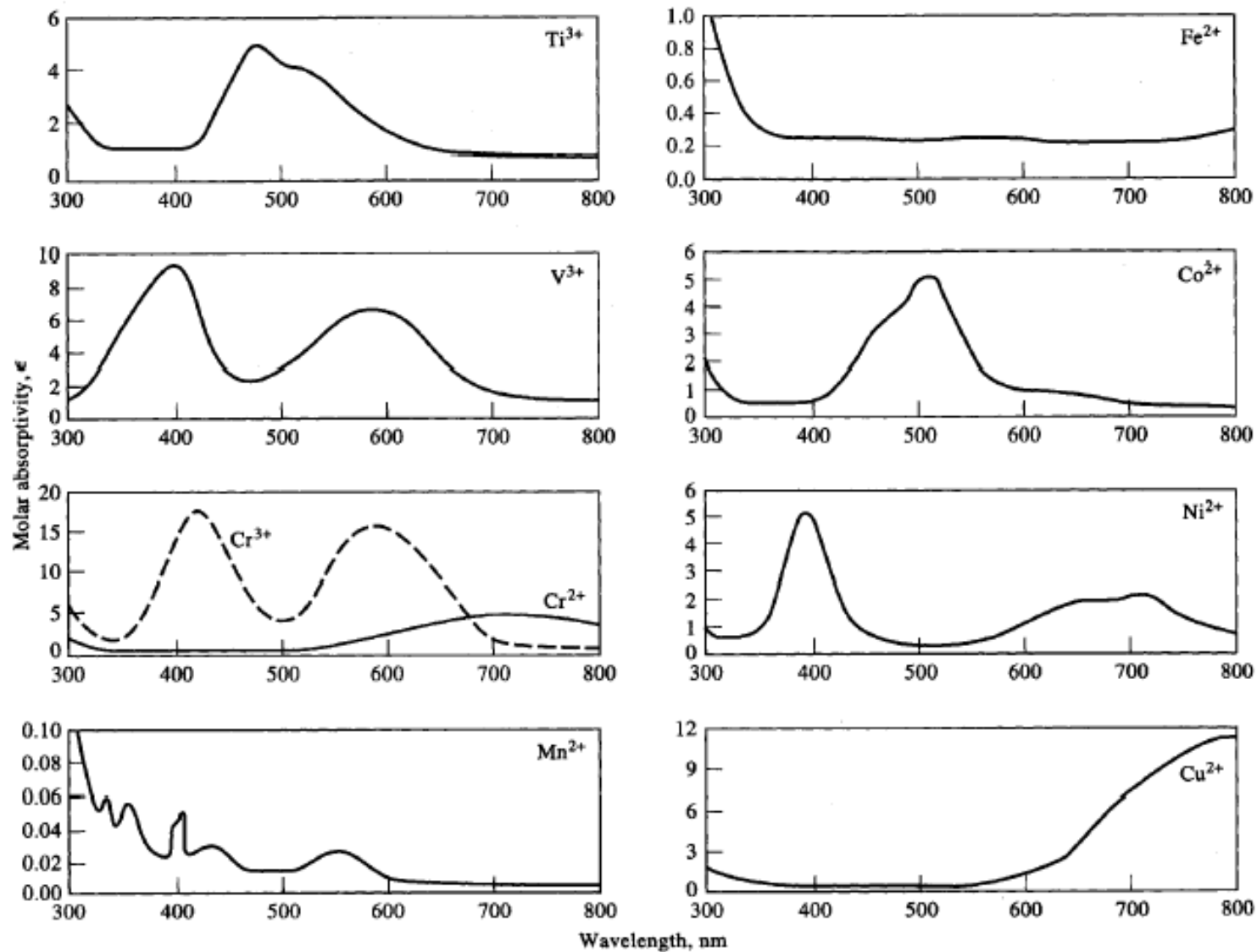

D transitions

- Partially occupied d orbitals
 - Transitions from lower to higher energy levels
 - Splitting of levels due to spatial distribution

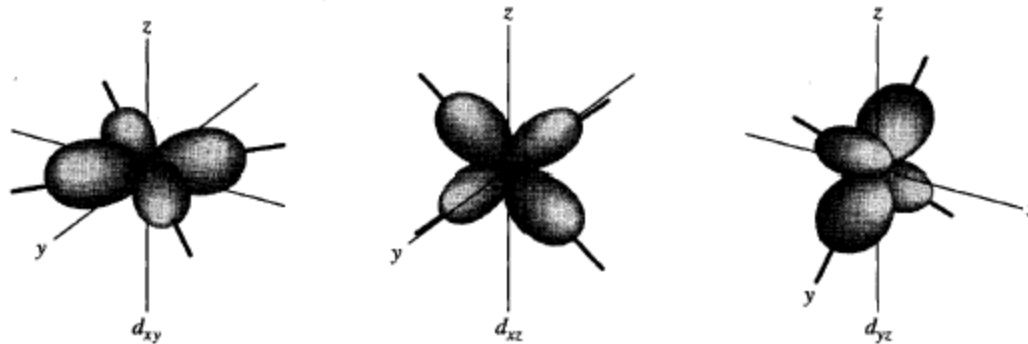

similar

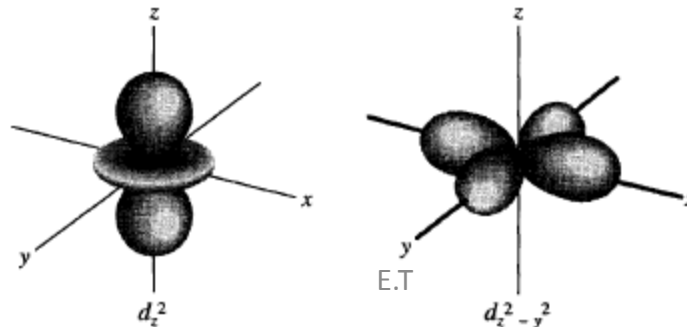

Axial direction

D transitions

- Binding ligands on axis have greater effect on axial orbitals

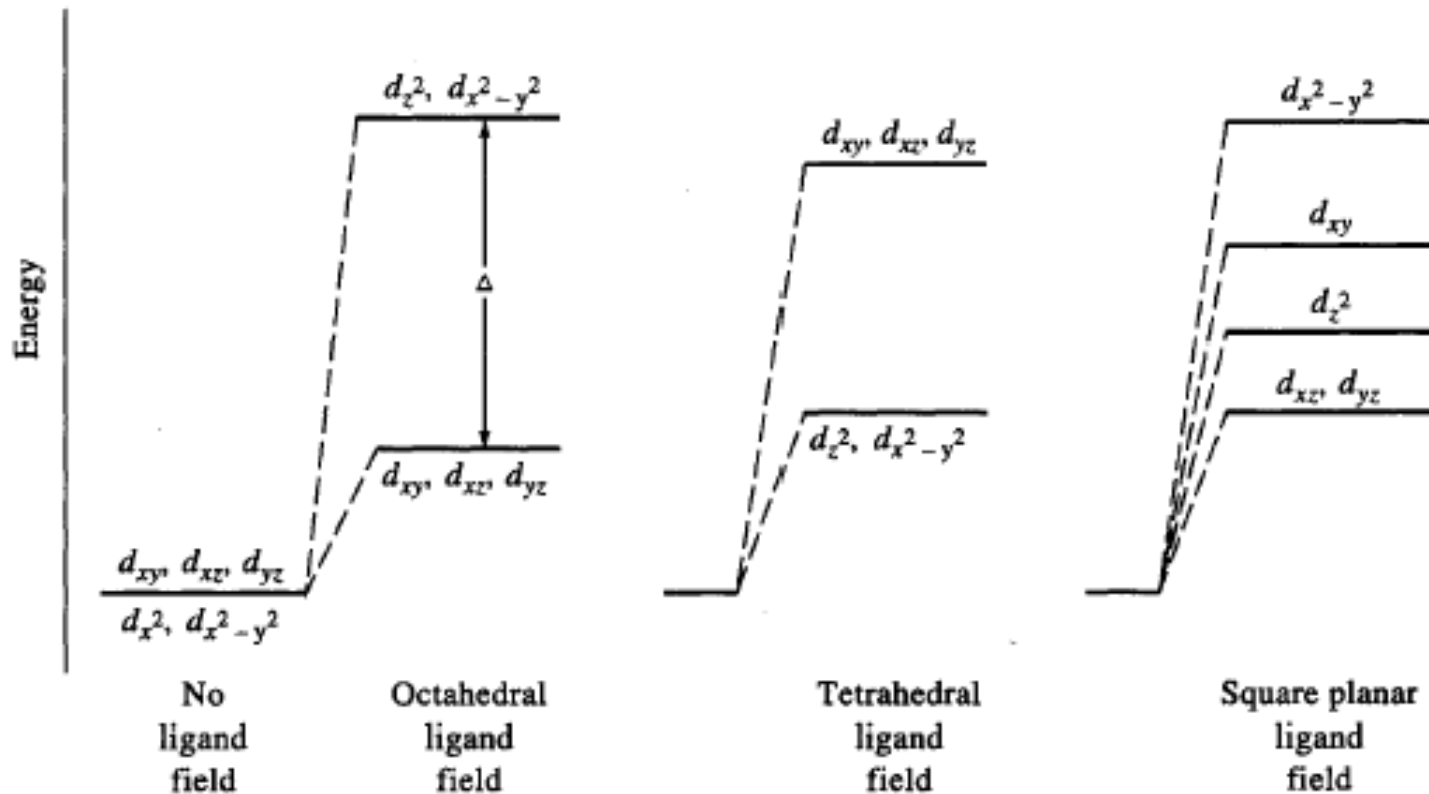

D transitions

- Δ value dependent upon ligand field strength
 - $\text{Br}^- < \text{Cl}^- < \text{F}^- < \text{OH}^- < \text{C}_2\text{O}_4^{2-} \sim \text{H}_2\text{O} < \text{SCN}^- < \text{NH}_3 < \text{en} < \text{NO}_2^- < \text{CN}^-$
 - Δ increases with increasing field strength
- f-f
 - 4f and 5f (lanthanides and actinides)
 - Sharper transitions

Actinide transitions

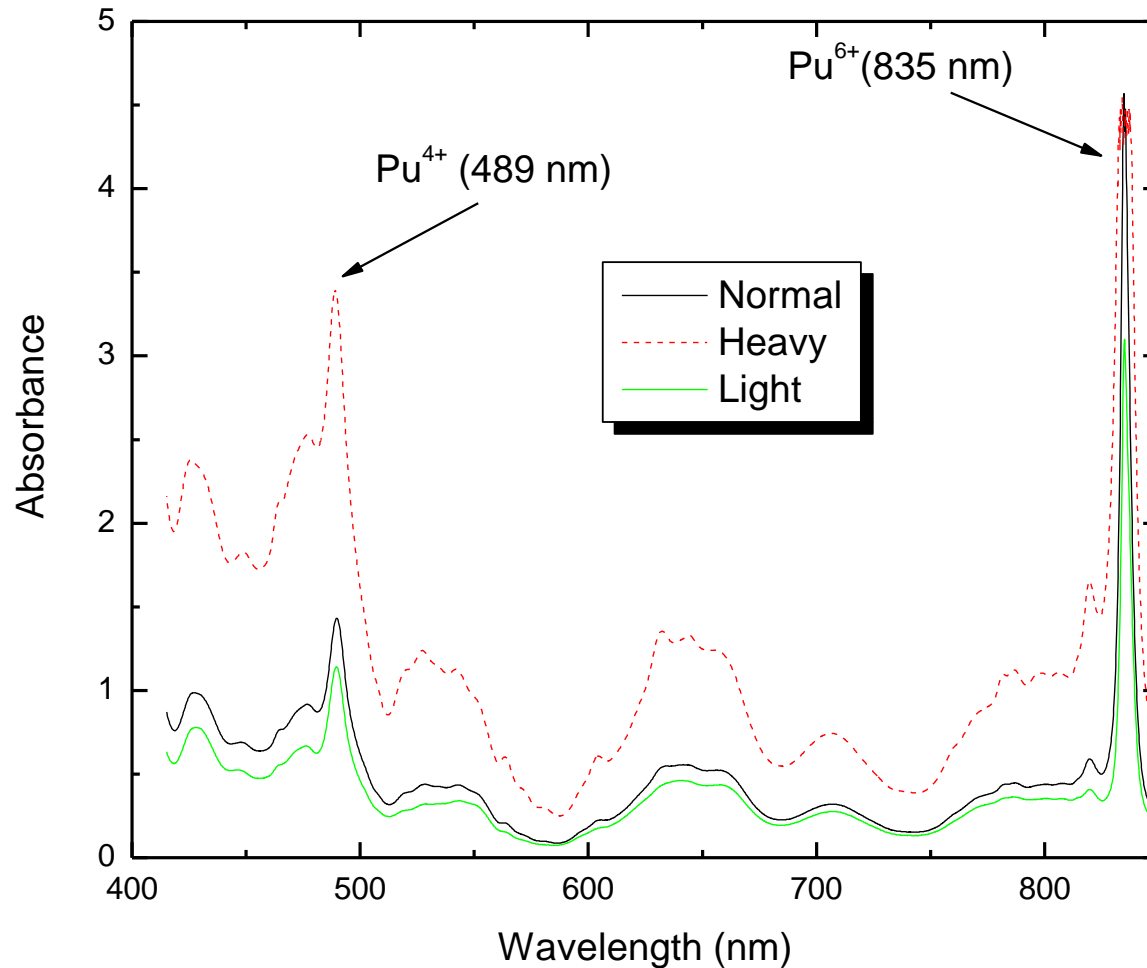
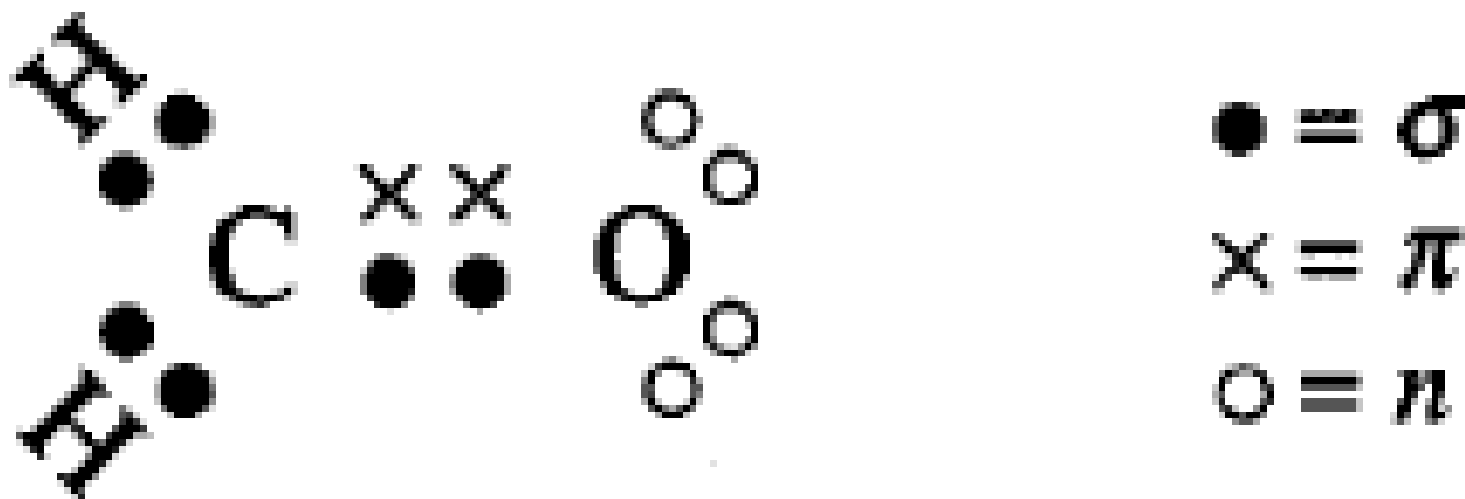

Figure 2: UV-vis spectra of organic phases for 13M HNO₃ system

Charge-transfer Transitions

- Electron donor and acceptor characteristics
 - Absorption involves e^- transitions from donor to acceptor
 - SCN to Fe(III)
 - Product is Fe(II) and neutral SCN
 - Metal is acceptor
- An exception is the 1,10-phenanthroline complex of iron(II) or copper(I), where the ligand is the acceptor and the metal ion is the donor.

- π , σ , and n (non-bonding) electrons



Sigma and Pi orbitals

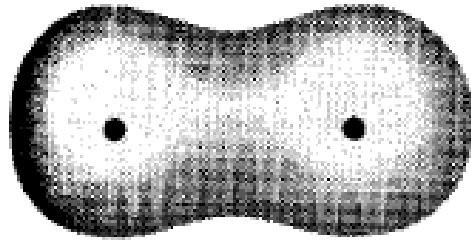

(a) σ orbital

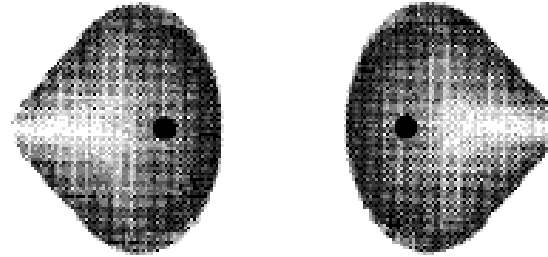

(c) σ^* orbital

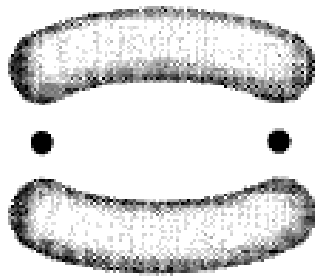

(b) π orbital

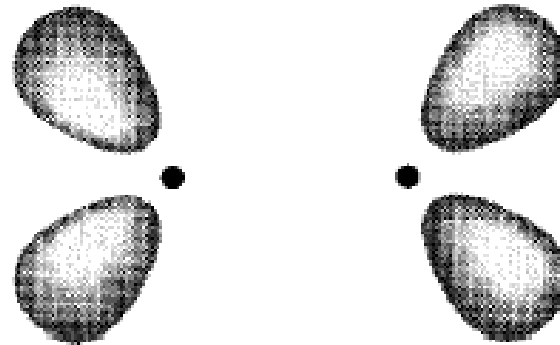

(d) π^* orbital

Electronic transactions involved

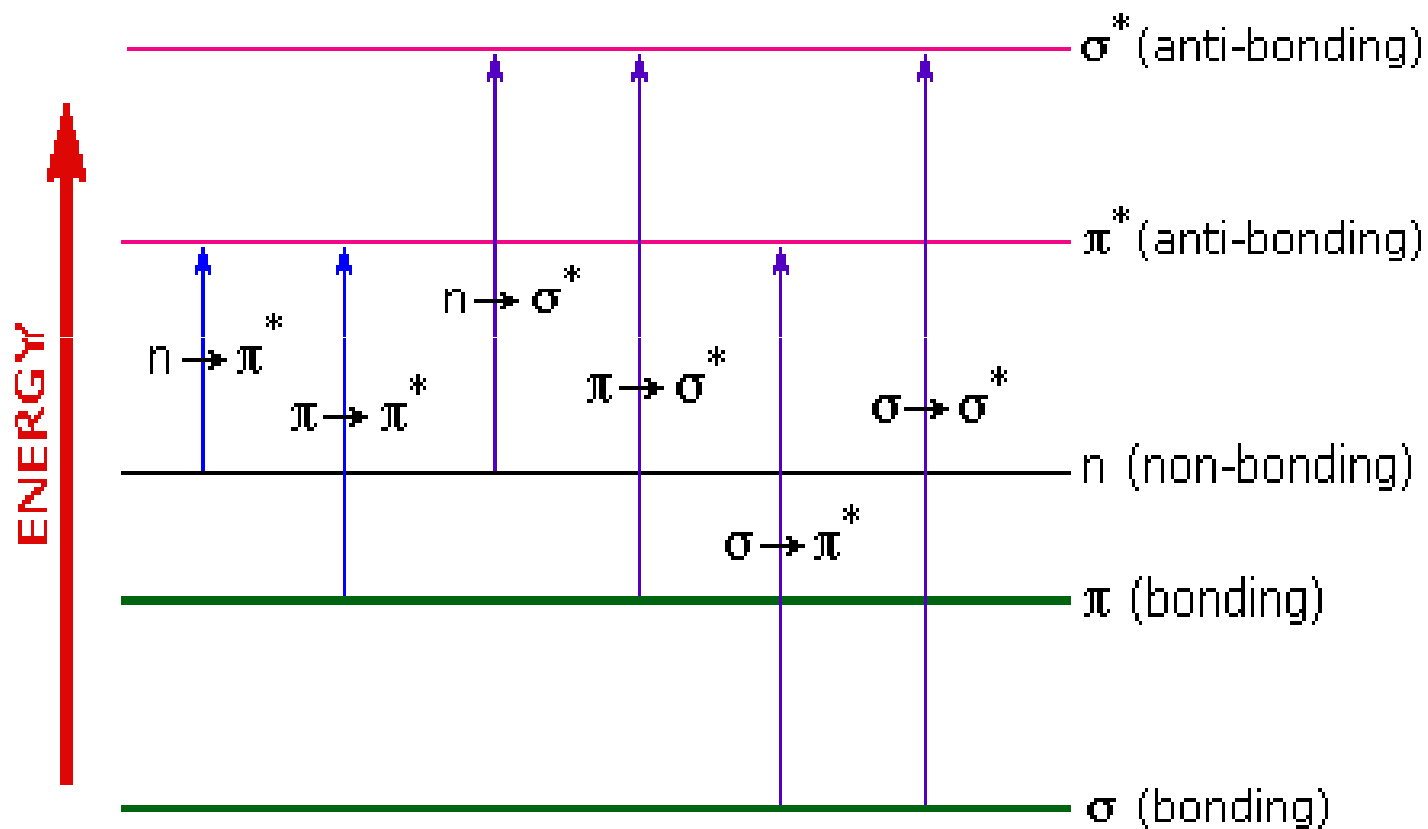

Far ultra-violet
(Vacuum u.v.)

Near ultra-violet

Visible

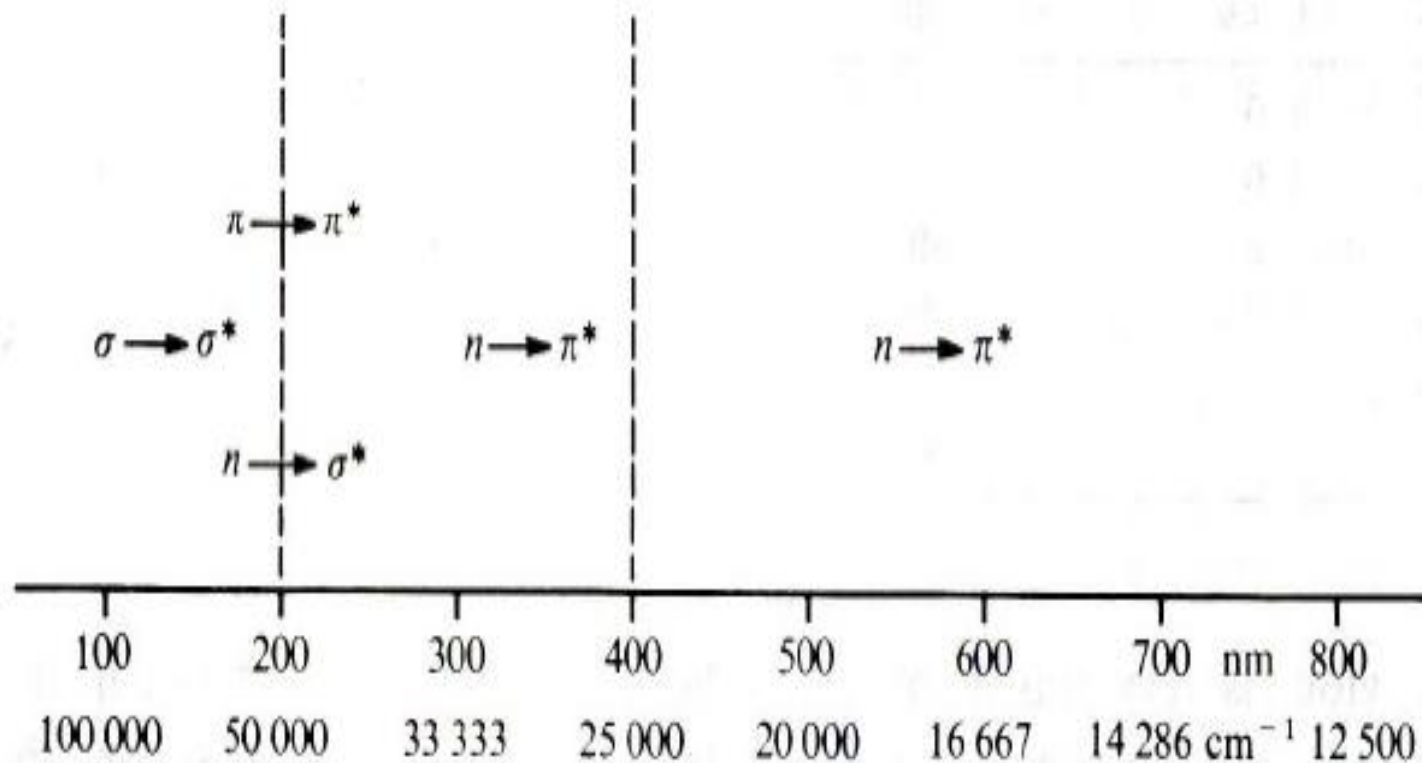

Electronic spectroscopy

- Out of the six transitions outlined, only the two lowest energy ones (left-most, colored blue) are achieved by the energies available in the 200 to 800 nm spectrum.
- As a rule, energetically favored electron promotion will be from the highest occupied molecular orbital (HOMO) to the lowest unoccupied molecular orbital (LUMO), and the resulting species is called an excited state

Types of Transitions

- There are several types of electronic transitions available to a molecule including:
 - σ to σ^* (alkanes)
 - σ to π^* (carbonyl compounds)
 - π to π^* (alkenes, carbonyl compounds, alkynes, azo compounds)
 - n to σ^* (oxygen, nitrogen, sulfur, and halogen compounds)
 - n to π^* (carbonyl compounds)

$\sigma \sigma^*$ Transitions

- An electron in a bonding σ orbital is excited to the corresponding antibonding orbital.
 - The energy required is large.
- For example, alkanes as methane (which has only C-H bonds, and can only undergo $\sigma \sigma^*$ transitions)
- shows an absorbance maximum at 125 nm.
- Absorption maxima due to $\sigma \sigma^*$ transitions are not seen in typical UV-Visible spectra (200 - 700 nm).
- σ bonds are very strong and requires higher energy of vacuum UV.

Ethane

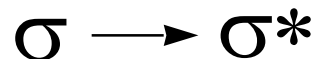

$$\lambda_{\max} = 135 \text{ nm} \quad (\text{a high energy transition})$$

Absorptions having $\lambda_{\max} < 200 \text{ nm}$ are difficult to observe because everything (including quartz glass and air) absorbs in this spectral region.

$n\sigma^*$ Transitions

- Saturated compounds containing atoms with lone pairs (non-bonding electrons) are capable of $n\sigma^*$ as transitions.
- These transitions usually need less energy than $\sigma\sigma^*$ transitions.
- They can be initiated by light whose wavelength is in the range 150 - 250 nm.
- The number of organic functional groups with $n\sigma^*$ peaks in the UV region is small.
- These transitions are involved in saturated compound with one hetero atom with unshared pair of electron i.e. saturated halides, ethers, aldehydes, ketones, amines etc.
- These transitions are sensitive to hydrogen bonding eg alcohol and ethers which absorbs at wavelength shorter than 185 nm therefore used as a solvent in UV

$\pi \pi^*$ Transitions

- For molecules that possess π bonding as in alkenes, alkynes, aromatics, acyl compounds or nitriles,
- energy that is available can promote electrons from a π Bonding molecular orbital to a π Antibonding molecular orbital (π^*).
- This is called a $\pi \pi^*$ transition.
- The absorption peaks for these transitions fall in an experimentally convenient region of the spectrum (200 - 700 nm).
- These transitions need an unsaturated group in the molecule to provide the π electrons.

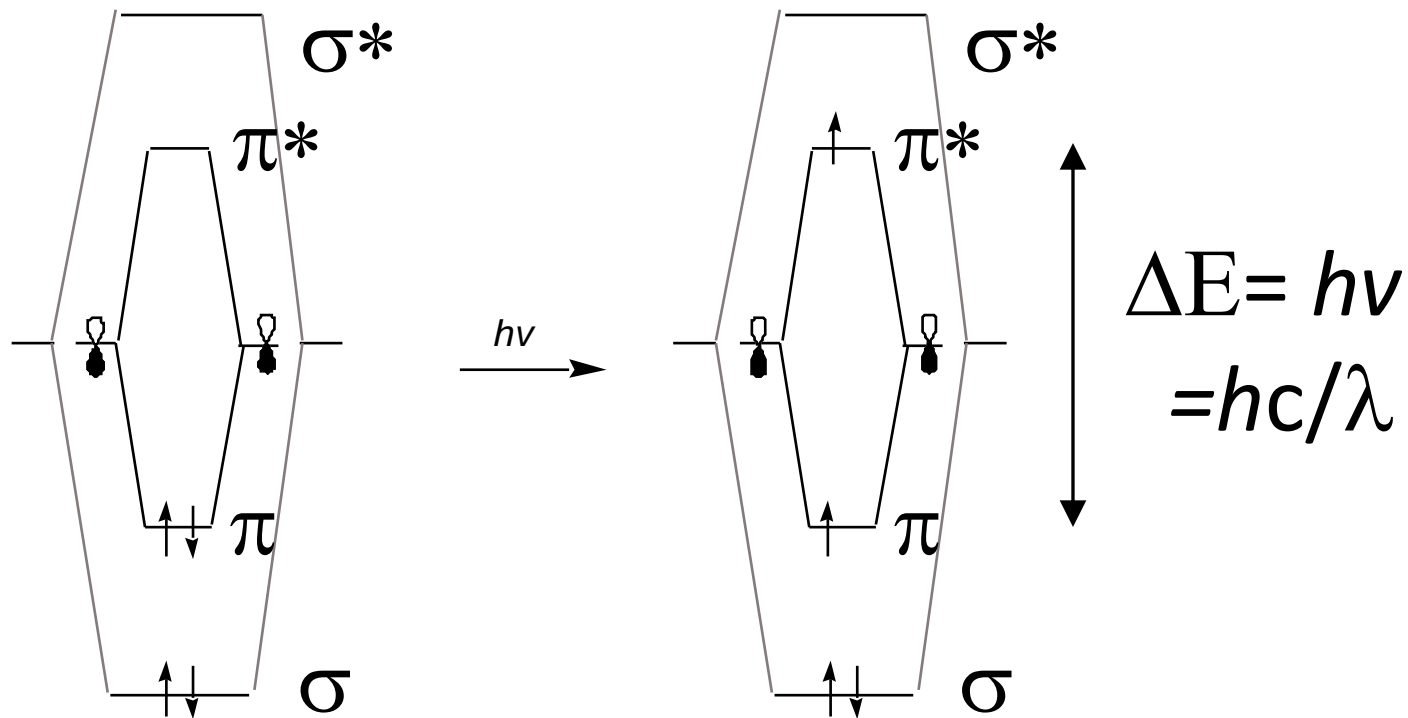
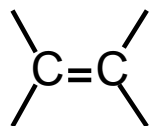

Example: ethylene absorbs at longer wavelengths:

$n \pi^*$ Transitions

- Lone pairs that exist on Oxygen atoms and Nitrogen atoms may be promoted from their non-bonding molecular orbital to a π antibonding molecular orbital within the molecule.
- This is called an $n \pi^*$ transition and
- requires less energy (longer wavelength) compared to a $\pi \pi^*$ transition within the same chromophore.
- These are available in compounds with unsaturated centers. eg. Alkenes. They requires lowest energy as compare to others

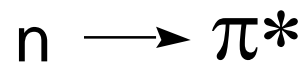
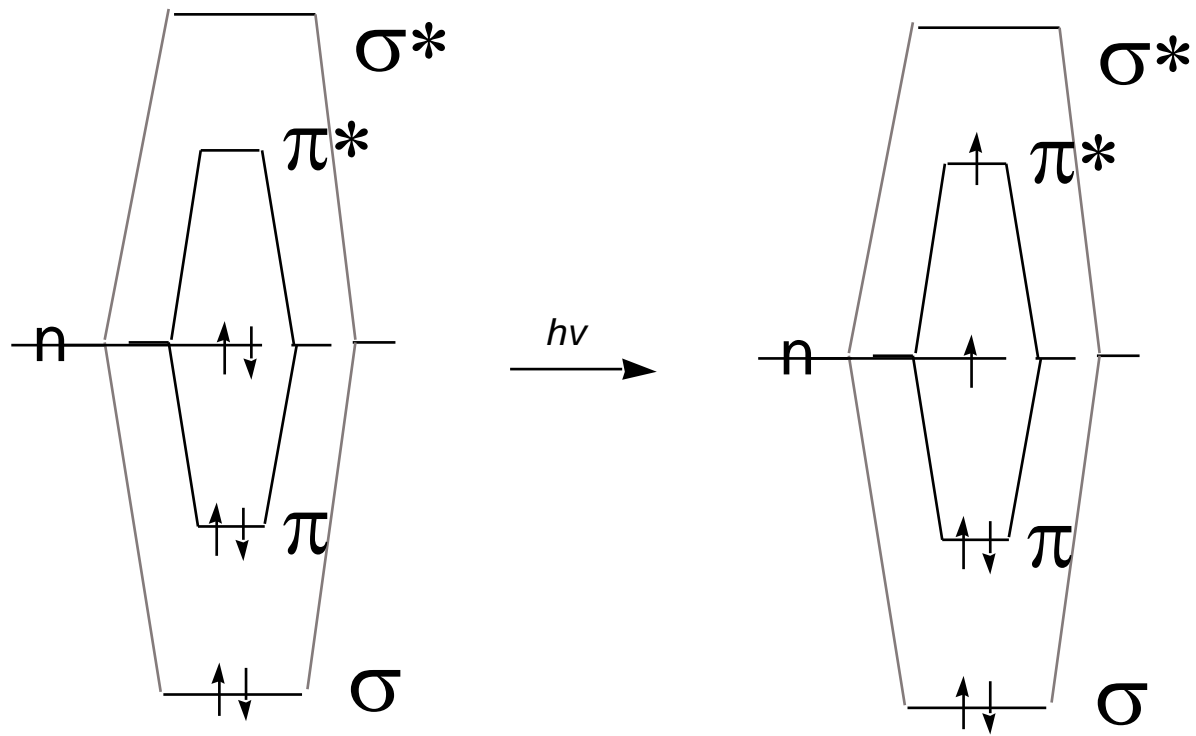
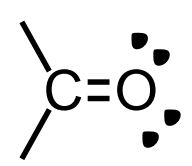

Conjugated systems:

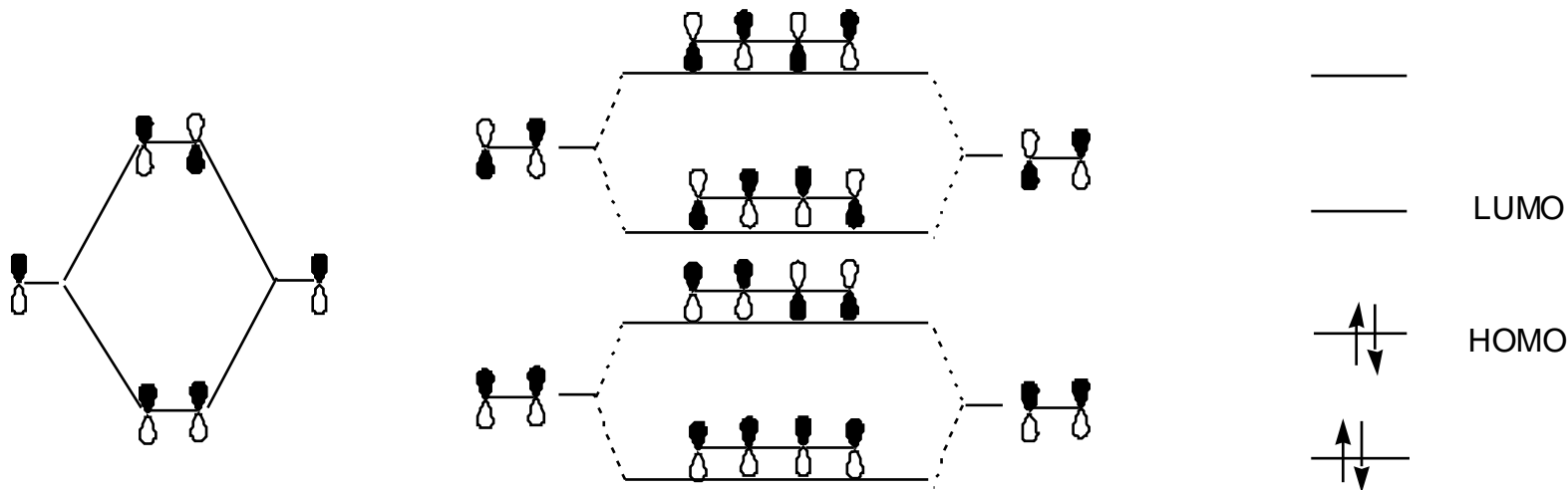
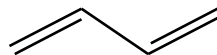
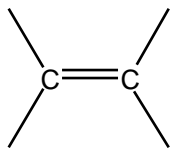

Preferred transition is between Highest Occupied Molecular Orbital (HOMO) and Lowest Unoccupied Molecular Orbital (LUMO).

Note: Additional conjugation (double bonds) lowers the HOMO-LUMO energy gap:

Example:

1,3 butadiene: $\lambda_{\max} = 217 \text{ nm}$; $\epsilon = 21,000$

1,3,5-hexatriene $\lambda_{\max} = 258 \text{ nm}$; $\epsilon = 35,000$

Similar structures have similar UV spectra:

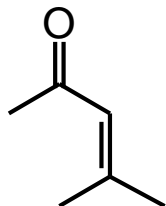

$$\lambda_{\max} = 238, 305 \text{ nm}$$

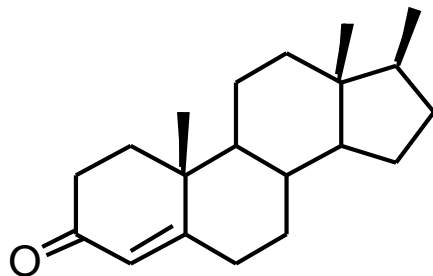

$$\lambda_{\max} = 240, 311 \text{ nm}$$

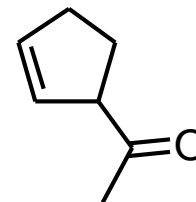

$$\lambda_{\max} = 173, 192 \text{ nm}$$

Table: absorption characteristics of some common chromophores

Chromophore	Example	Solvent	λ_{\max} , nm	ϵ_{\max}	Transition Type
Alkene	$C_6H_{13}CH=CH_2$	<i>n</i> -Heptane	177	13,000	$\pi \rightarrow \pi^*$
Alkyne	$C_5H_{11}CH\equiv C-CH_3$	<i>n</i> -Heptane	178	10,000	$\pi \rightarrow \pi^*$
			196	2000	—
			225	160	—
Carbonyl	$\begin{array}{c} CH_3CCH_3 \\ \\ O \end{array}$	<i>n</i> -Hexane	186	1000	$n \rightarrow \sigma^*$
			280	16	$n \rightarrow \pi^*$
Carboxyl	$\begin{array}{c} CH_3CH \\ \\ O \end{array}$	<i>n</i> -Hexane	180	large	$n \rightarrow \sigma^*$
			293	12	$n \rightarrow \pi^*$
Amido	CH_3COOH	Ethanol	204	41	$n \rightarrow \pi^*$
	$\begin{array}{c} CH_3CNH_2 \\ \\ O \end{array}$	Water	214	60	$n \rightarrow \pi^*$
Azo	$CH_3N=NCH_3$	Ethanol	339	5	$n \rightarrow \pi^*$
Nitro	CH_3NO_2	Isooctane	280	22	$n \rightarrow \pi^*$
Nitroso	C_4H_9NO	Ethyl ether	300	100	—
			665	20	$n \rightarrow \pi^*$
Nitrate	$C_2H_5ONO_2$	Dioxane	270	12	$n \rightarrow \pi^*$

Activity one:

Transitions $n \rightarrow \sigma^*$, $\pi \rightarrow \pi^*$, $n \rightarrow \pi^*$, $\sigma \rightarrow \sigma^*$, $\sigma \rightarrow \pi^*$

Choose possible transitions from the above list for each chromophores.

R-OH

R-O-R

R-CH₂-R

R-C \equiv C-R

R-C \equiv N

R-CHO

RCOOH

Instrumentation :

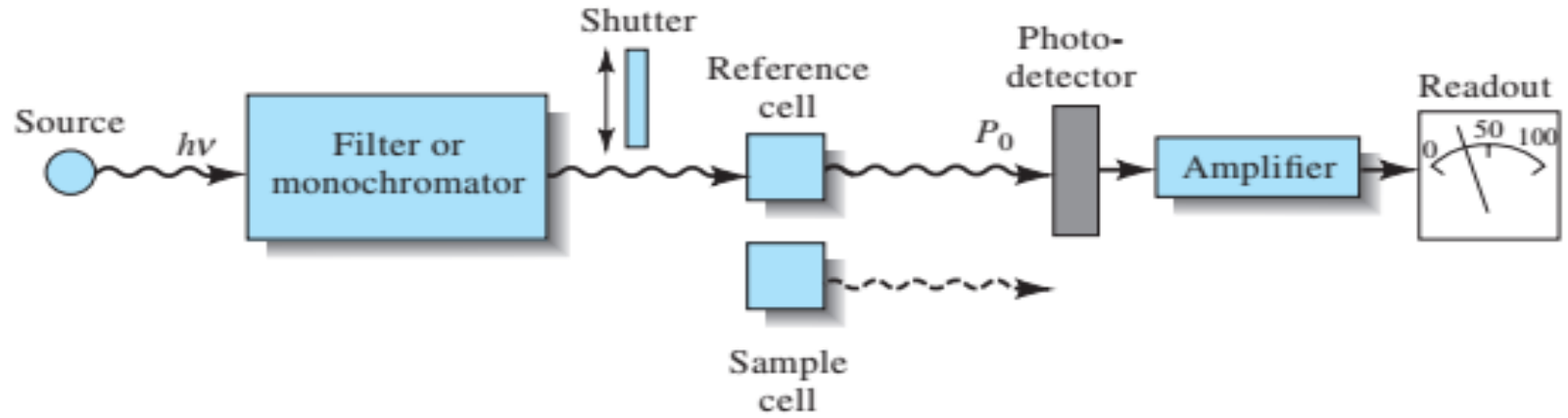

(a)

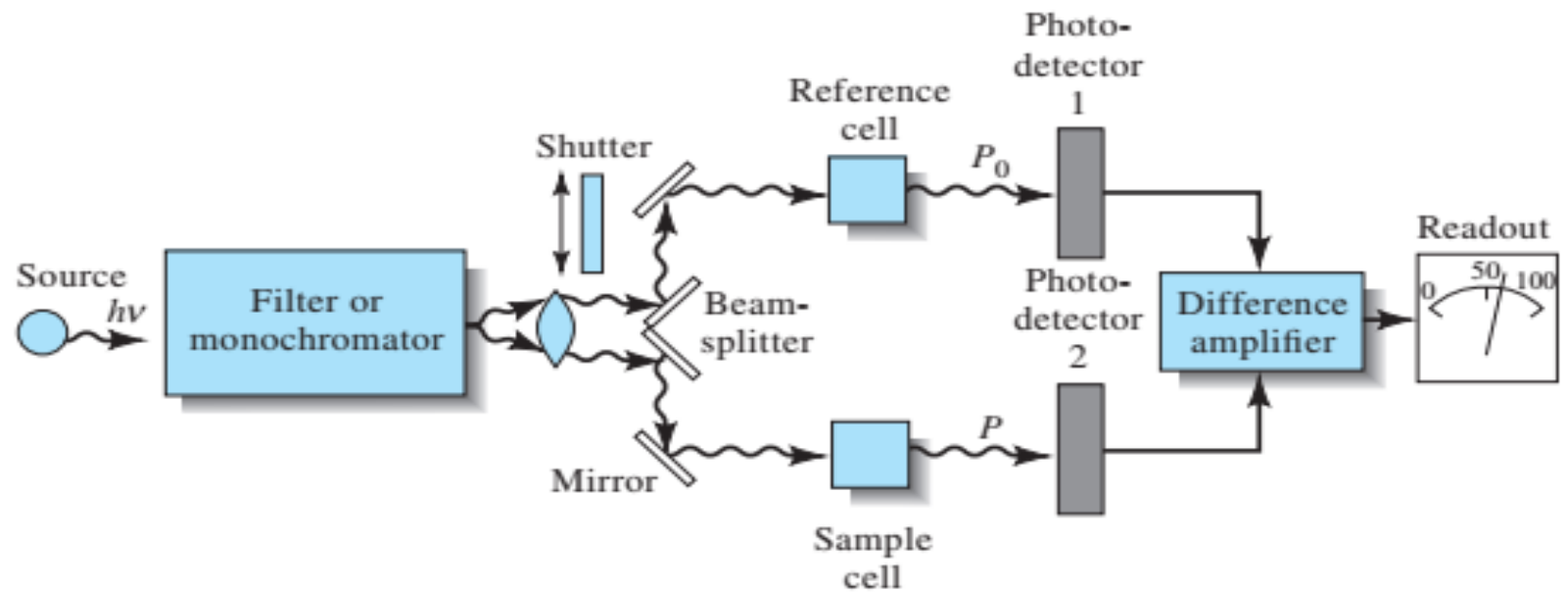

(b)

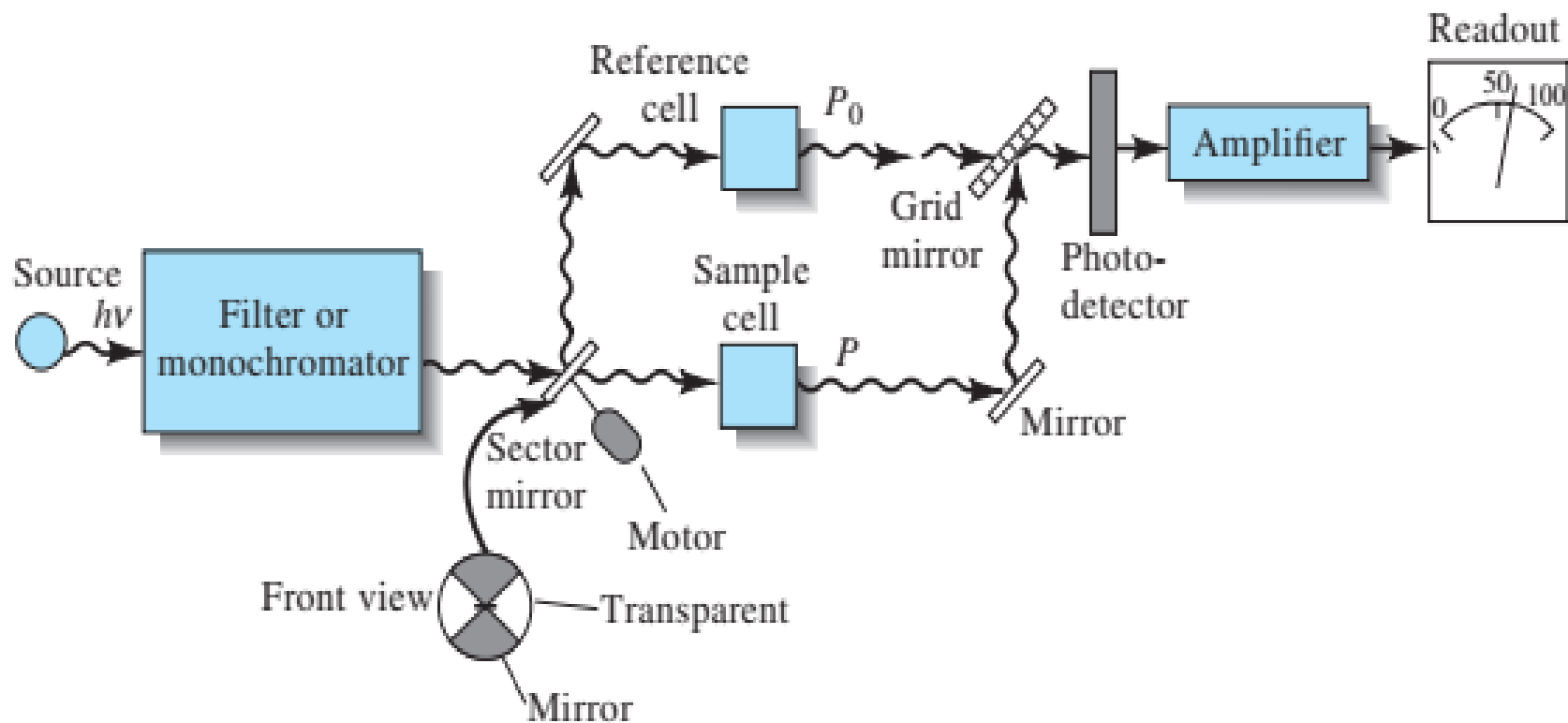

Figure: Instrumental designs for UV-visible photometers or spectrophotometers. In (a), a single-beam instrument is shown. Radiation from the filter or monochromator passes through either the reference cell or the sample cell before striking the photodetector. In (b), a double-beam-in-space instrument is shown. Here, radiation from the filter or monochromator is split into two beams that simultaneously pass through the reference and sample cells before striking two matched photodetectors. In the double-beam-in-time instrument (c), the beam is alternately sent through reference and sample cells before striking a single photodetector. Only a matter of milliseconds separate the beams as they pass through the two cells.

Instrumentation:

- A beam of light from a visible and/or UV light source is separated into its component wavelengths by a prism or diffraction grating.
- Each monochromatic (single wavelength) beam in turn is split into two equal intensity beams by a half-mirrored device.
- One beam, the sample beam, passes through a small transparent container (cuvette) containing a solution of the compound being studied in a transparent solvent.
- The other beam, the reference, passes through an identical cuvette containing only the solvent.

- The intensities of these light beams are then measured by electronic detectors and compared.
- The intensity of the reference beam, which should have suffered little or no light absorption, is defined as I_0 .
- The intensity of the sample beam is defined as I .
- Over a short period of time, the spectrometer automatically scans all the component wavelengths in the manner described.
- The ultraviolet (UV) region scanned is normally from 200 to 400 nm, and the visible portion is from 400 to 800 nm.

Solvent effect:

- Different compounds may have very different absorption maxima and absorbances.
- Intensely absorbing compounds must be examined in dilute solution, so that significant light energy is received by the detector, and this requires the use of completely transparent (non-absorbing) solvents.
- The most commonly used solvents are water, ethanol, hexane and cyclohexane.
- Solvents having double or triple bonds, or heavy atoms (e.g. S, Br & I) are generally avoided.

- Solvents must be transparent in the region to be observed; the wavelength where a solvent is no longer transparent is referred to as the **cutoff**

Table: solvents for the UV and Visible regions

Solvent	Lower Wavelength Limit, nm	Solvent	Lower Wavelength Limit, nm
Water	180	Diethyl ether	210
Ethanol	220	Acetone	330
Hexane	200	Dioxane	320
Cyclohexane	200	Cellosolve	320
Carbon tetrachloride	260		

- H-bonding further complicates the effect of vibrational and rotational energy levels on electronic transitions, dipole-dipole interacts less so
- The more non-polar the solvent, the better (this is not always possible)

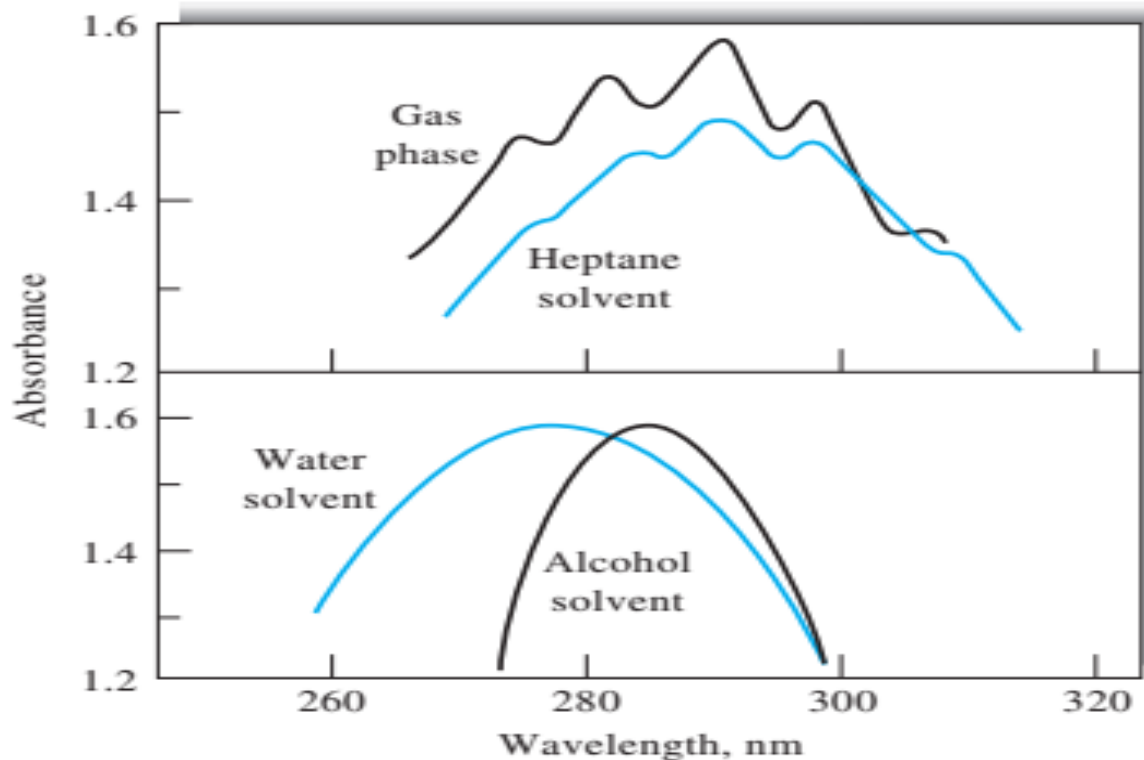
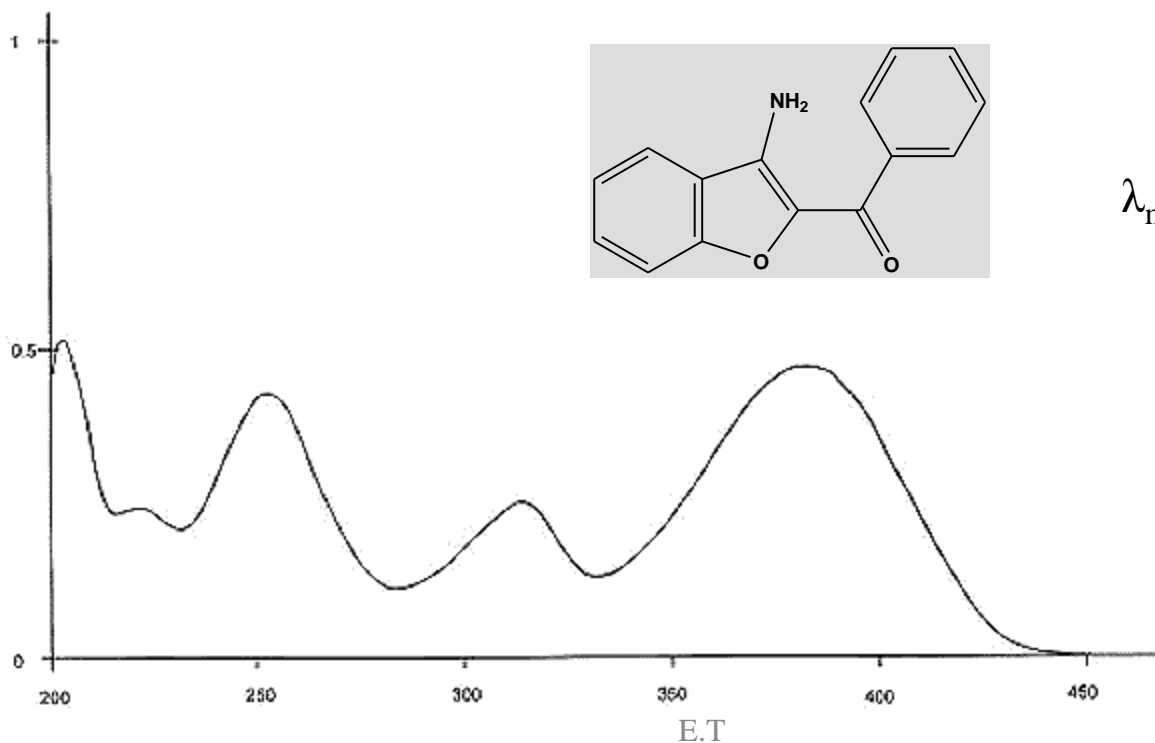

Figure: effect of solvent on the absorption spectrum of acetaldehyde

E.T

The Spectrum

1. The x-axis of the spectrum is in wavelength; 200-350 nm for UV, 200-700 for UV-VIS determinations
2. Due to the lack of any fine structure, spectra are rarely shown in their raw form, rather, the peak maxima are simply reported as a numerical list of “lambda max” values or λ_{\max}



$$\lambda_{\max} = \begin{array}{l} 206 \text{ nm} \\ 252 \\ 317 \\ 376 \end{array}$$

The Spectrum

1. The y-axis of the spectrum is in absorbance, A
2. From the spectrometers point of view, absorbance is the inverse of transmittance: $A = \log_{10} (p_0/p)$
3. From an experimental point of view, three other considerations must be made:
 - i. a longer **path length, l** through the sample will cause more UV light to be absorbed – linear effect
 - ii. the greater the **concentration, c** of the sample, the more UV light will be absorbed – linear effect
 - iii. some electronic transitions are more effective at the absorption of photon than others – **molar absorptivity, ϵ** this may vary by orders of magnitude...

4. These effects are combined into the Beer-Lambert Law: $A = \epsilon c l$
- i. for most UV spectrometers, l would remain constant (standard cells are typically 1 cm in path length)
 - ii. concentration is typically varied depending on the strength of absorption observed or expected – typically dilute – sub .001 M
 - iii. molar absorptivities vary by orders of magnitude:
 - values of 10^4 - 10^6 are termed **high intensity absorptions**
 - values of 10^3 - 10^4 are termed **low intensity absorptions**
 - values of 0 to 10^3 are the absorptions of **forbidden transitions**

A is unit less, so the units for ϵ are $\text{cm}^{-1} \cdot \text{M}^{-1}$

5. Since path length and concentration effects can be easily factored out, absorbance simply becomes proportional to ϵ , and the y-axis is expressed as e directly or as the logarithm of ϵ

The Spectrum

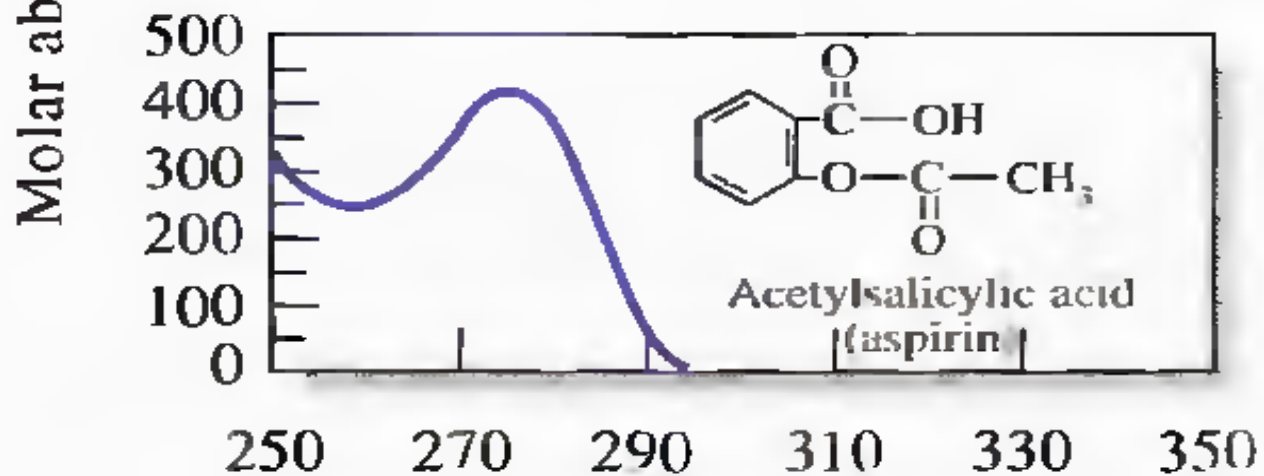
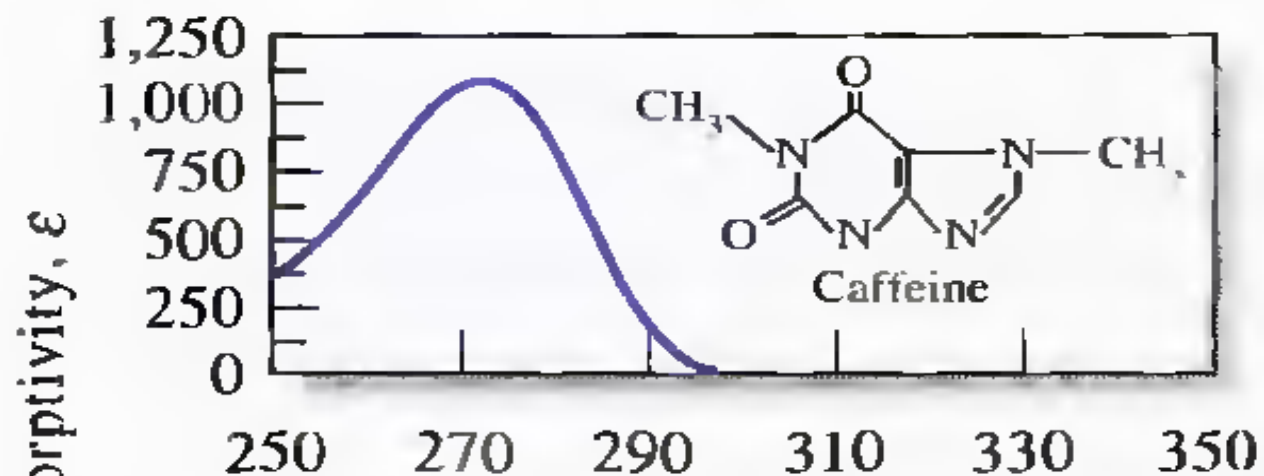

Terminology Chromophore:

- Chromophore: A covalently unsaturated group responsible for electronic absorption.
- Or Any group of atoms that absorbs light whether or not a color is thereby produced. Eg C=C, C=O, NO₂ etc
- A compound containing chromophore is called chromogen.
- There are two types of chromophore
 - Independent chromophore: single chromophore is sufficient to impart color to the compound eg. Azo group
 - Dependent chromophore: When more than one chromophore is required to produce color.
 - Eg acetone having 1 ketone group is colorless where as diacetyl having two ketone group is yellow

Auxochrome:

- A saturated group with non bonding electron when attached to chromophore alters both wavelengths as well as intensity of absorption. Eg OH, NH₂, NHR etc.

OR

- A group which extends the conjugation of a chromophore by sharing of nonbonding electrons.

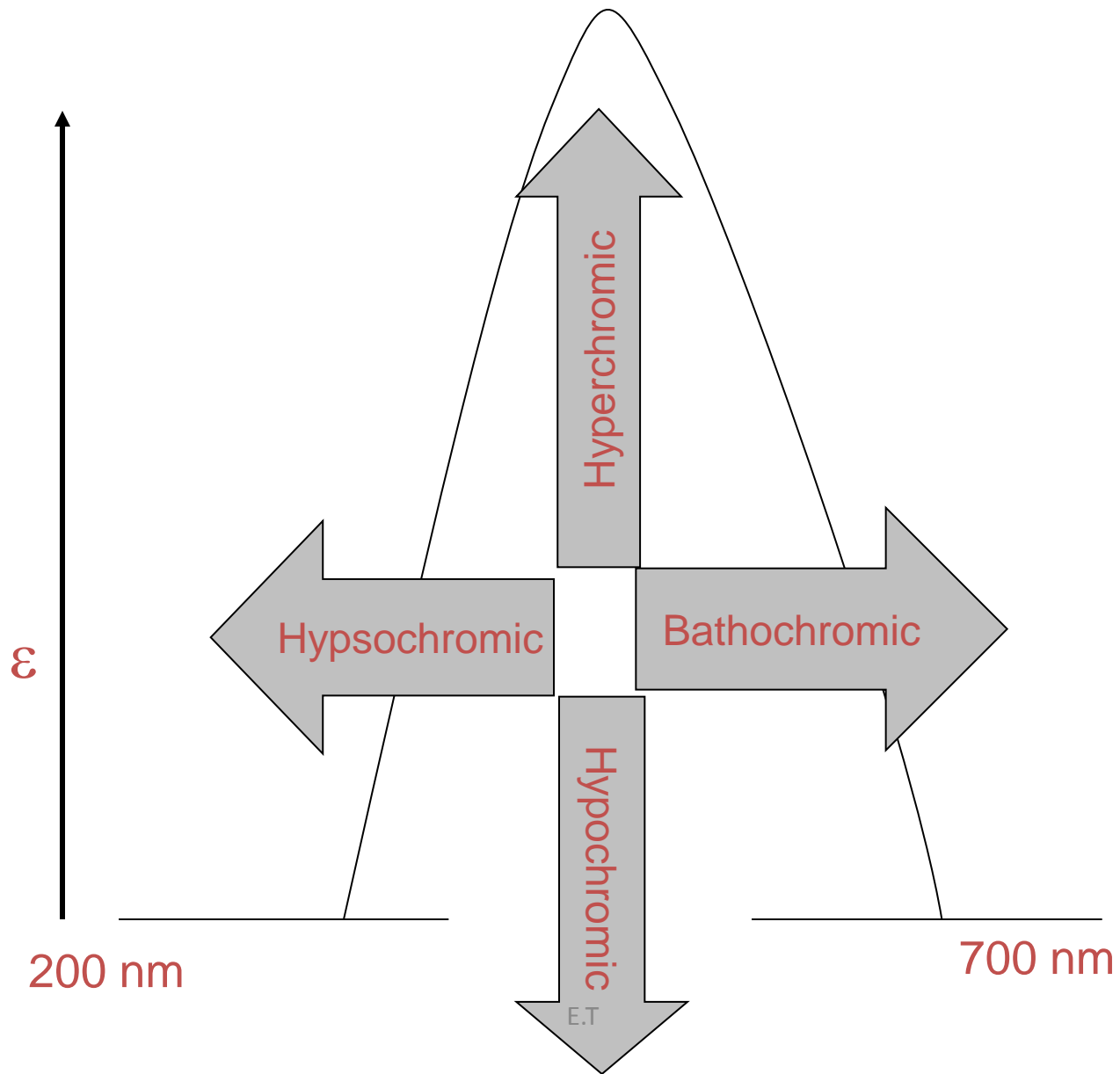

Substituent Effects

- General – Substituents may have any of four effects on a chromophore
- Bathochromic shift (red shift) – a shift to longer λ ; lower energy
- Hypsochromic shift (blue shift) – shift to shorter λ ; higher energy
- Hyperchromic effect – an increase in intensity
- Hypochromic effect - a decrease in intensity

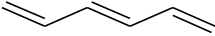
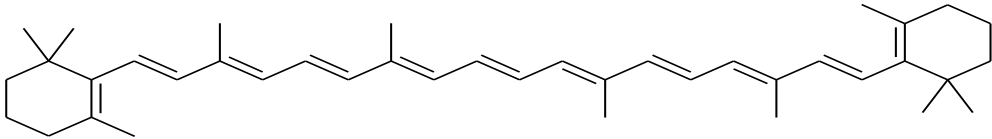

- Substituent Effects

1. **Conjugation** – most efficient means of bringing about a bathochromic and hyperchromic shift of an unsaturated chromophore:

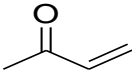
	λ_{\max} nm	ϵ
$\text{H}_2\text{C}=\text{CH}_2$	175	15,000
	217	21,000
	258	35,000
 β-carotene	465	125,000
	$n \rightarrow \pi^*$ 280	12
	$\pi \rightarrow \pi^*$ 189	900
	$n \rightarrow \pi^*$ 280	27
	$\pi \rightarrow \pi^*$ 213	7,100

- Substituent Effects

- 2. Conjugation – Alkenes

Extending this effect out to longer conjugated systems the energy gap becomes progressively smaller:

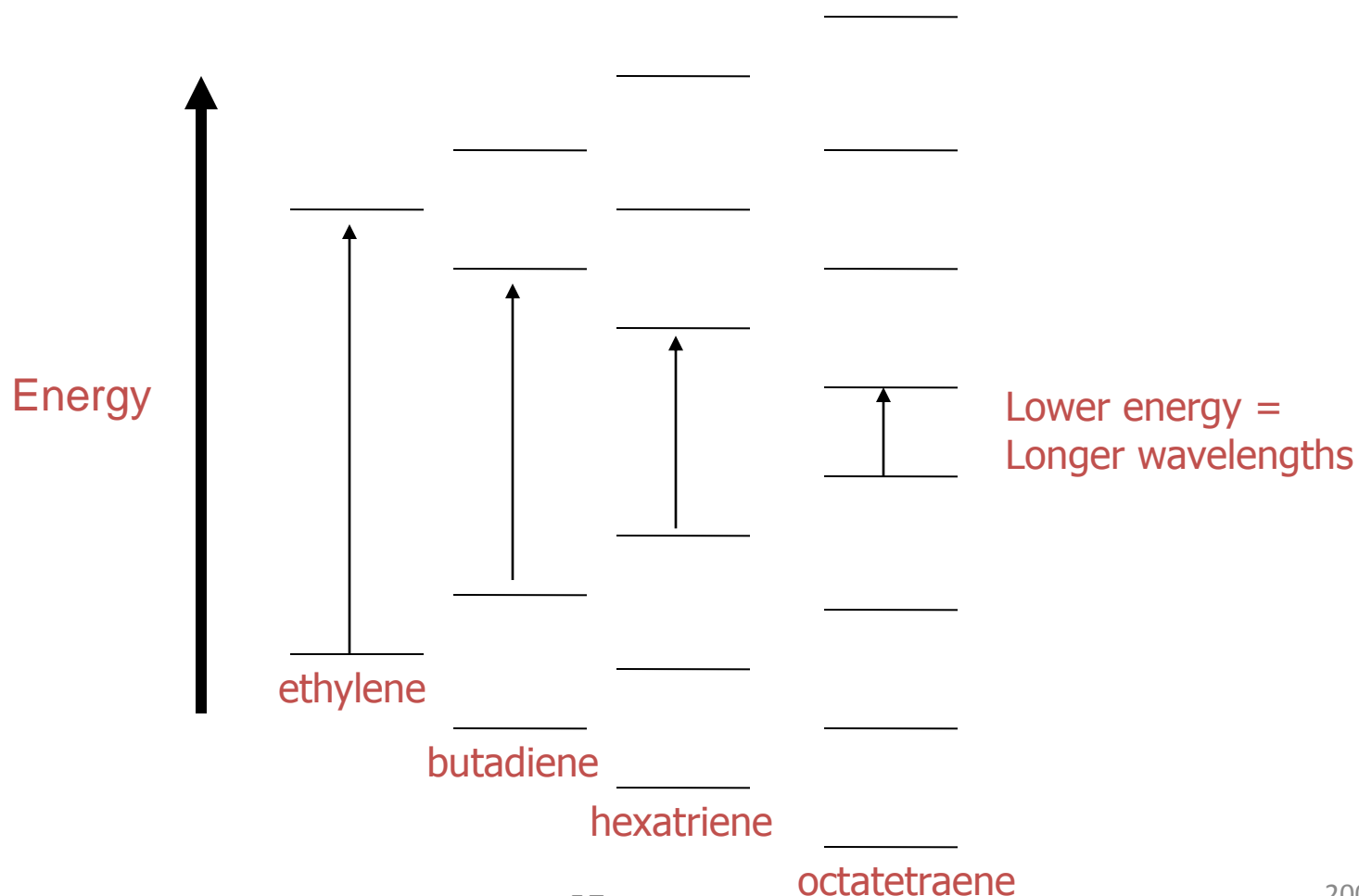

Activity 1

What type of shift observed in 1&2,3&5 and 4&6

- 1. $\text{CH}_3\text{-COH}$
 2. $\text{CH}_3\text{-COCl}$

λ_{max}

293 nm

235 nm

ϵ_{max}

12

53

Hypsochromic
&
Hyperchromic

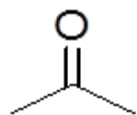

3. $n \rightarrow \pi^*$

4. $\pi \rightarrow \pi^*$

280

189

3&5

Hyperchromic

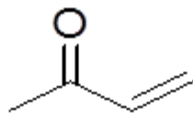

5. $n \rightarrow \pi^*$

6. $\pi \rightarrow \pi^*$

280

213

12

900

4&6

Bathochromic
&
Hyperchromic

27

7,100

- We will find that the effect of substituent groups can be reliably quantified from empirical observation of known conjugated structures and applied to new systems
- This quantification is referred to as the Woodward-Fieser Rules which we will apply to two specific chromophores:
 1. Conjugated dienes
 2. Aromatic systems

A. Dienes

1. General Features

For acyclic butadiene, two conformers are possible – s-cis and s-trans

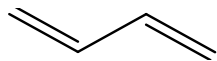

s-trans

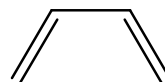

s-cis

The s-cis conformer is at an overall higher potential energy than the s-trans; therefore the HOMO electrons of the conjugated system have less of a jump to the LUMO – lower energy, longer wavelength

A. Dienes

1. General Features

Two possible $\pi \rightarrow \pi^*$ transitions can occur for butadiene $\Psi_2 \rightarrow \Psi_3^*$ and $\Psi_2 \rightarrow \Psi_4^*$

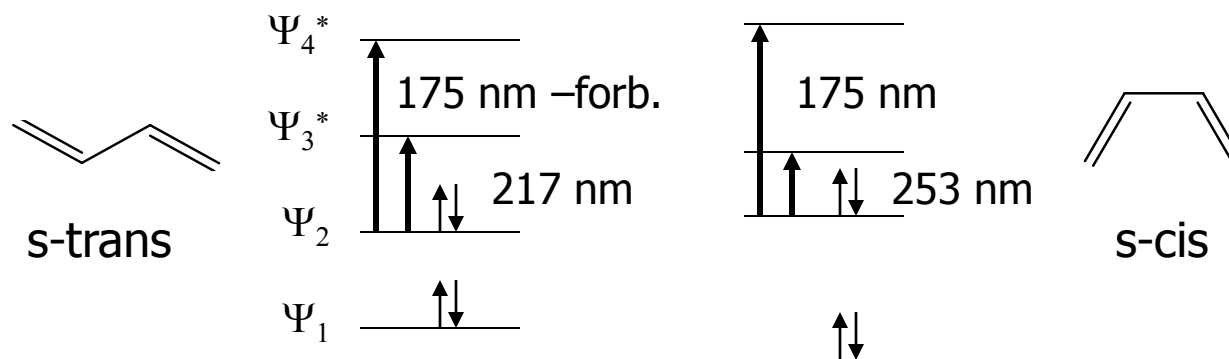

The $\Psi_2 \rightarrow \Psi_4^*$ transition is not typically observed:

- The energy of this transition places it outside the region typically observed – 175 nm
- For the more favorable s-trans conformation, this transition is forbidden

The $\Psi_2 \rightarrow \Psi_3^*$ transition is observed as an intense absorption

A. Dienes

1. General Features

The $\Psi_2 \rightarrow \Psi_3^*$ transition is observed as an intense absorption ($\epsilon = 20,000+$) based at 217 nm within the observed region of the UV

While this band is insensitive to solvent (as would be expected) it is subject to the bathochromic and hyperchromic effects of alkyl substituents as well as further conjugation

Consider:

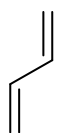

$$\lambda_{\max} = 217$$



$$253$$

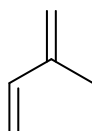

$$220$$

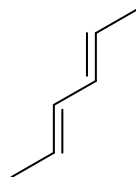

$$227$$

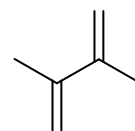

$$227$$

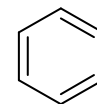

$$256$$

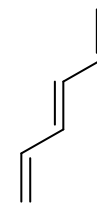

$$263 \text{ nm}$$

A. Dienes

2. Woodward-Fieser Rules - Dienes

The rules begin with a base value for λ_{\max} of the chromophore being observed:

acyclic butadiene = 217 nm



The incremental contribution of substituents is added to this base value from the group tables:

Group	Increment
Extended conjugation	+30
Each exo-cyclic C=C	+5
Alkyl	+5
-OCOCH ₃	+0
-OR	+6
-SR	+30
-Cl, -Br	+5
-NR ₂	+60

A. Dienes

2. Woodward-Fieser Rules - Dienes

For example:

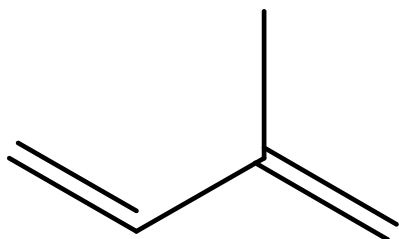

Isoprene - acyclic butadiene =	217 nm
one alkyl subs.	<u>+ 5 nm</u>
	222 nm
Experimental value	220 nm

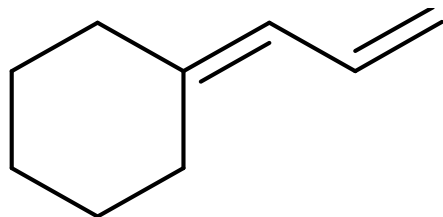

Allylidencyclohexane	
- acyclic butadiene =	217 nm
one exocyclic C=C	+ 5 nm
2 alkyl subs.	<u>+10 nm</u>
	232 nm
Experimental value	237 nm

Calculate wavelengths for the following compounds by using Woodward-Fieser Rules

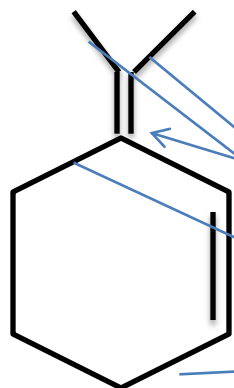

- acyclic butadiene = 217 nm

one exocyclic C=C + 5 nm

4 alkyl subs. +20 nm

242 nm

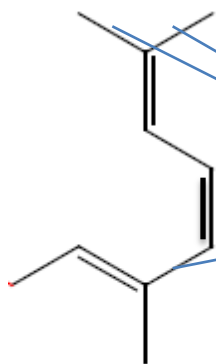

- acyclic butadiene = 217 nm

3 alkyl subs. +15 nm

232 nm

A. Dienes

3. Woodward-Fieser Rules – Cyclic Dienes

There are two major types of cyclic dienes, with two different base values

Heteroannular (transoid):

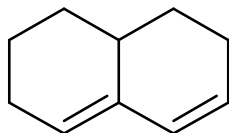

$$\varepsilon = 5,000 - 15,000$$
$$\text{base } \lambda_{\text{max}} = 214$$

Homoannular (cisoid):

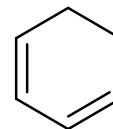

$$\varepsilon = 12,000 - 28,000$$
$$\text{base } \lambda_{\text{max}} = 253$$

The increment table is the same as for acyclic butadienes with a couple additions:

Group	Increment
Additional homoannular	+39
Where both types of diene are present, the one with the longer λ becomes the base	

A. Dienes

3. Woodward-Fieser Rules – Cyclic Dienes

For example:

1,2,3,7,8,8a-hexahydro-8a-methylnaphthalene
heteroannular diene = 214 nm

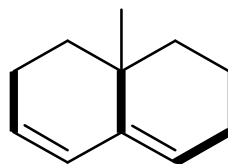
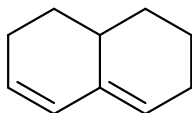
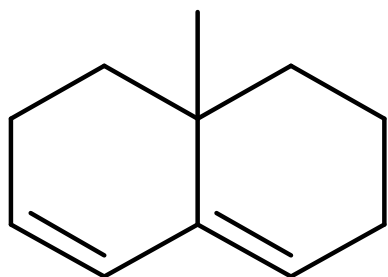

3 alkyl subs. (3 x 5)

+15 nm

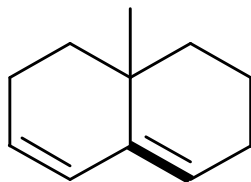

1 exo C=C

+ 5 nm
234 nm

Experimental value

235 nm

A. Dienes

3. Woodward-Fieser Rules – Cyclic Dienes

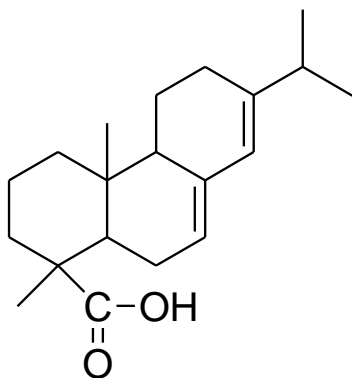

heteroannular diene = 214 nm

4 alkyl subs. (4 x 5) +20 nm

1 exo C=C + 5 nm

239 nm

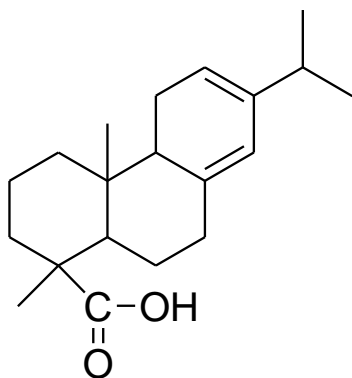

homoannular diene = 253 nm

4 alkyl subs. (4 x 5) +20 nm

1 exo C=C + 5 nm

278 nm

A. Dienes

3. Woodward-Fieser Rules – Cyclic Dienes

Be careful with your assignments – three common errors:

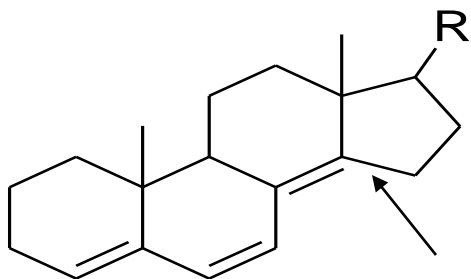

This compound has three exocyclic double bonds; the indicated bond is exocyclic to two rings

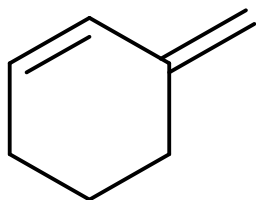

This is not a heteroannular diene; you would use the base value for an acyclic diene

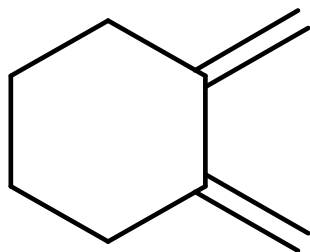

Likewise, this is not a homoannular diene; you would use the base value for an acyclic diene

Calculate wavelengths for the following compounds by using Woodward-Fieser Rules

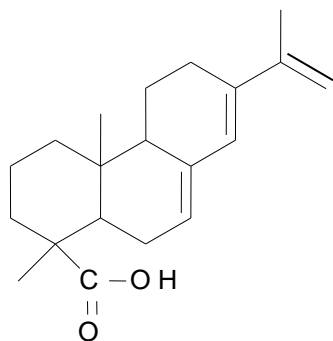

heteroannular diene =	214 nm
Extended conjugation	+ 30 nm
4 alkyl subs. (4 x 5)	+20 nm
1 exo C=C	<u>+ 5 nm</u>
	269 nm

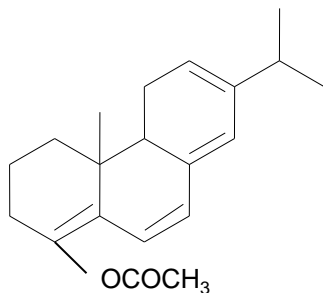

homoannular diene =	253 nm
2 Extended conjugation	+ 60 nm
5 alkyl subs. (5 x 5)	+25 nm
-OCOCH ₃	+ 0
2 exo C=C	<u>+ 10 nm</u>
	348 nm

Practical application of UV spectroscopy

1. UV was the first organic spectral method, however, it is rarely used as a primary method for structure determination
2. It is most useful in combination with NMR and IR data to elucidate unique electronic features that may be ambiguous in those methods
3. It can be used to assay (via λ_{\max} and molar absorptivity) the proper irradiation wavelengths for photochemical experiments, or the design of UV resistant paints and coatings
4. The most ubiquitous use of UV is as a detection device for HPLC; since UV is utilized for solution phase samples vs. a reference solvent this is easily incorporated into LC design

UV is to HPLC what mass spectrometry (MS) will be to GC

- Visible Spectroscopy

- A. Color

- 1. General

- The portion of the EM spectrum from 400-800 is observable to humans- we (and some other mammals) have the adaptation of seeing color at the expense of greater detail



	λ , nm
Violet	400-420
Indigo	420-440
Blue	440-490
Green	490-570
Yellow	570-585
Orange	585-620
Red	620-780

Visible Spectroscopy

Color

1. General

- When white (continuum of λ) light passes through, or is reflected by a surface, those that are absorbed are removed from the transmitted or reflected light respectively
- What is "seen" is the complimentary colors (those that are not absorbed)
- This is the origin of the "color wheel"

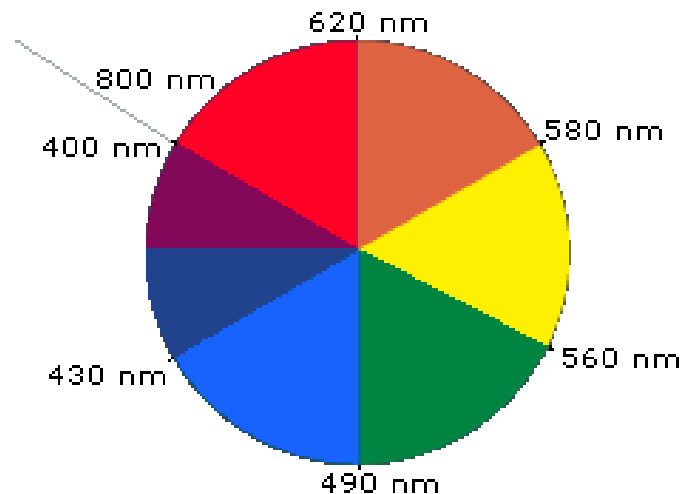

Visible Spectroscopy

- Organic compounds that are “colored” are typically those with extensively conjugated systems (typically more than five)
- Consider β -carotene

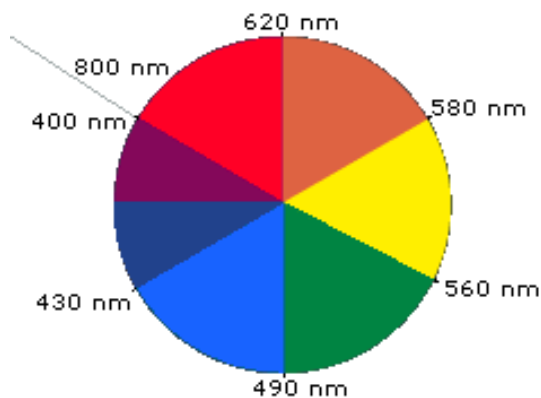
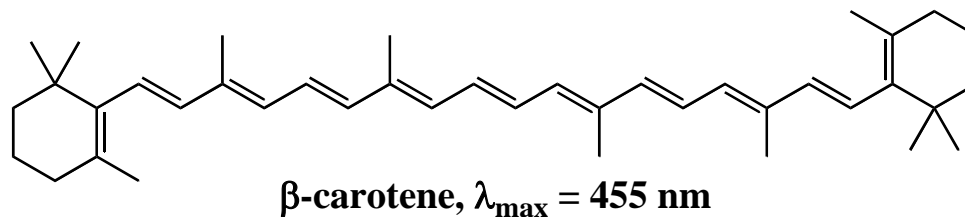

λ_{\max} is at 455 – in the far blue region of the spectrum – this is absorbed

The remaining light has the complementary color of orange

Visible Spectroscopy

- Likewise:

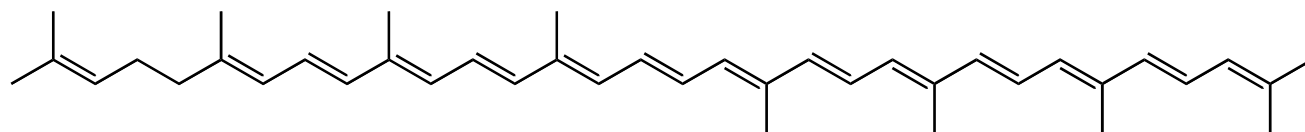

lycopene, $\lambda_{\max} = 474 \text{ nm}$

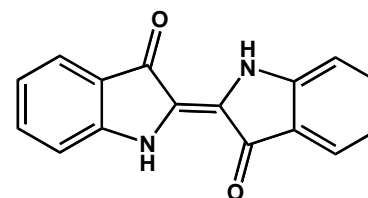

indigo

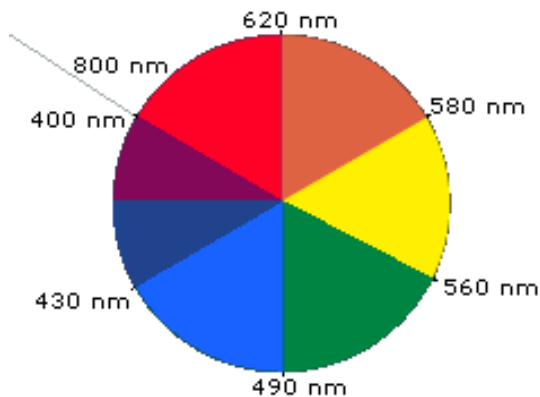

λ_{\max} for lycopene is at 474 – in the near blue region of the spectrum – this is absorbed, the complement is now red

λ_{\max} for indigo is at 602 – in the orange region of the spectrum – this is absorbed, the complement is now indigo!

One of the most common class of colored organic molecules are the azo dyes:

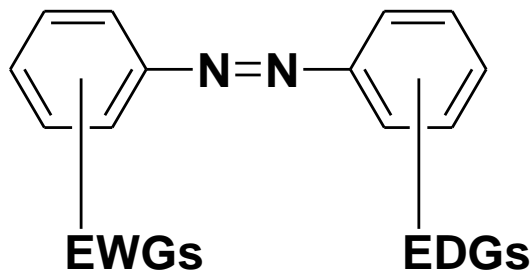

- These materials are some of the more familiar colors of our "environment"

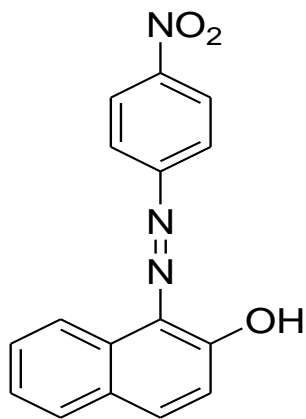

Para Red

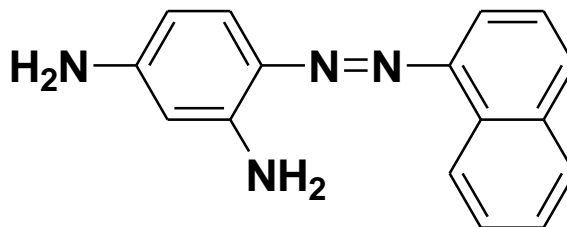

Fast Brown

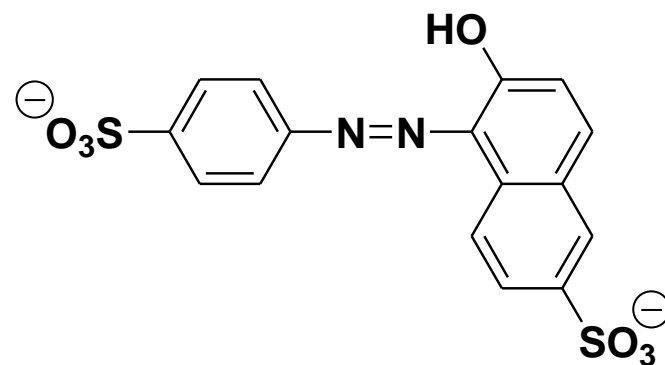

Sunset Yellow (Food Yellow 3)



- In the chemical sciences these are the acid-base indicators used for the various pH ranges:

Methyl Orange

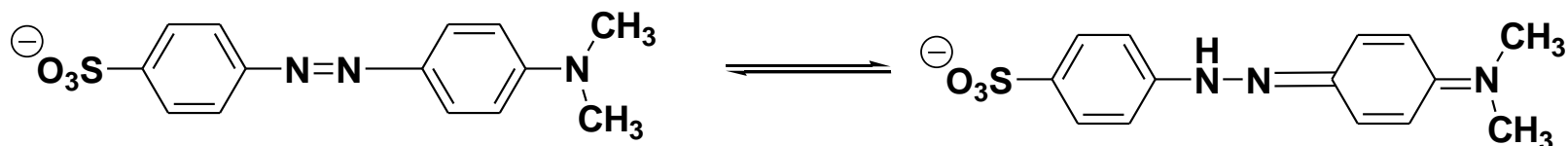

Yellow, pH > 4.4

Red, pH < 3.2

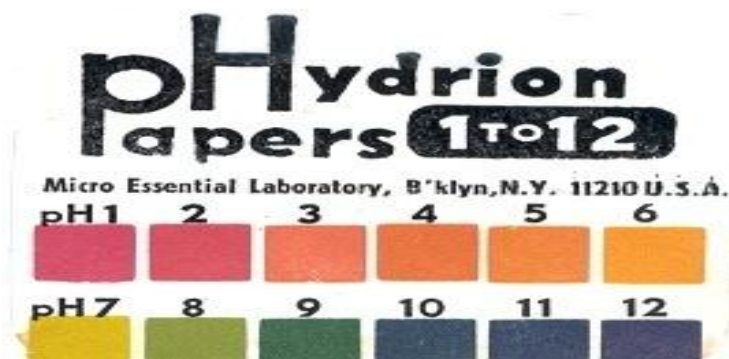

E.T

Quantitative applications of UV/Vis spectroscopy

- quantitative analysis of samples
- environmental chemistry
 - for the analysis of waters and wastewaters
- clinical chemistry
 - analysis of different analytes such as total serum protein, serum cholesterol, uric acid, glucose, protein-bound iodine
- industrial chemistry
 - for the analysis of a diverse array of industrial samples, including pharmaceuticals, food, paint, glass, and metals.
- forensic chemistry
 - blood alcohol using the Breathalyzer test

Chapter 6

Infrared Spectroscopy

determine the chemical functional groups in the sample.

- Different functional groups absorb characteristic frequencies of IR radiation.

- Using various sampling accessories, IR spectrometers

can accept a wide range of sample types such as gases,

liquids, and solids. Thus,

- IR spectroscopy is an important and popular tool for

structural elucidation and compound identification

- Infrared radiation takes a section of the electromagnetic

spectrum having wavenumbers from roughly 13,000 to 10 cm^{-1} , or wavelengths from 0.78 to $1000\text{ }\mu\text{m}$

wavenumbers are directly proportional to frequency, as well as the energy of the IR absorption

$$\bar{\nu} \text{ (in cm}^{-1}\text{)} = \frac{1}{\lambda \text{ (in } \mu\text{m)}} \times 10^4$$

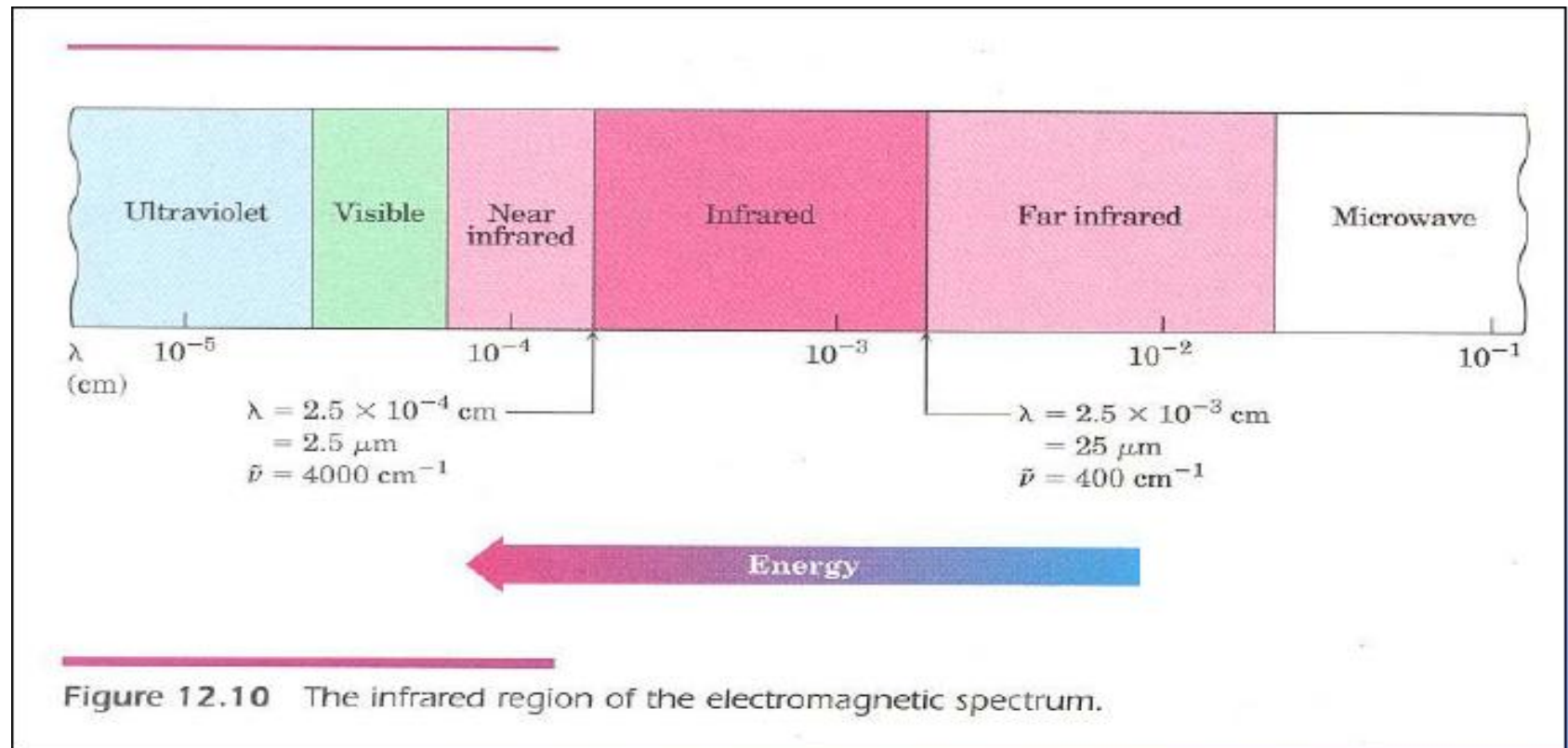

Principle: chemical bonds rotate or vibrate at specific frequencies

- Most electronic transitions require energies in the uv or

 - vis regions;

- Absorption of infrared radiation is thus confined largely

 - to molecular species for which small energy differences

 - exist between various vibrational and rotational states.

- ❖ In order to absorb infrared radiation, a molecule must

 - undergo a net change in **dipole moment** as a consequence of its vibrational or rotational motion

magnitude of

the charge difference and the distance between the two

centers of charge.

- As a hydrogen chloride molecule vibrates longitudinally, a regular fluctuation in dipole moment

occurs, and a field is established which can interact

with the electrical field associated with radiation.

- If the frequency of the radiation matches a natural vibrational frequency of the molecule, there occurs a net

transfer of energy that results in a change in the *amplitude* of the molecular vibration:

- absorption of the radiation is the

- No net change in dipole moment occurs during the vibration or rotation of homonuclear species such as O_2 , N_2 , or Cl_2 ;
 - consequently such compounds cannot absorb in the infrared

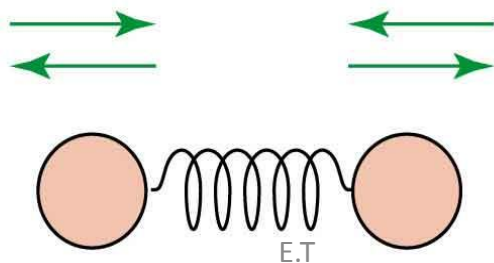
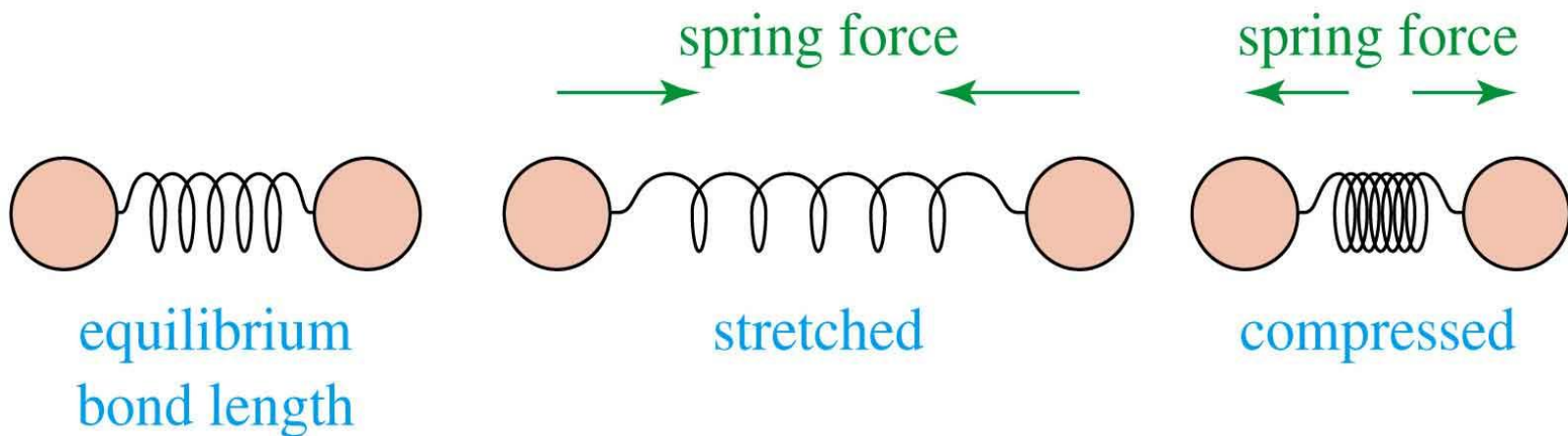

➤ Molecular Vibrations.

- The approximation is ordinarily made that the behaviour of a molecular vibration is analogous to the mechanical model. Thus, the frequency of the molecular vibration is calculated from

$$\nu_m = \frac{1}{2\pi} \sqrt{\frac{k}{\mu}} = \frac{1}{2\pi} \sqrt{\frac{k(m_1 + m_2)}{m_1 m_2}}$$

- The masses of the two atoms for m_1 and m_2 ; " the quantity k becomes the force constant for: the chemical bond,
- which is a measure of its: stiffness (but not necessarily its strength).

coordinate

axes (x, y, z).

✓ A polyatomic molecule of n atoms has $3n$ total degrees

of freedom.

✓ However, 3 degrees of freedom are required to describe

translation, the motion of the entire molecule through

space.

✓ Additionally, 3 degrees of freedom correspond to rotation of the entire molecule.

• Therefore, the remaining $3n - 6$ degrees of freedom are

true, fundamental vibrations for nonlinear molecules.

• Linear molecules possess $3n - 5$ fundamental

- Among the $3n - 6$ or $3n - 5$ fundamental vibrations (also known as normal modes of vibration),
- those that produce a net change in the dipole moment may
 - result in an IR activity
- The total number of observed absorption bands is generally different from the total number of fundamental vibrations.
- It is reduced because some modes are not IR active and a single frequency can cause more than one mode of motion to occur.
- Conversely, additional bands are generated by the appearance of overtones (integral multiples of the fundamental absorption frequencies),
- combinations of fundamental frequencies, differences of fundamental frequencies, coupling interactions of two fundamental absorption frequencies, and coupling interactions between fundamental vibrations and overtones or combination bands (Fermi resonance).

- The intensities of overtone, combination, and difference bands are less than those of the fundamental bands.
- The combination and blending of all the factors thus create a unique IR spectrum for each compound.
- The major types of molecular vibrations are stretching and bending.
- The various types of vibrations are illustrated in Fig. below
- Infrared radiation is absorbed and the associated energy is converted into these type of motions.
- The absorption involves discrete, quantized energy levels.
- However, the individual vibrational motion is usually accompanied by other rotational motions.
- These combinations lead to the absorption bands, not the discrete lines, commonly observed in the mid IR region.

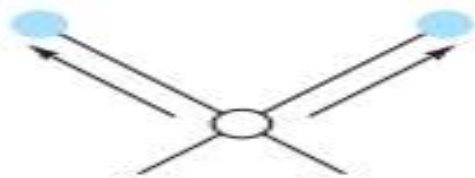

Symmetric

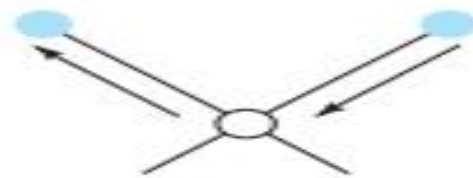

Asymmetric

(a) Stretching vibrations

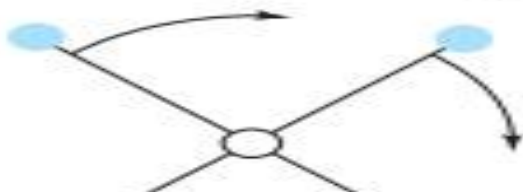

In-plane rocking



In-plane scissoring

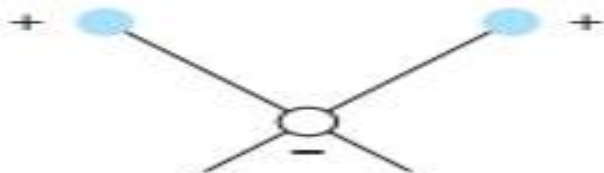

Out-of-plane wagging

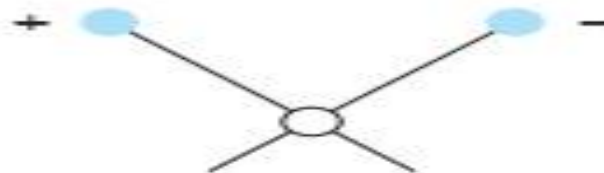

Out-of-plane twisting

(b) Bending vibrations

Figure: Types of molecular vibrations. note that + indicates motion from the page toward the reader and - indicates motion away from the reader.

Instrumentation

There are 3 types of IRs.

- Dispersive, FTIRs (Fourier Transform Infrared Spectrophotometer) and Filter photometers
- Dispersive uses heated solid source and changes frequency over time by moving grating, mirror or detector. Originally used prisms and later grating.

Detectors respond for heat than photon

- Largely replaced by Fourier Transform – Allows for all frequencies to be measured at once:

A FTIR Uses a Moving Mirror and Powerful Computer Calculations to Determine Which Wavelengths of IR Energy Were Absorbed

advantage – No slits: Better speed and sensitivity

- Filter photometers :Designed to monitor the concentration of air pollutantes such as CO

A Dispersive IR Spectrophotometer

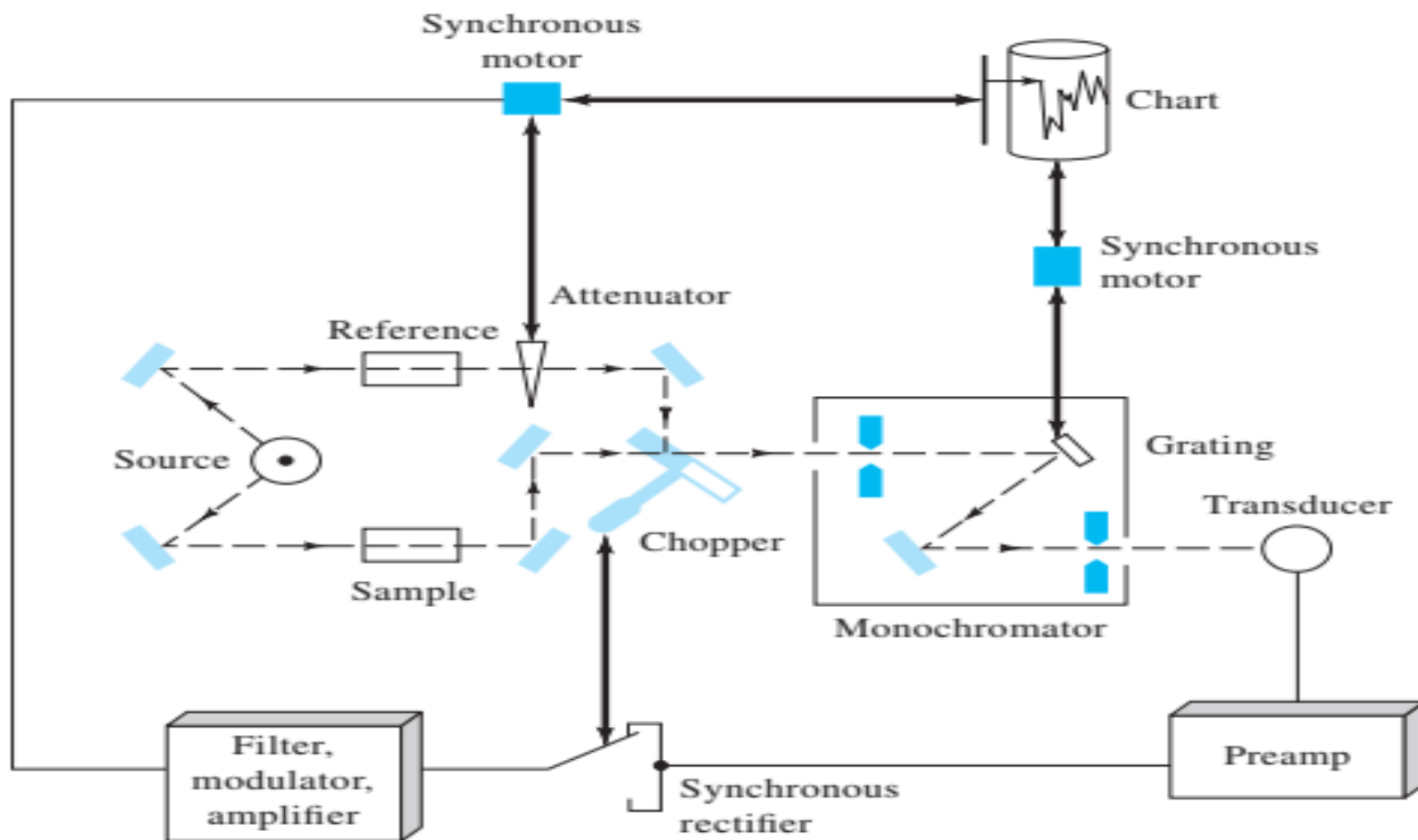
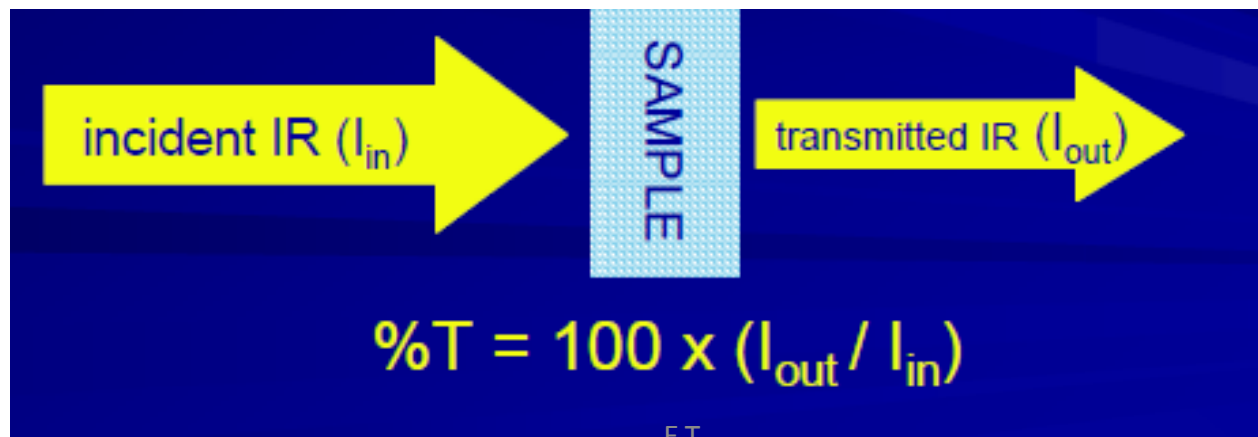

Figure: Schematic diagram of a double-beam, dispersive IR spectrophotometer. The heavy black lines indicate mechanical linkages, and the light lines indicate electrical connections. The radiation path is designated by dashed lines.

IR Spectrum

- Plot IR energy vs. %transmittance (%T)
- Energy scale in wave numbers, $\text{wn} (\text{cm}^{-1})$
- %T scale
- Compares intensity of IR striking sample (I_{in}) with intensity of IR leaving sample (I_{out})
- 100%T no light absorbed by sample
- 0% all light absorbed by sample



Record

- Wave number location of IR “band” (position of max %T)

- Intensity of IR “band”

s = strong (low %T), m = medium, w = weak (high %T)

vs = very strong, vw = very weak

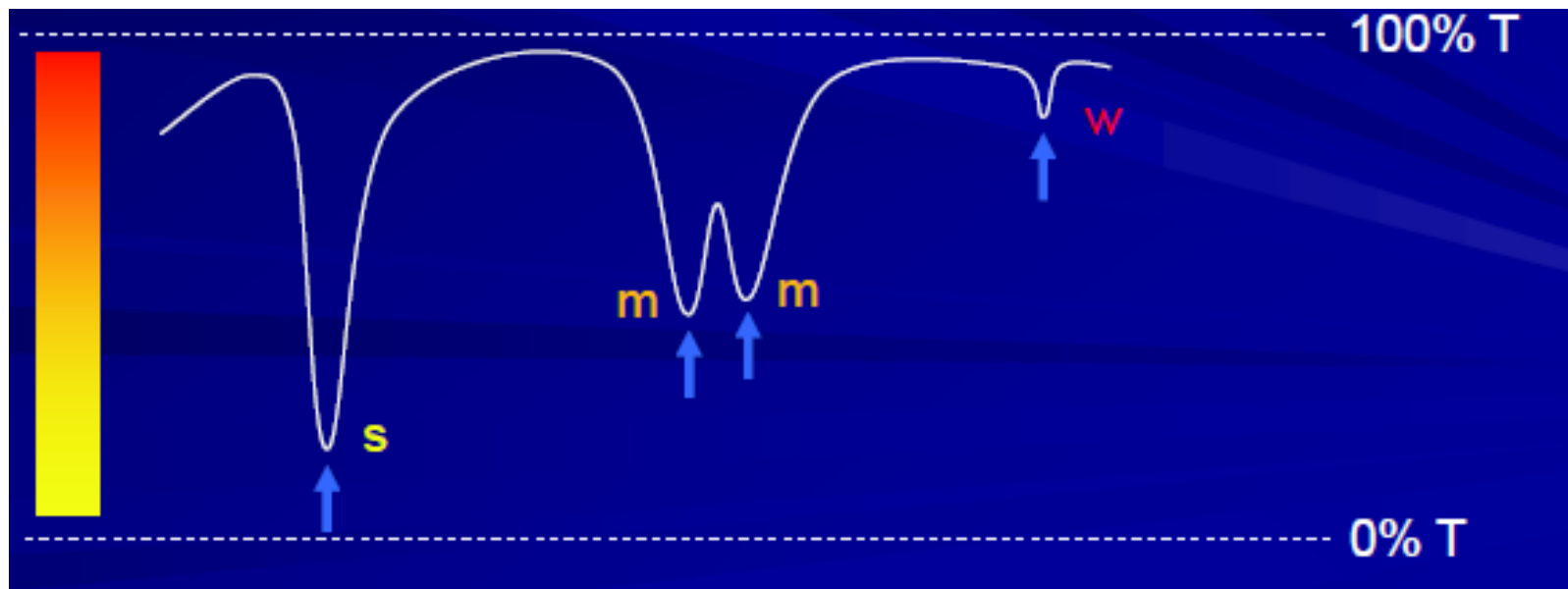

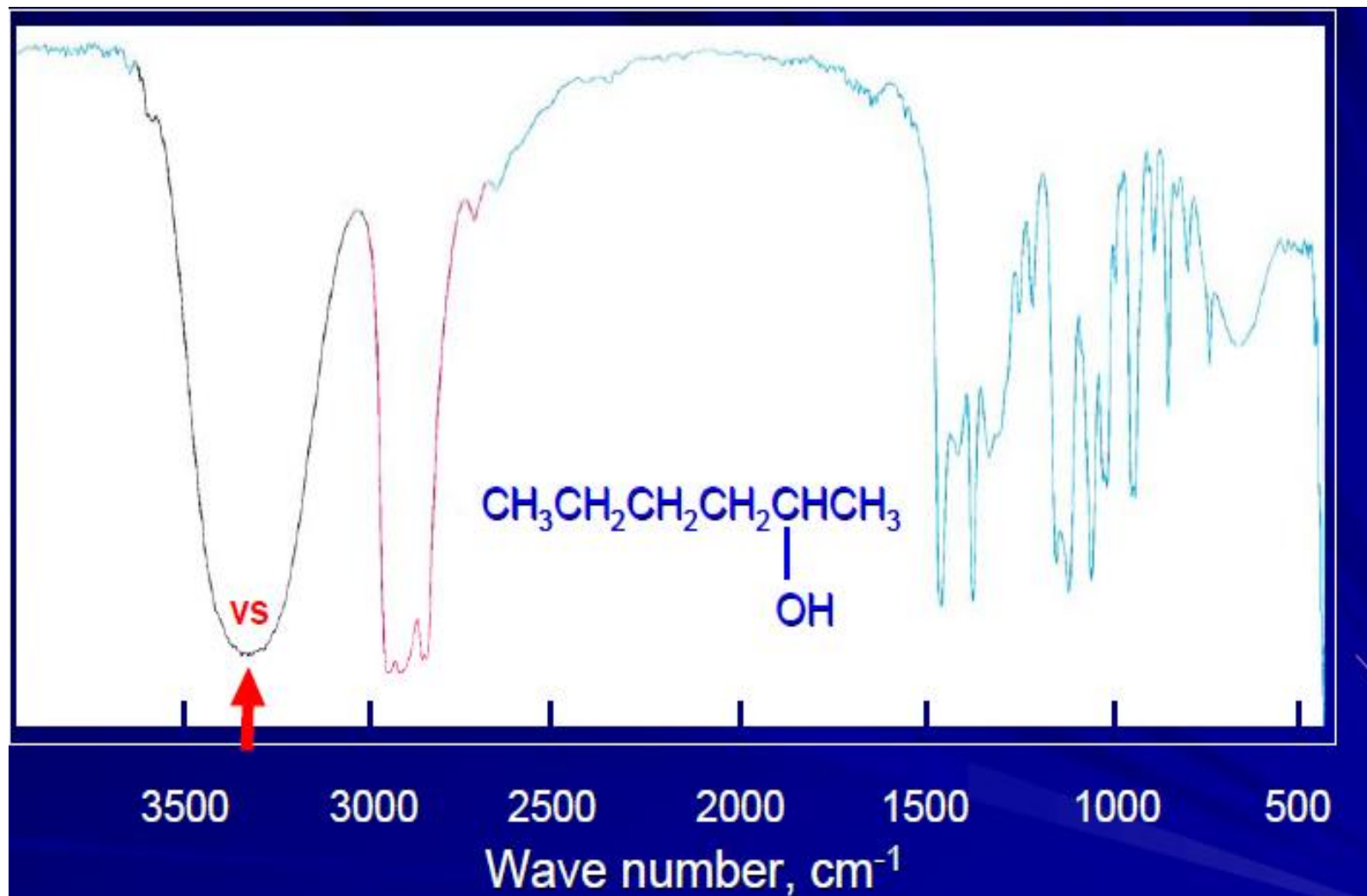

Characteristic Absorptions

Table 12.1 Characteristic IR Absorptions of Some Functional Groups

<i>Functional group class</i>	<i>Band position (cm⁻¹)</i>	<i>Intensity of absorption</i>
Alkanes, alkyl groups C—H	2850–2980	Medium to strong
Alkenes =C—H	3020–3100	Medium
C=C	1640–1680	Medium
Alkynes ≡C—H	3300	Strong
—C≡C—	2100–2260	Medium
Alkyl halides C—Cl	600–800	Strong
C—Br	500–600	Strong
C—I	500	Strong
Alcohols O—H	3400–3650	Strong, broad
C—O	1050–1150	Strong

Aromatics



3030

Medium

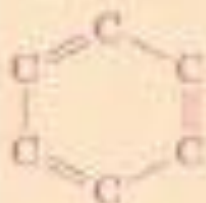

1600, 1500

Strong

Amines



3300–3500

Medium



1030, 1230

Medium

Carbonyl compounds*



1680–1750

Strong

Carboxylic acids



2500–3100

Strong, very broad

Nitriles



2210–2260

Medium

Nitro compounds



1540

Strong

*Acids, esters, aldehydes, and ketones.

IR Major Regions to Examine

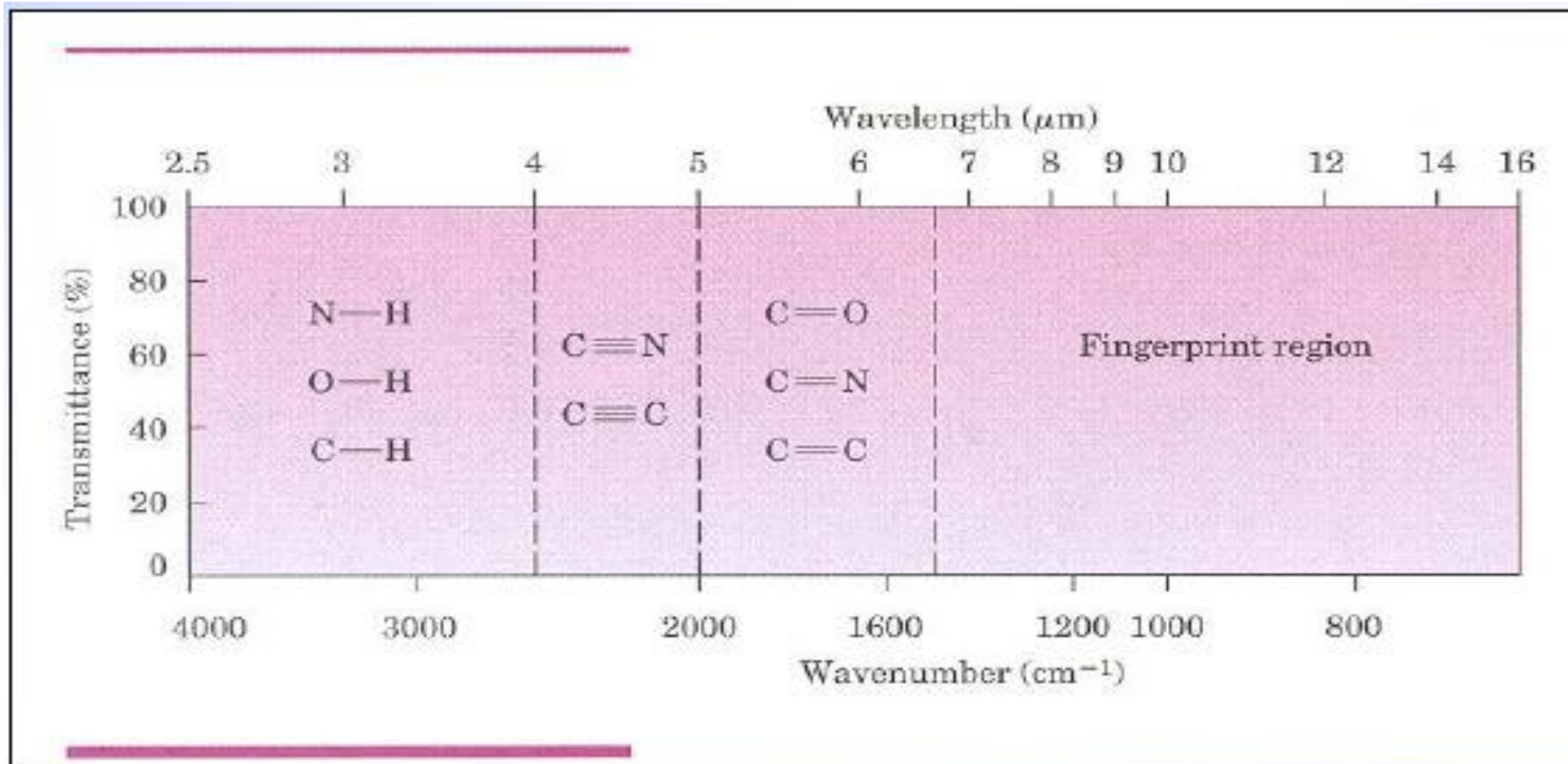

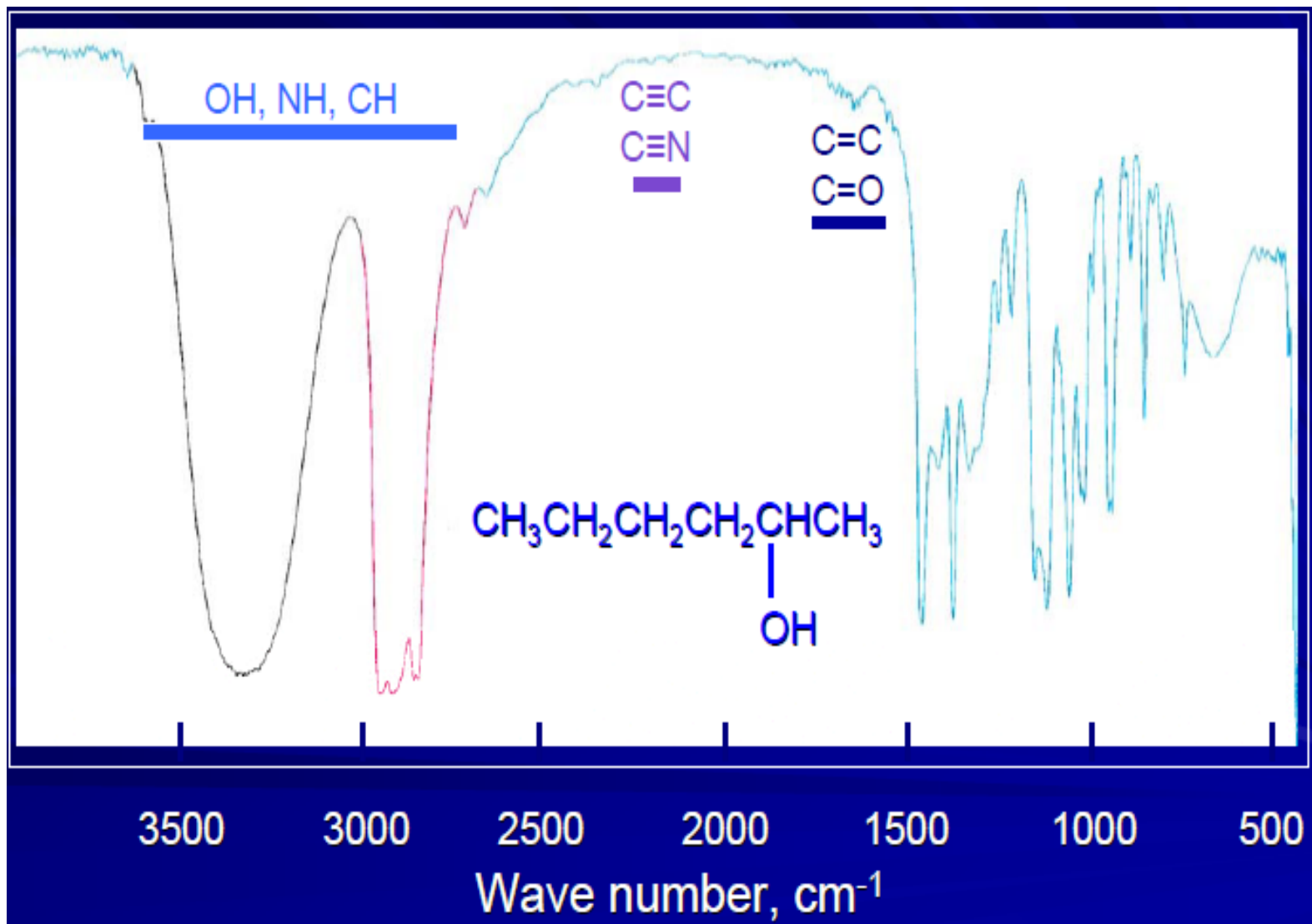

IR spectra of **ALKANES**

C—H bond “saturated”

(sp³) **2850-2960 cm⁻¹**

+ 1350-1470 cm⁻¹

-CH₂- bend + 1430-1470

-CH₃ bend + “ and 1375

-CH(CH₃)₂ + “ and 1370, 1385

-C(CH₃)₃ + “ and 1370(s), 1395 (m)

HIT-NO=1929 | SCORE= () | SDBS-NO=2475 | IR-NIDA-68185 : LIQUID FILM

PENTANE
***n*-pentane**

C₅H₁₂

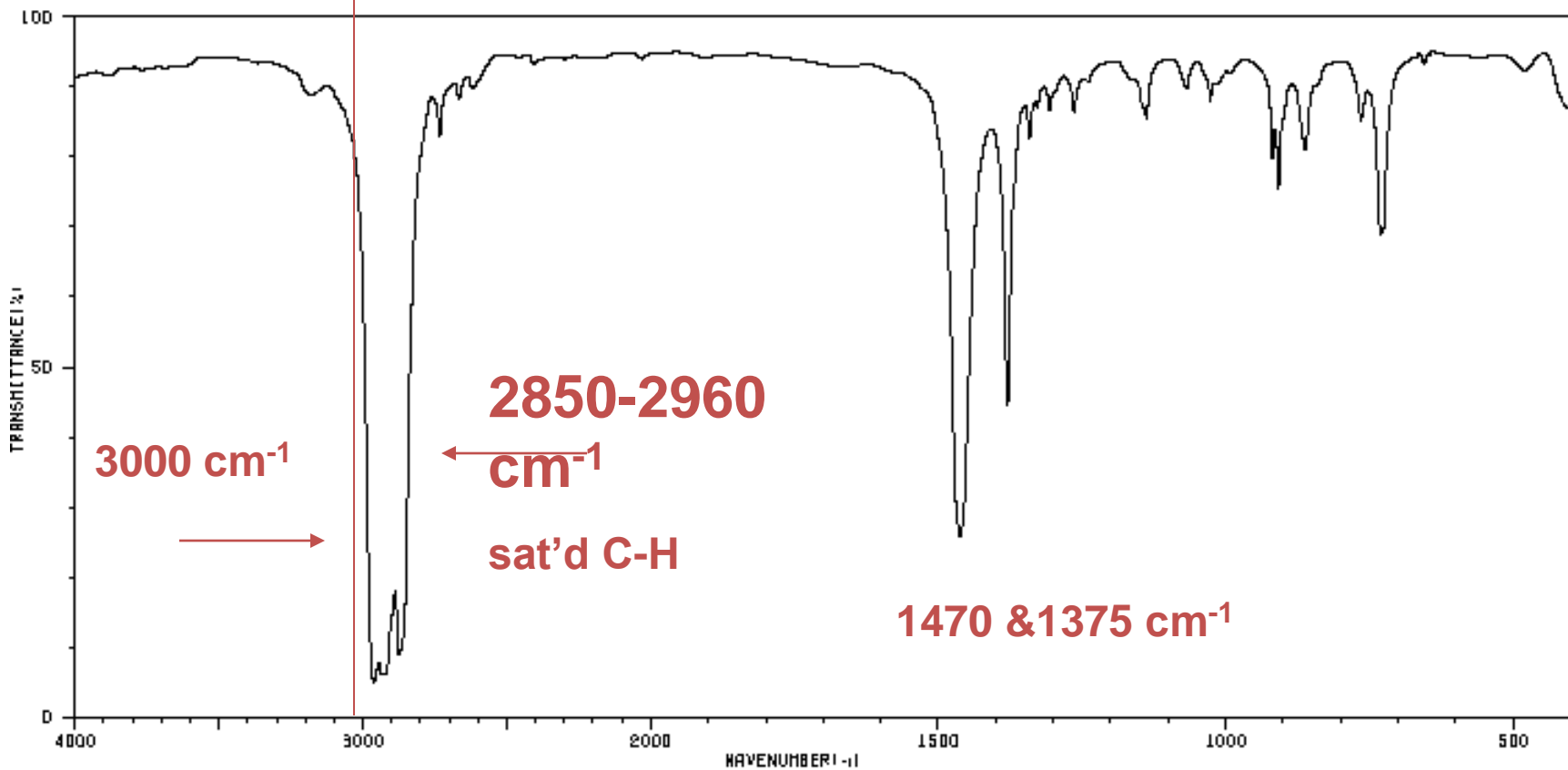

3182	86	2619	86	1138	81	732	66
3172	86	1462	24	1068	86		
2961	4	1380	45	1027	84		
2928	6	1342	78	919	77		
2875	8	1307	84	908	72		
2733	79	1264	84	862	79		
2666	84	1144	84	766	81		

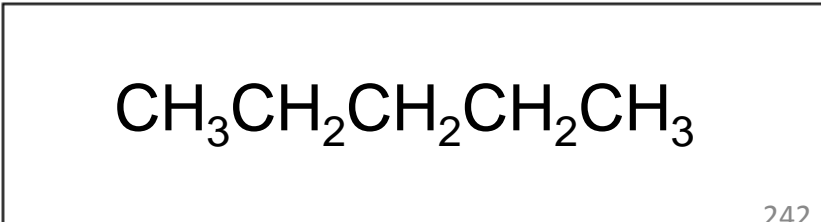

HIT-NO=1737

SCORE= ()

SDBS-NO=2118

IR-NIDA-14110 : LIQUID FILM

HEXANE

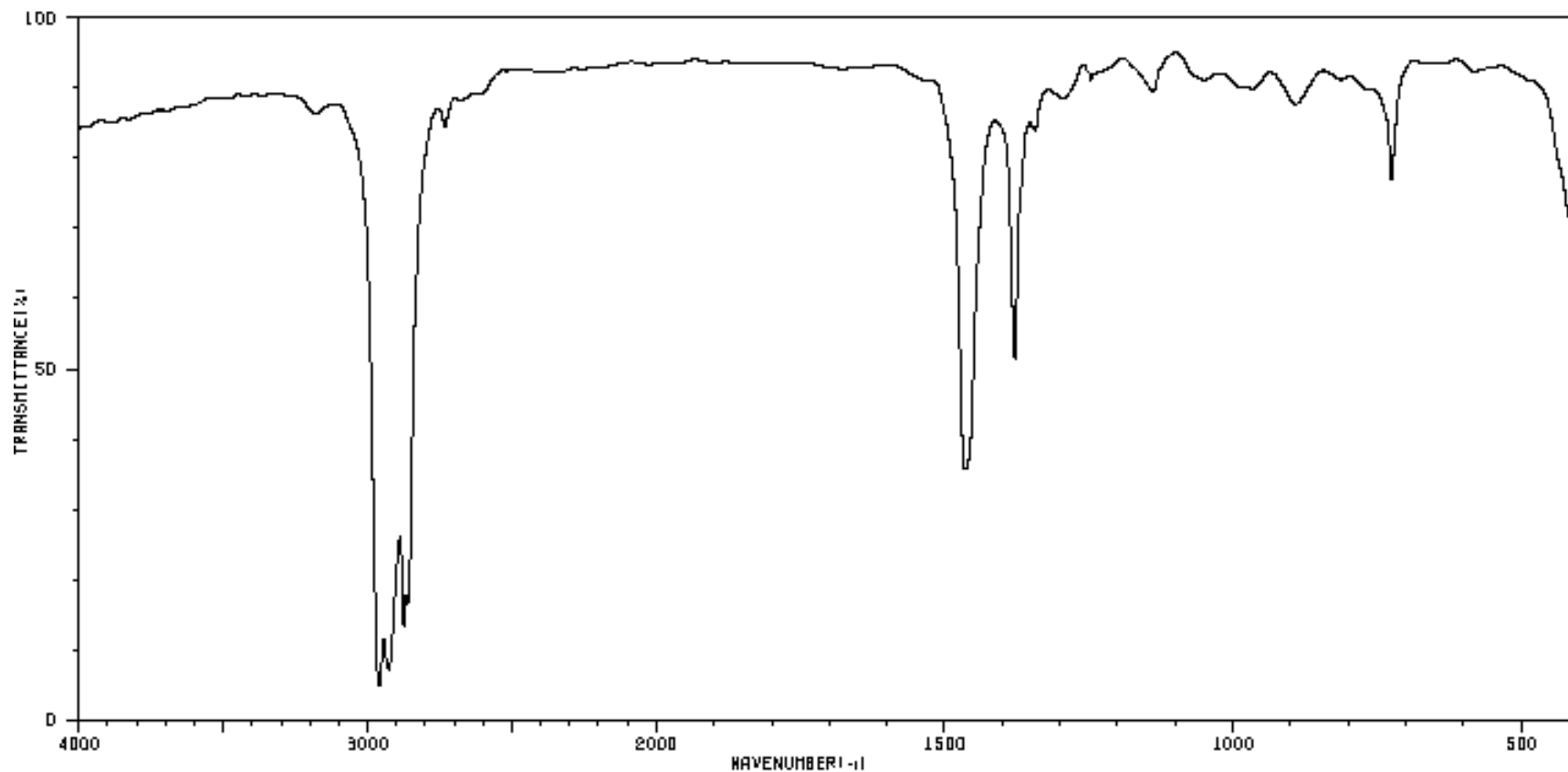
n-hexane C_6H_{14} 

3187	84	1466	34	726	74
3176	84	1379	49		
2959	4	1300	84		
2928	7	1294	84		
2875	13	1138	86		
2862	15	891	84		
2734	81	884	84		

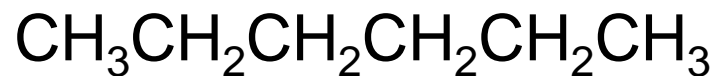

HIT-NO=4225

SCORE= ()

SDBS-NO=10633

IR-NIDA-03327 : LIQUID FILM

ISOPENTANE

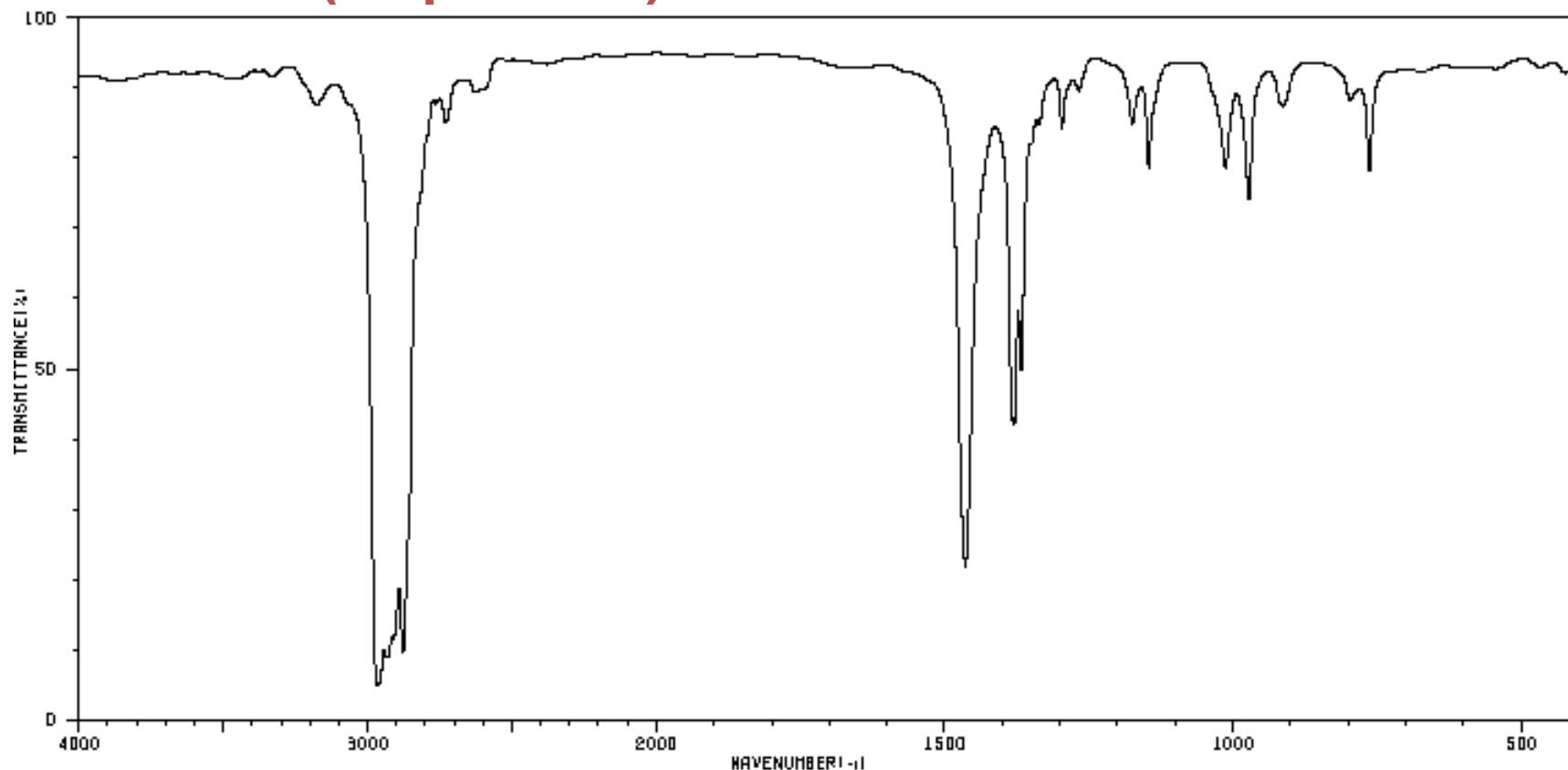
2-methylbutane C_5H_{12} **(isopentane)**

3176	84	1464	21	1013	77
2964	4	1380	41	972	70
2933	6	1368	47	913	84
2878	9	1297	81	797	84
2733	81	1268	86	764	74
2627	86	1175	81		
2604	86	1147	77		

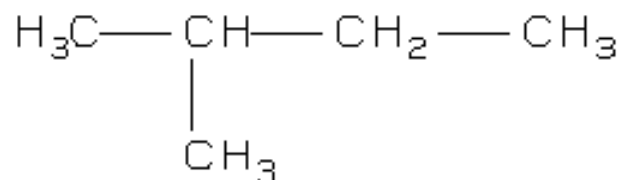

E.T

244

HIT-NO=1104 | SCORE= () | SDBS-NO=654 | IR-NIDA-02888 : LIQUID FILM

2,3-DIMETHYLBUTANE

2,3-dimethylbutane

C₆H₁₄

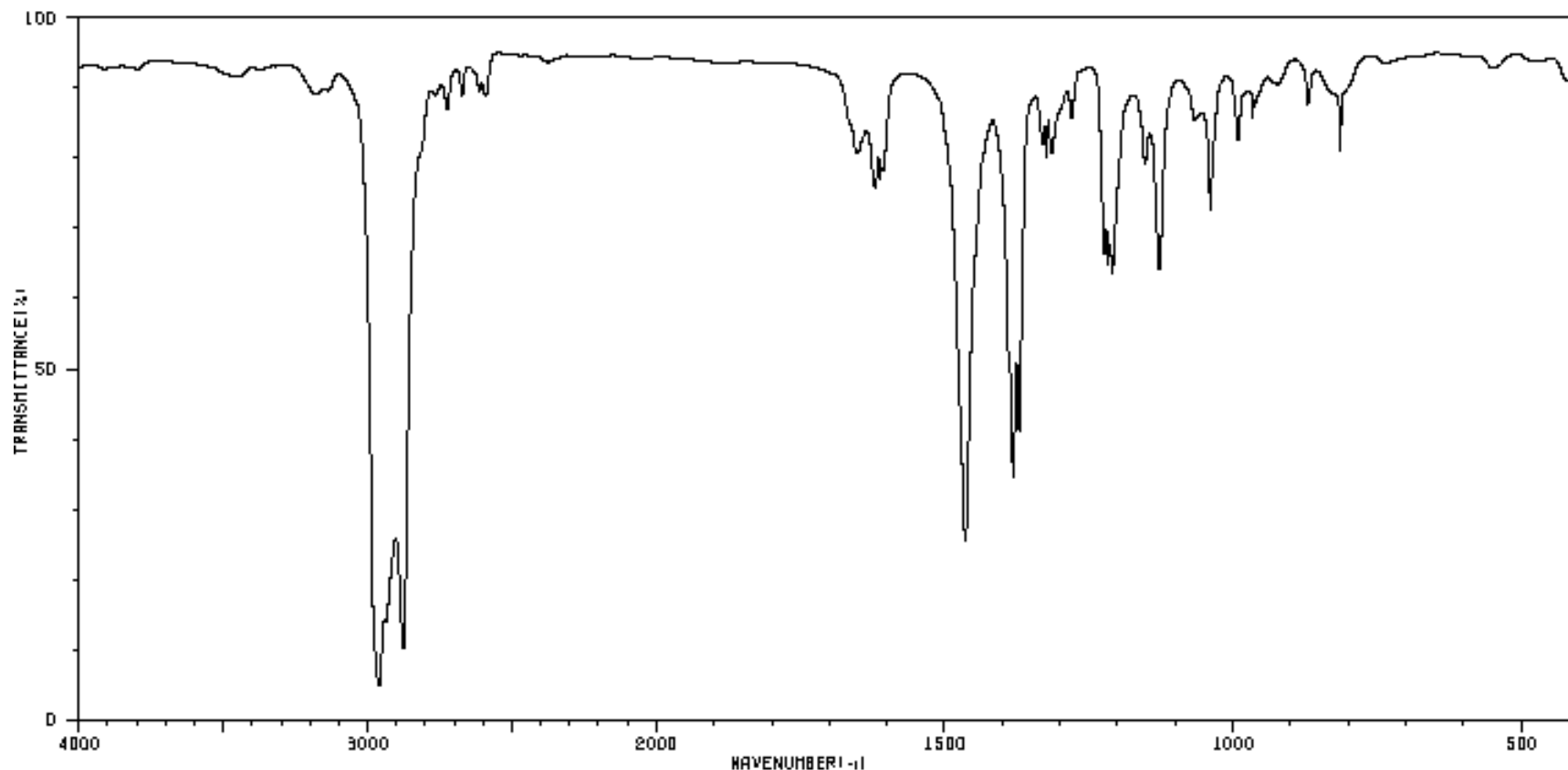

3176	86	2691	86	1381	33	1218	62	960	84
2959	4	1651	77	1371	39	1209	60	870	84
2938	13	1621	72	1330	79	1153	77	823	86
2876	9	1613	74	1323	77	1128	62	814	79
2722	84	1607	74	1315	77	1039	70		
2673	86	1454	24	1280	81	991	79		
2614	86	1389	48	1223	64	966	81		

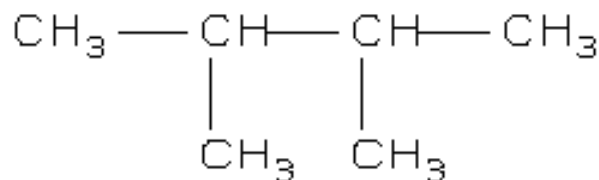

F.T.

245

HIT-NO=1236

SCORE= ()

SDBS-NO=897

IR-NIDA-05221 : LIQUID FILM

CYCLOHEXANE

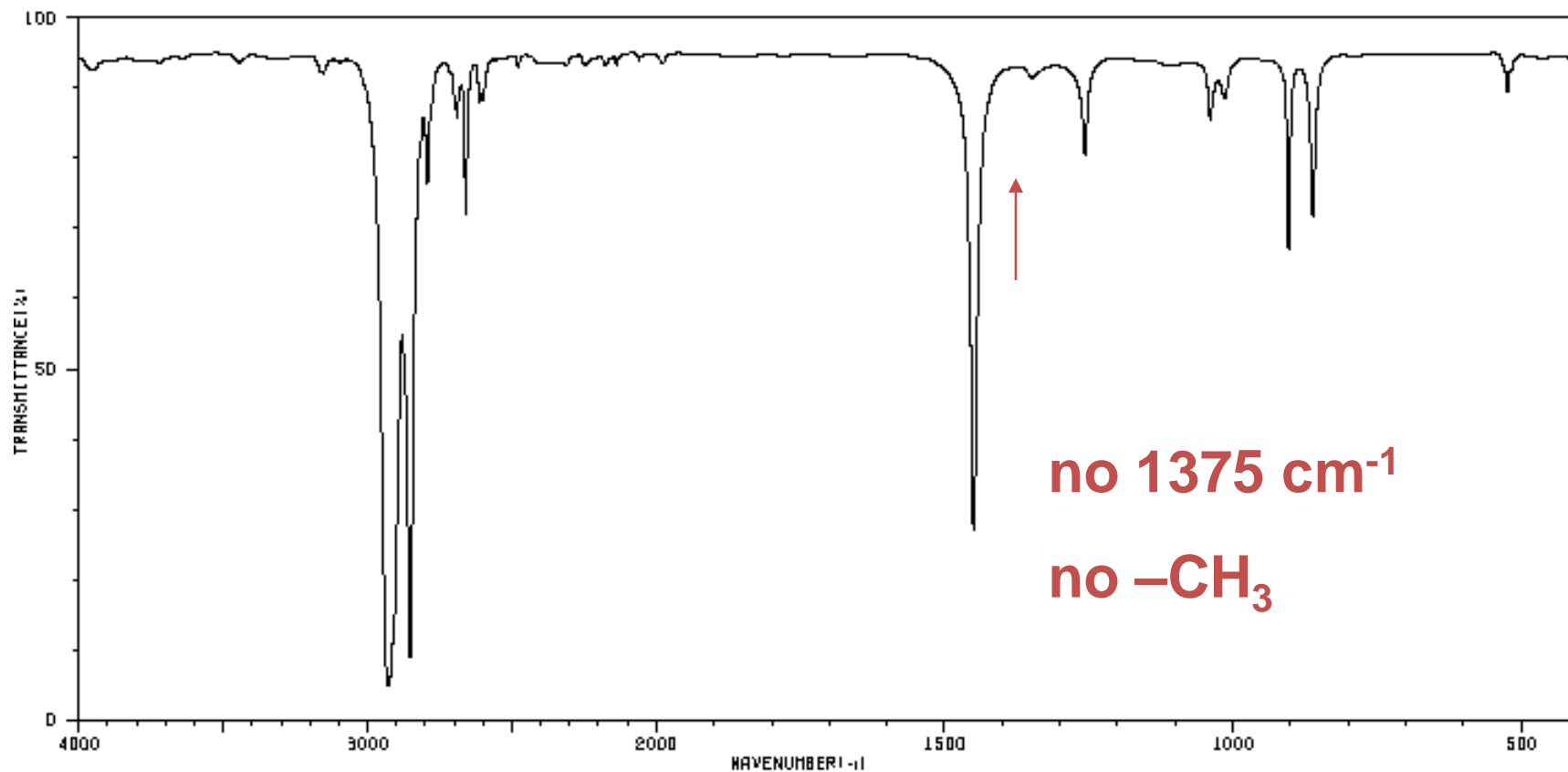
cyclohexane C_6H_{12} 

2928	4	1460	26
2853	8	1257	77
2794	72	1039	81
2690	81	1016	84
2661	70	904	64
2613	84	862	68
2599	84	624	86

E.T

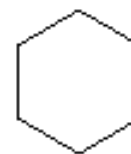

246

IR of **ALKENES**

=C—H bond, “unsaturated” vinyl

(sp²) **3020-3080 cm⁻¹**

bend + 675-1000

RCH=CH₂ + 910-920 & 990-1000

R₂C=CH₂ + 880-900

cis-RCH=CHR + 675-730 (v)

trans-RCH=CHR +965-975

C=C bond **1640-1680 cm⁻¹ (v)**

HIT-NO=1698

SCORE= ()

SDBS-NO=2024

IR-NIDA-04854 : LIQUID FILM

1-DECENE

1-decene

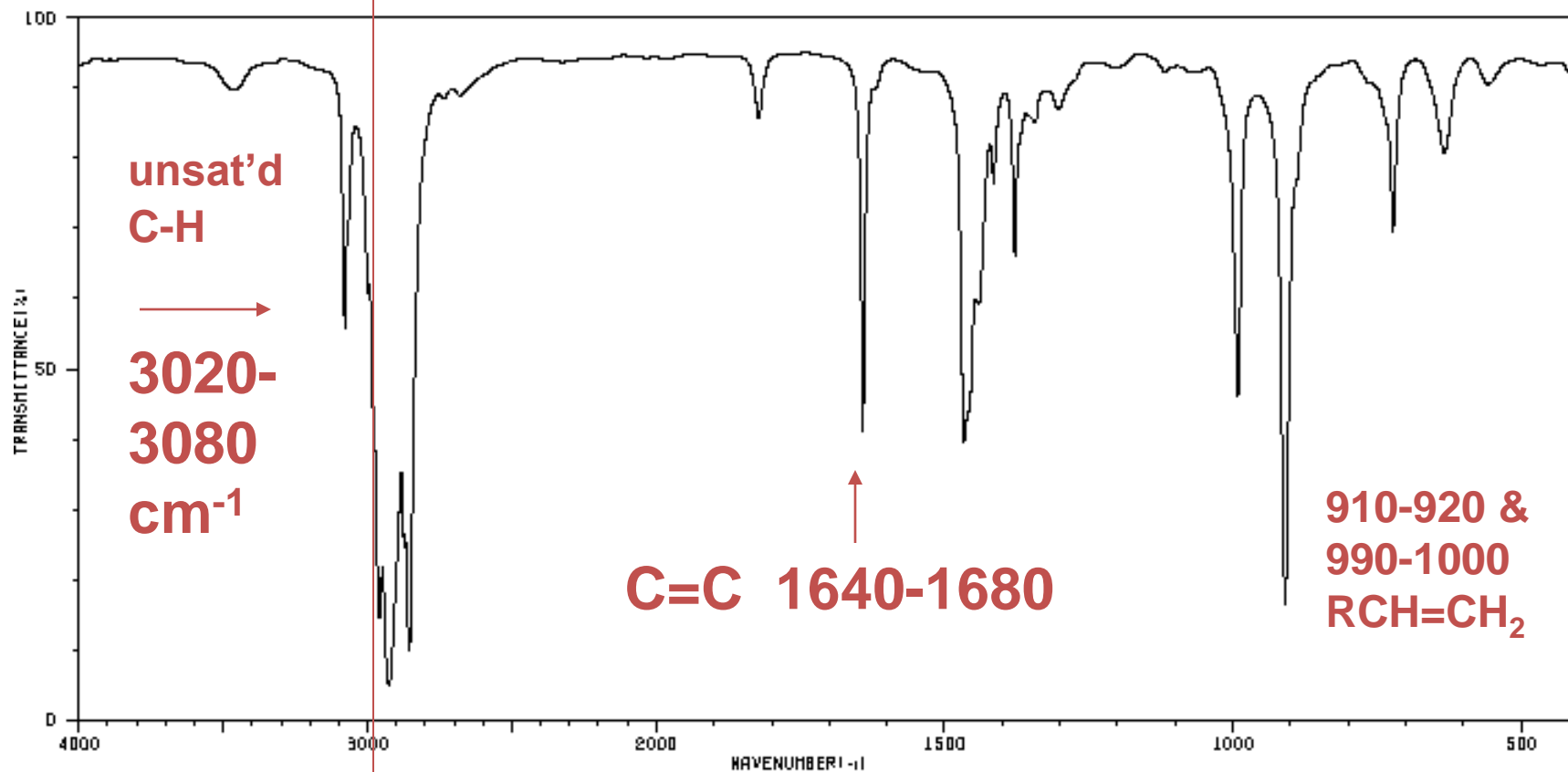
 $C_{10}H_{20}$ 

3467	86	2874	29	1379	64
3457	86	2856	9	1343	81
3079	53	2678	86	1303	84
3068	68	1822	81	991	44
2998	58	1642	39	910	15
2958	13	1467	38	723	86
2926	4	1416	72	633	77

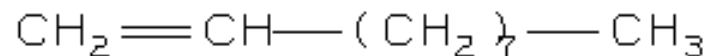

HIT-NO=897

SCORE= ()

SDBS-NO=212

IR-NIDA-03077 : LIQUID FILM

4-METHYL-1-PENTENE

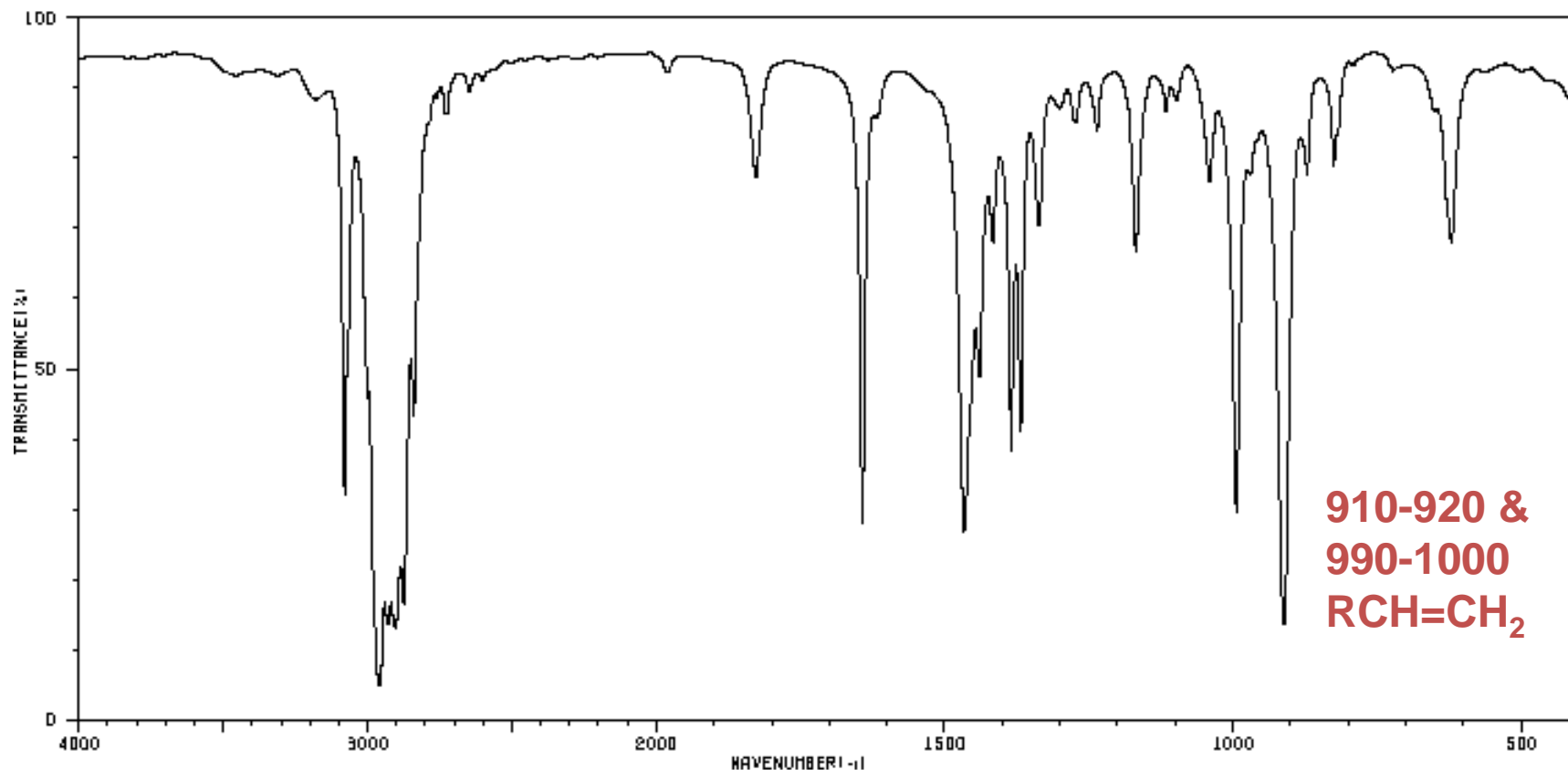
4-methyl-1-pentene C_6H_{12} 

3178	84	2727	84	1385	37	1116	84	622	56
3079	31	2648	86	1368	39	1098	84		
2960	4	1828	74	1337	86	1041	74		
2929	13	1643	26	1300	84	994	28		
2904	12	1467	26	1274	81	911	13		
2874	15	1440	47	1236	81	871	74		
2839	42	1417	66	1169	64	826	77		

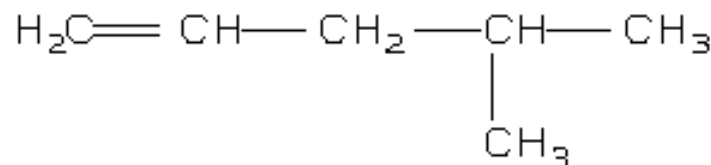

F.T.

HIT-NO=1774 | SCORE= () | SDBS-NO=2176 | IR-NIDA-03075 : LIQUID FILM

2-METHYL-1-BUTENE

2-methyl-1-butene

C₅H₁₀

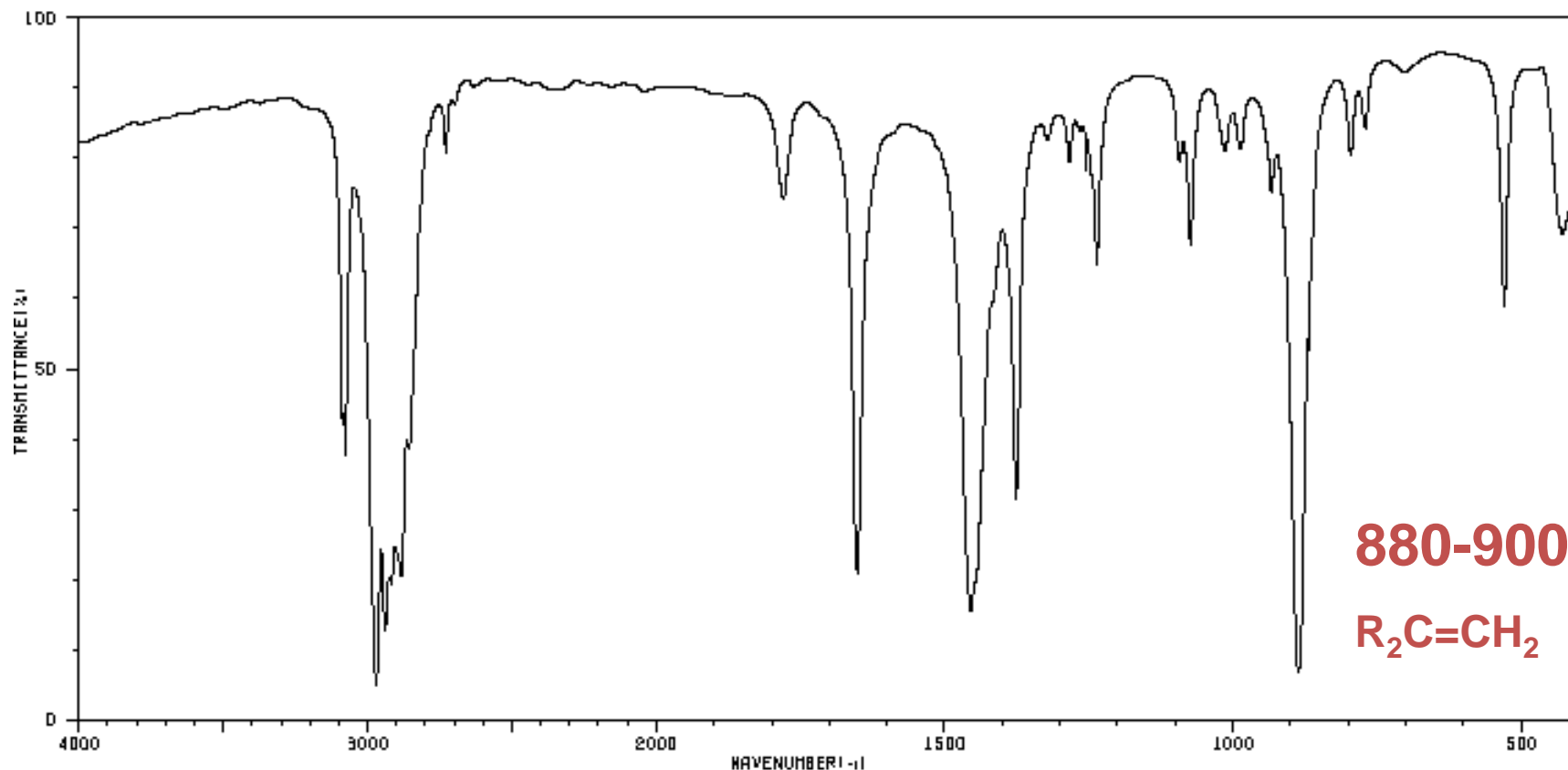

3087	41	2728	77	1266	74	887	6
3077	36	1780	72	1237	62	869	50
2970	4	1651	20	1093	77	796	77
2939	12	1466	14	1074	64	770	81
2919	18	1377	30	1014	79	530	57
2883	20	1322	79	987	79	429	66
2866	37	1284	77	933	72		

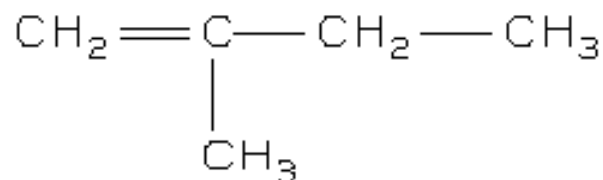

E.T

250

HIT-NO=2801 SCORE= () SDBS-NO=4815 IR-NIDA-03377 : LIQUID FILM

2,3-DIMETHYL-1-BUTENE

2,3-dimethyl-1-butene

C₆H₁₂

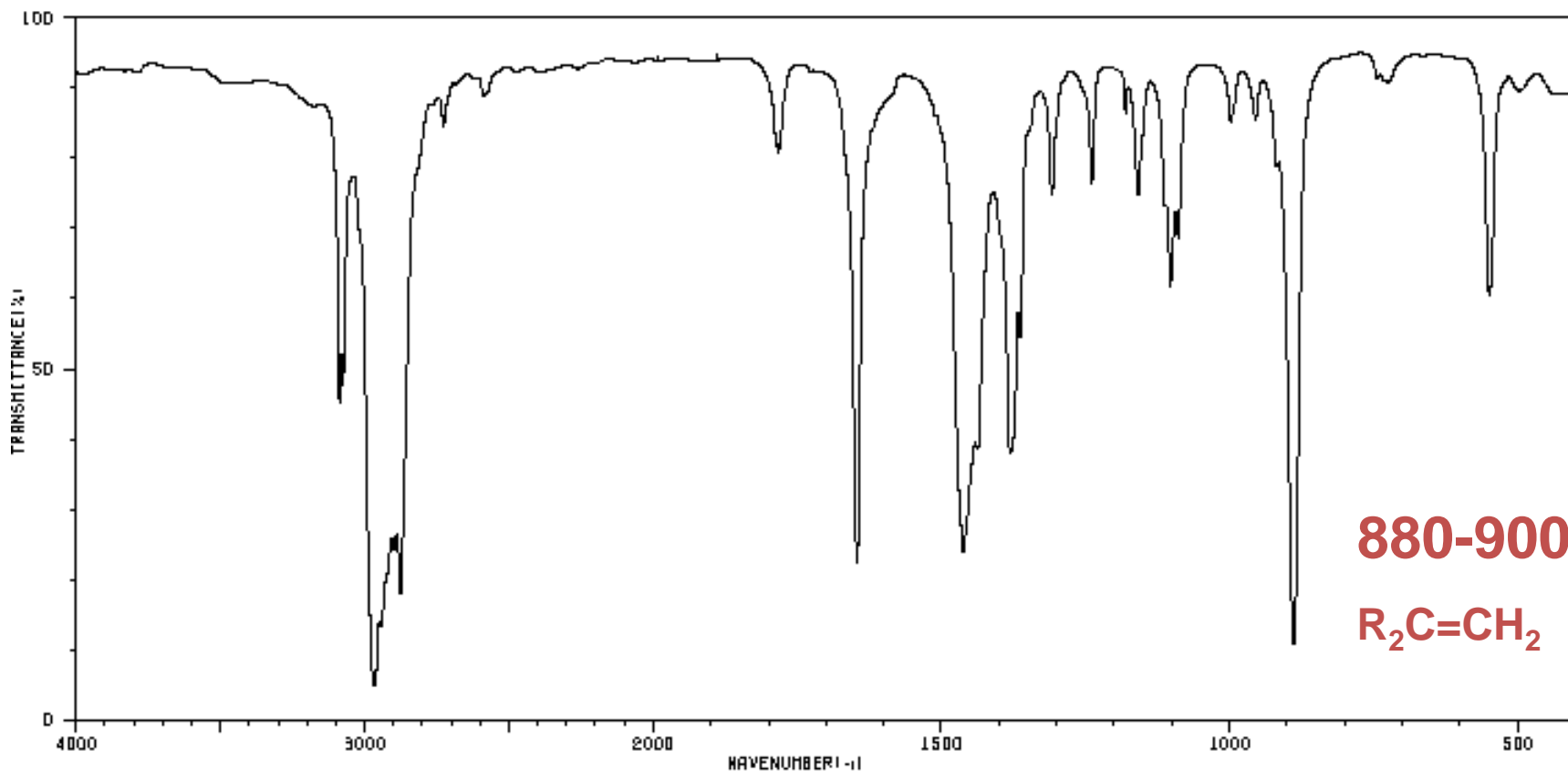

3087	43	2588	86	1308	72	966	81
3075	46	1794	84	1239	74	868	10
2966	4	1783	77	1181	84	550	58
2944	13	1646	21	1169	72	497	86
2898	23	1462	29	1102	58		
2875	17	1380	36	1089	86		
2727	81	1363	62	998	81		

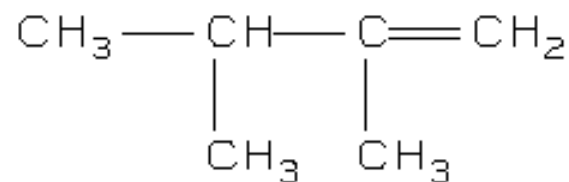

E.T.

251

IR spectra **BENZENES**

=C—H bond, “unsaturated” “aryl”

(sp²) **3000-3100 cm⁻¹**

+ 690-840

mono-substituted + 690-710, 730-770

ortho-disubstituted + 735-770

meta-disubstituted + 690-710, 750-810(m)

para-disubstituted + 810-840(m)

C=C bond pairs **1500, 1600 cm⁻¹**

HIT-NO=1402 SCORE= () SDBS-NO=1332 IR-NIDA-05258 : LIQUID FILM

ETHYLBENZENE
ethylbenzene

C_8H_{10}

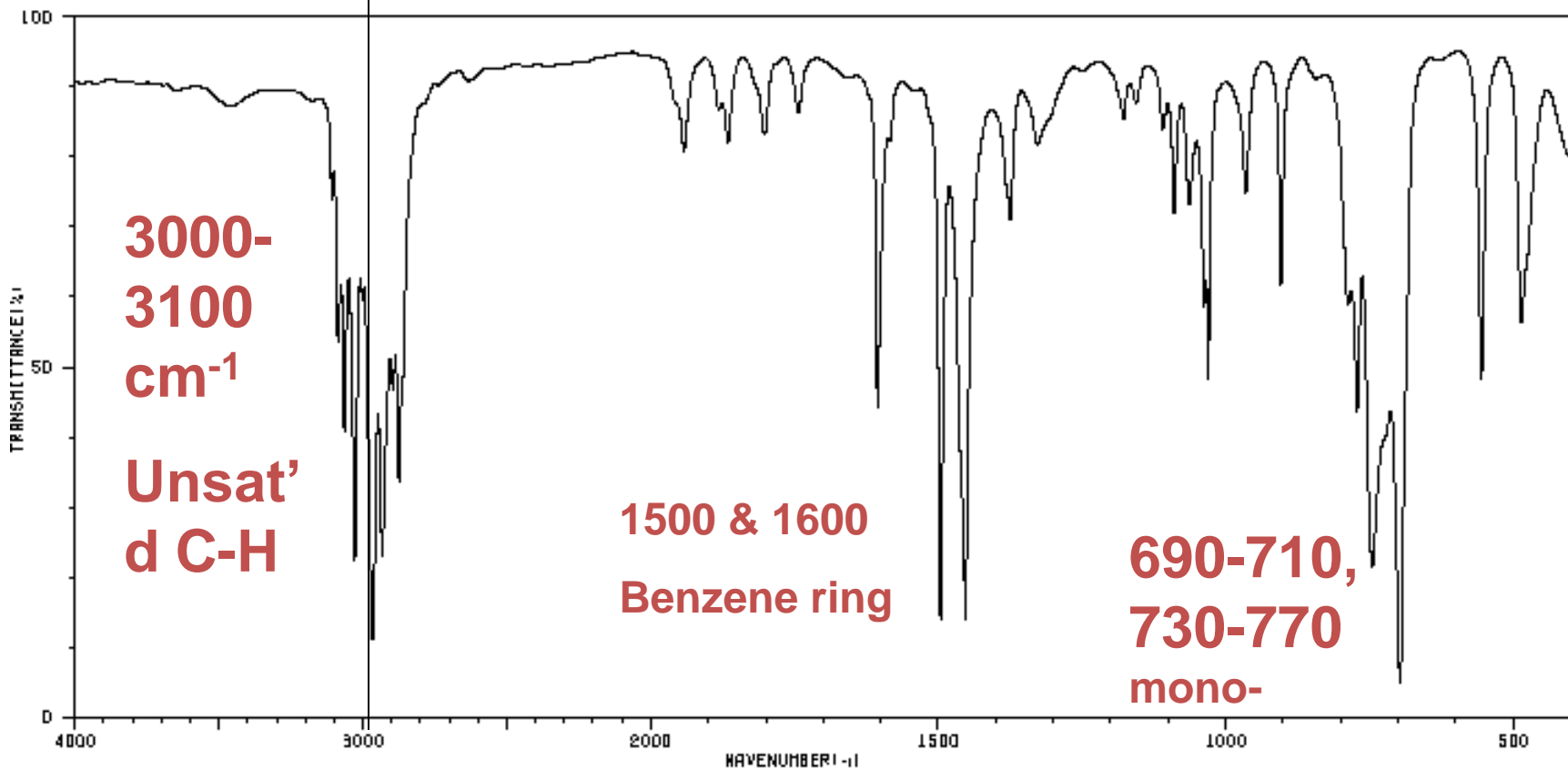

3468	84	2933	21	1802	79	1178	81	904	58
3108	70	2896	44	1744	84	1110	81	788	57
3087	52	2875	32	1806	42	1090	70	772	42
3066	39	1966	84	1496	13	1064	70	746	20
3028	21	1942	77	1453	13	1037	57	697	4
3003	57	1881	84	1376	88	1030	46	556	46
2967	10	1866	78	1329	79	966	72	486	53

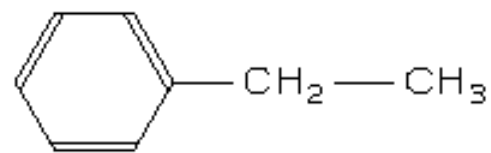

HIT-NO=1272 | SCORE= () | SDBS-NO=1028 | IR-NIDA-21942 : LIQUID FILM

O-XYLENE
o-xylene

C_8H_{10}

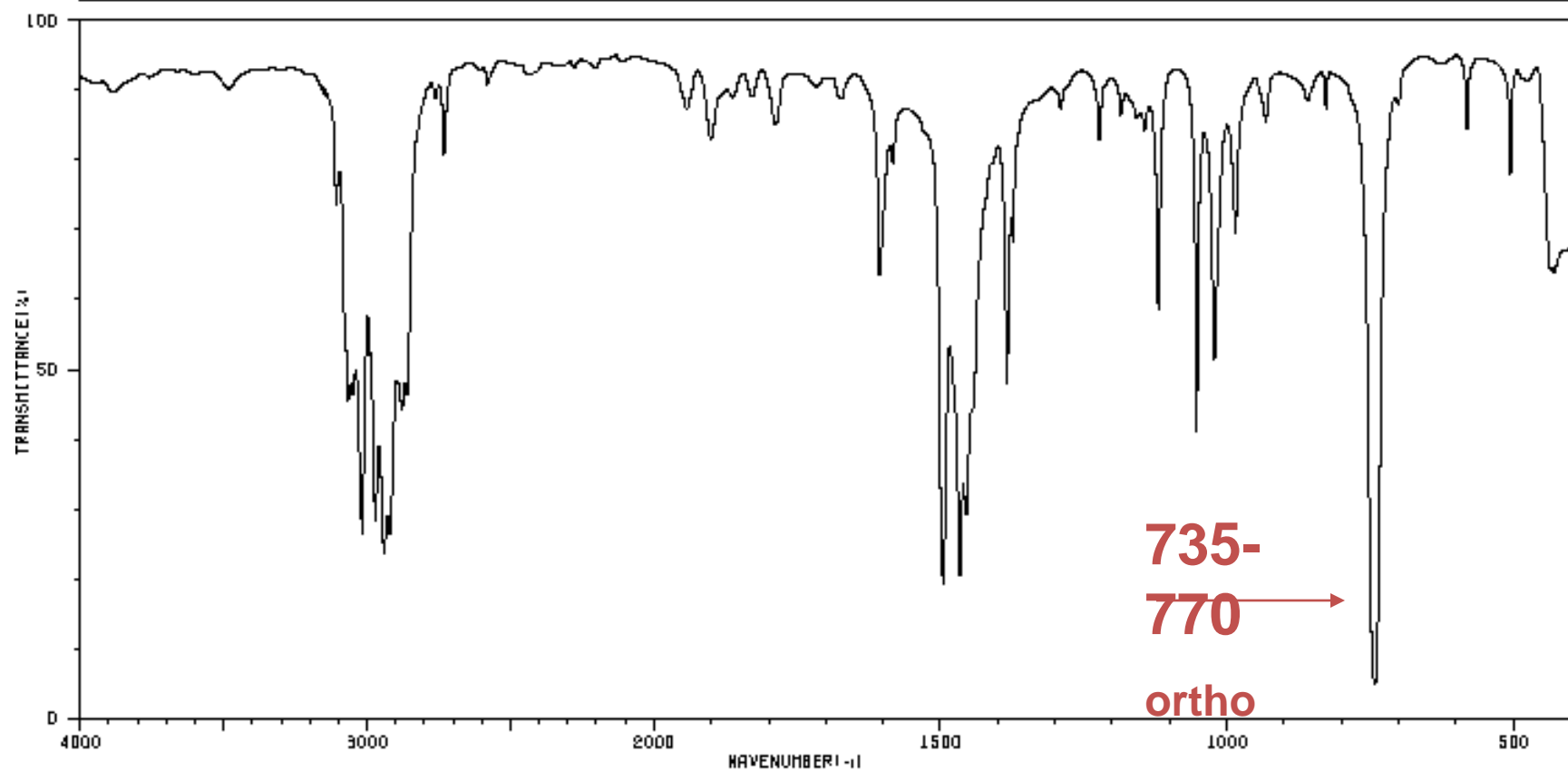

3108	70	2878	42	1683	77	1223	79	986	66
3066	43	2860	44	1495	18	1186	84	932	81
3050	44	2732	77	1467	20	1157	81	742	4
3018	25	1942	84	1456	27	1146	81	582	81
2971	26	1901	79	1384	46	1120	57	506	74
2940	22	1787	81	1374	86	1053	38	436	62
2921	25	1606	60	1291	84	1022	48	431	62

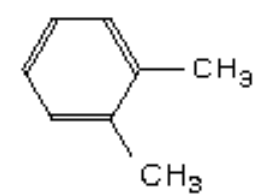

HIT-NO=1238 SCORE= () SDBS-NO=899 IR-NIDA-63598 : LIQUID FILM

P-XYLENE

p-xylene

C₈H₁₀

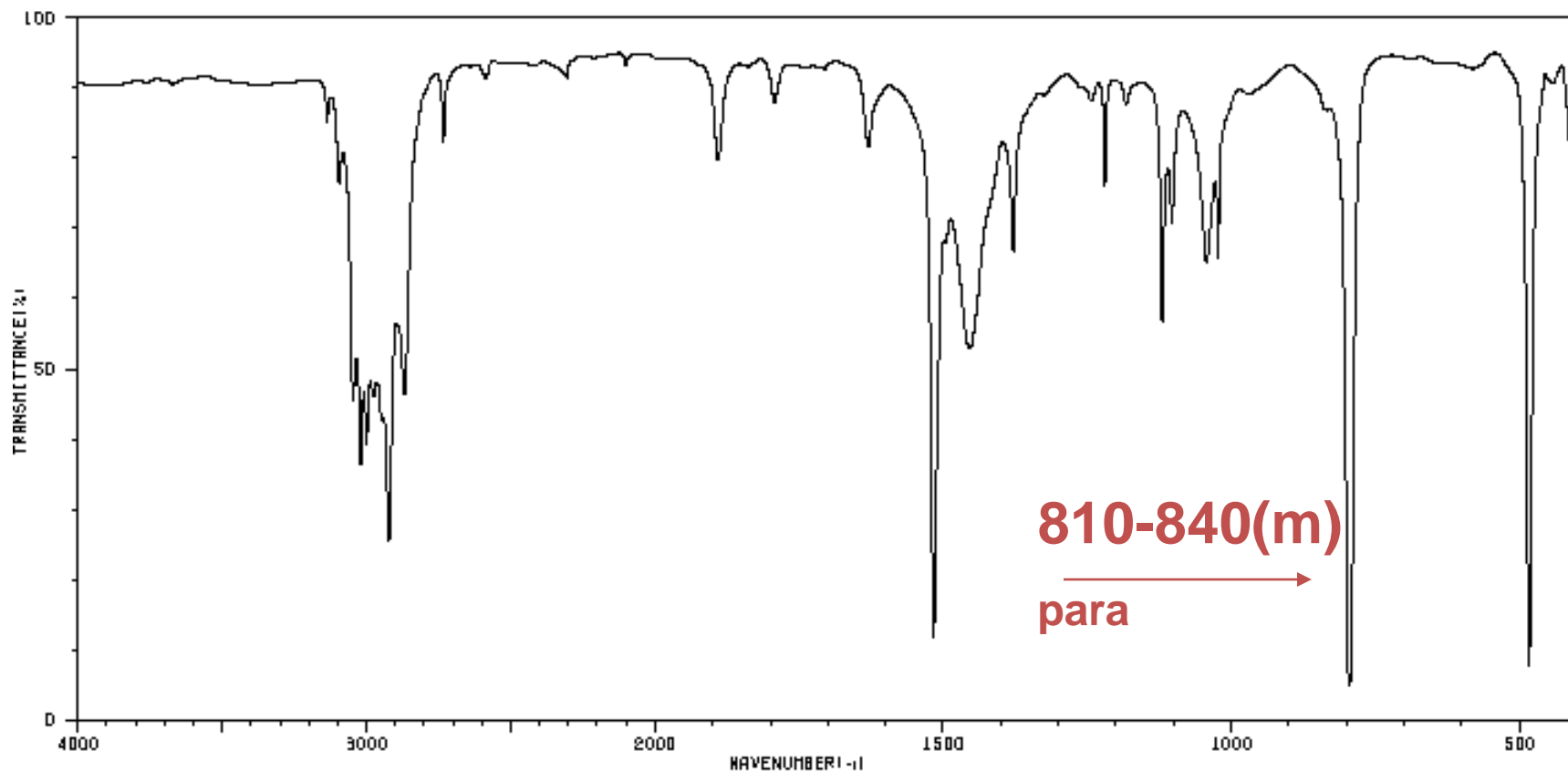

3136	81	2923	24	1454	60	1043	62
3095	74	2868	44	1378	64	1023	64
3047	43	2733	79	1243	84	795	4
3020	36	1890	77	1220	72	484	7
3000	37	1793	84	1183	84		
2976	44	1630	79	1120	55		
2945	41	1516	11	1103	68		

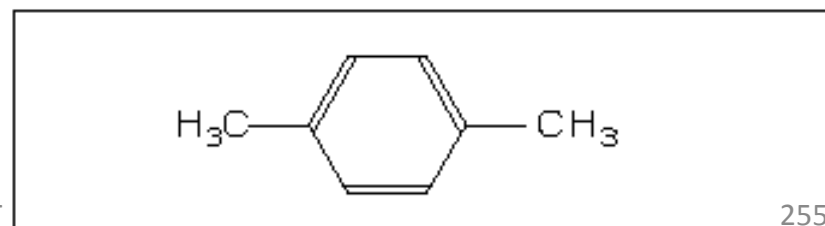

HIT-NO=1275 | SCORE= () | SDBS-NO=1032 | IR-NIDA-63601 : LIQUID FILM

M-XYLENE
m-xylene

C₈H₁₀

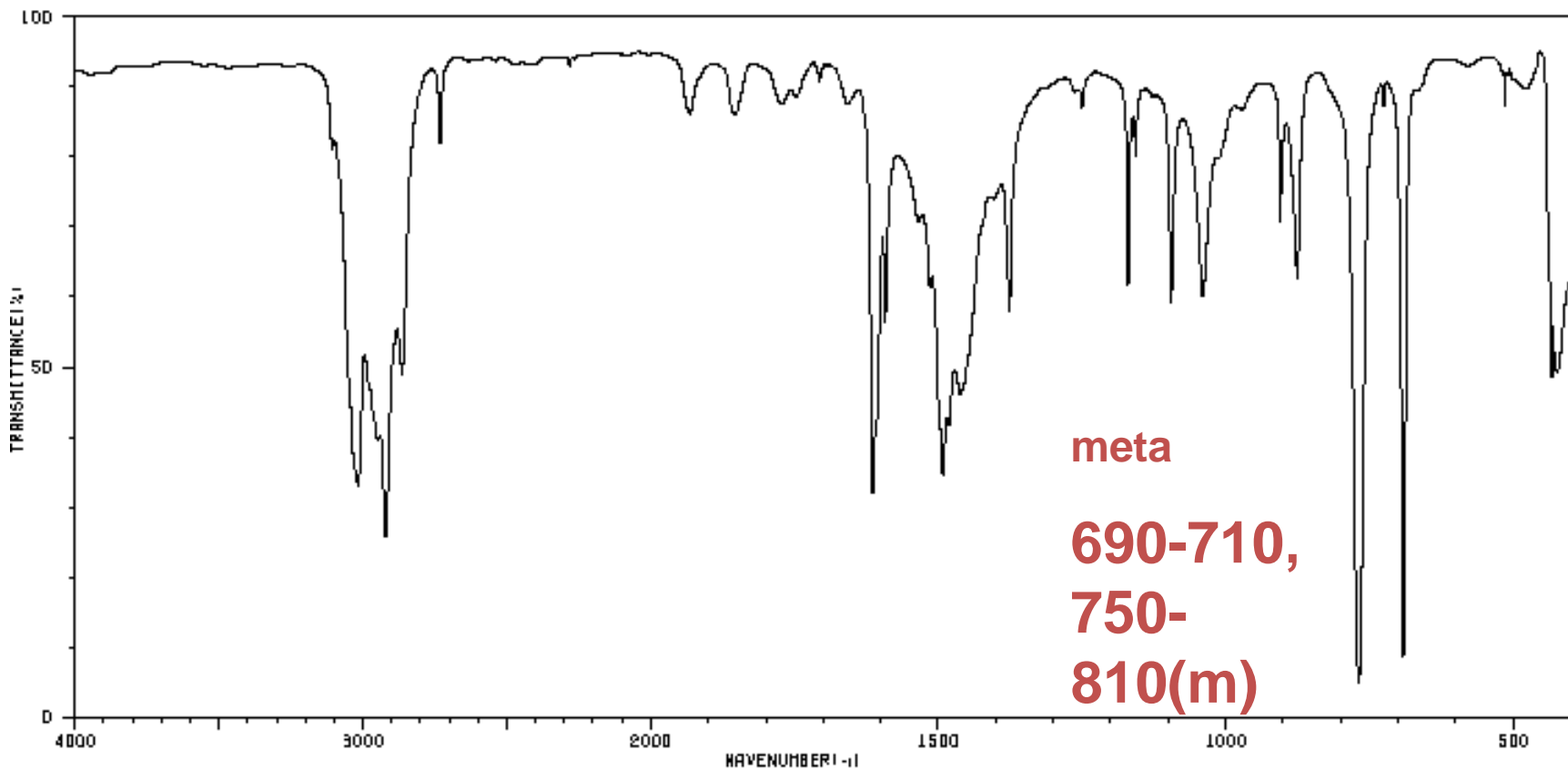

3106	79	1864	84	1492	33	1170	58	726	84
3016	32	1772	84	1482	39	1157	77	691	8
2948	37	1764	84	1462	44	1095	57	515	64
2921	24	1668	84	1376	55	1040	57	483	86
2864	47	1614	31	1263	86	905	68	478	86
2732	79	1592	59	1256	86	876	60	434	46
1932	84	1616	58	1250	84	769	4		

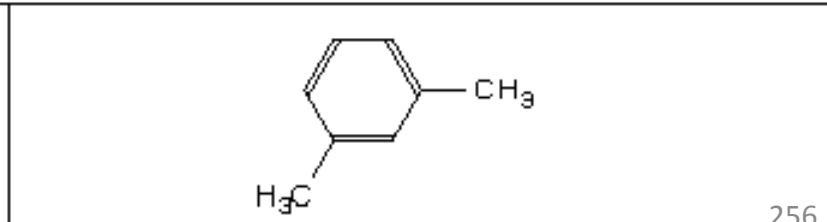

STYRENE

styrene

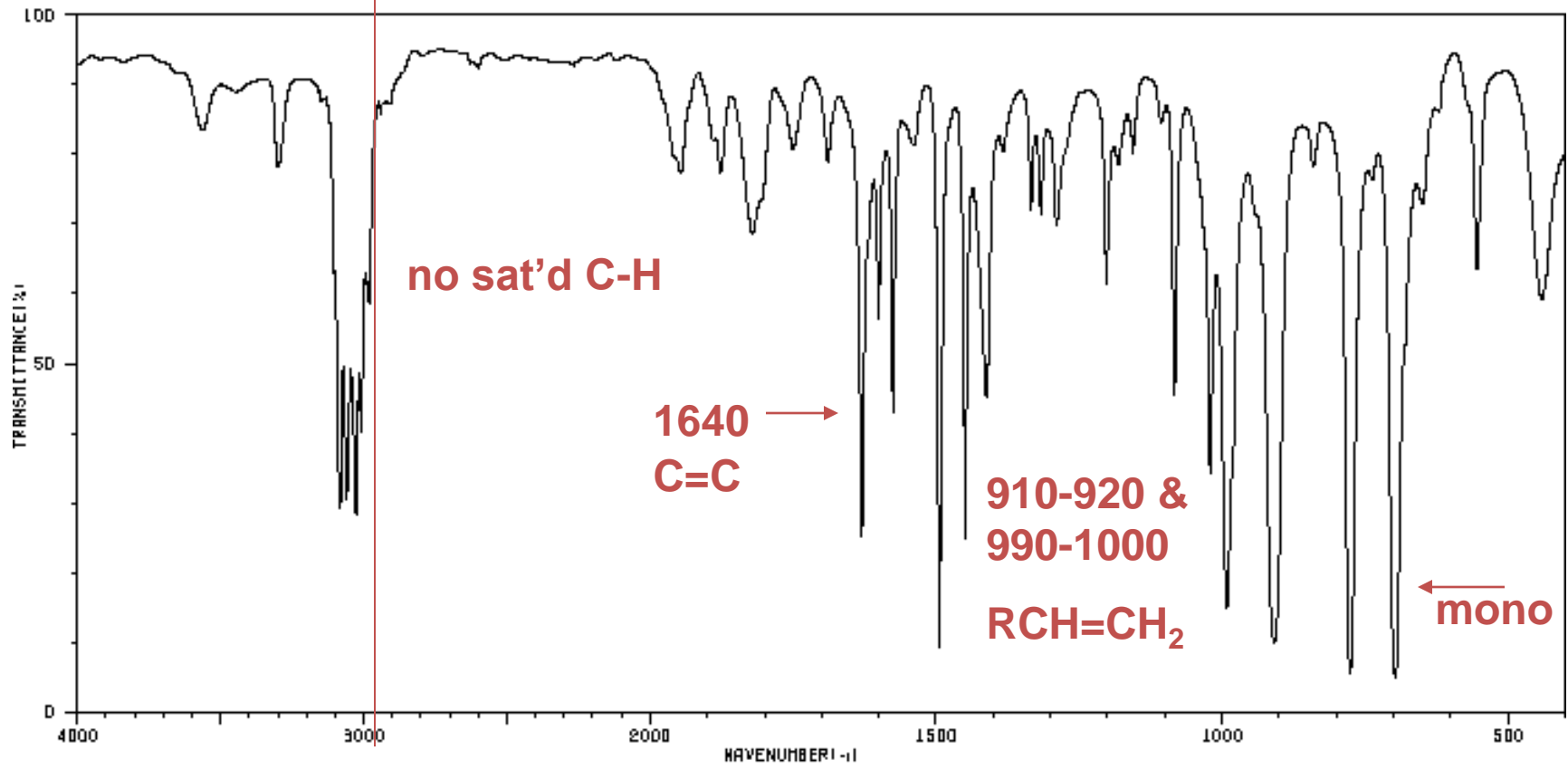

3299	74	1946	74	1496	9	1202	68	841	74
3082	28	1876	74	1449	23	1182	74	777	5
3060	29	1821	66	1412	43	1156	77	738	72
3027	27	1689	77	1383	77	1083	43	698	4
3009	38	1630	24	1334	70	1021	33	650	70
2980	57	1601	59	1317	88	992	14	555	60
1955	77	1576	41	1290	66	909	9	442	67

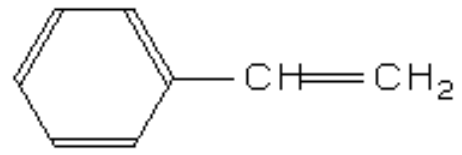

IR spectra **ALCOHOLS & ETHERS**

C—O bond **1050-1275 (b) cm⁻¹**

1° ROH 1050

2° ROH 1100

3° ROH 1150

ethers 1060-1150

O—H bond (broad peak) **3200-3640 (b)**



HIT-NO=1418 | SCORE= () | SDBS-NO=1374 | IR-NIDA-05408 : LIQUID FILM

1-BUTANOL
1-butanol

C₄H₁₀O

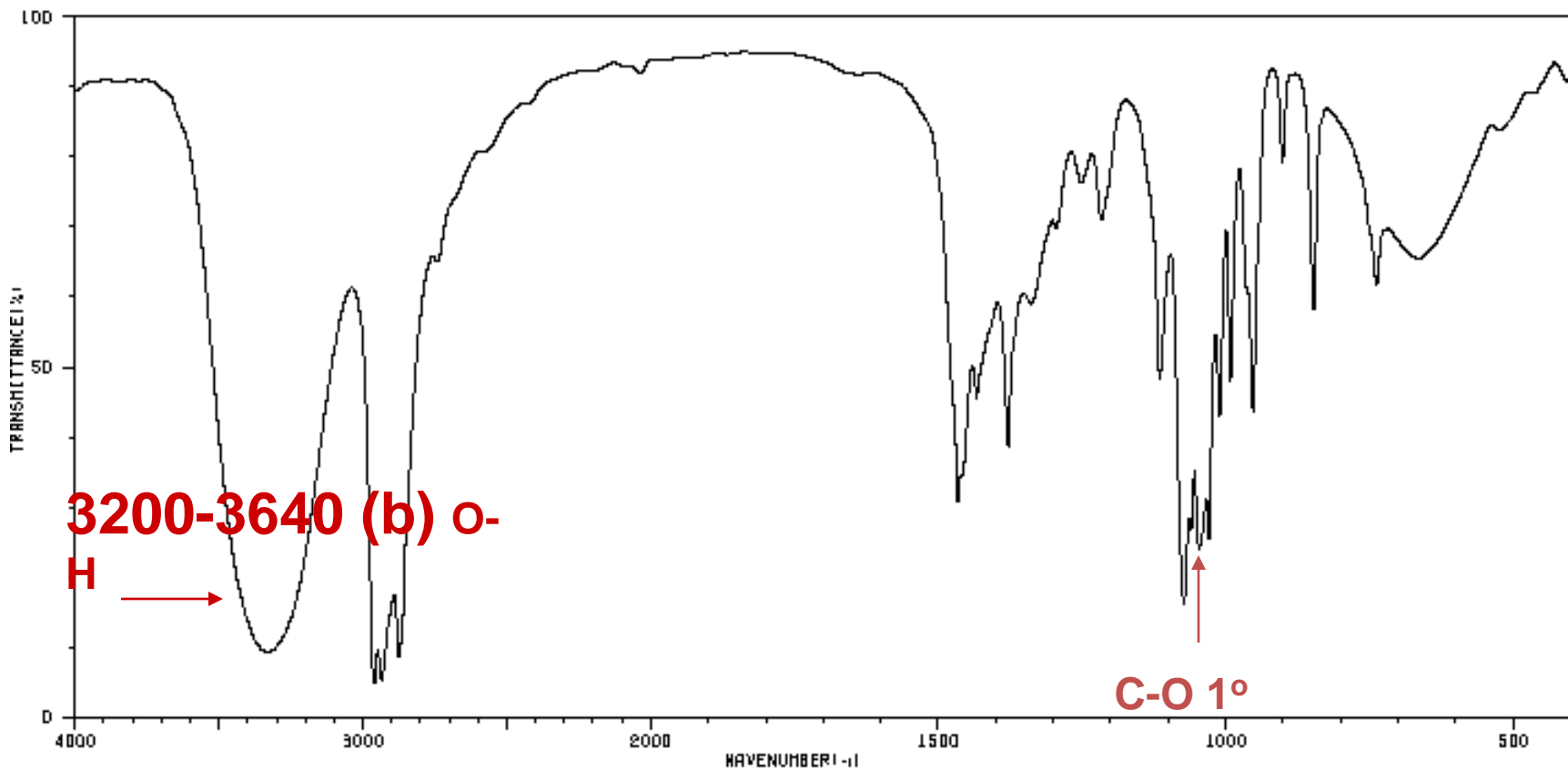

3333	9	1434	49	1073	16	901	77
3323	9	1379	37	1060	26	847	57
2960	4	1338	57	1047	23	738	58
2934	6	1296	68	1029	24	670	62
2875	8	1252	74	1011	42	665	62
1466	30	1217	68	992	46		
1461	33	1116	46	963	42		

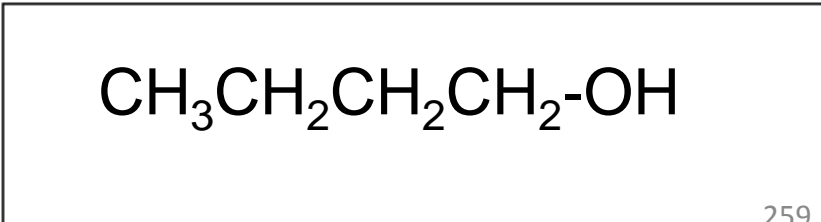

HIT-NO=1035 | SCORE= () | SDBS-NO=507 | IR-NIDA-04700 : LIQUID FILM
 2-BUTANOL
2-butanol
 $C_4H_{10}O$

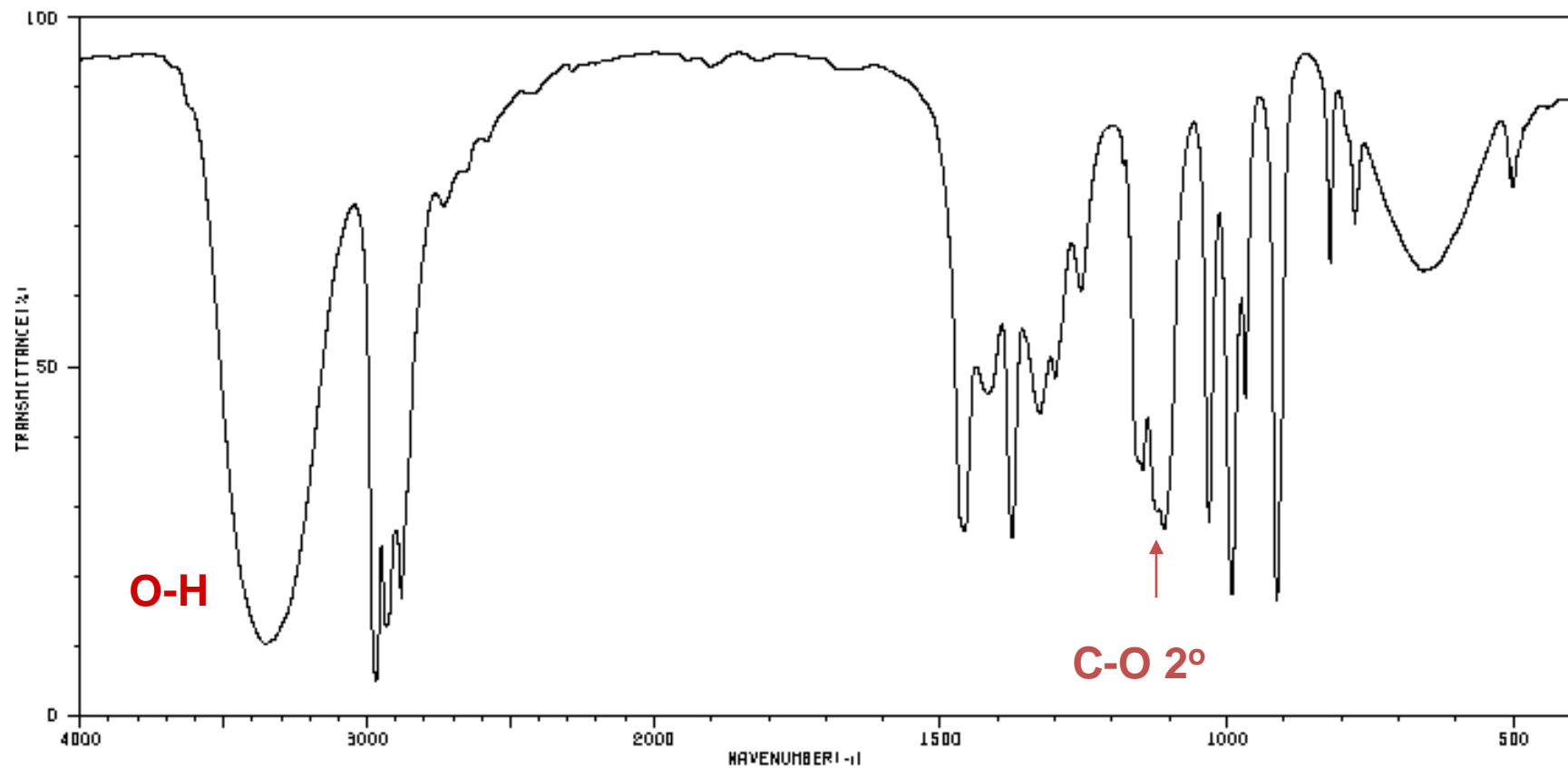

3363	10	1376	24	1110	26	666	60
2968	4	1327	42	1031	26	651	60
2932	12	1300	46	991	16	501	72
2880	16	1266	68	968	43		
2734	70	1154	35	913	15		
1457	25	1148	34	820	82		
1416	44	1122	28	777	68		

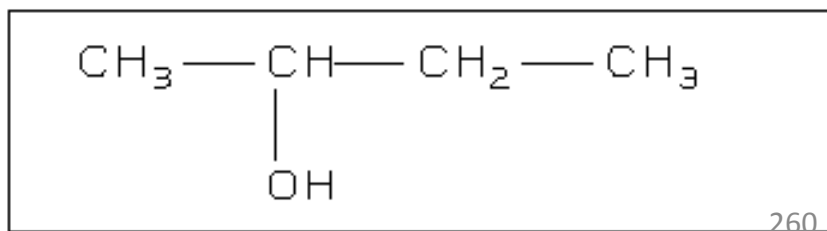

HIT-NO=1034 | SCORE= () | SDBS-NO=506 | IR-NIDA-05409 : LIQUID FILM

2-METHYL-2-PROPANOL

tert-butyl alcohol

C₄H₁₀O

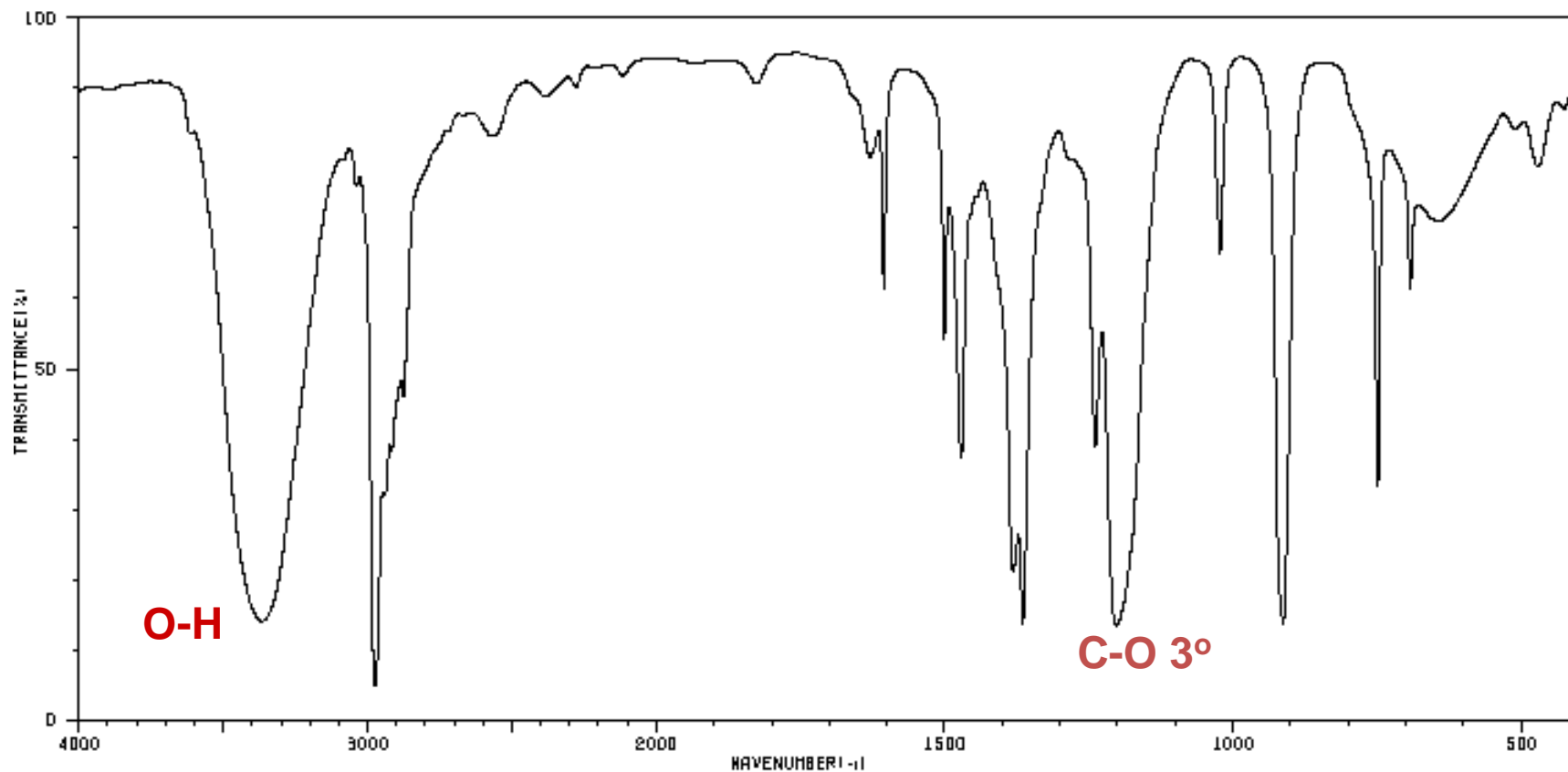

3366	13	1630	77	1202	12	611	81
3038	72	1606	58	1022	64	471	77
2974	4	1501	52	913	13		
2940	31	1471	36	749	32		
2875	44	1381	20	693	58		
2564	79	1365	19	646	68		
2385	86	1239	37	643	68		

E.T.

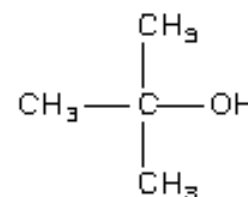

261

HIT-NO=2077 SCORE= () SDBS-NO=2841 IR-NIDA-03073 : LIQUID FILM

METHYL PROPYL ETHER

methyl *n*-propyl ether

C₄H₁₀O

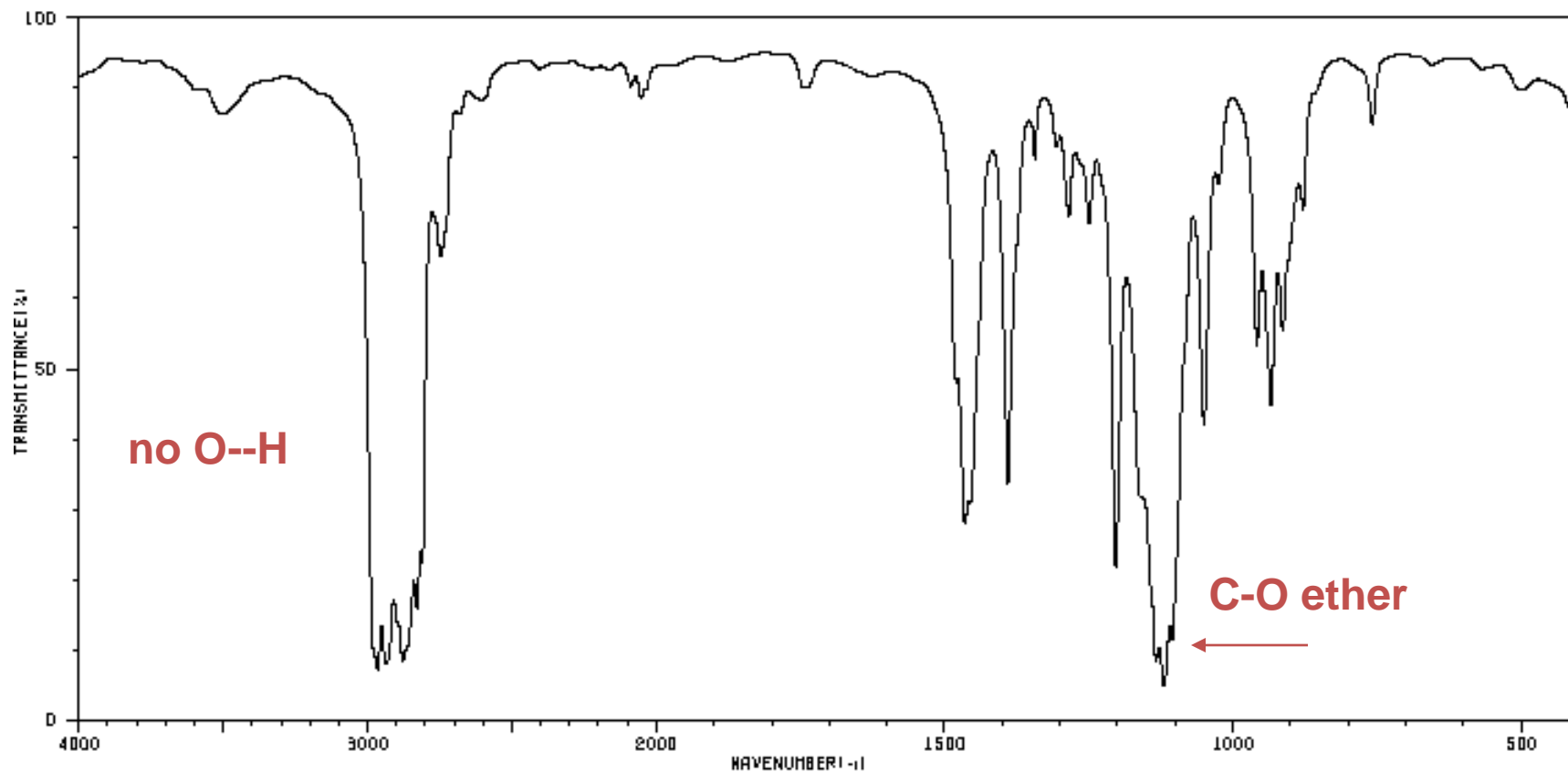

3600	84	2616	84	1344	77	1106	10	769	81
2965	7	2605	84	1307	79	1050	41	501	86
2935	7	2053	84	1285	88	1024	72		
2879	7	2039	86	1260	88	969	50		
2830	15	1465	26	1204	21	934	43		
2810	21	1458	29	1134	7	914	55		
2745	64	1391	32	1120	4	879	70		



HIT-NO=1228

SCORE= ()

SDBS-NO=888

IR-NIDA-33689 : LIQUID FILM

2-BUTANONE

2-butanone

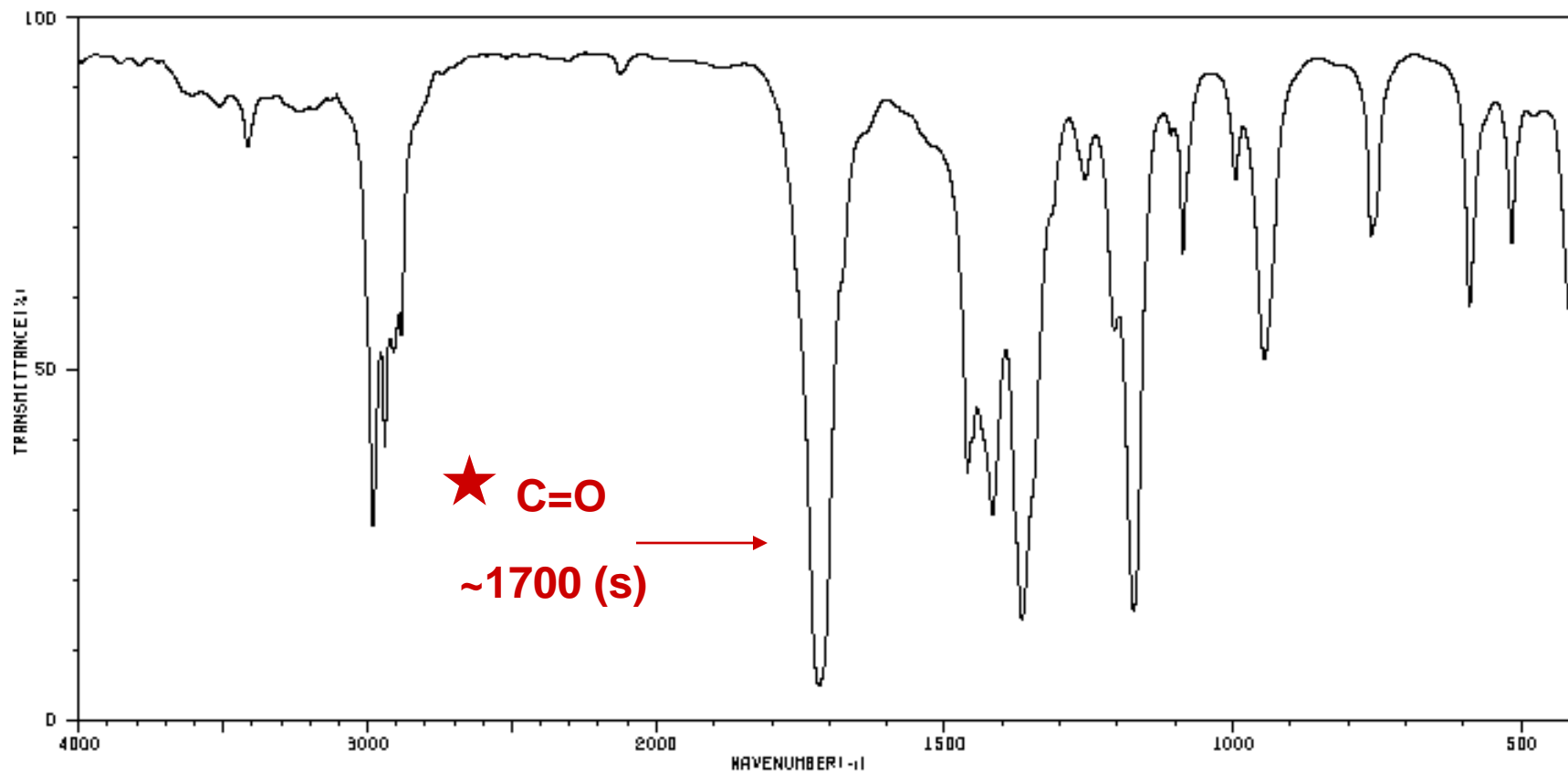
C₄H₈O

3611	84	1718	4	1173	14
3416	79	1461	34	1087	64
2981	26	1454	38	996	74
2964	44	1417	27	946	49
2940	37	1366	13	761	66
2909	50	1257	74	590	57
2883	62	1206	69	617	66

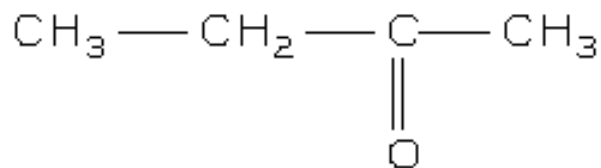

E.T

263

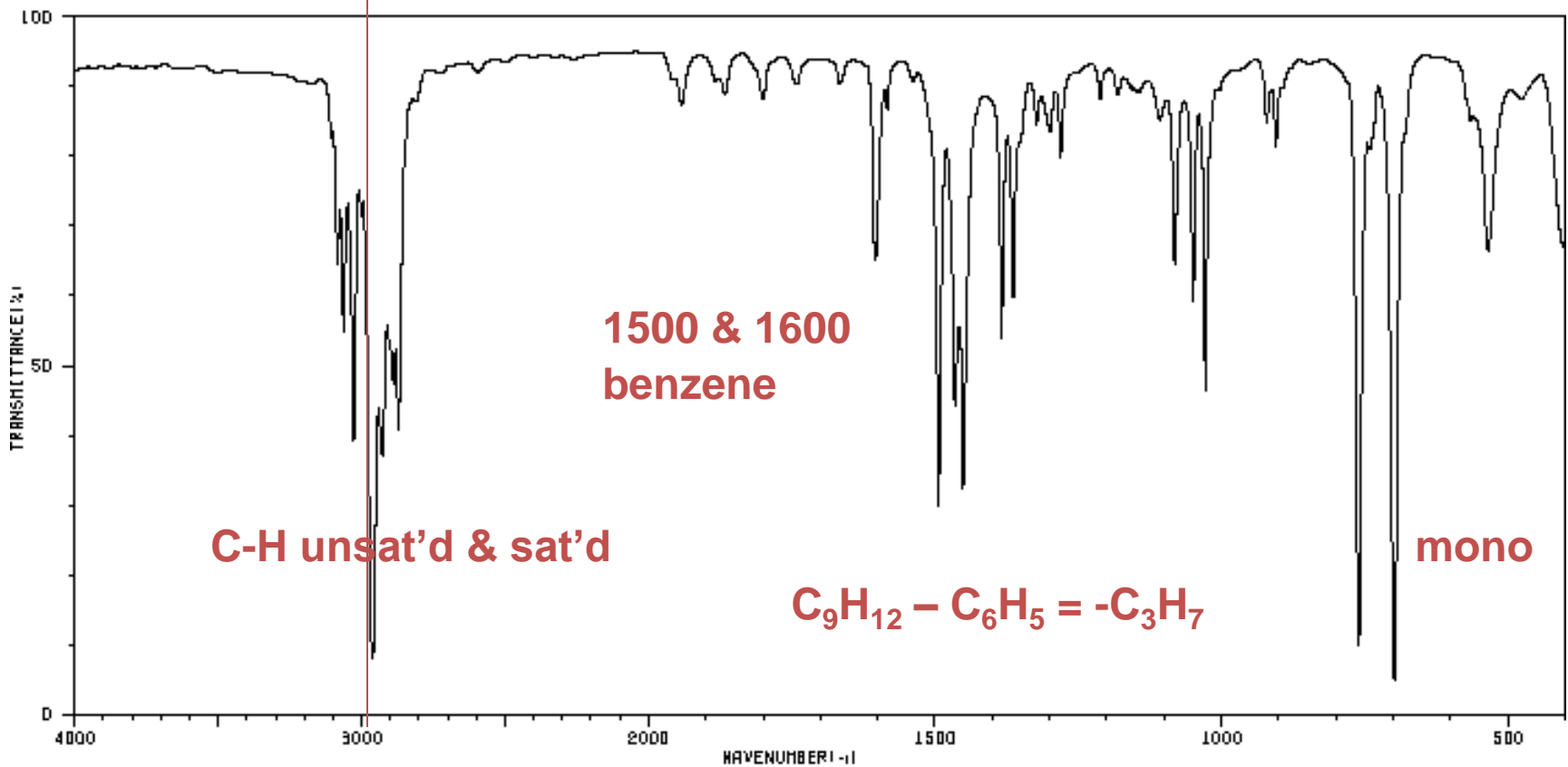
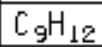

3084	62	2871	38	1466	42	1281	77	1028	44
3064	53	1942	84	1458	53	1219	84	922	81
3028	37	1868	86	1452	31	1150	86	905	79
3002	68	1800	84	1384	62	1144	86	761	9
2961	7	1604	62	1364	57	1108	81	699	4
2927	35	1583	84	1323	81	1082	62	535	64
2890	46	1494	28	1300	81	1060	67	478	84

isopropylbenzene

n-

propylbenzene?

HIT-NO=1235

SCORE= ()

SDBS-NO=896

IR-NIDA-64858 : LIQUID FILM

PROPYLBENZENE

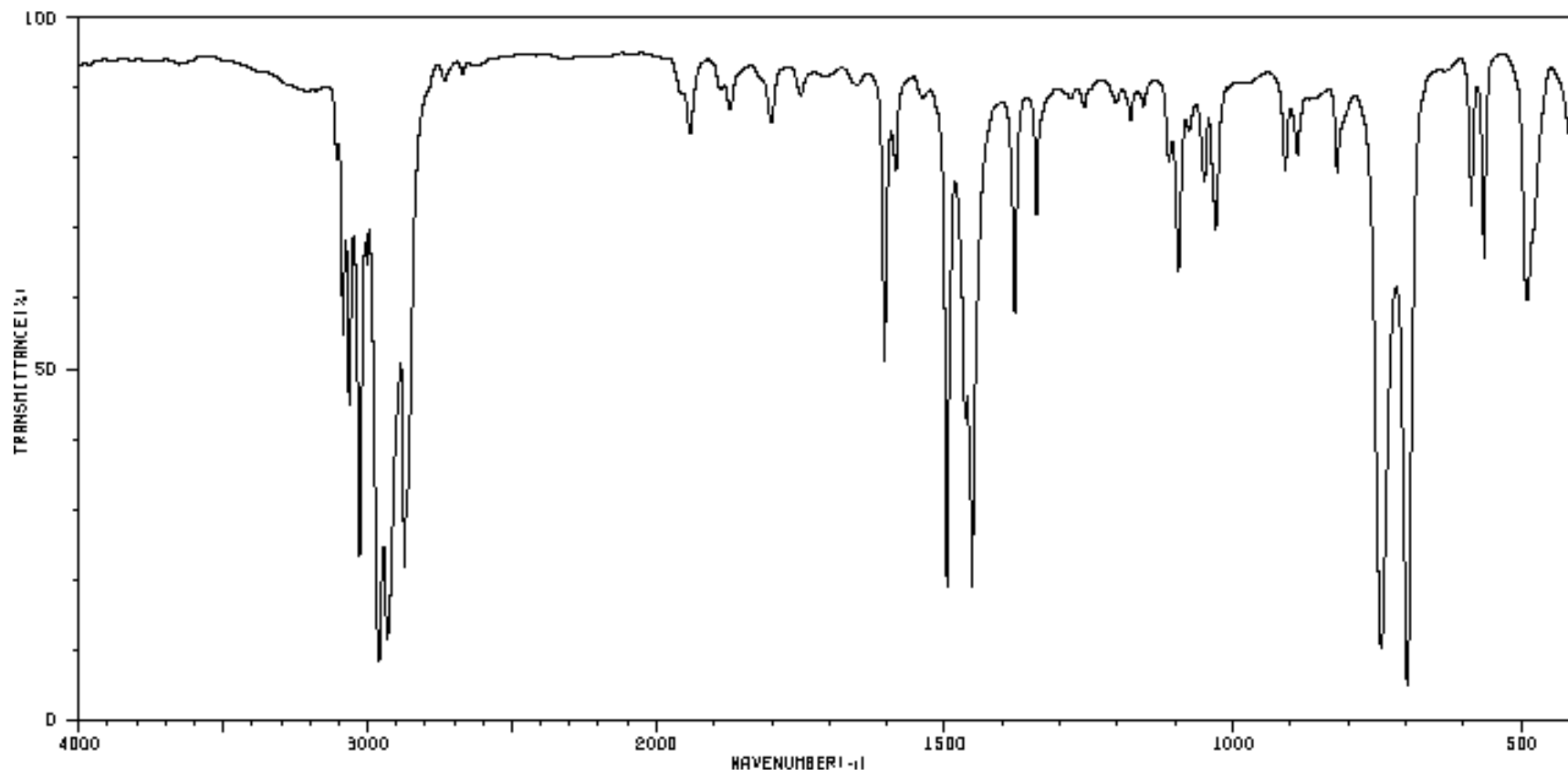
***n*-propylbenzene** C_9H_{12} 

3108	77	2873	20	1466	41	1111	77	619	74
3085	52	1941	79	1453	18	1095	62	743	9
3064	43	1801	81	1379	55	1076	81	696	4
3028	22	1604	49	1341	70	1060	74	587	70
3002	62	1584	74	1258	84	1031	66	565	62
2960	8	1538	84	1203	84	909	74	490	57
2931	10	1496	18	1178	81	888	77	481	66

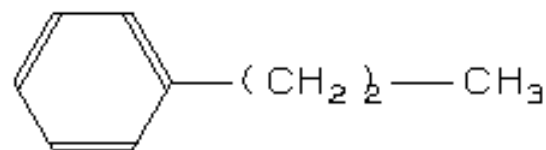

HIT-NO=1576

SCORE= ()

SDBS-NO=1816

IR-NIDA-63602 : LIQUID FILM

CUMENE

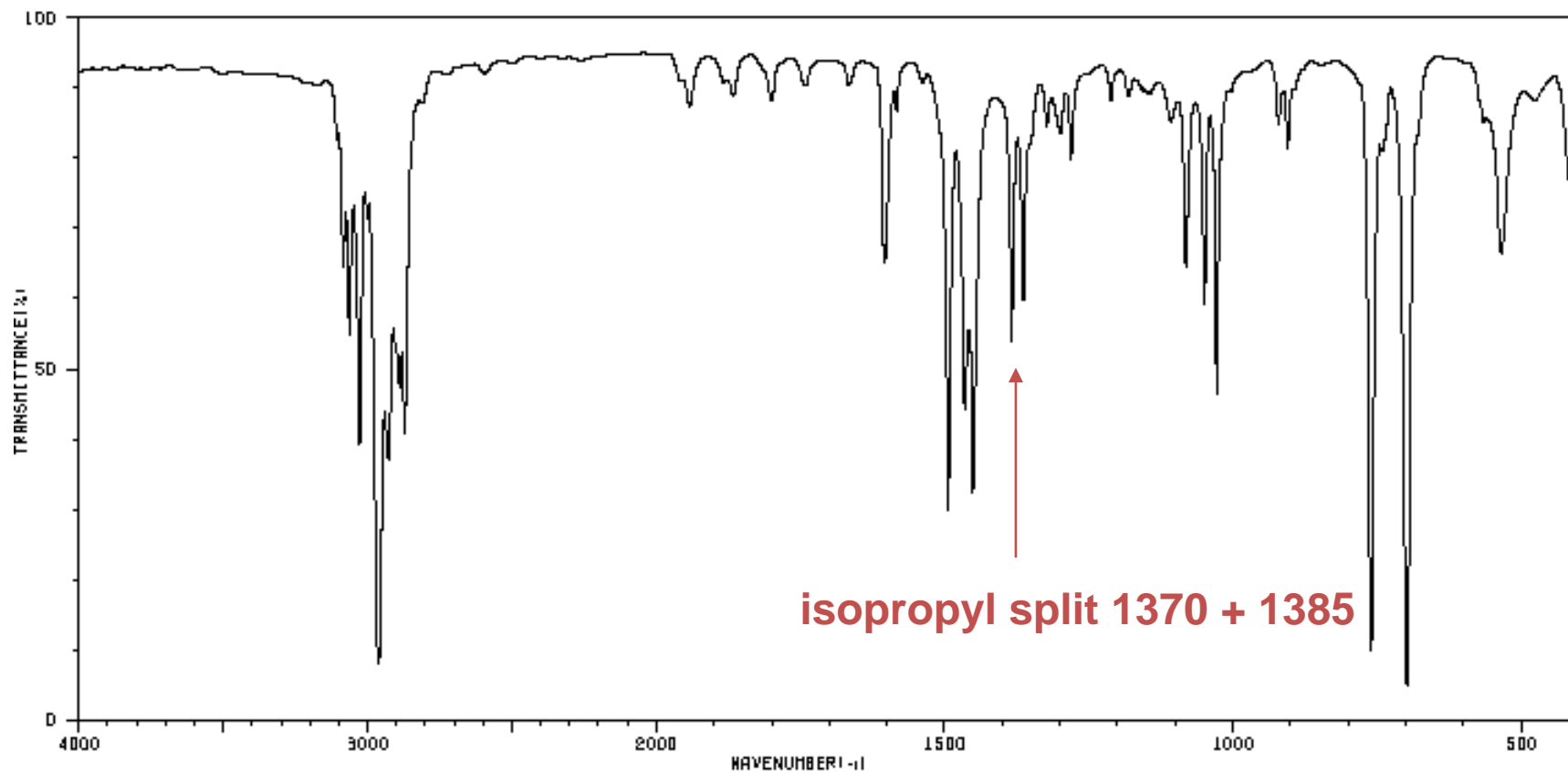
isopropylbenzene C_9H_{12} 

3084	62	2871	38	1466	42	1281	77	1028	44
3064	53	1942	84	1458	53	1219	84	922	81
3028	37	1868	86	1452	31	1150	86	905	79
3002	68	1800	84	1384	52	1144	86	761	9
2961	7	1604	62	1364	57	1108	81	699	4
2927	35	1583	84	1323	81	1082	62	535	64
2890	46	1494	28	1300	81	1060	67	478	84

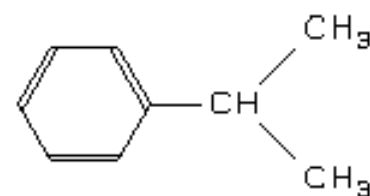

C₈H₆

C₈H₆

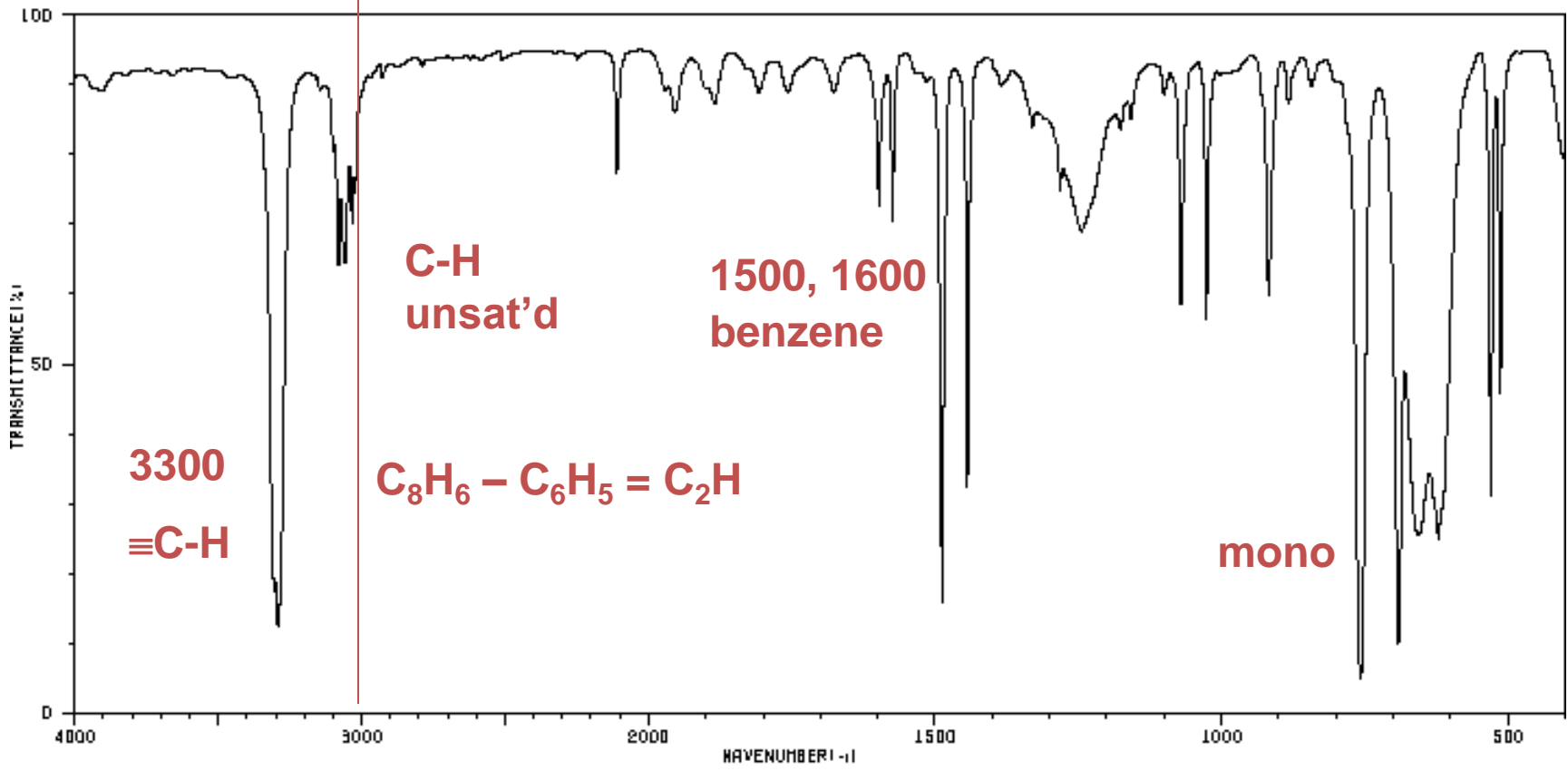

3906	86	2110	74	1674	68	1176	81	843	86
3306	16	1954	84	1488	15	1159	81	757	4
3291	12	1900	86	1444	31	1100	84	692	9
3081	62	1886	84	1386	86	1071	67	666	24
3058	62	1808	86	1331	81	1026	53	621	23
3034	86	1757	86	1282	72	918	57	530	30
3022	72	1698	70	1245	66	883	84	514	43

phenylacetylene

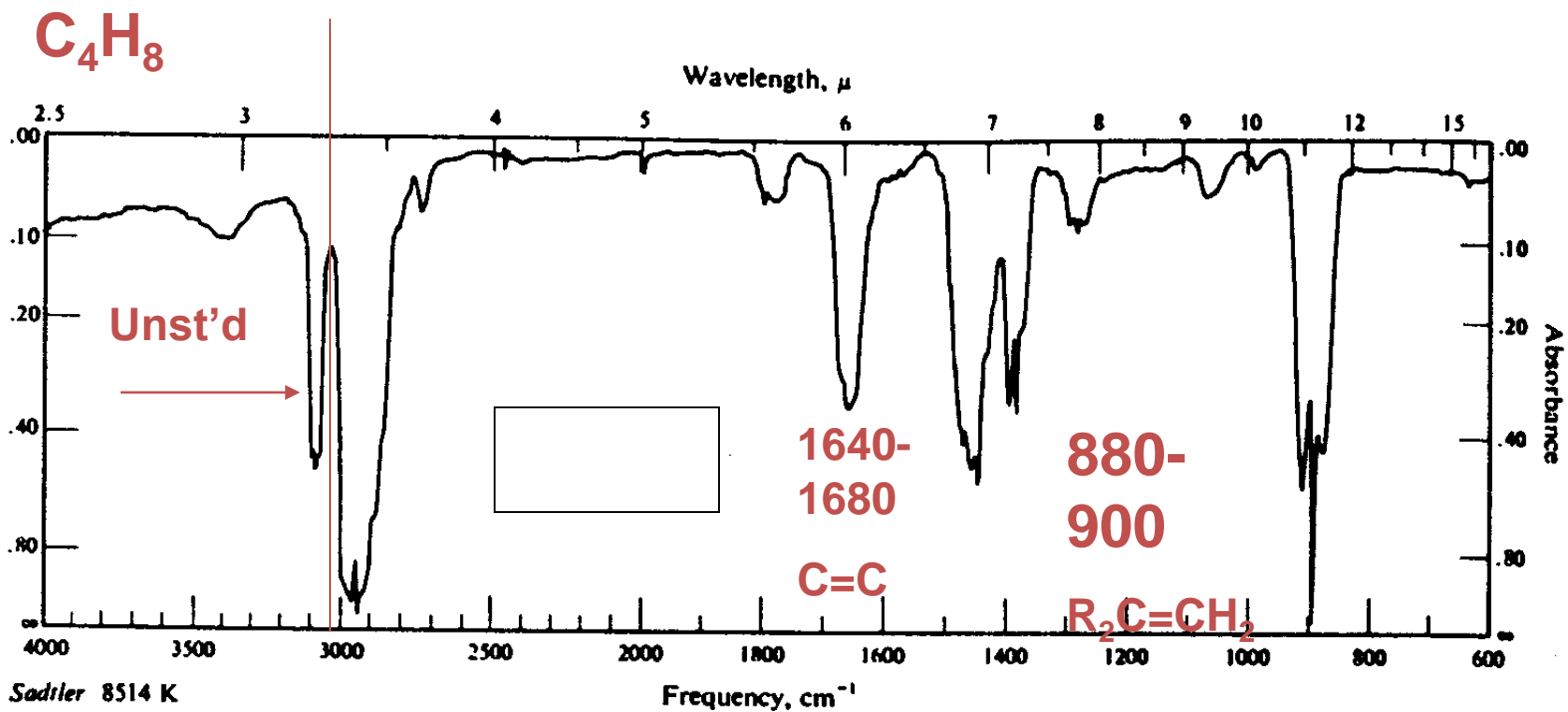

isobutylene

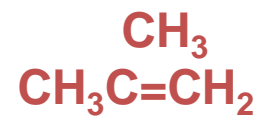

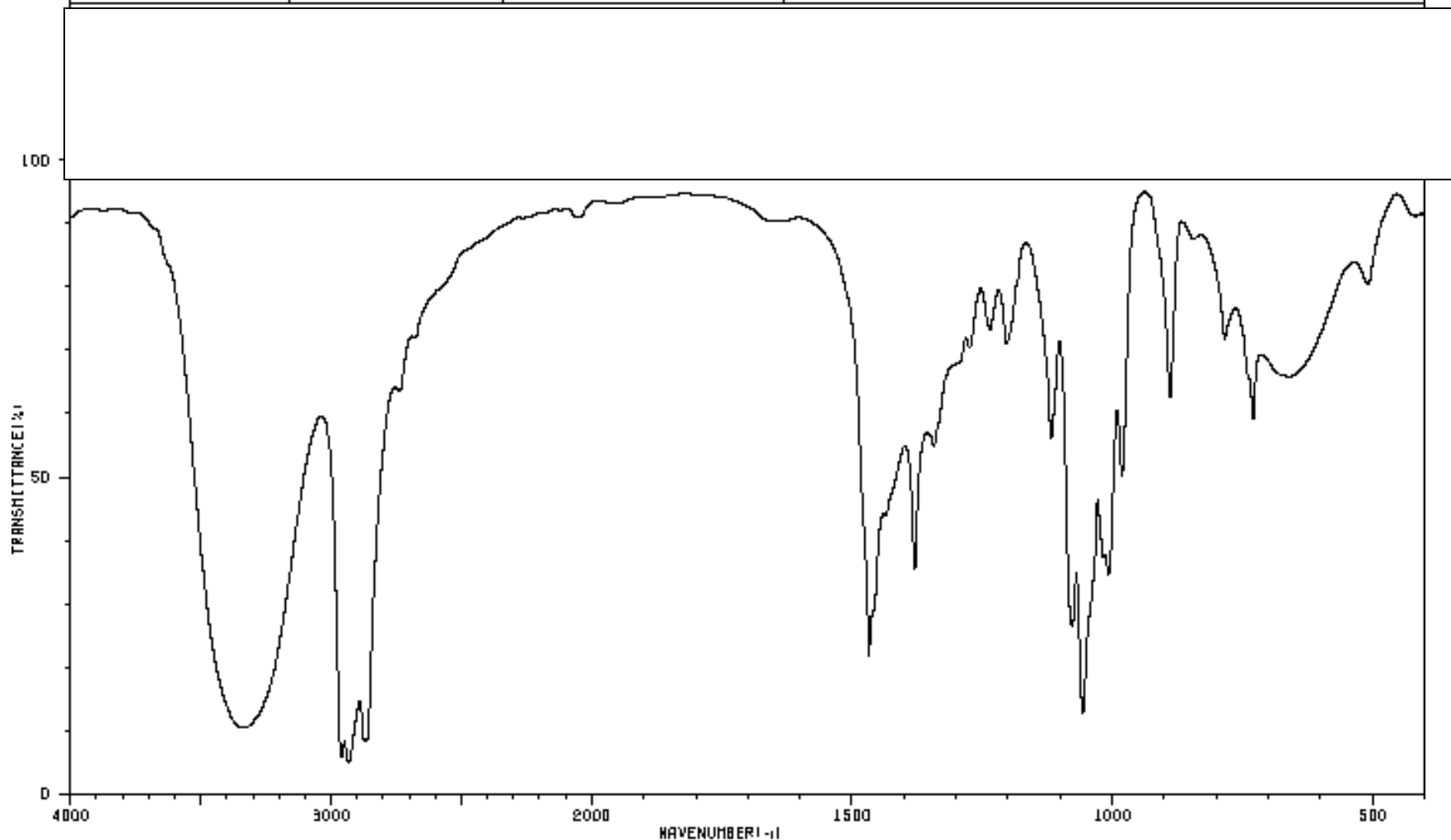

Which compound is this?

- a) 2-pentanone
- b) 1-pentanol
- c) 1-bromopentane
- d) 2-methylpentane

1-pentanol

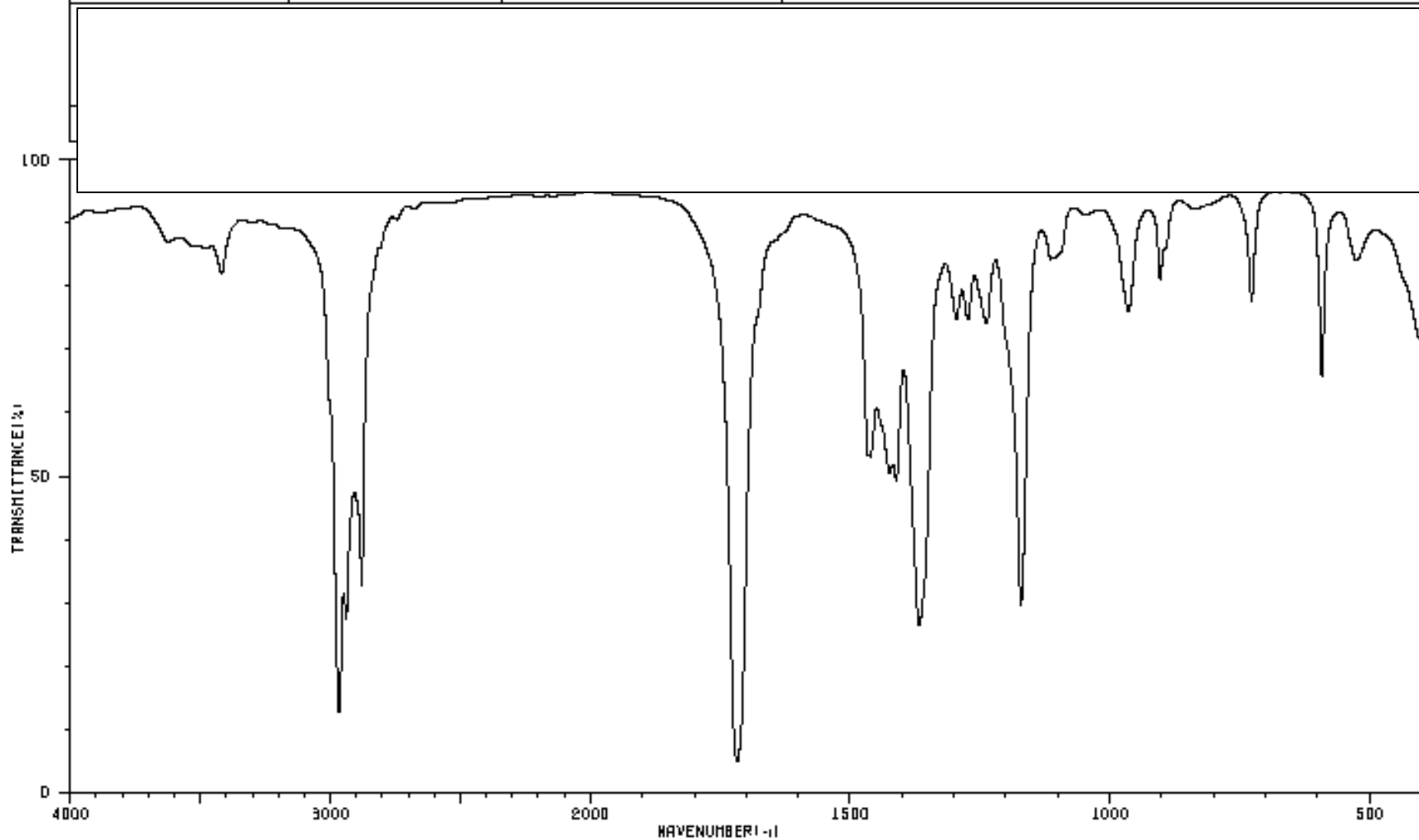

What is the compound?

- a) 1-bromopentane
- b) 1-pentanol
- c) 2-pentanone
- d) 2-methylpentane

2-pentanone

In a “matching” problem, do **not** try to fully analyze each spectrum. Look for differences in the possible compounds that will show up in an infrared spectrum.

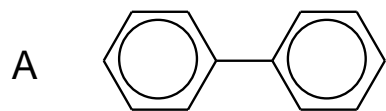

biphenyl

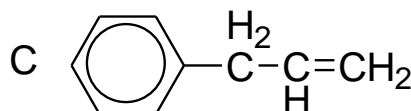

allylbenzene

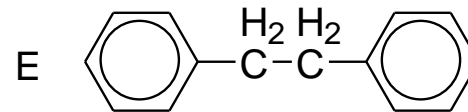

1,2-diphenylethane

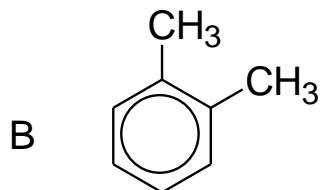

o-xylene

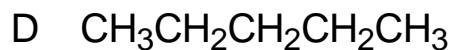

n-pentane

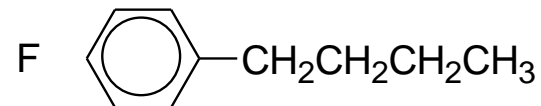

n-butylbenzene

HIT-NO=3317

SCORE= ()

SDBS-NO=6325

IR-NIDA-64189 : LIQUID FILM

1

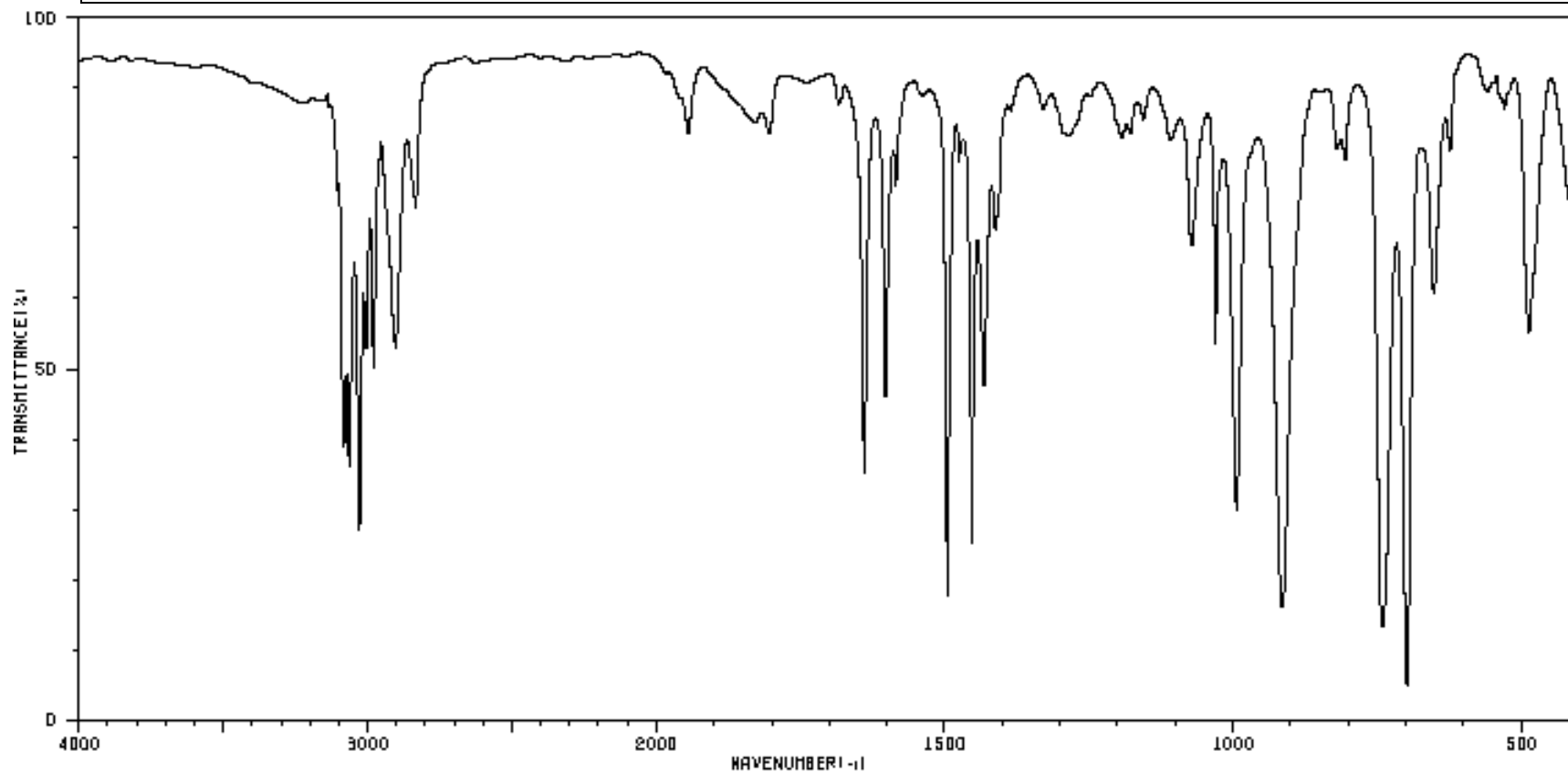

3082	37	1946	81	1463	24	1107	79	806	77
3064	34	1804	79	1432	46	1071	64	741	13
3029	26	1639	34	1412	86	1030	52	699	4
3006	50	1603	44	1286	79	994	28	662	58
2979	49	1585	72	1194	79	914	15	625	79
2904	50	1495	17	1186	81	821	79	487	53
2833	70	1476	77	1178	81	816	78	481	58

HIT-NO=1929

SCORE= ()

SDBS-NO=2475

IR-NIDA-68185 : LIQUID FILM

2

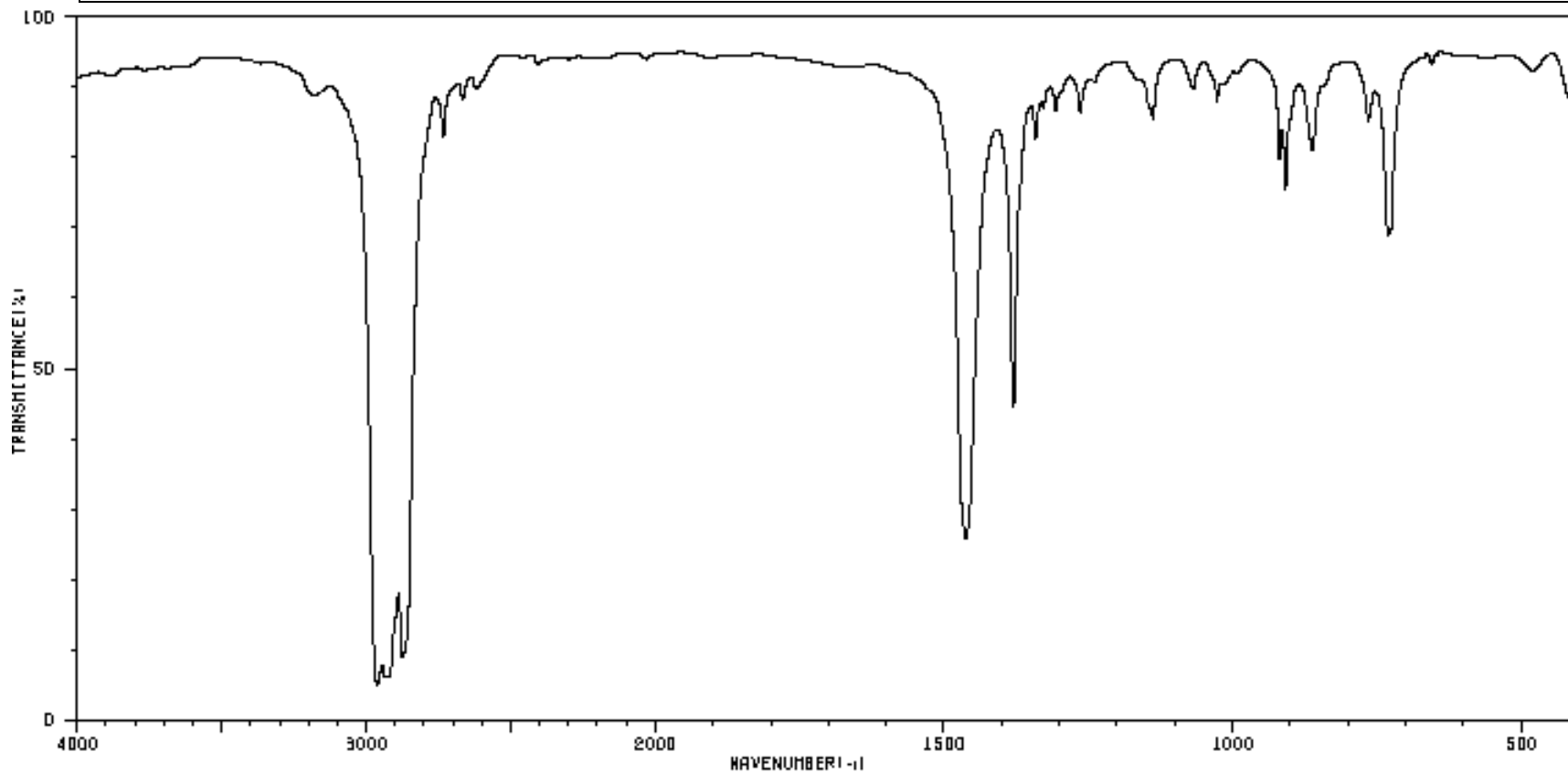

3182	86	2619	86	1138	81	732	66
3172	86	1462	24	1068	86		
2961	4	1380	45	1027	84		
2928	6	1342	78	919	77		
2875	8	1307	84	908	72		
2733	79	1264	84	862	79		
2666	84	1144	84	766	81		

E.T

273

HIT-NO=1575

SCORE= ()

SDBS-NO=1815

IR-NIDA-02821 : LIQUID FILM

3

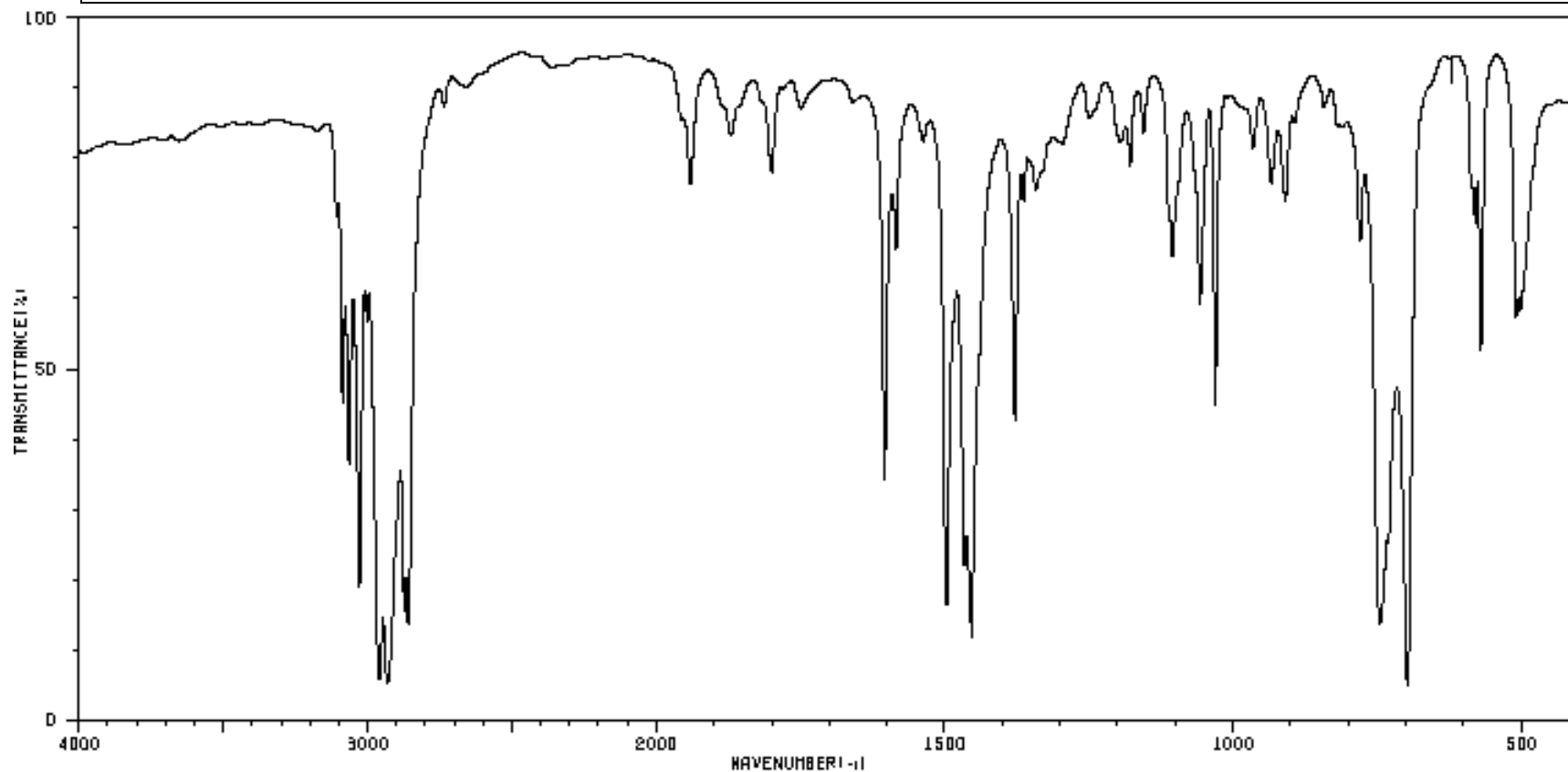

3108	68	2873	14	1467	21	1067	67	731	23
3087	43	2860	13	1454	11	1030	43	698	4
3064	35	1941	74	1379	41	965	79	588	72
3028	18	1800	74	1363	70	934	74	581	68
3002	55	1604	33	1342	72	909	70	570	50
2958	5	1584	64	1179	77	779	66	510	55
2931	4	1497	16	1106	64	746	19	503	67

HIT-NO=1384

SCORE= ()

SDBS-NO=1264

IR-NIDA-62151 : KBR DISC

4

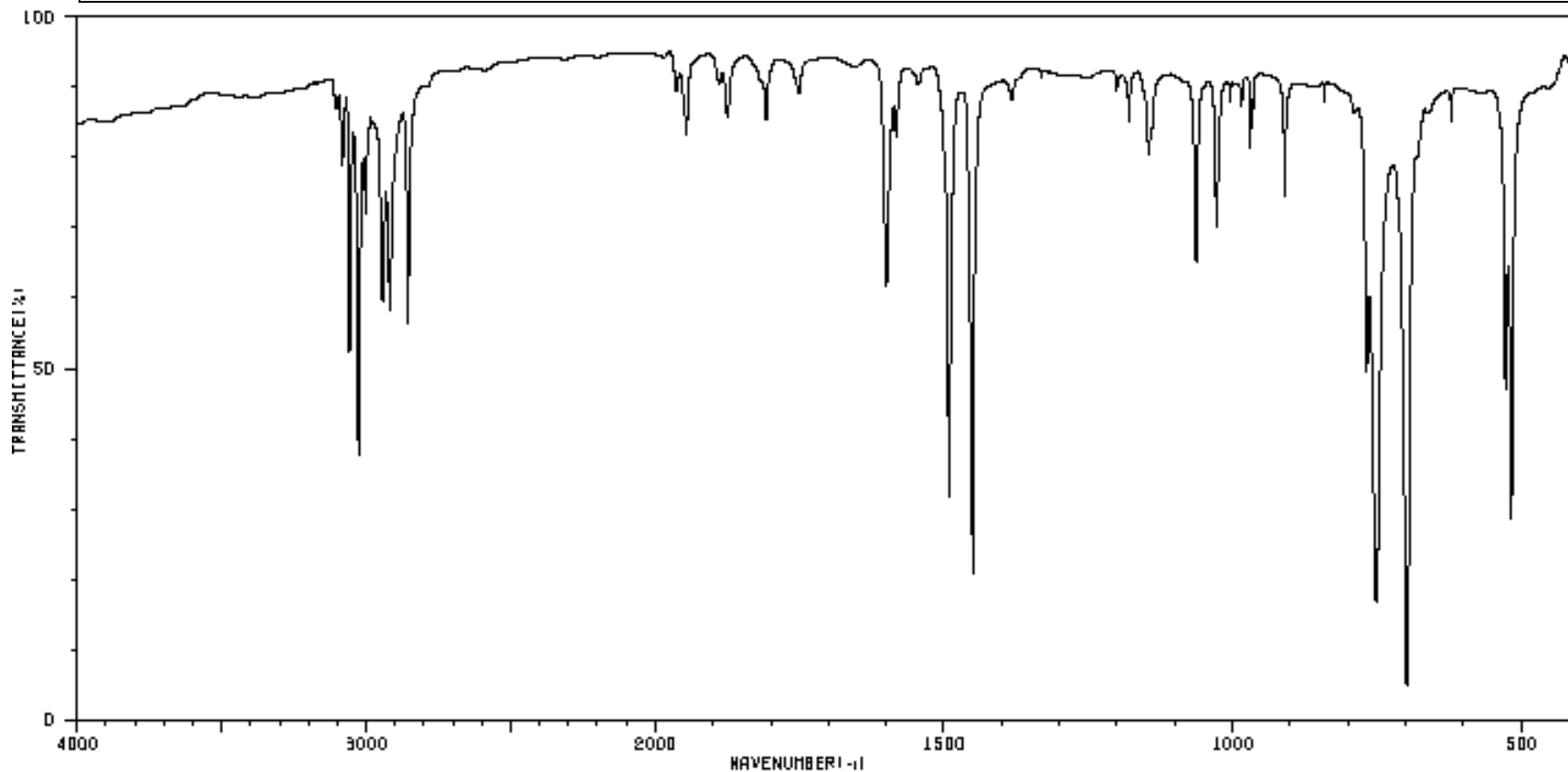

3102	84	2919	66	1600	68	1146	77	841	84
3083	77	2856	55	1583	79	1064	62	768	47
3058	50	1963	86	1492	30	1028	68	752	16
3040	79	1946	79	1460	20	1003	84	699	4
3027	36	1874	81	1383	84	985	84	622	81
3002	66	1808	81	1202	86	969	79	528	44
2943	67	1761	86	1180	81	910	72	518	27

HIT-NO=1355

SCORE= ()

SDBS-NO=1182

IR-NIDA-60114 : KBR DISC

5

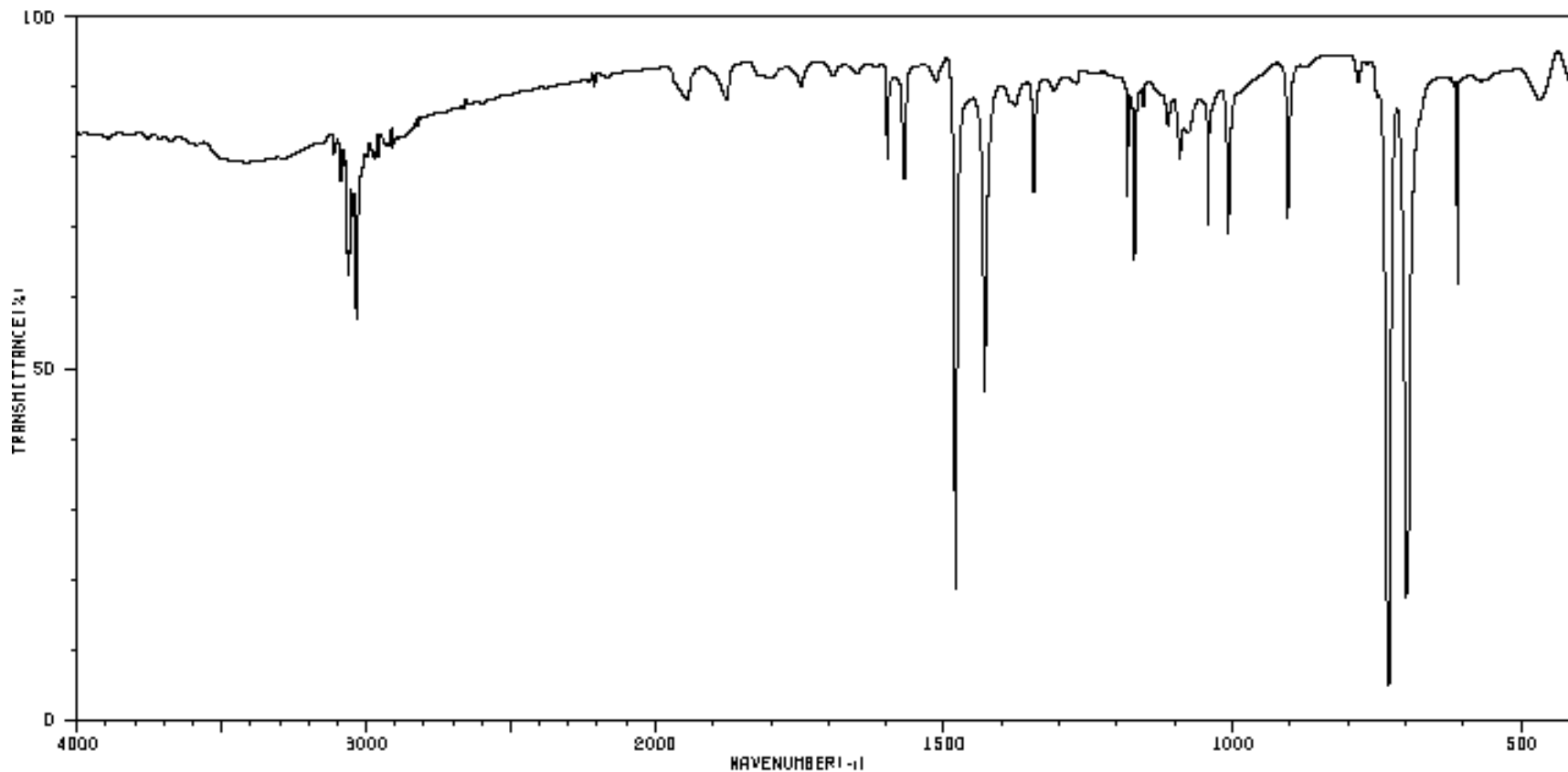

3111	77	2934	79	1669	74	1183	72	1007	66
3088	74	2921	79	1481	18	1170	62	904	68
3064	80	2908	79	1430	44	1155	64	730	4
3046	68	2876	79	1386	84	1112	81	700	16
3035	55	1944	84	1377	84	1092	77	611	60
2970	77	1877	84	1345	72	1077	79	468	64
2959	77	1699	77	1309	86	1043	68		

F.T

HIT-NO=1272

SCORE= ()

SDBS-NO=1028

IR-NIDA-21942 : LIQUID FILM

6

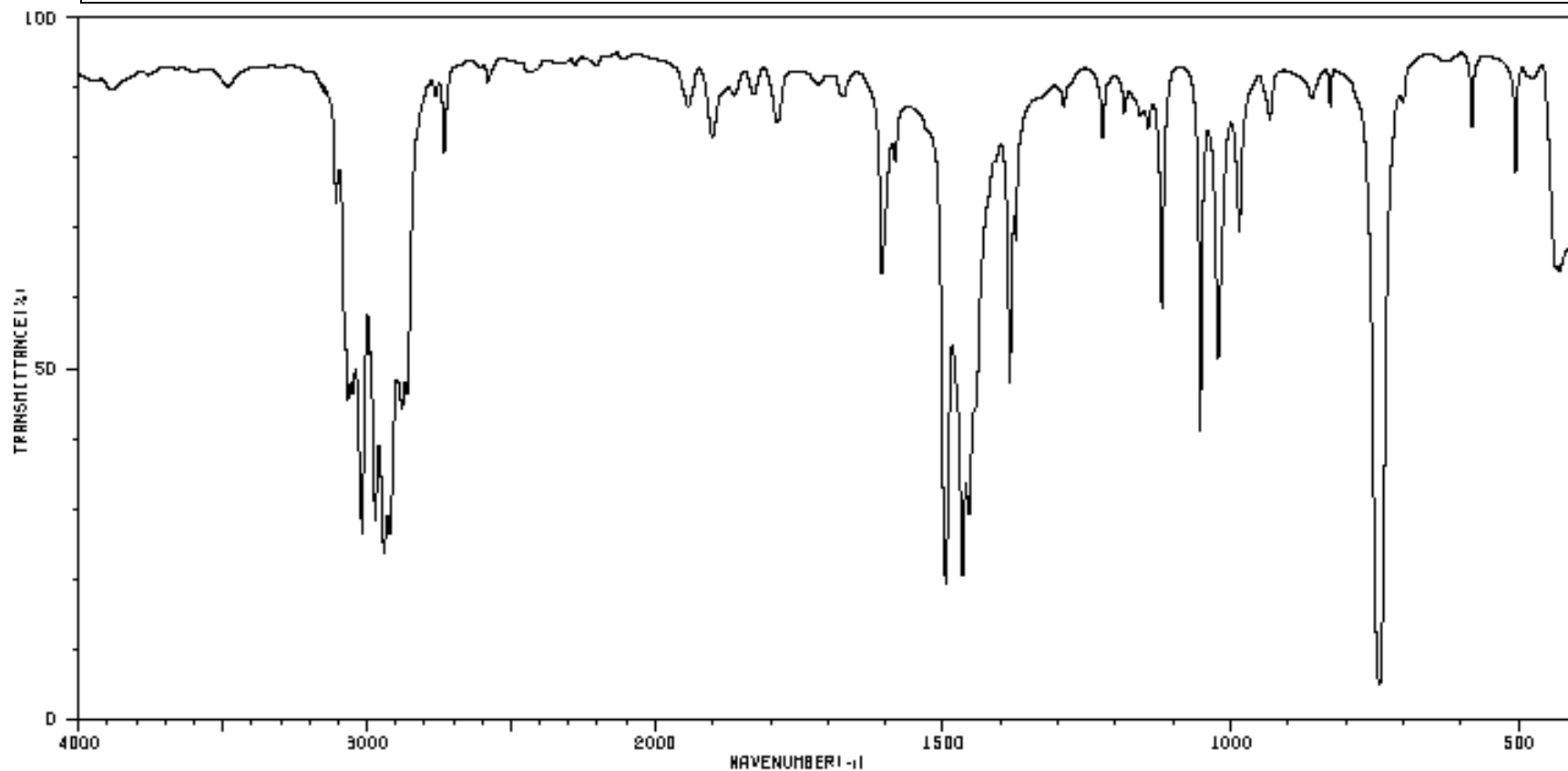

3108	70	2878	42	1683	77	1223	79	986	66
3066	43	2860	44	1495	18	1186	84	932	81
3050	44	2732	77	1467	20	1157	81	742	4
3018	25	1942	84	1466	27	1146	81	682	81
2971	26	1901	79	1384	46	1120	57	506	74
2940	22	1787	81	1374	86	1053	38	436	62
2921	25	1606	60	1291	84	1022	48	431	62

Chapter 7

NMR Spectroscopy

- A strong magnetic field causes the energies of certain nuclei to be split into two or more quantized levels, owing to the magnetic properties of these particles.
- Transitions among the resulting magnetically induced energy levels can be brought about by the absorption of EMR of suitable frequency,
- just as electronic transitions are caused by the absorption of ultraviolet or visible radiation.
- The energy differences between magnetic quantum levels for atomic nuclei correspond to radiation energies in the frequency range of 0.1 to 100MHz (wavelengths between 3000 and 3 m),
- which is in the radio-frequency portion of the electromagnetic spectrum.

The nuclei of many isotopes have a characteristic spin (**I**).

- Integral spins (e.g. $I = 1, 2, 3 \dots$),
- Fractional spins (e.g. $I = 1/2, 3/2, 5/2 \dots$),
- No spin, $I = 0$ (e.g. ^{12}C , ^{16}O , ^{32}S , \dots).
- Isotopes of particular interest and use to organic chemists are
 - ^1H , ^{13}C , ^{19}F and ^{31}P , all of which have $I = 1/2$.

Spin Properties of Nuclei

- Nuclear spin is related to the nucleon composition:
- Odd mass nuclei (i.e. those having an odd number of nucleons) have fractional spins.

Examples: $I = 1/2$ (^1H , ^{13}C , ^{19}F)

$$I = 3/2 \text{ (} ^{11}\text{B)}$$

$$I = 5/2 \text{ (} ^{17}\text{O)}$$

- Even mass nuclei composed of odd numbers of protons and neutrons have integral spins.
 - Examples: $I = 1$ (^2H , ^{14}N)
- Even mass nuclei composed of even numbers of protons and neutrons have zero spin ($I = 0$).
 - Examples: ^{12}C and ^{16}O
- Spin $1/2$ nuclei have a spherical charge distribution, and their NMR behavior is the easiest to understand.
- All nuclei with non-zero spins have magnetic moments (μ).

Nuclear Spin States

- ◆ Any atomic nucleus that has an odd mass, an odd atomic number, or both also has a spin and a resulting nuclear magnetic moment.
- ◆ The allowed nuclear spin states are determined by the spin quantum number, I , of the nucleus.
- ◆ A nucleus with spin quantum number I has $2I + 1$ spin states. If $I = 1/2$, there are two allowed spin states.

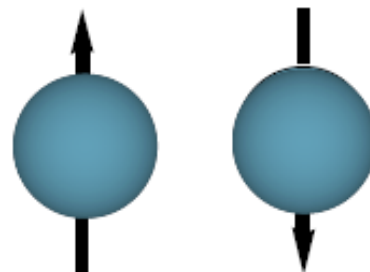

Isotope	Natural % Abundance	Spin (I)	Magnetic Moment (μ)	Magnetogyric Ratio (γ) *
^1H	99.9844	1/2	2.7927	26.753
^2H	0.0156	1	0.8574	4,107
^{11}B	81.17	3/2	2.6880	--
^{13}C	1.108	1/2	0.7022	6,728
^{17}O	0.037	5/2	-1.8930	-3,628
^{19}F	100.0	1/2	2.6273	25,179
^{29}Si	4.700	1/2	-0.5555	-5,319
^{31}P	100.0	1/2	1.1305	10,840

The following features lead to the NMR phenomenon:

1. A spinning charge generates a magnetic field.



The resulting spin-magnet has a magnetic moment (μ) proportional to the spin.

2. In the presence of an external magnetic field (\mathbf{B}_0), two spin states exist, **+1/2** and **-1/2**.

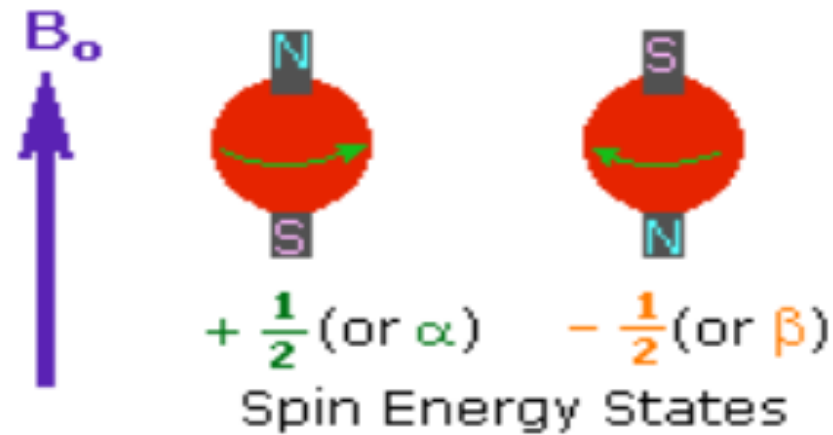

The magnetic moment of the **lower energy +1/2 state** is **aligned** with the external field, but that of the **higher energy -1/2 spin state** is **opposed** to the external field.

Note that the arrow representing the external field points North.

- 3.** The **difference in energy** between the two spin states is dependent on the **external magnetic field strength**, and is always very small.

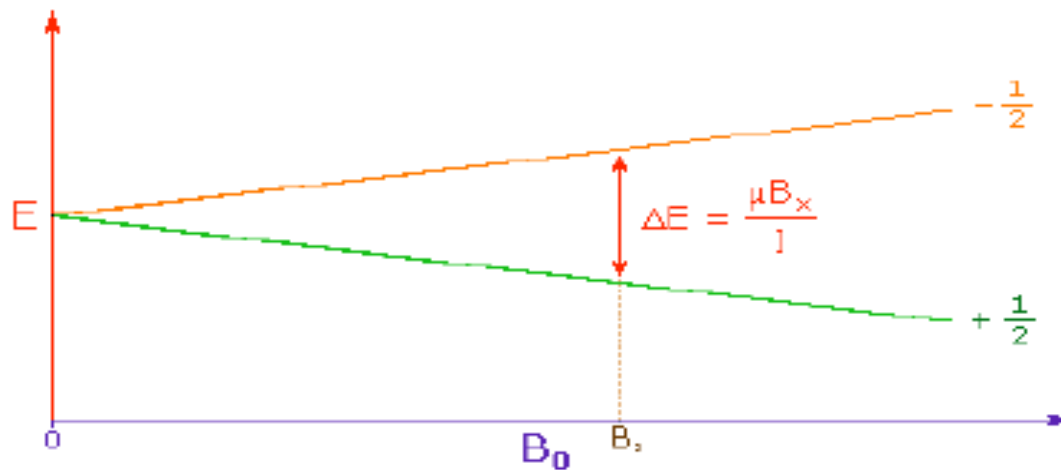

The two spin states have the same energy when the external field is zero, but diverge as the field increases.

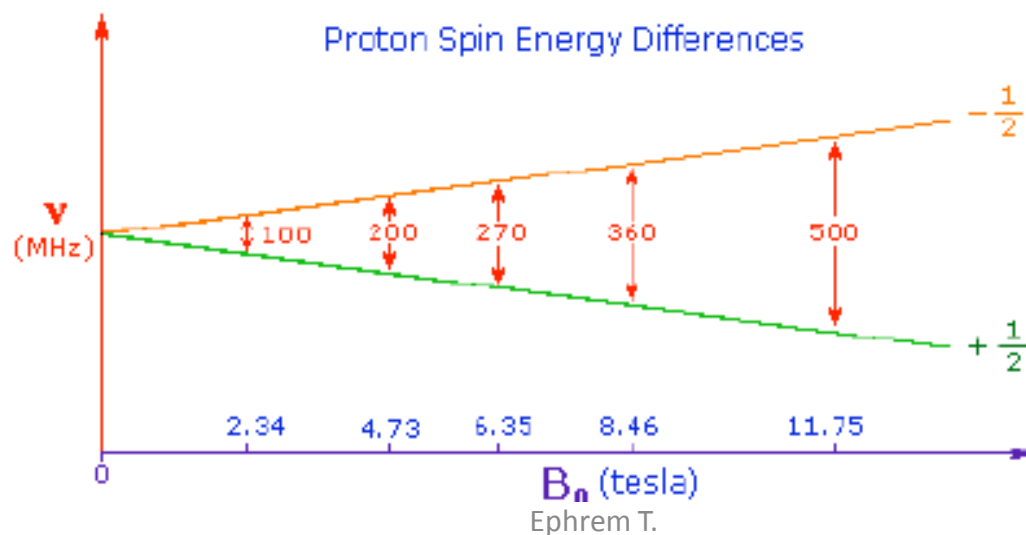

Energy Levels in a Magnetic Field

The potential energy E of a nucleus is given by

$$E = -\frac{\gamma m h}{2\pi} B_0$$

where m is magnetic quantum states given by

$$m = I, I-1, I-2, \dots, -I$$

and B_0 is an external magnetic field.

The energy for the lower energy state ($m = +1/2$) is

$$E_{+1/2} = -\frac{\gamma h}{4\pi} B_0$$

 For the $m = -1/2$ it is

$$E_{-1/2} = \frac{\gamma h}{4\pi} B_0$$

Thus the difference in energy ΔE between the two is

$$\Delta E = \frac{\gamma \hbar}{4\pi} B_0 - \left(-\frac{\gamma \hbar}{4\pi} B_0 \right) = \frac{\gamma \hbar}{2\pi} B_0$$

Recall that $\Delta E = h\nu_0$

Thus the frequency required to bring about the transition is

$$\nu_0 = \frac{\gamma B_0}{2\pi}$$

4. For spin 1/2 nuclei the **energy difference** between the two spin states at a given magnetic field strength will be proportional to their **magnetic moments**.

Magnetic Moments for the four common nuclei:

$${}^1\text{H } \mu = 2.7927$$

$${}^{31}\text{P } \mu = 1.1305$$

$${}^{19}\text{F } \mu = 2.6273$$

$${}^{13}\text{C } \mu = 0.7022$$

Approximate frequencies that correspond to the spin state energy separations for each of these nuclei in an external magnetic field of 2.34 T.

$$B_0 = 2.34 \text{ T}$$

$$\nu = \frac{\mu B_0}{hI} = \frac{4.68\mu}{h}$$



A Model for NMR Spectroscopy

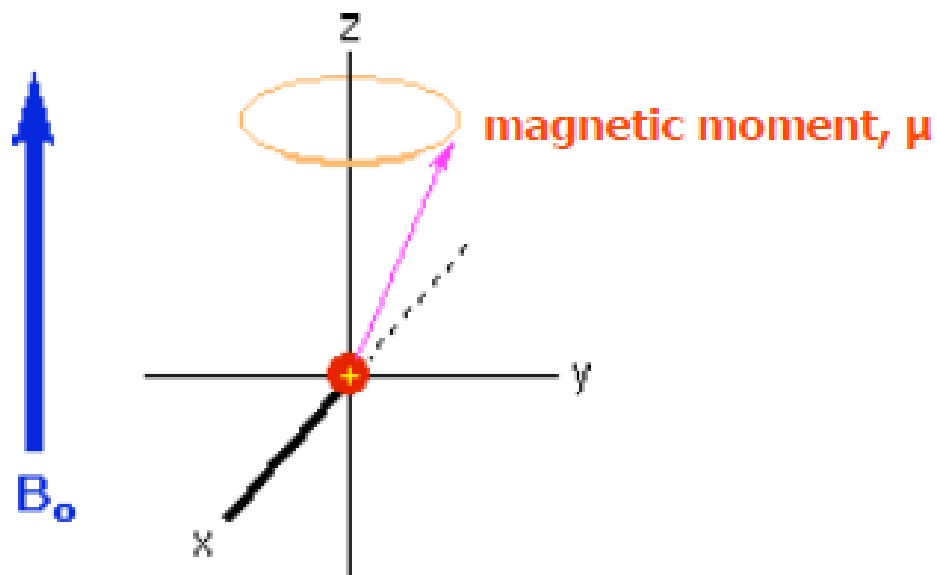

A Spinning Charge
in a Magnetic Field

The frequency of precession is proportional to the strength of the magnetic field, as noted by the equation:

$$\omega_0 = \gamma B_0$$

The frequency ω_0 is called the **Larmor frequency** and has units of radians per second.

The proportionality constant γ is known as the **gyromagnetic ratio** and is proportional to the magnetic moment.

If RF energy having a frequency matching the Larmor frequency is introduced at a right angle to the external field (e.g. along the x-axis), the precessing nucleus will absorb energy and the magnetic moment will flip to its $I = -1/2$ state.

This excitation is shown in the following diagram. Note that frequencies in radians per second may be converted to Hz (cps) by dividing by 2π .

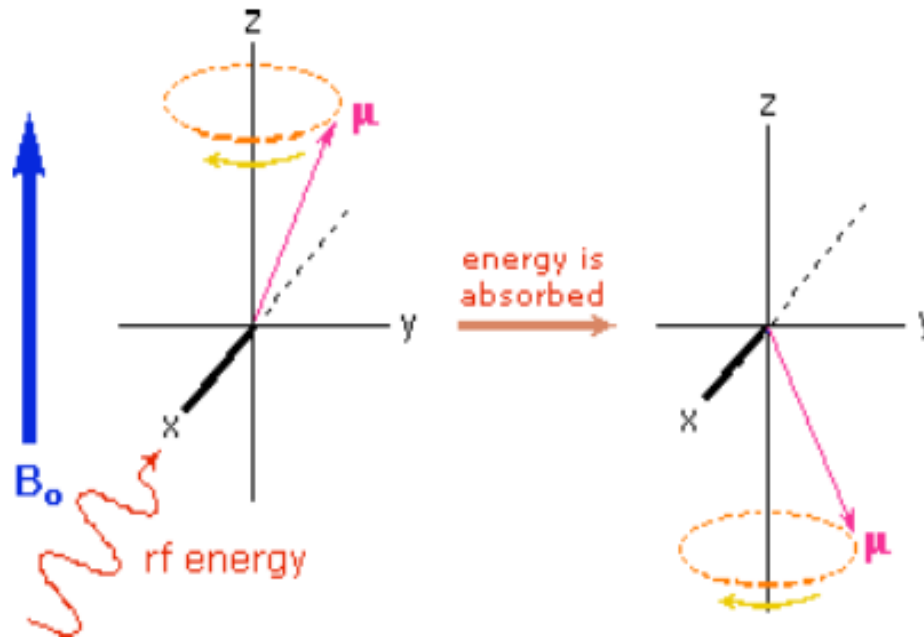

The energy difference between nuclear spin states is small compared with the average kinetic energy of room temperature samples, and the $+1/2$ and $-1/2$ states are nearly equally populated.

42 |

Excitation by RF Energy and Subsequent Relaxation

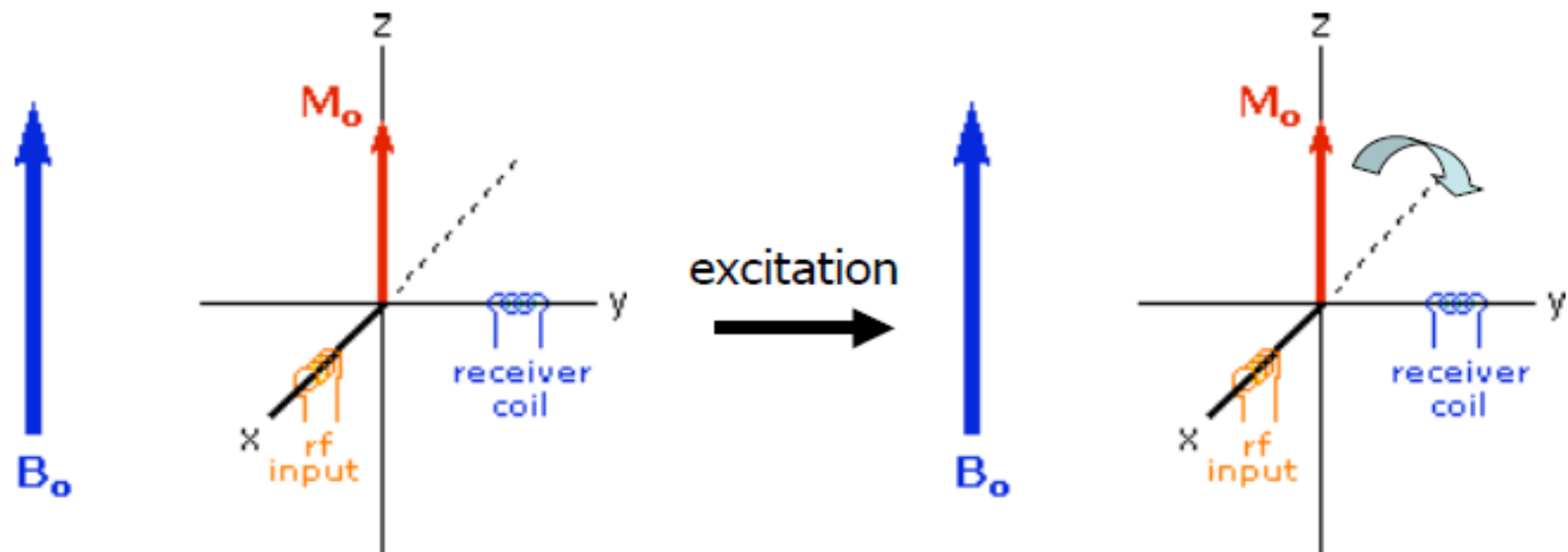

The net magnetization shifts away from the z-axis and toward the y-axis.

After irradiation the nuclear spins return to equilibrium in a process called **relaxation**.

CL Activity 1: nuclear spin states

1. List allowed spin state with spin quantum number 2 & 5/2.

$$m = l, l-1, l-2, \dots, -l$$

$$\text{eq. } 2l+1$$

$$2 \times 2 + 1 = 5 \quad 2, 1, 0, -1, -2$$

$$2 \times 5/2 + 1 = 6 \quad 5/2, 3/2, 1/2, -1/2, -3/2, -5/2$$

Magnetic Shielding

- If all protons absorbed the same amount of energy in a given magnetic field, not much information could be obtained.
- But protons are surrounded by electrons that shield them from the external field.
- Circulating electrons create an induced magnetic field that opposes the external magnetic field. =>

Shielded Protons

Magnetic field strength must be increased for a shielded proton to flip at the same frequency.

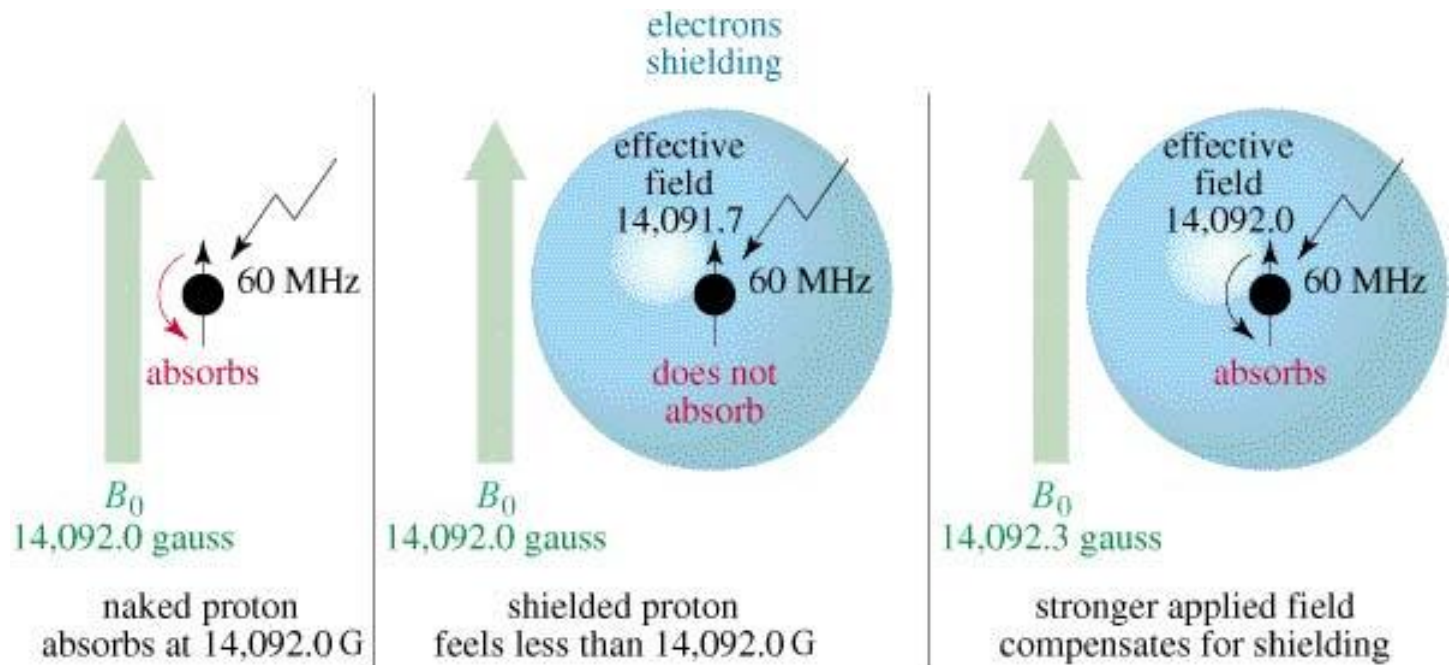

Protons in a Molecule

Depending on their chemical environment, protons in a molecule are shielded by different amounts.

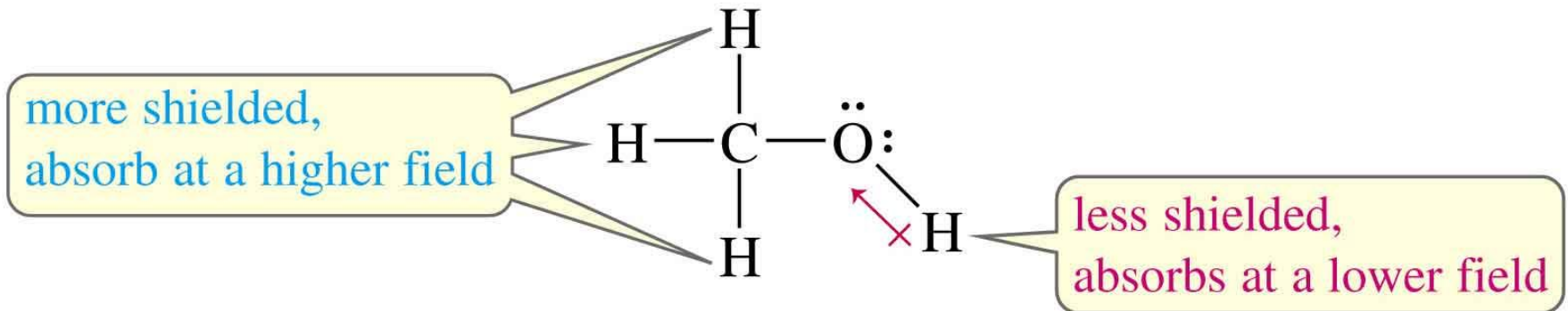

=>

NMR Signals

- The ***number*** of signals shows how many different kinds of protons are present.
- The ***location*** of the signals shows how shielded or deshielded the proton is.
- The ***intensity*** of the signal shows the number of protons of that type.
- Signal ***splitting*** shows the number of protons on adjacent atoms. =>

The NMR Spectrometer

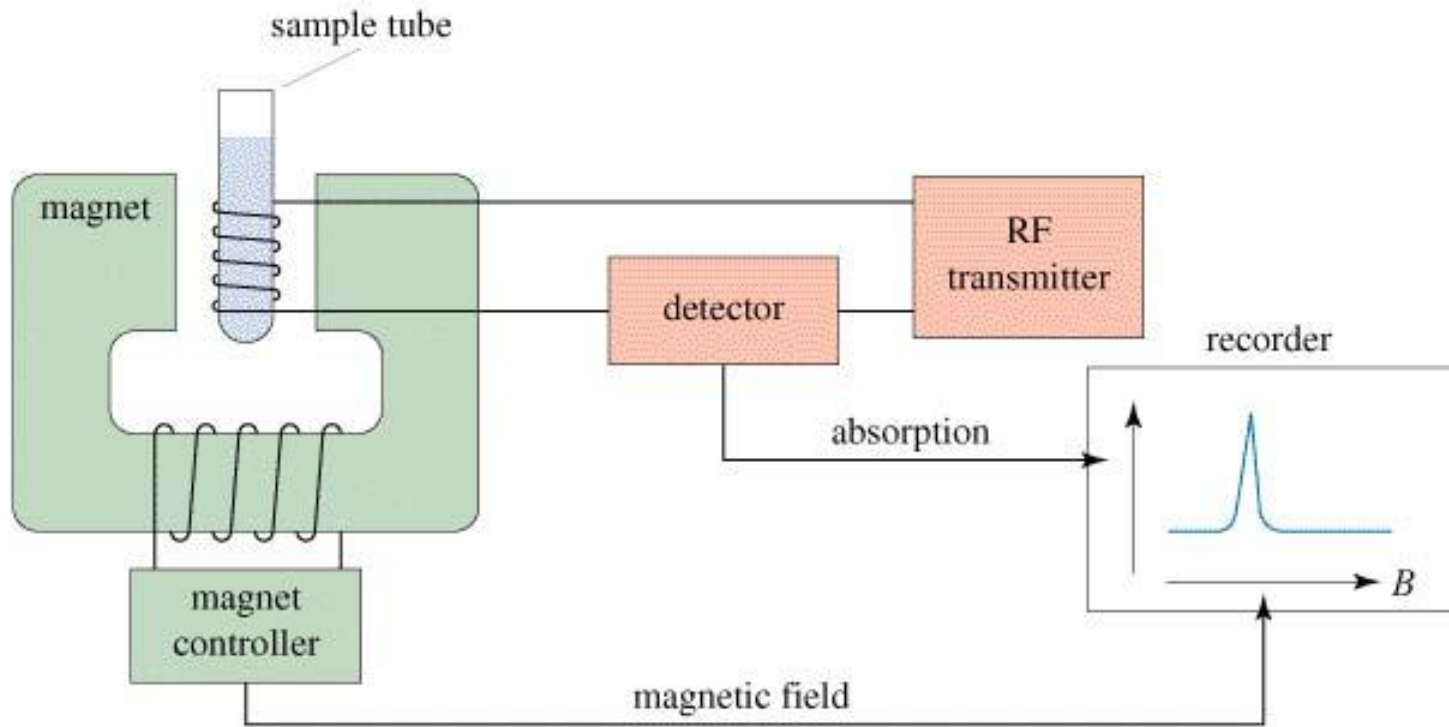

Varian 300 MHz NMR instrument

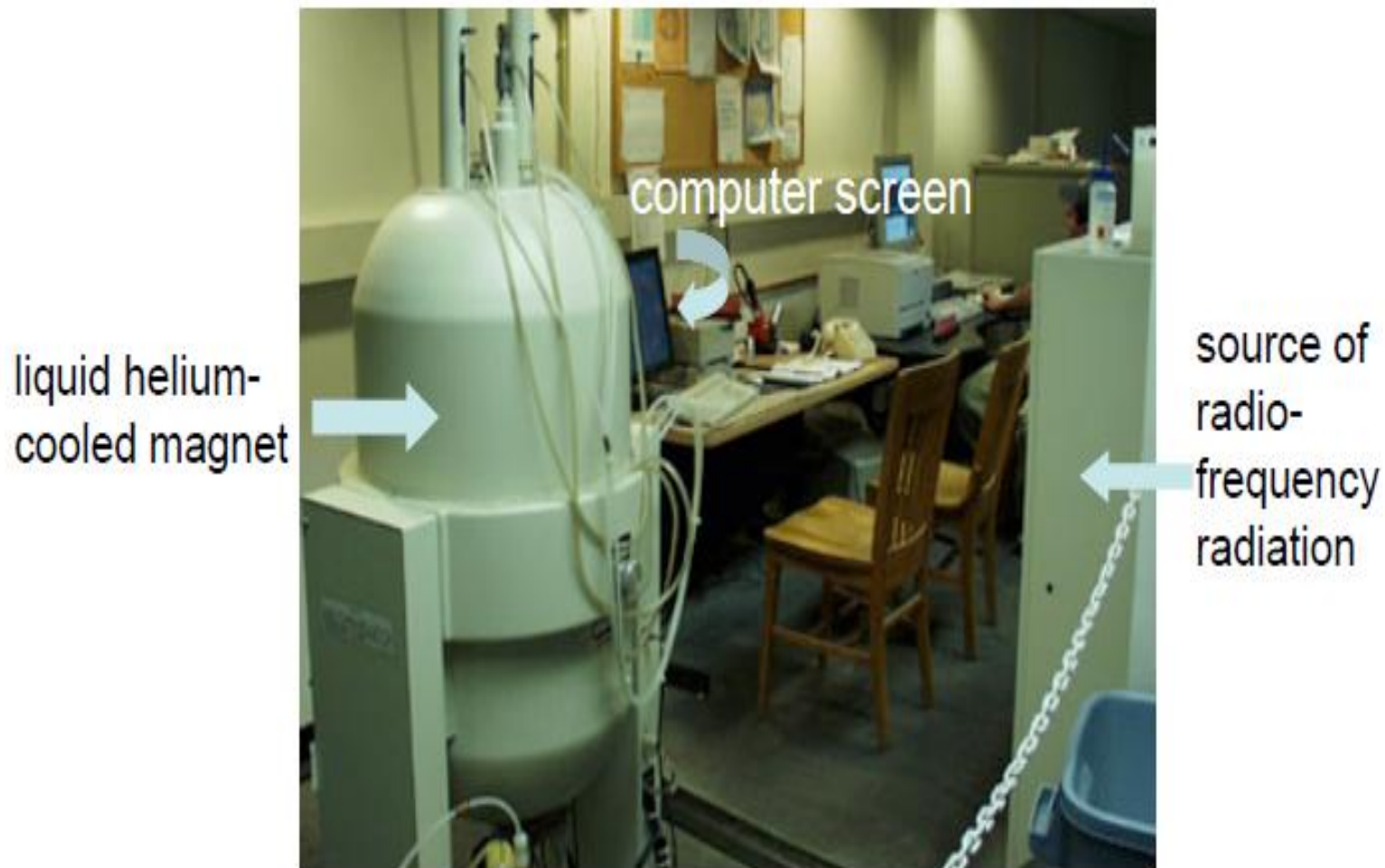

ER Procedure

1. A solution of the sample in a uniform 5 mm glass tube is oriented between the poles of a powerful magnet.
2. It is spun to average any magnetic field variations, as well as tube imperfections.
3. Radio frequency radiation of appropriate energy is broadcast into the sample from an antenna coil (colored red).
4. A receiver coil surrounds the sample tube, and emission of absorbed RF energy is monitored by dedicated electronic devices and a computer.
5. An NMR spectrum is acquired by varying or sweeping the magnetic field over a small range while observing the RF signal from the sample.

As an example, consider a sample of water in a 2.3487 T external magnetic field, irradiated by 100 MHz radiation.

If the magnetic field is smoothly increased to 2.3488 T, the hydrogen nuclei of the water molecules will at some point absorb RF energy and a resonance signal will appear.

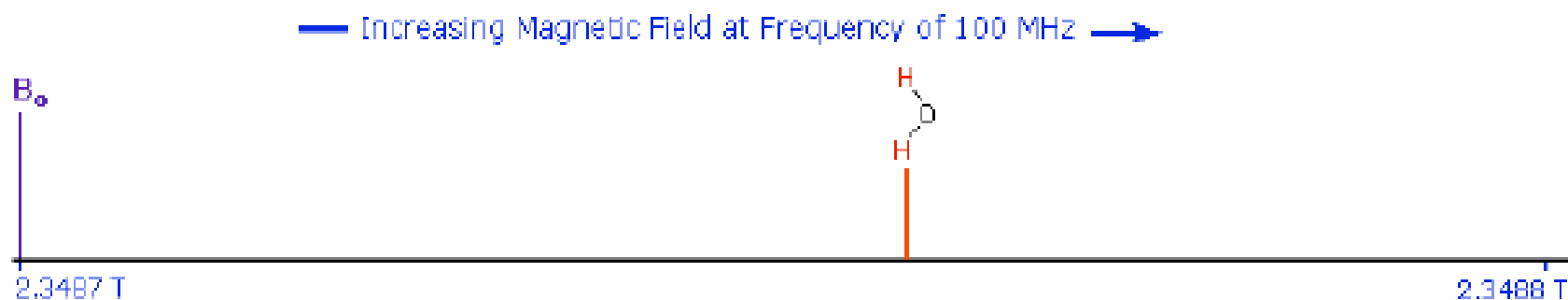

Since protons all have the same magnetic moment, we might expect all hydrogen atoms to give resonance signals at the same field / frequency values.

Resonance: the absorption of electromagnetic radiation by a nucleus and the flip of its nuclear spin from a lower energy state to a higher energy state.

➤ The instrument detects this and records it as a signal

Fortunately for chemistry applications, this is not true.

- Increasing Magnetic Field at Fixed Frequency →
- ← Increasing Frequency at Fixed Magnetic Field
- Increased Shielding by Extranuclear electrons →

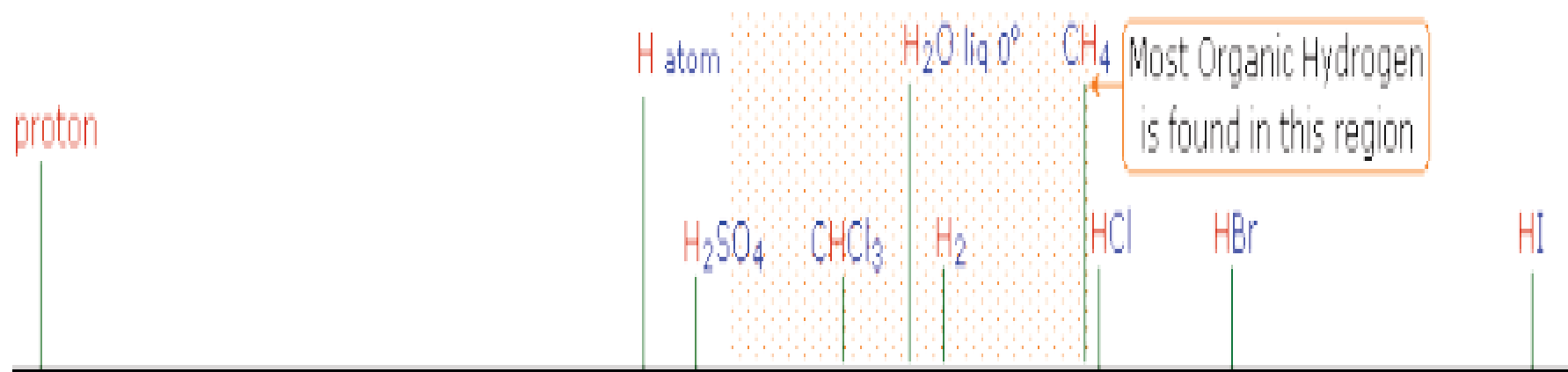

Why should the proton nuclei in different compounds behave differently in the NMR experiment ?

- Since electrons are charged particles, they move in response to the external magnetic field (B_0) so as to generate a secondary field that opposes the much stronger applied field.

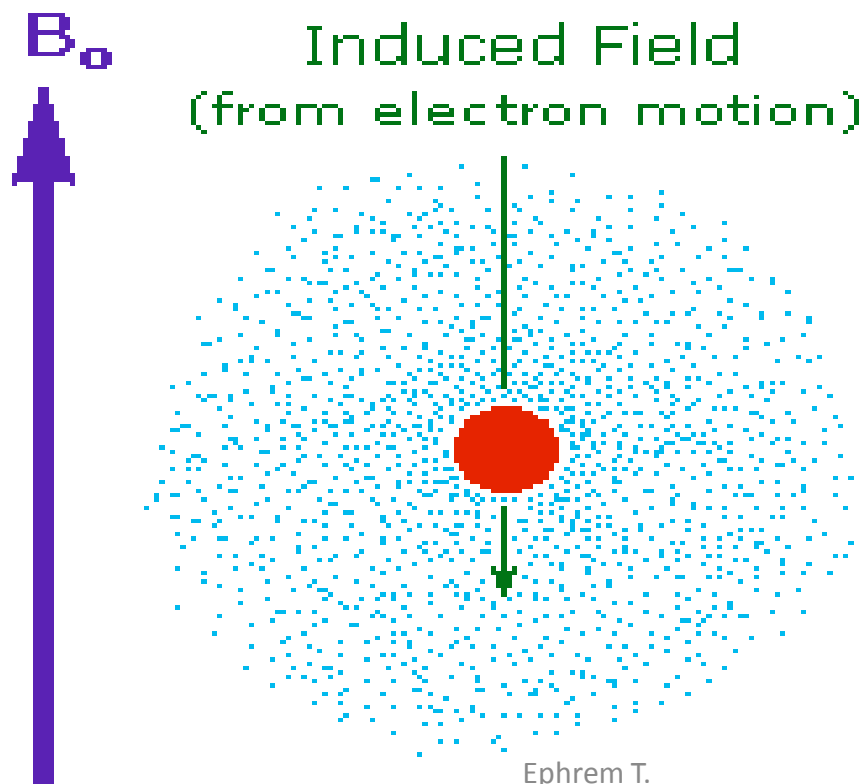

The secondary field **shields the nucleus from the applied field**, so B_0 must be increased in order to achieve resonance (absorption of RF energy).

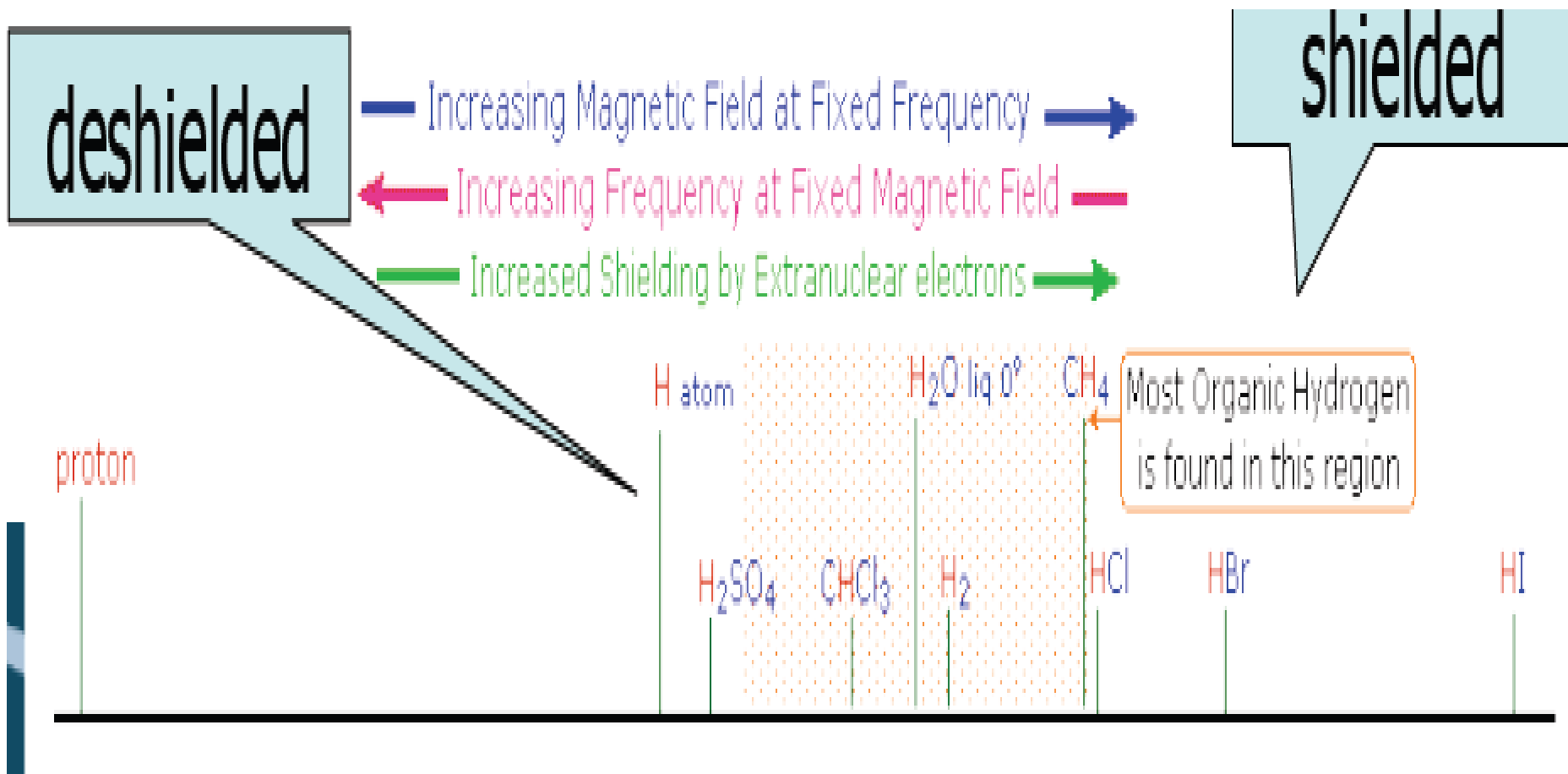

Chemical Shift

The location of different NMR resonance signals is dependent on both the external magnetic field strength and the RF frequency.

- Increasing Magnetic Field at Fixed Frequency —→
- ← Increasing Frequency at Fixed Magnetic Field ←
- Increased Shielding by Extranuclear electrons —→

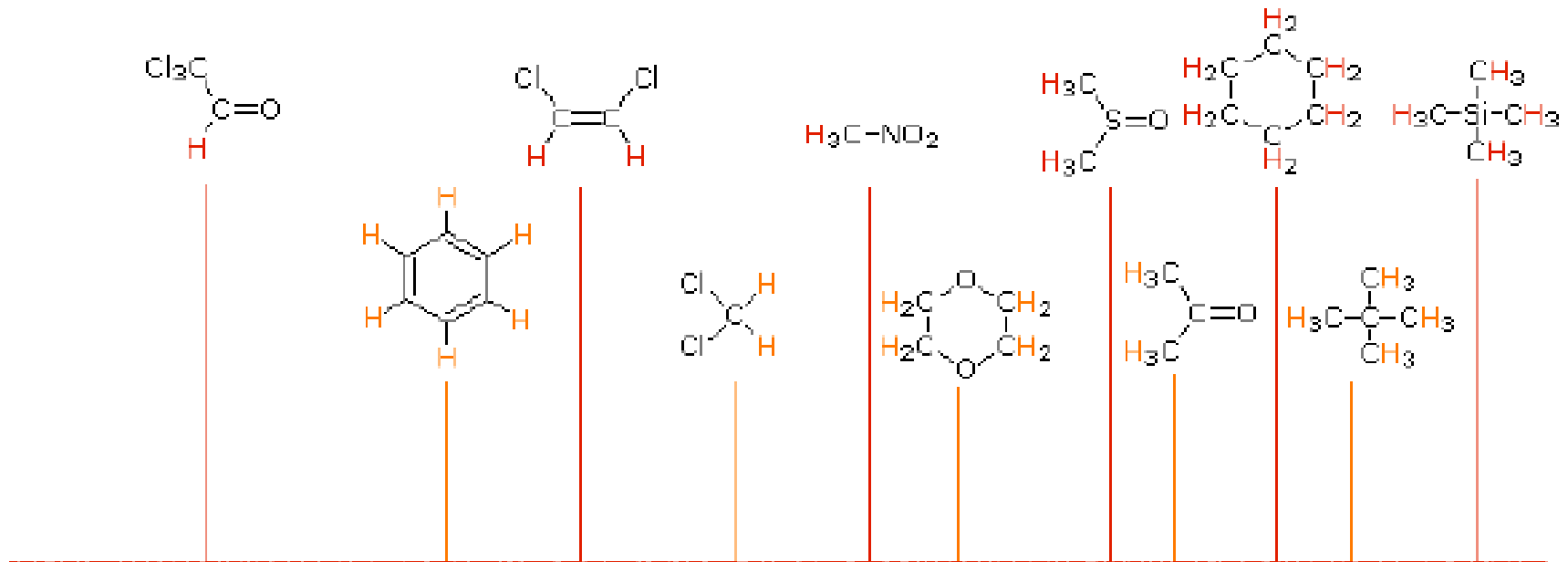

^1H NMR Resonance Signals for some Different Compounds

The location of an NMR signal in a spectrum is reported relative to a reference signal from a standard compound added to the sample.

A reference standard should be

1. Chemically unreactive
2. Easily removed from the sample after the measurement
3. Should give a single sharp NMR signal that does not interfere with the resonances normally observed for organic compounds.

Tetramethylsilane, $(\text{CH}_3)_4\text{Si}$, usually referred to as TMS,
meets all these characteristics

— Increasing Magnetic Field at Fixed Frequency —→

← Increasing Frequency at Fixed Magnetic Field ←—

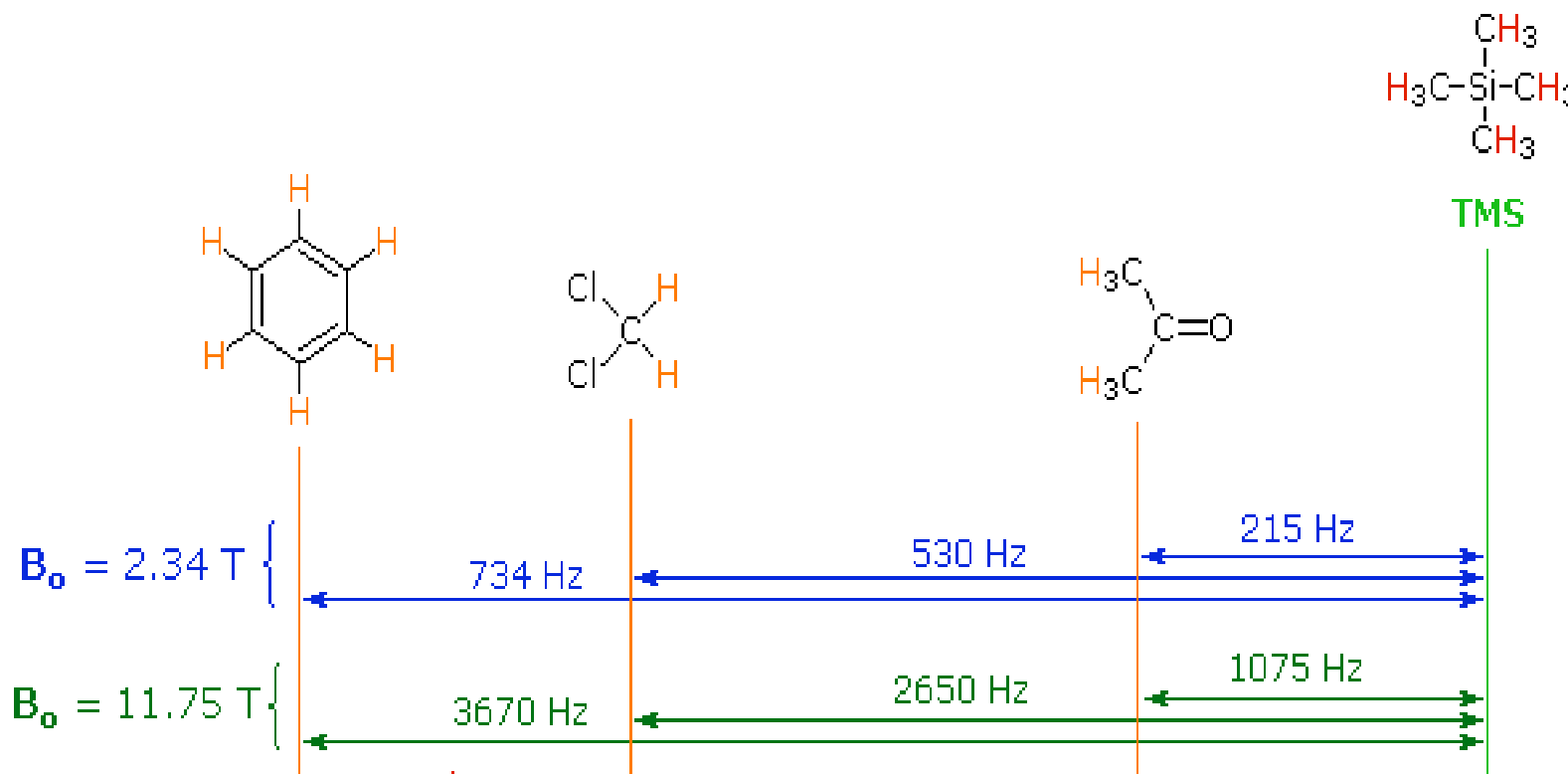

The Separation of Resonance Signals (in Hz) Increases with Increasing Field Strength

To correct these frequency differences for their field dependence, these differences are divided by the spectrometer frequency (100 or 500 MHz in the example)

→ Increasing Magnetic Field at Fixed Frequency →
← Increasing Frequency at Fixed Magnetic Field ←

Chemical Shift

$$\delta = \left(\frac{\nu_{\text{samp}} - \nu_{\text{ref}}}{\nu_{\text{ref}}} \right) \times 10^6$$

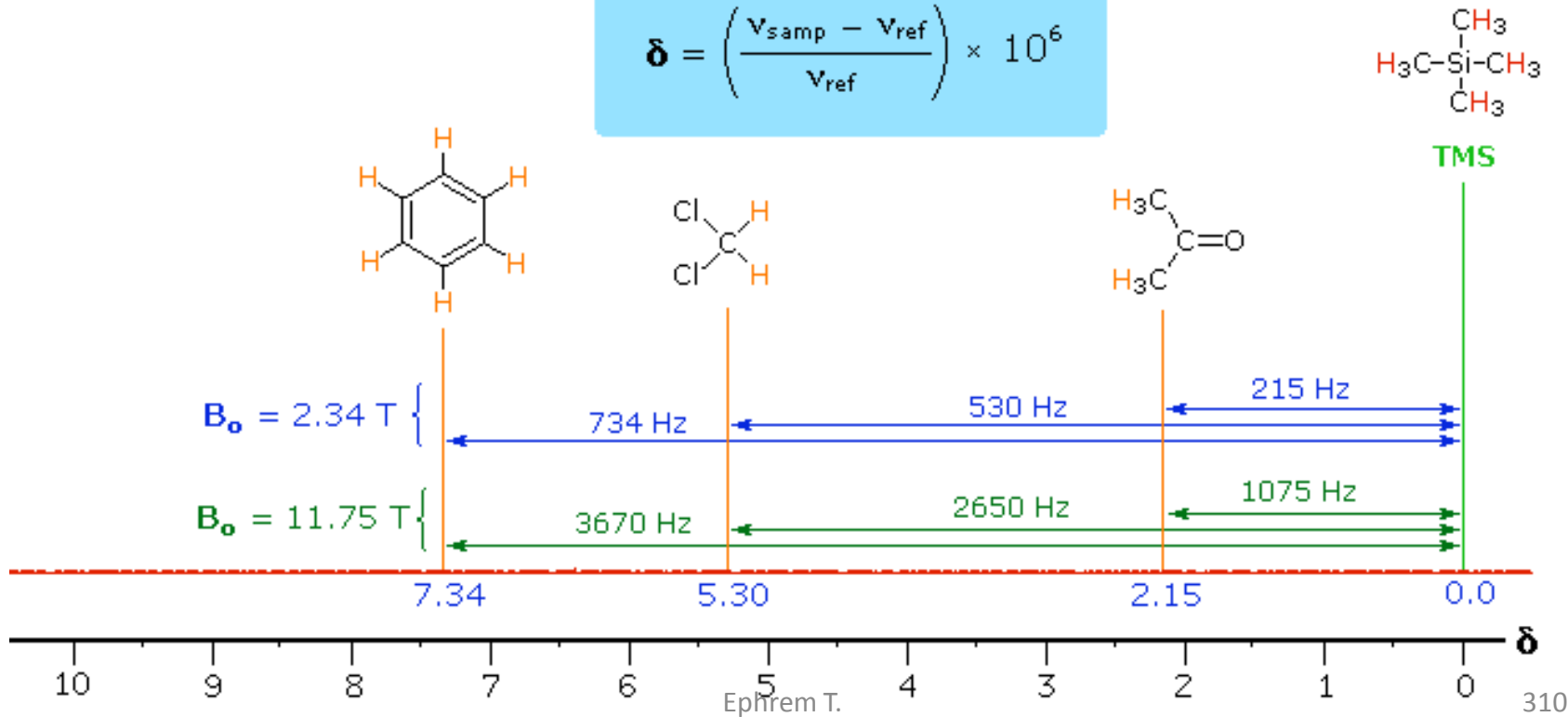

This operation gives a locator number called the **Chemical Shift**, having units of parts-per-million (ppm), and designated by the symbol δ .

- Increasing Magnetic Field at Fixed Frequency —→
- ← Increasing Frequency at Fixed Magnetic Field ←
- Increased Shielding by Extranuclear electrons —→

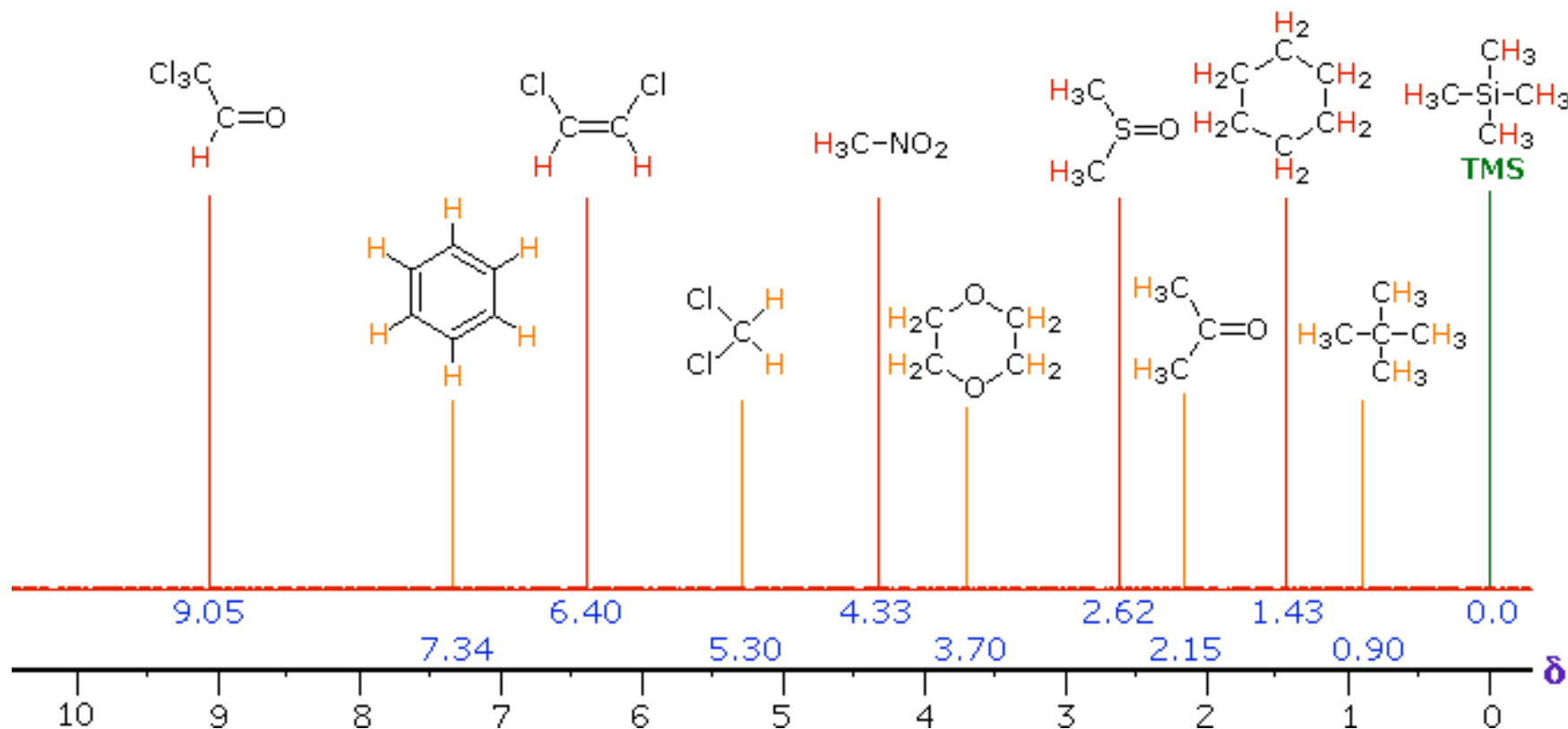

Commonly used solvents:

- CCl_4 – no interfering H, but poor solvent for many polar compounds and is also toxic.
- Deuterium labeled compounds: deuterium oxide (D_2O), chloroform-d (DCCl_3), benzene-d6 (C_6D_6), acetone-d6 (CD_3COCD_3) and DMSO-d6 (CD_3SOCD_3) are now widely used as NMR solvents.
- Deuterium is invisible in a spectrometer tuned to protons.
- One factor contributing to chemical shift differences in proton resonance is the **inductive effect**.
- The shielding effect in protons with high electron density is large, and a higher external field (B_0) will be needed for the RF energy to excite the nuclear spin.

Example

- Since Si is less EN than C, the electron density about the methyl hydrogens in $\text{Si}(\text{CH}_3)_4$ is expected to be greater than the electron density about the methyl hydrogens in $\text{C}(\text{CH}_3)_4$.
- The protons in TMS (with high e density) are said be **shielded**, and lie at higher magnetic field (**upfield**).
- Elements that are more electronegative than carbon should exert an opposite effect (reduce the electron density).
- Methyl groups bonded to such elements display lower field (**downfield**) signals (**they are deshielded**).

Proton Chemical Shifts of Methyl Derivatives

Compound	$(\text{CH}_3)_4\text{C}$	$(\text{CH}_3)_3\text{N}$	$(\text{CH}_3)_2\text{O}$	CH_3F
δ	0.9	2.1	3.2	4.1
Compound	$(\text{CH}_3)_4\text{Si}$	$(\text{CH}_3)_3\text{P}$	$(\text{CH}_3)_2\text{S}$	CH_3Cl
δ	0.0	0.9	2.1	3.0

Proton Chemical Shifts (ppm)

Cpd. / Sub.	X=Cl	X=Br	X=I	X=OR	X=SR
CH_3X	3.0	2.7	2.1	3.1	2.1
CH_2X_2	5.3	5.0	3.9	4.4	3.7
CHX_3	7.3	6.8	4.9	5.0	

Note that chemical shift increases as EN increases.

Proton Chemical Shift Ranges*

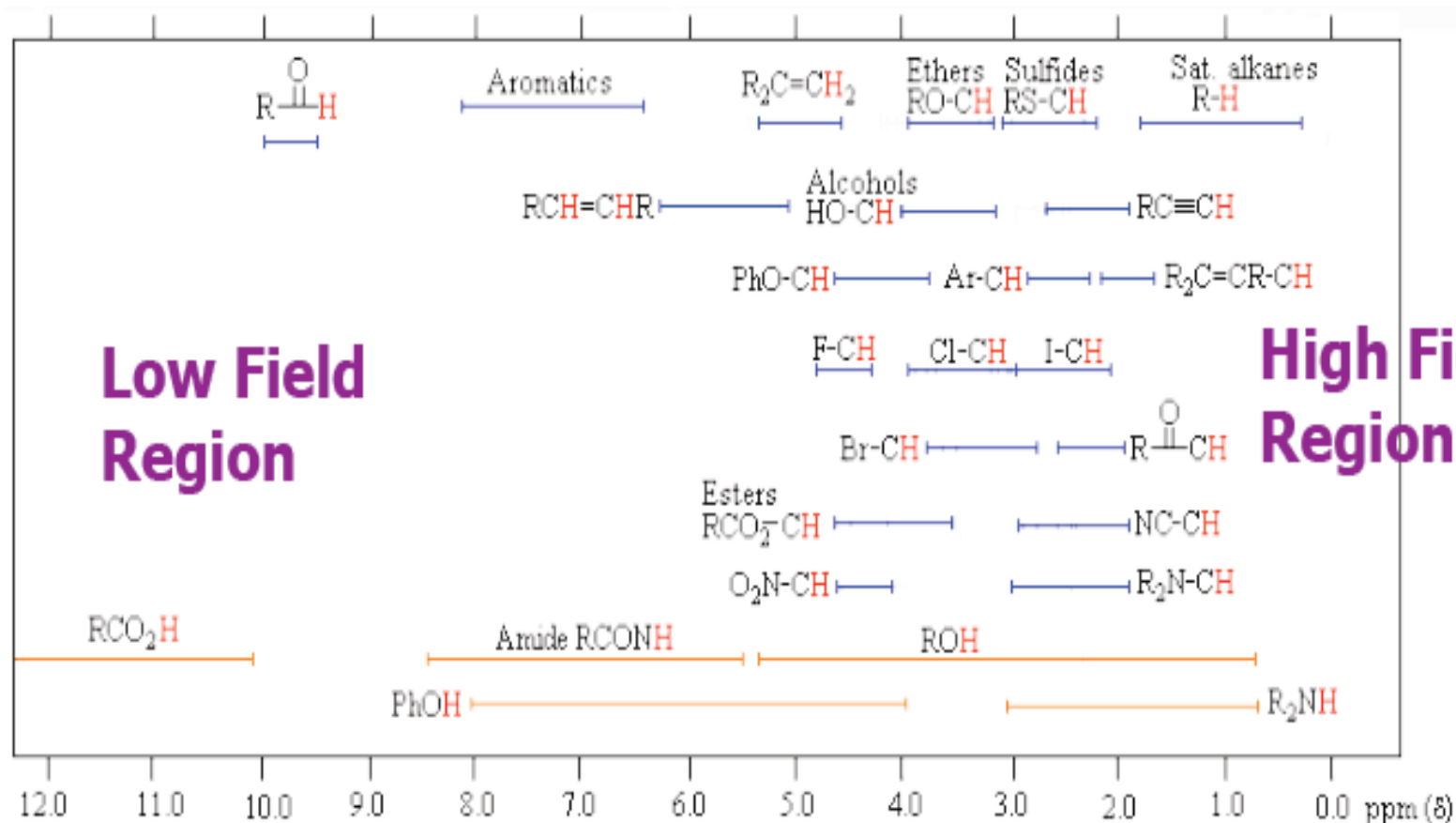

* For samples in CDCl_3 solution. The δ scale is relative to TMS at $\delta = 0$.

Signal Strength

The magnitude of NMR signals is proportional to the molar concentration of the sample.

Example

For equal molar amounts of benzene and cyclohexane, the signal from cyclohexane will be twice as intense as that from benzene because cyclohexane has twice as many hydrogens per molecule.

- Similarly, for samples incorporating two or more different sets of hydrogen atoms, the ratio of hydrogen atoms in each distinct set can be determined.

Methods

1) Through horizontal integrator trace (light green) which rises as it crosses each signal by a distance proportional to the signal strength.

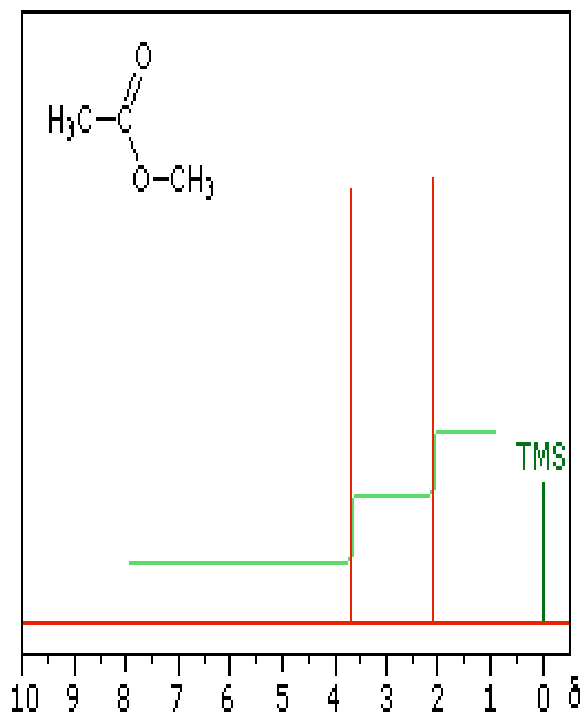
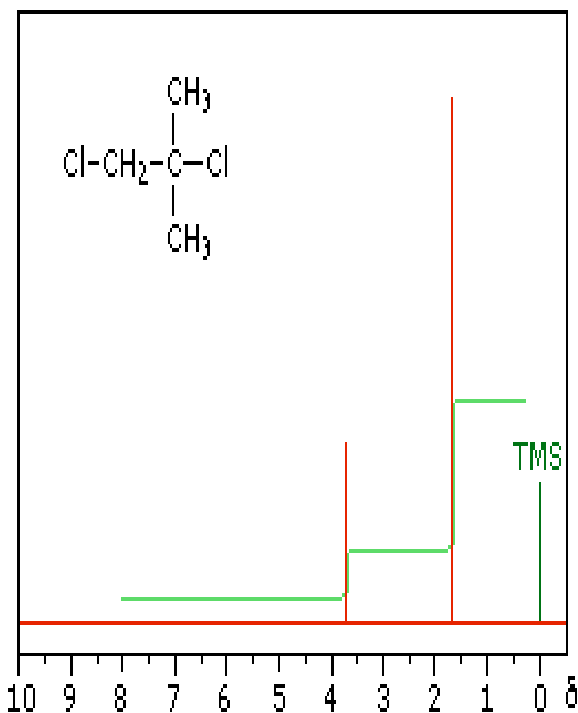
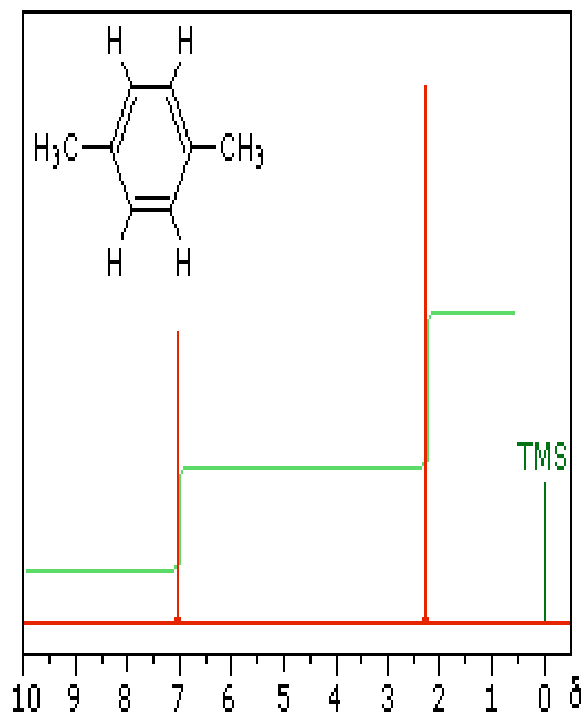

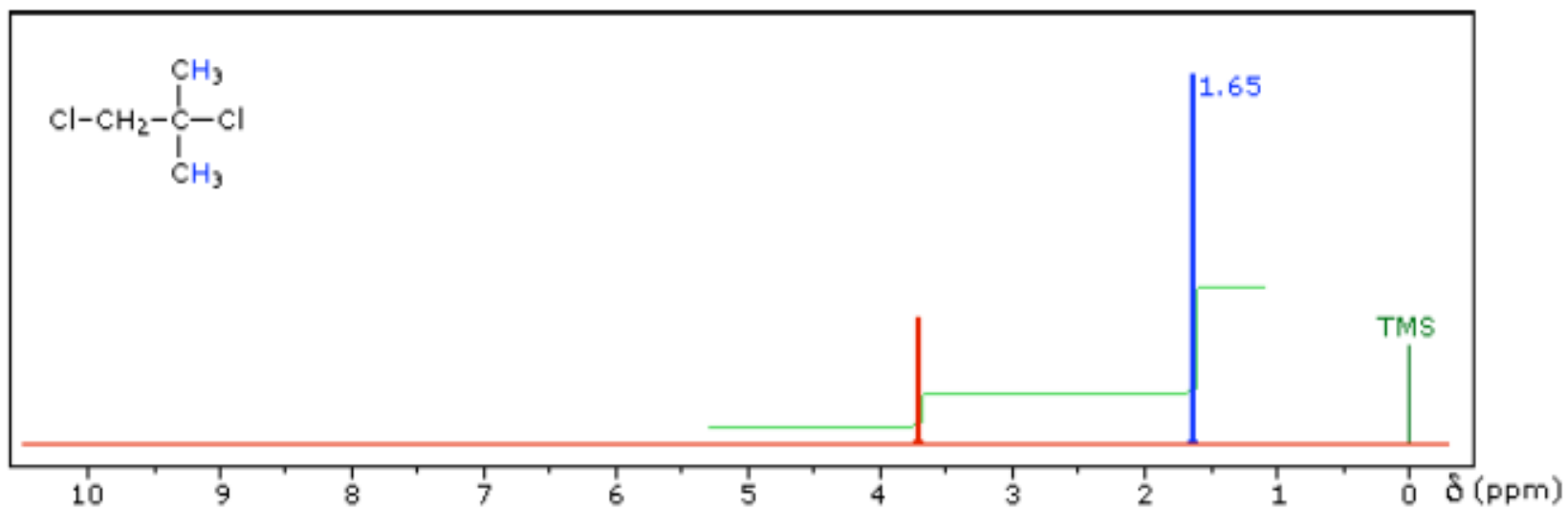
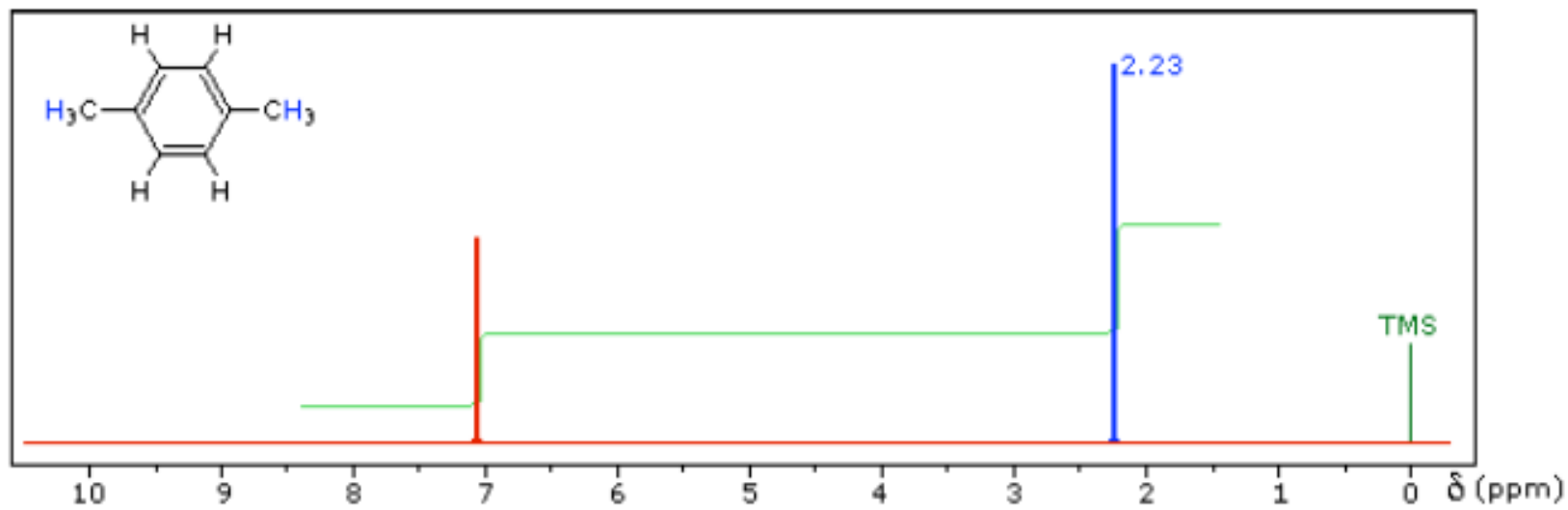

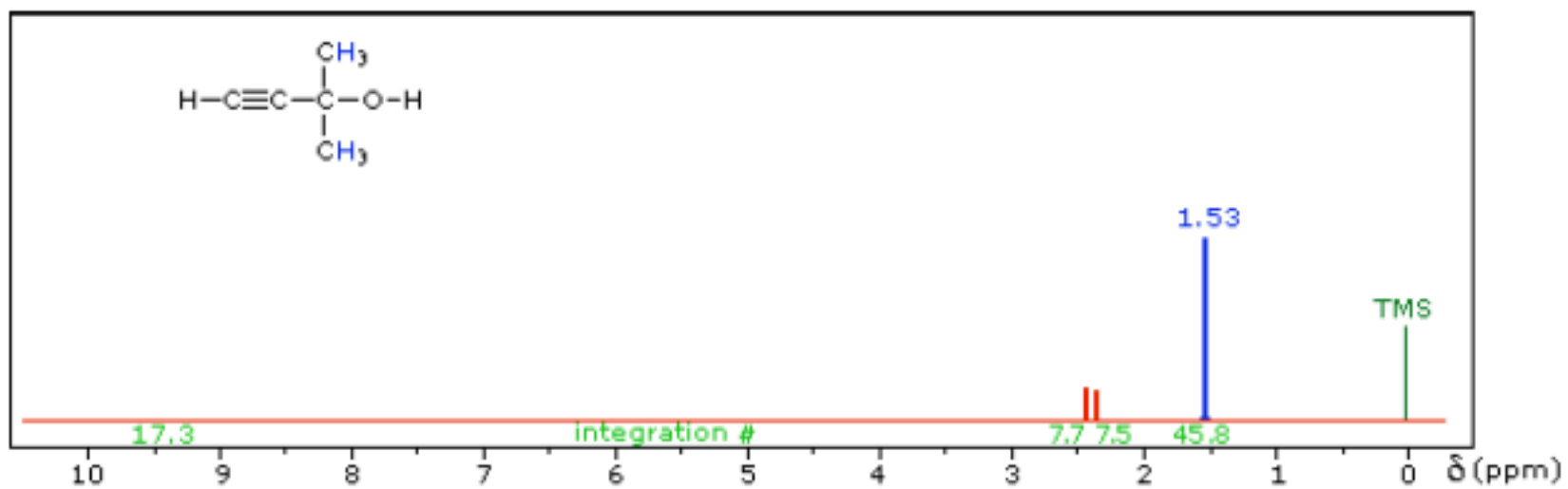
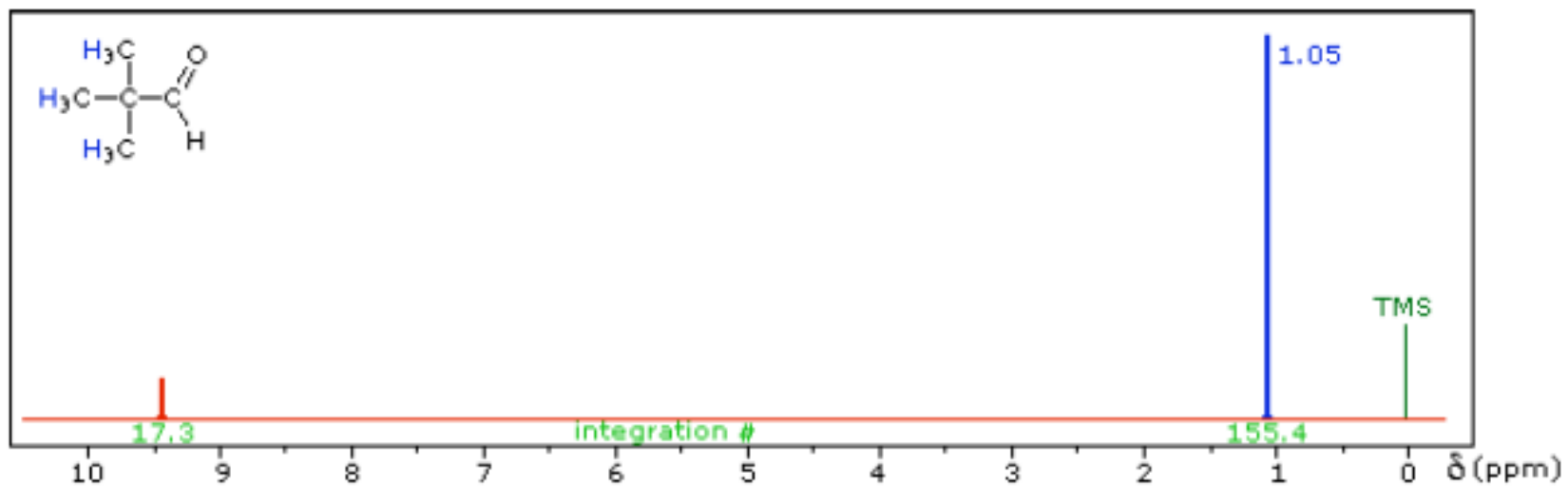

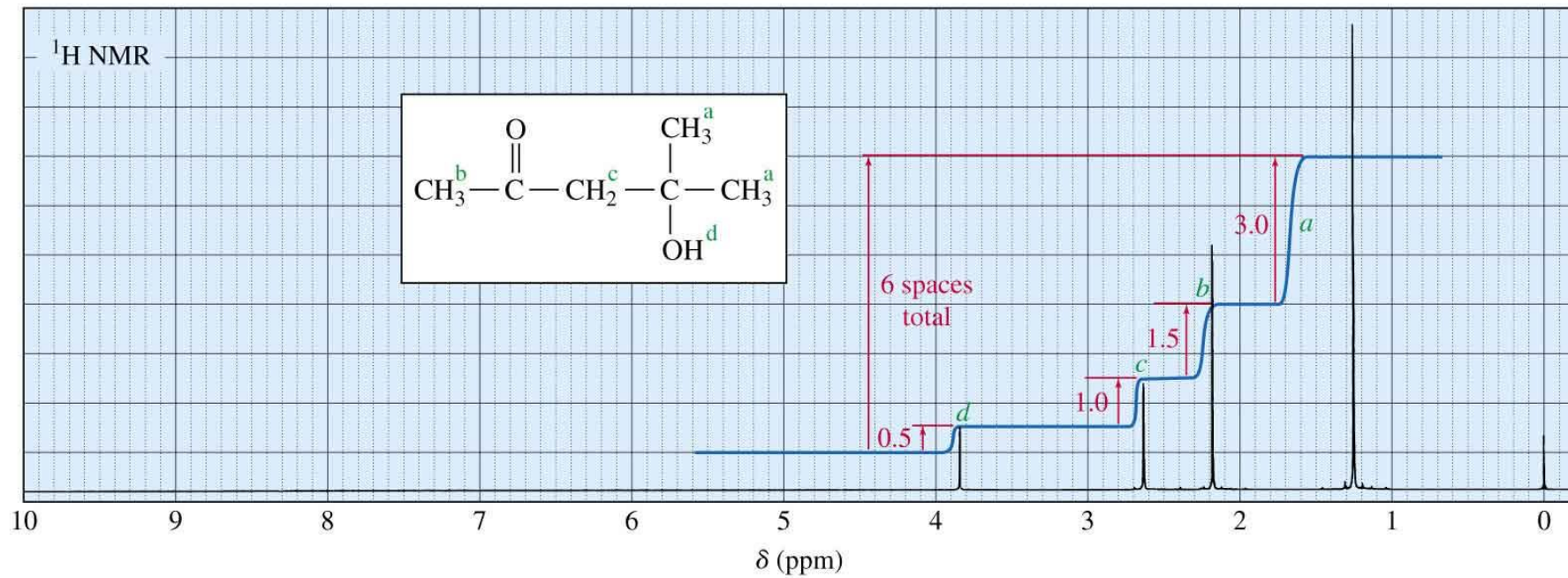
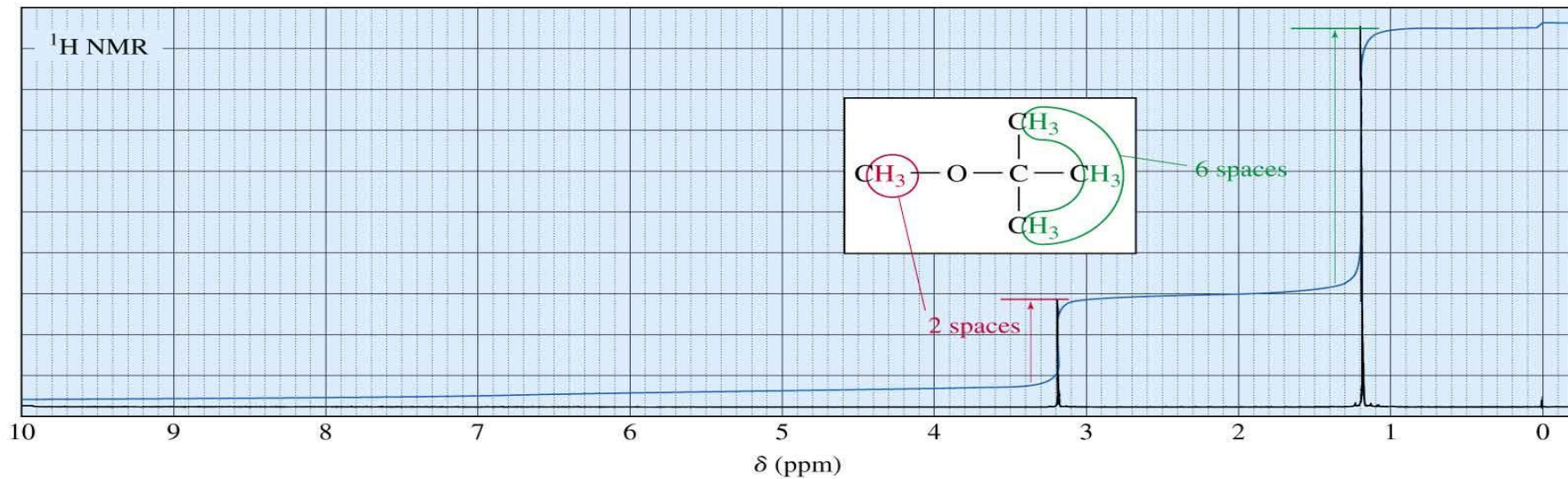

=>

Activity 1 Structurally Equivalent Atoms & Groups

For each of the compounds **A through F** indicate the number of structurally distinct groups of equivalent hydrogens

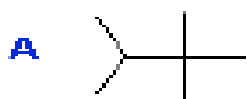

A

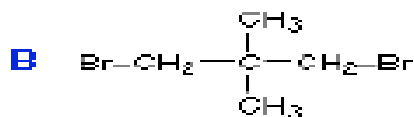

B



C

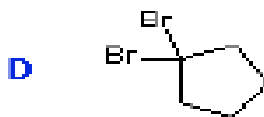

D



E

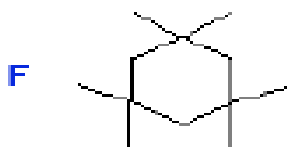

F

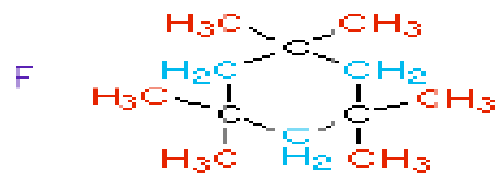
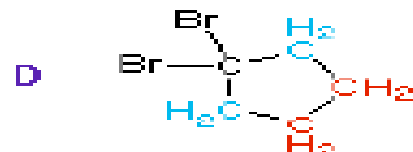
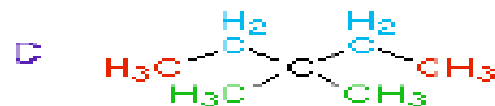
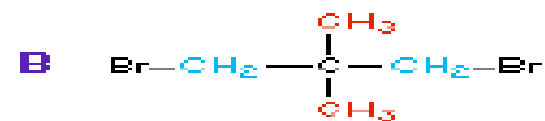
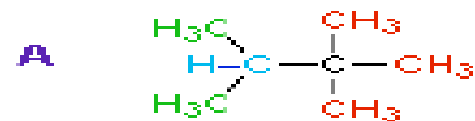

The Influence of Magnetic Field Strength

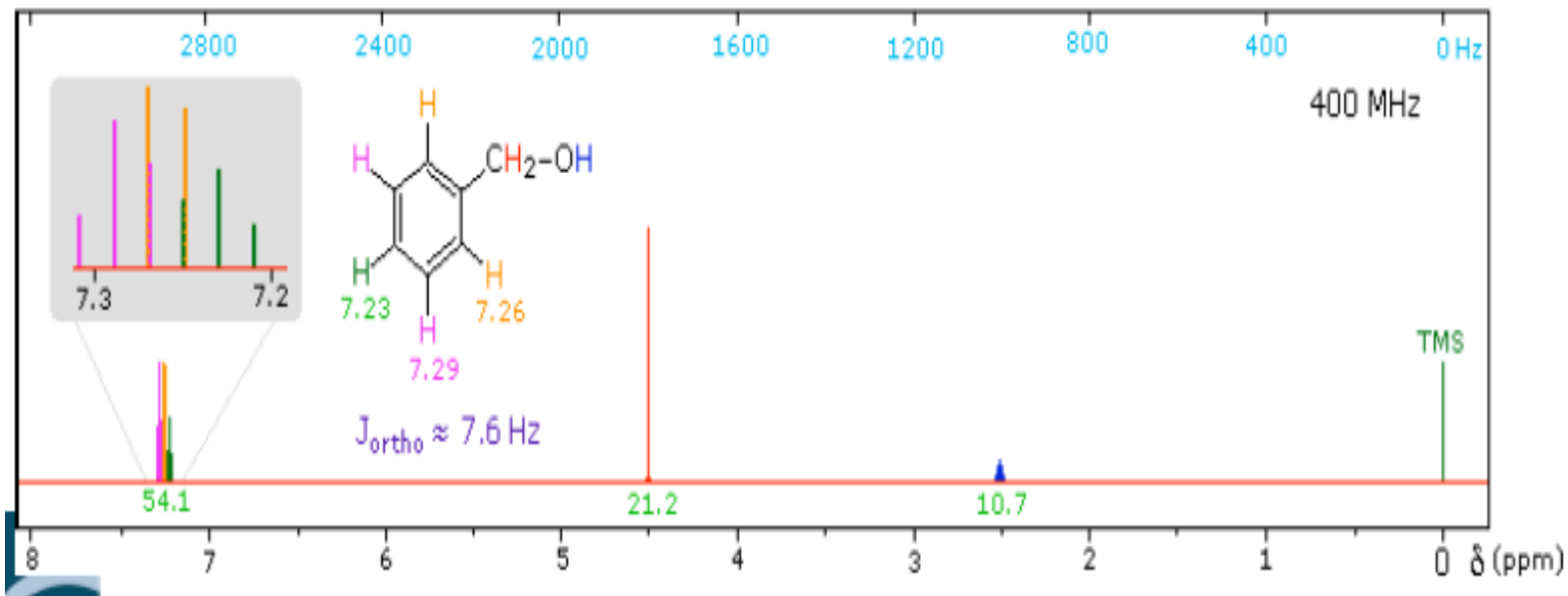
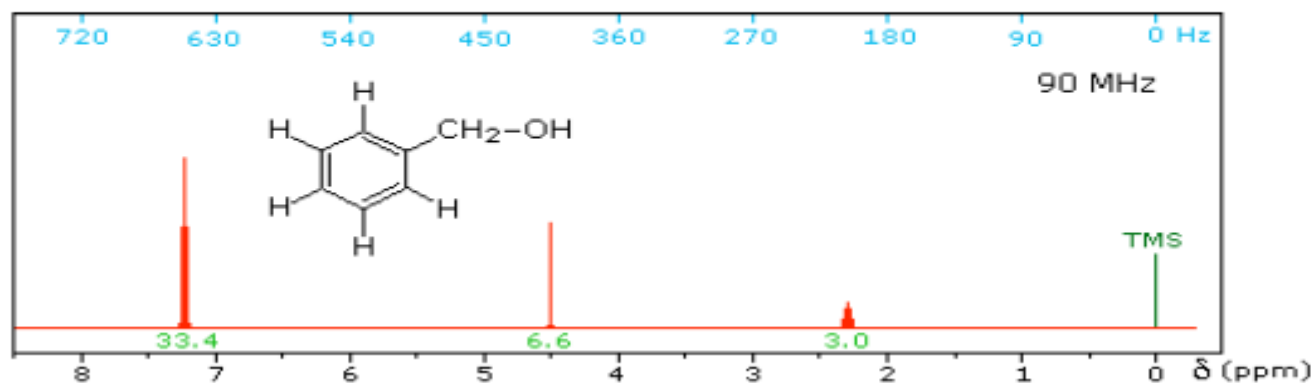

Influence of Hydrogen Bonding

- The OH proton signal is seen at 2.37 δ in 2-methyl-3-butyne-2-ol, and at 3.87 δ in 4-hydroxy-4-methyl-2-pentanone.
- A six-membered ring intramolecular hydrogen bond in the latter compound is in part responsible for its low field shift.

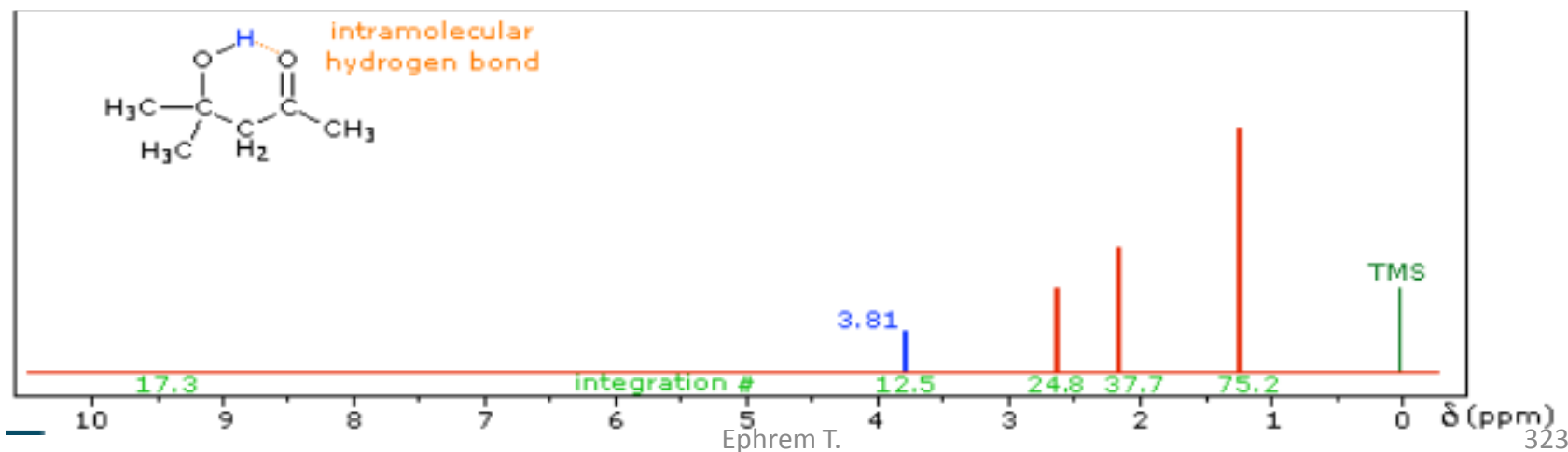
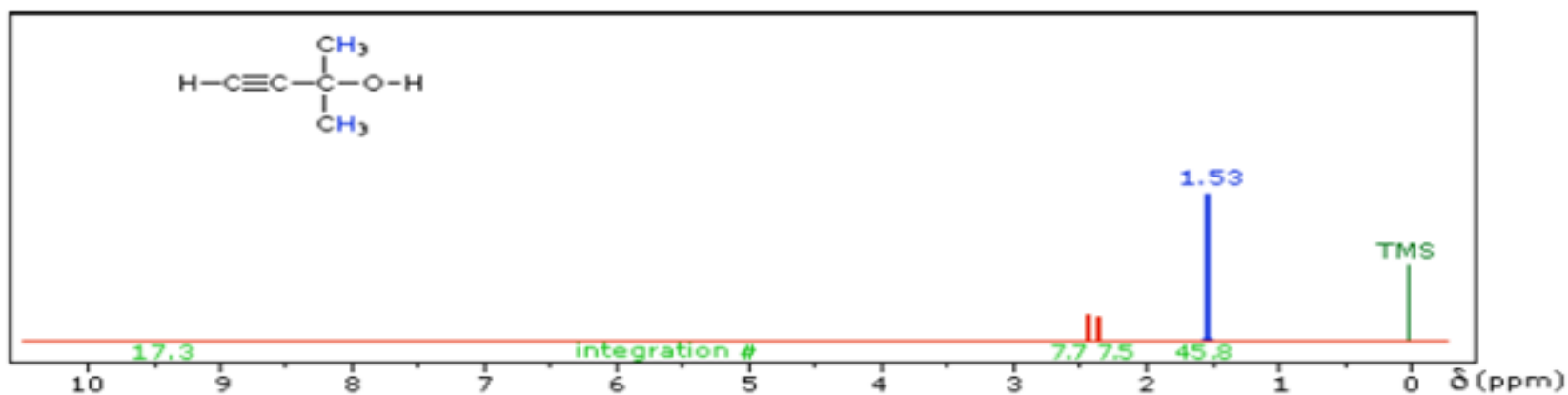

π -Electron Functions

Anomalous observations from chemical shift chart:

1. The low field resonance of hydrogens bonded to double bond or aromatic ring carbons.
2. the very low field signal from aldehyde hydrogens.
3. The hydrogen atom of a terminal alkyne, in contrast, appears at a relatively higher field.

All these anomalous cases seem to involve hydrogens bonded to pi-electron systems.

The field induced pi-electron movement produces strong secondary fields that perturb nearby nuclei.

Example:

The pi-electrons associated with a benzene ring

The electron cloud above and below the plane of the ring circulates in reaction to the external field so as to generate an opposing field at the center of the ring and a supporting field at the edge of the ring.

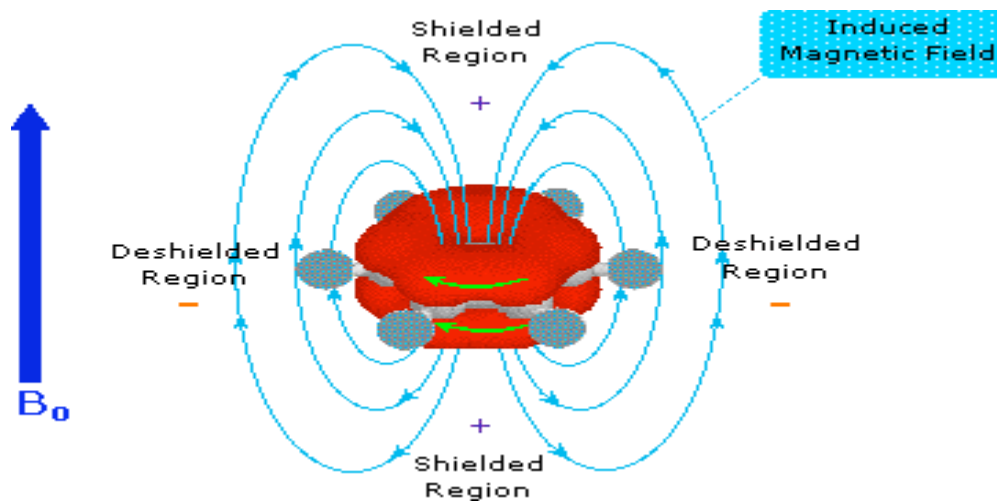

This kind of spatial variation is called **anisotropy**, and it is common to nonspherical distributions of electrons

Regions in which the induced field supports or adds to the external field are said to be **deshielded**.

- Regions in which the induced field opposes the external field are termed **shielded**.

The anisotropy of some important unsaturated functions

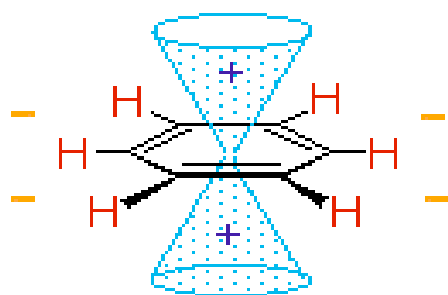

$\delta = 7-8$ ppm

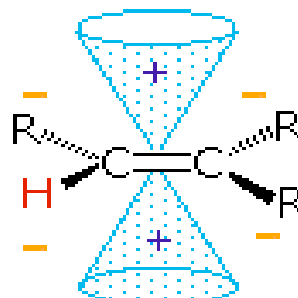

$\delta = 5-7$ ppm



$\delta = 2-3$ ppm

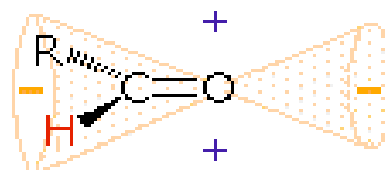

$\delta = 9-10$ ppm

Spin-Spin Interactions

Consider the dichloroethane isomers.

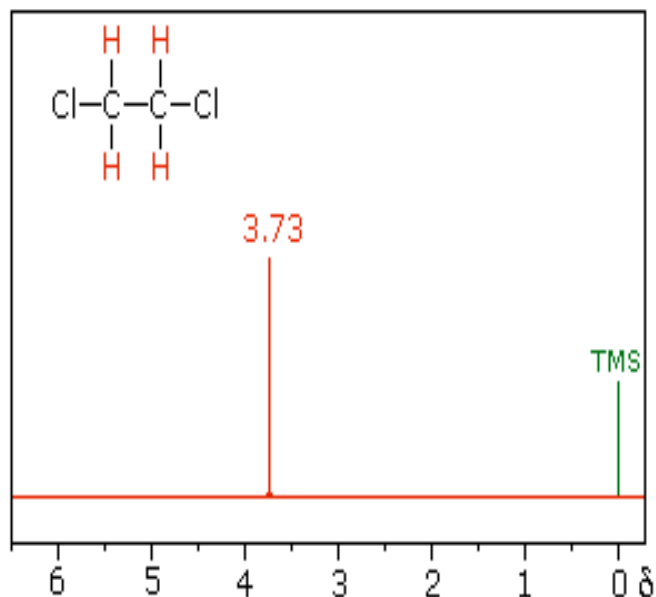

1,2-dichloroethane displays a single resonance signal from the four structurally equivalent hydrogens

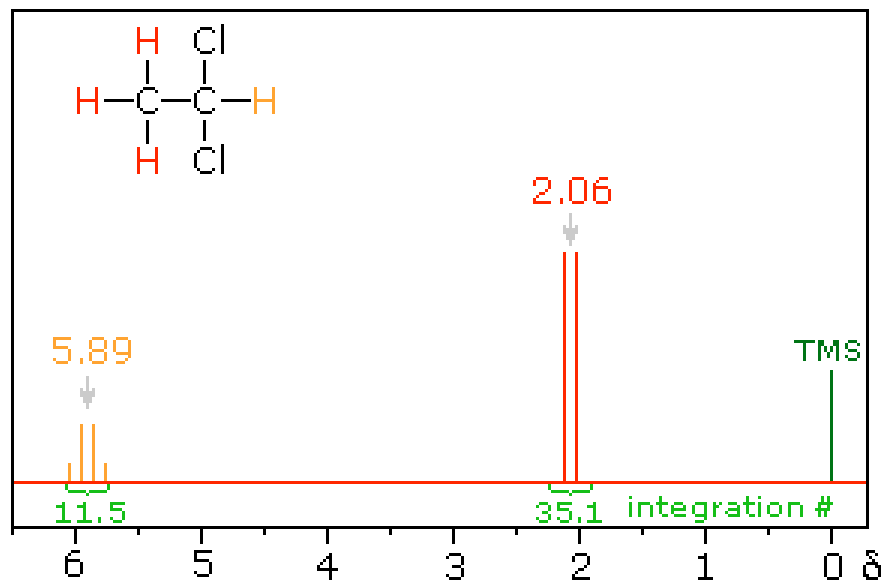

1,1-dichloroethane the two signals from the different hydrogens are split into close groupings of two or more resonances.

The signal splitting in proton spectra is usually small, ranging from fractions of a Hz to as much as 18 Hz, and is designated as **J** (referred to as the **coupling constant**).

In the 1,1-dichloroethane example all the coupling constants are 6.0 Hz.

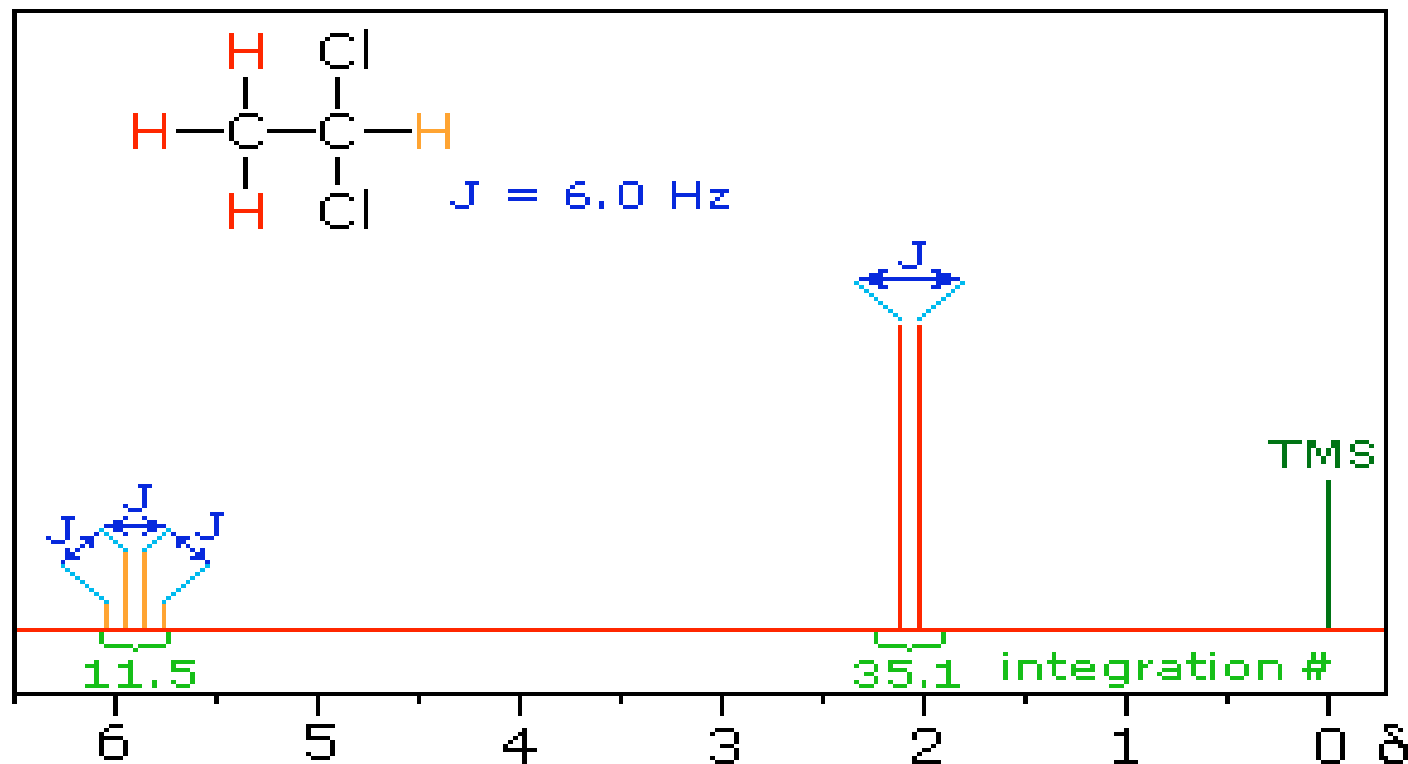

Causes of signal splitting, and useful information obtained from it.

If an atom under examination is influenced by a nearby nuclear spin (or set of spins), the observed nucleus responds to such influences.

- This spin-coupling is transmitted through the connecting bonds, and it functions in both directions.
- For spin-coupling to be observed, the sets of interacting nuclei must be bonded in relatively close proximity (e.g. vicinal and geminal locations), or be oriented in certain optimal and rigid configurations.

Some spectroscopists place a number before the symbol J to designate the number of bonds linking the coupled nuclei (colored orange below).

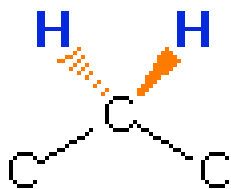

Geminal Hydrogens

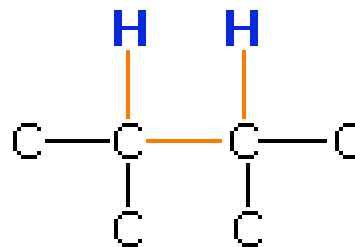

Vicinal Hydrogens

a vicinal coupling constant is 3J and a geminal constant is 2J .

General rules summarizing important requirements and characteristics for spin 1/2 nuclei :

1. Nuclei having the same chemical shift (called **isochronous**) do not exhibit spin-splitting.

2. Nuclei separated by three or fewer bonds (e.g. vicinal and geminal nuclei) will usually be spin-coupled and will show mutual spin-splitting of the resonance signals (same J's),

- provided they have different chemical shifts.
- Longer-range coupling may be observed in molecules having rigid configurations of atoms.

3. The magnitude of the observed spin-splitting depends on many factors and is given by the coupling constant **J (units of Hz)**.

- J is the same for both partners in a spin-splitting interaction and is independent of the external magnetic field strength.

4. The splitting pattern of a given nucleus (or set of equivalent nuclei) can be predicted by the **n+1 rule**.

n is the number of neighboring spin-coupled nuclei with the same (or very similar) Js.

Example

If there are 2 neighboring, spin-coupled, nuclei the observed signal is a triplet ($2+1=3$).

No Coupled
Hydrogens

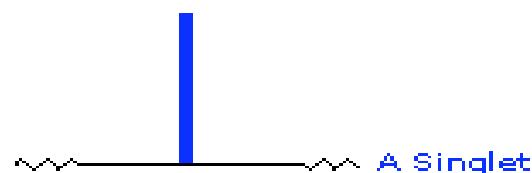
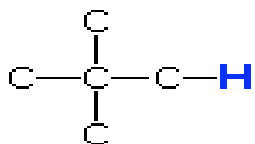

One Coupled
Hydrogen

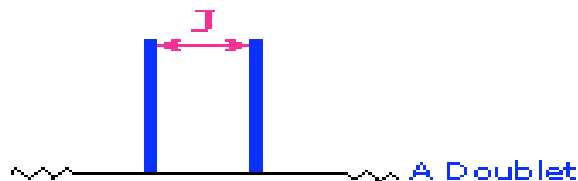
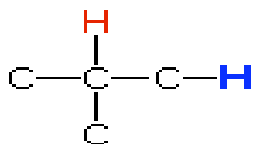

Two Coupled
Hydrogens

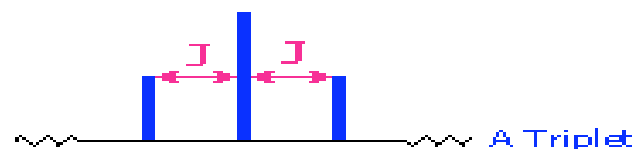
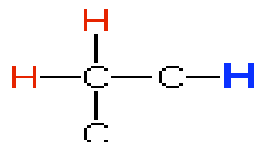

Three Coupled
Hydrogens

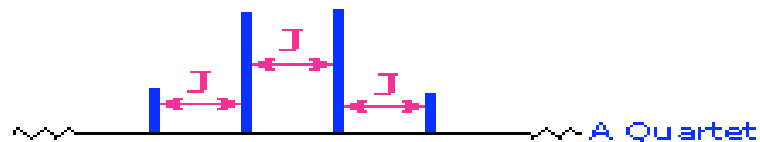
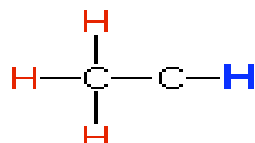

The intensity ratio of the lines is given by the numbers in Pascal's triangle.

Relative Peak Intensities of Symmetric Multiplets		
<i>Number of Equivalent Protons Causing Splitting</i>	<i>Number of Peaks (multiplicity)</i>	<i>Area Ratios (Pascal's triangle)</i>
0	1 (singlet)	1
1	2 (doublet)	1 1
2	3 (triplet)	1 2 1
3	4 (quartet)	1 3 3 1
4	5 (quintet)	1 4 6 4 1
5	6 (sextet)	1 5 10 10 5 1
6	7 (septet)	1 6 15 20 15 6 1

Thus, a doublet has 1:1 or equal intensities, a triplet has an intensity ratio of 1:2:1, a quartet 1:3:3:1, etc.

If a given nucleus is spin-coupled to two or more sets of neighboring nuclei by different J values, the splitting due to one J set is added to that expected from the other J sets.

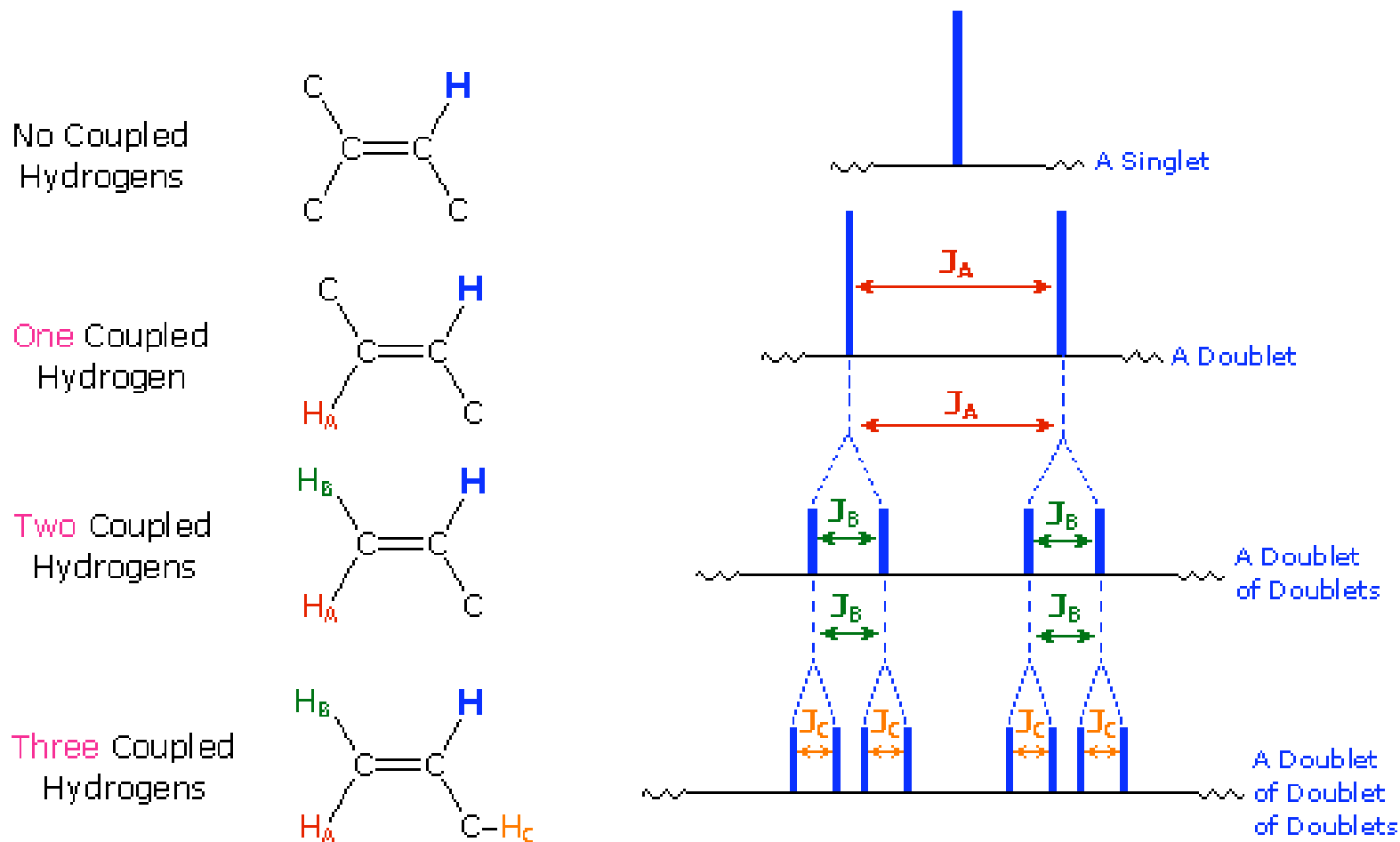

Splitting for Ethyl Groups

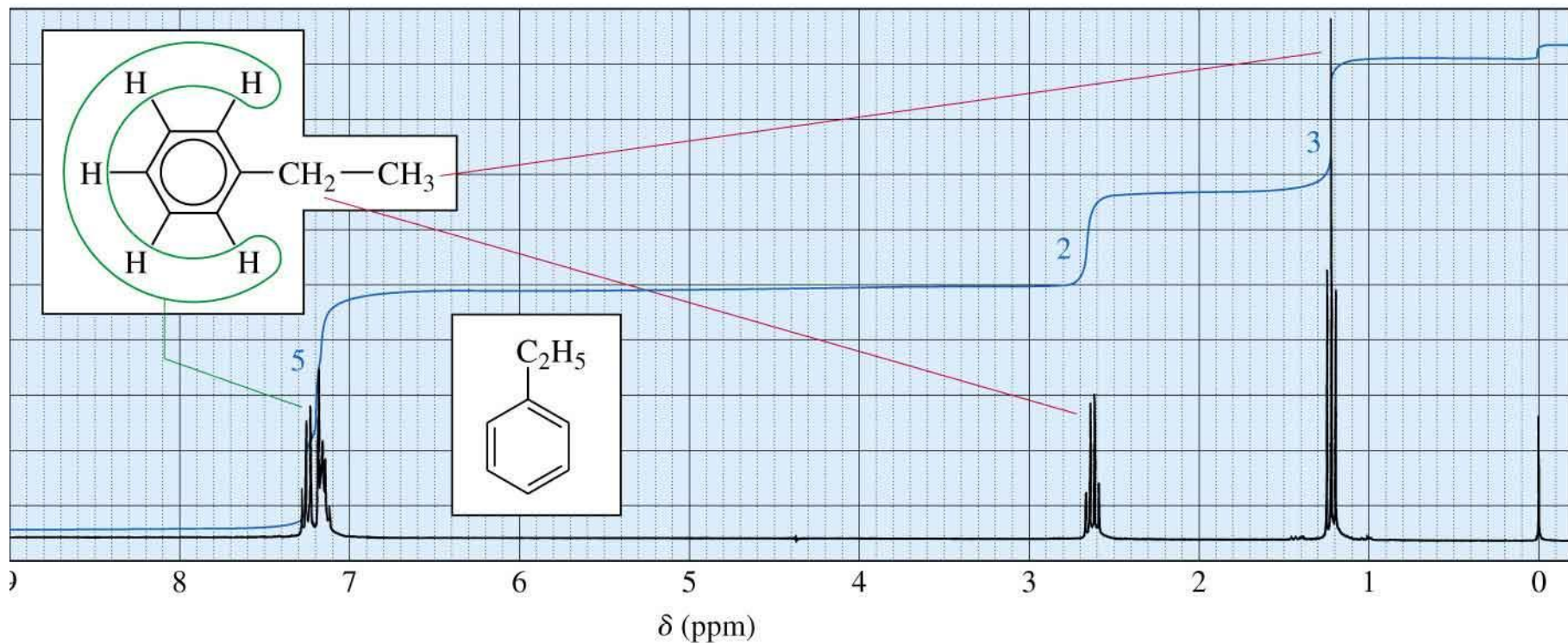

=>

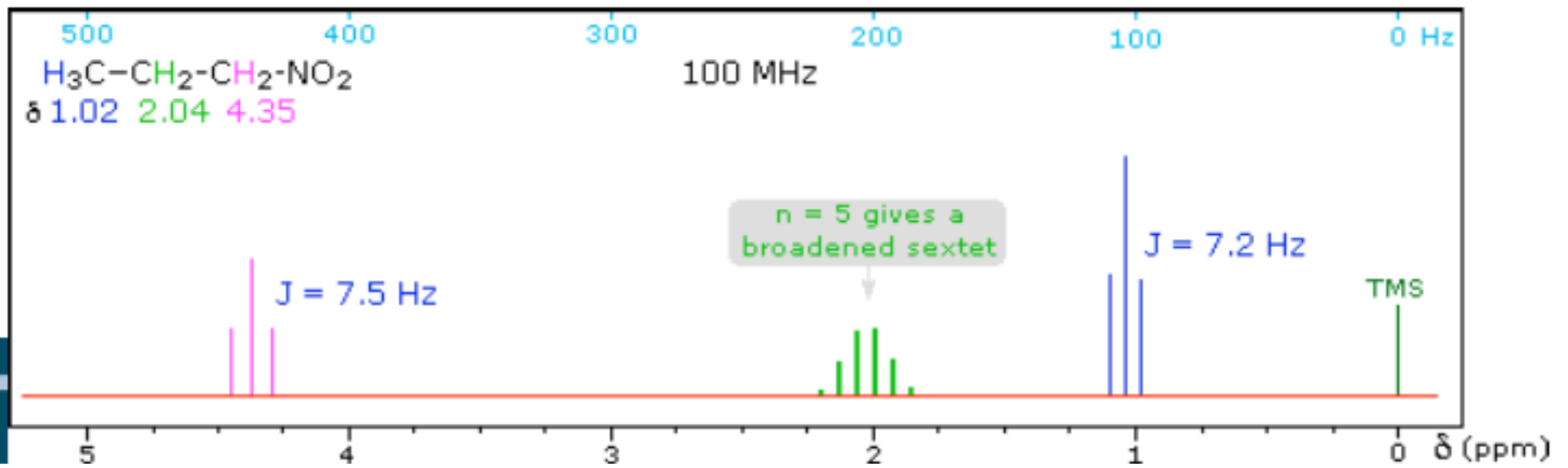
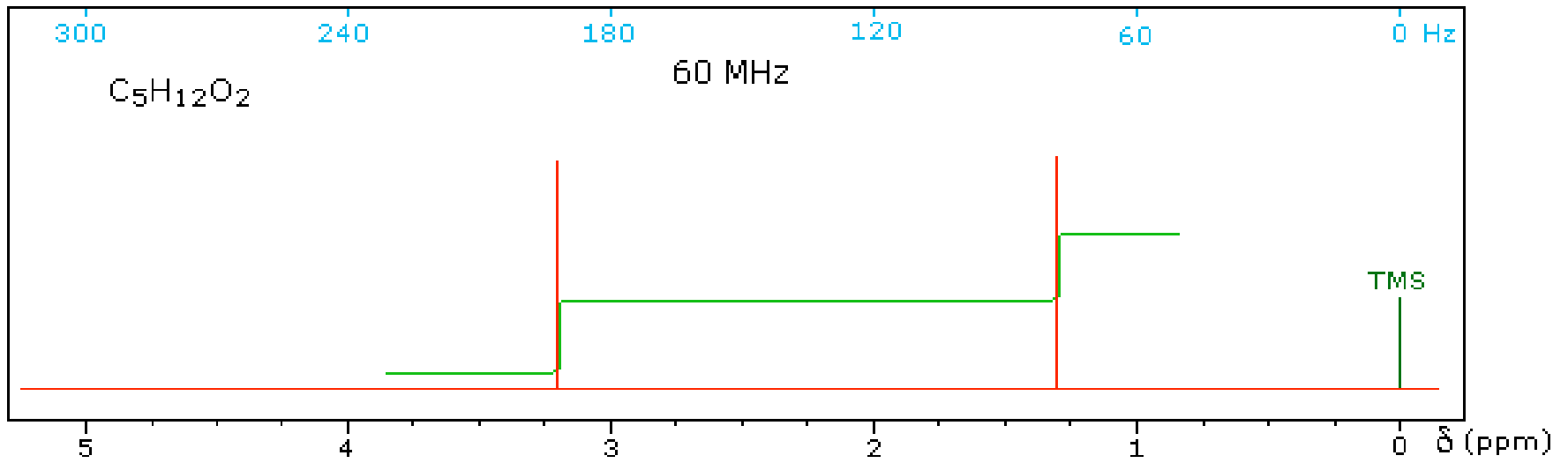

^{13}C NMR Spectroscopy

Pairs of isomers (A & B) which display similar proton NMR spectra

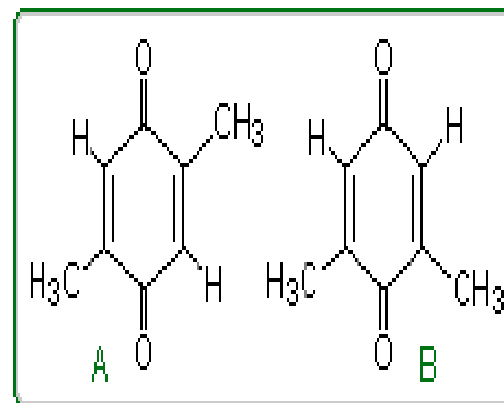
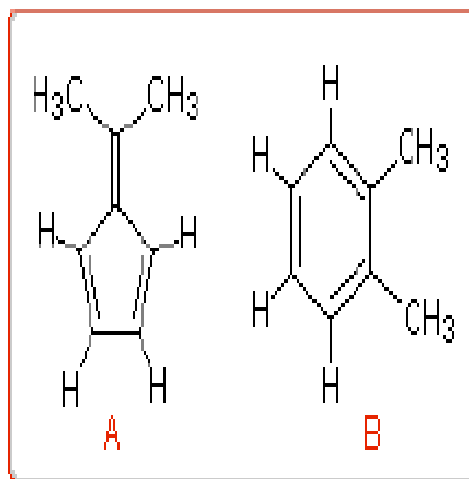
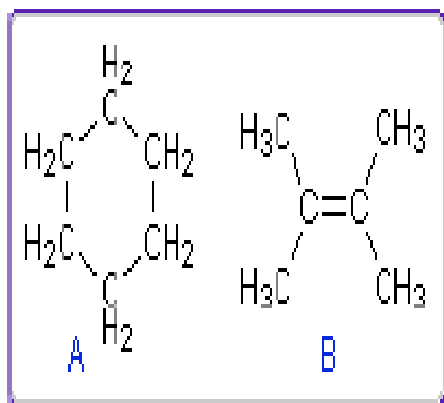

These difficulties would be largely resolved if the carbon atoms of a molecule could be probed by NMR in the same fashion as the hydrogen atoms.

Fortunately, 1.1% of elemental carbon is the ¹³C isotope, which has a spin $I = 1/2$, so in principle it should be possible to conduct a carbon NMR experiment.

It is worth noting, that if much higher abundances of ¹³C were naturally present in all carbon compounds, proton NMR would become much more complicated due to large one-bond coupling of ¹³C and ¹H.

Obstacles needed to be overcome before carbon NMR emerged as a routine tool:

- i) As noted, the abundance of ^{13}C in a sample is very low (1.1%), so higher sample concentrations are needed.
- ii) The ^{13}C nucleus is over fifty times less sensitive than a proton in the nmr experiment, adding to the previous difficulty.
- iii) Hydrogen atoms bonded to a ^{13}C atom split its NMR signal by 130 to 270 Hz, further complicating the NMR spectrum.

Solution

Use of high-field pulse technology coupled with broadband heteronuclear decoupling of all protons.

Unlike proton NMR spectroscopy, the relative strength of carbon NMR signals are not normally proportional to the number of atoms generating each one.

¹³C Chemical Shift Ranges

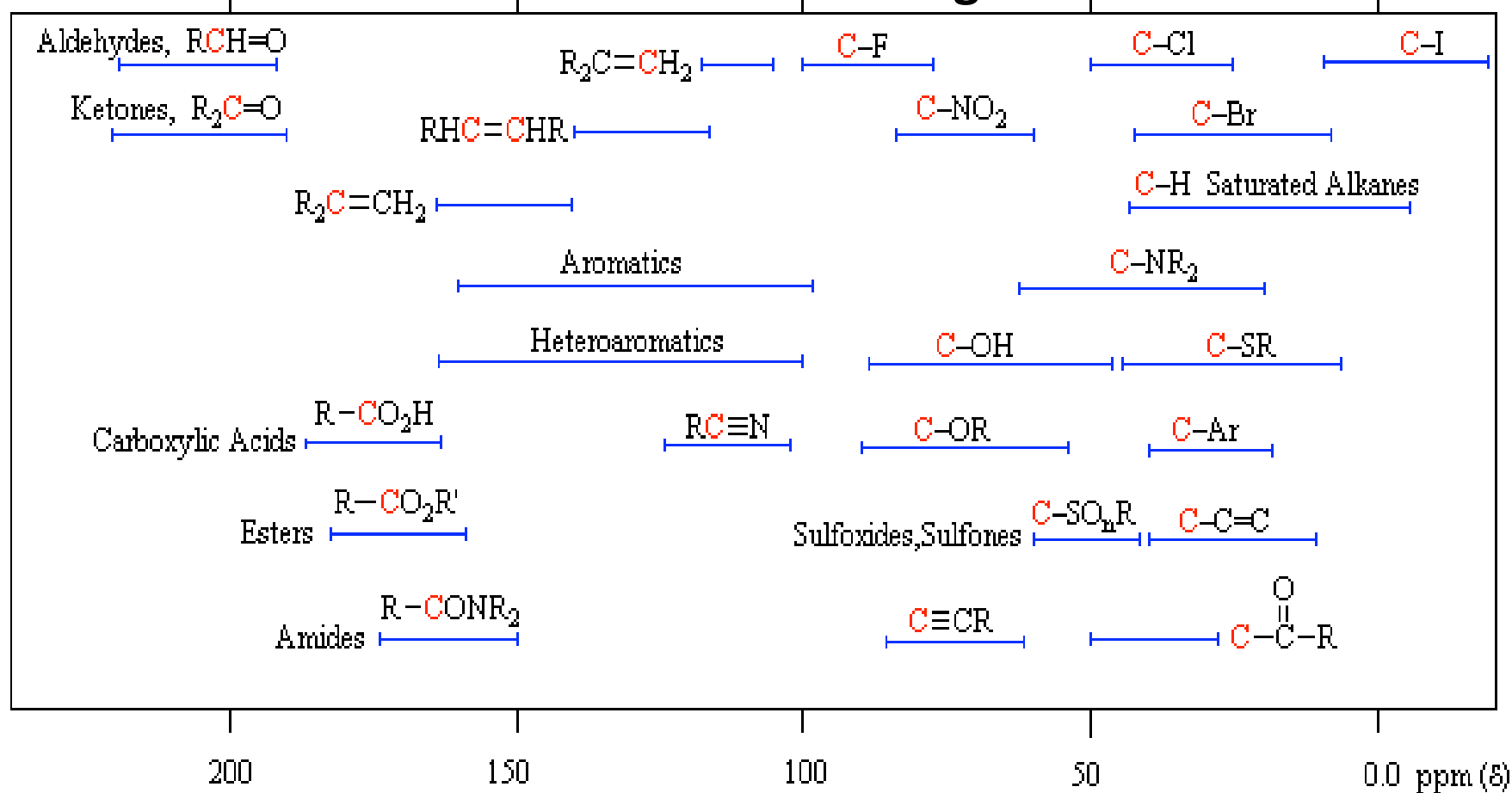

The isomeric pairs previously cited as giving very similar proton NMR spectra are now seen to be distinguished by carbon NMR.

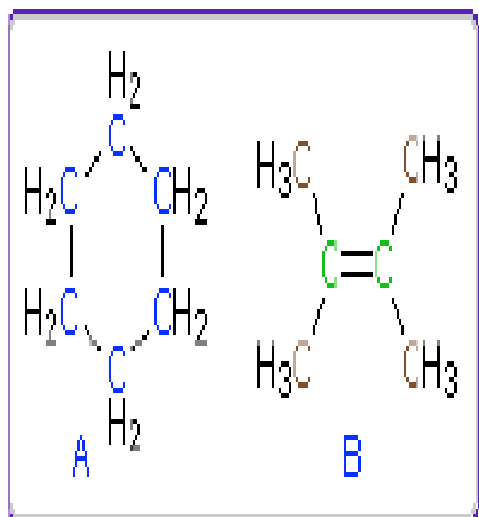

1 signal

27.1 ppm

2 signals

20.4, 123.5

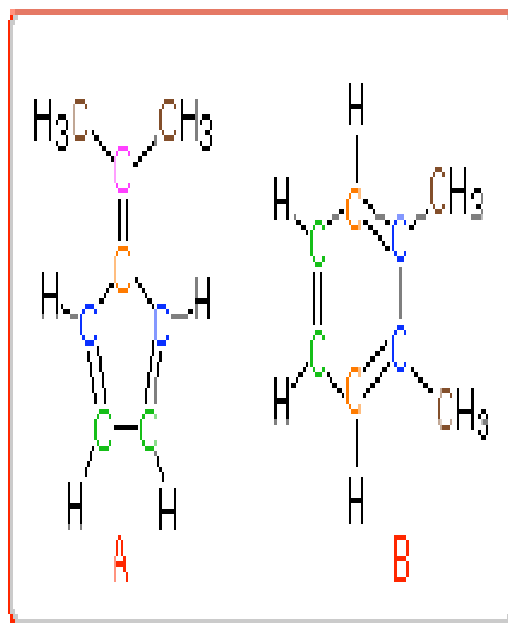

5 signals

4 signals

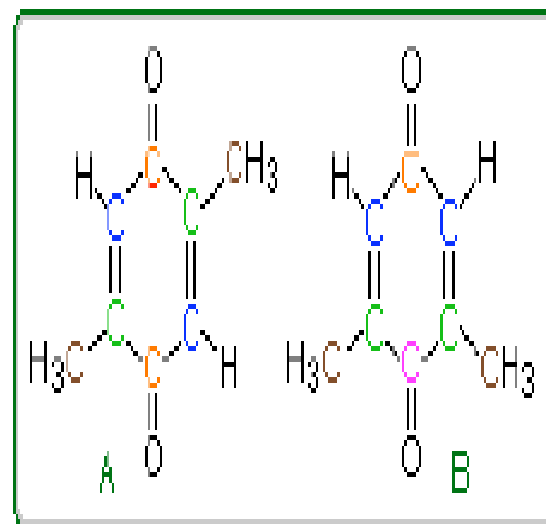

4 signals

5 signals

Structurally Equivalent Atoms & Groups

For each of the compounds **A through F** indicate the number of **structurally distinct** groups of carbon atoms, and also the number of distinct groups of equivalent hydrogens.

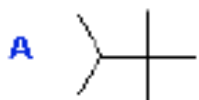

A Number of distinct carbon atoms: ...
Number of distinct hydrogen groups:

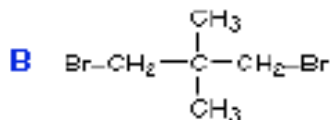
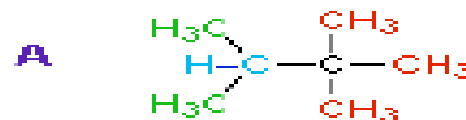

B Number of distinct carbon atoms: ... Number of distinct hydrogen groups:

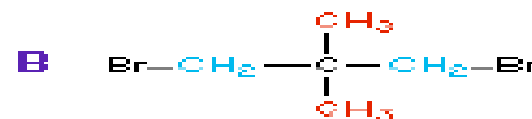

C Number of distinct carbon atoms: ...
Number of distinct hydrogen groups:

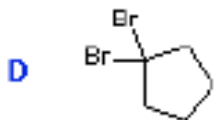
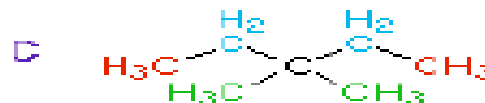

D Number of distinct carbon atoms: ...
Number of distinct hydrogen groups:

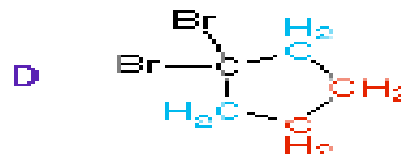

E Number of distinct carbon atoms: ...
Number of distinct hydrogen groups:

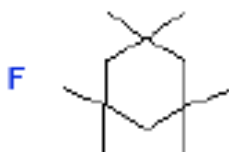

F Number of distinct carbon atoms: ...
Number of distinct hydrogen groups:

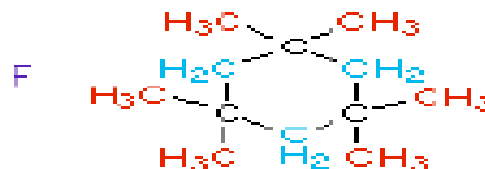

Activity 2 Structurally Equivalent Atoms & Groups

For each of the compounds **A through F** indicate the number of **structurally distinct** groups of equivalent carbons.

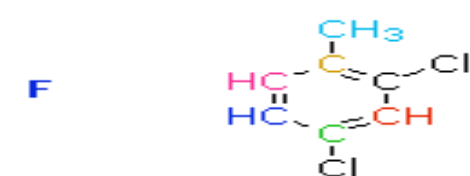
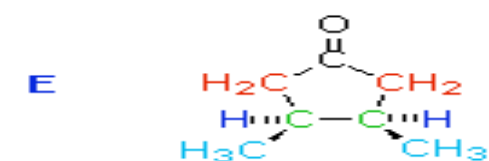
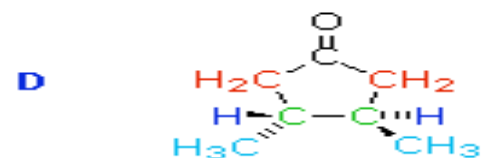
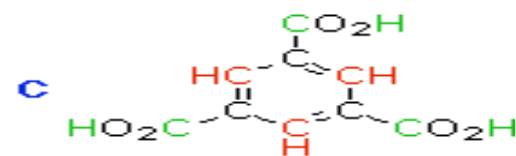
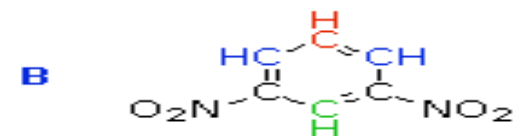
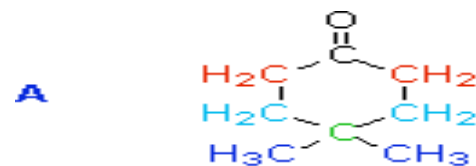
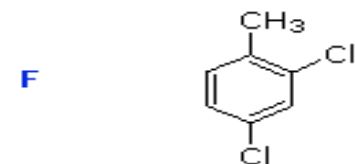
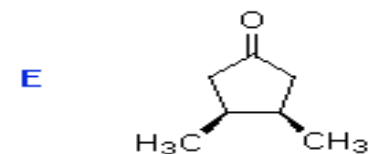
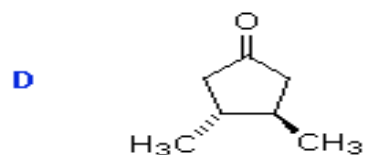
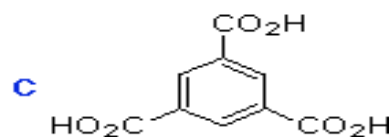
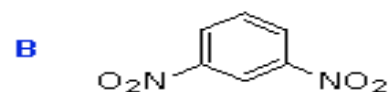
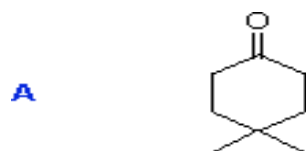

1. You have three unlabeled vials each containing a trichlorobenzene isomer. In order to correctly identify each compound and properly label its container you have taken their ^{13}C nmr spectra. Match the spectrum characteristics given below with a compound from the following group:

1,2,3-trichlorobenzene

1,2,4-trichlorobenzene

1,3,5-trichlorobenzene

^{13}C NMR:

(i) Two peaks between $\delta 125$ and 140 ppm

1,3,5-trichlorobenzene

(ii) Six peaks between $\delta 125$ and 140 ppm

1,2,4-trichlorobenzene

(iii) Four peaks between $\delta 125$ and 140 ppm

1,2,3-trichlorobenzene

Spin-Spin Splitting

- It is unlikely that a ^{13}C would be adjacent to another ^{13}C , so splitting by carbon is negligible.
- ^{13}C will magnetically couple with attached protons and adjacent protons.
- These complex splitting patterns are difficult to interpret.

Proton Spin Decoupling

- To simplify the spectrum, protons are continuously irradiated with “noise,” so they are rapidly flipping.
- The carbon nuclei see an average of all the possible proton spin states.
- Thus, each different kind of carbon gives a single, unsplit peak.

Off-Resonance Decoupling

- ^{13}C nuclei are split only by the protons attached directly to them.
- The $N + 1$ rule applies: a carbon with N number of protons gives a signal with $N + 1$ peaks.

Interpreting ^{13}C NMR

- The number of different signals indicates the number of different kinds of carbon.
- The location (chemical shift) indicates the type of functional group.
- The peak area indicates the numbers of carbons (if integrated).
- The splitting pattern of off-resonance decoupled spectrum indicates the number of protons attached to the carbon. =>

Two ^{13}C NMR Spectra

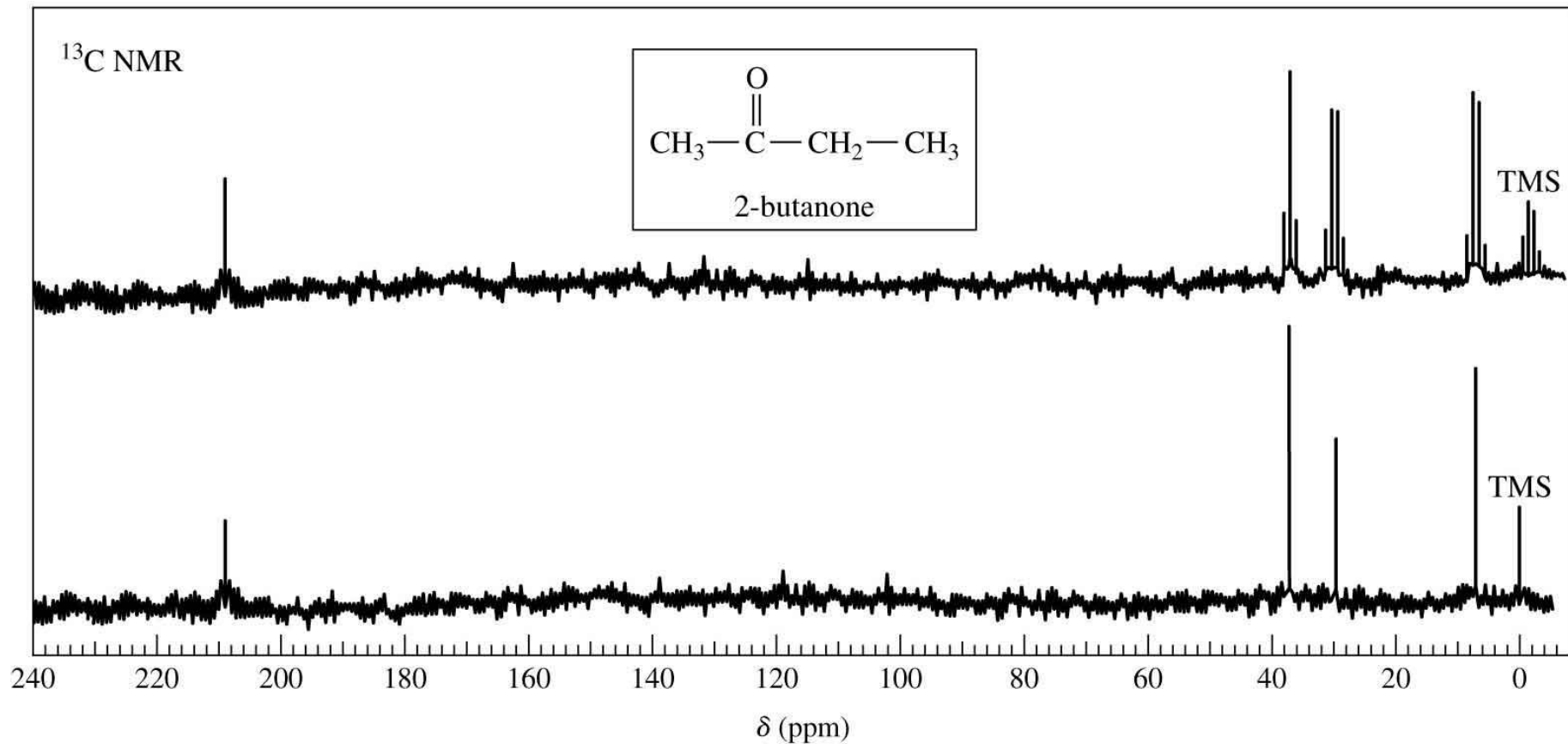

=>

Using DEPT to Count the Hydrogens Attached to ^{13}C (Distortionless Enhancement of Polarization Transfer)

In DEPT, a second transmitter irradiates ^1H during the sequence, which affects the appearance of the ^{13}C spectrum.

some ^{13}C signals stay the same

some ^{13}C signals disappear

some ^{13}C signals are inverted

Figure #3

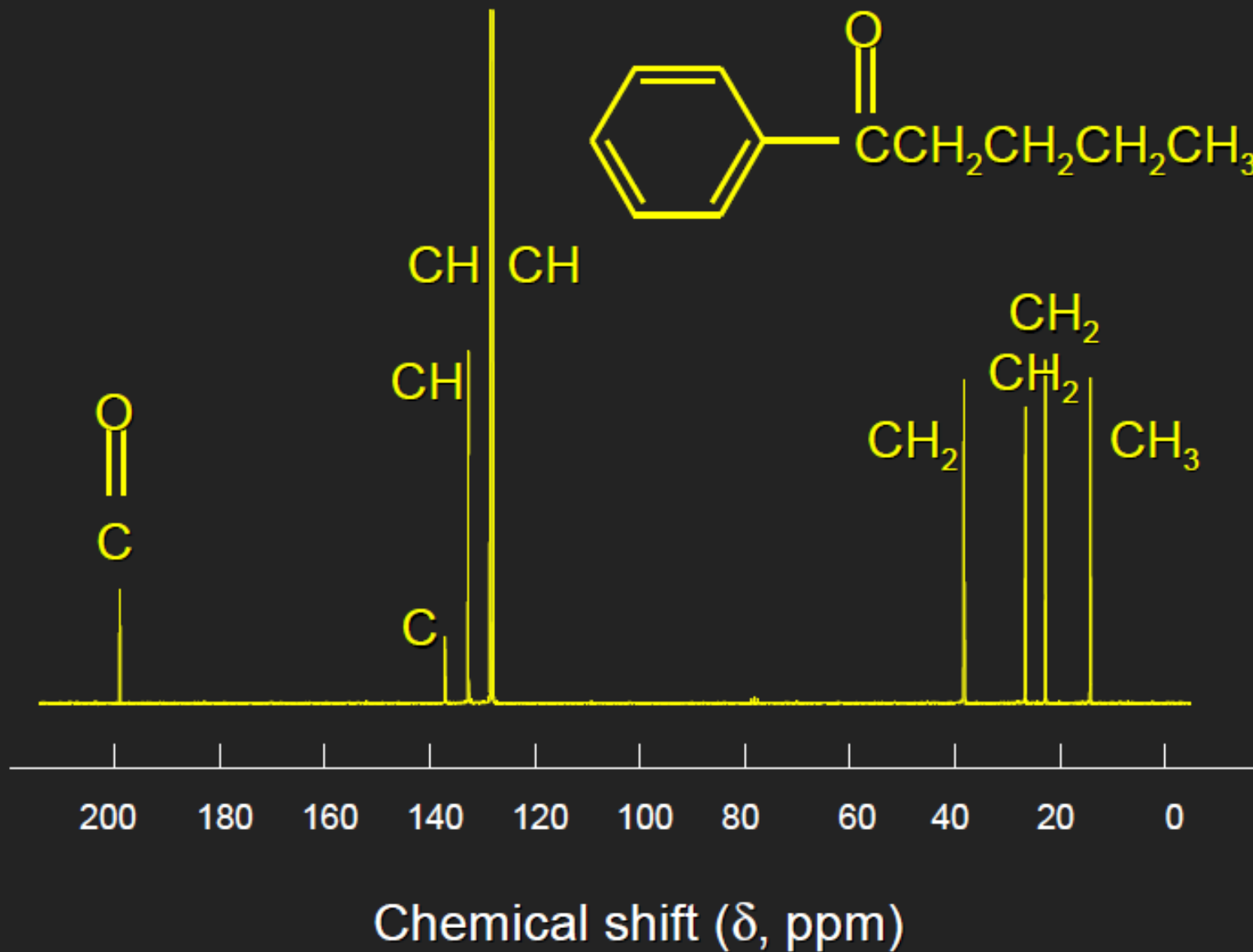
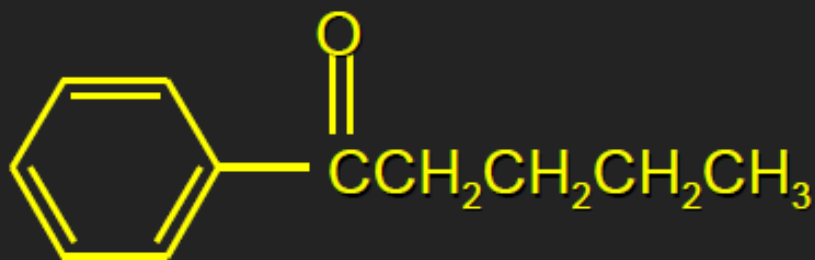

Figure #5



CH and CH₃
unaffected

C and C=O nulled

CH₂ inverted

CH₂

CH₂

CH₂

200 180 160 140 120 100 80 60 40 20 0

Chemical shift (δ , ppm)

MRI

- Magnetic resonance imaging,
- “Nuclear” is omitted because of public’s fear that it would be radioactive.
- Only protons in one plane can be in resonance at one time.
- Computer puts together “slices” to get 3D.
- Tumors readily detected.

Spin-Spin Splitting in ^1H NMR

What splitting pattern in the ^1H nmr spectrum would you expect for the hydrogen atom(s) colored red in the compounds shown below?

Your choices are: **s** singlet **d** doublet **t** triplet **q** quartet
m multiplet

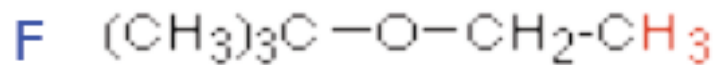
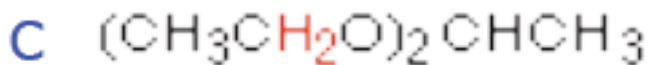
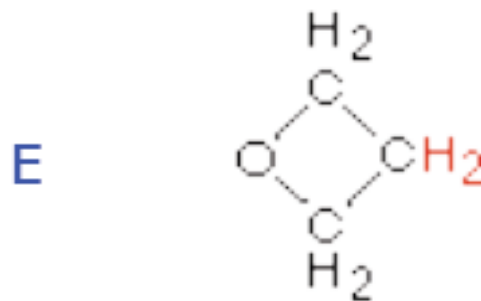
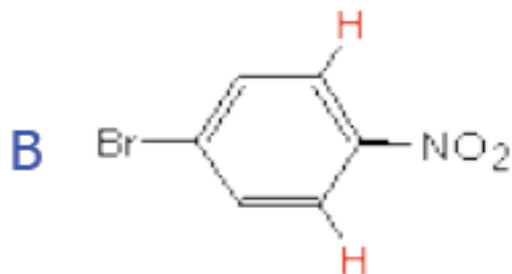
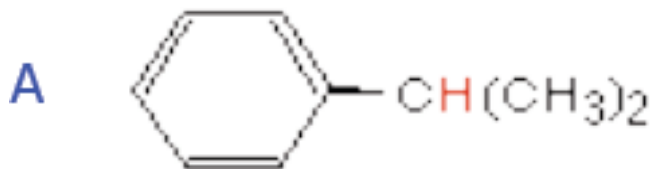

Mass Spectroscopy

CHAPTER 8

Point of Mass Spectroscopy

- Determine a **molecular mass** for a sample.
- Use the molecular mass to determine possible **molecular formulas**
- Determine **pieces** of the molecule from the fragmentation pattern.
- Use this information to make a guess about the structure or **identity** of the molecule.
- NOTE: This information alone is not enough to fully characterize a molecule. Other spectral data would be necessary.

How Mass Spec Works

- A sample is injected into a GC/MS.
- Components are separated through GC.
- Each item goes through a mass spectrometer
- A mass spectrum for each compound is detected and recorded

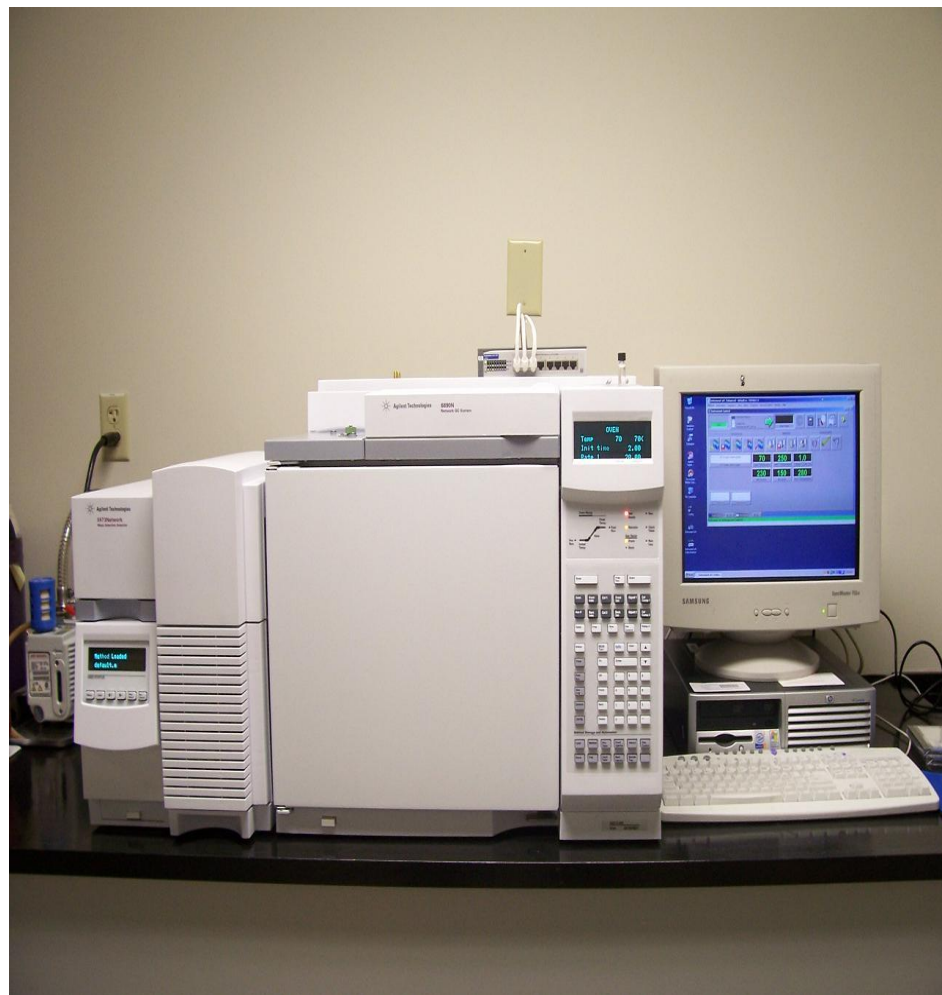

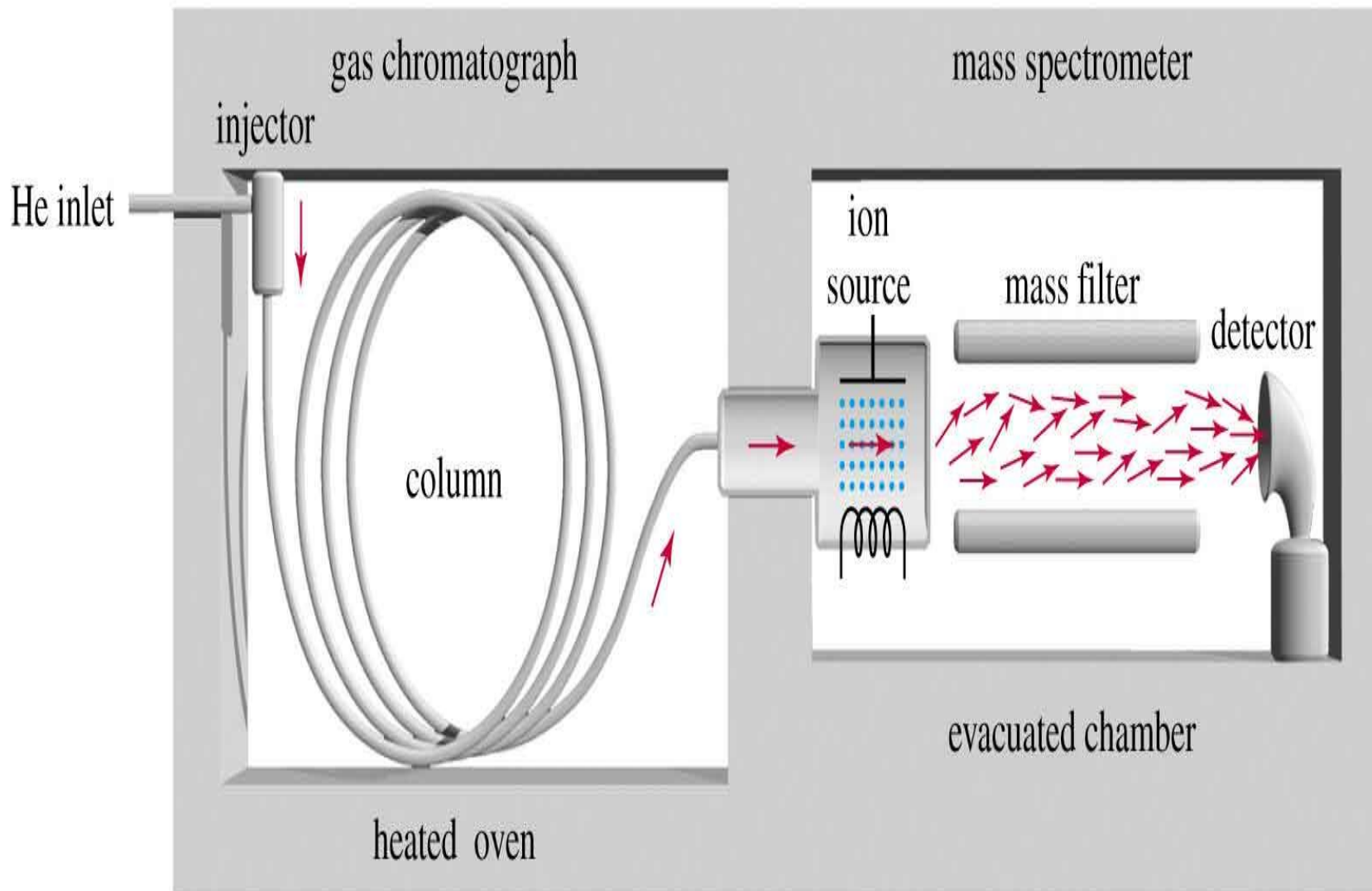

The guts of it

- Already in the gas phase molecules are bombarded by high energy electrons.
- Knock an electron out of the molecule → generates the Molecular ion (M^+)
- M^+ fragments
- All charged species are accelerated through a magnetic field based on their mass-to-charge ratio (m/z)

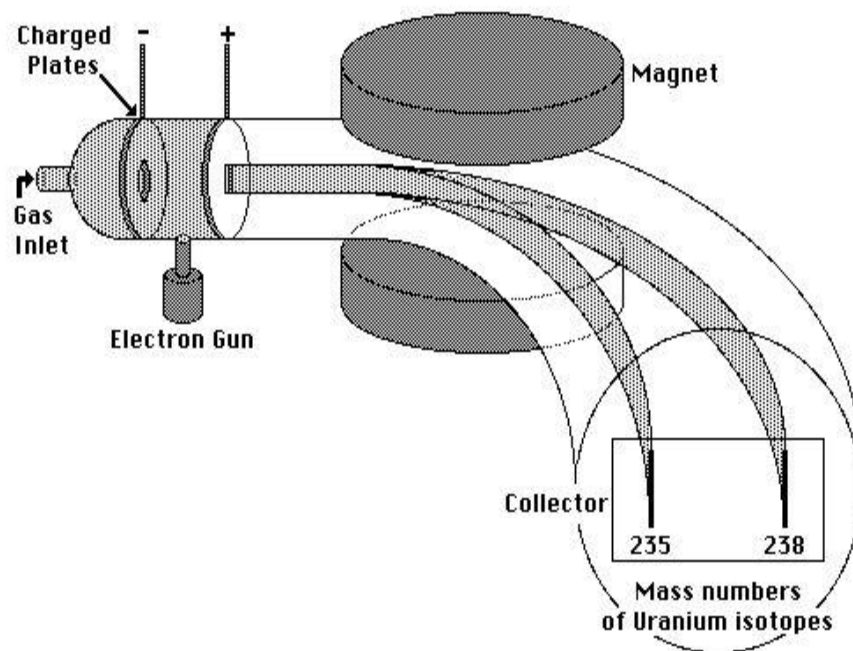

What comes out?

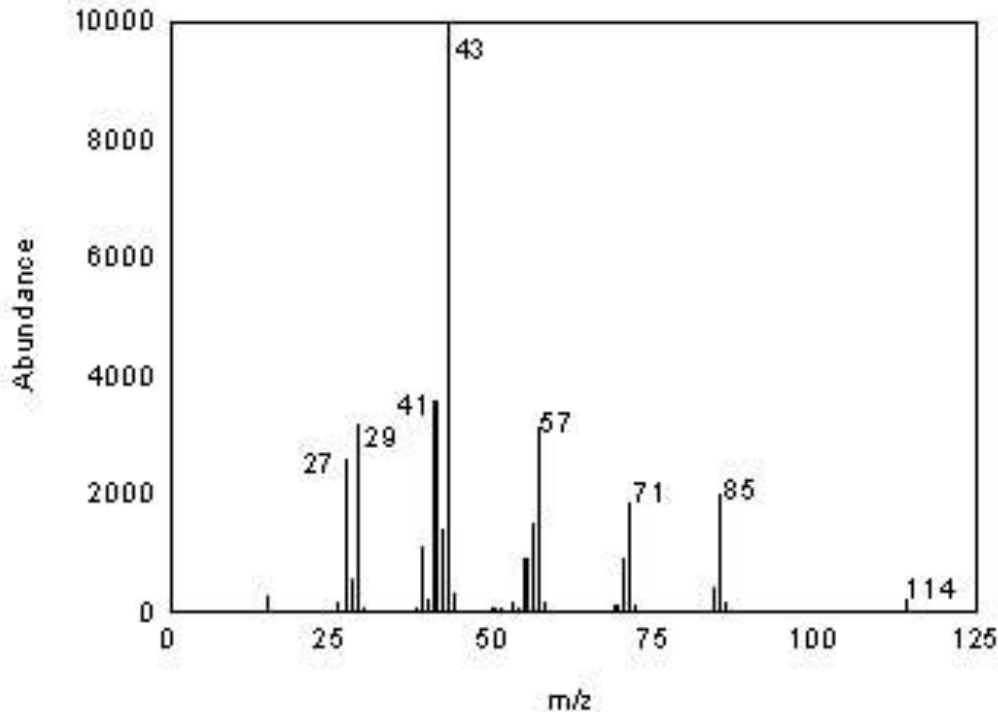

- A plot of m/z versus relative abundance
- The tallest peak is the **base peak** and everything else is relative to that
- The highest numbered peak is *probably* the **molecular ion**
- All other peaks are fragments

Still not sure what that graphy thing is?

- Only charged species are deflected through the magnetic field to the detector
- Multiple masses are shown
- These masses are indicative of how the molecular ion split up
- Figuring out the pieces is like doing a puzzle
- A puzzle for nerds

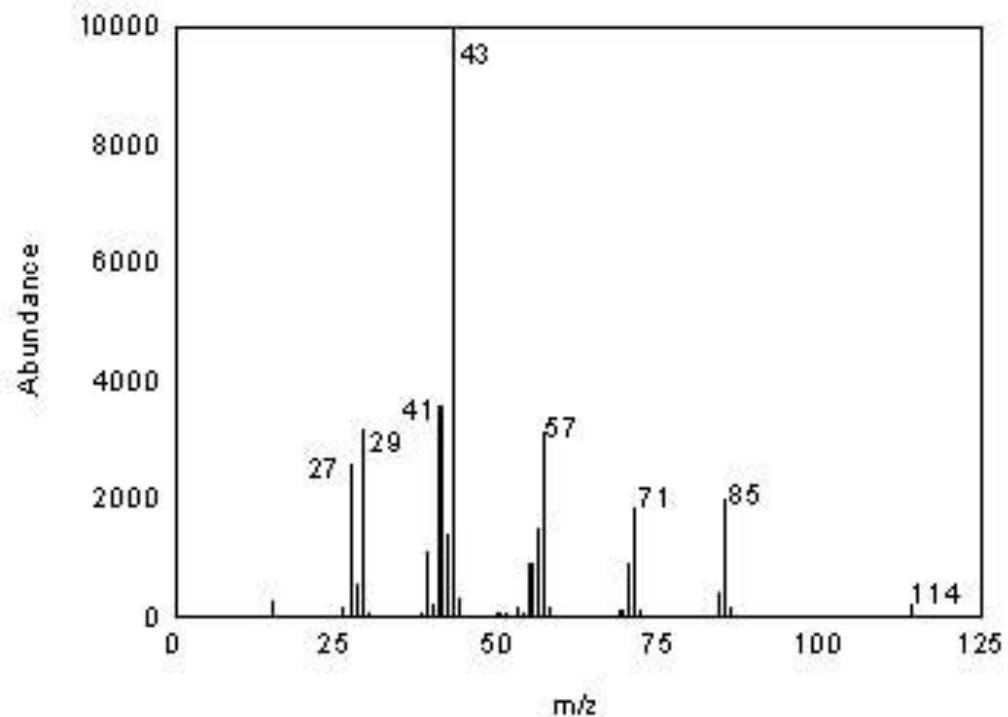

The Mass Spectrum

Example: methane $\text{CH}_4 + e^- \rightarrow \text{CH}_4^+ + 2e^-$

$m/z = (1 \times 12) + (4 \times 1) = 16$

C H

Base peak: most abundant ion

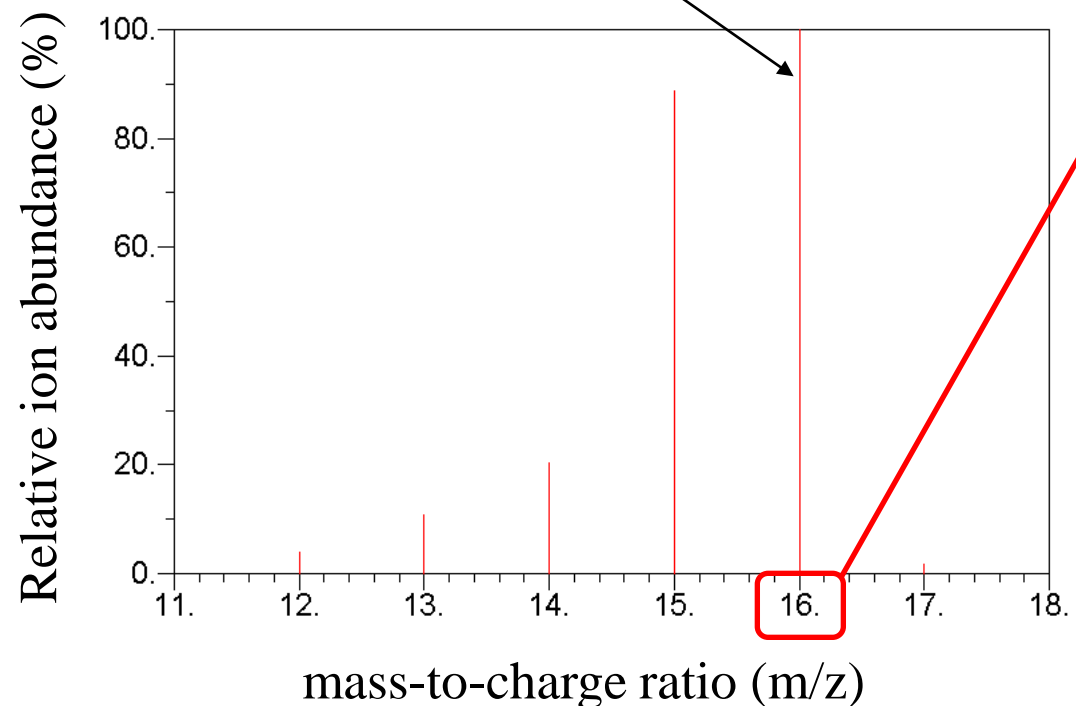

The Mass Spectrum

Alternate data presentation...

m/z (amu) Relative abundance (%)

18	< 0.5	M+2	$^{14}\text{C}^1\text{H}_4$ or $^{12}\text{C}^3\text{H}^1\text{H}_3$ or...
17	1.1	M+1	$^{13}\text{C}^1\text{H}_4$ or $^{12}\text{C}^2\text{H}^1\text{H}_3$
16	100.0	M	$^{12}\text{C}^1\text{H}_4$
15	85.0	M - H	
14	9.2	M - 2H	
13	3.0	M - 3H	
12	1.0	M - 4H	

Molecular ion (M): intact ion of substance being analyzed

Fragment ion: formed by cleavage of one or more bonds on molecular ions

Lets Go!

Base peak = 43

- This is a hydrocarbon
- It has an even number for its mass
- Assume that there are carbon atoms
- Carbon has a mass of 12
- Hydrogen has a mass of 1

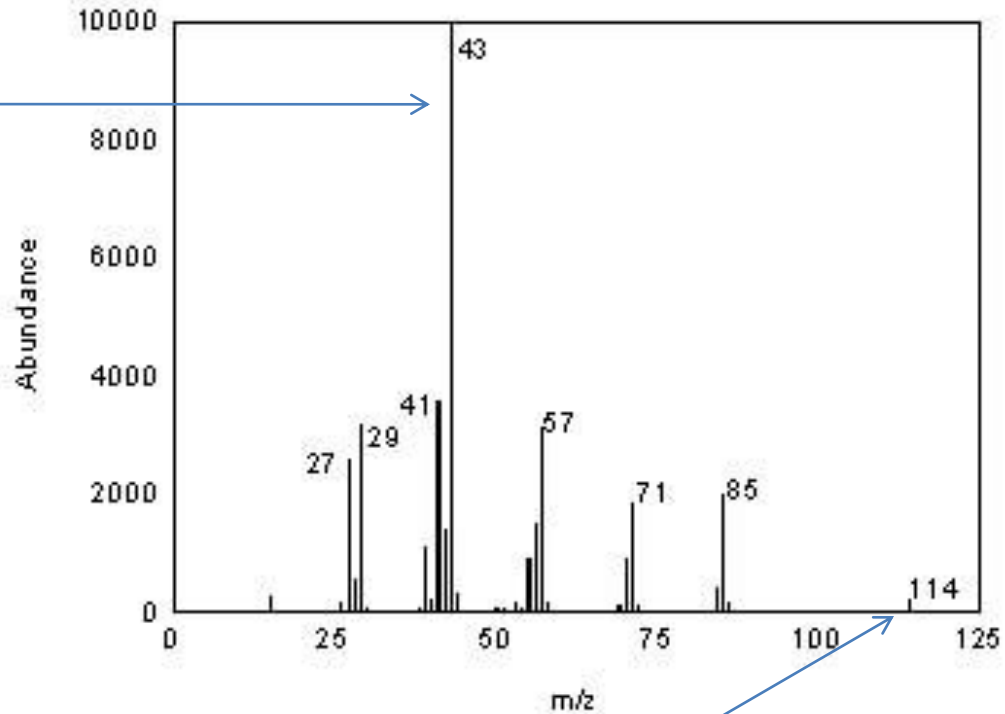

Molecular ion peak = 114

Math it up

- Assume there is nothing but Carbon and Hydrogen in it
- Divide $114/12 = 9$
- There are up to 9 carbon atoms in the molecule
- 9 carbon atoms has a mass of 108
- $114 - 108 = 6$
- There could be 9 carbons and 6 hydrogens (C_9H_6)
- *Not very likely*
- If there were 8 carbons then
 - $114 - 96 = 18$
 - C_8H_{18}
- Probable

Look for evidence

Fragmentation

- C_8H_{18} is octane. This would contain CH_3 and CH_2 groups.
 - $CH_3 = 15$
 - $CH_3CH_2 = 15+14=29$
 - $CH_3CH_2CH_2 = 15+14+14=43$
- Do you see evidence of these peaks?
- Commonly look for m/z – base peak = ?

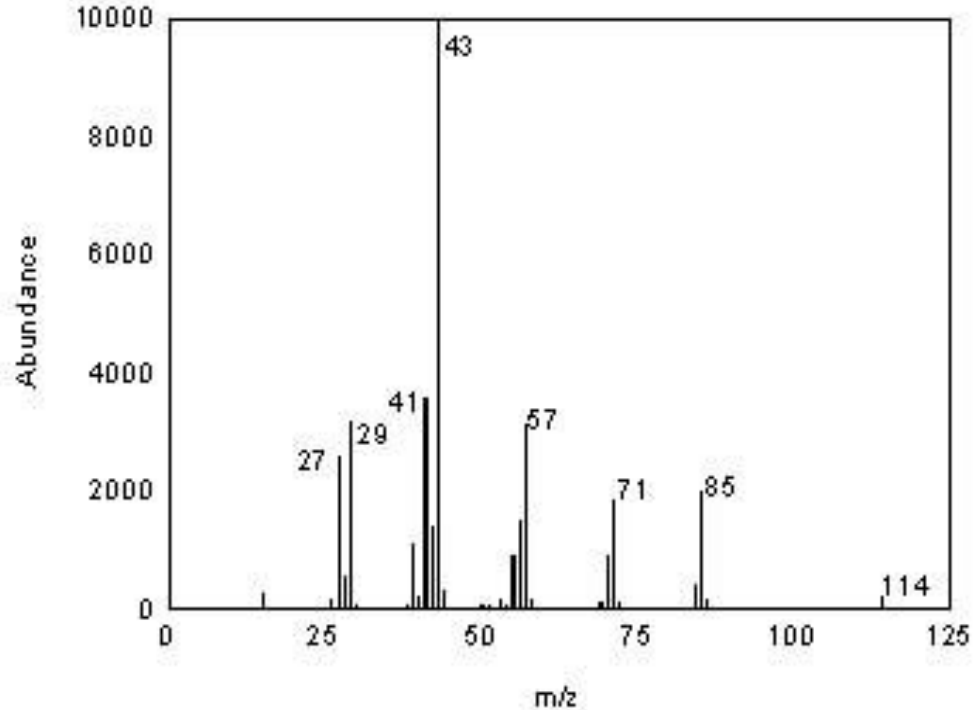

Tips for doing this

- Know atomic and molecular masses
 - Carbon = 12
 - Hydrogen = 1
 - Nitrogen = 14, etc.
- Look at the molecular ion peak.
 - Odd # = odd number of Nitrogen atoms (1, 3, etc.)
 - Even # = zero or even number of Nitrogen atoms (0, 2, 4, etc.)
- Look at the difference between molecular ion and base peak or other prominent peaks
- Subtract out non-carbon atom masses and divide remainder by 12
 - The integer refers to the maximum number of C's
 - Remember that 12 H's have the mass of 1 C

Isotopes

- Roughly 1% of the C in the world is ^{13}C .
- About 1/3 (~37%) of **Chlorine** is ^{37}Cl . The rest is ^{35}Cl .
 - Makes **M+2** peaks in a **3:1** ratio.
- About 50% of **Bromine** is ^{79}Br . The rest is ^{81}Br .
 - Makes **M+2** peaks in a **1:1** ratio.
- Look for M and M+2 peaks and try to determine if these halogens have been (fragmentation) or are present.

Isotopic Abundance

TABLE 12-4 Isotopic Composition of Some Common Elements

<i>Element</i>	M^+		$M+1$		$M+2$	
hydrogen	^1H	100.0%				
carbon	^{12}C	98.9%	^{13}C	1.1%		
nitrogen	^{14}N	99.6%	^{15}N	0.4%		
oxygen	^{16}O	99.8%			^{18}O	0.2%
sulfur	^{32}S	95.0%	^{33}S	0.8%	^{34}S	4.2%
chlorine	^{35}Cl	75.5%			^{37}Cl	24.5%
bromine	^{79}Br	50.5%			^{81}Br	49.5%
iodine	^{127}I	100.0%				

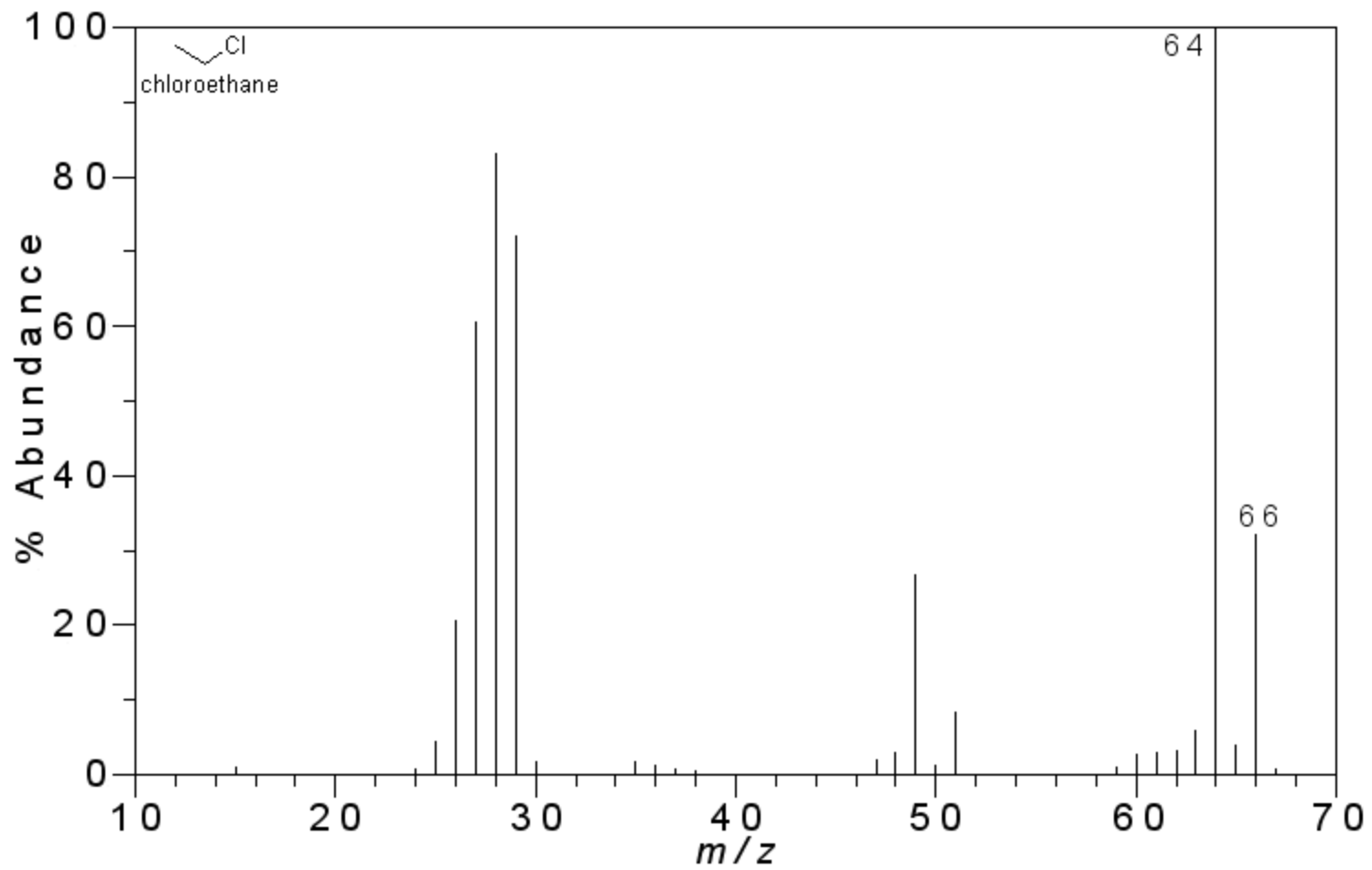

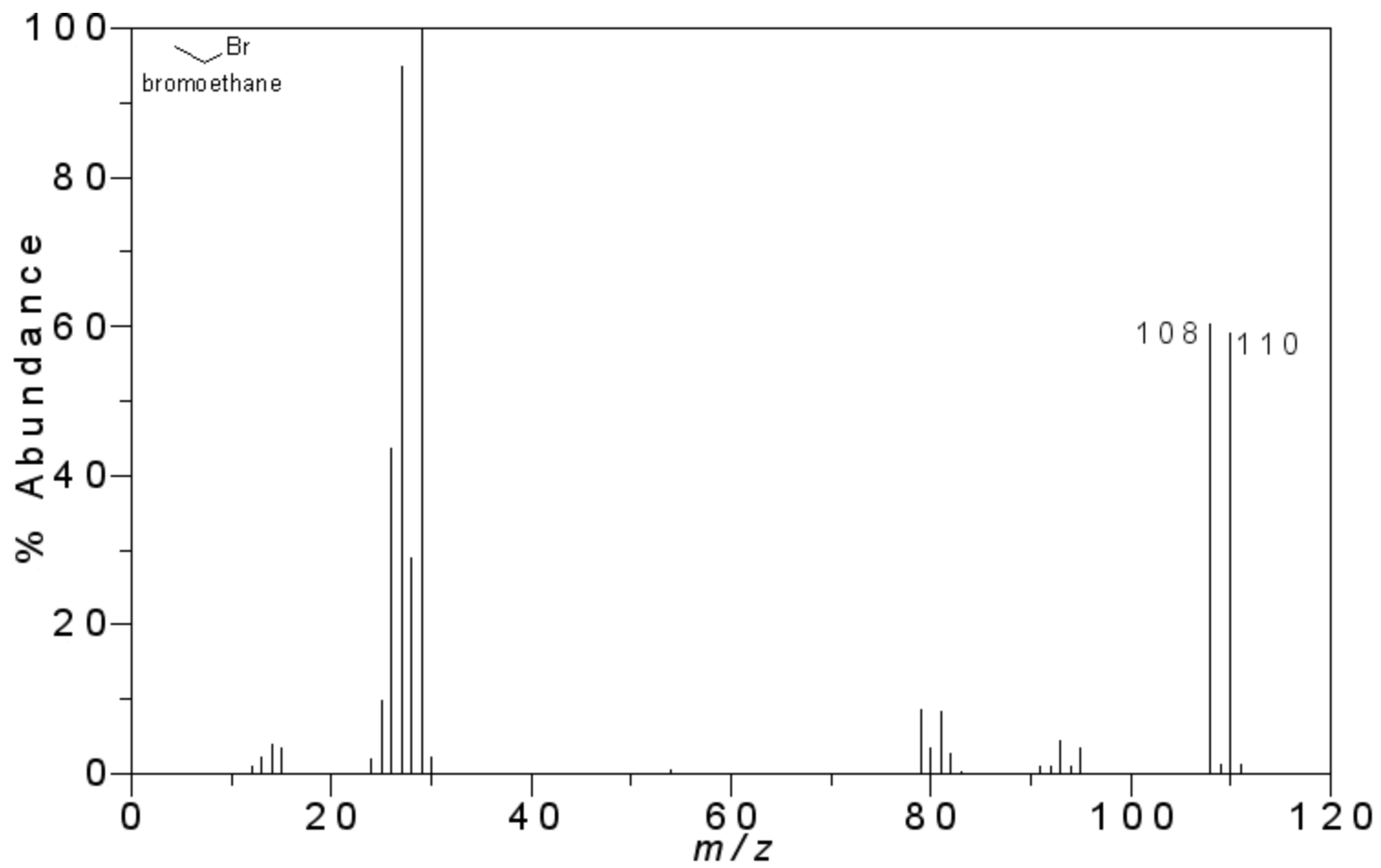

Mass Spectrum → Formula → Structure

How do we derive structure from the mass spectrum?

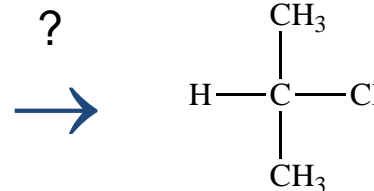
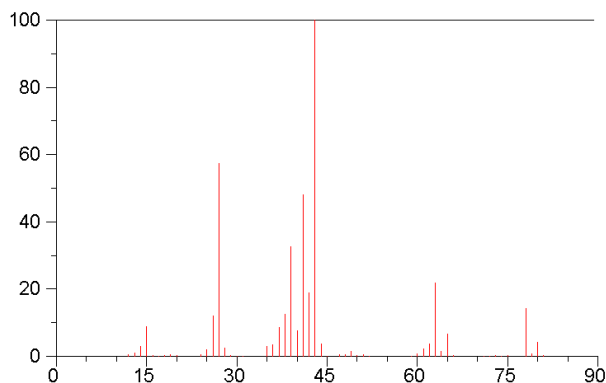

- Not trivial to do this directly
- Structure comes from formula; formula comes from mass spectrum

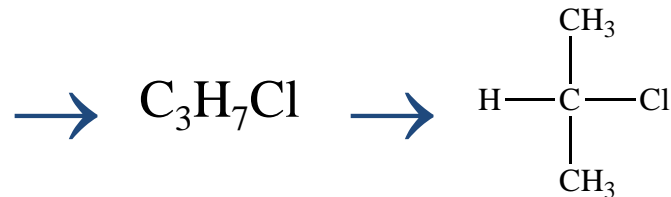
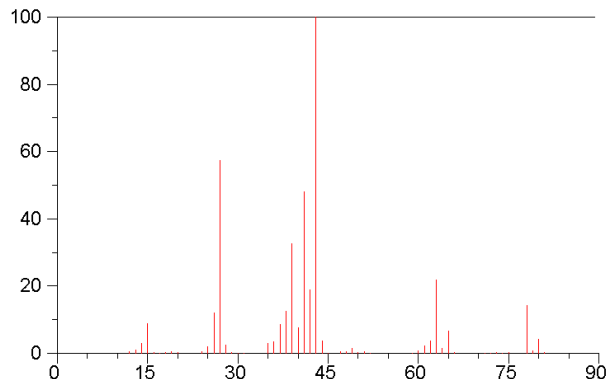

Mass Spectrum → Formula → Structure

How do we derive formula from the mass spectrum?

- m/z and relative intensities of M , $M+1$, and $M+2$

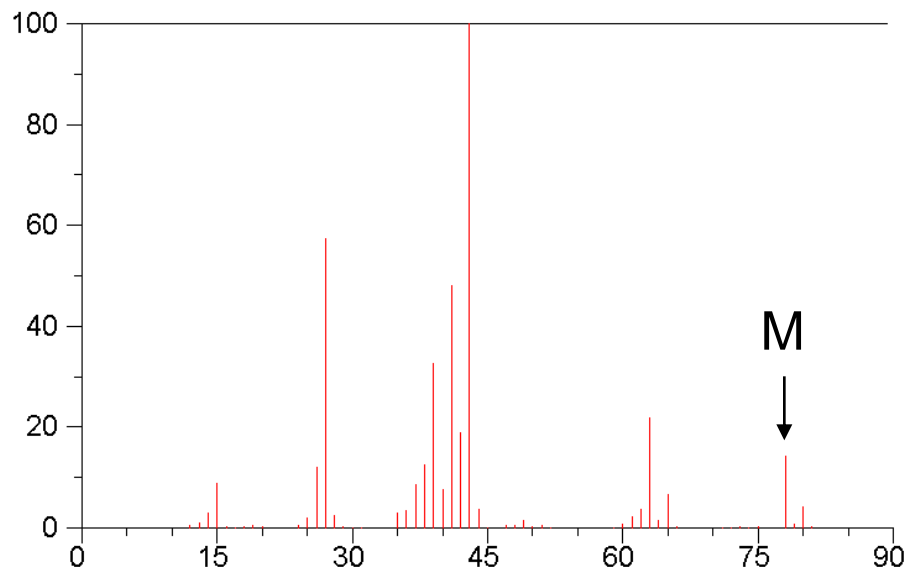

$M: m/z = 78$

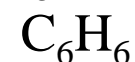
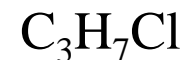
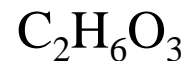

etc.

- A few useful rules to narrow the choices

How Many Nitrogen Atoms?

Consider these molecules:

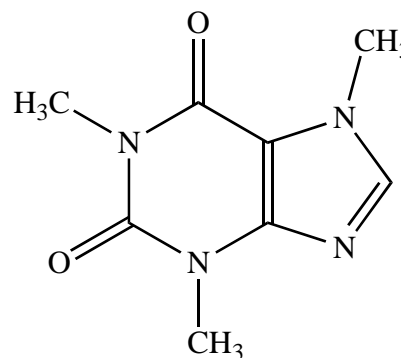
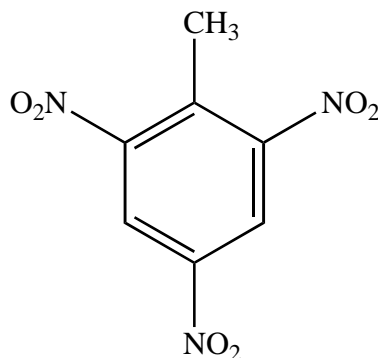

Formula:

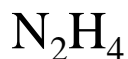

m/z (M):

17

32

227

194

Conclusion

- When m/z (M) = **even**, number of N in formula is **even**
 - When m/z (M) = **odd**, number of N in formula is **odd**
- } **The Nitrogen Rule**

How Many Nitrogen Atoms?

A Nitrogen Rule Example

Example: Formula choices from previous mass spectrum

M: m/z = 78 ← m/z even

$C_2H_6O_3$ ← even nitrogen count

C_3H_7Cl ← even nitrogen count

discarded ~~C_5H_4N~~ ← odd nitrogen count

C_6H_6 ← even nitrogen count

How Many Hydrogen Atoms?

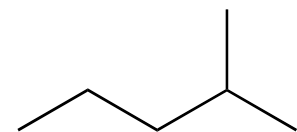

C_6H_{14}
max H for 6 C

One pi bond

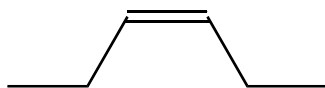

C_6H_{12}
H count = max - 2

Two pi bonds

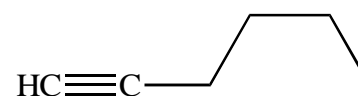
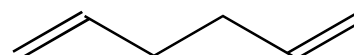

C_6H_{10}
H count = max - 4

Conclusion: Each pi bond reduces max hydrogen count by two

How Many Hydrogen Atoms?

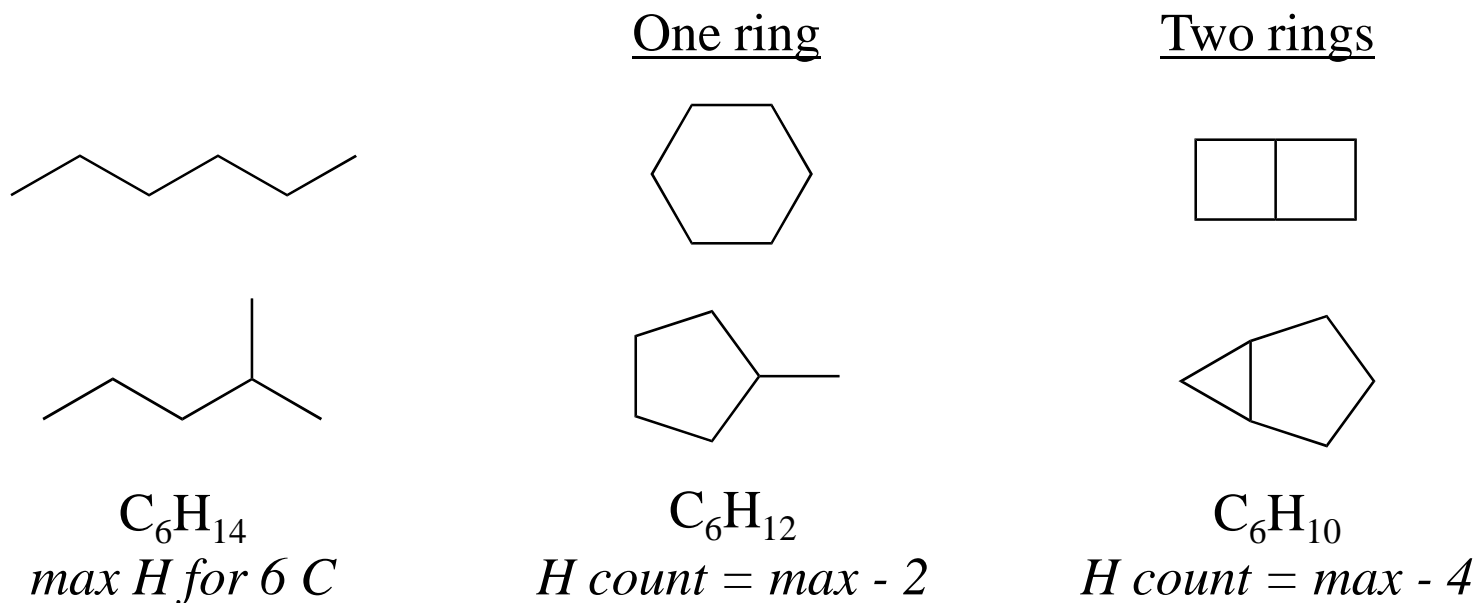

Conclusion: Each ring reduces max hydrogen count by two

How Many Hydrogen Atoms?

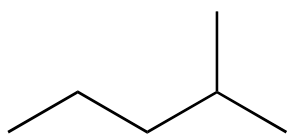

max H for 6 C

One nitrogen

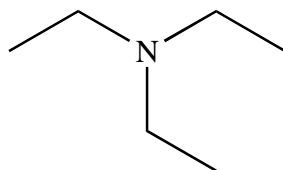
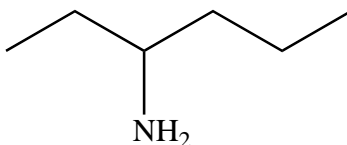

H count = max + 1

Two nitrogens

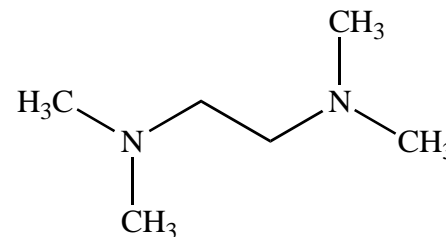
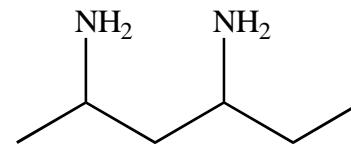

H count = max + 2

Conclusion:

- Each Nitrogen increases max H count by one
- The same for P, As, Sb, Bi
- No change in number of Hydrogen for O, S, Se, Te
- One Hydrogen subtract from saturated Hc for F, Cl, Br, I
- Ex. C_2H_6 $\text{C}_2\text{H}_5\text{F}$ $\text{C}_2\text{H}_4\text{F}_2$

Index of Hydrogen Deficiency

- IHD = number of pairs of hydrogen that must be removed from the corresponding saturated hydrocarbon.
- IHD = The SUM of the number of rings, double bonds, or the number of triple bonds

$$\text{IHD} = \underset{\substack{\text{carbons} \\ \uparrow}}{\text{C}} - \frac{\text{H}}{2} + \frac{\text{N}}{2} + 1$$

hydrogens and halogens ———— ↓
nitrogens ———— ↓

For example



- $\text{IHD} = 6 - 12/2 + 1 = 1$
- There is 1 ring or double bond.



- $\text{IHD} = 5 - 10/2 + 1 = 1$
- Ring or double bond



- $\text{IHD} = 6 - 6/2 + 1 = 4$
- There are 4 rings or double bonds or some combination of both.



- $\text{IHD} = 3 - 9/2 + \frac{1}{2} + 1 = 0$
- There are no rings or double bonds.

Mass Spectrum → Formula

Example #1

	<u>m/z</u>	<u>Molecular ion</u>	<u>Relative abundance</u>	<u>Conclusions</u>
<u>Given information</u>	102	M	100%	Mass (lowest isotopes) = 102 Even number of nitrogens
	103	M+1	6.9%	$6.9 / 1.1 = 6.3$ Six carbons*
	104	M+2	0.38%	< 4% so no S, Cl, or Br Oxygen?

*Rounding: 6.00 to 6.33 = 6; 6.34 to 6.66 = 6 or 7; 6.67 to 7.00 = 7

Mass Spectrum → Formula

Example #1

Mass (M) - mass (C, S, Cl, Br, F, and I) = mass (N, O, and H)

$$102 - C_6 = 102 - (6 \times 12) = 30 \text{ amu for N, O, and H}$$

<u>Oxygens</u>	<u>Nitrogens</u>	<u>30 - O - N = H</u>	<u>Formula</u>	<u>Notes</u>
0	0	$30 - 0 - 0 = 30$	C_6H_{30}	Violates hydrogen rule
1	0	$30 - 16 - 0 = 14$	$C_6H_{14}O$	Reasonable
2	0	$30 - 32 - 0 = -2$	$C_6H_{-2}O_2$	Not possible
0	2*	$30 - 0 - 28 = 2$	$C_6H_2N_2$	Reasonable

*Nitrogen rule!

•Other data (functional groups from IR, NMR integration, etc.) further trims the list

Mass Spectrum → Formula

Example #2

<u>m/z</u>	<u>Molecular ion</u>	<u>Relative abundance</u>	<u>Conclusions</u>
157	M	100%	<i>Mass (lowest isotopes) = 157 Odd number of nitrogens</i>
158	M+1	9.39%	$9.39 / 1.1 = 8.5$ <i>Eight or nine carbons</i>
159	M+2	34%	<i>One Cl; no S or Br</i>

Mass Spectrum → Formula

Example #2

Try eight carbons: $M - C_8 - Cl = 157 - (8 \times 12) - 35 = 26$ amu for O, N, and H

<u>Oxygens</u>	<u>Nitrogens</u>	<u>26 - O - N = H</u>	<u>Formula</u>	<u>Notes</u>
0	1*	$26 - 0 - 14 = 12$	$C_8H_{12}ClN$	Reasonable

*Nitrogen rule!

Not enough amu available for one oxygen/one nitrogen or no oxygen/three nitrogens

Mass Spectrum → Formula

Example #2

Try nine carbons: $M - C_9 - Cl = 157 - (9 \times 12) - 35 = 14$ amu for O, N, and H

<u>Oxygens</u>	<u>Nitrogens</u>	<u>14 - O - N = H</u>	<u>Formula</u>	<u>Notes</u>
0	1*	$14 - 0 - 14 = 0$	C_9ClN	Reasonable

*Nitrogen rule!

Not enough amu available for any other combination.

Rule of Thirteen:

Used to generate the possible formula for a given molecular mass.

1. Generate a base formula consisting of C and H, not necessarily the actual formula ;

$$\frac{M}{13} = n + \frac{r}{13} \longrightarrow \text{C}_n\text{H}_{n+r}$$

↓

2. Calculate the index of deficiency, U, for the base formula.

$$U = \frac{n - r + 2}{2}$$

3. If needed - find the formula with n_O atoms of O for the same M;

New formula = Base formula + n_O O – n_O C – $4n_O$ H
which changes U to $U+n_O$;

4. If needed - find the formula with n_N atoms of N for the same M,

New formula = Base formula + n_N N – n_N C – $2n_N$ H
and recalculate U; Fractional U's – unlikely formula.

$U < 0$ is an impossible combination of atoms and indicates likely presence of O and N.

Ex. Consider an unknown substance with a molecular mass of 94 amu.

$$\frac{94}{13} = 7 + \frac{3}{13}$$

According to the formula $n=7$ and $r=3$. The base formula must be C_7H_{10}
The index of hydrogen deficiency is $U=$

$$\frac{(7-3+2)}{2} = 3$$

The formula must contain 3 ring or double bond.

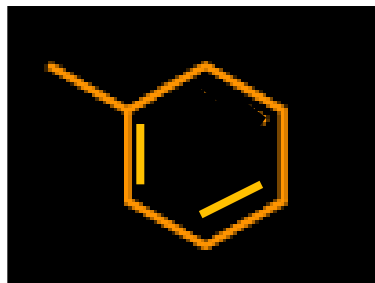

- If we wish to add oxygen with the same mol.mass,
- the mol. Formula would become C_6H_6O .
 - ✓ Base formula = C_7H_{10} $U=3$
 - ✓ Add: +O
 - ✓ Subtract: $-CH_4$
 - ✓ Change the value of U: $\Delta U=1$
 - ✓ New formula = C_6H_6O
 - ✓ New U: 4
- The other possible molecular formulas with mole. Mass of 94 amu are:

$C_5H_2O_2$	$U=5$	C_5H_2S	$U=5$
C_6H_8N	$U=3.5$	CH_3Br	$U=0$

Process of interpreting a mass spectrum

- MS allows one to determine the molecular weight of an unknown compound if the M^+ peak can be identified.
 1. The nitrogen rule is the following:
 - A compound has an odd molecular weight if and only if there are an odd number of nitrogen atoms in its formula.
 - The nitrogen rule holds for compounds containing H, C, N, O, Si, P, S, or any of the halogens,
 2. Every C-containing ion has a small peak accompanying it that weighs one mass unit more.
 - The ratio of the intensities of the (M) and (M+1) peaks is directly proportional to the number of C atoms in the ion.
 - The peak is due to small amounts of naturally occurring ^{13}C , which has 1.1% natural abundance.

- The intensity of the (M+1) peak allows one to determine exactly of how many C atoms a particular ion consists.
 - For example, a C₆ ion has a 6.6% probability of having one ¹³C atom in it, so its (M+1) peak is 6.6% of the intensity of the M+• peak.
 - If no information about intensities of (M) and (M+1) use **Rule of Thirteen**.
3. The presence and size of an M+2 peak tells you whether Cl or Br atoms are present.
- Cl (75% ³⁵Cl, 25% ³⁷Cl) and Br (50% ⁷⁹Br, 50% ⁸¹Br)

4. Calculate the degrees of unsaturation in your formula.
- You may have too few (fewer than zero, i.e. a negative number) or too many degrees of unsaturation in your compound.
 - Too few degrees of unsaturation means that you have too many H atoms.
 - a. If you have too few number of degrees of unsaturation, you must add degrees of unsaturation, i.e. remove H's without changing the molecular weight.
 - ✓ There are a few ways to do this.
 - I. Replace CH_4 with O. This has the effect of adding one degree of unsaturation.
 - II. Replace C_2H_4 with N_2 . This also has the effect of adding one degree of unsaturation.
 - III. Replace H_{16} with O. This has the effect of adding eight degrees of unsaturation

- (b) If you have a very large number of degrees of unsaturation, you may want to subtract degrees of unsaturation.
- (Most of the compounds I would have you identify have 0–5 degrees of unsaturation.) Replace C with H12.
 - This has the effect of subtracting seven degrees of unsaturation without changing the molecular weight.
5. You now have your first reasonable formula for your compound.
- Once you generate a reasonable formula, you may do the replacements to generate new formulas with the same molecular weight.
6. Draw at least one structure for each formula.
- It's useful to remember that a six-membered ring with three double bonds (e.g. a phenyl group, C_6H_5 ; or one or more N atoms may replace CH groups in the ring) uses up four degrees of unsaturation.

7. The molecular ion, unfortunately, is not always observed. One can also gain information from the fragmentation pattern.
- The fragmentation pattern constitutes a kind of "fingerprint" for a compound.
 - Different structural isomers and even stereoisomers give different fragmentation patterns, so the fragmentation pattern can be used to distinguish different compounds that have the same molecular formula.
 - The fragmentation pattern also provides evidence for and against certain structural elements in the unidentified compound. If the major fragments can be identified, and if a reasonable mechanism for their formation from the molecular ion can be written, then this constitutes evidence that the parent ion has been correctly identified.

- For example, when a fragment ion of $M = 91$ is observed, it is almost always the very stable benzyl cation PhCH_2^+ , suggesting that a benzyl group is present in the parent compound.
- Ethyl esters, RCO_2Et , often show fragments $M - 45$ (for the fragment RCO) and
- $M - 73$ (for the fragment R).

Example. The mass spectrum of a compound shows an M^+ peak at 124 amu and no $M+2$ peaks. Determine some molecular formulas for this compound.

- (1) Nitrogen Rule \Rightarrow even No of N
- (2) It will be clear from the $M+2$ peak how many Cl or Br atoms you have.
 - For each Cl or Br atom, subtract 35 or 79 from the molecular weight, and write Cl or Br in your formula. In the present case, no Cl or Br atoms are present.
- (3) Determine the base formula by rule of thirteen.
 $124/13 = 9 + 7/13 \quad n=9 \quad r=7$
 - C_9H_{16}
- (4) Calculate the degrees of unsaturation in your formula.
 - $U = (9 - 7 + 2)/2 = 2$

5. You now have your first reasonable formula for your compound. Once you generate a reasonable formula, you may do the following replacements to generate new formulas with the same molecular weight.

- (a) Replace CH_4 with O. (Adds a degree of unsaturation.)
- (b) Replace C_2H_4 with N_2 . (Adds a degree of unsaturation.)
- (c) Replace CO with N_2 . (Leaves degrees of unsaturation unchanged.)

• Thus:

- $\text{C}_9\text{H}_{16} \rightarrow \text{C}_8\text{H}_{12}\text{O}$ (Three degrees of unsaturation.)
- $\text{C}_8\text{H}_{12}\text{O} \rightarrow \text{C}_7\text{H}_{12}\text{N}_2$ (Three degrees of unsaturation.)
- $\text{C}_8\text{H}_{12}\text{O} \rightarrow \text{C}_7\text{H}_8\text{O}_2$ (Four degrees of unsaturation.)
- $\text{C}_8\text{H}_{12}\text{O} \rightarrow \text{C}_6\text{H}_8\text{N}_2\text{O}$ (Four degrees of unsaturation.)
- $\text{C}_6\text{H}_8\text{N}_2\text{O} \rightarrow \text{C}_5\text{H}_8\text{N}_4$ (Four degrees of unsaturation.)
- Etc.

6. Draw at least one structure for each formula. It's useful to remember that a six-membered ring with three double bonds
- (e.g. a phenyl group, C_6H_5 ; or one or more N atoms may replace CH groups in the ring) uses up four degrees of unsaturation.
 - **More problems:**
 - (1) 88 amu, no $M+2$.
 - (2) 119 amu, no $M+2$.
 - (3) 108 amu, and there's an $M+2$ peak that is $1/3$ the size of M .

m/z Relative
abundance (%)

26	38
27	74
28	12
29	4.4
44	14
45	32
55	74
56	2.5
57	0.2
71	4.2
72	100
73	3.5
74	0.5

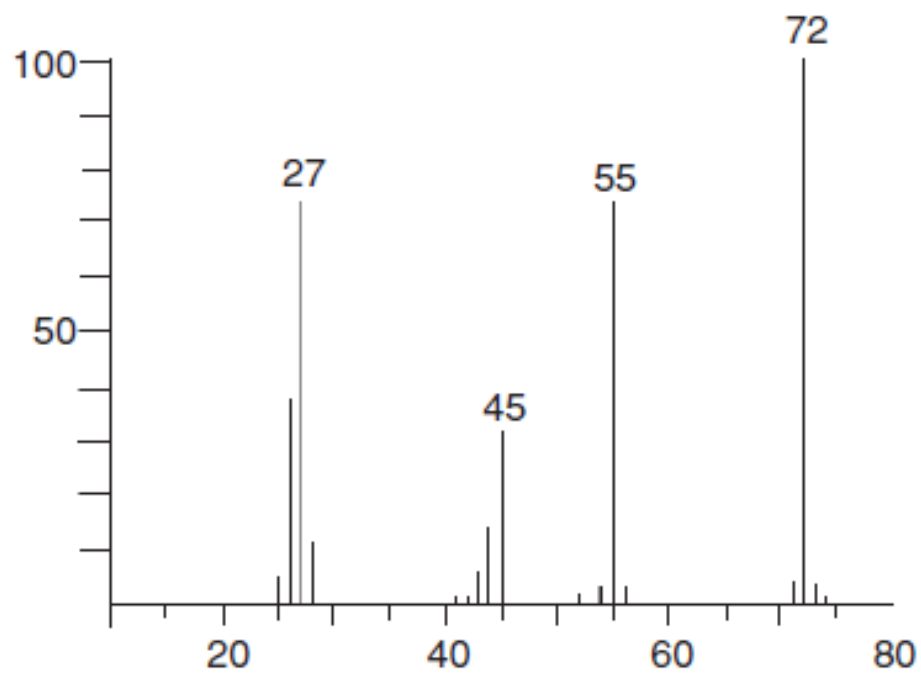

Interpreting Mass-Spectral Fragmentation Patterns

- The way molecular ions break down can produce characteristic fragments that help in identification
 - Serves as a “fingerprint” for comparison with known materials in analysis (used in forensics)
 - Positive charge goes to fragments that best can stabilize it

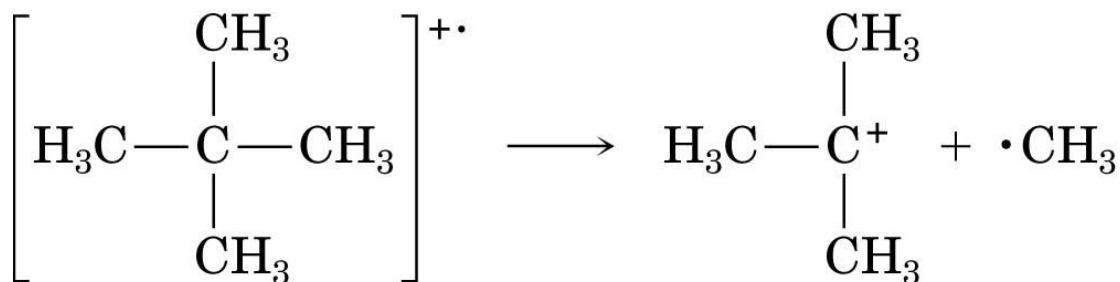

$$m/z = 57$$

Mass Spectral Fragmentation of Hexane

- Hexane ($m/z = 86$ for parent) has peaks at $m/z = 71, 57, 43, 29$

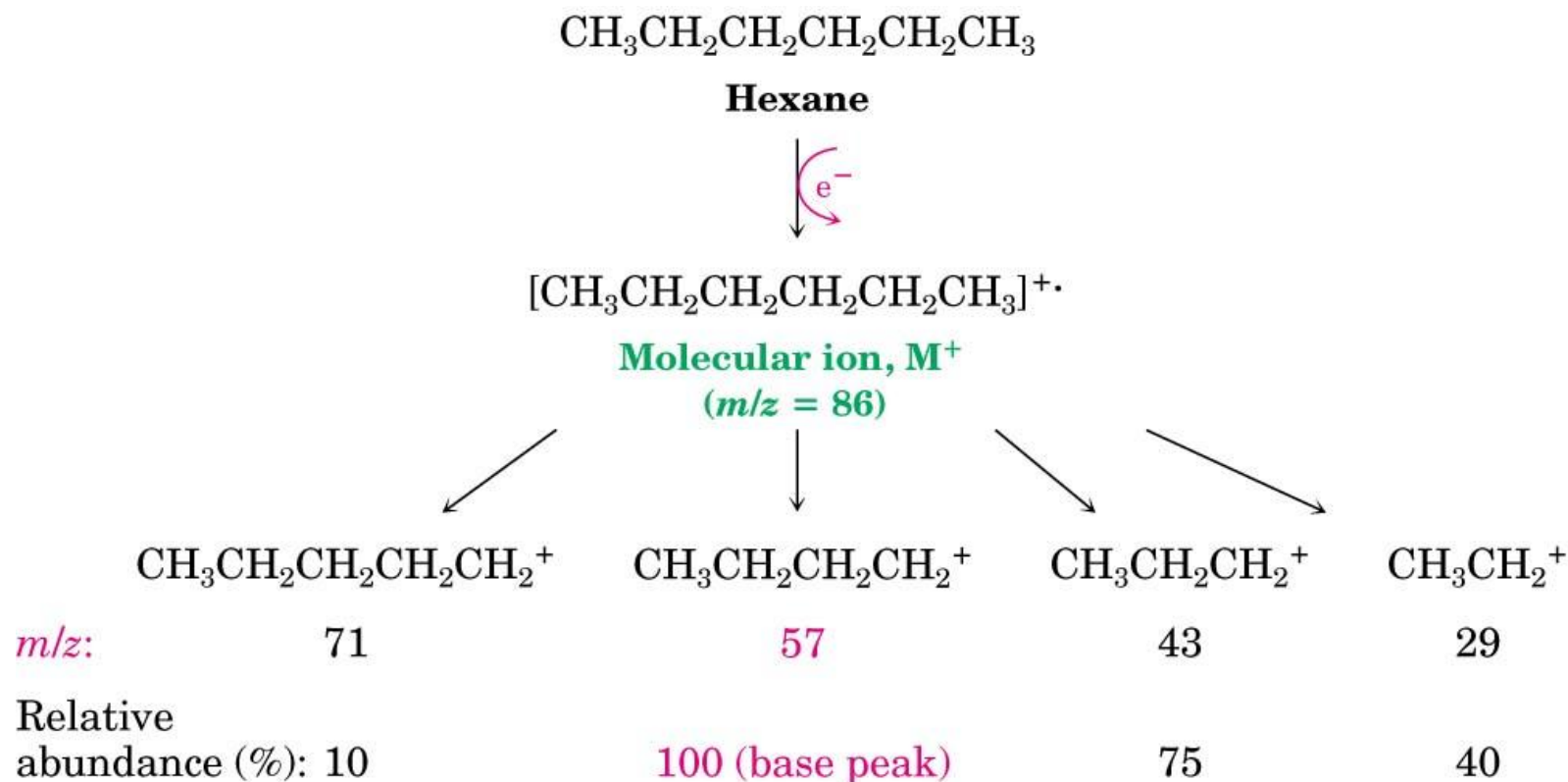

Hexane

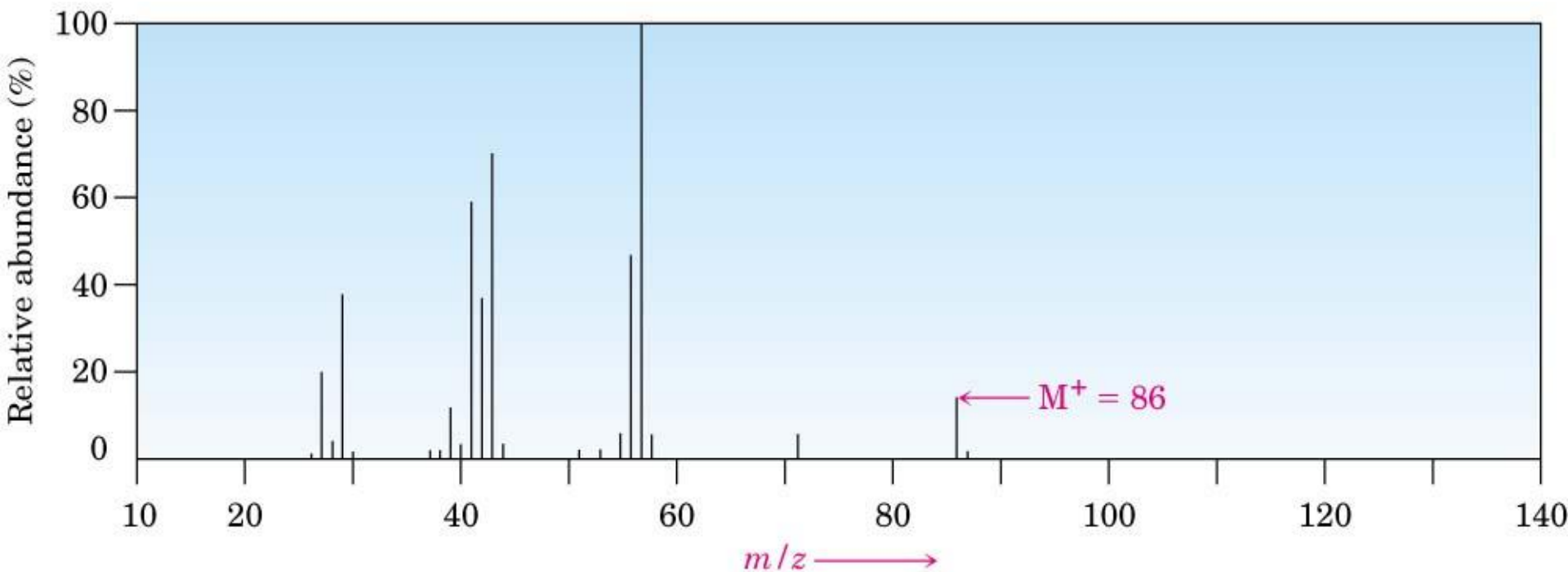

© Thomson - Brooks Cole

Practice Problem 12.2: methylcyclohexane or ethylcyclopentane?

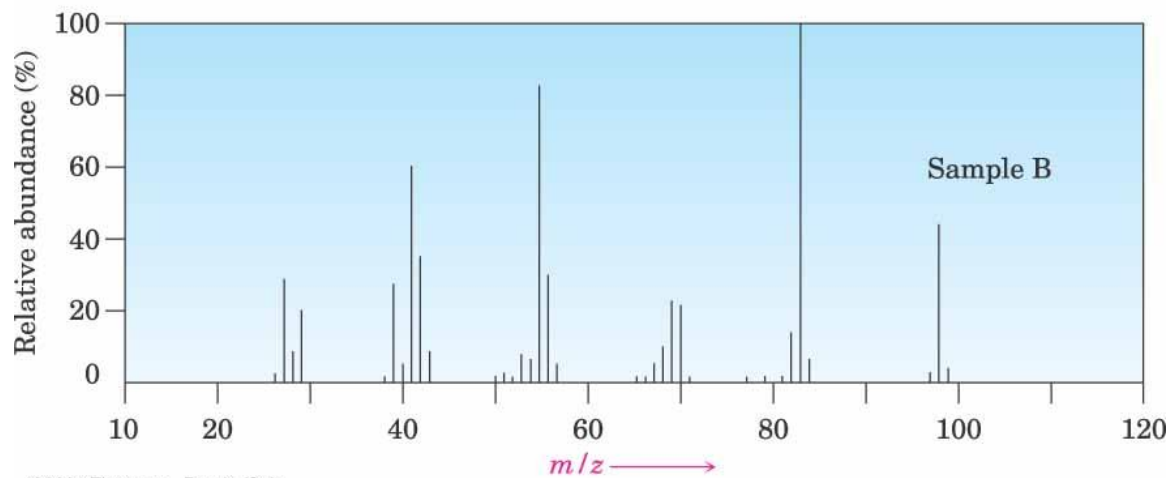
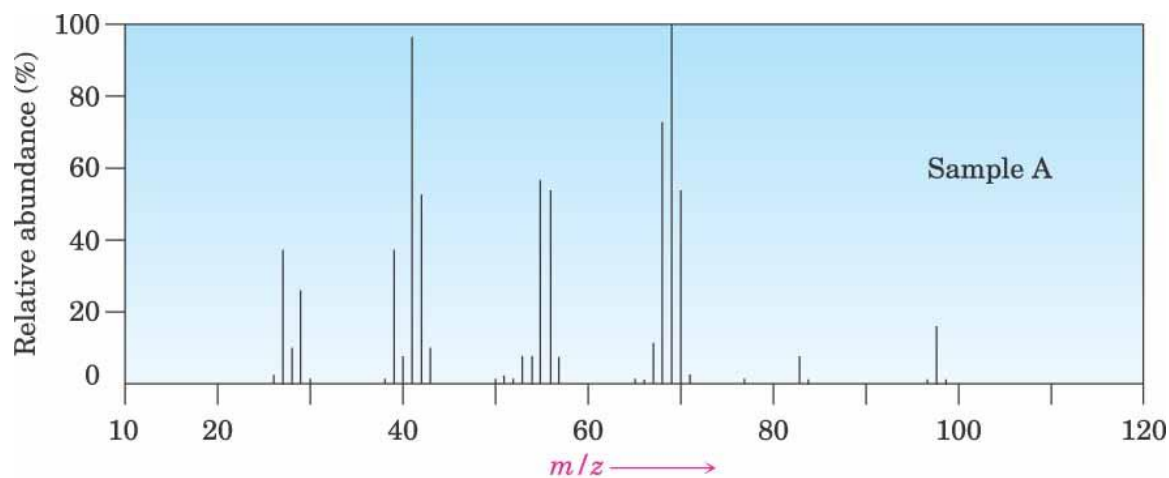

Mass Spectral Cleavage Reactions of Alcohols

- Alcohols undergo α -cleavage (at the bond next to the C-OH) as well as loss of H-OH to give C=C

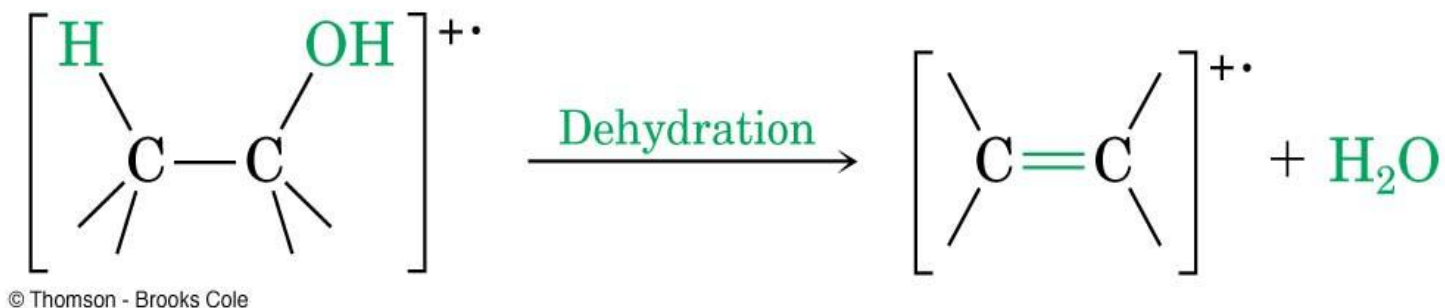
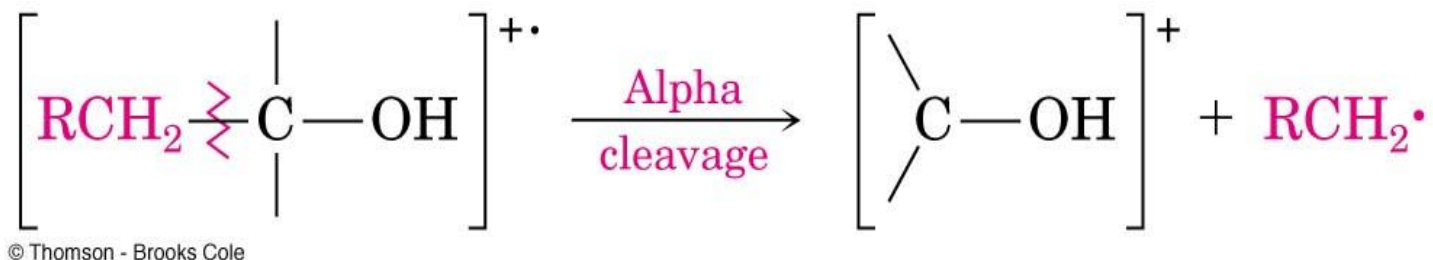

Mass Spectral Cleavage of Amines

- Amines undergo α -cleavage, generating radicals

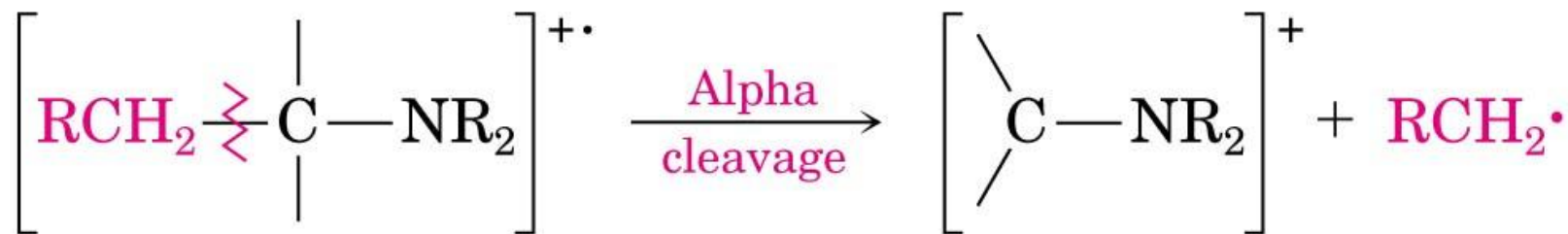

© Thomson - Brooks Cole

Fragmentation of Ketones and Aldehydes

- A C-H that is three atoms away leads to an internal transfer of a proton to the C=O, called the *McLafferty rearrangement*
- Carbonyl compounds can also undergo α cleavage

Fragmentation of Ketones and Aldehydes

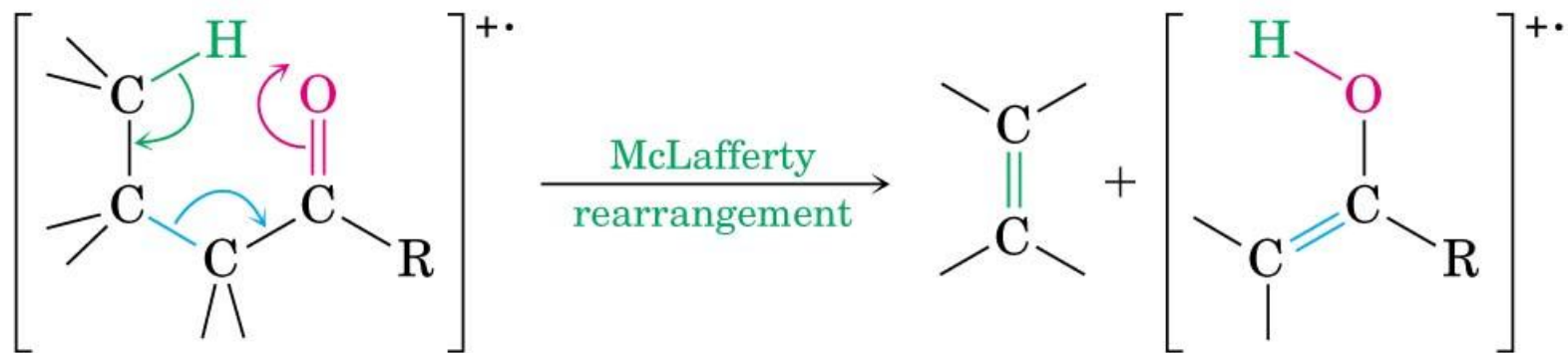

© Thomson - Brooks Cole

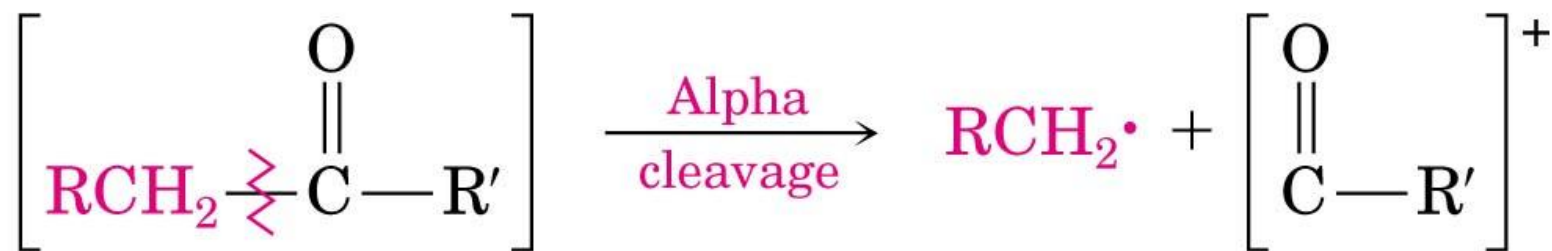

© Thomson - Brooks Cole

Mass Spectra of Alkanes

More stable carbocations will be more abundant.

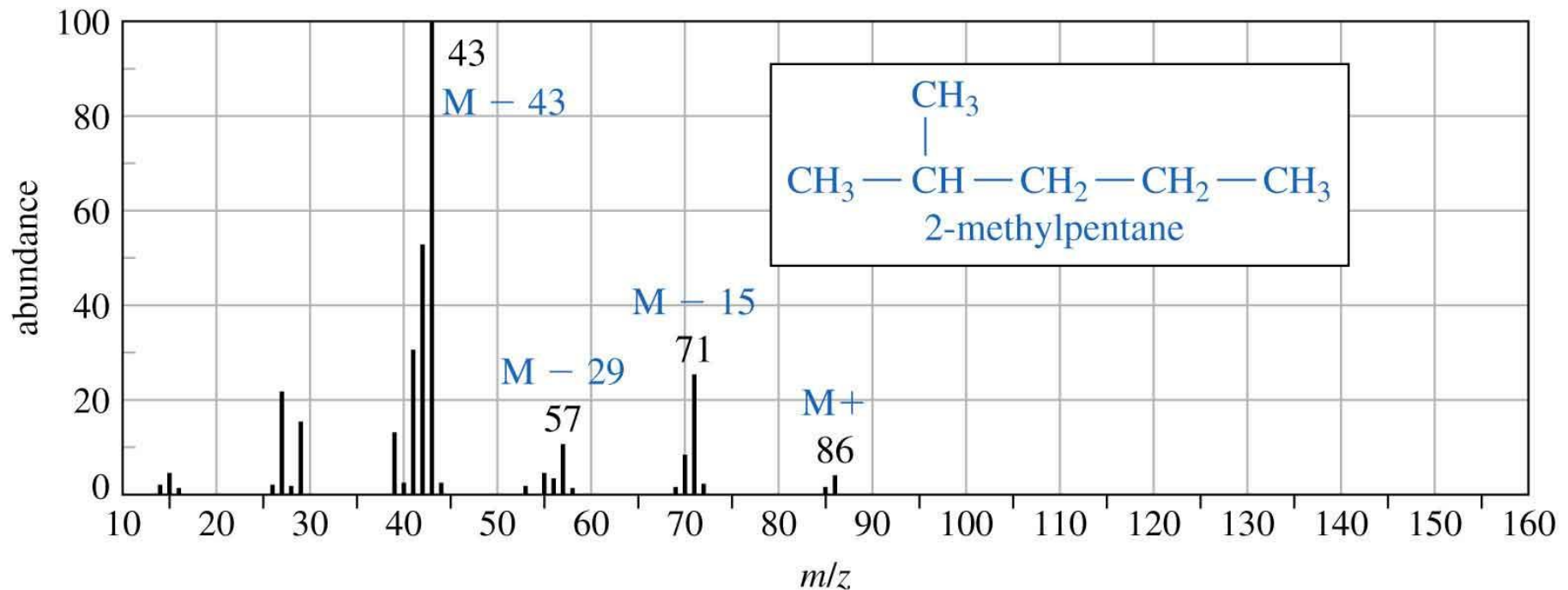

=>

Mass Spectra of Alkenes

Resonance-stabilized cations favored.

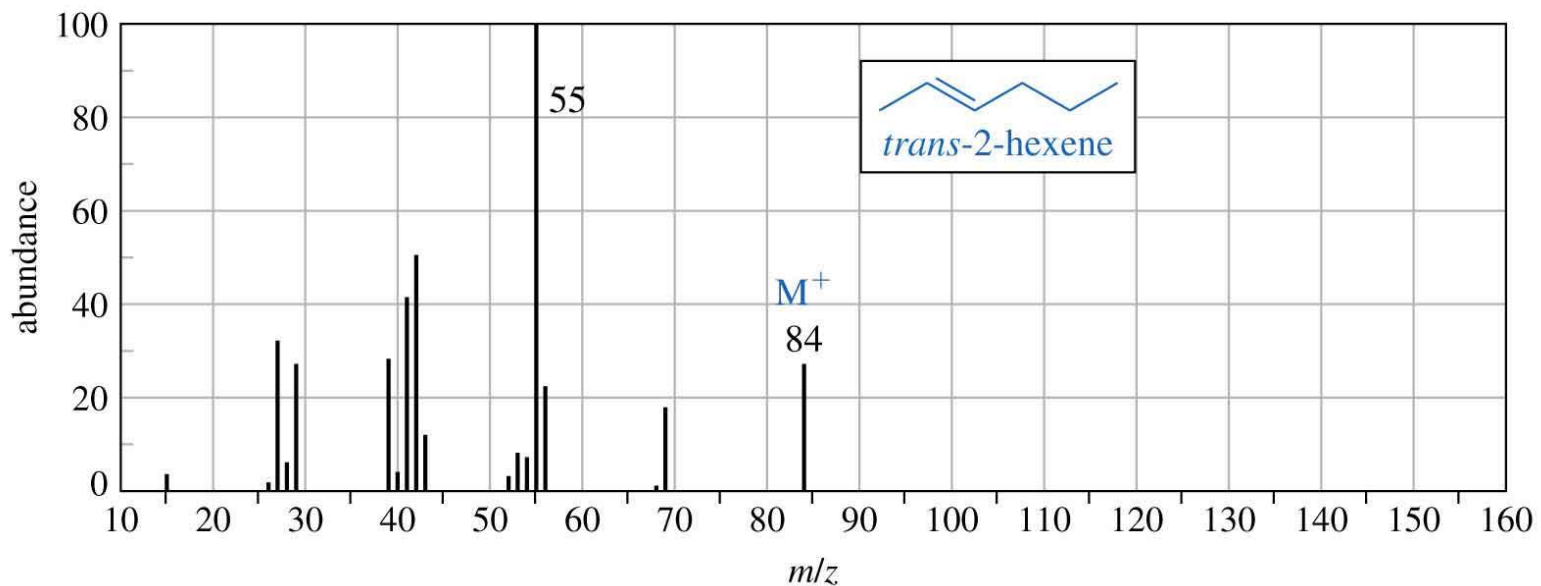
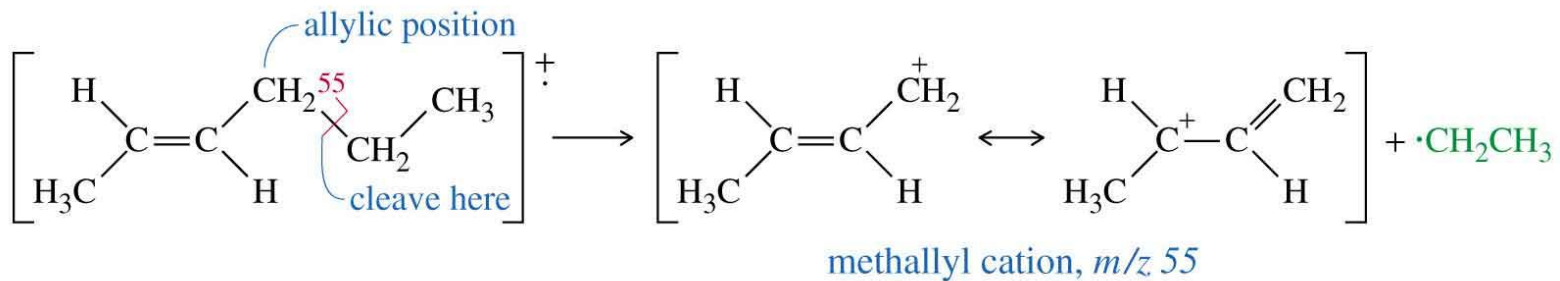

dodekan

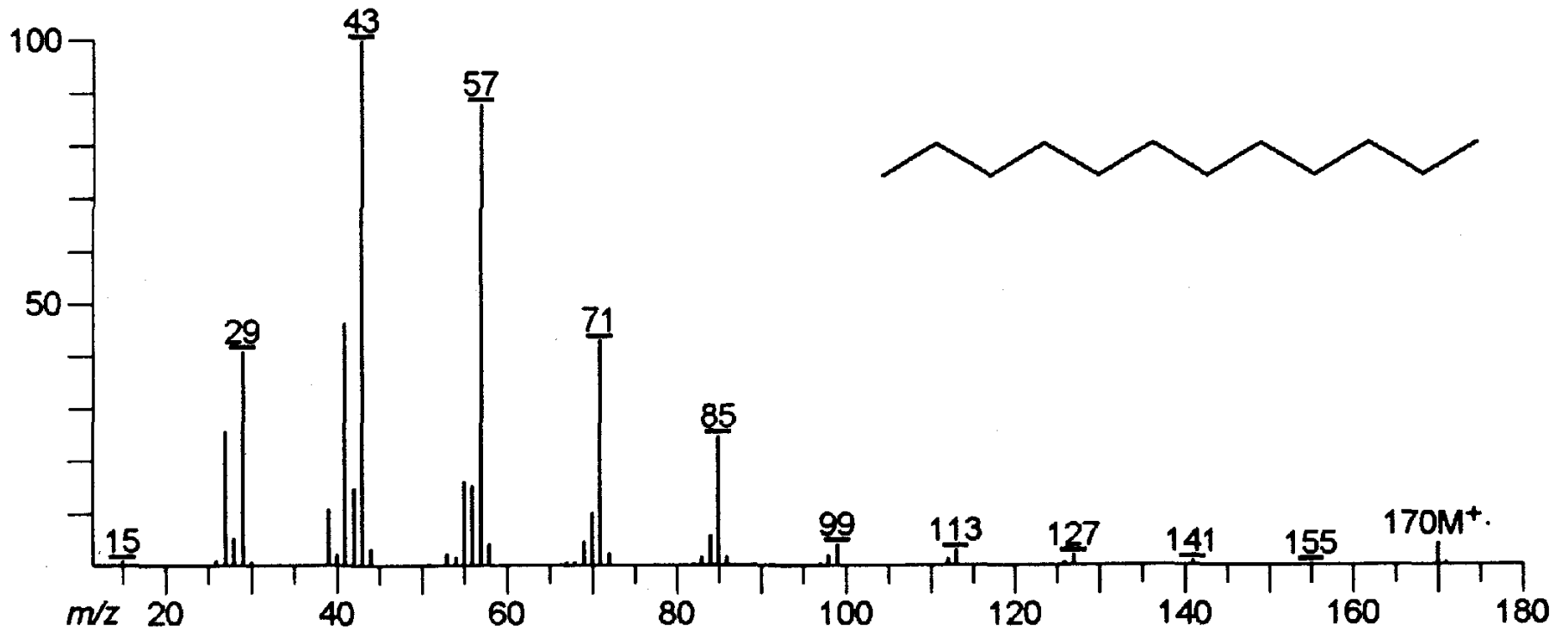

4-metylundekan

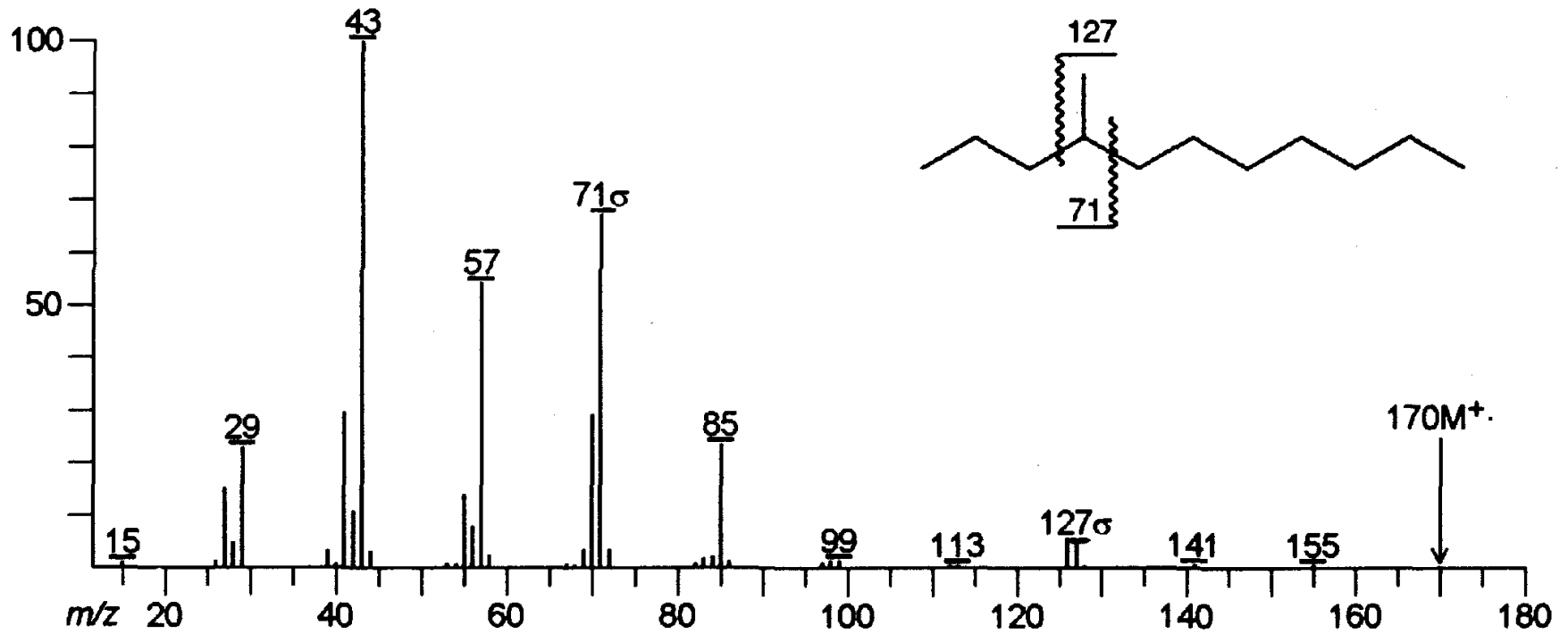

2,2,4,6,6-pentamethylheptan

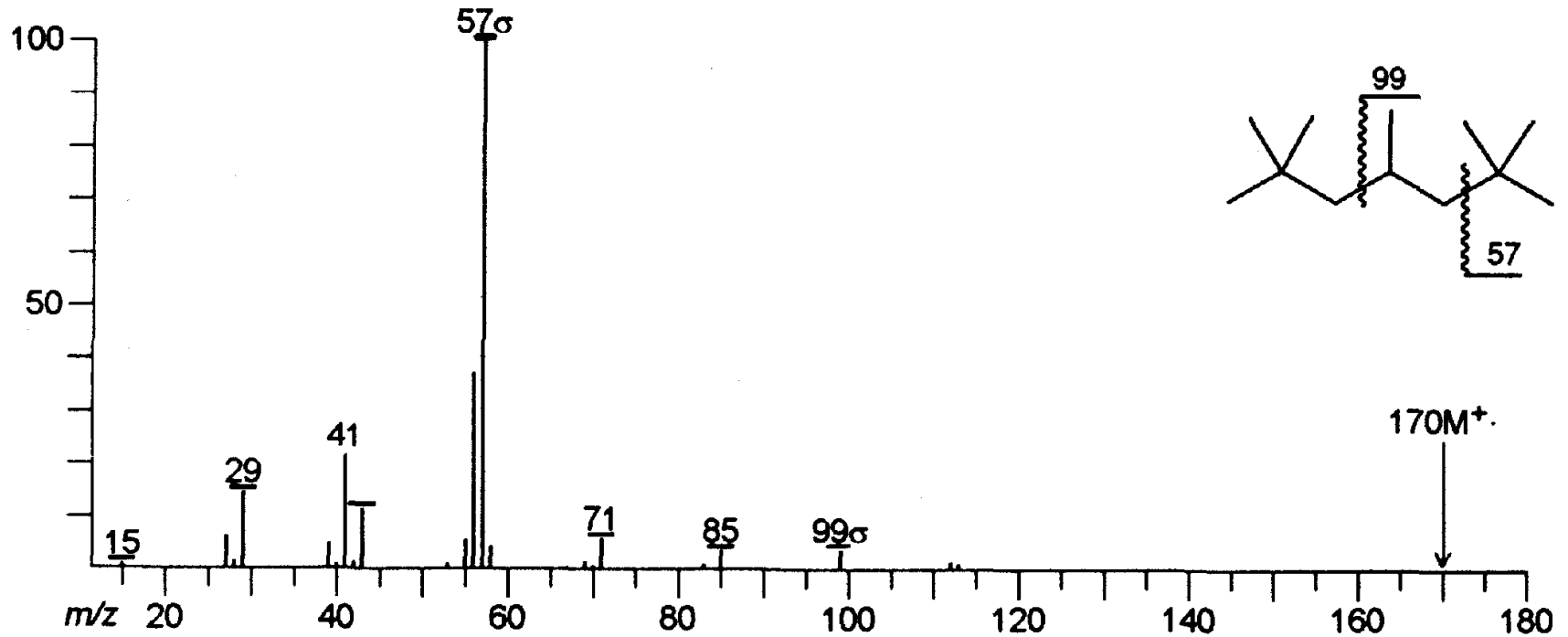

dihexyleter

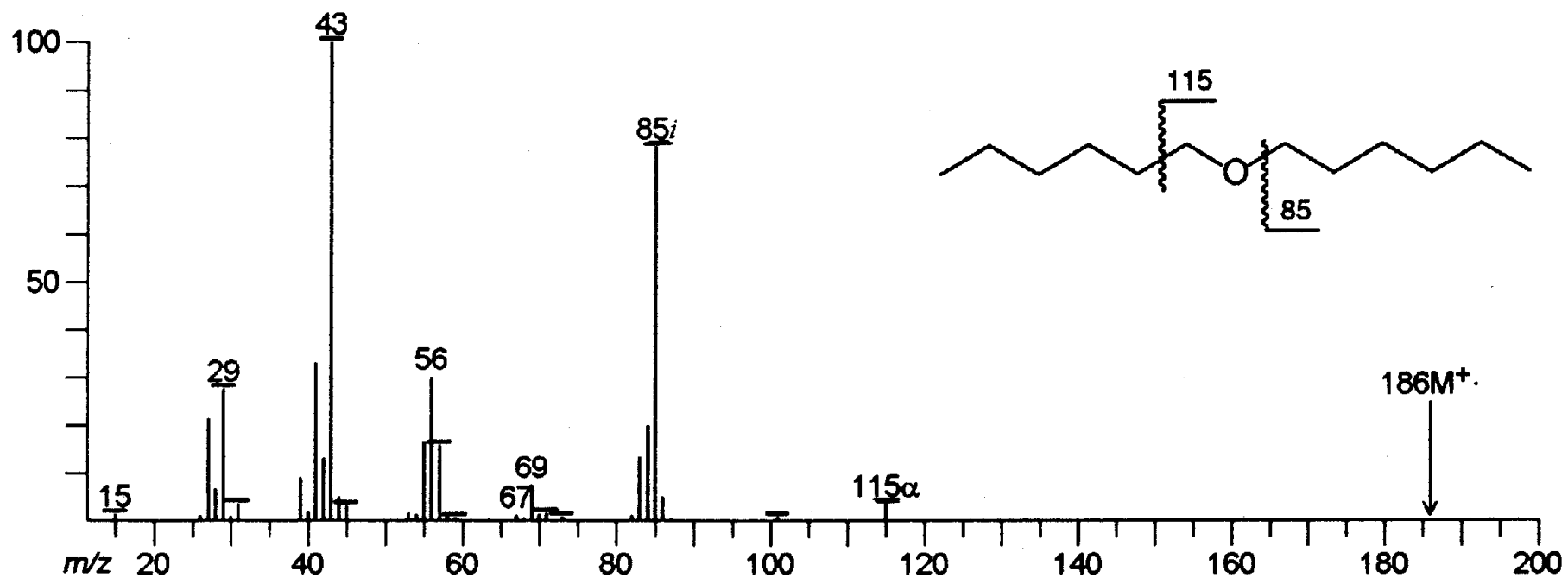

Vilken α -klyvning ger det största fragmentet för efedrin?

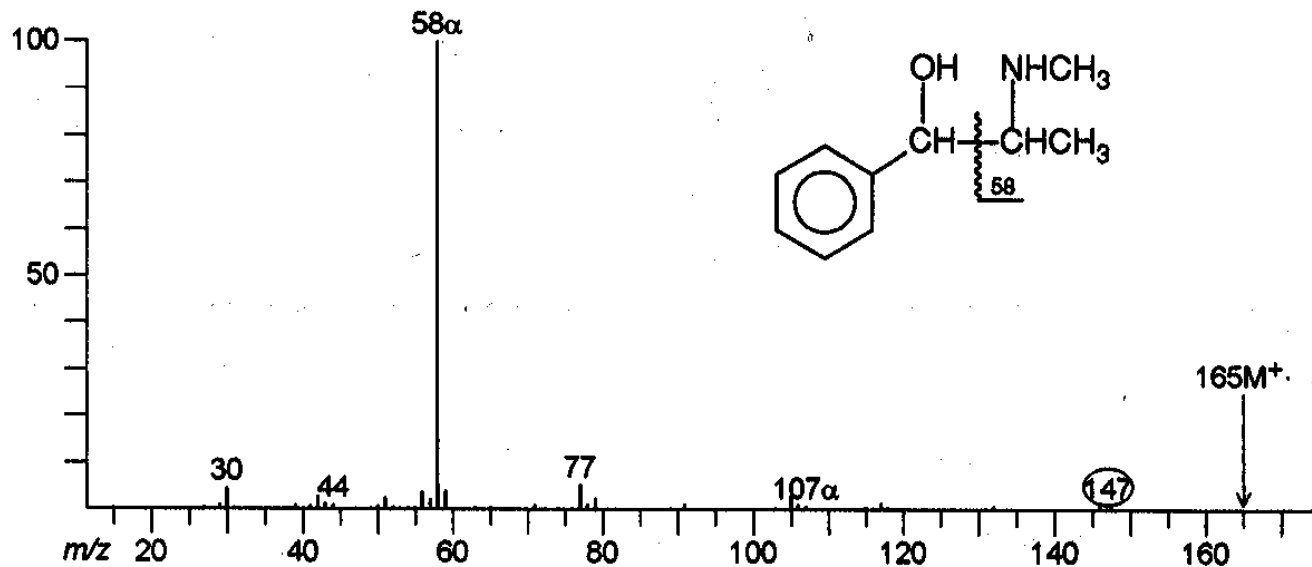

6-dodekanon

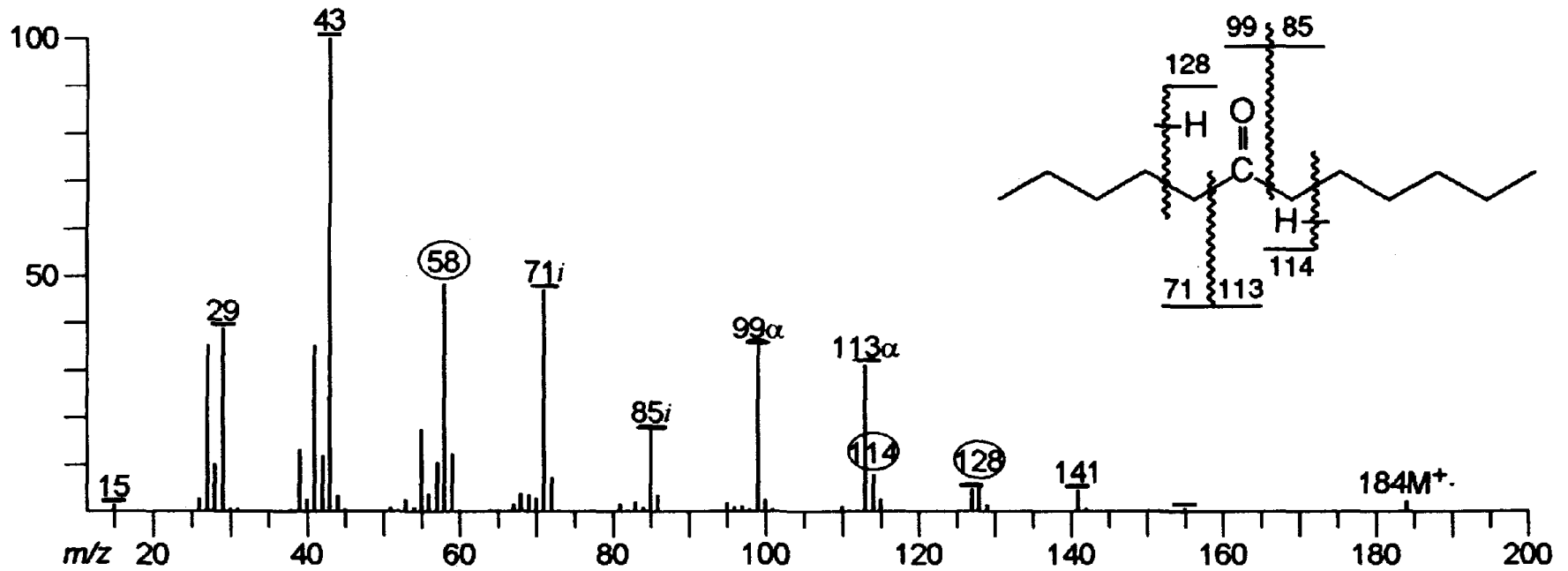

1-dodeken

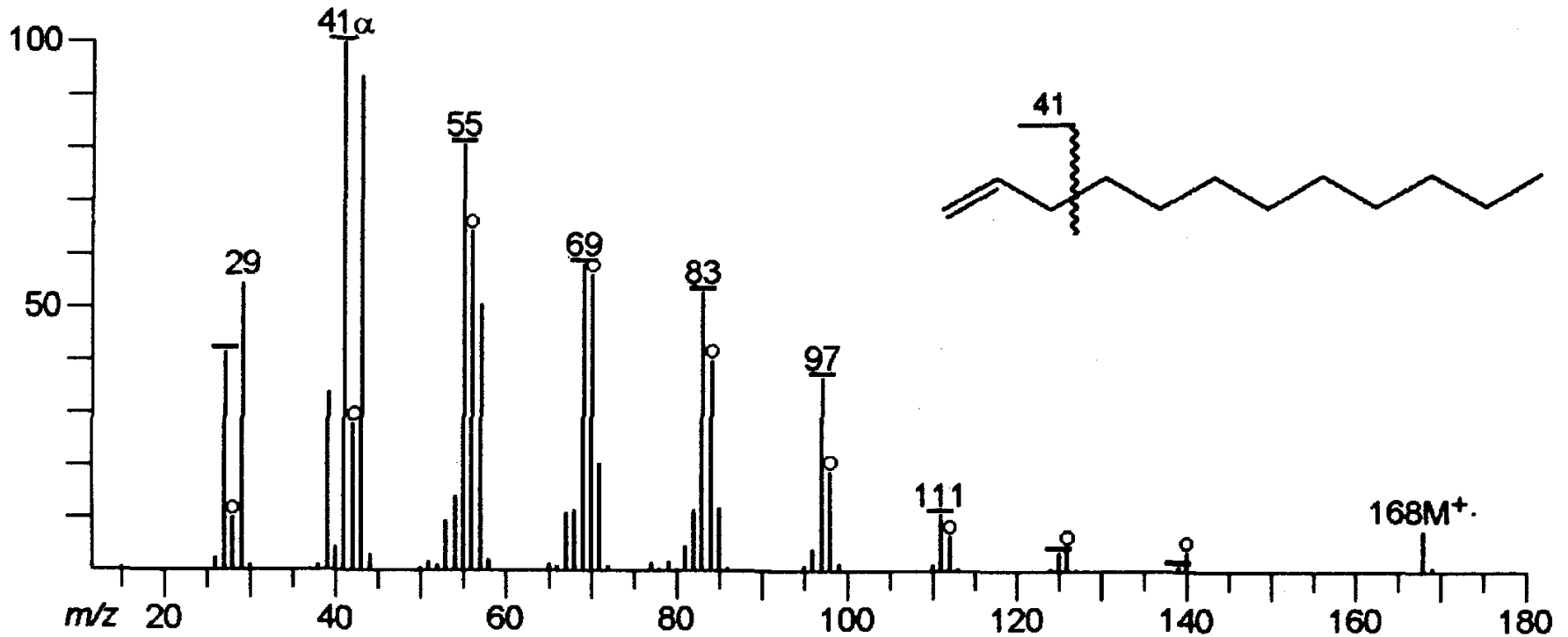

3-methyl-3-hexanol

